

---

---

# SECURITIES AND EXCHANGE COMMISSION

Washington, D.C. 20549

---

## Amendment No. 3 to FORM S-1

REGISTRATION STATEMENT

UNDER

THE SECURITIES ACT OF 1933

---

### Genworth Financial, Inc.

(Exact Name of Registrant as Specified in its Charter)

**Delaware**  
(State or Other Jurisdiction of  
Incorporation or Organization)

**6311**  
(Primary Standard Industrial  
Classification Code Number)

**33-1073076**  
(I.R.S. Employer Identification Number)

**6620 West Broad Street  
Richmond, Virginia 23230  
(804) 281-6000**

(Address, Including Zip Code, and Telephone Number,  
Including Area Code, of Registrant's Principal Executive Offices)

---

**Leon E. Roday, Esq.**  
**Senior Vice President, General Counsel and Secretary**  
**Genworth Financial, Inc.**  
**6620 West Broad Street**  
**Richmond, Virginia 23230**  
**(804) 281-6000**

(Name, Address, Including Zip Code, and Telephone Number,  
Including Area Code, of Agent for Service)

---

*Copies to:*

**David S. Lefkowitz, Esq.**  
**Weil, Gotshal & Manges LLP**  
**767 Fifth Avenue**  
**New York, New York 10153**  
**(212) 310-8000**

**Alexander M. Dye, Esq.**  
**LeBoeuf, Lamb, Greene & MacRae, L.L.P.**  
**125 West 55th Street**  
**New York, New York 10019**  
**(212) 424-8000**

---

**Richard J. Sandler, Esq.**  
**Davis Polk & Wardwell**  
**450 Lexington Avenue**  
**New York, New York 10017**  
**(212) 450-4000**

**Approximate date of commencement of proposed sale to the public:** As soon as practicable after the effective date of this Registration Statement.

If any of the securities being registered on this Form are to be offered on a delayed or continuous basis pursuant to Rule 415 under the Securities Act of 1933, check the following box. //

If this Form is filed to register additional securities for an offering pursuant to Rule 462(b) under the Securities Act, check the following box and list the Securities Act registration statement number of the earlier effective registration statement for the same offering. //

If this Form is a post-effective amendment filed pursuant to Rule 462(c) under the Securities Act, check the following box and list the Securities Act registration statement number of the earlier effective registration statement for the same offering. //

If this Form is a post-effective amendment filed pursuant to Rule 462(d) under the Securities Act, check the following box and list the Securities Act registration statement number of the earlier effective registration statement for the same offering. //

If delivery of the prospectus is expected to be made pursuant to Rule 434, check the following box. //

**The Registrant hereby amends this Registration Statement on such date or dates as may be necessary to delay its effective date until the Registrant shall file a further amendment which specifically states that this Registration Statement shall thereafter become effective in accordance with Section 8(a) of the Securities Act of 1933 or until the Registration Statement shall become effective on such date as the Commission, acting pursuant to Section 8(a), may determine.**

---

---

The information in this preliminary prospectus is not complete and may be changed. These securities may not be sold until the registration statement filed with the Securities and Exchange Commission is effective. This preliminary prospectus is not an offer to sell nor does it seek an offer to buy these securities in any jurisdiction where the offer or sale is not permitted.

PROSPECTUS (Subject to Completion)  
 Issued April 19, 2004

## Shares



**Genworth**  
 Financial

*Built on GE Heritage*

### Class A Common Stock

GE Financial Assurance Holdings, Inc., the selling stockholder and an indirect subsidiary of General Electric Company, is offering all the shares of Class A Common Stock to be sold in this offering. This is our initial public offering, and no public market currently exists for our shares. We anticipate that the initial public offering price of the shares will be between \$ and \$ per share.

The selling stockholder has granted the underwriters the right to purchase up to an additional shares of Class A Common Stock to cover over-allotments.

The Class A Common Stock has been approved for listing on The New York Stock Exchange under the symbol "GNW."

Concurrently with this offering, the selling stockholder is offering, by means of a separate prospectus, \$600 million of our % Equity Units. Each Equity Unit will have a stated amount of \$25 and will initially consist of a contract to purchase shares of our Class A Common Stock and an interest in a % senior note due 2009 issued by us. Concurrently with this offering, the selling stockholder also is offering, by means of a separate prospectus, \$100 million of our % Series A Cumulative Preferred Stock.

We will not receive any proceeds from the sale by the selling stockholder of Class A Common Stock in this offering or the Equity Units or Series A Cumulative Preferred Stock in the concurrent offerings.

**Investing in our Class A Common Stock involves risks. See "Risk Factors" beginning on page 14.**

PRICE \$	A SHARE	Per Share	Total
Price to public		\$	\$
Underwriting discounts and commissions		\$	\$
Proceeds to selling stockholder		\$	\$

Neither the Securities and Exchange Commission nor any other regulatory body has approved or disapproved of these securities or passed upon the adequacy or accuracy of this prospectus. Any representation to the contrary is a criminal offense.

The underwriters expect to deliver the shares of Class A Common Stock to purchasers on , 2004.

**Morgan Stanley**

**Goldman, Sachs & Co.**

**Banc of America Securities LLC  
 Deutsche Bank Securities  
 Merrill Lynch & Co.**

**Citigroup  
 JPMorgan  
 UBS Investment Bank**

**Credit Suisse First Boston  
 Lehman Brothers**

**Blaylock & Partners, L.P.  
 Edward D. Jones & Co., L.P.  
 KeyBanc Capital Markets  
 Stephens Inc.**

**Cochran, Caronia & Co.  
 Fox-Pitt, Kelton  
 Legg Mason Wood Walker  
 Incorporated**

**Dowling & Partners Securities  
 Keefe, Bruyette & Woods  
 Raymond James  
 The Williams Capital Group, L.P.**

, 2004

Prospectus Summary	1
Risk Factors	14
Forward-Looking Statements	44
Use of Proceeds	45
Dividend Policy	45
Capitalization	46
Selected Historical and Pro Forma Financial Information	49
Management's Discussion and Analysis of Financial Condition and Results of Operations	62
Corporate Reorganization	112
Business	115
Regulation	195
Management	206
Arrangements Between GE and Our Company	228
Ownership of Common Stock	255
Description of Capital Stock	258
Description of Equity Units	270
Description of Certain Indebtedness	275
Shares Eligible for Future Sale	278
Certain United States Federal Tax Consequences for Non-U.S. Holders of Common Stock	280
Underwriters	283
Legal Matters	288
Experts	288
Additional Information	288
Index to Financial Statements	F-1
Glossary of Selected Insurance Terms	G-1

## Prospectus Summary

*This summary highlights information contained elsewhere in this prospectus and may not contain all of the information that may be important to you. You should read this entire prospectus carefully, including the information set forth in "Risk Factors," before making an investment decision.*



We are a leading insurance company in the U.S., with an expanding international presence, serving the life and lifestyle protection, retirement income, investment and mortgage insurance needs of more than 15 million customers. We have leadership positions in key products that we expect will benefit from a number of significant demographic, governmental and market trends. We distribute our products and services through an extensive and diversified distribution network that includes financial intermediaries, independent producers and dedicated sales specialists. We conduct operations in 20 countries and have approximately 5,850 employees.

We have the following three operating segments:

- Protection.** We offer U.S. customers life insurance, long-term care insurance and, for companies with fewer than 1,000 employees, group life and health insurance. In Europe, we offer payment protection insurance, which helps consumers meet their payment obligations in the event of illness, involuntary unemployment, disability or death. In 2003, we were the leading provider of individual long-term care insurance and the sixth-largest provider of term life insurance in the U.S., according to LIMRA International (in each case based upon gross written premiums). We believe we are a leading provider of term life insurance through brokerage general agencies in the U.S. and that this channel is the largest and fastest-growing distribution channel for term life insurance. Our leadership in long-term care insurance is based upon almost 30 years of product underwriting and claims experience. For the year ended December 31, 2003, our Protection segment had pro forma segment net earnings of \$481 million.
- Retirement Income and Investments.** We offer U.S. customers fixed, variable and income annuities, variable life insurance, asset management, and specialized products, including guaranteed investment contracts, funding agreements and structured settlements. We are an established provider of these products and, in 2003, we were the leading provider of income annuities in the U.S., according to LIMRA International (based upon total premiums and deposits). For the year ended December 31, 2003, our Retirement Income and Investments segment had pro forma segment net earnings of \$93 million.
- Mortgage Insurance.** In the U.S., Canada, Australia and Europe, we offer mortgage insurance products that facilitate homeownership by enabling borrowers to buy homes with low-down-payment mortgages. In 2003, according to *Inside Mortgage Finance*, we were the fourth-largest provider of mortgage insurance in the U.S. (based upon new insurance written), and we believe we are the largest provider of private mortgage insurance outside the U.S. The net premiums written in our international mortgage insurance business have increased by a compound annual growth rate of 46% for the three years ended December 31, 2003. For the year ended December 31, 2003, our Mortgage Insurance segment had pro forma segment net earnings of \$369 million.

We also have a Corporate and Other segment, which consists primarily of net realized investment gains (losses), interest and other financing expenses that are incurred at our holding company level, unallocated corporate income and expenses, and the results of several small, non-core businesses that

are managed outside our operating segments. For the year ended December 31, 2003, our Corporate and Other segment had a pro forma segment net loss of \$8 million.

We had \$11.0 billion of total stockholder's interest and \$97.9 billion of total assets as of December 31, 2003, on a pro forma basis. For the year ended December 31, 2003, on a pro forma basis, our revenues were \$9.8 billion and our net earnings from continuing operations were \$935 million. Upon the completion of this offering, we expect our principal life insurance companies to have financial strength ratings of "AA-" (Very Strong) from S&P, "Aa3" (Excellent) from Moody's and "A+" (Superior) from A.M. Best, and we expect our rated mortgage insurance companies to have financial strength ratings of "AA" (Very Strong) from S&P, "Aa2" (Excellent) from Moody's and "AA" (Very

Strong) from Fitch. The "AA" and "AA-" ratings are the third- and fourth-highest of S&P's 21 ratings categories, respectively. The "Aa2" and "Aa3" ratings are the third- and fourth-highest of Moody's 21 ratings categories, respectively. The "A+" rating is the second-highest of A.M. Best's 15 ratings categories. The "AA" rating is the third-highest of Fitch's 24 ratings categories.

## Market Environment and Opportunities

We believe we are well positioned to benefit from a number of significant demographic, governmental and market trends, including the following:

- **Aging U.S. population with growing retirement income needs**, resulting from large numbers of baby boomers approaching retirement and significant increases in life expectancy that heighten the risk that individuals will outlive their retirement savings.
- **Growing lifestyle protection gap**, with individuals lacking sufficient financial resources, including insurance coverage, to maintain their desired lifestyle due to declining individual savings rates, rising healthcare and nursing home costs and a shifting of the burden for funding protection needs from governments and employers to individuals.
- **Increasing opportunities for mortgage insurance in the U.S. and other countries**, resulting from increasing homeownership levels, expansion of low-down-payment mortgage loan offerings, favorable legislative and regulatory policies, and expansion of secondary mortgage markets that require credit enhancements.

## Competitive Strengths

We believe the following competitive strengths will enable us to capitalize on opportunities in our targeted markets:

- **Leading positions in diversified targeted markets.** We believe our leading positions in our targeted markets, including term life and individual long-term care insurance, retirement income and mortgage insurance, provide us with the scale necessary to compete effectively in these markets as they continue to grow. We also believe our strong presence in multiple markets provides balance to our business, reduces our exposure to adverse economic trends affecting any one market and provides stable cash flow to fund growth opportunities.
- **Product innovation and smart breadth.** We offer a breadth of products that meet the needs of consumers throughout the various stages of their lives, thereby positioning us to benefit from the current trend among distributors to reduce the number of insurers with whom they maintain relationships. We refer to our approach to product diversity as "smart" breadth because we are selective in the products we offer and strive to maintain appropriate return and risk thresholds when we expand the scope of our product offerings.
- **Extensive, multi-channel distribution network.** We have extensive distribution reach and offer consumers access to our products through a broad network of financial intermediaries,

2

---

independent producers and dedicated sales specialists. In addition, we maintain strong relationships with leading distributors by providing a high level of specialized and differentiated distribution support and by pursuing joint business improvement efforts.

- **Technology-enhanced, scalable, low-cost operating platform.** We have pursued an aggressive approach to cost-management and continuous process improvement. We also have developed sophisticated technological tools that enhance performance by automating key processes and reducing response times and process variations. In addition, we have centralized our operations and have established scalable, low-cost operating centers in Virginia, North Carolina, India and Ireland.
- **Disciplined risk management with strong compliance practices.** Risk management and regulatory compliance are critical parts of our business, and we are recognized in the insurance industry for our excellence in these areas. We employ comprehensive risk management processes in virtually every aspect of our operations, including product development, underwriting, investment management, asset-liability management and technology development programs. We have 130 dedicated risk management professionals supporting these efforts and approximately 200 additional professionals dedicated to legal and regulatory compliance.
- **Strong balance sheet and high-quality investment portfolio.** We believe our size, ratings and capital strength provide us with a significant competitive advantage. We have a diversified, high-quality investment portfolio with \$59.8 billion of investment securities, as of December 31, 2003, on a pro forma basis. More than 93% of our fixed maturities had ratings equivalent to investment-grade, and less than 1% of our total investment portfolio consisted of equity securities, as of December 31, 2003, on a pro forma basis.
- **Experienced and deep management team.** Our senior management team has an average of approximately 17 years of experience in the financial services industry. We have adopted GE's recognized practices for successfully developing managerial talent at all levels of our organization and have instilled a performance- and execution-oriented corporate culture that we will continue to foster as an independent company.

## Growth Strategies

Our objective is to increase operating earnings and enhance returns on equity. We intend to pursue this objective by focusing on the following strategies:

- **Capitalize on attractive growth trends in three key markets.** We have positioned our product portfolio and distribution relationships to capitalize on the attractive growth prospects in three key markets:

*Retirement income*, where we believe growth will be driven by a variety of favorable demographic trends and the approximately \$4.4 trillion of invested financial assets in the U.S. that are held by people within 10 years of retirement. Our products are designed to enable the growing retired population to convert their invested assets into reliable retirement income.

*Protection*, particularly long-term care insurance, where we believe growth will be driven by the increasing protection needs of the expanding aging population and a shifting of the burden for funding these needs to individuals from governments and employers. For example, it is estimated that approximately 70% of individuals in the U.S. aged 65 and older will require long-term care at some time in their lives, but in 2001, only 7% of individuals in the U.S. aged 55 and older had long-term care insurance.

*International mortgage insurance*, where we continue to see attractive growth opportunities with the expansion of homeownership and low-down-payment loans. The net premiums written in

3

---

our international mortgage insurance business have increased by a compound annual growth rate of 46% for the three years ended December 31, 2003.

- **Further strengthen and extend our distribution channels.** We intend to further strengthen and extend our distribution channels by continuing to differentiate ourselves in areas where we believe we have distinct competitive advantages. These areas include:

*Product and service innovations*, as illustrated by new product introductions, such as the introduction in 2002 of our GE Retirement Answer®, our introduction of innovative private mortgage insurance products in the European market, and our service innovations, which include programs such as our policyholder wellness initiatives in our long-term care insurance business and our AU Central® Internet platform in our mortgage insurance business.

*Collaborative approach to key distributors*, which includes a joint business improvement program (originally developed by GE), called "At the Customer, For the Customer," or ACFC, and our platinum customer service desks, which have benefited our distributors and helped strengthen our relationships with them.

*Technology initiatives*, such as our GENIUS® underwriting system, which makes it easier for distributors to do business with us by improving our term life and long-term care insurance underwriting speed and accuracy and also lowering operating costs.

- **Enhance returns on capital and increase margins.** We believe we will be able to enhance our returns on capital and increase our margins through the following:

*Rigorous product pricing and return discipline.* We intend to maintain strict product pricing disciplines that are designed to achieve our target returns on capital. Over the past two years, we introduced restructured pricing on newly issued policies in each of our operating segments and exited products that were not achieving our target returns. We expect our returns on capital to improve as the benefits of these actions emerge and as we continue our focus on maintaining target returns.

*Capital efficiency enhancements.* We continually seek opportunities to use our capital more efficiently to support our business, while maintaining our ratings and strong capital position. For example, in 2003, we took actions to reduce the statutory capital required to support most of our new term and universal life insurance policies and to reduce excess capital at our mortgage insurance subsidiaries by operating at an "AA/Aa2" rating level.

*Investment income enhancements.* As part of GE, the yield on our investment portfolio has been affected by the practice in recent years of realizing investment gains through the sale of appreciated securities and other assets during a period of historically low interest rates. This strategy was pursued to offset impairments and losses in our investment portfolio, fund consolidations and restructurings in our business and provide current income. As we transition to being an independent public company, our investment strategy will be to optimize investment income without relying on realized investment gains. We will seek to improve our investment yield by continuously evaluating our asset class mix and pursuing additional investment classes.

*Ongoing operating cost reductions and efficiencies.* We will continually focus on reducing our cost base while maintaining strong service levels for our customers. We expect to accomplish this in each of our operating units through a wide range of cost management disciplines, including consolidating operations, using low-cost operating locations, reducing supplier costs, leveraging Six Sigma and other process improvement efforts, forming dedicated teams to identify opportunities for cost reductions and investing in new technology, particularly for web-based, digital end-to-end processes.

- **Pursue acquisitions opportunistically.** We intend to continue to complement our core growth strategy through selective acquisitions designed to enhance our earnings and returns, the breadth of our product portfolio, or our distribution reach. We have successfully completed the acquisition and integration of 13 key businesses since 1993. As a public company, we will have direct access to capital markets, which we believe will enable us to raise external capital in an efficient manner to facilitate selective acquisitions.

#### **Formation of Genworth Financial, Inc.**

We were incorporated in Delaware on October 23, 2003 in preparation for our corporate reorganization.

Prior to the completion of this offering and the concurrent offerings, we will acquire substantially all of the assets and liabilities of GE Financial Assurance Holdings, Inc., or GEFAHI. GEFAHI is an indirect subsidiary of GE and a holding company for a group of companies that provide life insurance, long-term care insurance, group life and health insurance, annuities and other investment products and U.S. mortgage insurance. We also will acquire certain other insurance businesses currently owned by other GE subsidiaries but managed by members of the Genworth management team. These businesses include international mortgage insurance, European payment protection insurance, a Bermuda reinsurer and mortgage contract underwriting.

In consideration for the assets that we will acquire and the liabilities that we will assume in connection with our corporate reorganization, we will issue to GEFAHI the following securities:

- million shares of our Class B Common Stock. For a description of the terms of our common stock, see "Description of Capital Stock—Common Stock."
- \$600 million of our % Equity Units, which we refer to in this prospectus as the Equity Units. For a description of the terms of our Equity Units, see "Description of Equity Units." GEFAHI is offering the Equity Units for sale in a concurrent offering.
- \$100 million of our % Series A Cumulative Preferred Stock, which we refer to in this prospectus as the Series A Preferred Stock. The Series A Preferred Stock is mandatorily redeemable on , 2011. For a description of the terms of our Series A Preferred Stock, see "Description of Capital Stock—Preferred Stock—Series A Preferred Stock." GEFAHI is offering the Series A Preferred Stock for sale in a concurrent offering.
- A \$2.4 billion short-term note, which we refer to in this prospectus as the Short-term Intercompany Note. We intend to repay this note with proceeds from the borrowings under a \$2.4 billion short-term credit facility that we intend to establish with a syndicate of banks concurrently with the completion of this offering. We intend to repay the borrowings under this short-term credit facility with proceeds from the issuance of approximately \$1.9 billion in senior notes and approximately \$500 million in commercial paper, both of which we intend to complete shortly after the completion of this offering. For a description of the terms of this note, see "Description of Certain Indebtedness—Short-term Intercompany Note."

- A \$550 million contingent non-interest-bearing note that matures on the first anniversary of the completion of this offering. We refer to this note in this prospectus as the Contingent Note. This note will be repaid solely to the extent that statutory contingency reserves from our U.S. mortgage insurance business in excess of \$150 million are released and paid to us as a dividend. The release of these statutory reserves and payment of the dividend by our U.S. mortgage insurance business to us are subject to statutory limitations, regulatory approval and the absence of any impact on our financial ratings. If regulatory approval has been obtained by the first anniversary date, but our financial ratings have not been affirmed, the term of this note will be extended for a period of up to twelve months to obtain affirmation of our financial

ratings. Any portion of the Contingent Note that is not repaid by the first anniversary of the completion of this offering or by the extended term, if applicable, will be canceled. We will record any portion of the Contingent Note that is canceled as a capital contribution. For a description of the terms of this note see "Description of Certain Indebtedness—Contingent Note."

The liabilities we will assume from GEFAHI include ¥60 billion aggregate principal amount of 1.6% notes due 2011 issued by GEFAHI, ¥3 billion of which GEFAHI currently owns and will transfer to us. We refer to these notes in this prospectus as the Yen Notes. We have entered into arrangements to swap our obligations under these notes to a U.S. dollar obligation with a principal amount of \$491 million and bearing interest at a rate of 4.84% per annum.

Prior to the completion of this offering and the concurrent offerings, GEFAHI will own 100% of our outstanding common stock, which will consist solely of Class B Common Stock. Shares of Class B Common Stock convert automatically into shares of Class A Common Stock when they are held by any person other than GE or an affiliate of GE or when GE no longer beneficially owns at least 10% of our outstanding common stock. As a result, all the shares of common stock offered in this offering consist of Class A Common Stock. Upon the completion of this offering and the concurrent offerings, GE will beneficially own approximately % of our outstanding common stock, assuming the underwriters' over-allotment option is not exercised, and %, if it is exercised in full. GE has informed us that, after completion of this offering, it intends, subject to market conditions, to divest its remaining interest in us as soon as practicable. GE has also informed us that, in any event, it expects to reduce its interest to below 50% within two years of the completion of this offering. GE currently expects to reduce its interest through one or more additional public offerings of our common stock, but it is not obligated to divest our shares in this or any other manner.

Prior to the completion of this offering, we will enter into a number of arrangements with GE governing our separation from GE and a variety of transition and other matters, including our relationship with GE while GE remains a significant stockholder in our company. These arrangements include several significant reinsurance transactions with Union Fidelity Life Insurance Company, or UFLIC, an indirect, wholly-owned subsidiary of GE. As part of these transactions, we will cede to UFLIC, effective as of January 1, 2004, all of our in-force structured settlement contracts, substantially all of our in-force variable annuity contracts, and a block of long-term care insurance policies that we reinsured in 2000 from The Travelers Insurance Company, a subsidiary of Citigroup, Inc., which we refer to in this prospectus as Travelers. In the aggregate, these blocks of business do not meet our target return thresholds, and although we remain liable under these contracts and policies as the ceding insurer, the reinsurance transactions will have the effect of transferring the financial results of the reinsured blocks to UFLIC. We are continuing new sales of structured settlement, variable annuity and long-term care insurance products, and we expect to achieve our targeted returns on these new sales. In addition, we will continue to service these blocks of business, which will preserve our operating scale and enable us to service and grow our new sales of these products. See "Arrangements Between GE and Our Company."

The diagram below shows the relationships among GE, GEFAHI and Genworth prior to the completion of our corporate reorganization. The arrows indicate the businesses that will be transferred to Genworth in connection with our corporate reorganization.

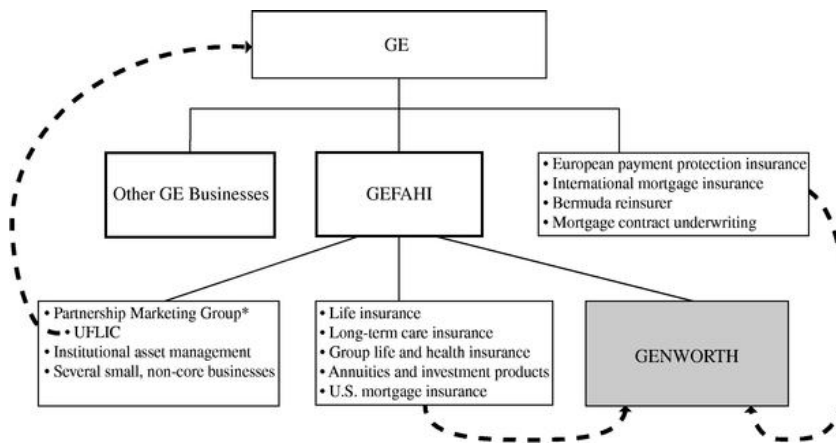

\* The Partnership Marketing Group offers life and health insurance, auto club memberships and other financial products and services directly to consumers through affinity marketing arrangements with a variety of organizations. The Partnership Marketing Group historically included UFLIC, a subsidiary that offered the life and health insurance for these arrangements.

The diagram below shows the relationships among GE, GEFAHI and Genworth after the completion of our corporate reorganization and this offering.



Class B	shares
Common stock to be held by the selling stockholder immediately after this offering	
Class B	shares
Over-allotment option	shares of Class A Common Stock to be offered by the selling stockholder if the underwriters exercise the over-allotment option in full.
Voting rights	One vote per share for all matters on which stockholders are entitled to vote, except: <ul style="list-style-type: none"> <li>• holders of Class A Common Stock will have the right separately to elect and remove a specified number of directors, and</li> <li>• holders of Class B Common Stock will have the right (1) separately to elect and remove a specified number of directors, and (2) to approve significant corporate actions, including mergers, acquisitions, dispositions and incurrences of debt.</li> </ul> <p>The specific number of directors that holders of the Class A Common Stock and the Class B Common Stock will have the separate rights to elect and remove will vary, depending upon the percentage of our common stock owned by GE.</p> <p>See "Description of Capital Stock—Common Stock."</p>
Use of proceeds	We will not receive any proceeds from the sale by the selling stockholder of Class A Common Stock in this offering or of the Equity Units or the Series A Preferred Stock in the concurrent offerings.
Dividend policy	We intend to pay quarterly cash dividends on our common stock at an initial rate of \$ per share. The first such dividend will be declared in the third quarter and paid in the fourth quarter of 2004. Class A Common Stock and Class B Common Stock will have identical dividend rights. The declaration and payment of future dividends to holders of our common stock will be at the discretion of our board of directors and will depend on many factors, including our financial condition, earnings, capital requirements of our subsidiaries, legal requirements, regulatory constraints and other factors that the board of directors deems relevant.
Proposed New York Stock Exchange symbol	The Class A Common Stock has been approved for listing on The New York Stock Exchange under the symbol "GNW."
Concurrent Offerings	Concurrently with this offering, the selling stockholder is publicly offering, by separate prospectuses: <ul style="list-style-type: none"> <li>Equity Units \$600 million of our % Equity Units.</li> <li>Series A Preferred Stock \$100 million of our % Series A Cumulative Preferred Stock.</li> </ul>
Conditions	The offerings of the Equity Units and the Series A Preferred Stock are conditioned upon the completion of this offering. <p>This offering is conditioned upon the completion of the offerings of the Series A Preferred Stock and the Equity Units.</p>

Unless otherwise indicated, all information in this prospectus:

- reflects the consummation of our corporate reorganization, whereby we will acquire substantially all of the assets and liabilities of GEFAHI and acquire certain other GE insurance businesses, in exchange for million shares of our Class B Common Stock, \$600 million of our Equity Units, \$100 million of our Series A Preferred Stock, the \$2.4 billion Short-term Intercompany Note and the \$550 million Contingent Note, all as described under "Corporate Reorganization;"
- assumes an initial public offering price of \$ per share (the midpoint of the price range set forth on the front cover of this prospectus);
- assumes the over-allotment option in this offering has not been exercised;
- excludes million shares of Class A Common Stock issuable upon the exercise of unvested stock appreciation rights to be granted on the date of this prospectus, at an exercise price equal to the initial public offering price;
- excludes million shares of Class A Common Stock issuable upon the exercise of unvested employee stock options to be granted on the date of this prospectus, at an exercise price equal to the initial public offering price;
- excludes million shares of Class A Common Stock issuable upon the exercise of unvested employee stock options that will be issued on the date of this prospectus in exchange for unvested GE stock options held by our employees, at a weighted average exercise price of \$ per share, and million shares of Class A Common Stock issuable upon the exercise of vested employee stock options that will be issued on the date of this prospectus in exchange for vested GE stock options held by our Chairman, President and Chief Executive Officer, at a weighted average exercise price of \$ per share;
- excludes million shares of Class A Common Stock issuable upon the vesting of restricted stock units and stock appreciation rights that will be issued on the date of this prospectus in exchange for unvested GE restricted stock units and stock appreciation rights;
- excludes million shares of Class A Common Stock available for future issuance under our Genworth Omnibus Incentive Plan; and
- excludes up to million shares of Class A Common Stock that we will be required to issue to settle the purchase contracts included in our Equity Units.



### Summary Historical and Pro Forma Financial Information

The following table sets forth summary historical and pro forma financial information. You should read this information in conjunction with the information under "Selected Historical and Pro Forma Financial Information," "Management's Discussion and Analysis of Financial Condition and Results of Operations" and our combined financial statements and the related notes included elsewhere in this prospectus.

Prior to the completion of this offering, we will acquire substantially all of the assets and liabilities of GEFAHI. We also will acquire certain other insurance businesses currently owned by other GE subsidiaries but managed by members of the Genworth management team. These businesses include international mortgage insurance, European payment protection insurance, a Bermuda reinsurer and mortgage contract underwriting. In consideration for the assets that we will acquire and the liabilities that we will assume in connection with our corporate reorganization, we will issue to GEFAHI million shares of our Class B Common Stock, \$600 million of our Equity Units, \$100 million of our Series A Preferred Stock, the \$2.4 billion Short-term Intercompany Note and the \$550 million Contingent Note.

We have prepared our combined financial statements as if Genworth had been in existence throughout all relevant periods. Our historical combined financial information and statements include all businesses that were owned by GEFAHI including those that will not be transferred to us, as well as the other insurance businesses that we will acquire from other GE subsidiaries, each in connection with our corporate reorganization.

The unaudited pro forma information set forth below reflects our historical combined financial information, as adjusted to give effect to the transactions described under "Selected Historical and Pro Forma Financial Information" as if each had occurred as of January 1, 2003, in the case of earnings information, and December 31, 2003, in the case of financial position information. The following transactions are reflected in the pro forma financial information:

- the removal of certain businesses of GEFAHI that will not be transferred to us in connection with our corporate reorganization, including the Partnership Marketing Group business, an institutional asset management business and several other small businesses;
- the removal of certain liabilities that we will not assume, including an aggregate of \$1.691 billion of commercial paper issued by GEFAHI and short-term borrowings from General Electric Capital Corporation of \$548 million that were outstanding as of December 31, 2003;
- the reinsurance transactions with UFLIC, including a capital contribution of \$1.836 billion that we will make to UFLIC;
- the equity and debt securities that we will issue to GEFAHI in exchange for the assets that we will acquire and the liabilities that we will assume in connection with our corporate reorganization; and
- the other adjustments described in the notes to the unaudited pro forma financial statements under "Selected Historical and Pro Forma Financial Information."

The unaudited pro forma information below is based upon available information and assumptions that we believe are reasonable. The unaudited pro forma financial information is for illustrative and informational purposes only and is not intended to represent or be indicative of what our financial condition or results of operations would have been had the transactions described above occurred on the dates indicated. The unaudited pro forma information also should not be considered representative of our future financial condition or results of operations.

In addition to the pro forma adjustments to our historical combined financial statements, various other factors will have an effect on our financial condition and results of operations after the completion of this offering, including those discussed under "Risk Factors" and "Management's Discussion and Analysis of Financial Condition and Results of Operations."

	Historical					Pro forma
	Years ended December 31,					Year ended December 31,
	2003(1)	2002	2001	2000(2)	1999	2003
<b>Combined Statement of Earnings Information</b>						
Revenues:						
Premiums	\$ 6,703	\$ 6,107	\$ 6,012	\$ 5,233	\$ 4,534	\$ 6,252
Net investment income	4,015	3,979	3,895	3,678	3,440	2,928
Net realized investment gains	10	204	201	262	280	38
Policy fees and other income	943	939	993	1,053	751	557
<b>Total revenues</b>	<b>11,671</b>	<b>11,229</b>	<b>11,101</b>	<b>10,226</b>	<b>9,005</b>	<b>9,775</b>
Benefits and expenses:						
Benefits and other changes in policy reserves	5,232	4,640	4,474	3,586	3,286	4,191
Interest credited	1,624	1,645	1,620	1,456	1,290	1,358
Underwriting, acquisition, and insurance expenses, net of deferrals	1,942	1,808	1,823	1,813	1,626	1,614
Amortization of deferred acquisition costs and intangibles(3)	1,351	1,221	1,237	1,394	1,136	1,144
Interest expense	140	124	126	126	78	138

(Dollar amounts in millions, per share amounts in dollars)

Total benefits and expenses	10,289	9,438	9,280	8,375	7,416	8,445
Earnings from continuing operations before income taxes	1,382	1,791	1,821	1,851	1,589	1,330
Provision for income taxes	413	411	590	576	455	395
Net earnings from continuing operations	\$ 969	\$ 1,380	\$ 1,231	\$ 1,275	\$ 1,134	\$ 935

Pro forma earnings per share:

Basic						
Diluted						
Pro forma shares outstanding:						
Basic						
Diluted						

**Selected Segment Information**

Total revenues:

Protection	\$ 6,153	\$ 5,605	\$ 5,443	\$ 4,917	\$ 5,839
Retirement Income and Investments	3,781	3,756	3,721	3,137	2,707
Mortgage Insurance	982	946	965	895	982
Affinity(4)	566	588	687	817	—
Corporate and Other	189	334	285	460	247
Total	\$ 11,671	\$ 11,229	\$ 11,101	\$ 10,226	\$ 9,775

Net earnings (loss) from continuing operations:

Protection	\$ 487	\$ 554	\$ 538	\$ 492	\$ 481
Retirement Income and Investments	151	186	215	250	93
Mortgage Insurance	369	451	428	414	369
Affinity(4)	16	(3)	24	(13)	—
Corporate and Other	(54)	192	26	132	(8)
Total	\$ 969	\$ 1,380	\$ 1,231	\$ 1,275	\$ 935

(Dollar amounts in millions)	Historical					Pro forma
	December 31,					December 31,
	2003(1)	2002	2001	2000(2)	1999	2003
<b>Combined Statement of Financial Position Information</b>						
Total investments	\$ 78,693	\$ 72,080	\$ 62,977	\$ 54,978	\$ 48,341	\$ 59,772
All other assets	24,738	45,277	41,021	44,598	27,758	38,095
Total assets	\$ 103,431	\$ 117,357	\$ 103,998	\$ 99,576	\$ 76,099	\$ 97,867
Policyholder liabilities	\$ 66,545	\$ 63,195	\$ 55,900	\$ 48,291	\$ 45,042	\$ 66,046
Non-recourse funding obligations(5)	600	—	—	—	—	600
Short-term borrowings	2,239	1,850	1,752	2,258	990	2,400
Long-term borrowings	529	472	622	175	175	529
All other liabilities	17,718	35,088	31,559	35,865	18,646	17,312
Total liabilities	\$ 87,631	\$ 100,605	\$ 89,833	\$ 86,589	\$ 64,853	\$ 86,887
Accumulated nonowner changes in stockholder's interest	\$ 1,672	\$ 835	\$ (664)	\$ (424)	\$ (862)	\$ 1,025
Total stockholder's interest	15,800	16,752	14,165	12,987	11,246	10,980

**U.S. Statutory Information**

Statutory capital and surplus	7,021	7,207	7,940	7,119	6,140
Asset valuation reserve	413	390	477	497	500

- (1) On August 29, 2003, we sold our Japanese life insurance and domestic auto and homeowners' insurance businesses for aggregate cash proceeds of approximately \$2.1 billion, consisting of \$1.6 billion paid to us and \$0.5 billion paid to other GE affiliates, plus pre-closing dividends. See note 4 to our combined financial statements, included elsewhere in this prospectus;
- (2) During 2000, we consummated three significant business combinations:
  - In July 2000, we reinsured 90% of Travelers' long-term care insurance portfolio and acquired certain related assets for \$411 million;
  - In April 2000, we acquired 97% of Phoenix American Life Insurance Company for \$284 million; and
  - Effective March 2000, we acquired the insurance policies and related assets of Toho Mutual Life Insurance Company. Our Japanese life insurance business assumed \$21.6 billion of policyholder liabilities and \$0.3 billion of accounts payable and accrued expenses and acquired \$20.3 billion in cash, investments and other tangible assets through this transaction. We sold this business on August 29, 2003, and its results have been presented as discontinued operations.
- (3) As of January 1, 2002, we adopted Statement of Financial Accounting Standard 142, *Goodwill and Other Intangible Assets*, and, in accordance with its provisions, discontinued amortization of goodwill. Goodwill amortization was \$84 million, \$70 million and \$53 million for the years ended December 31, 2001, 2000 and 1999, respectively, excluding goodwill amortization included in discontinued operations.
- (4) Reflects the results of the following businesses, which are owned by GEFAHI but which will not be transferred to us in connection with our corporate reorganization, including (a) the Partnership Marketing Group business, (b) an institutional asset management business, and (c) several other small businesses that are not part of our core ongoing business. See "Management's Discussion and Analysis of Financial Condition and Results of Operations—Overview—Our historical and pro forma financial information."
- (5) Reflects non-recourse funding obligations. These obligations are represented by notes that bear a floating rate of interest and mature in 2033. The notes were issued by a wholly-owned captive reinsurance subsidiary of our company to fund certain statutory reserves. Both principal and interest payments are guaranteed by a third-party insurance company.

13

---

## Risk Factors

*You should carefully consider the following risks before investing in our common stock. These risks could materially affect our business, results of operations or financial condition and cause the trading price of our common stock to decline. You could lose part or all of your investment.*

### Risks Relating to Our Businesses

#### **Interest rate fluctuations could adversely affect our business and profitability.**

Our insurance and investment products are sensitive to interest rate fluctuations and expose us to the risk that falling interest rates will reduce our "spread," or the difference between the returns we earn on the investments that support our obligations under these products and the amounts that we must pay policyholders and contractholders. Because we may reduce the interest rates we credit on most of these products only at limited, pre-established intervals, and because some of them have guaranteed minimum crediting rates, declines in interest rates may adversely affect the profitability of those products. For example, interest rates declined to unusually low levels from 2001 to 2003. During this period, our net earnings from spread-based products, such as fixed and income annuities and guaranteed investment contracts, declined from \$207 million for the year ended December 31, 2001 to \$148 million for the year ended December 31, 2003.

During periods of increasing market interest rates, we must offer higher crediting rates on interest-sensitive products, such as universal life insurance and fixed annuities, and we must increase crediting rates on in-force products to keep these products competitive. In addition, increases in market interest rates may cause increased policy surrenders, withdrawals from life insurance policies and annuity contracts and requests for policy loans, as policyholders and contractholders seek to shift assets to products with perceived higher returns. Increases in crediting rates, as well as surrenders and withdrawals, could have an adverse effect on our financial condition and results of operations. An increase in policy surrenders and withdrawals also may require us to accelerate amortization of deferred acquisition costs or other intangibles or cause an impairment of goodwill, which would reduce our net earnings.

Our long-term care insurance products also expose us to the risk of interest rate fluctuations. The pricing and expected future profitability of these products are based in part on expected investment returns. Over time, long-term care insurance products generally produce positive cash flows as customers pay periodic premiums, which we invest as we receive them. Declining interest rates may reduce our ability to achieve our targeted investment margins and may adversely affect the profitability of our long-term care insurance products.

In our mortgage insurance business, rising interest rates generally reduce the volume of new mortgages, resulting in a decrease in the volume of new insurance written. Rising interest rates also can increase the monthly mortgage payments for insured homeowners with adjustable rate mortgages, or ARMs, which could have the effect of increasing default rates on ARM loans and thereby increasing our exposure on our mortgage insurance policies. This is particularly relevant in our non-U.S. mortgage insurance business, where ARMs are the predominant mortgage product. Declining interest rates increase the rate at which insured borrowers refinance their existing mortgages, thereby resulting in cancellations of the mortgage insurance covering the refinanced loans. Declining interest rates also generally are associated with home price appreciation, which may provide insured borrowers the option of canceling their mortgage insurance coverage earlier than we anticipated in pricing that coverage. These cancellations could have an adverse effect on our results from our mortgage insurance business.

Interest rate fluctuations also could have an adverse effect on the results of our investment portfolio. During periods of declining market interest rates, the interest we receive on variable interest rate investments decreases. In addition, during those periods, we are forced to reinvest the cash we

14

---

receive as interest or return of principal on our investments in lower-yielding high-grade instruments or in lower-credit instruments to maintain comparable returns. Issuers of fixed-income securities also may decide to prepay their obligations in order to borrow at lower market rates, which exacerbates the risk that we may have to invest the cash proceeds of these securities in lower-yielding or lower-credit instruments. Declining interest rates from 2001 to 2003 contributed to a decrease in our weighted average investment yield from 6.5% for the year ended December 31, 2001 to 5.2% for the year ended December 31, 2003. For additional information regarding our investment portfolio, see "Business—Investments." For additional information regarding the sensitivity of the fixed maturities in our investment portfolio to interest rate fluctuations, see

**Downturns and volatility in equity markets could adversely affect our business and profitability.**

Significant downturns and volatility in equity markets could have an adverse effect on our financial condition and results of operations in two principal ways. First, market downturns and volatility may cause potential new purchasers of our products to refrain from purchasing products, such as variable annuities and variable life insurance, that have returns linked to the performance of the equity markets and may cause current policyholders and contractholders to withdraw cash values from those products. The sharp declines in the equity markets during 2001 and 2002 have had adverse impacts on our sales of variable annuities and other products linked to equity markets. For example, our deposits for variable annuities decreased by 28% from \$2,309 million for the year ended December 31, 2001 to \$1,667 million for the year ended December 31, 2002.

Second, downturns and volatility in equity markets can have an adverse effect on the revenues and returns from our separate account and private asset management products and services. Because these products depend on fees related primarily to the value of assets under management, declines in the equity markets have reduced our revenues by reducing the value of the investment assets we manage. For example, the recent equity market downturn caused a reduction in the value of the separate account assets underlying our variable life insurance policies, variable annuities and assets under management. As a result, our policy fees and other income in our Retirement Income and Investments segment decreased by 7% from \$243 million for the year ended December 31, 2002 to \$225 million for the year ended December 31, 2003. In addition, some of our variable annuity products contain guaranteed minimum death benefits and guaranteed minimum income payments tied to the investment performance of the assets held within the variable annuity. A significant market decline could result in declines in account values which could increase our payments under the guaranteed minimum death benefits and certain income payments in connection with variable annuities, which could have an adverse effect on our financial condition and results of operations. We also are exposed to equity risk on our holdings of common stock and other equities. For additional information regarding the sensitivity of the equity securities in our investment portfolio to equity market fluctuations, see "Management's Discussion and Analysis of Financial Condition and Results of Operations—Quantitative and Qualitative Disclosures About Market Risk—Sensitivity analysis."

**Defaults in our fixed-income securities portfolio may reduce our earnings.**

Issuers of the fixed-income securities that we own may default on principal and interest payments. As of each of December 31, 2003 and 2002, 93% of our fixed maturities had ratings equivalent to investment-grade. Nevertheless, as a result of the economic downturn and recent corporate malfeasance, the number of companies defaulting on their debt obligations increased dramatically in 2001 and 2002. As of December 31, 2003 and 2002, we had fixed maturities in or near default (where the issuer has missed payment of principal or interest or entered bankruptcy) with a fair value of \$190 million and \$181 million, respectively. A protracted economic downturn or further events of

15

---

corporate malfeasance could produce additional defaults and cause our investment returns and net earnings to decline.

We recognized gross capital gains of \$473 million, \$790 million and \$814 million for the years ended December 31, 2003, 2002 and 2001, respectively. We realized these capital gains in part to offset default-related losses during those periods. However, capital gains may not be available in the future, and if they are, we may elect not to recognize capital gains to offset losses.

**A downgrade or a potential downgrade in our financial strength or credit ratings could result in a loss of business and have a significant adverse effect on our financial condition and results of operations.**

Financial strength ratings, which various ratings organizations publish as measures of an insurance company's ability to meet contractholder and policyholder obligations, are important to maintaining public confidence in our products, the ability to market our products and our competitive position. A downgrade in our financial strength ratings, or the announced potential for a downgrade, could have a significant adverse effect on our financial condition and results of operations in many ways, including:

- reducing new sales of insurance products, annuities and other investment products;
- adversely affecting our relationships with independent sales intermediaries and our dedicated sales specialists;
- materially increasing the number or amount of policy surrenders and withdrawals by contractholders and policyholders;
- requiring us to reduce prices for many of our products and services to remain competitive; and
- adversely affecting our ability to obtain reinsurance or obtain reasonable pricing on reinsurance.

In connection with our initial public offering and separation from GE, our principal life insurance companies were downgraded from financial strength ratings of "AA" (Very Strong) by S&P and "Aa2" (Excellent) by Moody's, to "AA-" (Very Strong) and "Aa3" (Excellent), respectively. In addition, as a result of our 2003 decision to reduce excess capital at our mortgage insurance subsidiaries, our mortgage insurance companies were downgraded from financial strength ratings of "AAA" (Extremely Strong) by S&P and Fitch and "Aaa" (Exceptional) by Moody's to "AA" (Very Strong) by S&P and Fitch and "Aa2" (Excellent) by Moody's. Although we do not believe that these downgrades have negatively affected our business overall in any material respect, we cannot assure you that they will not have an adverse effect over time or that our ratings will not be further downgraded in the future. The "AA" and "AA-" ratings are the third- and fourth-highest of S&P's 21 ratings categories, respectively. The "Aa2" and "Aa3" ratings are the third- and fourth-highest of Moody's 21 ratings categories, respectively. The "AA" rating is the third-highest of Fitch's 24 ratings categories.

The charters of the Federal National Mortgage Corporation, or Fannie Mae, and the Federal Home Loan Mortgage Corporation, or Freddie Mac, only permit them to buy high loan-to-value mortgages that are insured by a "qualified insurer," as determined by each of them. Their current rules effectively provide that they will accept mortgage insurance only from private mortgage insurers with financial strength ratings of at least "AA-" by S&P and "Aa3" by Moody's. If our financial strength ratings decrease below the thresholds established by Fannie Mae and Freddie Mac, we would not be able to insure mortgages purchased by Fannie Mae or Freddie Mac. Approximately 68% of the loans we insured in the U.S. during the year ended December 31, 2003 were sold to either Fannie Mae or Freddie Mac. An inability to insure mortgage loans sold to Fannie Mae or Freddie Mac, or their transfer of our existing policies to an alternative mortgage insurer, would have an adverse effect on our financial condition and results of operations.

In 2003, the U.S. Office of Federal Housing Enterprise Oversight announced a risk-based capital rule that treats credit enhancements issued by private mortgage insurers with financial strength ratings

16

---

of "AAA" more favorably than those issued by "AA" rated insurers. Neither Fannie Mae nor Freddie Mac has adopted policies that distinguish between "AA" rated and "AAA" rated mortgage insurers. However, if Fannie Mae or Freddie Mac adopts policies that treat "AAA" rated insurers more favorably than "AA" rated insurers, our competitive

position may suffer.

Our mortgage insurance subsidiaries in Canada and Australia are also subject to local regulations that require them to maintain specified financial strength ratings to continue their operations.

In addition to the financial strength ratings of our insurance subsidiaries, ratings agencies also publish credit ratings for our company. The credit ratings have an impact on the interest rates we pay on the money we borrow. Therefore, a downgrade in our credit ratings could increase our cost of borrowing and have an adverse effect on our financial condition and results of operations.

**The ratings of our insurance subsidiaries are not evaluations directed to the protection of investors in our common stock.**

The ratings of our insurance subsidiaries described under "Business—Financial Strength Ratings" reflect each rating agency's current opinion of each subsidiary's financial strength, operating performance and ability to meet obligations to policyholders and contractholders. These factors are of concern to policyholders, contractholders, agents, sales intermediaries and lenders. Ratings are not evaluations directed to the protection of investors in our common stock. They are not ratings of our common stock and should not be relied upon when making a decision to buy, hold or sell our shares of common stock or any other security. In addition, the standards used by rating agencies in determining financial strength are different from capital requirements set by state insurance regulators. We may need to take actions in response to changing standards set by any of the ratings agencies, as well as statutory capital requirements, which could cause our business and operations to suffer.

**If our reserves for future policy benefits and claims are inadequate, we may be required to increase our reserve liabilities, which could adversely affect our results of operations and financial condition.**

We establish reserve liabilities to provide for future obligations under our insurance policies, annuities and other investment products, and mortgage insurance contract underwriting arrangements. Reserves do not represent an exact calculation of liability, but rather are estimates of expected net policy and contract benefits and claims payments over time. Our reserving assumptions and estimates require significant judgments and, therefore, are inherently uncertain. We cannot determine with precision the ultimate amounts that we will pay for actual benefit and claim payments, the timing of those payments, or whether the assets supporting our policy and contract liabilities will increase to the levels we estimate before payment of benefits or claims. We continually monitor our reserves. If we conclude that our reserves are insufficient to cover actual or expected policy and contract benefits and claims payments, we would be required to increase our reserves and incur income statement charges for the period in which we make the determination, which could adversely affect our results of operations and financial condition. For more information on how we set our reserves, see "Business—Reserves."

**As a holding company, we depend on the ability of our subsidiaries to transfer funds to us to pay dividends and to meet our obligations.**

We will act as a holding company for our insurance subsidiaries and will not have any significant operations of our own. Dividends from our subsidiaries and permitted payments to us under our tax sharing arrangements with our subsidiaries will be our principal sources of cash to pay stockholder dividends and to meet our obligations. These obligations will include our operating expenses, interest and principal on debt and contract adjustment payments on our Equity Units. These obligations also include amounts we will owe to GE under the tax matters agreement that we and GE will enter into prior to the completion of this offering. If the cash we receive from our subsidiaries pursuant to dividend payment and tax sharing arrangements is insufficient for us to fund any of these obligations,

17

---

we may be required to raise cash through the incurrence of debt, the issuance of additional equity or the sale of assets.

The payment of dividends and other distributions to us by our insurance subsidiaries is regulated by insurance laws and regulations. In general, dividends in excess of prescribed limits are deemed "extraordinary" and require insurance regulatory approval. See "Regulation." During the years ended December 31, 2003, 2002 and 2001, we received dividends from our insurance subsidiaries of \$1,472 million (\$1,400 million of which were deemed "extraordinary"), \$840 million (\$375 million of which were deemed "extraordinary") and \$410 million (none of which were deemed "extraordinary"), respectively. In addition, during the years ended December 31, 2003, 2002 and 2001, we received dividends from insurance subsidiaries related to discontinued operations of \$495 million, \$62 million and \$0, respectively. Based on statutory results as of December 31, 2003, our subsidiaries could pay dividends of \$1,121 million to us in 2004 without obtaining regulatory approval. However, as a result of the dividends we will pay in connection with our corporate reorganization, most of our insurance subsidiaries will not be able to pay us any additional dividends for the twelve months following this offering without prior regulatory approval. As part of our corporate reorganization, we will retain cash at the holding company level which we believe will be adequate to fund our dividend payments, debt service, obligations under the tax matters agreement and other obligations until our subsidiaries can resume paying dividends to us. In addition, the ability of our insurance subsidiaries to pay dividends to us, and our ability to pay dividends to our stockholders, are also subject to various conditions imposed by the rating agencies for us to maintain our ratings.

**Some of our investments are relatively illiquid.**

Our investments in privately placed fixed maturities, mortgage loans, policy loans, limited partnership interests, real estate and restricted investments held by securitization entities are relatively illiquid. These asset classes represented approximately 30% of the carrying value of our total cash and invested assets as of December 31, 2003, on a pro forma basis. If we require significant amounts of cash on short notice in excess of our normal cash requirements, we may have difficulty selling these investments in a timely manner, be forced to sell them for less than we otherwise would have been able to realize, or both. For example, our floating rate funding agreements generally contain "put" provisions through which a contractholder may terminate the funding agreement for any reason after giving notice within the contract's specified notice period, which is generally 90 days but can be less than 30 days. As of December 31, 2003, the aggregate amount of our outstanding funding agreements with put option features was approximately \$2.4 billion, and the aggregate amount of funding agreements with put option notice periods of 30 days or less was \$450 million. If an unexpected number of contractholders exercise this right and we are unable to access other liquidity sources, we may have to liquidate assets quickly. Our inability to quickly dispose of illiquid investments could have an adverse effect on our financial condition and results of operations.

**Intense competition could negatively affect our ability to maintain or increase our market share and profitability.**

Our businesses are subject to intense competition. We believe the principal competitive factors in the sale of our products are product features, price, commission structure, marketing and distribution arrangements, brand, reputation, financial strength ratings and service.

Many other companies actively compete for sales in our protection and retirement income and investments markets, including other major insurers, banks, other financial institutions and specialty providers. The principal direct and indirect competitors for our mortgage insurance business include other private mortgage insurers, as well as federal and state governmental and quasi-governmental agencies in the U.S., including the Federal Housing Administration, or FHA, and to a lesser degree, the Veterans Administration, or VA, Fannie Mae and Freddie Mac, as well as local and state housing finance agencies. We also compete with structured transactions in the capital markets and with other financial instruments designed to manage credit risk, such as credit default swaps and credit linked

18

---

notes, with lenders who forego mortgage insurance, or self-insure, on loans held in their portfolios, and with lenders that provide mortgage reinsurance through captive mortgage reinsurance programs. In Canada and some European countries, our mortgage insurance business competes directly with government entities, which provide comparable mortgage insurance. Government entities with which we compete typically do not have the same capital requirements and do not have the same profit objectives as we do. Although private companies, such as our company, establish pricing terms for their products to achieve targeted returns, these government entities may offer products on terms designed to accomplish social or political objectives or reflect other non-economic goals.

In many of our product lines, we face competition from competitors that have greater market share or breadth of distribution, offer a broader range of products, services or features, assume a greater level of risk, have lower profitability expectations or have higher financial strength ratings than we do. Many competitors offer similar products and use similar distribution channels. The substantial expansion of banks' and insurance companies' distribution capacities and expansion of product features in recent years have intensified pressure on margins and production levels and have increased the level of competition in many of our business lines.

**We may be unable to attract and retain independent sales intermediaries and dedicated sales specialists.**

We distribute our products through financial intermediaries, independent producers and dedicated sales specialists. We compete with other financial institutions to attract and retain commercial relationships in each of these channels, and our success in competing for sales through these sales intermediaries depends on factors such as the amount of sales commissions and fees we pay, the breadth of our product offerings, the strength of our brand, our perceived stability and our financial strength ratings, the marketing and services we provide to them and the strength of the relationships we maintain with individuals at those firms. From time to time, due to competitive forces, we have experienced unusually high attrition in particular sales channels for specific products. Our inability to continue to recruit productive independent sales intermediaries and dedicated sales specialists, or our inability to retain strong relationships with the individual agents at our independent sales intermediaries, would have an adverse effect on our financial condition and results of operations.

**If the counterparties to our reinsurance arrangements or to the derivative instruments we use to hedge our business risks default, we may be exposed to risks we had sought to mitigate, which could adversely affect our financial condition and results of operations.**

We use reinsurance and derivative instruments to mitigate our risks in various circumstances. Reinsurance does not relieve us of our direct liability to our policyholders, even when the reinsurer is liable to us. Accordingly, we bear credit risk with respect to our reinsurers. We cannot assure you that our reinsurers will pay the reinsurance recoverable owed to us now or in the future or that they will pay these recoverables on a timely basis. A reinsurer's insolvency or inability or unwillingness to make payments under the terms of its reinsurance agreement with us could have an adverse effect on us.

Prior to the completion of this offering, we will cede to UFLIC, effective as of January 1, 2004, policy obligations under our structured settlement contracts, which had reserves of \$12.0 billion, and our variable annuity contracts, which had general account reserves of \$2.8 billion and separate account reserves of \$7.9 billion. These contracts represent substantially all of our contracts that were in force as of December 31, 2003 for these products. In addition, effective as of January 1, 2004, we will cede to UFLIC policy obligations under a block of long-term care insurance policies that we reinsured from Travelers, which had reserves of \$1.5 billion. UFLIC has agreed to establish trust accounts for our benefit to secure its obligations under the reinsurance arrangements, and General Electric Capital Corporation, an indirect subsidiary of GE, or GE Capital, has agreed to maintain UFLIC's risk-based capital above a specified minimum level. If UFLIC becomes insolvent notwithstanding this agreement, and the amounts in the trusts are insufficient to pay UFLIC's obligations to us, our financial condition

19

---

and results of operations could be materially adversely affected. See "Arrangements between GE and our Company—Reinsurance Transactions."

In addition, we use derivative instruments to hedge various business risks. We enter into a variety of derivative instruments, including options, forwards, interest rate and currency swaps and options to enter into interest rate and currency swaps with a number of counterparties. If our counterparties fail to honor their obligations under the derivative instruments, our hedges of the related risk will be ineffective. That failure could have an adverse effect on our financial condition and results of operations.

**Fluctuations in foreign currency exchange rates and international securities markets could negatively affect our profitability.**

Our international operations generate revenues denominated in local currencies. For the years ended December 31, 2003, 2002 and 2001, respectively, 18%, 14% and 14% of our revenues, and 26%, 12% and 11% of our net earnings from continuing operations were generated by our international operations. We generally invest cash generated by our international operations in securities denominated in local currencies. As of December 31, 2003 and 2002, approximately 5% of our invested assets were held by our international operations and were invested primarily in non-U.S.-denominated securities. Although investing in securities denominated in local currencies limits the effect of currency exchange rate fluctuation on local operating results, we remain exposed to the impact of fluctuations in exchange rates as we translate the operating results of our foreign operations into our combined financial statements. We currently do not hedge this exposure, and as a result, period-to-period comparability of our results of operations is affected by fluctuations in exchange rates. Our net earnings for the year ended December 31, 2003 were favorably impacted by approximately \$25 million from changes in foreign exchange rates. In addition, because we derive a significant portion of our earnings from non-U.S.-denominated revenue, our results of operations could be adversely affected to the extent the dollar value of non-U.S.-denominated revenue is reduced as a result of a strengthening U.S. dollar.

In addition, our investments in non-U.S.-denominated securities are subject to fluctuations in non-U.S. securities and currency markets, and those markets can be volatile. In the last several years, various countries have experienced severe economic and financial disruptions, including significant devaluations of their currencies and low or negative growth rates in their economies. Non-U.S. currency fluctuations also affect the value of any dividends paid by our non-U.S. subsidiaries to their parent companies in the U.S. For additional information regarding the sensitivity of our net earnings to foreign currency exchange rate fluctuations, see "Management's Discussion and Analysis of Financial Condition and Results of Operations—Quantitative and Qualitative Disclosures About Market Risk—Sensitivity analysis."

**Our insurance businesses are heavily regulated, and changes in regulation may reduce our profitability and limit our growth.**

Our insurance operations are subject to a wide variety of laws and regulations. State insurance laws regulate most aspects of our U.S. insurance businesses, and our insurance subsidiaries are regulated by the insurance departments of the states in which they are domiciled and licensed. Our non-U.S. insurance operations are regulated principally by insurance regulatory authorities in the jurisdictions in which they are domiciled.

State laws in the U.S. grant insurance regulatory authorities broad administrative powers with respect to, among other things:

- licensing companies and agents to transact business;
- calculating the value of assets to determine compliance with statutory requirements;
- mandating certain insurance benefits;
- regulating certain premium rates;

- reviewing and approving policy forms;
- regulating unfair trade and claims practices, including through the imposition of restrictions on marketing and sales practices, distribution arrangements and payment of inducements;
- establishing statutory capital and reserve requirements and solvency standards;
- fixing maximum interest rates on insurance policy loans and minimum rates for guaranteed crediting rates on life insurance policies and annuity contracts;
- approving changes in control of insurance companies;
- restricting the payment of dividends and other transactions between affiliates; and
- regulating the types, amounts and valuation of investments.

State insurance regulators and the National Association of Insurance Commissioners, or NAIC, regularly re-examine existing laws and regulations applicable to insurance companies and their products. Changes in these laws and regulations are often made for the benefit of the consumer at the expense of the insurer and thus could have an adverse effect on our financial condition or results of operation.

Our mortgage insurance business is subject to additional laws and regulations. For a discussion of the risks associated with those laws and regulations, see "—Risks Relating to Our Mortgage Insurance Business—Changes in regulations that affect the mortgage insurance business could affect our operations significantly and could reduce the demand for mortgage insurance."

Currently, the U.S. federal government does not regulate directly the business of insurance. However, federal legislation and administrative policies in several areas can significantly and adversely affect insurance companies. These areas include financial services regulation, securities regulation, pension regulation, privacy, tort reform legislation and taxation. In addition, legislation has been introduced in the U.S. Senate, which, if enacted, would establish comprehensive and exclusive federal regulation over all "interstate insurers." This legislation would repeal the McCarran-Ferguson antitrust exemption for the business of insurance. It would also establish a Federal Insurance Regulatory Commission within the Department of Commerce that would have exclusive regulatory jurisdiction over life and property and casualty insurers that do business in more than one U.S. jurisdiction. The legislation would establish comprehensive federal regulatory oversight over such insurers, including licensing, solvency supervision, accounting and auditing practices, form and rate approval, and market conduct examination. In particular, the legislation would provide for price regulation of life insurance products, which is not now a feature of state regulation of life insurance and could affect the profitability of this business. The legislation also would establish a National Insurance Guaranty Fund which may be empowered to collect pre-funded assessments that are different from, and potentially greater than, current state guaranty fund assessment levels.

The Federal Trade Commission and the Federal Communications Commission have promulgated regulations governing telemarketing practices, including the implementation of a national Do-Not-Call Registry. These regulations require telemarketers under the jurisdiction of either agency to consult the Do-Not-Call Registry periodically and to remove from telemarketing lists any telephone numbers on that registry before making telemarketing calls. Under the McCarran-Ferguson Act, insurers are not subject to these regulations to the extent that their telemarketing activities constitute the "business of insurance" regulated by state law. Nevertheless, we believe it is not clear whether either agency will attempt to assert jurisdiction over any insurer that engages in telemarketing activities. We believe these regulations already have had an adverse effect, and may have a further adverse effect, on our sales of insurance products, such as long-term care insurance, that we market partly through telemarketing calls.

Our international operations are subject to regulation in the relevant jurisdictions in which they operate, which in many ways is similar to that of the state regulation outlined above. See "Regulation—International Regulation."

Many of our customers and independent sales intermediaries operate in regulated environments. Changes in the regulations that affect their operations also may affect our business relationships with them and their ability to buy or to distribute our products. Accordingly, these changes could have an adverse effect on our financial condition or results of operation.

Compliance with applicable insurance laws and regulations is time consuming and personnel-intensive, and changes in these laws and regulations may increase materially our direct and indirect compliance and other expenses of doing business, thus having an adverse effect on our financial condition and results of operations. For a further discussion of the regulatory framework in which we operate, see "Regulation."

**Legal and regulatory actions are common in the insurance business and may result in financial losses and harm our reputation.**

We face significant risks of litigation and regulatory investigations and actions in connection with our activities as an insurer, financial services provider, employer, investment adviser, securities issuer, investor and taxpayer. These lawsuits and regulatory actions may be difficult to assess or quantify and may seek recovery of very large or indeterminate amounts, including punitive and treble damages, which may remain unknown for substantial periods of time. A substantial legal liability or a significant regulatory action against us could have an adverse effect on our financial condition and results of operations.

Life insurance companies historically have been subject to substantial litigation resulting from policy disputes and other matters. Most recently, they have faced extensive claims, including class-action lawsuits, alleging improper life insurance sales practices. Judgments or negotiated settlements of such claims have had an adverse impact on the financial condition and results of operations of other insurance companies. We recently agreed to settle one such case and have established what we believe are adequate reserves to bring the matter to a conclusion. Substantial legal liability in any of these or future legal or regulatory actions could have an adverse financial effect or cause significant reputational harm, which could seriously harm our business prospects. For further details regarding the litigation in which we are involved, see "Business—Legal Proceedings."

**We have significant operations in India that could be adversely affected by changes in the political or economic stability of India or government policies in India, the U.S. or Europe.**

Through an arrangement with an affiliate of GE, we have a substantial team of professionals in India who provide a variety of services to our insurance operations, including customer service, transaction processing, and functional support including finance, investment research, actuarial, risk and marketing. See "Arrangements Between GE and Our Company—Relationship with GE—Arrangements Regarding Our Operations in India." The development of our operations center in India has been facilitated partly by the liberalization policies pursued by the Indian government over the past decade. The current government of India, formed in October 1999, has announced policies and taken initiatives that support the continued economic liberalization policies that have been pursued by previous governments. However, we cannot assure you that these liberalization policies will continue in the future. The rate of economic liberalization could change, and specific laws and policies affecting our business could change as well. A

significant change in India's economic liberalization and deregulation policies could adversely affect business and economic conditions in India generally and our business in particular.

The political climate in the U.S. also could change so that it would not be practical for us to use international operations centers, such as call centers. This could adversely affect our ability to maintain or create low-cost operations outside the U.S. For example, a bill recently introduced in the U.S. Senate, entitled "The Call Center Consumer's Right To Know Act," would, if enacted, require employees of call centers used by a U.S. company to disclose their physical location at the beginning of each telephone call. An identical bill recently was introduced in the U.S. House of Representatives.

22

---

Similar legislation also is pending in several states in which we operate. We believe the intent of this legislation is to alert consumers to the use of call centers that are located outside the U.S. If enacted, this legislation could result in consumer pressure to curtail our use of low-cost operations outside the U.S., which could reduce the cost benefits we currently realize from using them.

Similarly, the political or regulatory climate in Europe could change in ways which would inhibit our ability to use international operations centers. For example, changes in European privacy regulations, or more stringent interpretation or enforcement of these regulations, could require us to curtail our use of low-cost operations in India to service our European businesses, which would reduce the cost benefits we currently realize from using these operations.

**The continued threat of terrorism, the occurrence of terrorist acts and ongoing military actions could adversely affect our financial condition and results of operations.**

The continued threat of terrorism and ongoing military actions, as well as heightened security measures in response to these threats and actions, may cause significant volatility in global financial markets, disruptions to commerce and reduced economic activity. These consequences could have an adverse effect on the value of the assets in our investment portfolio. We cannot predict whether, and the extent to which, companies in which we maintain investments may suffer losses as a result of financial, commercial or economic disruptions, or how any such disruptions might affect the ability of those companies to pay interest or principal on their securities. The continued threat of terrorism also could result in increased reinsurance prices and potentially cause us to retain more risk than we otherwise would retain if we were able to obtain reinsurance at lower prices. In addition, the occurrence of terrorist actions could result in higher claims under our insurance policies than we had anticipated. For example, we incurred approximately \$25 million in losses related to the terrorist events of September 11, 2001.

**Risks Relating to Our Protection and Retirement Income and Investments Segments**

**We may face losses if morbidity rates, mortality rates or unemployment rates differ significantly from our pricing expectations.**

We set prices for our life insurance, long-term care insurance, European payment protection insurance and some annuity products based upon expected claims and payment patterns, using assumptions for morbidity rates, or likelihood of sickness, and mortality rates, or likelihood of death, of our policyholders and contractholders. The long-term profitability of these products depends upon how our actual experience compares with our pricing assumptions. For example, if morbidity rates are higher, or mortality rates are lower, than our pricing assumptions, we could be required to make greater payments under long-term care insurance policies and annuity contracts than we had projected. Similarly, if mortality rates are higher than our pricing assumptions, we could be required to make greater payments under our life insurance and European payment protection policies and annuity contracts with guaranteed minimum death benefits than we had projected.

The risk that our claims experience may differ significantly from our pricing assumptions is particularly significant for our long-term care insurance products. Long-term care insurance policies provide for long-duration coverage and, therefore, our actual claims experience will emerge over many years after pricing assumptions have been established. Moreover, as a relatively new product in the market, long-term care insurance does not have the extensive claims experience history of life insurance, and as a result, our ability to forecast future claim rates for long-term care insurance is more limited than for life insurance.

We use assumptions regarding unemployment levels in pricing our European payment protection insurance. If those unemployment levels are higher than our pricing assumptions, the claims frequency could be higher for our European payment protection insurance business than we had projected.

23

---

**We may be required to accelerate the amortization of deferred acquisition costs and the present value of future profits, which would increase our expenses and reduce profitability.**

Deferred acquisition costs, or DAC, represent costs which vary with and are primarily related to the sale and issuance of our insurance policies and investment contracts that are deferred and amortized over the estimated life of the related insurance policies. These costs include commissions in excess of ultimate renewal commissions, direct mail and printing costs, sales material and some support costs, such as underwriting and policy and contract issuance expenses. Under U.S. GAAP, DAC is deferred and recognized over the expected life of the policy or contract in relation to either the premiums or gross profits from the underlying contracts. In addition, when we acquire a block of insurance policies or investment contracts, we assign a portion of the purchase price to the right to receive future net cash flows from existing insurance and investment contracts and policies. This intangible asset, called the present value of future profits, or PVFP represents the actuarially estimated present value of future cash flows from the acquired policies. We amortize the value of this intangible asset in a manner similar to the amortization of DAC.

Our amortization of DAC and PVFP generally depends upon anticipated profits from investments, surrender and other policy and contract charges and mortality and maintenance expense margins. Unfavorable experience with regard to expected expenses, investment returns, mortality, morbidity or withdrawals or lapses may cause us to accelerate the amortization of DAC or PVFP, or both, or to record a charge to increase benefit reserves.

We regularly review DAC and PVFP to determine if they are recoverable from future income. If these costs are not recoverable, they are charged to expenses in the financial period in which we make this determination. For example, if we determine that we are unable to recover DAC from profits over the life of a block of insurance policies or annuity contracts, or if withdrawals or surrender charges associated with early withdrawals do not fully offset the unamortized acquisition costs related to those policies or annuities, we would have to recognize the additional DAC amortization as a current-period expense. In recent years, the portion of estimated product margins required to amortize DAC and PVFP has increased in most of our lines of business, with the most significant impact on investment products, primarily as the result of lower investment returns. We also regularly review the recoverability of PVFP for impairment. As of December 31, 2003 and 2002, respectively, we had \$5.8 billion and \$5.3 billion in DAC, and \$1.2 billion and \$1.3 billion of PVFP. We amortized \$1.3 billion of DAC and PVFP as a current-period expense for the year ended December 31, 2003, compared to \$1.2 billion for the year ended December 31, 2002 and \$1.2 billion for the year ended December 31, 2001.

**We may be required to recognize impairment in the value of our goodwill, which would increase our expenses and reduce our profitability.**

Goodwill represents the excess of the amount we paid to acquire our subsidiaries and other businesses over the fair value of their net assets at the date of the acquisition.



Under U.S. GAAP, we test the carrying value of goodwill for impairment at least annually at the "reporting unit" level, which is either an operating segment or a business one level below the operating segment. Goodwill is impaired if the fair value of the reporting unit as a whole is less than the fair value of the identifiable assets and liabilities of the reporting unit, plus the carrying value of goodwill, at the date of the test. For example, goodwill may become impaired if the fair value of a reporting unit as a whole were to decline by an amount greater than the decline in the value of its individual identifiable assets and liabilities. This may occur for various reasons, including changes in actual or expected earnings or cash flows of a reporting unit, generation of earnings by a reporting unit at a lower rate of return than similar businesses or declines in market prices for publicly traded businesses similar to our reporting units. If any portion of our goodwill becomes impaired, we would be required to recognize the amount of the impairment as a current-period expense. When we adopted Statement of Financial Accounting Standards 142 with respect to recognizing impairment of goodwill, effective January 1, 2002, we recognized a \$376 million impairment, net of tax, relating to our domestic auto and homeowners'

insurance business (included in discontinued operations), primarily as a result of heightened price competition in the auto insurance industry.

**Our reputation in the long-term care insurance market may be adversely affected if we were to raise premiums on our in-force long-term care insurance products.**

Unlike several of our competitors, we have never increased premiums on any in-force long-term care policies that we have issued. Although the terms of all our long-term care insurance policies permit us to increase premiums during the premium-paying period, any implementation of a premium increase could have an adverse effect on our reputation, our ability to market and sell new long-term care insurance products and our ability to retain existing policyholders.

**Genetic mapping research and other medical advances could adversely affect the financial performance of our life insurance, long-term care insurance and annuities businesses.**

Genetic mapping research includes procedures focused on identifying key genes that render an individual predisposed to specific diseases, such as cancer or Alzheimer's disease. Other medical advances, such as diagnostic imaging technologies, also may be used to detect the early onset of diseases such as cancer and heart disease. We believe that if individuals learn through genetic testing or other medical advances that they are predisposed to particular conditions that may reduce life longevity or require long-term care, they will be more likely to purchase our life and long-term care insurance policies or not permit existing policies to lapse. In contrast, if individuals learn that they are genetically unlikely to develop the conditions that reduce longevity or require long-term care, they will be less likely to purchase our life and long-term care insurance products, but more likely to purchase certain annuity products. In addition, such individuals that are existing policyholders will be more likely to permit their policies to lapse.

If we were to gain access to the same genetic or other medical information as our prospective policyholders and contractholders, then we would be able to take this information into account in pricing our life and long-term care insurance policies and annuity contracts. However, there are a number of regulatory proposals that would make genetic and other medical information confidential and unavailable to insurance companies. For example, the U.S. Senate recently passed and sent to the U.S. House of Representatives a bill that would prohibit group health plans, health insurers and employers from making enrollment decisions or adjusting premiums on the basis of genetic test information. Health plans and health insurers also would be prohibited from requiring genetic testing. The Bush Administration has expressed support for the legislation. However, the House has not taken action on the legislation, and it is not clear whether the bill will be enacted or whether life or long-term care insurance underwriting also would be affected by the final legislation. Legislators in certain states have recently introduced similar legislation. If these regulatory proposals were enacted, prospective policyholders and contractholders would only disclose this information if they chose to do so voluntarily. These factors could lead us to reduce sales of products affected by these regulatory proposals and could result in a deterioration of the risk profile of our portfolio, which could lead to payments to our policyholders and contractholders that are higher than we anticipated.

**We may face losses if there are significant deviations from our assumptions regarding the future persistency of our insurance policies and annuity contracts.**

The prices and expected future profitability of our life insurance, long-term care insurance, group life and health insurance and deferred annuity products are based in part upon expected patterns of premiums, expenses and benefits, using a number of assumptions, including those related to persistency, which is the probability that a policy or contract will remain in-force from one period to the next. The effect of persistency on profitability varies for different products. For most of our life insurance, group life and health insurance, and deferred annuity products, actual persistency that is lower than our persistency assumptions could have an adverse impact on profitability, especially in the early years of a policy or contract primarily because we would be required to accelerate the amortization of expenses

we deferred in connection with the acquisition of the policy or contract. For the years ended December 31, 2003, 2002 and 2001, persistency in our life insurance and fixed annuity businesses has been slightly higher than assumed, while persistency in our variable annuity and group life and health insurance businesses has been slightly lower than we had assumed.

For our long-term care insurance and some other health insurance policies, actual persistency in later policy durations that is higher than our persistency assumptions could have a negative impact on profitability. If these policies remain in-force longer than we assumed, then we could be required to make greater benefit payments than we had anticipated when we priced these products. This risk is particularly significant in our long-term care insurance business because we do not have the experience history that we have in many of our other businesses. As a result, our ability to predict persistency for long-term care insurance is more limited than for many other products. Some of our long-term care insurance policies have experienced higher persistency than we had assumed, which has resulted in adverse claims experience.

Because our assumptions regarding persistency experience are inherently uncertain, reserves for future policy benefits and claims may prove to be inadequate if actual persistency experience is different from those assumptions. Although some of our products permit us to increase premiums during the life of the policy or contract, we cannot guarantee that these increases would be sufficient to maintain profitability. Moreover, many of our products do not permit us to increase premiums or limit those increases during the life of the policy or contract. Significant deviations in experience from pricing expectations regarding persistency could have an adverse effect on the profitability of our products.

**Regulation XXX may have an adverse effect on our financial condition and results of operations by requiring us to increase our statutory reserves for term life and universal life insurance or incur higher operating costs.**

The Model Regulation entitled "Valuation of Life Insurance Policies," commonly known as "Regulation XXX," was promulgated by the NAIC and adopted by nearly all states as of January 1, 2001. It requires insurers to establish additional statutory reserves for term and universal life insurance policies with long-term premium guarantees. Virtually all our newly issued term and universal life insurance business is now affected by Regulation XXX.

In response to this regulation, we have increased term and universal life insurance statutory reserves and changed our premium rates for term and universal life insurance products. We also have implemented reinsurance and capital management actions to mitigate the impact of Regulation XXX. However, we cannot assure you that there will not be regulatory or other challenges to the actions we have taken to date. The result of those challenges could require us to increase statutory reserves or incur higher operating costs.

We also cannot assure you that we will be able to continue to implement actions to mitigate the impact of Regulation XXX on future sales of term and universal life insurance products. If we are unable to continue to implement those actions, we may be required to increase statutory reserves or incur higher operating costs than we currently anticipate. We also may have to implement measures that may be disruptive to our business. For example, because term and universal life insurance are particularly price-sensitive products, any increase in premiums charged on these products in order to compensate us for the increased statutory reserve requirements or higher costs of reinsurance may result in a significant loss of volume and adversely affect our life insurance operations.

**Changes in tax laws could make some of our products less attractive to consumers.**

Changes in tax laws could make some of our products less attractive to consumers. For example, in September 2001, the U.S. Congress enacted the Economic Growth and Taxpayer Relief Reconciliation Act of 2001. This act contains provisions that have significantly lowered individual income tax rates. These reductions effectively reduce the benefits of federal income tax deferral on the build-up of value

of life insurance and annuity products. The act also includes provisions that repeal the federal estate tax over a ten-year period. Some of these changes could reduce our sales of life insurance and annuity products and result in the increased surrender of these products.

In May 2003, U.S. President George Bush signed into law the Jobs and Growth Tax Relief Reconciliation Act of 2003, which reduced the federal income tax that investors are required to pay on long-term capital gains and on some dividends paid on stock. This reduction may provide an incentive for some of our customers and potential customers to shift assets into mutual funds and away from products, including annuities, designed to defer taxes payable on investment returns. Because the income taxes payable on long-term capital gains and some dividends paid on stock have been reduced, investors may decide that the tax-deferral benefits of annuity contracts are less advantageous than the potential after-tax income benefits of mutual funds or other investment products that produce dividends and long-term capital gains. A shift away from annuity contracts and other tax-deferred products would reduce our income from sales of these products, as well as the assets upon which we earn investment income.

We cannot predict whether any other legislation will be enacted, what the specific terms of any such legislation will be or how, if at all, this legislation or any other legislation could have an adverse effect on our financial condition and results of operations.

**Changes in U.S. federal and state securities laws may affect our operations and our profitability.**

U.S. federal and state securities laws apply to investment products that are also "securities," including variable annuities and variable life insurance policies. As a result, some of our subsidiaries and the policies and contracts they offer are subject to regulation under these federal and state securities laws. Our insurance subsidiaries' separate accounts are registered as investment companies under the Investment Company Act of 1940. Some variable annuity contracts and variable life insurance policies issued by our insurance subsidiaries are also registered under the Securities Act of 1933. Other subsidiaries are registered as broker-dealers under the Securities Exchange Act of 1934 and are members of, and subject to, regulation by the National Association of Securities Dealers, Inc. Some of our subsidiaries are also registered as investment advisers under the Investment Advisers Act of 1940.

Securities laws and regulations are primarily intended to ensure the integrity of the financial markets and to protect investors in the securities markets or investment advisory or brokerage clients. These laws and regulations generally grant supervisory agencies broad administrative powers, including the power to limit or restrict the conduct of business for failure to comply with those laws and regulations. Changes to these laws or regulations that restrict the conduct of our business could have an adverse effect on our financial condition and results of operations.

**Risks Relating to Our Mortgage Insurance Segment**

**Fannie Mae, Freddie Mac and a small number of large mortgage lenders exert significant influence over the U.S. mortgage insurance market.**

Our mortgage insurance products protect mortgage lenders and investors from default-related losses on residential first mortgage loans made primarily to home buyers with high loan-to-value mortgages—generally, those home buyers who make down payments of less than 20% of their home's purchase price. The largest purchasers of mortgage loans in the U.S. are Fannie Mae and Freddie Mac, which were created by Congressional charter to ensure that mortgage lenders have sufficient funds to continue to finance home purchases. In 2003, Fannie Mae purchased approximately 38% of all the mortgage loans originated in the U.S., and Freddie Mac purchased approximately 22%, according to statistics published by *Inside the GSEs*. Fannie Mae's and Freddie Mac's charters generally prohibit them from purchasing any mortgage with a face amount that exceeds 80% of the home's value, unless that mortgage is insured by a qualified insurer or the mortgage seller retains at least a 10% participation in the loan or agrees to repurchase the loan in the event of default. As a result, high

loan-to-value mortgages purchased by Fannie Mae or Freddie Mac generally are insured with private mortgage insurance. These provisions in Fannie Mae's and Freddie Mac's charters create much of the demand for private mortgage insurance in the U.S. For the year ended December 31, 2003, Fannie Mae and Freddie Mac purchased approximately 68% of the mortgage loans that we insured. As a result, a change in these provisions could have an adverse effect on our financial condition and results of operations.

In addition, increasing consolidation among mortgage lenders in recent years has resulted in significant customer concentration for mortgage insurers. Ten mortgage lenders accounted for approximately 48% of our flow new insurance written for the year ended December 31, 2003, compared to approximately 40% for the year ended December 31, 1998, and flow insurance premiums received from these lenders represented approximately 46% of the flow insurance premiums we received for the year ended December 31, 2003, compared to 36% for the year ended December 31, 1998.

As a result of the significant concentration in mortgage originators and purchasers, Fannie Mae, Freddie Mac and the largest mortgage lenders possess substantial market power which enables them to influence our business and the mortgage insurance industry in general. Although we actively monitor and develop our relationships with Fannie Mae, Freddie Mac and our largest mortgage lending customers, a deterioration in any of these relationships, or the loss of business from any of our key customers, could have an adverse effect on our financial condition and results of operations.

Our mortgage insurance business is one of the members of the Mortgage Insurance Companies of America, or MICA. In 1999, several large mortgage lenders and a coalition of financial services and housing-related trade associations, including MICA, formed FM Watch, now known as FM Policy Focus, a lobbying organization that supports expanded federal oversight and legislation relating to the role of Fannie Mae and Freddie Mac. Fannie Mae and Freddie Mac have criticized and lobbied against the positions taken by FM Policy Focus. These lobbying activities could, among other things, polarize Fannie Mae, Freddie Mac and members of FM Policy Focus. As a result of this possible polarization, our relationships with Fannie Mae and Freddie Mac may limit our opportunities to do business with some mortgage lenders, and our relationships with mortgage lenders who are members of FM Policy Focus may limit our ability to do business with Fannie Mae and Freddie Mac, as well as with mortgage lenders who are not members of FM Policy Focus and are opposed to these efforts. Any of these outcomes could have an adverse effect on our financial condition and results of operations.

**A decrease in the volume of high loan-to-value home mortgage originations or an increase in the volume of mortgage insurance cancellations could result in a decline in our revenue.**

We provide mortgage insurance primarily for high loan-to-value mortgages. Factors that could lead to a decrease in the volume of high loan-to-value mortgage originations include:

- a change in the level of home mortgage interest rates;
- a decline in economic conditions generally, or in conditions in regional and local economies;
- the level of consumer confidence, which may be adversely affected by economic instability, war or terrorist events;
- declines in the price of homes;
- adverse population trends, including lower homeownership rates;
- high rates of home price appreciation, which in times of heavy refinancing affect whether refinanced loans have loan-to-value ratios that require mortgage insurance; and
- changes in government housing policy encouraging loans to first-time homebuyers.

A decline in the volume of high loan-to-value mortgage originations would reduce the demand for mortgage insurance and, therefore, could have an adverse effect on our financial condition and results of operations.

28

---

In addition, a significant percentage of the premiums we earn each year in our U.S. mortgage insurance business are renewal premiums from insurance policies written in previous years. We estimate that approximately 70% of our gross premiums written for the year ended December 31, 2003 were renewal premiums. As a result, the length of time insurance remains in force is an important determinant of our mortgage insurance revenues. Fannie Mae, Freddie Mac and many other mortgage investors in the U.S. generally permit a homeowner to ask his loan servicer to cancel his mortgage insurance when the principal amount of the mortgage falls below 80% of the home's value. Factors that tend to reduce the length of time our mortgage insurance remains in force include:

- declining interest rates, which may result in the refinancing of the mortgages underlying our insurance policies with new mortgage loans that may not require mortgage insurance or that we do not insure;
- significant appreciation in the value of homes, which causes the size of the mortgage to decrease below 80% of the value of the home and enables the borrower to request cancellation of the mortgage insurance; and
- changes in mortgage insurance cancellation requirements under applicable federal law or mortgage insurance cancellation practices by mortgage lenders and investors.

These factors contributed to an increase in our policy cancellation rates from 43% for the year ended December 31, 2002 to 54% for the year ended December 31, 2003. A further increase in the volume of mortgage insurance cancellations in the U.S. generally would reduce the amount of our insurance in force and have an adverse effect on our financial condition and results of operations. These factors are less significant in our non-U.S. operations because we generally receive a single payment for mortgage insurance at the time a loan closes, and this premium typically is not refundable if the policy is canceled.

**Continued increases in the volume of "simultaneous second" mortgages could have an adverse effect on the U.S. market for mortgage insurance.**

High loan-to-value mortgages can consist of two simultaneous loans, known as "simultaneous seconds," comprising a first mortgage with a loan-to-value ratio of 80% and a simultaneous second mortgage for the excess portion of the loan, instead of a single mortgage with a loan-to-value ratio of more than 80%. Simultaneous second loans are often known as "80-10-10 loans" because they frequently consist of a first mortgage with an 80% loan-to-value ratio, a second mortgage with a 10% loan-to-value ratio and the remaining 10% paid in cash by the buyer, rather than a single mortgage with a 90% loan-to-value ratio.

Over the past several years, the volume of simultaneous seconds as an alternative to loans requiring mortgage insurance has increased substantially. We believe this recent increase in simultaneous second loans reflects the following factors:

- the lower monthly cost of simultaneous second loans compared to the cost of mortgage insurance, as a result of the current low-interest-rate environment and the emerging popularity of 15- and 30-year amortizing simultaneous seconds;
- the tax deductibility in most cases of interest on a second mortgage, in contrast to the non-deductibility of mortgage insurance payments; and
- negative consumer, broker and realtor perceptions about mortgage insurance.

Further increases in the volume of simultaneous seconds may cause corresponding decreases in the use of mortgage insurance for high loan-to-value mortgages, which could have an adverse effect on our financial condition and results of operations.

29

---

**The amount of mortgage insurance we write could decline significantly if mortgage lenders and investors select other alternatives to private mortgage insurance to protect against default risk, or if lenders select lower coverage levels of mortgage insurance.**

Lenders may seek to mitigate their mortgage default risks through a variety of alternatives to private mortgage insurance other than simultaneous second mortgages. These alternatives include:

- using government mortgage insurance programs, including those of the FHA, the VA and Canada Mortgage and Housing Corporation, or CMHC;
- holding mortgages in their own loan portfolios and self-insuring;

- using programs, such as those offered by Fannie Mae and Freddie Mac, requiring lower mortgage insurance coverage levels;
- originating and securitizing loans in mortgage-backed securities whose underlying mortgages are not insured with private mortgage insurance or which are structured so that the risk of default lies with the investor, rather than a private mortgage insurer; and
- using credit default swaps or similar instruments, instead of private mortgage insurance, to transfer credit risk on mortgages.

A decline in the use of private mortgage insurance in connection with high loan-to-value home mortgages for any reason would reduce the size of the mortgage insurance market and could have an adverse effect on our financial condition and results of operations.

**Our claims expenses would increase and our results of operations would suffer if the rate of defaults on mortgages covered by our mortgage insurance increases or the severity of such defaults exceeds our expectations.**

Our premium rates vary depending upon the perceived risk of a claim on the insured loan and take into account factors such as the loan-to-value ratio, our long-term historical loss experience, whether the mortgage provides for fixed payments or variable payments, the term of the mortgage and the borrower's credit history. We establish renewal premium rates for the life of a mortgage insurance policy upon issuance, and we cannot cancel the policy or adjust the premiums after the policy is issued. As a result, we cannot offset the impact of unanticipated claims with premium increases on policies in force, and we cannot refuse to renew mortgage insurance coverage. The premiums we agree to charge upon writing a mortgage insurance policy may not adequately compensate us for the risks and costs associated with the coverage we provide for the entire life of that policy.

The long-term profitability of our mortgage insurance business depends upon the accuracy of our pricing assumptions. If defaults on mortgages increase because of an economic downturn or for reasons we failed to take into account adequately, we would be required to make greater claim payments than we planned when we priced our policies. Future claims on our mortgage insurance policies may not match the assumptions made in our pricing. An increase in the amount or frequency of claims beyond the levels contemplated by our pricing assumptions could have an adverse effect on our financial condition and results of operations. In recent years, our results of operations have benefited from historically low loss ratios because of significant home price appreciation and low levels of defaults. Increases from these recent historic lows could have an adverse effect on our financial condition and results of operations.

As of December 31, 2003, approximately 79% of our risk in force had not yet reached its anticipated highest claim frequency years, which are generally between the third and seventh year of the loan. As a result, we expect our loss experience on these loans will increase as policies continue to age. If the claim frequency on the risk in force significantly exceeds the claim frequency that was assumed in setting premium rates, our financial condition, results of operations and cash flows would be adversely affected.

**A deterioration in economic conditions may adversely affect our loss experience in mortgage insurance.**

Losses in our mortgage insurance business generally result from events, such as unemployment, divorce or illness, that reduce a borrower's ability to continue to make mortgage payments. The amount of the loss we suffer, if any, depends in part on whether the home of a borrower who defaults on a mortgage can be sold for an amount that will cover unpaid principal and interest and the expenses of the sale. A deterioration in economic conditions generally increases the likelihood that borrowers will not have sufficient income to pay their mortgages and can also adversely affect housing values, which increases our risk of loss.

A substantial economic downturn across the entire U.S. could have a significant adverse effect on our financial condition and results of operations. We also may be particularly affected by economic downturns in states where a large portion of our business is concentrated. As of December 31, 2003, approximately 51% of our risk in force was concentrated in 10 states, with 8% in Florida, 7% in California and 7% in Texas. Similarly, our mortgage insurance operations in Canada, Australia and the U.K. are concentrated in the largest cities in those countries. Continued and prolonged adverse economic conditions in these states or cities could result in high levels of claims and losses, which could have an adverse effect on our financial condition and results of operations.

**A significant portion of our risk in force consists of loans with high loan-to-value ratios, which generally result in more and larger claims than loans with lower loan-to-value ratios.**

Mortgage loans with higher loan-to-value ratios typically have claim incidence rates substantially higher than mortgage loans with lower loan-to-value ratios. In our U.S. mortgage insurance business as of December 31, 2003:

- 13% of our risk in force consisted of mortgage loans with original loan-to-value ratios greater than 95%;
- 42% of our risk in force consisted of mortgage loans with original loan-to-value ratios greater than 90% but less than or equal to 95%;
- 42% of our risk in force consisted of mortgage loans with original loan-to-value ratios greater than 80% but less than or equal to 90%; and
- 3% of our risk in force consisted of mortgage loans with original loan-to-value ratios less than or equal to 80%.

In Canada, Australia and New Zealand, the risks of having a portfolio with a significant portion of high loan-to-value mortgages are greater than in the U.S. and Europe because we generally agree to cover 100% of the losses associated with mortgage defaults in those markets, compared to percentages in the U.S. and Europe that are typically 12% to 35% of the loan amount. In our non-U.S. mortgage insurance business as of December 31, 2003:

- less than 1% of our risk in force consisted of mortgage loans with original loan-to-value ratios greater than 95%;
- 27% of our risk in force consisted of mortgage loans with original loan-to-value ratios greater than 90% but less than or equal to 95%;
- 36% of our risk in force consisted of mortgage loans with original loan-to-value ratios greater than 80% but less than or equal to 90%; and
- 37% of our risk in force consisted of mortgage loans with original loan-to-value ratios less than or equal to 80%.

Although mortgage insurance premiums for higher loan-to-value ratio loans generally are higher than for loans with lower loan-to-value ratios, the difference in premium rates may not be sufficient to compensate us for the enhanced risks associated with mortgage loans bearing higher loan-to-value ratios.

**We cede a portion of our U.S. mortgage insurance business to mortgage reinsurance companies affiliated with our mortgage lending customers, and this reduces our profitability; recent changes in our ceding policies are likely to result in a reduction in business from some lenders.**

We, like other mortgage insurers, offer opportunities to our mortgage lending customers that are designed to allow them to participate in the risks and rewards of the mortgage insurance business. Many of the major mortgage lenders with which we do business have established captive mortgage reinsurance subsidiaries. These reinsurance subsidiaries assume a portion of the risks associated with the lender's insured mortgage loans in exchange for a percentage of the premiums. In most cases, our reinsurance coverage is an "excess of loss" arrangement with a limited band of exposure for the reinsurer. This means that we are required to pay the first layer of losses arising from defaults in the covered mortgages, the reinsurer indemnifies us for the next layer of losses, and we pay any losses in excess of the reinsurer's obligations. The effect of these arrangements historically has been a reduction in the profitability and return on capital of this business to us. Approximately 75% of our primary new risk written as of December 31, 2003 was subject to captive mortgage reinsurance, compared to approximately 77% as of December 31, 2002 and 61% as of December 31, 2001. Premiums ceded to these reinsurers were approximately \$139 million, \$113 million and \$76 million for the years ended December 31, 2003, 2002 and 2001, respectively.

Most large mortgage lenders have developed reinsurance operations that obtain net premium cessions from mortgage insurers of 25% to 40%. To increase our return on capital, we announced in August 2003 that, effective January 1, 2004, we generally would not renew, on their existing terms, our existing excess-of-loss risk sharing arrangements with net premium cessions in excess of 25%. We expect that these actions will result in a significant reduction in business from these lenders.

**If efforts by Fannie Mae and Freddie Mac to reduce the need for mortgage insurance are successful, they could adversely affect the results of our U.S. mortgage insurance business.**

Freddie Mac has sought changes to the provisions of its Congressional charter that requires private mortgage insurance for low-down-payment mortgages and has lobbied the U.S. Congress for amendments that would permit Fannie Mae and Freddie Mac to use alternative forms of default loss protection or otherwise forego the use of private mortgage insurance. In October 1998, the U.S. Congress passed legislation to amend Freddie Mac's charter to give it flexibility to use alternative structures to protect against mortgage default. Although this charter amendment was quickly repealed, we cannot predict whether similar legislation may be proposed or enacted in the future.

Fannie Mae and Freddie Mac have the ability to implement new eligibility requirements for mortgage insurers. They also have the authority to increase or reduce required mortgage insurance coverage percentages and to alter or liberalize underwriting standards on low-down-payment mortgages they purchase. We cannot predict the extent to which any new requirements may be enacted or how they may affect the operations of our mortgage insurance business, our capital requirements and our products.

In light of recent events concerning Freddie Mac's accounting disclosures and other matters, we believe regulatory changes governing the operations of Freddie Mac, Fannie Mae and other government-sponsored enterprises could occur. We cannot predict what the nature of these changes will be or what effect they may have on our business.

**Changes in the policies of the Federal Home Loan Banks could reduce the demand for U.S. mortgage insurance.**

The Federal Home Loan Banks, or FHLBs, purchase single-family conforming mortgage loans originated by participating member institutions. Although the FHLBs are not required to purchase insurance for mortgage loans, they currently use mortgage insurance on substantially all mortgage loans with a loan-to-value ratio above 80% and have become a source of increasing new business for us. If the FHLBs were to purchase uninsured mortgage loans or increase the loan-to-value ratio threshold

32

---

above which they require mortgage insurance, the market for mortgage insurance could decrease, and our mortgage insurance business could be adversely affected.

**We compete with government-owned and government-sponsored entities in our mortgage insurance business, and this may put us at a competitive disadvantage on pricing and other terms and conditions.**

Our mortgage insurance business competes with many different government-owned and government-sponsored entities in the U.S., Canada and some European countries. In the U.S., these entities include principally the FHA and, to a lesser degree, the VA, Fannie Mae and Freddie Mac, as well as local and state housing finance agencies. In Canada, we compete with the CMHC, a Crown corporation owned by the Canadian government. In Europe, these entities include public mortgage guarantee facilities in The Netherlands, Sweden, Finland, some of the Baltic states and Italy.

Those competitors may establish pricing terms and business practices that may be influenced by motives such as advancing social housing policy or stabilizing the mortgage lending industry, which may not be consistent with maximizing return on capital or other profitability measures. In addition, those governmental entities typically do not have the same capital requirements that we and other mortgage insurance companies have and therefore may have financial flexibility in their pricing and capacity that could put us at a competitive disadvantage in some respects. In the event that a government-owned or sponsored entity in one of our markets determines to reduce prices significantly or alter the terms and conditions of its mortgage insurance or other credit enhancement products in furtherance of social or other goals rather than a profit motive, we may be unable to compete in that market effectively, which could have an adverse effect on our financial condition and results of operations.

We compete in Canada with the CMHC, which is owned by the Canadian government and, as a sovereign entity, provides mortgage lenders with 100% capital relief from applicable bank regulatory requirements on loans that it insures. In contrast, lenders receive only 90% capital relief on loans we insure. CMHC also operates the Canadian Mortgage Bond Program, which provides lenders the ability to efficiently guaranty and securitize their mortgage loan portfolios. If we are unable to effectively distinguish ourselves competitively with our Canadian mortgage lender customers, we may be unable to compete effectively with the CMHC as a result of the more favorable capital relief it can provide or the other products and incentives that it offers to lenders.

**Changes in regulations that affect the mortgage insurance business could affect our operations significantly and could reduce the demand for mortgage insurance.**

In addition to the general regulatory risks that are described above under "—Our insurance businesses are heavily regulated, and changes in regulation may reduce our profitability and limit our growth," we are also affected by various additional regulations relating particularly to our mortgage insurance operations.

U.S. federal and state regulations affect the scope of our competitors' operations, which has an effect on the size of the mortgage insurance market and the intensity of the competition in our mortgage insurance business. This competition includes not only other private mortgage insurers, but also U.S. federal and state governmental and quasi-governmental agencies, principally the FHA, and to a lesser degree, the VA, which are governed by federal regulations. Increases in the maximum loan amount that the FHA can insure, and reductions in the mortgage insurance premiums the FHA charges, can reduce the demand for private mortgage insurance. The FHA has also streamlined its down-payment formula and made FHA insurance more competitive with private mortgage insurance in areas with higher home prices. These and other legislative and regulatory changes could cause demand for private mortgage insurance to decrease.

Our U.S. mortgage insurance business, as a credit enhancement provider in the residential mortgage lending industry, also is subject to compliance with various federal and state consumer protection laws, including the Real Estate Settlement Procedures Act, the Equal Credit Opportunity

33

Act, the Fair Housing Act, the Homeowners Protection Act, the Federal Fair Credit Reporting Act, the Fair Debt Collection Practices Act and others. Among other things, these laws prohibit payments for referrals of settlement service business, require fairness and non-discrimination in granting or facilitating the granting of credit, require cancellation of insurance and refund of unearned premiums under certain circumstances, govern the circumstances under which companies may obtain and use consumer credit information, and define the manner in which companies may pursue collection activities. Changes in these laws or regulations could adversely affect the operations and profitability of our mortgage insurance business. For example, the Department of Housing and Urban Development is considering a rule that would exempt certain mortgages that provide a single price for a package of settlement services from the prohibition in the Real Estate Settlement Procedures Act, or RESPA, against payments for referrals of settlement service business. If mortgage insurance were included among the settlement services that, when offered as a package, would be exempt from this prohibition, then mortgage lenders would have greater leverage in obtaining business concessions from mortgage insurers.

The Office of Thrift Supervision recently amended its capital regulations to increase from 80% to 90% the loan-to-value threshold in the definition of a "qualifying mortgage loan." The capital regulations assign a lower risk weight to qualifying mortgage loans than to non-qualifying loans. As a result, these new regulations no longer penalize mortgage lenders for retaining loans that have loan-to-value ratios between 80% and 90% without credit enhancements. Other regulators, including the U.S. Federal Deposit Insurance Corporation, also have raised corresponding loan-to-value thresholds for qualifying mortgage loans from 80% to 90%.

Mortgage lenders may compete with mortgage insurers as a result of legislation that removed restrictions on affiliations between banks and mortgage insurers. The Graham-Leach-Bliley Act of 1999 permits the combination of banks, insurers, including mortgage insurers, and securities firms under one holding company. This legislation may increase competition by increasing the number, size and financial strength of potential competitors. In addition, mortgage lenders that establish captive reinsurance businesses or affiliate with competing mortgage insurers may reduce their purchases of our products.

Lenders and loan aggregators also have faced new liabilities and compliance risks posed by state and local laws which have been enacted in recent years to combat "predatory lending" practices. In February 2003 and March 2004, the Ney-Lucas Responsible Lending Act of 2003 and the Prohibit Predatory Lending Act of 2004, respectively, were introduced in the U.S. House of Representatives. These bills, if enacted, would, among other things, prohibit certain lending practices on high-cost mortgages and limit the liability of persons who comply with the law. It is unclear in what form, if any, either of these bills will be enacted or what impact they would have on our business and the mortgage lending, securitization, and insurance industries generally.

We have an agreement with the Canadian government under which it guarantees the benefits payable under a mortgage insurance policy, less 10% of the original principal amount of an insured loan, in the event that we fail to make claim payments with respect to that loan because of insolvency. This guarantee provides that the government has the right to review the terms of the guarantee in certain circumstances, including if GE's ownership of our Canadian mortgage insurance company decreases below 50%. GE has informed us that it expects to reduce its equity ownership of us to below 50% within two years of the completion of this offering. That disposition would permit the Canadian government to review the terms of its guarantee and could lead to a termination of the guarantee for any new insurance written after the termination. Although we believe the Canadian government will preserve the guarantee to maintain competition in the Canadian mortgage insurance industry, any adverse change in the guarantee's terms and conditions or termination of the guarantee could have an adverse effect on our ability to continue offering mortgage insurance products in Canada.

34

---

The Australian Prudential Regulatory Authority, or APRA, regulates all financial institutions in Australia, including general, life and mortgage insurance companies. APRA's license conditions require Australian mortgage insurance companies, including ours, to be mono-line insurers, which are insurance companies that offer just one type of insurance product. However, in November 2003, APRA announced that it is considering, and has sought comment on, a proposal to eliminate the requirement that mortgage insurance companies be mono-line insurers, which APRA believes could facilitate the entry of new competitors.

APRA currently is studying the adequacy of the capital requirements that govern lenders and mortgage insurers in Australia, particularly in the event of a severe recession accompanied by a significant decline in housing values. If APRA concludes that the capital requirements that currently govern mortgage insurers are not sufficient and decides to increase the amount of capital required for mortgage insurers, we may, depending on the amount of such increase, be required to increase the capital in our Australian mortgage insurance business. This would reduce our returns on capital from those operations.

#### **Our U.S. mortgage insurance business could be adversely affected by legal actions under RESPA.**

RESPA prohibits paying lenders for the referral of settlement services, including mortgage insurance. This precludes us from providing services to mortgage lenders free of charge, charging fees for services that are lower than their reasonable or fair market value, and paying fees for services that others provide that are higher than their reasonable or fair market value. A number of lawsuits, including some that were class actions, have challenged the actions of private mortgage insurers, including our company, under RESPA, alleging that the insurers have provided products or services at improperly reduced prices in return for the referral of mortgage insurance. We and several other mortgage insurers, without admitting any wrongdoing, reached a settlement in these cases, which includes an injunction that prohibited certain specified practices and details the basis on which mortgage insurers may provide agency pool insurance, captive mortgage reinsurance, contract underwriting and other products and services and be deemed to be in compliance with RESPA. The injunction expired on December 31, 2003, and it is not clear whether the expiration of the injunction will result in new litigation against private mortgage insurers, including us, to extend the injunction or to seek damages under RESPA. We also cannot predict whether our competitors will change their pricing structure or business practices after the expiration of the injunction, which could require us to alter our pricing structure or business practices in response to their actions or suffer a competitive disadvantage, or whether any services we or they provide to mortgage lenders could be found to violate RESPA, the current injunction or any future injunction that might be issued. In addition, U.S. federal and state officials also are authorized to enforce RESPA and to seek civil and criminal penalties, and we cannot predict whether these proceedings might be brought against us or other mortgage insurers. Any such proceedings could have an adverse effect on our financial condition and results of operations.

#### **Our U.S. mortgage insurance business could be adversely affected by legal actions under the Federal Fair Credit Reporting Act.**

Two actions recently have been filed against us in Illinois, each seeking certification of a nationwide class of consumers who allegedly were required to pay for our private mortgage insurance at a rate higher than our "best available rate," based upon credit information we obtained. Each action alleges that the Federal Fair Credit Reporting Act, or the FCRA, requires notice to such borrowers and that we violated the FCRA by failing to give such notice. The plaintiffs in one action allege in the complaint that they are entitled to "actual damages" and "damages within the Court's discretion of not more than \$1,000 for each separate violation" of the FCRA. The plaintiffs in the other action allege that they are entitled to "appropriate actual, punitive and statutory damages" and "such other or further relief as the Court deems proper." Similar cases are pending against six other mortgage insurers. We intend to vigorously defend against these actions, but we cannot predict their outcome.

35

---

#### **Potential liabilities in connection with our U.S. contract underwriting services could have an adverse effect on our financial condition and results of operations.**

We offer contract underwriting services to many of our mortgage lenders in the U.S., pursuant to which our employees and contractors work directly with the lender to determine whether a particular mortgage applicant's loan application complies with the lender's loan underwriting guidelines or the investor's loan purchase requirements. We also assist in compiling and submitting this data to the automated underwriting systems of Fannie Mae and Freddie Mac, which then independently analyze the data.

Under the terms of our contract underwriting agreements, we agree to indemnify the lender against losses incurred in the event that we make material errors in determining whether loans processed by our contract underwriters meet specified underwriting or purchase criteria. As a result, we assume credit and interest rate risk in connection with our contract underwriting services. Worsening economic conditions, a deterioration in the quality of our underwriting services or other factors could cause our contract underwriting liabilities to increase and have an adverse effect on our financial condition and results of operations. Although we have established reserves to provide for potential claims in connection with our contract underwriting services, we have limited historical experience that we can use to establish reserves for these potential liabilities, and these reserves may not be adequate to cover liabilities that may arise.

**If the European mortgage insurance market does not grow as we expect, we will not be able to execute our strategy to expand our business into this market.**

We have devoted resources to marketing our mortgage insurance products in Europe, and we plan to continue these efforts. Our growth strategy depends partly upon the development of favorable legislative and regulatory policies throughout Europe that support increased homeownership and provide capital relief for institutions that insure their mortgage loan portfolios with private mortgage insurance. In furtherance of these policies, we have collaborated with government agencies to develop bank regulatory capital requirements that provide incentives to lenders to implement risk transfer strategies such as mortgage insurance, as well as governmental policies that encourage homeownership as a wealth accumulation strategy for borrowers with limited resources to make large down payments. We have invested, and we will continue to invest, significant resources to advocate such a regulatory environment at the national and pan-European levels. However, if European legislative and regulatory agencies fail to adopt these policies, then the European markets for high loan-to-value lending and mortgage insurance may not expand as we currently anticipate, and our growth strategy in those markets may not be successful.

#### **Risks Relating to Our Separation from GE**

**Our separation from GE could adversely affect our business and profitability due to GE's strong brand and reputation.**

As a subsidiary of GE, our businesses have marketed many of their products using the "GE" brand name and logo, and we believe the association with GE has provided many benefits, including:

- a world-class brand associated with trust, integrity and longevity;
- perception of high-quality products and services;
- preferred status among our customers, independent sales intermediaries and employees;
- strong capital base and financial strength; and
- established relationships with U.S. federal and state and non-U.S. regulators.

Following this offering, our separation from GE could adversely affect our ability to attract and retain highly qualified independent sales intermediaries and dedicated sales specialists for our products. We

---

may be required to lower the prices of our products, increase our sales commissions and fees, change long-term selling and marketing agreements and take other action to maintain our relationship with our independent sales intermediaries and our dedicated sales specialists, all of which could have an adverse effect on our financial condition and results of operations.

After our separation from GE, some of our existing policyholders, contractholders and other customers may choose to stop doing business with us, and this could increase our rate of surrenders and withdrawals in our policies and contracts. In addition, other potential policyholders and contractholders may decide not to purchase our products because we no longer will be a part of GE.

We cannot accurately predict the effect that our separation from GE will have on our sales intermediaries, customers or employees. The risks relating to our separation from GE could materialize at various times, including:

- immediately upon the completion of this offering and the concurrent offerings, when GE's beneficial ownership in our common stock will decrease to %;
- when GE reduces its ownership in our common stock to a level below 50%; and
- when we cease using the GE name and logo in our sales and marketing materials, particularly when we deliver notices to our distributors and customers that the names of some of our insurance subsidiaries will change.

**We will only have the right to use the GE brand name and logo for a limited period of time. If we fail to establish in a timely manner a new, independently recognized brand name with a strong reputation, our revenue and profitability could decline.**

Upon completion of this offering, our corporate name will be "Genworth Financial, Inc.," although we and our insurance and other subsidiaries may use the GE brand name and logo in marketing our products and services. Pursuant to a transitional trademark license agreement, GE will grant us the right to use the "GE" mark and the "GE" monogram for up to five years in connection with our products and services. GE also will grant us the right to use "GE," "General Electric" and "GE Capital" in the corporate names of our subsidiaries until the earlier of twelve months after the date on which GE owns less than 20% of our outstanding common stock and five years from the date of the trademark license agreement. When our right to use the GE brand name and logo expires, we may not be able to maintain or enjoy comparable name recognition or status under our new brand. In addition, insurance regulators in the U.S. and the other countries where we do business could require us to accelerate the transition to our independent brand. If we are unable to successfully manage the transition of our business to our new brand, our reputation among our independent sales intermediaries, customers and employees could be adversely affected.

**Our historical combined and pro forma financial information is not necessarily representative of the results we would have achieved as a stand-alone company and may not be a reliable indicator of our future results.**

The historical combined and pro forma financial information included in this prospectus does not reflect the financial condition, results of operations or cash flows we would have achieved as a stand-alone company during the periods presented or those we will achieve in the future. This is primarily a result of the following factors:

- Our historical combined financial information reflects certain businesses that will not be included in our company following the completion of this offering. For a description of the components of our historical combined financial information, see "Management's Discussion and Analysis of Financial Condition and Results of Operations—Overview—Our historical and pro forma financial information" and our audited and unaudited financial statements included elsewhere in this prospectus;

- Our historical combined and pro forma financial results reflect allocations of corporate expenses from GE. Those allocations may be different from the comparable expenses we would have incurred had we operated as a stand-alone company;
- Our working capital requirements historically have been satisfied as part of GE's corporate-wide cash management policies. After our separation from GE, we may not be able to obtain financing on terms as favorable as could be obtained from or by GE. In this case, our cost of debt could be higher and our capitalization might be different from that reflected in our historical combined financial statements;
- Significant changes may occur in our cost structure, management, financing and business operations as a result of our separation from GE. These changes could result in increased costs associated with reduced economies of scale; stand-alone costs for services currently provided by GE; marketing and legal entity transition expenses related to building a company brand identity separate from GE; the need for additional personnel to perform services currently provided by GE; and the legal, accounting, compliance and other costs associated with being a public company with listed equity. See "—The terms of our arrangements with GE may be more favorable than we will be able to obtain from an unaffiliated third party. We may be unable to replace the services GE provides us in a timely manner or on comparable terms;"
- Our separation from GE and the adoption of our new brand may have an adverse effect on our relationships with distributors, customers, employees and regulators and government officials, which could result in reduced sales, increased policyholder terminations and withdrawals, increased regulatory scrutiny and disruption to our business operations;
- Under some of our agreements, our separation from GE will allow the other party to the agreement to terminate the agreement pursuant to a change of control provision, which may be triggered when GE's ownership of our company decreases to less than 50%. If the other party to any of these agreements does not wish to continue the agreement, then we may be required to terminate or modify our existing agreement or seek alternative arrangements, which could result in reduced sales, increased costs or other disruptions to our business; and
- The pro forma financial information presented in this prospectus gives effect to several significant transactions that we will implement prior to the completion of this offering, including the reinsurance transactions with UFLIC, as if those transactions were already consummated. The unaudited pro forma information gives effect to the transactions as if each had occurred as of January 1, 2003, in the case of earnings information, and December 31, 2003, in the case of financial position information. This pro forma financial information is based upon available information and assumptions that we believe are reasonable. However, this pro forma financial information is for illustrative and informational purposes only and is not intended to represent or be indicative of what our financial condition or results of operations would have been had those transactions occurred as of those dates, nor what they may be in the future.

**The terms of our arrangements with GE may be more favorable than we will be able to obtain from an unaffiliated third party. We may be unable to replace the services GE provides us in a timely manner or on comparable terms.**

We and GE will enter into a transition services agreement and other agreements prior to the completion of this offering. Pursuant to the transition services agreement, GE and its affiliates will agree to provide us with transitional services after this offering, including treasury, payroll and other financial services, human resources and employee benefit services, legal services, information systems and network services, and procurement and sourcing support.

We negotiated these arrangements with GE in the context of a parent-subsidary relationship. Although GE is contractually obligated to provide us with services during the term of the transition services agreement, we cannot assure you that these services will be sustained at the same level after

the expiration of that agreement, or that we will be able to replace these services in a timely manner or on comparable terms. Other agreements with GE will also govern the relationship between us and GE after this offering and will provide for the allocation of employee benefit, tax and other liabilities and obligations attributable or related to periods or events prior to the separation. They also contain terms and provisions that may be more favorable than terms and provisions we might have obtained in arm's-length negotiations with unaffiliated third parties. When GE ceases to provide services pursuant to those arrangements, our costs of procuring those services from third parties may increase. See "Arrangements Between GE and Our Company—Relationship with GE."

**We have agreed to make payments to GE based on the projected amounts of certain tax benefits, and these payments will remain fixed even if, because of insufficient taxable income or as a result of reduced tax rates, our actual tax benefits are less than projected.**

We will enter into a tax matters agreement with GE prior to the completion of this offering. We refer to this agreement in this prospectus as the Tax Matters Agreement. Under the Tax Matters Agreement, we will have an obligation to pay to GE a fixed amount over 15 to 25 years. This fixed obligation will equal 80% of the tax savings we are projected to realize (subject to a maximum amount) as a result of the tax elections to be made in connection with our separation from GE. Based upon current estimates, and assuming that certain elections are made by GE, the present value of our fixed obligations would be approximately \$423 million. These estimates will change, however, as a result of a number of factors, including a final determination of the value of our company and its individual assets, and the present value of our obligations to GE may be larger as a result. However, we have agreed with GE that except for specified contingent benefits and excluding interest on payments we defer, our total payments to GE will not exceed \$640 million. The Tax Matters Agreement generally provides for increases or reductions to our payment obligations if the current estimates underlying the projected tax benefits prove inaccurate, but it does not provide for reductions in our obligations if we fail to generate sufficient income to realize the projected tax savings or if our actual tax savings are reduced as a result of reduced tax rates. In these circumstances, we will remain obligated to pay to GE the fixed obligation, as initially projected or subsequently adjusted, even though it exceeds 80%, or even 100%, of the tax benefits we actually realize. If the amounts we are obligated to pay to GE remain fixed while the tax benefits we actually realize decline, there could be a material adverse effect on our financial condition and results of operations. See "Arrangements Between GE and Our Company—Relationship with GE—Tax Matters Agreement."

**In the event of a change in control of our company, our obligations under the Tax Matters Agreement could accelerate, and we cannot be sure that we will have sufficient funds to meet these obligations.**

In some circumstances, such as a change in control over the management and policies of our company (other than through a sale of our stock by GE), the amounts we will owe under the Tax Matters Agreement could accelerate, and the amounts then due and payable could be substantial. The acceleration of payments would be subject to the approval of certain state insurance regulators, and we are obligated to use our reasonable best efforts to see that these approvals are granted. In the event these approvals are granted and the acceleration of payments does occur, we cannot assure you that we will have sufficient funds available to meet these accelerated obligations when due. If we do not have sufficient funds available, we may seek to fund these obligations from dividends or other payments from our subsidiaries, but we cannot be certain that they will have sufficient funds available or be permitted to transfer them to us. See "As a holding company, we depend on the ability of our subsidiaries to transfer funds to us to pay dividends



and to meet our obligations." We also may seek to fund these obligations from the proceeds of the issuance of debt or equity securities or the sale of assets, but we cannot assure you that we will be able to successfully issue any securities or consummate an asset sale.

---

**Under the Tax Matters Agreement, GE will control certain tax returns and audits that can result in tax liability for us.**

Under the Tax Matters Agreement, GE has retained control over the preparation and filing, as well as the contests, audits and amendments or other changes of certain pre-separation federal income tax returns with respect to which we remain liable for taxes. In addition, determinations regarding the allocation to us of responsibility to pay taxes for pre-separation periods will be made by GE in its reasonable discretion. While the Tax Matters Agreement provides that we will not be liable for taxes resulting from returns filed or matters settled by GE without our consent if the return or settlement position is found to be unreasonable, taking into account both the liability that we incur and any non-Genworth tax benefit, it is possible that we will pay more taxes than we would have paid if we had been permitted to control such matters.

**GE has significant control over us and may not always exercise its control in a way that benefits our public stockholders.**

Upon the completion of this offering and the concurrent offerings, GE will beneficially own approximately % of our outstanding common stock. GE has informed us that, following completion of this offering, it intends, subject to market conditions, to divest its remaining interest in us as soon as practicable. GE has also informed us that, in any event, it expects to reduce its interest to below 50% within two years of the completion of this offering. GE has adopted a formal Plan of Divestiture embodying this expectation to reduce its interest below 50% and has represented to the Internal Revenue Service, or IRS, that it will accomplish the divestiture. The adverse financial consequences to GE from a failure to effect the divestiture below 50% are significant. However, so long as GE continues to beneficially own more than 50% of our outstanding voting stock, GE generally will be able to determine the outcome of many corporate actions requiring stockholder approval. GE, in its capacity as the beneficial holder of all outstanding shares of our Class B Common Stock, also will have the right to elect a majority of the members of our board of directors so long as it continues to beneficially own more than 50% of our outstanding common stock and will have the right to elect a decreasing percentage of the members of our board of directors as its beneficial ownership of our common stock decreases. In addition, until the first date on which GE owns less than 20% of our outstanding common stock, the prior affirmative vote or written consent of GE is required for the following actions (subject in each case to certain agreed exceptions):

- a merger involving us or any of our subsidiaries (other than mergers involving our subsidiaries to effect acquisitions for a price less than or equal to \$700 million);
- acquisitions by us or our subsidiaries of the stock or assets of another business for a price (including assumed debt) in excess of \$700 million;
- dispositions by us or our subsidiaries of assets in a single transaction or a series of related transactions for a price (including assumed debt) in excess of \$700 million;
- incurrence or guarantee of debt by us or our subsidiaries in excess of \$700 million outstanding at any one time or that would reasonably be expected to result in a negative change in any of our credit ratings, excluding, the debt described in this prospectus that we intend to incur concurrently with, and shortly after, the completion of this offering (provided that any debt in excess of \$500 million incurred under our commercial paper program and our five-year and 364-day revolving credit facilities will be subject to the \$700 million limitation described above), intercompany debt (within Genworth), debt incurred in connection with permitted securitization transactions and debt determined to constitute operating leverage by a nationally recognized statistical rating organization;
- issuance by us or our subsidiaries of capital stock or other securities convertible into capital stock;
- dissolution, liquidation or winding up of our company; and

- 
- alteration, amendment, termination or repeal, or adoption of any provision inconsistent with, certain provisions of our certificate of incorporation or our bylaws.

Because GE's interests may differ from your interests, actions GE takes with respect to us, as our controlling stockholder, and with respect to those corporate actions requiring its prior affirmative written consent described above, may not be favorable to you.

**We derive a significant portion of the premiums in our European payment protection insurance business from transactions with GE.**

For the years ended December 31, 2003 and 2002, GE's consumer finance division and other related GE entities accounted for 19% and 14% of the gross written premiums in our European payment protection insurance business, respectively. Prior to the completion of this offering, we will enter into a five-year agreement that extends our relationship with GE's consumer finance division and provides us with the right to be the exclusive provider of payment protection insurance in Europe for GE's consumer finance operations in jurisdictions where we offer these products. However, if GE determines not to offer payment protection insurance, we may not be able to replace those revenues on a timely basis, and our financial condition and results of operations could suffer. See "Business—Protection—Products—European payment protection insurance."

**If GE engages in the same type of business we conduct, our ability to successfully operate and expand our business may be hampered.**

Our certificate of incorporation provides that, subject to any contractual provision to the contrary, GE will have no obligation to refrain from:

- engaging in the same or similar business activities or lines of business as us; or
- doing business with, or in competition with, any of our clients, customers or vendors.

GE is a diversified technology and services company with significant financial services businesses, including consumer finance, asset management and insurance activities. Following this offering, GE will continue to be engaged in the marketing of supplemental life insurance, including accidental death and dismemberment coverage. GE will also continue to market and underwrite dental and vision insurance, medical stop-loss insurance and primary property and casualty insurance. In addition, GE will continue to operate a significant reinsurance business, including life reinsurance, a life insurance business in the U.K. and a savings and pension business in France. Because of GE's significant financial resources, GE could have a significant competitive advantage over us should it decide to engage in businesses that compete with any of the businesses we conduct.

GE has generally agreed for five years after this offering not to use the "GE" mark or the "GE" monogram or the name "General Electric" in connection with the marketing or underwriting on a primary basis of life insurance, long-term care insurance, annuities, or group life and health insurance in the U.S., or of auto insurance products in Mexico, and the underwriting or issuing of mortgage insurance products anywhere in the world. GE's agreement to restrict the use of its brand will terminate earlier upon the occurrence of certain events, including termination of our transitional trademark license agreement with GE and our discontinuation of the use of the "GE" mark or the "GE" monogram. In

addition, GE Consumer Finance, the consumer finance division of GE, has generally agreed to distribute on an exclusive basis our payment protection insurance products in certain European countries for five years, unless earlier terminated. See "Business—Protection—European payment protection insurance."

**Conflicts of interest may arise between us and GE that could be resolved in a manner unfavorable to us.**

Questions relating to conflicts of interest may arise between us and GE in a number of areas relating to our past and ongoing relationships. Five of our directors were designated to our board of

41

---

directors by GE. One of these directors is both an officer and director of GE, and the other four of these directors are also officers of GE. These directors and a number of our officers own substantial amounts of GE stock and options to purchase GE stock, and all of them participate in GE pension plans. Ownership interests of our directors or officers in GE shares, or service as a director or officer of both our company and GE, could give rise to potential conflicts of interest when a director or officer is faced with a decision that could have different implications for the two companies. These potential conflicts could arise, for example, over matters such as the desirability of an acquisition opportunity, employee retention or recruiting, or our dividend policy.

The corporate opportunity policy set forth in our certificate of incorporation addresses potential conflicts of interest between our company, on the one hand, and GE and its officers and directors who are directors of our company, on the other hand. By becoming a stockholder in our company, you will be deemed to have notice of and have consented to these provisions of our certificate of incorporation. Although these provisions are designed to resolve conflicts between us and GE fairly, we cannot assure you that any conflicts will be so resolved. The principles for resolving such potential conflicts of interest are described under "Description of Capital Stock—Provisions of Our Certificate of Incorporation Relating to Related-Party Transactions and Corporate Opportunities."

**Risks Relating to This Offering**

**Future sales of a substantial number of shares of our common stock may depress the price of our shares.**

If our stockholders sell a large number of shares of our common stock, or if we issue a large number of shares of our common stock in connection with future acquisitions, financings, or other circumstances, the market price of shares of our common stock could decline significantly. Moreover, the perception in the public market that our stockholders might sell shares of our common stock could depress the market price of those shares.

GE has informed us that, following completion of this offering and the concurrent offerings, it intends, subject to market conditions, to divest its remaining interest in us as soon as practicable. GE has also informed us that, in any event, it expects to reduce its interest to below 50% within two years of the completion of this offering. GE currently expects to reduce its interest through one or more additional public offerings of our common stock, but it is not obligated to divest our shares in this manner. See "Shares Eligible for Future Sale."

All the shares sold in this offering will be freely tradable without restriction, except for shares owned by any of our affiliates, including GE. Immediately after this offering, the public market for our common stock will include only the million shares of Class A Common Stock that are being sold by the selling stockholder in this offering, or million shares if the underwriters exercise their over-allotment option in full. After the offering, we intend to register million shares of Class A Common Stock, which are reserved for issuance under our employee benefit plans. Once we register these shares, they can be sold in the public market upon issuance, subject to restrictions under the securities laws applicable to resales by affiliates. In addition, we have granted GE demand and "piggyback" registration rights with respect to the shares of our common stock it will hold upon completion of this offering. GE may exercise its demand and piggyback registration rights, and any shares so registered will be freely tradable in the public market, except for shares acquired by any of our affiliates. See "Arrangements Between GE and Our Company—Relationship with GE—Registration Rights Agreement" and "Shares Eligible for Future Sale."

GEFAHI and our directors and executive officers have entered into lock-up agreements in which they have agreed that they will not sell, directly or indirectly, any common stock for a period of 180 days from the date of this prospectus without the prior written consent of Morgan Stanley & Co. Incorporated and Goldman, Sachs & Co. See "Shares Eligible for Future Sale."

42

---

**Our common stock has no prior public market, and we cannot assure you that an active trading market will develop.**

Prior to this offering, there has not been a market for our common stock. Although our Class A Common Stock has been approved for listing on The New York Stock Exchange, an active trading market in our Class A Common Stock might not develop or continue. If you purchase shares of Class A Common Stock in this offering, you will pay a price that was not established in a competitive market. Rather, you will pay a price that was determined by negotiations with the representatives of the underwriters based upon an assessment of the valuation of our common stock and a book-building process. The public market may not agree with or accept this valuation, in which case you may not be able to sell your shares at or above the initial offering price.

**The price of our common stock may be volatile and may be affected by market conditions beyond our control.**

Our share price is likely to fluctuate in the future because of the volatility of the stock market in general and a variety of factors, many of which are beyond our control, including:

- quarterly variations in actual or anticipated results of our operations;
- changes in financial estimates by securities analysts;
- actions or announcements by our competitors;
- regulatory actions;
- changes in the market outlook for the insurance industry;
- departure of our key personnel; and
- future sales of our common stock.

The stock market has recently experienced extreme price and volume fluctuations. The market prices of securities of insurance and financial services companies have experienced fluctuations that often have been unrelated or disproportionate to the operating results of these companies. These market fluctuations could result in extreme volatility in the price of shares of our common stock, which could cause a decline in the value of your investment. You should also be aware that price volatility may be greater if the public float and trading volume of shares of our common stock is low.

**Applicable laws, provisions of our certificate of incorporation and bylaws and our Tax Matters Agreement with GE may discourage takeover attempts and business combinations that stockholders might consider in their best interests.**

Applicable laws, provisions of our certificate of incorporation and bylaws and our Tax Matters Agreement may delay, deter, prevent or render more difficult a takeover attempt that our stockholders might consider in their best interests. For example, they may prevent our stockholders from receiving the benefit from any premium to the market price of our common stock offered by a bidder in a takeover context. Even in the absence of a takeover attempt, the existence of these provisions may adversely affect the prevailing market price of our common stock if they are viewed as discouraging takeover attempts in the future.

Various states and non-U.S. jurisdictions in which our insurance companies are domiciled or deemed domiciled must approve any acquisition of or change in control of those insurance companies. Under most states' statutes, an entity is presumed to have control of an insurance company if it owns, directly or indirectly, 10% or more of the voting stock of that insurance company. These regulatory restrictions may delay, deter or prevent a potential merger or sale of our company, even if our board of directors decides that it is in the best interests of stockholders for us to merge or be sold. These restrictions also may delay sales by us or acquisitions by third parties of our subsidiaries.

Section 203 of the Delaware General Corporation Law may affect the ability of an "interested stockholder" to engage in certain business combinations, including mergers, consolidation or

acquisitions of additional shares, for a period of three years following the time that the stockholder becomes an "interested stockholder." An "interested stockholder" is defined to include persons owning directly or indirectly 15% or more of the outstanding voting stock of a corporation. However, our certificate of incorporation provides that we will not be governed by Section 203 of the Delaware General Corporation Law until GE reduces its ownership interest in us to less than 15% of our outstanding common stock.

Under our Tax Matters Agreement with GE, if any person or group of persons other than GE or its affiliates gains the power to direct the management and policies of our company (other than through a sale of our stock by GE), we could become obligated immediately to pay to GE the total present value of all tax benefit payments due to GE under the agreement from the time of the change in control until the end of the 25-year term of the agreement. We currently estimate this amount to be \$423 million, but this estimate will vary based on a number of factors, including the value of our company and the time at which our obligation is accelerated. Similarly, if any person or group of persons other than us or our affiliates gains effective control of one of our subsidiaries (other than through a sale of our stock by GE), we could become obligated to pay to GE the total present value of all such payments due to GE allocable to that subsidiary, unless the subsidiary assumes the obligation to pay these future amounts under the Tax Matters Agreement and certain conditions are met. The acceleration of payments would be subject to the approval of certain state insurance regulators, and we are obligated to use our reasonable best efforts to see that these approvals are granted. This feature of the agreement could adversely affect a potential merger or sale of our company. It could also limit our flexibility to dispose of one or more of our subsidiaries, with adverse implications for any business strategy dependent on such dispositions. See "Arrangements Between GE and Our Company—Relationship with GE—Tax Matters Agreement."

Our certificate of incorporation and by-laws include provisions that may have anti-takeover effects and may delay, deter or prevent a takeover attempt that our stockholders might consider in their best interests. For example, our certificate of incorporation and by-laws will:

- permit our board of directors to issue one or more series of preferred stock;
- limit the ability of stockholders to remove directors;
- limit the ability of stockholders to fill vacancies on our board of directors;
- limit the ability of stockholders to call special meetings of stockholders and take action by written consent; and
- impose advance notice requirements for stockholder proposals and nominations of directors to be considered at stockholder meetings.

**Forward-Looking Statements**

Some of the statements under "Prospectus Summary," "Risk Factors," "Management's Discussion and Analysis of Financial Condition and Results of Operations," "Business" and elsewhere in this prospectus include forward-looking statements that are based upon our current expectations but are subject to uncertainty and changes in circumstances. These statements include forward-looking statements both with respect to us specifically and the insurance industry generally. Statements that include the words "expect," "intend," "plan," "believe," "project," "anticipate," "will," and similar statements of a future or forward-looking nature identify forward-looking statements.

These statements are based on management's current expectations and are subject to uncertainty and changes in circumstances. Actual results may differ materially from these expectations due to changes in global political, economic, business, competitive, market and regulatory factors, many of which are beyond our control. We believe that these factors include, but are not limited to, those described under "Risk Factors" and elsewhere in this prospectus. We undertake no obligation to publicly update or review any forward-looking statement, whether as a result of new information, future developments or otherwise.

**Use of Proceeds**

We will not receive any proceeds from the sale by the selling stockholder of Class A Common Stock in this offering or of the Equity Units or Series A Preferred Stock in the concurrent offerings.

**Dividend Policy**

We intend to pay quarterly cash dividends on our common stock at an initial rate of \$ \_\_\_\_\_ per share. The first such dividend will be declared in the third quarter of 2004 and paid in the fourth quarter. The declaration and payment of future dividends to holders of our common stock will be at the discretion of our board of directors and will

depend upon many factors, including our financial condition, earnings, capital requirements of our operating subsidiaries, legal requirements, regulatory constraints and other factors that the board of directors deems relevant.

We are a holding company and have no direct operations. As a result, our ability to pay dividends in the future will depend on receiving dividends from our subsidiaries. Our insurance subsidiaries are subject to the laws of the jurisdictions in which they are domiciled and licensed and consequently are limited in the amount of dividends that they can pay. See "Regulation."

### Capitalization

Set forth below is our capitalization as of December 31, 2003, on an historical and a pro forma basis, which reflects the adjustments described in more detail in the notes to the unaudited pro forma financial information under "Selected Historical and Pro Forma Financial Information." You should read this information in conjunction with those notes, as well as "Management's Discussion and Analysis of Financial Condition and Results of Operations" and our combined financial statements and the related notes included elsewhere in this prospectus.

	Historical	Pro forma adjustments-excluded assets and liabilities(1)	Pro forma adjustments-reinsurance transactions(2)	Pro forma adjustments-capital structure and other	Pro forma
Cash and cash equivalents	\$ 1,982	\$ (99)	\$ (385)	\$ 20	\$ 1,518
Borrowings and other obligations:					
Short-term borrowings	\$ 2,239	\$ (2,239)	\$ —	\$ 2,400(3)	\$ 2,400
Long-term borrowings	529(4)	—	—	—	529
Total borrowings	2,768	(2,239)	—	2,400	2,929
Contingent note payable to GEFAHI	—	—	—	550(5)	550
Non-recourse funding obligations	600(6)	—	—	—	600
Borrowings related to securitization entities	1,018(7)	—	—	—	1,018
% senior notes due 2009 underlying Equity Units	—	—	—	600(8)	600
Series A Preferred Stock, mandatorily redeemable, liquidation preference \$50 per share	—	—	—	100(9)	100
Total borrowings and other obligations	4,386	(2,239)	—	3,650	5,797
Stockholder's interest:					
Class A Common Stock, \$0.001 par value; billion shares authorized; million shares issued and outstanding					
Class B Common Stock, \$0.001 par value; billion shares authorized; million shares issued and outstanding(10)					
Additional paid-in capital	8,377	805	337	436(11)	9,955
Total paid-in capital	8,377	805	337	436	9,955
Accumulated nonowner changes in stockholder's interest	1,672	65	(712)	—	1,025
Retained earnings	5,751	(187)	(1,772)	(3,792)(12)	—
Total stockholder's interest	15,800	683	(2,147)	(3,356)	10,980
Total capitalization	\$ 20,186	\$ (1,556)	\$ (2,147)	\$ 294	\$ 16,777
Book value per share of common stock					

(1) Reflects adjustments to exclude amounts included in our historical combined financial statements relating to certain assets and liabilities that will not be transferred to us. For more information regarding the adjustments related to the excluded assets and liabilities, see notes (a), (b), (c) and (d) to the unaudited pro forma financial information under "Selected Historical and Pro Forma Financial Information."

(2) Reflects adjustments to record the effects of the reinsurance transactions we will enter into with UFLIC in connection with this offering as described under "Arrangements Between GE and Our

- (3) Reflects the \$2.4 billion Short-term Intercompany Note that we will issue to GEFAHI in connection with our corporate reorganization. We will repay this note with proceeds from the borrowings under a \$2.4 billion short-term credit facility that we will establish with a syndicate of banks concurrently with the completion of this offering. We intend to repay the borrowings under this short-term credit facility with proceeds from the issuance of approximately \$1.9 billion in senior notes (which would be included in long-term borrowings) and approximately \$500 million in commercial paper (which would be included in short-term borrowings), both of which we intend to complete shortly after the completion of this offering. For a description of the terms of this note, see "Description of Certain Indebtedness—Short-term Intercompany Note" and "Description of Certain Indebtedness—New Senior Notes."
- (4) Reflects the Yen Notes. We have entered into arrangements to swap our obligations under these notes to a U.S. dollar obligation with a principal amount of \$491 million and bearing interest at a rate of 4.84% per annum. For a description of the terms of these notes, see "Description of Certain Indebtedness—Yen Notes."
- (5) Reflects the \$550 million Contingent Note that we will issue to GEFAHI in connection with our corporate reorganization. This note is non-interest-bearing, matures on the first anniversary of the completion of this offering and will be repaid solely to the extent that statutory contingency reserves from our U.S. mortgage insurance business in excess of \$150 million are released and paid to us as a dividend. The release of these statutory reserves and payment of the dividend by our U.S. mortgage insurance business to us are subject to statutory limitations, regulatory approval and the absence of any impact on our financial ratings. If regulatory approval has been obtained by the first anniversary date, but our financial ratings have not been affirmed, the term of this note will be extended for a period up to twelve months to obtain affirmation of our financial ratings. Any portion of the Contingent Note that is not repaid by the first anniversary of the completion of this offering or by the extended term, if applicable, will be canceled. We will record any portion of the Contingent Note that is canceled as a capital contribution. For a description of the terms of this note, see "Description of Certain Indebtedness—Contingent Note."
- (6) Reflects non-recourse funding obligations. These obligations are represented by notes that bear a floating rate of interest and mature in 2033. The notes were issued by River Lake Insurance Company, a wholly-owned captive reinsurance subsidiary of our company, to fund additional statutory reserves required by Regulation XXX. Both principal and interest payments are guaranteed by a third-party insurance company. In the event that payment of principal or interest are not made by River Lake Insurance Company for any reason, the third-party insurance company is required to make these payments. The noteholders cannot require repayment from us or any of our subsidiaries, other than River Lake Insurance Company, the direct issuer of the notes.
- (7) Reflects borrowings associated with certain securitization entities that we were required to include in our financial statements upon adoption of FASB Interpretation 46, "Consolidation of Variable Interest Entities." Upon its adoption, GE Capital, of which we are an indirect subsidiary, was required to consolidate the funding conduit it sponsored. As a result, assets and liabilities of certain previously off-balance sheet securitization entities were required to be included in our financial statements because the funding conduit no longer qualified as a third party. For more information regarding these arrangements, see "Management's Discussion and Analysis of Financial Condition and Results of Operations—Off-balance Sheet Transactions."

47

- 
- (8) Represents notes forming part of the Equity Units. For a description of the terms of our Equity Units, see "Description of Equity Units." GEFAHI is offering the Equity Units for sale in a concurrent offering.
  - (9) For a description of the terms of our Series A Preferred Stock, see "Description of Capital Stock—Preferred Stock—Series A Preferred Stock." GEFAHI is offering the Series A Preferred Stock for sale in a concurrent offering.
  - (10) Shares of Class B Common Stock convert automatically into shares of Class A Common Stock when they are held by any person other than GE or an affiliate of GE or when GE no longer beneficially owns at least 10% of our outstanding common stock.
  - (11) Reflects adjustments to our paid-in capital, as described in notes (h), (i)(2), (j), (k) and (l) to the unaudited pro forma financial information under "Selected Historical and Pro Forma Financial Information."
  - (12) Reflects adjustments to our retained earnings, as described in notes (i)(2), (i)(3), (i)(4), (i)(5), (j) and (l) to the unaudited pro forma financial information under "Selected Historical and Pro Forma Financial Information."

The foregoing table:

- excludes        million shares of Class A Common Stock issuable upon the exercise of unvested stock appreciation rights to be granted on the date of this prospectus, at an exercise price equal to the initial public offering price;
- excludes        million shares of Class A Common Stock issuable upon the exercise of unvested employee stock options to be granted on the date of this prospectus, at an exercise price equal to the initial public offering price;
- excludes        million shares of Class A Common Stock issuable upon the exercise of unvested employee stock options that will be issued on the date of this prospectus in exchange for unvested GE stock options held by our employees, at a weighted average exercise price of \$            per share, and        million shares of Class A Common Stock issuable upon the exercise of vested employee stock options that will be issued on the date of this prospectus in exchange for vested GE stock options held by our Chairman, President and Chief Executive Officer, at a weighted average exercise price of \$            per share;
- excludes        million shares of Class A Common Stock issuable upon the vesting of restricted stock units and stock appreciation rights that will be issued on the date of this prospectus in exchange for unvested GE restricted stock units and stock appreciation rights;
- excludes        million shares of Class A Common Stock available for future issuance under our Genworth Omnibus Incentive Plan; and
- excludes up to        million shares of Class A Common Stock that we will be required to issue to settle the purchase contracts included in our Equity Units.

Our total pro forma capitalization also does not include our liability to GE under the Tax Matters Agreement. As a consequence of our separation from GE, and the election we will make with GE to treat that separation as an asset sale under section 338 of the Internal Revenue Code, we expect to realize future tax savings that we otherwise would not realize. We are obligated, pursuant to the Tax Matters Agreement with GE, to pay to GE over a period from 15 to 25 years 80% of the projected future tax savings, subject to a maximum amount. Based on a number of assumptions, we estimate these projected payments to have a present value of \$423 million. See "Arrangements Between GE and Our Company—Relationship with GE—Tax Matters Agreement" and note (k) to our pro forma financial statements under "Selected Historical and Pro Forma Financial Information."

48

### Selected Historical and Pro Forma Financial Information

The following table sets forth selected historical and pro forma financial information. The selected historical financial information as of December 31, 2003 and 2002, and for the years ended December 31, 2003, 2002 and 2001 has been derived from our combined financial statements, which have been audited by KPMG LLP and are included elsewhere in this prospectus. The selected pro forma financial information as of and for the year ended December 31, 2003 is unaudited and has been derived from our combined financial statements, which are included elsewhere in this prospectus. You should read this information in conjunction with the information under "Management's Discussion and Analysis of Financial Condition and Results of Operations," our combined financial statements, the related notes and the accompanying independent auditors' report (which refers to a change in accounting for variable interest entities in 2003, goodwill and other intangibles in 2002, and derivative instruments and hedging activities in 2001), included elsewhere in this prospectus.

Prior to the completion of this offering, we will acquire substantially all of the assets and liabilities of GEFAHI. We also will acquire certain other insurance businesses currently owned by other GE subsidiaries but managed by members of the Genworth management team. These businesses include international mortgage insurance, European payment protection insurance, a Bermuda reinsurer and mortgage contract underwriting.

In consideration for the assets that we will acquire and the liabilities that we will assume in connection with our corporate reorganization, we will issue to GEFAHI the following securities:

- million shares of our Class B Common Stock;
- \$600 million of our Equity Units;
- \$100 million of our Series A Preferred Stock;
- \$2.4 billion Short-term Intercompany Note; and
- \$550 million Contingent Note.

The liabilities we will assume from GEFAHI include the Yen Notes.

We have prepared our combined financial statements as if Genworth had been in existence throughout all relevant periods. Our historical combined financial information and statements include all businesses that were owned by GEFAHI, including those that will not be transferred to us, as well as the other insurance businesses that we will acquire from other GE subsidiaries, each in connection with our corporate reorganization.

Prior to the completion of this offering, we will enter into several significant reinsurance transactions with UFLIC, an indirect, wholly-owned subsidiary of GE. As part of these transactions, we will cede to UFLIC, effective as of January 1, 2004, policy obligations under our structured settlement contracts, which had reserves of \$12.0 billion, and our variable annuity contracts, which had general account reserves of \$2.8 billion and separate account reserves of \$7.9 billion. These contracts represent substantially all of our contracts that were in force as of December 31, 2003 for these products. In addition, effective as of January 1, 2004, we will cede to UFLIC policy obligations under a block of long-term care insurance policies that we reinsured from Travelers, which had reserves of \$1.5 billion. In the aggregate, these blocks of business do not meet our target return thresholds, and although we remain liable under these contracts and policies as the ceding insurer, the reinsurance transactions will have the effect of transferring the financial results of the reinsured blocks to UFLIC. In addition, as part of the reinsurance transactions, UFLIC will cede to us substantially all of its in-force blocks of Medicare supplement insurance. As of December 31, 2003, these blocks of business had aggregate reserves of \$19 million.

49

---

The unaudited pro forma information set forth below reflects our historical combined financial information, as adjusted to give effect to the transactions described below as if each had occurred as of January 1, 2003, in the case of earnings information, and December 31, 2003, in the case of financial position information. The following transactions are reflected in the pro forma financial information:

- the removal of certain businesses of GEFAHI that will not be transferred to us in connection with our corporate reorganization, including the Partnership Marketing Group business, an institutional asset management business and several other small businesses;
- the removal of certain liabilities that we will not assume, including an aggregate of \$1.691 billion of commercial paper issued by GEFAHI and short-term borrowings from GE Capital of \$548 million that were outstanding as of December 31, 2003;
- the reinsurance transactions with UFLIC, including a capital contribution of \$1.836 billion that we will make to UFLIC;
- the equity and debt securities that we will issue to GEFAHI in exchange for the assets that we will acquire and the liabilities that we will assume in connection with our corporate reorganization; and
- the other adjustments described below in the notes to the unaudited pro forma financial information.

The unaudited pro forma information below is based upon available information and assumptions that we believe are reasonable. The unaudited pro forma financial information is for illustrative and informational purposes only and is not intended to represent or be indicative of what our financial condition or results of operations would have been had the transactions described above occurred on the dates indicated. The unaudited pro forma information also should not be considered representative of our future financial condition or results of operations.

In addition to the pro forma adjustments to our historical combined financial statements, various other factors will have an effect on our financial condition and results of operations after the completion of this offering, including those discussed under "Risk Factors" and "Management's Discussion and Analysis of Financial Condition and Results of Operations."

For information with respect to certain items that are not reflected in the pro forma financial information, see note (o) below.

50

---

(Dollar amounts in millions, per share amounts in dollars)	Historical					Pro forma
	Years ended December 31,					Year ended December 31,
	2003(1)	2002	2001	2000(2)	1999	2003
<b>Combined Statement of Earnings Information</b>						
Revenues:						
Premiums	\$ 6,703	\$ 6,107	\$ 6,012	\$ 5,233	\$ 4,534	\$ 6,252
Net investment income	4,015	3,979	3,895	3,678	3,440	2,928
Net realized investment gains	10	204	201	262	280	38
Policy fees and other income	943	939	993	1,053	751	557
<b>Total revenues</b>	<b>11,671</b>	<b>11,229</b>	<b>11,101</b>	<b>10,226</b>	<b>9,005</b>	<b>9,775</b>
Benefits and expenses:						
Benefits and other changes in policy reserves	5,232	4,640	4,474	3,586	3,286	4,191
Interest credited	1,624	1,645	1,620	1,456	1,290	1,358
Underwriting, acquisition, and insurance expenses, net of deferrals	1,942	1,808	1,823	1,813	1,626	1,614
Amortization of deferred acquisition costs and intangibles(3)	1,351	1,221	1,237	1,394	1,136	1,144
Interest expense	140	124	126	126	78	138
<b>Total benefits and expenses</b>	<b>10,289</b>	<b>9,438</b>	<b>9,280</b>	<b>8,375</b>	<b>7,416</b>	<b>8,445</b>
Earnings from continuing operations before income taxes	1,382	1,791	1,821	1,851	1,589	1,330
Provision for income taxes	413	411	590	576	455	395
<b>Net earnings from continuing operations</b>	<b>\$ 969</b>	<b>\$ 1,380</b>	<b>\$ 1,231</b>	<b>\$ 1,275</b>	<b>\$ 1,134</b>	<b>\$ 935</b>
Pro forma earnings per share:						
Basic						
Diluted						
Pro forma shares outstanding:						
Basic						
Diluted						
<b>Selected Segment Information</b>						
Total revenues:						
Protection	\$ 6,153	\$ 5,605	\$ 5,443	\$ 4,917		\$ 5,839
Retirement Income and Investments	3,781	3,756	3,721	3,137		2,707
Mortgage Insurance	982	946	965	895		982
Affinity(4)	566	588	687	817		—
Corporate and Other	189	334	285	460		247
<b>Total</b>	<b>\$ 11,671</b>	<b>\$ 11,229</b>	<b>\$ 11,101</b>	<b>\$ 10,226</b>		<b>\$ 9,775</b>
Net earnings (loss) from continuing operations:						
Protection	\$ 487	\$ 554	\$ 538	\$ 492		\$ 481
Retirement Income and Investments	151	186	215	250		93
Mortgage Insurance	369	451	428	414		369
Affinity(4)	16	(3)	24	(13)		—
Corporate and Other	(54)	192	26	132		(8)
<b>Total</b>	<b>\$ 969</b>	<b>\$ 1,380</b>	<b>\$ 1,231</b>	<b>\$ 1,275</b>		<b>\$ 935</b>

Historical					Pro forma
December 31,					December 31,
2003(1)	2002	2001	2000(2)	1999	2003

**Combined Statement of  
Financial Position Information**

Total investments	\$ 78,693	\$ 72,080	\$ 62,977	\$ 54,978	\$ 48,341	\$ 59,772
All other assets	24,738	45,277	41,021	44,598	27,758	38,095
<b>Total assets</b>	<b>\$ 103,431</b>	<b>\$ 117,357</b>	<b>\$ 103,998</b>	<b>\$ 99,576</b>	<b>\$ 76,099</b>	<b>\$ 97,867</b>
Policyholder liabilities	\$ 66,545	\$ 63,195	\$ 55,900	\$ 48,291	\$ 45,042	\$ 66,046
Non-recourse funding obligation(5)	600	—	—	—	—	600
Short-term borrowings	2,239	1,850	1,752	2,258	990	2,400
Long-term borrowings	529	472	622	175	175	529
All other liabilities	17,718	35,088	31,559	35,865	18,646	17,312
<b>Total liabilities</b>	<b>\$ 87,631</b>	<b>\$ 100,605</b>	<b>\$ 89,833</b>	<b>\$ 86,589</b>	<b>\$ 64,853</b>	<b>\$ 86,887</b>
Accumulated nonowner changes in stockholder's interest	\$ 1,672	\$ 835	\$ (664)	\$ (424)	\$ (862)	\$ 1,025
Total stockholder's interest	15,800	16,752	14,165	12,987	11,246	10,980
<b>U.S. Statutory Information</b>						
Statutory capital and surplus	7,021	7,207	7,940	7,119	6,140	
Asset valuation reserve	413	390	477	497	500	
<b>Other Information</b>						
Ratio of earnings to fixed charges(6)	1.74	1.94	1.99	2.10	2.12	1.83

- (1) On August 29, 2003, we sold our Japanese life insurance and domestic auto and homeowners' insurance businesses for aggregate cash proceeds of approximately \$2.1 billion, consisting of \$1.6 billion paid to us and \$0.5 billion paid to other GE affiliates, plus pre-closing dividends. See note 4 to our combined financial statements, included elsewhere in this prospectus.
- (2) During 2000, we consummated three significant business combinations:
- In July 2000, we reinsured 90% of Travelers' long-term care insurance portfolio and acquired certain related assets for \$411 million;
  - In April 2000, we acquired 97% of Phoenix American Life Insurance Company for \$284 million; and
  - Effective March 2000, we acquired the insurance policies and related assets of Toho Mutual Life Insurance Company. Our Japanese life insurance business assumed \$21.6 billion of policyholder liabilities and \$0.3 billion of accounts payable and accrued expenses and acquired \$20.3 billion in cash, investments and other tangible assets through this transaction. We sold this business on August 29, 2003, and its results have been presented as discontinued operations.
- (3) As of January 1, 2002, we adopted Statement of Financial Accounting Standard 142, *Goodwill and Other Intangible Assets*, and, in accordance with its provisions, discontinued amortization of goodwill. Goodwill amortization was \$84 million, \$70 million and \$53 million for the years ended December 31, 2001, 2000 and 1999, respectively, excluding goodwill amortization included in discontinued operations.
- (4) Reflects the results of the businesses that are owned by GEFAHI but which will not be transferred to us in connection with our corporate reorganization, including (a) the Partnership Marketing Group business, (b) an institutional asset management business, and (c) several other small businesses that are not part of our core ongoing business. See "Management's Discussion and Analysis of Financial Condition and Results of Operations—Overview—Our historical and pro forma financial information."
- (5) Reflects non-recourse funding obligations. These obligations are represented by notes that bear a floating rate of interest and mature in 2033. The notes were issued by a wholly-owned captive reinsurance subsidiary of our company, to fund certain statutory reserves. Both principal and interest payments are guaranteed by a third-party insurance company.
- (6) For purposes of determining the historical ratio of earnings to fixed charges, "earnings" consist of earnings from continuing operations before taxes and accounting changes plus fixed charges from continuing and discontinued operations. "Fixed charges" consist of (a) interest expense on short-term and long-term borrowings, (b) interest credited to policyholders on annuities and financial products and (c) the portion of operating leases that are representative of the interest factor. For purposes of determining the ratio of pro forma earnings to pro forma fixed charges, pro forma earnings consist of pro forma earnings from continuing operations before taxes plus pro forma fixed charges from continuing operations and fixed charges from discontinued operations. Pro forma fixed charges consist of (a) pro forma interest expense on short-term and long-term borrowings, including dividends on Series A Preferred Stock, (b) pro forma interest credited to policyholders on annuities and financial products, and (c) the portion of operating leases that are representative of the interest factor.



	Historical	Pro forma adjustments—excluded assets and liabilities	Pro forma adjustments—reinsurance transactions	Pro forma adjustments—capital structure and other	Pro forma(o)
<b>(Dollar amounts in millions)</b>					
<b>Revenues:</b>					
Premiums	\$ 6,703	\$ (244)(a)	\$ (207)(f)	—	\$ 6,252
Net investment income	4,015	(62)(a) (8)(c)	(921)(f) (96) (g)	—	2,928
Net realized investment gains	10	6 (e)	24 (f) (2) (g)	—	38
Policy fees and other income	943	(260)(a)	(126)(f)	—	557
<b>Total revenues</b>	<b>11,671</b>	<b>(568)</b>	<b>(1,328)</b>	<b>—</b>	<b>9,775</b>
<b>Benefits and expenses:</b>					
Benefits and other changes in policy reserves	5,232	(196)(a)	(845)(f)	—	4,191
Interest credited	1,624	—	(266)(f)	—	1,358
Underwriting, acquisition, and insurance expenses, net of deferrals	1,942	(239)(a) (4)(c)	(85)(f)	—	1,614
Amortization of deferred acquisition costs and intangibles	1,351	(110)(a)	(97)(f)	—	1,144
Interest expense	140	—	—	(83)(b) 24 (i) 23 (k) 34 (m)	138
<b>Total benefits and expenses</b>	<b>10,289</b>	<b>(549)</b>	<b>(1,293)</b>	<b>(2)</b>	<b>8,445</b>
Earnings from continuing operations before income taxes	1,382	(19)	(35)	2	1,330
Provision for income taxes	413	(5)(a) (1)(c) 2 (e)	24 (f) (39) (g)	1(n)	395
<b>Net earnings from continuing operations</b>	<b>\$ 969</b>	<b>\$ (15)</b>	<b>\$ (20)</b>	<b>\$ 1</b>	<b>\$ 935</b>
<b>Pro forma earnings per share: (p)</b>					
Basic					
Diluted					
<b>Pro forma number of shares outstanding: (p)</b>					
Basic					
Diluted					

### Pro Forma Financial Information

December 31, 2003

	Historical	Pro forma adjustments—excluded assets and liabilities	Pro forma adjustments—reinsurance transactions	Pro forma adjustments—capital structure and other	Pro forma(o)
<b>(Dollar amounts in millions)</b>					
<b>Assets</b>					
<b>Investments:</b>					
Fixed maturities	\$ 65,485	\$ (1,310)(a)	\$ (15,504)(f)	—	\$ 47,442
Equity securities	600	(3)(d) (73)(a)	(1,226)(g) (68)(f)	—	428
Mortgage and other loans	6,114	(31)(d) 82 (c)	(334)(f) (184)(g)	—	5,678
Policy loans	1,105	(9)(a)	—	—	1,096
Short-term investments	531	(15)(a)	—	—	516

Restricted investments held by securitization entities	1,069	—	—	—	1,069
Other invested assets	3,789	(13)(a)	(52)(f)	—	3,543
		(120)(e)			
		(61)(d)			
<b>Total investments</b>	<b>78,693</b>	<b>(1,553)</b>	<b>(17,368)</b>	<b>—</b>	<b>59,772</b>
Cash and cash equivalents	1,982	(93)(a)	(385)(g)	20(h)	1,518
Accrued investment income	1,247	(6)(e)	(224)(f)	—	977
		(22)(a)	(17)(g)		
Deferred acquisition costs	5,788	(7)(d)	(864)(f)	—	4,726
		(198)(a)			
Intangible assets	1,346	(191)(a)	(282)(f)	—	872
		(1)(d)			
Goodwill	1,728	(284)(a)	—	—	1,444
Reinsurance recoverable	2,334	(23)(a)	16,345 (f)	—	18,656
Other assets	2,069	(84)(a)	(21)(f)	—	1,658
		(6)(e)			
		(300)(d)			
Separate account assets	8,244	—	—	—	8,244
<b>Total assets</b>	<b>\$ 103,431</b>	<b>\$ (2,768)</b>	<b>\$ (2,816)</b>	<b>\$ 20</b>	<b>\$ 97,867</b>
<b>Liabilities and Stockholder's Interest</b>					
<b>Liabilities:</b>					
Future annuity and contract benefits	\$ 59,257	\$ (349)(a)	\$ 13 (f)	\$ —	\$ 58,921
Liability for policy and contract claims	3,207	(144)(a)	6 (f)	—	3,069
Unearned premiums	3,616	(19)(a)	—	—	3,597
Other policyholder liabilities	465	(6)(a)	—	—	459
Other liabilities	7,051	(231)(a)	(31)(f)	57 (i)	7,262
		(176)(b)		2,400 (i)	
		(2)(c)		550 (i)	
		(379)(d)		(2,400)(m)	
				423 (k)	
Non-recourse funding obligations	600	—	—	—	600
Short-term borrowings	2,239	(2,239)(b)	—	2,400 (m)	2,400
Long-term borrowings	529	—	—	—	529
% senior notes due 2009 underlying Equity Units	—	—	—	600 (i)	600
Series A Preferred Stock, mandatorily redeemable(q)	—	—	—	100 (i)	100
Deferred income taxes	1,405	39 (a)	(657)(f)	(18)(j)	88
		81 (b)		(736)(k)	
		(26)(d)			
Borrowings related to securitization entities	1,018	—	—	—	1,018
Separate account liabilities	8,244	—	—	—	8,244
<b>Total liabilities</b>	<b>87,631</b>	<b>(3,451)</b>	<b>(669)</b>	<b>3,376</b>	<b>86,887</b>
<b>Stockholder's interest:</b>					
Common stock(r)	—	—	—	—	—
Additional paid-in capital	8,377	(1,386)(a)	401 (f)	(57) (i)	9,955
		2,235 (b)	(64)(g)	45 (j)	
		(46)(c)		313 (k)	
		2 (d)		115 (l)	
				20 (h)	
Accumulated non owner changes in equity					
Net unrealized investment gains	1,518	(34)(a)	(690)(f)	—	800
			6 (g)		
Derivatives qualifying as hedges	(5)	99 (b)	(25)(f)	—	66
			(3)(g)		
Foreign currency translation adjustments	159	—	—	—	159
<b>Total accumulated non owner changes in equity</b>	<b>1,672</b>	<b>65</b>	<b>(712)</b>	<b>—</b>	<b>1,025</b>
Retained earnings	5,751	(185)(a)	(1,772)(g)	(3,650)(i)	—
		(2)(c)		(27)(j)	
				(115)(l)	
<b>Total stockholder's interest</b>	<b>15,800</b>	<b>683</b>	<b>(2,147)</b>	<b>(3,356)</b>	<b>10,980</b>
<b>Total liabilities and stockholder's interest</b>	<b>\$ 103,431</b>	<b>\$ (2,768)</b>	<b>\$ (2,816)</b>	<b>\$ 20</b>	<b>\$ 97,867</b>

### Notes to unaudited pro forma financial information

- (a) Reflects adjustments to exclude amounts included in our historical combined financial statements relating to the results of operations, assets and liabilities of businesses reported in the Affinity segment, which will not be transferred to us. For a description of our Affinity segment, see "Management's Discussion and Analysis of Financial

Condition and Results of Operations—Overview—Our historical and pro forma financial information." The exclusion of these businesses from our historical combined financial statements will be accounted for as a dividend to our stockholder prior to the completion of this offering.

- (b) Reflects adjustments to exclude the liabilities for commercial paper issued by GEFAHI of \$1,691 million, short-term borrowings from GE Capital of \$548 million, derivative contracts hedging the commercial paper cash flows of \$176 million, deferred tax liability of \$(65) million relating to those derivative contracts, non-owner changes in equity of \$99 million, net of deferred tax, reflecting the effective portion of hedges that have not yet been reclassified to earnings, and interest expense, adjusted for qualified hedge effects, of \$83 million incurred during 2003 on our commercial paper and other short-term borrowings. The commercial paper, short-term borrowing and derivative contracts liabilities will not be transferred to us and their exclusion from our historical combined financial statements will be accounted for as a capital contribution from our stockholder prior to the completion of this offering.
- (c) Reflects adjustments to exclude amounts included in our historical combined financial statements relating to the results of operations, assets and liabilities of certain investment partnerships that will not be transferred to us. The exclusion of these partnerships from our historical combined financial statements will be accounted for as a dividend to our stockholder prior to the completion of this offering.
- (d) Reflects adjustments to exclude payables to, receivables from, and intercompany investments in other GE companies included in our historical combined financial statements, net of deferred taxes, that will not be transferred to us. The exclusion from our historical combined financial statements of the net liability for these intercompany balances will be accounted for as a capital contribution from our stockholder prior to the completion of this offering.
- (e) Reflects adjustments to exclude from results of operations net realized investment losses, and related income tax benefit, arising from sales of Affinity segment assets. In our historical combined financial statements net realized investment losses are reflected in the Corporate and Other segment.
- (f) Reflects adjustments to record the effects of the reinsurance transactions we will enter into with UFLIC in connection with this offering as described under "Arrangements Between GE and Our Company—Reinsurance Transactions." As part of these transactions, we will cede to UFLIC, effective as of January 1, 2004, all of our in-force structured settlement contracts, substantially all of our in-force variable annuity contracts, and a block of long-term care insurance policies that we reinsured from Travelers in 2000. The unaudited pro forma information gives effect to the reinsurance transactions as if each had occurred as of January 1, 2003, in the case of earnings information, and December 31, 2003, in the case of financial position information. Accordingly, our unaudited pro forma earnings information excludes the effects of all reinsured contracts that were issued before January 1, 2003. We will continue to sell variable annuities and structured settlements after completion of the reinsurance transactions and will retain that business for our own account, subject to third-party reinsurance transactions in the ordinary course of business. As a result, our unaudited pro forma combined statements of earnings reflect premiums and fees from these products issued after January 1, 2003, even though these variable annuities and structured settlements will be included in the blocks of policies reinsured with UFLIC. Our net loss for 2003 from variable annuities and structured settlements issued after January 1, 2003 was \$5 million. We

55

---

did not issue any new policies in 2003 in the block of long-term care insurance policies that we will cede to UFLIC and we will not issue any in the future. As a result, our pro forma combined statements of earnings exclude the impact of that entire block of policies.

In connection with the reinsurance transactions, we will record a reinsurance recoverable asset of \$16,345 million, including \$12,056 million related to structured settlement contracts, \$2,815 million related to variable annuity contracts and \$1,468 million related to long-term care insurance policies.

When we enter into the reinsurance transactions we will transfer investment assets to UFLIC in exchange for the reinsurance recoverable asset from UFLIC and consequently we will not earn investment income on the investment assets transferred. The actual investment assets that will be transferred in the reinsurance transactions have been determined on an asset-by-asset basis and the pro forma financial position adjustments have been determined based upon the actual assets that will be transferred. Because a significant portion of the assets to be transferred were not owned for the entire period, the pro forma earnings adjustments were based upon a proportional allocation of investment income from the investment assets historically identified as supporting the blocks of business reinsured. Under our existing investment management strategies, multiple product lines with similar characteristics can be supported by a single portfolio of investment securities, known as "multiple product portfolios." Where the reinsurance transactions with UFLIC relate to products supported by multiple product portfolios, the pro forma net investment income and net realized investment gains (losses) attributable to the reinsured liabilities were determined using an allocation approach, applying the ratio of reinsured liabilities to the total liabilities supported by the multiple product portfolio to the portfolio's net investment income and net realized investment gains (losses), respectively.

Under the reinsurance transactions, we will receive an expense allowance to reimburse us for costs we incur to service the reinsured blocks. Actual costs and expense allowance amounts will be determined by expense studies to be conducted periodically. The pro forma adjustments have been prepared assuming that actual costs incurred during the pro forma periods, as determined under our historical cost structure and allocation methods, were reimbursed by an expense allowance.

The reinsurance transactions will be completed and accounted for at book value. We will report the reinsurance transactions on our tax returns at fair value as determined for tax purposes, giving rise to a net reduction in current and deferred income tax liabilities. The differences between the book value of assets and liabilities transferred and the ceding commission received, and their respective income tax effects, are recorded as a net capital contribution from our stockholder. The actual income tax effects will vary depending upon, among other factors, the fair value of the investment assets at the time of the reinsurance transaction.

The pro forma information does not represent the results we would have achieved had the reinsurance transactions we will enter into with UFLIC been consummated at the beginning of the periods presented, and the information presented may not be a reliable indicator of our future results.

- (g) Concurrently with the reinsurance transactions described in note (f), we will contribute \$1.836 billion of capital to UFLIC, which primarily represents excess statutory capital in our insurance subsidiaries, after giving effect to the reinsurance transactions. We have reflected this capital contribution to UFLIC in our unaudited pro forma financial position information as a distribution to our stockholder and a decrease in fixed maturities, mortgage loans and cash, with related adjustments to accrued investment income, deferred income taxes and other associated items. The actual investment assets that will be contributed to UFLIC have been determined on an asset-by-asset basis and the pro forma financial position adjustments have been determined based upon the actual assets that will be transferred. Because a significant portion of the assets to be

56

---

transferred were not owned for the entire period, the pro forma adjustments to reduce net investment income and net realized investment gains related to the transferred assets were based upon a proportional allocation of investment income from the investment assets historically identified as representing surplus of the subsidiaries providing the assets to be contributed to UFLIC.

- (h) Reflects an adjustment to record a capital contribution of \$20 million received by one of our combined subsidiaries from GE in March 2004. We will record this capital contribution in our historical combined financial statements in the first quarter of 2004.

- (i) Reflects adjustments to record the equity and debt securities we will issue to GEFAHI in connection with our corporate reorganization, as well as related interest expense:
1. We will issue million shares of our Class B Common Stock to GEFAHI. Shares of Class B Common Stock convert automatically into shares of Class A Common Stock when they are held by any person other than GE or an affiliate of GE, or when GE no longer beneficially owns at least 10% of our outstanding common stock. For a description of the terms of our common stock, see "Description of Capital Stock—Common Stock." GEFAHI is offering shares of our Class A Common Stock for sale in this offering.
  2. We will issue \$600 million of our Equity Units to GEFAHI. We will pay holders of Equity Units quarterly contract adjustment payments on each purchase contract forming a part of the Equity Units at a rate of % per year of the stated amount of \$25 per Equity Unit. The estimated present value of the contract adjustment payments on the stock purchase contracts is \$57 million, which has been recorded in other liabilities with a decrease in additional paid-in capital. When we make contract adjustment payments, they will be charged to other liabilities and we will accrue interest expense on the unpaid balance at the rate of % per year. Our pro forma adjustments have been prepared based upon an assumed contract adjustment payment rate of % per year and a weighted average senior note interest rate of % per year. For a description of the terms of our Equity Units, see "Description of Equity Units." GEFAHI is offering the Equity Units for sale in a concurrent offering.
  3. We will issue \$100 million of our Series A Preferred Stock, which is mandatorily redeemable, to GEFAHI. For a description of the terms of our Series A Preferred Stock, see "Description of Capital Stock—Preferred Stock—Series A Preferred Stock." The dividends on our Series A Preferred Stock will be accounted for as interest expense in our financial statements. Our pro forma interest expense adjustment has been prepared based upon an assumed dividend rate of % per year. GEFAHI is offering shares of our Series A Preferred Stock for sale in a concurrent offering.
  4. We will issue the \$2.4 billion Short-term Intercompany Note to GEFAHI. We intend to repay this note with proceeds from the borrowings described in note (m) below. Because this note will be outstanding only between the date of this prospectus and the completion of this offering, interest expense on this note will not be material and has not been included in our pro forma adjustments. For a description of the terms of the Short-term Intercompany Note, see "Description of Certain Indebtedness—Short-term Intercompany Note."
  5. We will issue the \$550 million Contingent Note to GEFAHI. This note is non-interest-bearing, matures on the first anniversary of the completion of this offering and will be repaid solely to the extent that statutory contingency reserves from our U.S. mortgage insurance business in excess of \$150 million are released and paid to us as a dividend. The release of these statutory reserves and payment of the dividend by our U.S. mortgage insurance business to us are subject to statutory limitations, regulatory approval and the absence of any impact on our financial ratings. If regulatory approval has been obtained by the first anniversary date, but

57

---

our financial ratings have not been affirmed, the term of this note will be extended for a period up to twelve months to obtain affirmation of our financial ratings. Any portion of the Contingent Note that is not repaid by the first anniversary of the completion of this offering or by the extended term, if applicable, will be canceled. We will record any portion of the Contingent Note that is canceled as a capital contribution. For a description of the terms of the Contingent Note, see "Description of Certain Indebtedness—Contingent Note."

- (j) Reflects adjustments to retained earnings for the first-year cost of our grant of stock options and stock appreciation rights to our management and employees and cost relating to the conversion of certain existing stock-based compensation awards upon the completion of this offering, net of a related reduction of deferred income tax liability. On the date of this prospectus, we will establish equity compensation plans pursuant to which we will (1) issue stock options to purchase million shares of our Class A Common Stock with an exercise price equal to the initial offering price, (2) issue stock appreciation rights on million shares of our Class A Common Stock with an exercise price equal to the initial public offering price, and (3) convert all the unvested stock options, restricted stock units and stock appreciation rights that GE previously granted to our employees and the vested GE stock options held by our Chairman, President and Chief Executive Officer into stock options, restricted stock units and stock appreciation rights issued by our company. We recognize compensation expense for share-based compensation awards based upon the fair value of the stock options in accordance with Statement of Financial Accounting Standards 123, *Accounting for Stock-Based Compensation* ("SFAS 123"). Under the measurement principles of SFAS 123, we estimate that we will recognize compensation expense related to (1) the new issuances of stock options and stock appreciation rights of \$39 million, \$39 million, \$17 million, \$10 million and \$4 million for the five twelve-month periods following the completion of this offering, and (2) the conversions of existing awards of \$6 million and \$1 million for the two twelve-month periods following the completion of this offering. Our estimate of fair value was made using the Black-Scholes model based upon the assumed initial offering price of \$ per share, volatility of %, risk free interest rate of % per year, and average expected life of years. For a description of our stock-based compensation plans see "Management—GE 1990 Long-Term Incentive Plan," "—Omnibus Incentive Plan" and "—Incentive Compensation Program."
- (k) Reflects an adjustment to record certain effects of our Tax Matters Agreement with GE. Under the Tax Matters Agreement, GE will make, and we will join GE in making, tax elections under section 338 of the Internal Revenue Code that will treat (for tax purposes) many of the companies in our group as having sold all their assets in fully taxable sales. Under the Tax Matters Agreement, GE will control the making of these elections and related determinations. GE will be responsible for all current taxes resulting from the making of these tax elections. As a result of the section 338 elections, we will become entitled to certain tax benefits that are expected to be realized by us in the future in the ordinary course of our business and that otherwise would not have been available to us. These benefits are generally attributable to increased tax deductions for amortization of intangibles and to increased tax basis in non-amortizable investment assets. Under the Tax Matters Agreement, we will be required to make payments to GE, equal to 80% of the amount of tax we are projected to save for each tax period as the result of these increased tax benefits, subject to a maximum amount. We estimate that these payments will aggregate approximately \$640 million, comprising \$589 million resulting from temporary differences between financial reporting and tax basis of our assets and liabilities arising from the elections (and recorded as a reduction in net deferred tax liabilities) and \$51 million resulting from future interest expense deductions arising under the Tax Matters Agreement. The estimated present value of the projected payments is approximately \$423 million. We have recorded this amount as our estimate of our liability to GE and have increased paid-in capital by the difference (\$313 million) between that amount and the total \$736 million reduction in net deferred income tax liabilities as

58

---

a result of the Section 338 elections. The \$736 million includes both GE's 80% share of the benefit, or \$589 million, and our 20% share of the benefit, or \$147 million. We will record interest expense as our obligation under the Tax Matters Agreement accretes over time. Our pro forma adjustment for interest expense related to the Tax Matters Agreement has been prepared based upon an assumed interest rate of % per year.

These amounts are estimates and will change as the result of a number of factors, including a final determination of the value of our company and its individual assets. However, we have agreed with GE that, except for specified contingent benefits and excluding interest on payments we defer, our total payments to GE under the Tax Matters Agreement will not exceed \$640 million. If and to the extent our Section 338 tax benefits exceed the amount of tax benefits we currently project, our additional

paid-in capital would increase. See "Arrangements Between GE and Our Company—Tax Matters Agreement" for further description of these tax matters.

- (l) Reflects an adjustment to record additional effects of our Tax Matters Agreement with GE. As described in note (k), GE generally will pay all current taxes arising from the section 338 elections. Certain taxes other than section 338 taxes will be incurred by our subsidiaries in the transaction. Under the Tax Matters Agreement, these taxes also will be paid by GE. These taxes have been estimated at \$25 million, using assumptions as to, among other things, the value of our company and its individual assets. We will record these non-recurring taxes as a current tax expense when incurred, and will record GE's payment of the taxes on our behalf as an equity contribution. Because these taxes are non-recurring, we have not reflected this adjustment in the unaudited pro forma earnings information. See "Arrangements Between GE and Our Company—Relationship with GE—Tax Matters Agreement" for further description of these tax matters.
- (m) Reflects an adjustment to record borrowings and related interest expense pursuant to a \$2.4 billion short-term credit facility that we will establish with a syndicate of banks concurrently with the completion of this offering. We will borrow the entire amount available under that facility upon the completion of this offering to repay the Short-term Intercompany Note. For a description of the terms of this facility, see "Description of Certain Indebtedness—Short-term Credit Facility." Our pro forma adjustment for interest expense has been prepared based upon an assumed interest rate of % per year. We intend to repay the borrowings under this short-term credit facility with proceeds from the issuance of approximately \$1.9 billion in senior notes (which would be included in long-term borrowings) and approximately \$500 million in commercial paper (which would be included in short-term borrowings), both of which we intend to complete shortly after the completion of this offering. If these notes and commercial paper had been issued as of January 1, 2003, our pro forma interest expense for the year ended December 31, 2003 would have increased by \$ million, assuming a weighted average interest rate of % per year on the notes and % per year on the commercial paper.
- (n) Reflects an adjustment to record the tax impact on other pro forma earnings adjustments at a rate of 35%.
- (o) We have not reflected any adjustments in our unaudited pro forma combined financial information for the following:
  - 1. Prior to the completion of this offering, we will enter into a number of arrangements with GE governing our separation from GE and a variety of transition matters. These include (i) arrangements with respect to certain transition services, management consulting services, administration services for a pool of guaranteed investment contracts, or GICs, and institutional asset management services, pursuant to which we will provide services to GE, and (ii) arrangements with respect to certain transition services and asset management services, pursuant to which GE will provide services to us. Except as described in the notes above, we have not reflected any adjustments for the estimated effects of these arrangements, which are

described under "Management's Discussion and Analysis of Financial Condition and Results of Operations—Overview—Separation from GE and related costs."

- 2. We have not reflected any adjustments to exclude net investment income or net realized investment gains related to the \$2,930 million dividend paid by GEFAHI in December 2003. Approximately \$1,630 million of the dividend was funded from proceeds received on the sale of our Japanese life insurance and domestic auto and homeowners' insurance businesses, after deducting expenses and settlements, and the remaining \$1,300 million of the dividend was funded from a portion of dividends received from our insurance subsidiaries. If the amount of the dividend funded from dividends received from our insurance subsidiaries had been invested in short-term investments during the year ended December 31, 2003, it would have earned net investment income of approximately \$30 million, based on our average short-term investment yield during 2003.
- 3. Our payment protection insurance business in the U.K. includes a portfolio of insurance bonds and structured settlements issued to contractholders in the U.K. that had reserves of approximately \$160 million as of December 31, 2003 and net earnings of less than \$1 million for the year ended December 31, 2003. We and GE have agreed, subject to receipt of required regulatory and court approvals in the U.K., to transfer ownership of the bond and structured settlement portfolio to GE as soon as practicable following the transfer of the U.K. insurance businesses to us. Pending completion of the transfer of the bond and structured settlement portfolio, we have agreed to use commercially reasonable efforts to enter into indemnity reinsurance arrangements with GE to transfer the economic benefits, obligations and risks of the bond and structured settlement portfolio to GE promptly following completion of the offering. We have not reflected any adjustments for the reinsurance transaction and subsequent portfolio transfer. The reinsurance and portfolio transfer transactions will have no material effect on our net earnings or total stockholder's interest. When completed, the reinsurance transaction will reduce cash and investments and increase reinsurance recoverable by the amount of the reserves. The subsequent portfolio transfer will remove the reinsurance recoverable and related reserves from our combined statement of financial position. See "Arrangements Between GE and Our Company—European Payment Protection Insurance Business Arrangements."
- 4. We expect to incur aggregate incremental pre-tax expenses of approximately \$35 million in each of 2004 and 2005 for marketing, advertising and legal entity transition expenses, reflecting primarily the additional costs of establishing our new brand throughout our business, including with consumers and sales intermediaries. We have not reflected any adjustments for the estimated effect of these expenses because the expenses are nonrecurring and we did not incur any material expenses relating to advertising in the periods presented. We will charge these expenses to income in the periods incurred.
- 5. We have not reflected any adjustments for the transition to our benefit plans under the employee matters agreement we will enter into with GE prior to the completion of this offering. Effective as of the date that GE ceases to own more than 50% of our outstanding common stock, our applicable U.S. employees will cease to participate in the GE plans and will participate in employee benefit plans established and maintained by us. For at least the one year period following the date that GE ceases to own more than 50% of our outstanding common stock, we will establish plans that will provide our employees with benefits that are at least substantially comparable in the aggregate to the value of those benefits provided by the GE plans. See "Arrangements Between GE and Our Company—Employee Matters Agreement" for further description of these matters.

- (p) Basic and diluted earnings per share and the weighted average shares outstanding for the pro forma earnings per share calculation included in our unaudited pro forma combined earnings information are calculated as set forth below:

	December 31, 2003	
	Basic	Diluted
Pro forma net earnings	—	—
Common stock	—	—

Restricted stock units(1)		
Stock options and stock appreciation rights(1)		
Purchase contracts(1)		
Pro forma shares outstanding		
Pro forma earnings per share		

(1) Pro forma shares outstanding used in our calculation of pro forma diluted earnings per share result from million shares of Class A Common Stock available under restricted stock units, million shares of Class A Common Stock available under stock options and stock appreciation rights and million shares of Class A Common Stock available under purchase contracts forming part of our Equity Units, based on the treasury stock method.

(q) Reflects liquidation preference and mandatory redemption value and of \$50 per share.

(r) Reflects par value of \$0.001 per share, billion shares of Class A Common Stock authorized, million shares of Class A Common Stock issued and outstanding. Also reflects par value of \$0.001 per share, billion shares of Class B Common Stock authorized, million shares of Class B Common Stock issued and outstanding.

61

## Management's Discussion and Analysis of Financial Condition and Results of Operations

*The following discussion and analysis of our financial condition and results of operations should be read in conjunction with our audited and unaudited historical combined financial statements and related notes as well as our unaudited pro forma combined financial statements included elsewhere in this prospectus. The discussion below contains forward-looking statements that are based upon our current expectations and are subject to uncertainty and changes in circumstances. Actual results may differ materially from these expectations due to changes in global political, economic, business, competitive, market and regulatory factors, many of which are beyond our control. See "Forward-Looking Statements."*

### Overview

#### *Our business*

We are a leading insurance company in the U.S., with an expanding international presence. We have three operating segments—Protection, Retirement Income and Investments, and Mortgage Insurance.

- **Protection.** We offer U.S. customers life insurance, long-term care insurance and, for companies with fewer than 1,000 employees, group life and health insurance. In Europe, we offer payment protection insurance, which helps consumers meet their payment obligations in the event of illness, involuntary unemployment, disability or death. For the year ended December 31, 2003, our Protection segment had pro forma segment net earnings of \$481 million.
- **Retirement Income and Investments.** We offer U.S. customers fixed, variable and income annuities, variable life insurance, asset management and specialized products, including guaranteed investment contracts, funding agreements and structured settlements. For the year ended December 31, 2003, our Retirement Income and Investments segment had pro forma segment net earnings of \$93 million.
- **Mortgage Insurance.** We offer mortgage insurance products in the U.S., Canada, Australia, and Europe that facilitate homeownership by enabling borrowers to buy homes with low-down-payment mortgages. For the year ended December 31, 2003, our Mortgage Insurance segment had pro forma segment net earnings of \$369 million.

We also have a Corporate and Other segment, which consists primarily of net realized investment gains (losses), interest and other financing expenses that are incurred at our holding company level, unallocated corporate income and expenses (including amounts accrued in settlement of class action lawsuits), and the results of several small, non-core businesses that are managed outside our operating segments. For the year ended December 31, 2003, our Corporate and Other segment had a pro forma segment net loss of \$8 million.

#### *Our corporate reorganization*

We were incorporated in Delaware on October 23, 2003 in preparation for our corporate reorganization. Prior to the completion of this offering, we will acquire substantially all of the assets and liabilities of GEFAHI. GEFAHI is an indirect subsidiary of GE and a holding company for a group of companies that provide life insurance, long-term care insurance, group life and health insurance, annuities and other investment products and U.S. mortgage insurance. We also will acquire certain other insurance businesses currently owned by other GE subsidiaries but managed by members of the Genworth management team. These businesses include international mortgage insurance, European payment protection insurance, a Bermuda reinsurer and mortgage contract underwriting. In consideration for the assets that we will acquire and the liabilities that we will assume in connection with our corporate reorganization, we will issue to GEFAHI million shares of our Class B Common

62

Stock, \$600 million of our Equity Units, \$100 million of our Series A Preferred Stock, the \$2.4 billion Short-term Intercompany Note and the \$550 million Contingent Note. See "Corporate Reorganization."

#### *Our historical and pro forma financial information*

The historical combined financial information presented in this prospectus has been derived from our audited and unaudited combined financial statements, which have been prepared as if Genworth had been in existence throughout all relevant periods. Our historical combined financial information and statements include all businesses that were owned by GEFAHI, including those that will not be transferred to us in connection with our corporate reorganization, as well as the other insurance businesses that we will acquire from other GE subsidiaries in connection with our corporate reorganization. In addition to the three operating segments that we will have after the completion of this

offering and our Corporate and Other segment, our historical combined financial statements also include the results of (1) the Partnership Marketing Group business, which offers life and health insurance, auto club memberships and other financial products and services directly to consumers through affinity marketing arrangements with a variety of organizations, (2) an institutional asset management business owned by GEFAHI, and (3) several other small businesses owned by GEFAHI that are not part of our core ongoing business.

The Partnership Marketing Group historically included UFLIC, a subsidiary that offered life and health insurance products through affinity marketing arrangements. Prior to the completion of this offering, GEFAHI's Partnership Marketing Group will transfer UFLIC to General Electric Capital Services, Inc., a direct wholly-owned subsidiary of GE. We will not acquire the Partnership Marketing Group business, the institutional asset management business or these other small businesses from GEFAHI, and their results (including UFLIC's historical results) are presented as a separate operating segment under the caption "Affinity."

Our historical combined financial statements also include our Japanese life insurance and domestic auto and homeowners' insurance businesses, which we sold on August 29, 2003, and which are presented in our historical combined financial statements as discontinued operations.

The unaudited pro forma information presented in this prospectus reflects our historical combined financial information, as adjusted to give effect to the transactions described under "Selected Historical and Pro Forma Financial Information" as if each had occurred as of January 1, 2003, in the case of earnings information, and December 31, 2003, in the case of financial position information.

### ***Revenues and expenses***

Our revenues consist primarily of the following:

- ***Protection.*** The revenues in our Protection segment consist primarily of:
  - net premiums earned on individual life, individual long-term care, group life and health and payment protection insurance policies;
  - net investment income on the separate investment portfolio held by our European payment protection insurance business or allocated to this segment's other lines of business; and
  - policy fees and other income, including fees for mortality and surrender charges primarily from universal life insurance policies, and other administrative charges.
- ***Retirement Income and Investments.*** The revenues in our Retirement Income and Investments segment consist primarily of:
  - net premiums earned on income annuities and structured settlements with life contingencies and variable life insurance;

63

- 
- net investment income allocated to this segment; and
  - policy fees and other income, including surrender charges, mortality and expense charges, investment management fees and commissions.
- ***Mortgage Insurance.*** The revenues in our Mortgage Insurance segment consist primarily of:
    - net premiums earned on mortgage insurance policies;
    - net investment income on the segment's separate investment portfolio; and
    - policy fees and other income, including fees from contract underwriting services.
  - ***Corporate and Other.*** The revenues in our Corporate and Other segment consist primarily of:
    - net premiums, policy fees and other income from the insurance businesses in this segment;
    - unallocated net investment income; and
    - net realized investment gains (losses).

We allocate net investment income from our Corporate and Other segment to our Protection (except European payment protection insurance) and Retirement Income and Investments segments using an approach based principally upon the investment portfolio established to support each of those segments' products and targeted capital levels. We do not allocate net investment income from our Corporate and Other segment to our Mortgage Insurance segment or to our European payment protection insurance product within the Protection segment because they have their own separate investment portfolios, and the net investment income from those portfolios is reflected in the Mortgage Insurance and Protection segment results. In our historical combined financial statements, we allocated net investment income to our Affinity segment in the same manner that we allocated these items to our Protection and Retirement Income and Investments segments.

All net realized investment gains (losses) are reflected in the Corporate and Other segment and are not reflected in the results of any of our other segments.

Our expenses consist primarily of the following:

- benefits provided to policyholders and contractholders and changes in reserves;
- interest credited on general account balances;

- underwriting, acquisition and insurance expenses, including commissions, marketing expenses, policy and contract servicing costs, overhead and other general expenses that are not capitalized (shown net of deferrals);
- amortization of deferred policy acquisition costs and other intangible assets;
- interest and other financing expenses; and
- income taxes.

We allocate corporate expenses to each of our operating segments based on our relative equity investment in that segment.

### ***Business trends and conditions***

In recent years, our business has been, and we expect will continue to be, influenced by a number of macroeconomic, industry-wide and product-specific trends and conditions.

64

### ***Market and economic environment***

***Macroeconomic conditions.*** During the last several years, the sales and financial results of our business were adversely affected by very slow economic growth, low interest rates and depressed equity markets. During 2001 and 2002, U.S. real GDP growth declined to 0.5% and 2.2%, respectively, after averaging compound annual growth of 4.1% from 1995 to 2000. Interest rates, as measured by the 10-year U.S. Treasury, reached historical 45-year lows in June 2003, declining from 6.8% in January 2000 to 3.1% in June 2003. In addition, the U.S. equity markets were marked by a severe downturn, with the S&P 500 Index declining by 51% from 1,553 at its peak in March 2000 to 768 in October 2002. These economic conditions were exacerbated by several high-profile corporate scandals and bankruptcies. During this period, our business also faced a challenging credit cycle, with the Moody's Default Index reaching 2.05% in 2002 after averaging 0.45% from 1999 to 2001. Similar economic trends and challenges prevailed outside the U.S. as well during this period.

***Aging U.S. population with growing retirement income needs.*** According to the U.S. Social Security Administration, from 1945 to 2001, U.S. life expectancy at birth increased from 62.9 years to 73.8 years for men and from 68.4 years to 79.4 years for women, respectively, and life expectancy is expected to increase further. In addition, increasing numbers of baby boomers are approaching retirement age. The U.S. Census Bureau projects that the percentage of the U.S. population aged 55 or older will increase from approximately 21% (61 million) in 2002 to more than 29% (95 million) in 2020. These increases in life expectancy and the average age of the U.S. population heighten the risk that individuals will outlive their retirement savings. In addition, approximately \$4.4 trillion of invested financial assets (25% of all U.S. invested financial assets) are held by people within 10 years of retirement and are expected to be converted to income as those people retire, according to a survey conducted by SRI Consulting Business Intelligence in 2002. We believe these trends will lead to growing demand for retirement income and investment products, such as our annuities and other investment products, that help consumers accumulate assets and provide reliable retirement income.

***Growing lifestyle protection gap.*** The aging U.S. population and a number of other factors are creating a significant lifestyle protection gap for a growing number of individuals. This gap is the result of individuals not having sufficient financial resources, including insurance coverage, to ensure that their future assets and income will be adequate to support their desired future lifestyle. Other factors contributing to this gap include declining individual savings rates, rising healthcare and nursing home costs, and a shifting of the burden for funding protection needs from governments and employers to individuals. Recent reductions in employer-paid benefits by many companies, coupled with uncertainty over the future of government benefit programs underscore the potential for long-term benefit reductions from these traditional sources and the potential need for individuals to identify alternative sources of these benefits. At the same time, according to the U.S. Bureau of Economic Analysis, personal savings rates decreased from 10.9% in 1982 to 3.7% in 2002. Consumers are exposed to the rising costs of healthcare and nursing care during their retirement years, and some experts believe that many consumers are underinsured with respect to their protection needs. We expect these trends to result in increased demand for our life, long-term care and small group life and health insurance products.

***Increasing opportunities for mortgage insurance in the U.S. and other countries.*** We believe a number of factors have contributed and will contribute to the growth of mortgage insurance in the U.S., Canada and Australia, where we have significant mortgage insurance operations. These factors include increasing homeownership levels (spurred in part by government housing policies that favor homeownership); expansion of low-down-payment mortgage loan offerings; legislative and regulatory policies that provide capital incentives for lenders to transfer the risks of low-down-payment mortgages to mortgage insurers; and expansion of secondary mortgage markets that require credit enhancements, such as mortgage insurance. We believe a number of these factors also are becoming evident in some

65

European and Asian markets, where lenders increasingly are using mortgage insurance to manage the risks of their loan portfolios and to expand low-down-payment lending.

### ***General conditions and trends affecting our businesses***

***Interest rate fluctuations.*** Fluctuations in market interest rates have a significant effect on our sales of insurance and investment products and our margins on these products. In our Protection and Retirement Income and Investments segments, declining interest rates in a low-interest-rate environment have reduced the spreads between the amounts we have paid or credited to policyholders and contractholders and the returns we earned on the investments that supported our obligations under these products. In response to the recent decline in market interest rates, we have reduced the guaranteed minimum crediting rates we offer on newly issued fixed annuity contracts in order to mitigate the adverse impact of declining interest rates on our spreads and profitability on these contracts. However, this reduction in minimum guaranteed crediting rates has had an adverse effect on our sales of these products because some of our competitors have continued to offer higher minimum rates. For example, our fixed annuity deposits declined by 60% from \$2,663 million for the year ended December 31, 2002 to \$1,069 million for the year ended December 31, 2003. In addition, as a result of a lower interest rate environment, our income annuity premiums and deposits declined by 27% from \$979 million for the year ended December 31, 2002 to \$717 million for the year ended December 31, 2003. Declining interest rates also have resulted in increased persistency in our fixed annuity and universal life insurance products because investors generally have been unable to shift assets into higher-yielding investments. Our net earnings from spread-based products in our Retirement Income and Investments segment declined by 11% from \$166 million for the year ended December 31, 2002 to \$138 million for the year ended December 31, 2003 as a result of reduced spreads, offset in part by increased persistency. Interest rates have stabilized in 2003, and we expect the yield on our investment portfolio also will stabilize, with the potential for increases in a rising interest rate environment.

In our Mortgage Insurance segment, declining interest rates in the U.S. have generated significant mortgage refinancing activity, which, in turn, has led to lower persistency in our U.S. mortgage insurance business, as well as increases in the volume of new mortgage insurance written and increased contract underwriting expenses. For example, our policy cancellation rates increased from 43% for the year ended December 31, 2002 to 54% for the year ended December 31, 2003. In addition, our U.S. new insurance written increased by 44% from \$46.9 billion for the year ended December 31, 2002 to \$67.4 billion for the year ended December 31, 2003. We expect that increasing



mortgage interest rates will result in increased persistency, but also will reduce the volume of mortgage originations and of new mortgage insurance written.

*Volatile equity markets.* The equity markets in the U.S. and the other markets in which we invest have experienced extreme volatility and significant downturns in recent years, which has affected our financial condition and results of operations in two principal ways. First, we believe equity market downturns and volatility generally have discouraged potential new purchasers of our products from purchasing separate account products, such as variable annuities, that have returns linked to the performance of the equity markets and have caused our existing customers to withdraw cash values or reduce investments in those products. For example, our variable annuity deposits declined by 28% from \$2,309 million for the year ended December 31, 2001 to \$1,667 million for the year ended December 31, 2002. However, with the improved equity markets in 2003, variable annuity deposits increased by 26% to \$2,102 million for the year ended December 31, 2003. Second, lower equity markets have had an adverse effect on our fee income tied to the value of the equity investments in our separate accounts and have resulted in accelerated amortization of DAC and PVFP, reflecting lower expected profits from our variable products. After the completion of this offering, the potential adverse impact of volatile equity markets will be significantly reduced as a result of our reinsurance arrangements with UFLIC, pursuant to which we will reinsure, effective as of January 1, 2004,

66

---

substantially all of our in-force blocks of variable annuities. We will retain variable annuities sold after January 1, 2004 for our own account, subject to third-party reinsurance transactions in the ordinary course of business, and therefore we will bear the risk of any adverse impact of future equity market fluctuations on those annuities.

*Credit default risk.* As a result of the recent economic downturn and some high-profile corporate bankruptcies and scandals, the number of companies defaulting on their debt obligations increased dramatically in 2001 and 2002. These defaults and other declines in the value of some of our investments have resulted in impairment charges in recent years. Charges associated with impairments of investments were \$224 million, \$343 million and \$289 million for the years ended December 31, 2003, 2002 and 2001, respectively. We expect that continuing economic and market improvements will lead to fewer credit defaults and lower impairment charges in our results of operations.

*Investment gains.* As part of GE, the yield on our investment portfolio has been affected by the practice in recent years of realizing investment gains through the sale of appreciated securities and other assets during a period of historically low interest rates. This strategy was pursued to offset impairments and losses in our investment portfolio, fund consolidations and restructurings in our business and provide current income. Our gross realized gains were \$473 million, \$790 million and \$814 million for the years ended December 31, 2003, 2002 and 2001, respectively. These gross realized gains, net of gross realized losses, including charges from impairments of investments and realized losses from portfolio restructuring, have resulted in net realized investment gains of \$10 million, \$204 million and \$201 million for the years ended December 31, 2003, 2002 and 2001, respectively. This strategy has had an adverse impact on the yield on our investment portfolio and our net investment income as we typically sold higher-yielding securities and reinvested the proceeds in lower-yielding securities during periods of declining or low interest rates. The impact was most significant in the Retirement Income and Investments segment, which has a higher percentage of our fixed maturities allocated to it than our other segments. As we transition to being an independent public company, our investment strategy will be to optimize investment income without relying on realized investment gains. As a result of this strategy, we expect the yield on our investment portfolio to stabilize, with the potential for increases in a rising interest rate environment. We also will seek to improve our investment yield by continuously evaluating our asset class mix and pursuing additional investment classes.

*Globalization.* Historically, we have derived a majority of our revenues and profits from our operations in the U.S. However, in recent years, our international business has grown and has had an increasing impact on our financial condition and results of operations. For the years ended December 31, 2003, 2002 and 2001, respectively, 18%, 14% and 14% of our revenues, and 26%, 12% and 11% of our net earnings from continuing operations were generated by our international operations. These increases were largely due to growth in our international mortgage insurance business, and we expect that we will derive an increasing portion of our total revenues and profits from outside the U.S. as our international mortgage insurance business continues to grow. Our European payment protection insurance business also derives revenues in the countries where it offers its products. We are exposed to the impact of fluctuations in exchange rates as we translate the operating results of our foreign operations into our combined financial statements. We currently do not hedge this exposure, and as a result, period-to-period comparability of our results of operations is affected by fluctuations in exchange rates. Our net earnings for the year ended December 31, 2003 were favorably impacted by approximately \$25 million from changes in foreign exchange rates. Our four principal foreign currencies are the Canadian dollar, the Australian dollar, the U.K. pound and the euro.

*Ongoing operating cost reductions and efficiencies.* Our underwriting, acquisition, and insurance expenses, net of deferrals, have decreased to 16.6% of our revenues in 2003 from 18.1% in 1999. We will continually focus on reducing our cost base while maintaining strong service levels for our

67

---

customers. We expect to accomplish this in each of our operating units through a wide range of cost management disciplines, including consolidating operations, using low-cost operating locations, reducing supplier costs, leveraging Six Sigma and other process improvement efforts, forming dedicated teams to identify opportunities for cost reductions and investing in new technology, particularly for web-based, digital end-to-end processes.

#### *Developments affecting our product lines*

*Developments in life insurance.* Regulation XXX, which was adopted by nearly all states as of January 1, 2001, requires insurers to establish additional statutory reserves for term and universal life insurance policies with long-term premium guarantees. In response to this regulation, we have increased term and universal life insurance statutory reserves and changed our premium rates for term and universal life insurance products, which have contributed to lower term life insurance sales in 2003. We also have been able to improve our new business returns on equity by implementing pricing, reinsurance and capital management actions in response to Regulation XXX. See "Risk Factors—Regulation XXX may have an adverse effect on our financial condition and results of operations by requiring us to increase our statutory reserves for term life and universal life insurance or incur higher operating costs."

*Developments in long-term care insurance.* During 2001, 2002 and 2003, the level of annualized first-year premiums in our long-term care insurance business has remained relatively constant. This sales trend is generally consistent with the overall industry sales trend, according to reports published by LIMRA International. In addition, we have been experiencing lower lapse rates than we originally anticipated on long-term care insurance policies that we issued prior to the mid-1990s. This has adversely affected our overall claims experience on those policies. In the third quarter of 2003, we started selling our newest long-term care insurance products in selected markets. These products were priced to reflect new features and benefits, trends in lapse rates, interest rates, morbidity and adverse claims experience in certain higher risk policyholder classes. Our pricing strategy for these products has contributed to significantly lower sales in recent periods. We are continuing to seek regulatory approvals to begin selling these products in additional markets, and we expect that their introduction into those markets initially may have a further adverse impact on our sales in the near term. We believe, however, that over time sales of the industry and of our company will increase. We also believe that our pricing strategy is appropriate relative to the underlying risk exposure of these products and that it will ultimately lead to increased profitability and net earnings.

*Developments in payment protection insurance.* The margins of our payment protection business in the U.K. have decreased in recent years as a result of increased pricing pressure and greater competition from captive insurance arrangements by distributors that provide payment protection insurance directly to their customers. Consistent with our focus on disciplined growth and returns on capital, we are continuing to pursue arrangements that will enable us to achieve our target returns while strengthening our client relationships. In the last several years, our payment protection insurance business has expanded as a result of our strategy to enter additional markets in Continental Europe and to develop new relationships with distributors in those markets. However, we did not renew arrangements with our largest distributor of payment protection insurance (as measured by gross written premiums), a large U.K. bank that accounted for approximately 25% of the gross written premiums in our payment protection insurance

business during the year ended December 31, 2003. Although we expect our revenue to decline significantly over the next few years as existing policies from these less profitable arrangements begin to run off, we believe this will have a favorable effect on our results over the long term as capital is released and redeployed into markets with potential for higher returns.

*Developments in retirement income and investments.* The results of our Retirement Income and Investments segment are affected primarily by interest rate fluctuations and volatile equity markets, as discussed above under "—Overview—Business trends and conditions—General conditions and trends affecting our businesses." In addition, our competitive position within many of our distribution channels depends significantly upon product features, including our crediting rates on spread-based products relative to our competitors, minimum guaranteed rates, surrender charge periods and agent commissions. We continually evaluate our competitive position based upon each of those features, and we make adjustments as appropriate to meet our target return thresholds. In late 2002 and throughout 2003, in response to declining interest rates, we reduced minimum guaranteed rates on many of our spread-based products. These reductions have had an adverse effect on our competitive position because some of our competitors have retained higher minimum guaranteed rates. In addition, some competitors have offered fixed annuity products with higher commissions and shorter surrender charge periods, and this also has had an adverse effect on our competitive position. These factors contributed to a decline in our sales of fixed annuities in 2003 and our market position in this product. Our new deposits in fixed deferred annuities decreased 60% from \$2,663 million for the year ended December 31, 2002 to \$1,069 million for the year ended December 31, 2003. Moreover, as a result of the rating agency downgrades in connection with our initial public offering and separation from GE, some of our GIC customers have limited their purchases of new GIC contracts from us to comply with their internal credit policies regarding counterparty credit risk at our new rating levels. These actions may adversely affect the future profitability and growth of our GIC product lines.

*Developments in mortgage insurance.* The net earnings of our U.S. mortgage insurance business have been adversely affected by our ceding a larger portion of our gross premiums to captive mortgage reinsurance subsidiaries established by many of the major mortgage lenders with which we do business. Most large mortgage lenders have developed reinsurance operations that obtain net premium cessions from mortgage insurers of 25% to 40%. In order to increase our return on capital, we announced in August 2003 that, effective January 1, 2004, we generally would not renew, on their existing terms, our existing excess-of-loss risk sharing arrangements with net premium cessions in excess of 25%. We expect that these actions will result in a significant reduction in business from these lenders. We recently decided that we may, in selected cases, enter into captive reinsurance arrangements that involve premium cessions in excess of 25% in situations where the terms and conditions, including the level of reinsurance coverage afforded, will enable us to achieve our target returns on capital. In addition, we believe U.S. mortgage insurance growth has been adversely affected by the increased use of simultaneous second mortgages as an alternative to loans requiring private mortgage insurance. The adverse impact of ceding to captive reinsurers and the growth of simultaneous seconds has been offset by the positive impact in recent years of historically low loss ratios due to significant refinancing activity, home price appreciation and low levels of defaults. As a result of this refinancing activity, as of December 31, 2003, approximately 79% of our risk in force had not yet reached its anticipated highest claim frequency years, which is generally between the third and seventh year of the loan. We expect our loss experience on these loans will increase as policies continue to age.

#### *Separation from GE and related financial arrangements*

GE historically has provided a variety of products and services to us, and we have provided various products and services to GE. Prior to the completion of this offering, we will enter into a transition services agreement and various other agreements with GE that, together with a number of existing agreements that will remain in effect following this offering, will govern the relationship between GE and us after this offering. These arrangements are discussed below and described more fully under "Arrangements Between GE and Our Company" and note 18 to our combined financial statements included elsewhere in this prospectus.

#### *Services received from GE*

*Support services and corporate overhead.* GE historically has provided a variety of support services for our businesses, including:

- customer service, transaction processing and a variety of functional support services provided by GE Capital International Services, or GECIS;
- employee benefit processing and payroll administration, including relocation, travel, credit card processing and related services;
- employee training programs, including access to GE training courses;
- insurance coverage under the GE insurance program;
- information systems, network and related services;
- leases for vehicles, equipment and facilities; and
- other financial advisory services such as tax consulting, capital markets services, research and development activities, and use of trademarks and licenses.

We have reimbursed GE for the costs of providing these services to us. We paid GE a total of \$87 million, \$74 million and \$52 million for these services for the years ended December 31, 2003, 2002 and 2001, respectively.

In addition, GE historically has allocated to us a share of its corporate overhead expenses for certain services provided to us, which are not specifically billed to us, including public relations, investor relations, treasury, and internal audit services. Our total expense for this allocation was \$50 million, \$49 million and \$43 million for the years ended December 31, 2003, 2002 and 2001, respectively. We have not reimbursed these amounts to GE, and have recorded them as a capital contribution in each year. After the completion of this offering, GE will no longer allocate any of its corporate expenses to us.

GE will continue to provide us with many of the corporate services described above on a transitional basis after the completion of this offering, and we will arrange to procure other services pursuant to arrangements with third parties or through our own employees. In the case of support services provided by GECIS, we will continue to receive these services pursuant to agreements that will be amended prior to the completion of this offering. For a description of our historical, continuing and new arrangements with GE, see "Arrangements Between GE and Our Company—Relationship with GE." In the aggregate, we expect that our total costs for procuring corporate services that previously had been provided by GE will not materially exceed the amounts we historically have paid to GE for these services, including GE's allocation to us for its corporate overhead. However, we do expect to incur incremental advertising, marketing and legal entity transition expenses to establish a new brand identity, and we also expect to incur compensation expense with respect to the establishment of our new equity plans. In addition, we have obtained direct access to a variety of third-party products and services, including technology licenses, as a result of GE's relationships with those third parties. After our separation from GE, we will negotiate our own arrangements with third-party providers for these products and services, but we do not believe this will result in materially increased costs in the aggregate.

*Investment management services.* We have received and will continue to receive investment management services from GE Asset Management Incorporated, or GEAM, a subsidiary of GE, pursuant to agreements that will, with limited exceptions, be amended prior to the completion of this offering. We also will enter into new agreements with GE Asset Management Limited, or GEAML, an affiliate of GEAM, for investment management services in the U.K. Pursuant to the existing, amended and new agreements, the

the value of the assets under management. This percentage is established annually by agreement between GEAM or GEAML and us and is intended to reflect the cost to GEAM or GEAML of providing its services and, for the agreements with GEAML, a premium of 5%. For the years ended December 31, 2003, 2002 and 2001, our aggregate costs for investment management and related administration services provided by GEAM were approximately \$61 million, \$39 million and \$2 million, respectively. We expect our investment management expenses to increase marginally following this offering as a result of the expenses we will incur related to our new investment department, including the transfer of some employees from GEAM to us to manage certain asset classes that GEAM previously managed. See "Arrangements Between GE and Our Company—Relationship with GE—Investment Agreements."

*Reinsurance transactions.* We have entered into reinsurance transactions with affiliates of GE, principally Employers Reassurance Company and ERC Life Reinsurance Corporation, which we refer to collectively as ERC, under which we have reinsured some of the risks of our insurance policies on terms comparable to those we could obtain from third parties. We have paid premiums to these affiliates of \$56 million, \$60 million and \$58 million for the years ended December 31, 2003, 2002 and 2001, respectively. In addition, in 2002 one of our subsidiaries entered into a life reinsurance agreement with an affiliated company, GE Pensions Limited, to reinsure 95% of gross written premiums received under certain life policies. We have paid premiums to this affiliate of \$100 million and \$94 million for the years ended December 31, 2003 and 2002. See "Business—Reinsurance." The existing reinsurance agreements with GE will remain in force and continue in accordance with their terms after the completion of this offering.

*Employee benefit plans.* Historically, we have reimbursed GE for benefits it has provided to our employees under various employee benefit plans, including GE's retirement plan, retiree health and life insurance benefit plans, defined contribution savings plan and life and health insurance benefits through the GE benefit program. We incurred expenses associated with these plans of \$106 million, \$112 million and \$103 million for the years ended December 31, 2003, 2002 and 2001, respectively. GE will continue to provide these benefits to our employees for so long as GE owns more than 50% of our outstanding common stock. See "Arrangements Between GE and our Company—Employee Matters Agreement" and note 12 to our combined financial statements included elsewhere in this prospectus. In addition to these expenses for which we have reimbursed GE, we have incurred expenses of \$9 million, \$6 million and \$4 million for certain GE stock option and restricted stock unit grants for the years ended December 31, 2003, 2002 and 2001, respectively. As in the case of the allocation of corporate overhead, we have not reimbursed these amounts with respect to stock options and restricted stock units to GE, and have recorded them as a capital contribution in each year. After the completion of this offering, we will establish our own equity compensation plans. See "—Equity plans" below.

*Credit arrangements.* Historically, we have had access to funding provided by GE in the form of credit lines, revolving credit agreements and other borrowing arrangements. See "Arrangements between GE and our Company—Historical Related-Party Transactions—Credit arrangements and other amounts due from or owed to GE." In connection with our initial public offering and separation from GE, we intend to enter into new credit arrangements with unaffiliated third-parties. See "—Liquidity and Capital Resources" below.

#### *Services provided to GE*

We have provided various products and services to GE on terms comparable to those we provide to third-parties. After the completion of this offering, we expect to continue to provide many of these products and services to GE. See "Arrangements Between GE and Our Company—Historical Related-Party Transactions—Products and services provided to GE."

In addition, prior to the completion of this offering, we will enter into a series of arrangements with GE pursuant to which we will provide a variety of additional services to GE, including the arrangements discussed below. The following describes the principal impact of those service arrangements on our results of operations:

- *Transition services relating to GE and GEFAHI businesses not acquired by us.* We will provide services to certain of GE's insurance businesses that we will not acquire. These services will include finance, information systems, network services and legal and regulatory support. We will continue to provide these services for a minimum of two years and a maximum of three years in most cases. For the two years after the completion of this offering, GE generally may not terminate any of the services we provide. GE has agreed to pay us an aggregate of \$40 million in eight equal quarterly installments during the first two years after this offering for our provision of the transition services to GE. The charges for the transition services generally are intended to allow the providing company to fully recover the allocated direct costs of providing the services, plus all out-of-pocket costs and expenses, generally without profit. See "Arrangements Between GE and Our Company—Relationship with GE—Transition Services Agreement."
- *Management consulting services.* We will provide management consulting services to GE for a period of five years. These services will include delivering training, providing consultation and strategic advice with respect to actuarial, regulatory and other emerging issues, planning and participating in meetings with rating agencies and regulators, participating in government relations activities and various other activities. In consideration for these services, GE will pay us a fee of \$1 million per month during the first four years following the offering and \$500,000 per month during the fifth year. GE cannot terminate this arrangement before the expiration of the five-year term. See "Arrangements Between GE and Our Company—Relationship with GE—Transition Services Agreement."
- *GIC investment administration services.* We will enter into agreements with affiliates of GE to manage a pool of municipal guaranteed investment contracts issued by GE affiliates. Pursuant to these agreements, we will originate GIC liabilities and advise the affiliates regarding the investment, administration and management of their assets that support those liabilities. Under two of those agreements, we will receive an administration fee of 0.165% per annum of the maximum program size for those affiliates, which was an aggregate of \$15.0 billion as of December 31, 2003. The agreements also provide for termination fees in the event of early termination at the option of either affiliate. Under a third agreement with another affiliate, we will receive a management fee of 0.10% per annum of the book value of the investment contracts or similar securities issued by this affiliate after January 1, 2003, which was \$912 million as of December 31, 2003. The fee we will receive on the contracts issued by that affiliate before January 1, 2003 will be based upon a pricing arrangement that will vary depending upon the maturities of those contracts and that affiliate's cost of capital. The book value of the contracts issued before January 1, 2003 was \$2,008 million as of December 31, 2003 and is expected to generate a weighted average fee of approximately 0.35% in 2004. We also will receive reimbursement of our operating expenses under each of the agreements. The initial term of each of the three agreements will expire December 31, 2006, and unless terminated at the option of either party, each agreement automatically will renew on January 1 of each year for successive terms of one year. See "Arrangements Between GE and Our Company—Relationship with GE—Liability and Portfolio Management Agreements."
- *Institutional asset management services.* Prior to the completion of this offering, we offered a broad range of institutional asset management services to third parties. GEAM provided the portfolio management services for this business, and we provided marketing, sales and support services. We will not acquire the institutional asset management services business from GEFAHI,

---

but we will continue to provide services to GEAM and GEFAHI related to this asset management business, including client introduction services, asset retention services and compliance support. GEFAHI will pay us a fee of up to \$10 million per year for four years to provide these services. The fee will be determined based upon the level of third-party assets under management managed by GEAM over the four-year term. The agreement may not be terminated by GEAM or GEFAHI, except for non-performance or in the event that we commence a similar institutional asset management business. See "Arrangements Between GE and Our Company—Relationship with GE—Asset Management Services Agreement."

#### *Additional arrangements with GE*

In addition to the arrangements described above pursuant to which we and GE will provide services to each other, we also will enter into the following additional arrangements with GE:

- *Tax Matters Agreement.* As a consequence of our separation from GE, and the election we will make with GE to treat that separation as an asset sale under section 338 of the Internal Revenue Code, we expect to realize future tax savings that we otherwise would not realize. These future tax savings initially will be recorded on our balance sheet as a \$736 million reduction in net deferred income tax liabilities. We are obligated, pursuant to the Tax Matters Agreement with GE, to pay to GE 80% of the amount of tax we are projected to save for each tax period as a result of these increased tax benefits. The present value of this obligation to GE is approximately \$423 million and this liability will be recorded on our balance sheet as well. These amounts are estimates and will change as the result of a number of factors, including a final determination of the value of our company and its individual assets. However, we have agreed with GE that, with certain exceptions relating to specified contingent benefits and excluding interest on payments we defer, our total payments to GE will not exceed \$640 million.

To the extent that we never realize the anticipated tax savings because we have insufficient taxable income of the appropriate character (or because of a reduction in tax rates), we may, at our option, defer payments until 2029. These deferred payments would bear interest over the term of the deferral at an interest rate of % per annum, from the time that the payments were scheduled to be made. Similarly, to the extent that we do realize the anticipated tax savings, but we realize them later than anticipated, we may, at our option, defer payments of projected but unrealized tax savings until we realize them. These deferred payments would bear interest over the term of the deferral at an interest rate of % per annum. We may also, at our option, defer payment of any interest on deferred payments until 2029, in which case it will bear interest at the rate of % per annum.

The \$313 million difference between the \$736 million benefit we will record as the expected future tax savings and the \$423 million liability to GE we will record as a liability will be part of our net stockholder's interest. If and to the extent our Section 338 tax benefits exceed the amount of tax benefits we currently project, our additional paid-in capital would increase. As our obligation to make payments under the Tax Matters Agreement accretes over time, we will record interest expense at a rate of % per annum. Under the Tax Matters Agreement, GE also will pay certain taxes of our legal entities, other than taxes in respect of the section 338 elections described above, resulting from the various transactions implemented in connection with the separation (other than the reinsurance with UFLIC). We will record these non-recurring taxes as a current tax expense when incurred, and will record GE's payment of the taxes on our behalf as an equity contribution. See "Arrangements Between GE and Our Company—Relationship with GE—Tax Matters Agreement."

- *UFLIC reinsurance arrangements.* Prior to the completion of this offering, we will enter into several significant reinsurance transactions with UFLIC, an indirect, wholly-owned subsidiary of

73

---

GE. Under the terms of the agreements governing these reinsurance transactions, we will transfer to UFLIC assets equal to the policyholder liabilities related to the ceded blocks of business and will record a reinsurance recoverable asset for the amount of the policyholder liabilities reinsured, except with respect to the in-force liabilities for the variable annuity separate accounts, for which there is no asset transfer. We will continue to have a separate account liability in the amount of the policyholder liabilities related to the separate account assets which we are not transferring to UFLIC. We will remain liable under these contracts and policies as the ceding insurer and, as a result, will continue to carry insurance reserve liabilities for the reinsured policies on our balance sheet. In connection with the Medicare supplement insurance assumed by us, UFLIC will transfer to us cash and other investments, and we will record a reinsurance liability, equal to the policyholder liabilities related to this assumed block of business. Our total reinsurance recoverable for all of our reinsurance arrangements as of December 31, 2003, on an historical and pro forma basis, was \$2.3 billion and \$18.7 billion, respectively.

The reinsurance transactions will have the effect of transferring the financial results of the reinsured blocks of business (except for Medicare supplement insurance) from us to UFLIC and the Medicare supplement insurance block of business from UFLIC to us. With respect to the long-term care insurance policies reinsured to UFLIC, we will retain an interest in the future profitability of the block if it exceeds certain thresholds. We also will continue to administer all the policies reinsured by UFLIC, and we will receive an expense allowance to reimburse us for the costs we incur to service these policies. See "Arrangements Between GE and Our Company—Reinsurance Transactions."

#### *Equity plans*

Our key employees currently participate in a number of GE's equity compensation plans. Before 2002, we recorded compensation expense related to our employees' participation in those plans over the vesting period of the awards based upon their intrinsic value at the grant date. For grants issued after January 1, 2002, we have recognized compensation expense for share-based compensation awards over the vesting period of the awards based upon their fair value at the grant date in accordance with SFAS 123, *Accounting for Stock-Based Compensation*. We incurred compensation expense of \$6 million and \$9 million for the years ended December 31, 2002 and 2003, respectively, and expect to incur expenses of \$7 million and \$4 million in the years ended December 31, 2004 and 2005, respectively, for 2002 and prior awards to our employees' under these plans.

Upon completion of this offering, we will establish our own equity compensation plans. Under these plans, unvested GE stock options, vested stock options held by our Chairman, President and Chief Executive Officer, GE stock appreciation rights and GE restricted stock units will be canceled and converted into awards of our company, and we also will grant new stock options in our company in connection with our initial public offering and separation from GE. The GE stock options, stock appreciation rights and restricted stock units will be converted based upon a ratio equal to the initial offering price of our common stock, divided by the weighted average stock price of GE common stock for the trading day immediately preceding the date of the completion of this offering. The converted securities, if unvested, generally will continue to vest over their original vesting periods. We anticipate the unvested converted awards will have approximately the same fair value at the date of the conversion as the GE awards being replaced. Consequently, we do not expect to incur any material incremental compensation expense for the unvested converted awards. We will incur additional compensation expense as the result of conversions of vested stock options and issuances of stock options and stock appreciation rights in connection with our initial public offering. For these stock options and stock appreciation rights, we expect to incur a charge to income of approximately

74

---

\$45 million, \$40 million, \$17 million, \$10 million and \$4 million for the five twelve-month periods following the completion of the offering.

#### *Advertising costs*

We expect to incur aggregate incremental expenses of approximately \$35 million in each of the years ending December 31, 2004 and 2005 on marketing, advertising and legal entity transition expenses, reflecting primarily the additional costs of establishing our new brand throughout our business, including with consumers and sales intermediaries.

#### *Critical accounting policies*

The accounting policies discussed in this section are those that we consider to be particularly critical to an understanding of our financial statements because their application places the most significant demands on our ability to judge the effect of inherently uncertain matters on our financial results. For all of these policies, we caution that future events rarely develop exactly as forecast, and our management's best estimates may require adjustment.

*Reserves.* We calculate and maintain reserves for the estimated future payment of claims to our policyholders and contractholders based on actuarial assumptions and in accordance with industry practice and U.S. GAAP. Many factors can affect these reserves, including economic and social conditions, inflation, healthcare costs, changes in doctrines of legal liability and damage awards in litigation. Therefore, the reserves we establish are necessarily based on extensive estimates, assumptions and our analysis of historical experience. Our results depend significantly upon the extent to which our actual claims experience is consistent with the assumptions we used in determining our reserves and pricing our products. Our reserve assumptions and estimates require significant judgment and, therefore, are inherently uncertain. We cannot determine with precision that the ultimate amounts that we will pay for actual claims or the timing of those payments will be consistent with our reserve assumptions.

Insurance reserves differ for long- and short-duration insurance policies and annuity contracts. Measurement of long-duration insurance reserves (such as guaranteed renewable term life, whole life and long-term care insurance policies) is based on approved actuarial methods, but necessarily includes assumptions about expenses, mortality, morbidity, lapse rates and future yield on related investments. Short-duration contracts (such as payment protection insurance) are accounted for based on actuarial estimates of the amount of loss inherent in that period's claims, including losses incurred for which claims have not been reported. Short-duration contract loss estimates rely on actuarial observations of ultimate loss experience for similar historical events.

Estimates of mortgage insurance reserves for losses and loss adjustment expenses are based on notices of mortgage loan defaults and estimates of defaults that have been incurred but have not been reported by loan servicers, using assumptions of claim rates for loans in default and the average amount paid for loans that result in a claim. As is common accounting practice in the mortgage insurance industry and in accordance with U.S. GAAP, loss reserves are not established for future claims on insured loans that are not currently in default.

*Deferred acquisition costs.* Deferred acquisition costs, or DAC, represents costs which vary with and are primarily related to the sale and issuance of our insurance policies and investment contracts that are deferred and amortized over the estimated life of the related insurance policies. These costs include commissions in excess of ultimate renewal commissions, solicitation and printing costs, sales material and some support costs, such as underwriting and contract and policy issuance expenses. DAC is subsequently amortized to income, over the lives of the underlying contracts, in relation to the anticipated recognition of premiums or gross profits.

75

---

The amortization of DAC for traditional long-duration insurance products (including guaranteed renewable term life, life-contingent structured settlements and immediate annuities and long-term care insurance) is determined as a level proportion of premium based on commonly accepted actuarial methods and reasonable assumptions established when the contract or policy is issued about mortality, morbidity, lapse rates, expenses, and future yield on related investments. Amortization for annuity contracts without significant mortality risk and investment and universal life products is based on estimated gross profits and is adjusted as those estimates are revised. The DAC amortization methodology for our variable products (variable annuities and variable universal life insurance) includes a long-term equity market average appreciation assumption of 8.5%. When actual returns vary from the expected 8.5%, we assume a reversion to this mean over a 3- to 12-year period, subject to the imposition of ceilings and floors. The assumed returns over this reversion period are limited to the 85th percentile of historical market performance.

We regularly review all of these assumptions and periodically test DAC for recoverability. For deposit products, if the current present value of estimated future gross profits is less than the unamortized DAC for a line of business, a charge to income is recorded for additional DAC amortization. For other products, if the benefit reserves plus anticipated future premiums and interest earnings for a line of business are less than the current estimate of future benefits and expenses (including any unamortized DAC), a charge to income is recorded for additional DAC amortization or for increased benefit reserves.

Unfavorable experience with regard to expected expenses, investment returns, mortality, morbidity, withdrawals or lapses, may cause us to increase the amortization of DAC or to record a charge to increase benefit reserves. In recent years, the portion of estimated product margins required to amortize DAC and PVFP has increased in most lines of our business, with the most significant impact on investment products, primarily as the result of lower investment returns.

*Present value of future profits.* In conjunction with the acquisition of a block of life insurance policies or investment contracts, a portion of the purchase price is assigned to the right to receive future gross profits arising from existing insurance and investment contracts. This intangible asset, called the present value of future profits, or PVFP, represents the actuarially estimated present value of future cash flows from the acquired policies. PVFP is amortized, net of accreted interest, in a manner similar to the amortization of DAC. We regularly review our assumptions and periodically test PVFP for recoverability in a manner similar to our treatment of DAC.

*Goodwill impairment.* Goodwill resulting from acquisitions is tested for impairment at least annually using a fair value approach, which requires the use of estimates and judgment. To the extent the carrying amount of goodwill exceeds its fair value, an impairment charge to income would be recorded.

*Valuation of investment securities.* We obtain values for actively traded securities from external pricing services. For infrequently traded securities, we obtain quotes from brokers or we estimate values using internally developed pricing models. These models are based upon common valuation techniques and require us to make assumptions regarding credit quality, liquidity and other factors that affect estimated values.

*Impairment of investment securities.* We regularly review investment securities for impairment in accordance with our impairment policy, which includes both quantitative and qualitative criteria. Our quantitative criteria include length of time and amount that each security position is in an unrealized loss position, and for fixed maturities, whether the issuer is in compliance with terms and covenants of the security. Our qualitative criteria include the financial strength and specific prospects for the issuer as well as our intent to hold the security until recovery. We actively perform comprehensive market research, monitor market conditions and segment our investments by credit risk in order to minimize

76

combined financial statements, included elsewhere in this prospectus.

## Historical Combined and Pro Forma Results of Operations

The following table sets forth our historical combined and pro forma results of operations. This information should be read in conjunction with the additional information regarding our results of operations by segment set forth under "—Historical Combined and Pro Forma Results of Operations by Segments."

The pro forma financial information reflects our historical results of operations as adjusted to reflect the various adjustments described under "Selected Historical and Pro Forma Financial Information." The pro forma financial information principally reflects the exclusion from our results of operations of the structured settlement, variable annuity and long-term care insurance in-force blocks that we will cede to UFLIC in connection with the reinsurance transactions; the exclusion from our results of operations of certain businesses, including the Affinity segment, and other assets and liabilities of GEFAHI that will not be transferred to us in connection with our corporate reorganization; and the inclusion in our results of operations of incremental interest expense associated with the consideration to be issued to GEFAHI in connection with our corporate reorganization, including \$600 million of our Equity Units, \$100 million of our Series A Preferred Stock and the \$2.4 billion Short-term Intercompany Note. Pro forma revenues and benefits and expenses are lower than our historical revenues and benefits and expenses primarily as a result of the exclusion of revenues and expenses related to the reinsured blocks of business and the Affinity segment.

	Historical			Pro forma
	Years ended December 31,			Year ended December 31,
	2003	2002	2001	2003
<b>(Dollar amounts in millions)</b>				
<b>Revenues:</b>				
Premiums	\$ 6,703	\$ 6,107	\$ 6,012	\$ 6,252
Net investment income	4,015	3,979	3,895	2,928
Net realized investment gains	10	204	201	38
Policy fees and other income	943	939	993	557
<b>Total revenues</b>	<b>11,671</b>	<b>11,229</b>	<b>11,101</b>	<b>9,775</b>
<b>Benefits and expenses:</b>				
Benefits and other changes in policy reserves	5,232	4,640	4,474	4,191
Interest credited	1,624	1,645	1,620	1,358
Underwriting, acquisition and insurance expenses, net of deferrals	1,942	1,808	1,823	1,614
Amortization of deferred acquisition costs and intangibles	1,351	1,221	1,237	1,144
Interest expense	140	124	126	138
<b>Total benefits and expenses</b>	<b>10,289</b>	<b>9,438</b>	<b>9,280</b>	<b>8,445</b>
Earnings from continuing operations before income taxes	1,382	1,791	1,821	1,330
Provision for income taxes	413	411	590	395
<b>Net earnings from continuing operations</b>	<b>\$ 969</b>	<b>\$ 1,380</b>	<b>\$ 1,231</b>	<b>\$ 935</b>

### Year Ended December 31, 2003 Compared to Year Ended December 31, 2002

**Premiums.** Our premiums consist primarily of premiums earned on individual life, long-term care, group life and health and payment protection insurance policies, income annuities and structured settlements with life contingencies, variable life insurance policies, and mortgage insurance policies. Premiums increased \$596 million, or 10%, to \$6,703 million for the year ended December 31, 2003 from \$6,107 million for the year ended December 31, 2002. This increase was primarily the result of a \$500 million increase in our Protection segment, a \$54 million increase in our Retirement Income and

Investments segment, and a \$39 million increase in our Mortgage Insurance segment. The increase in our Protection segment was primarily attributable to increases in payment protection insurance premiums as a result of changes in foreign exchange rates and growth of the in-force block as well as growth in long-term care insurance premiums. The increase in our Retirement Income and Investments segment was primarily attributable to an increase in life-contingent structured settlement premiums, offset in part by a decrease in life-contingent income annuities. The increase in our Mortgage Insurance segment was primarily attributable to an increase in international mortgage insurance premiums, offset in part by a decrease in U.S. mortgage insurance premiums.

**Net investment income.** Net investment income represents the income earned on our investments. Net investment income increased \$36 million, or 1%, to \$4,015 million for the year ended December 31, 2003 from \$3,979 million for the year ended December 31, 2002. This increase in net investment income was primarily the result of a \$7,874 million, or 11%, increase in average invested assets. This increase was offset in part by a decrease in weighted average investment yields, primarily attributable to investments in the U.S., to 5.2% for the year ended December 31, 2003 from 5.8% for the year ended December 31, 2002.

**Net realized investment gains.** Net realized investment gains consist of gross realized investment gains and gross realized investment (losses), including charges related to impairments. Net realized investment gains decreased \$194 million to \$10 million for the year ended December 31, 2003 from \$204 million for the year ended December 31, 2002. For the year ended December 31, 2003, gross realized gains and (losses) were \$473 million and \$(463) million, respectively. The realized gains for the year ended December 31, 2003 included a \$43 million gain from a securitization of certain financial assets. Realized losses for the year ended December 31, 2003 included \$224 million of impairments. These impairments were attributable to fixed maturities, equity securities and other investments (\$126 million, \$83 million and \$15 million, respectively). The fixed maturities impairments primarily related to securities issued by companies in the transportation, mining and metals, utilities and energy and technology and communications industries (\$36 million, \$28 million, \$12 million and \$11 million, respectively). In addition, \$30 million of fixed maturities impairments were realized on asset-backed securities. The equity securities impairments related to mutual fund and common stock investments (\$37 million and \$46 million, respectively). The other investments impairments primarily related to impairment of limited partnership investments. For the year ended December 31, 2002, gross realized gains and (losses) were \$790 million and \$(586) million, respectively. The realized gains for the year ended December 31, 2002 included \$29 million from a securitization of certain financial assets. Realized losses for the year ended December 31, 2002 included \$343 million of impairments. These impairments were attributable to fixed maturities, equity securities and other

investments (\$193 million, \$133 million and \$17 million, respectively). The fixed maturities impairments primarily related to securities issued by companies in the technology and communications and airline industries (\$131 million and \$27 million, respectively). The technology and communication industry impairments include \$83 million related to securities issued by WorldCom Inc. and its affiliates. The equity securities impairments related to mutual fund and common stock investments (\$81 million and \$52 million, respectively). The other investments impairments are related to impairment of limited partnership and other private equity investments.

*Policy fees and other income.* Policy fees and other income consist primarily of cost of insurance and surrender charges assessed on universal life insurance policies, fees assessed against policyholder and contractholder account values, and commission income. Policy fees and other income increased \$4 million to \$943 million for the year ended December 31, 2003 from \$939 million for the year ended December 31, 2002. This increase was the result of a \$38 million increase in our Corporate and Other segment and a \$10 million increase in our Mortgage Insurance segment, offset in part by a \$18 million decrease in our Retirement Income and Investments segment, a \$15 million decrease in our Protection segment, and a \$11 million decrease in the Affinity segment. The increase in our Corporate and Other

78

---

segment was primarily attributable to interest income resulting from the consolidation of two securitization entities in our financial statements in connection with our adoption of FASB Interpretation 46 ("FIN 46"), *Consolidation of Variable Interest Entities*, beginning in the third quarter of 2003. The increase in our Mortgage Insurance segment was primarily attributable to higher contract underwriting fees related to increased refinancing activity in the U.S. and higher fees from increased volume in our international mortgage insurance business. The decrease in our Retirement Income and Investments segment was primarily attributable to decreases in commission income and fee income on variable annuities. The decrease in our Protection segment was primarily attributable to a decrease in administrative fees from our group life and health insurance business. The decrease in the Affinity segment was primarily attributable to the decision to discontinue certain products and distribution relationships that did not meet our target return thresholds.

*Benefits and other changes in policy reserves.* Benefits and other changes in policy reserves consist primarily of reserve activity related to current claims and future policy benefits on life, long-term care, group life and health and payment protection insurance policies, structured settlements and income annuities with life contingencies and claim costs incurred related to mortgage insurance products. Benefits and other changes in policy reserves increased \$592 million, or 13%, to \$5,232 million for the year ended December 31, 2003 from \$4,640 million for the year ended December 31, 2002. This increase was primarily the result of a \$367 million increase in our Protection segment, a \$102 million increase in our Retirement Income and Investments segment and a \$69 million increase in our Mortgage Insurance segment. The increase in our Protection segment was primarily attributable to an increase in changes in policy reserves for long-term care insurance, payment protection insurance and life insurance. The increase in our Retirement Income and Investments segment was primarily attributable to an increase in changes in policy reserves for structured settlements. The increase in our Mortgage Insurance segment was primarily attributable to favorable loss development on prior year reserves.

*Interest credited.* Interest credited represents interest credited on behalf of policyholder and contractholder general account balances. Interest credited decreased \$21 million, or 1%, to \$1,624 million for the year ended December 31, 2003 from \$1,645 million for the year ended December 31, 2002. This decrease was primarily the result of a \$24 million decrease in our Retirement Income and Investments segment that was primarily attributable to lower credited rates on GICs and funding agreements, offset in part by an increase in interest credited resulting from more variable annuity policyholders selecting the fixed account option on their contracts, on which we credit interest. The decrease in interest credited was also the result of a reduction in our weighted average crediting rates to 3.3% for the year ended December 31, 2003 from 3.6% for the year ended December 31, 2002.

*Underwriting, acquisition and insurance expenses, net of deferrals.* Underwriting, acquisition and insurance expenses, net of deferrals, represent costs and expenses related to the acquisition and ongoing maintenance of insurance and investment contracts, including commissions, policy issue expenses and other underwriting and general operating costs. These costs and expenses are net of amounts that are capitalized and deferred, which are primarily costs and expenses which vary with and are primarily related to the sale and issuance of our insurance policies and investment contracts, such as first year commissions in excess of ultimate renewal commissions and other policy issue expenses. These expenses increased \$134 million, or 7%, to \$1,942 million for the year ended December 31, 2003 from \$1,808 million for the year ended December 31, 2002. This increase was primarily the result of a \$99 million increase in our Protection segment, a \$66 million increase in our Mortgage Insurance segment, and a \$31 million increase in our Corporate and Other segment, offset in part by a \$73 million decrease in the Affinity segment. The increase in our Protection segment was primarily attributable to growth of the payment protection insurance in-force block. The increase in our Mortgage Insurance segment was primarily attributable to higher expenses associated with increased refinancing activity in the U.S., continued investment in our international mortgage insurance business

79

---

and higher indemnity liabilities for U.S. contract underwriting claims, which are included as other liabilities in our statement of financial position. U.S. contract underwriting indemnification claims arise out of our contract underwriting agreements, pursuant to which we agree to indemnify lenders against losses incurred in the event that we make material errors during the underwriting process. These claims are classified in this line item (and not in "Benefits and other changes in policy reserves") because they do not relate to insured events. Our indemnification liabilities related to U.S. contract underwriting claims increased as the result of our updating the assumptions we used to calculate these indemnity liabilities to reflect recent underwriting experience and the increase in the volume of mortgage loans underwritten due to significant refinancing activity. The increase in our Corporate and Other segment was primarily attributable to an increase in reserves for a class action litigation settlement. The decrease in the Affinity segment was primarily attributable to cost saving initiatives that reduced compensation and benefits and other general expenses.

*Amortization of deferred acquisition costs and intangibles.* Amortization of deferred acquisition costs and intangibles consists primarily of the amortization of acquisition costs that are capitalized and PVFP and, for years prior to 2002, goodwill. Amortization increased \$130 million, or 11%, to \$1,351 million for the year ended December 31, 2003 from \$1,221 million for the year ended December 31, 2002. This increase was primarily the result of a \$155 million increase in our Protection segment, offset in part by a \$20 million decrease in our Retirement Income and Investments segment. The increase in our Protection segment was primarily attributable to growth of the payment protection insurance in-force block. The decrease in our Retirement Income and Investments segment was primarily attributable to the impact of accelerated amortization in 2002 due to lower equity valuations of assets in our variable annuity separate accounts.

*Interest expense.* Interest expense increased \$16 million, or 13%, to \$140 million for the year ended December 31, 2003 from \$124 million for the year ended December 31, 2002. This increase was primarily the result of \$27 million of interest expense associated with securitization entities that were consolidated in our financial statements in connection with our adoption of FIN 46, beginning in the third quarter of 2003, and \$3 million of interest paid on non-recourse funding obligations, issued in the third and fourth quarters of 2003, supporting certain term life insurance policies. These increases were offset in part by a \$14 million decrease in interest expense that was primarily the result of lower average short-term borrowings and long-term borrowings.

*Provision for income taxes.* Provision for income taxes increased \$2 million to \$413 million for the year ended December 31, 2003 from \$411 million for the year ended December 31, 2002. The effective tax rate was 29.9% and 22.9% for the years ended December 31, 2003 and 2002, respectively. This increase in effective tax rate was primarily the result of a \$152 million decrease in income tax expense for the year ended December 31, 2002 that was attributable to a favorable settlement with the Internal Revenue Service related to the treatment of certain reserves for obligations to policyholders on life insurance contracts, offset in part by dividend received deduction benefits realized in 2003. Excluding the effect of the settlement, our effective tax rate would have been 29.9% and 31.4% for the years ended December 31, 2003 and 2002, respectively.

*Net earnings from continuing operations.* Net earnings from continuing operations decreased by \$411 million, or 30%, to \$969 million for the year ended December 31,

2003 from \$1,380 million for the year ended December 31, 2002. This decrease was primarily the result of a reduction in net realized investment gains and the impact of a favorable settlement with the IRS in 2002. The decline in net earnings from continuing operations reflects decreases in segment net earnings in our Protection, Retirement Income and Investments, Mortgage Insurance and Corporate and Other segments, offset in part by increased segment net earnings in the Affinity segment.

---

**Year Ended December 31, 2002 Compared to Year Ended December 31, 2001**

**Premiums.** Premiums increased \$95 million, or 2%, to \$6,107 million for the year ended December 31, 2002 from \$6,012 million for the year ended December 31, 2001. This increase was primarily the result of a \$173 million increase in our Protection segment, offset in part by a \$39 million decrease in the Affinity segment, a \$32 million decrease in our Retirement Income and Investments segment and a \$21 million decrease in our Mortgage Insurance segment. The increase in our Protection segment was primarily attributable to increases in long-term care insurance and payment protection insurance premiums, offset in part by a decrease in life insurance premiums. The decrease in the Affinity segment was primarily attributable to the decision to discontinue certain products and distribution relationships that did not meet our target return thresholds. The decrease in our Retirement Income and Investment segment was primarily attributable to a decrease in premiums from life-contingent structured settlements, offset in part by an increase in premiums from income annuities. The decrease in our Mortgage Insurance segment was primarily attributable to a decrease in premiums from our U.S. mortgage insurance business, offset in part by an increase in premiums from our international mortgage insurance business.

**Net investment income.** Net investment income increased \$84 million, or 2%, to \$3,979 million for the year ended December 31, 2002 from \$3,895 million for the year ended December 31, 2001. This increase was primarily the result of an increase of \$8,802 million, or 15%, in average invested assets. This increase was offset in part by a decrease in our weighted average investment yields, primarily attributable to investments in the U.S., to 5.8% for the year ended December 31, 2002 from 6.5% for the year ended December 31, 2001.

**Net realized investment gains.** Net realized investment gains increased \$3 million, or 1%, to \$204 million for the year ended December 31, 2002 from \$201 million for the year ended December 31, 2001. For the year ended December 31, 2002, gross realized gains and (losses) were \$790 million and \$(586) million, respectively. The realized gains for the year ended December 31, 2002 included \$29 million attributable to a securitization of certain financial assets. Realized losses for the year ended December 31, 2002 included \$343 million of impairments. These impairments were attributable to fixed maturities, equity securities and other investments (\$193 million, \$133 million and \$17 million, respectively). The fixed maturities impairments primarily related to securities issued by companies in the technology and communications and airline industries (\$131 million and \$27 million, respectively). The technology and communication industry impairments include \$83 million related to securities issued by WorldCom Inc. and its affiliates. The equity securities impairments related to mutual fund and common stock investments (\$81 million and \$52 million, respectively). The other investments impairments are related to impairment of limited partnership and other private equity investments. For the year ended December 31, 2001, gross realized gains and (losses) were \$814 million and \$(613) million, respectively. The realized gains for the year ended December 31, 2001 included \$145 million attributable to securitization of certain financial assets. Realized losses for the year ended December 31, 2001 included \$289 million of impairments. These impairments were attributable to fixed maturities, equity securities and other investments (\$201 million, \$78 million and \$10 million, respectively). The fixed maturities impairments primarily related to securities issued by companies in the technology and communications and utilities and energy industries (\$85 million and \$81 million respectively). The utilities and energy industry impairments include \$80 million related to securities issued by Enron Corp. The equity securities impairments related to common stock and mutual fund investments were \$64 million and \$14 million, respectively.

**Policy fees and other income.** Policy fees and other income decreased \$54 million, or 5%, to \$939 million for the year ended December 31, 2002 from \$993 million for the year ended December 31, 2001. This decrease was primarily the result of a \$56 million decrease in the Affinity segment and a \$28 million decrease in our Protection segment, offset in part by a \$27 million increase

---

in our Retirement Income and Investments segment. The decrease in the Affinity segment was primarily attributable to our decision to discontinue certain products and distribution relationships that did not meet our target return thresholds. The decrease in our Protection segment was primarily attributable to a return to a normal level of policy fees in 2002 following the recognition in 2001 of deferred policy fees resulting from the favorable mortality experience in certain universal life insurance products. The increase in our Retirement Income and Investments segment was attributable to the acquisition of a small asset management company at the end of 2001, offset in part by a decrease in fee income on variable annuity products.

**Benefits and other changes in policy reserves.** Benefits and other changes in policy reserves increased \$166 million, or 4%, to \$4,640 million for the year ended December 31, 2002 from \$4,474 million for the year ended December 31, 2001. This increase was primarily the result of a \$250 million increase in our Protection segment and a \$33 million increase in our Retirement Income and Investments segment, offset in part by a \$104 million decrease in our Mortgage Insurance segment. The increase in our Protection segment was primarily attributable to increases in changes in policy reserves for long-term care insurance and payment protection insurance. The increase in the Retirement Income and Investments segment was primarily attributable to an increase in changes in policy reserves for income annuities, offset in part by a decrease in changes in policy reserves for structured settlements. The decrease in our Mortgage Insurance segment was primarily attributable to favorable loss development on prior year reserves.

**Interest credited.** Interest credited increased \$25 million, or 2%, to \$1,645 million for the year ended December 31, 2002 from \$1,620 million for the year ended December 31, 2001. This increase was primarily the result of a \$20 million increase in our Protection segment that was primarily attributable to increased policyholder account balances in universal life and corporate-owned life insurance products. The increase in interest credited was also the result of a \$5 million increase in our Retirement Income and Investments segment that was primarily attributable to an increase in policyholder accounts attributable to higher sales of annuity products. These increases were offset in part by a reduction in our weighted average crediting rates attributable to the lower interest rate environment to 3.6% for the year ended December 31, 2002 from 4.0% for the year ended December 31, 2001.

**Underwriting, acquisition and insurance expenses, net of deferrals.** Underwriting, acquisition and insurance expenses, net of deferrals, decreased \$15 million, or 1%, to \$1,808 million for the year ended December 31, 2002 from \$1,823 million for the year ended December 31, 2001. This decrease was primarily the result of a \$113 million decrease in our Protection segment and a \$8 million decrease in the Affinity segment, offset in part by a \$53 million increase in our Mortgage Insurance segment, a \$34 million increase in our Retirement Income and Investments segment, and a \$19 million increase in our Corporate and Other segment. The decrease in our Protection segment was primarily attributable to a decrease in periodic payment protection insurance products resulting in lower current expense; a major customer's decision to underwrite its own payment protection insurance policies; and reduced expenses associated with a discontinued block of accident and health insurance policies in our long-term care insurance business. The decrease in the Affinity segment was primarily attributable to reduced compensation and benefits and other cost-saving initiatives. The increase in our Mortgage Insurance segment was primarily attributable to growth in our international mortgage insurance business, increased expenses in the U.S. due to increased underwriting volume from higher refinancing activity, and the impact of a decrease in the liability associated with U.S. contract underwriting indemnifications in 2001 as the result of our updating of the assumptions we used to calculate these indemnity liabilities to reflect recent underwriting experience where loss experience was lower than we had anticipated. The increase in our Retirement Income and Investments segment was primarily attributable to the operations of a small asset management company acquired at the end of 2001. The



increase in our Corporate and Other segment was primarily attributable to costs incurred to close certain facilities resulting from relocations to Richmond, Virginia.

*Amortization of deferred acquisition costs and intangibles.* Amortization of deferred acquisition costs and intangibles decreased \$16 million, or 1%, to \$1,221 million for the year ended December 31, 2002 from \$1,237 million for the year ended December 31, 2001. This decrease was the result of a \$40 million decrease in the Affinity segment and a \$12 million decrease in our Mortgage Insurance segment, offset in part by a \$29 million increase in our Retirement Income and Investments segment and a \$7 million increase in our Protection segment. The decrease in the Affinity segment was primarily attributable to an adjustment in the fourth quarter of 2002 to reflect actual membership lapse rates as compared with the lapse rates projected at the time of purchase. The decrease in our Mortgage Insurance segment was primarily attributable to discontinuation of goodwill amortization in accordance with SFAS 142. The increase in our Retirement Income and Investments segment was primarily attributable to accelerated amortization of deferred acquisition costs for variable annuity products associated with the decrease in asset values resulting from declines in the equity markets. The increase in our Protection segment was primarily attributable to growth in the payment protection insurance in-force block, offset in part by the discontinuation of amortization of goodwill in accordance with SFAS 142 and a decrease associated with the amortization for PVFP of the block of long-term care insurance reinsured from Travelers.

*Interest expense.* Interest expense decreased \$2 million, or 2%, to \$124 million for the year ended December 31, 2002 from \$126 million for the year ended December 31, 2001. This decrease was primarily the result of lower interest rates on borrowings, offset in part by higher average borrowings.

*Provision for income taxes.* Provision for income taxes decreased \$179 million, or 30%, to \$411 million for the year ended December 31, 2002 from \$590 million for the year ended December 31, 2001. The effective tax rate was 22.9% and 32.4% for the years ended December 31, 2002 and 2001, respectively. This decrease in effective tax rate was primarily the result of a \$152 million decrease in income tax expense for the year ended December 31, 2002 that was attributable to a favorable settlement with the IRS related to the treatment of certain reserves for obligations to policyholders on life insurance contracts. Excluding the effect of this item, our effective tax rate would have been 31.4% and 32.4% for the years ended December 31, 2002 and 2001, respectively. The decrease was also the result of our discontinuation of goodwill amortization in accordance with SFAS 142.

*Net earnings from continuing operations.* Net earnings from continuing operations increased by \$149 million, or 12%, to \$1,380 million for the year ended December 31, 2002 from \$1,231 million for the year ended December 31, 2001. This increase was primarily the result of the lower provision for income taxes primarily attributable to the favorable settlement with the IRS. The increase in net earnings from continuing operations reflects increases in segment net earnings in our Protection, Mortgage Insurance and Corporate and Other segments, offset in part by decreases in segment net earnings in our Retirement Income and Investments and Affinity segments.

#### Historical Combined and Pro Forma Results of Operations by Segment

Set forth below is historical combined financial information for each of our operating segments after the completion of this offering (Protection, Retirement Income and Investments and Mortgage Insurance), together with our Corporate and Other segment and the Affinity segment. Set forth below also is pro forma financial information for our Protection, Retirement Income and Investments, Mortgage Insurance and Corporate and Other segments. The pro forma financial information for the Mortgage Insurance segment reflects an adjustment to its financial position to remove assets and liabilities that will not be transferred to us in connection with our corporate reorganization. There were no material revenues or expenses associated with these assets and liabilities. Pro forma financial information is not provided for the Affinity segment because we will not be acquiring that segment from GEFAHI. All pro forma segment information is calculated on the same basis as the segment information presented in our audited historical combined financial statements. See note 23 to our audited historical combined financial statements included elsewhere in this prospectus.

83

Management regularly reviews the performance of each of our operating segments based on the after-tax net earnings (loss) of the segment, which excludes: (1) net realized investment gains (losses), (2) interest expense and other debt financing expenses that are incurred at our holding company level, (3) amounts reserved for the settlement in principle of the class action litigation relating to sales practices in our life insurance business, and (4) advertising and marketing costs and severance and restructuring charges. Although these excluded items are significant to our consolidated financial performance, we believe that the presentation of segment net earnings (loss) enhances our understanding and assessment of the results of operations of our operating segments by highlighting net earnings (loss) attributable to the normal, recurring operations of our business. However, segment net earnings (loss) is not a substitute for net income determined in accordance with U.S. GAAP.

	Historical			Pro forma	
	Years ended December 31,			Year ended December 31,	
	2003	2002	2001	2003	
<b>(Dollar amounts in millions)</b>					
<b>Revenues by segment:</b>					
Protection	\$ 6,153	\$ 5,605	\$ 5,443	\$	5,839
Retirement Income and Investments	3,781	3,756	3,721		2,707
Mortgage Insurance	982	946	965		982
Affinity	566	588	687		—
Corporate and Other	189	334	285		247
<b>Total revenues</b>	<b>\$ 11,671</b>	<b>\$ 11,229</b>	<b>\$ 11,101</b>	<b>\$</b>	<b>9,775</b>
<b>Segment net earnings (loss):</b>					
Protection	\$ 487	\$ 554	\$ 538	\$	481
Retirement Income and Investments	151	186	215		93
Mortgage Insurance	369	451	428		369
Affinity	16	(3)	24		—
Corporate and Other	(54)	192	26		(8)
<b>Total segment net earnings (loss)</b>	<b>\$ 969</b>	<b>\$ 1,380</b>	<b>\$ 1,231</b>	<b>\$</b>	<b>935</b>
<b>Total assets by segment (as of the year ended):</b>					
Protection	\$ 29,254	\$ 27,104	\$ 24,647	\$	28,801
Retirement Income and Investments	55,614	53,624	50,512		52,675
Mortgage Insurance	6,110	6,066	5,830		6,087

Affinity	2,315	2,317	2,211	—
Corporate and Other	10,138	28,246	20,798	10,304
Total assets	\$ 103,431	\$ 117,357	\$ 103,998	\$ 97,867

### Protection segment

The following table presents the historical and pro forma results of operations relating to our Protection segment. The pro forma financial information reflects adjustments to give effect to the reinsurance transactions in which we will cede to UFLIC a block of long-term care insurance policies that we reinsured from Travelers in 2000 and we will assume from UFLIC in-force blocks of Medicare supplement insurance policies. There were no pro forma adjustments to policy fees and other income, interest credited or interest expense because the long-term care insurance policies we will cede to UFLIC, and the Medicare supplement insurance policies UFLIC will cede to us, in connection with the reinsurance transactions do not generate such fees, interest credited or interest expense. Pro forma revenues and benefits and expenses are lower than our historical revenues and benefits and expenses

84

primarily as a result of exclusion of revenues and benefits and expenses related to the reinsured long-term care insurance policies.

	Historical			Pro forma
	Years ended December 31,			Year ended December 31,
	2003	2002	2001	2003
<b>(Dollar amounts in millions)</b>				
<b>Revenues:</b>				
Premiums	\$ 4,588	\$ 4,088	\$ 3,915	\$ 4,381
Net investment income	1,199	1,136	1,119	1,092
Policy fees and other income	366	381	409	366
<b>Total revenues</b>	<b>6,153</b>	<b>5,605</b>	<b>5,443</b>	<b>5,839</b>
<b>Benefits and expenses:</b>				
Benefits and other changes in policy reserves	2,997	2,630	2,380	2,745
Interest credited	365	362	342	365
Underwriting, acquisition and insurance expenses, net of deferrals	1,029	930	1,043	994
Amortization of deferred acquisition costs and intangibles	1,001	846	839	981
Interest expense	3	—	—	3
<b>Total benefits and expenses</b>	<b>5,395</b>	<b>4,768</b>	<b>4,604</b>	<b>5,088</b>
Earnings before income taxes	758	837	839	751
Provision for income taxes	271	283	301	270
<b>Segment net earnings</b>	<b>\$ 487</b>	<b>\$ 554</b>	<b>\$ 538</b>	<b>\$ 481</b>

### Year Ended December 31, 2003 Compared to Year Ended December 31, 2002

**Premiums.** Premiums increased \$500 million, or 12%, to \$4,588 million for the year ended December 31, 2003 from \$4,088 million for the year ended December 31, 2002. This increase was primarily the result of a \$265 million increase in payment protection insurance premiums, with \$155 million of that increase attributable to changes in foreign exchange rates and \$110 million of that increase attributable to growth of the in-force block. The increase was also the result of a \$232 million increase in long-term care insurance premiums that was primarily attributable to growth of the in-force block.

**Net investment income.** Net investment income increased \$63 million, or 6%, to \$1,199 million for the year ended December 31, 2003 from \$1,136 million for the year ended December 31, 2002. This increase was primarily the result of an increase in invested assets, offset in part by declining yields on investments in the lower interest rate environment.

**Policy fees and other income.** Policy fees and other income decreased \$15 million, or 4%, to \$366 million for the year ended December 31, 2003 from \$381 million for the year ended December 31, 2002. This decrease was primarily the result of a \$13 million decrease in administrative fees from our group life and health insurance business that was primarily attributable to higher lapse rates.

**Benefits and other changes in policy reserves.** Benefits and other changes in policy reserves increased \$367 million, or 14%, to \$2,997 million for the year ended December 31, 2003 from \$2,630 million for the year ended December 31, 2002. This increase was primarily the result of a \$267 million increase in changes in reserves and benefit payments resulting from the normal, expected increases in claims volume associated with the aging of the long-term care insurance in-force block. The increase was also the result of a \$69 million increase in changes in policy reserves attributable to

85

growth of the payment protection insurance in-force block, of which \$34 million was attributable to a lower amount of favorable loss development on prior-year reserves, and a \$38 million increase in life insurance reserves.

**Interest credited.** Interest credited increased \$3 million, or 1%, to \$365 million for the year ended December 31, 2003 from \$362 million for the year ended December 31,

2002. This increase was primarily the result of increased policyholder account balances on corporate-owned life insurance policies, offset in part by decreased crediting rates for universal life insurance policies.

*Underwriting, acquisition, insurance and other expenses, net of deferrals.* Underwriting, acquisition, insurance and other expenses, net of deferrals increased \$99 million, or 11%, to \$1,029 million for the year ended December 31, 2003 from \$930 million for the year ended December 31, 2002. This increase was primarily the result of an \$83 million increase attributable to growth in the payment protection insurance in-force block that was primarily associated with an increase in net commission expense.

*Amortization of deferred acquisition costs and intangibles.* Amortization of deferred acquisition costs and intangibles increased \$155 million, or 18%, to \$1,001 million for the year ended December 31, 2003 from \$846 million for the year ended December 31, 2002. This increase was primarily the result of a \$96 million increase resulting from growth of the payment protection insurance in-force block. The increase was also the result of a \$33 million increase primarily attributable to additional investment income due to early bond calls within the universal life insurance investment portfolio and to favorable universal life insurance claims experience, both of which accelerated amortization of deferred acquisition costs and intangibles. In addition, \$19 million of the increase was the result of the impact of the amortization of PVFP in 2002 for the block of long-term care insurance reinsured from Travelers.

*Interest expense.* Interest expense increased \$3 million for the year ended December 31, 2003 from \$0 million for the year ended December 31, 2002. This increase was the result of interest paid on non-recourse funding obligations, issued in the third and fourth quarters of 2003, supporting certain term life insurance policies.

*Provision for income taxes.* Provision for income taxes decreased \$12 million, or 4%, to \$271 million for the year ended December 31, 2003 from \$283 million for the year ended December 31, 2002. The effective tax rate was 35.8% and 33.8% for the years ended December 31, 2003 and 2002, respectively. This increase in effective tax rate was primarily the result of a decrease in certain foreign tax loss and dividend benefits.

*Segment net earnings.* Segment net earnings decreased by \$67 million, or 12%, to \$487 million for the year ended December 31, 2003 from \$554 million for the year ended December 31, 2002. The decrease in segment net earnings primarily reflects decreases in net earnings for life, payment protection and group life and health insurance products, offset in part by increases in net earnings for long-term care insurance products. The decrease in life insurance was primarily attributable to an increase in life insurance reserves, as well as accelerated amortization of deferred acquisition costs and intangibles related to additional investment income resulting from early bond calls and favorable claims experience. The decrease in payment protection insurance was primarily attributable to higher underwriting, acquisition, insurance and other expenses, net of deferrals, and the impact of the recognition in 2002 of certain foreign tax loss benefits. The decrease in group life and health insurance was primarily attributable to lower administration fees due to higher lapse rates. The increase in long-term care insurance was primarily attributable to growth in the in-force blocks.

#### **Year Ended December 31, 2002 Compared to Year Ended December 31, 2001**

*Premiums.* Premiums increased \$173 million, or 4%, to \$4,088 million for the year ended December 31, 2002 from \$3,915 million for the year ended December 31, 2001. This increase was

86

---

primarily the result of a \$110 million increase in long-term care insurance premiums that was primarily attributable to growth of the in-force block. The increase was also the result of an \$81 million increase in payment protection insurance premiums, with \$40 million of that increase attributable to growth of the in-force block and \$41 million attributable to changes in foreign exchange rates. These increases were offset in part by a \$27 million decrease in term life insurance premiums that was primarily attributable to a term life insurance in-force reinsurance transaction in which certain premiums were ceded by us to a third-party reinsurer.

*Net investment income.* Net investment income increased \$17 million, or 2%, to \$1,136 million for the year ended December 31, 2002 from \$1,119 million for the year ended December 31, 2001. This increase was primarily the result of an increase in invested assets, offset in part by declining yields on investments in the lower interest rate environment.

*Policy fees and other income.* Policy fees and other income decreased \$28 million, or 7%, to \$381 million for the year ended December 31, 2002 from \$409 million for the year ended December 31, 2001. This decrease was primarily the result of a return to a normal level of policy fees in 2002 following the recognition in 2001 of deferred policy fees resulting from favorable mortality experience in certain universal life insurance products.

*Benefits and other changes in policy reserves.* Benefits and other changes in policy reserves increased \$250 million, or 11%, to \$2,630 million for the year ended December 31, 2002 from \$2,380 million for the year ended December 31, 2001. This increase was primarily the result of a \$221 million increase in reserves and benefit payments resulting from the normal, expected increase in claims volume associated with the aging of the long-term care insurance in-force block. The increase was also the result of a \$41 million increase in changes in policy reserves attributable to growth of the payment protection insurance in-force block. These increases were offset in part by a \$12 million decrease in changes in policy reserves for group life and health insurance that were primarily attributable to favorable experience in our long-term disability product.

*Interest credited.* Interest credited increased \$20 million, or 6%, to \$362 million for the year ended December 31, 2002 from \$342 million for the year ended December 31, 2001. This increase was primarily the result of increased policyholder account balances on universal life and corporate-owned life insurance policies.

*Underwriting, acquisition, insurance and other expenses, net of deferrals.* Underwriting, acquisition, insurance and other expenses, net of deferrals decreased \$113 million, or 11%, to \$930 million for the year ended December 31, 2002 from \$1,043 million for the year ended December 31, 2001. This decrease was primarily the result of a \$72 million decrease attributable to a decrease in periodic payment protection insurance products resulting in lower current expense and to a major customer's decision to underwrite its own payment protection insurance. The decrease was also the result of a \$30 million decrease primarily attributable to a discontinued block of accident and health insurance policies in our long-term care insurance business.

*Amortization of deferred acquisition costs and intangibles.* Amortization of deferred acquisition costs and intangibles increased \$7 million, or 1%, to \$846 million for the year ended December 31, 2002 from \$839 million for the year ended December 31, 2001. This increase was primarily the result of an \$85 million increase attributable to growth of the payment protection insurance in-force block. This increase was offset in part by a \$52 million decrease attributable to discontinuation of amortization of goodwill in accordance with SFAS 142. The increase was also offset in part by a \$19 million decrease associated with the amortization of PVFP for the block of long-term care insurance reinsured from Travelers.

*Interest expense.* There was no interest expense for the years ended December 31, 2002 and 2001.

87

---

*Provision for income taxes.* Provision for income taxes decreased \$18 million, or 6%, to \$283 million for the year ended December 31, 2002 from \$301 million for the year ended December 31, 2001. The effective tax rate was 33.8% and 35.9% for the years ended December 31, 2002 and 2001, respectively. This decrease in effective tax rate

was primarily the result of an increase in certain foreign tax loss and dividend benefits, as well as the discontinuation of goodwill amortization in accordance with SFAS 142.

*Segment net earnings.* Segment net earnings increased \$16 million, or 3%, to \$554 million for the year ended December 31, 2002 from \$538 million for the year ended December 31, 2001. This increase was primarily attributable to the discontinuance in 2002 of goodwill amortization. The increase in segment net earnings reflects increases in net earnings for payment protection and group life and health insurance products and decreases in net earnings for life and long-term care insurance products (excluding, in each case, the effect of any discontinuation of goodwill amortization). The increase in payment protection insurance was primarily attributable to dividends received deduction benefits and certain foreign tax benefits. The increase in group life and health insurance was primarily attributable to favorable experience in our long-term disability product. The decrease in life insurance was primarily attributable to the impact of the recognition in 2001 of deferred policy fees and the term life insurance in-force reinsurance transaction. The decrease in long-term care insurance was primarily attributable to an increase in claims volume.

#### Retirement Income and Investments segment

The following table presents the historical and pro forma results of operations relating to our Retirement Income and Investments segment. The pro forma financial information reflects adjustments to give effect to the reinsurance transactions in which we will cede to UFLIC our in-force blocks of structured settlements and substantially all of our in-force blocks of variable annuities. There were no pro forma adjustments to premiums because the structured settlements we will cede are single premium products and do not have renewal premiums. The variable annuity products we will cede are deposit contracts, and their deposits are not recorded as premiums. Pro forma revenues and expenses are lower than our historical revenues and expenses primarily as a result of the exclusion of revenues and expenses related to the reinsured blocks of variable annuities and structured settlements.

	Historical			Pro forma
	Years ended December 31,			Year ended December 31,
	2003	2002	2001	2003
(Dollar amounts in millions)				
Revenues:				
Premiums	\$ 1,045	\$ 991	\$ 1,023	\$ 1,045
Net investment income	2,511	2,522	2,482	1,563
Policy fees and other income	225	243	216	99
<b>Total revenues</b>	<b>3,781</b>	<b>3,756</b>	<b>3,721</b>	<b>2,707</b>
Benefits and expenses:				
Benefits and other changes in policy reserves	1,871	1,769	1,736	1,278
Interest credited	1,259	1,283	1,278	993
Underwriting, acquisition and insurance expenses, net of deferrals	232	221	187	182
Amortization of deferred acquisition costs and intangibles	190	210	181	113
<b>Total benefits and expenses</b>	<b>3,552</b>	<b>3,483</b>	<b>3,382</b>	<b>2,566</b>
Earnings before income taxes	229	273	339	141
Provision for income taxes	78	87	124	48
<b>Segment net earnings</b>	<b>\$ 151</b>	<b>\$ 186</b>	<b>\$ 215</b>	<b>\$ 93</b>

#### Year Ended December 31, 2003 Compared to Year Ended December 31, 2002

*Premiums.* Premiums increased \$54 million, or 5%, to \$1,045 million for the year ended December 31, 2003 from \$991 million for the year ended December 31, 2002. This increase was primarily the result of a \$92 million increase in premiums for life-contingent structured settlements that was attributable to higher sales of this product. This increase was offset in part by a \$31 million decrease in premiums for life-contingent income annuities that was primarily attributable to lower sales of this product resulting from a reduction of crediting and payout rates in 2003 in the lower interest rate environment.

*Net investment income.* Net investment income decreased \$11 million to \$2,511 million for the year ended December 31, 2003 from \$2,522 million for the year ended December 31, 2002. This decrease was primarily the result of declining yields on investments, which more than offset the impact of an increase in invested assets.

*Policy fees and other income.* Policy fees and other income decreased \$18 million, or 7%, to \$225 million for the year ended December 31, 2003 from \$243 million for the year ended December 31, 2002. This decrease was the result of a \$10 million decrease in commission income and an \$8 million decrease in fee income on annuities primarily attributable to lower equity values of the assets in our variable annuity separate accounts.

*Benefits and other changes in policy reserves.* Benefits and other changes in policy reserves increased \$102 million, or 6%, to \$1,871 million for the year ended December 31, 2003 from \$1,769 million for the year ended December 31, 2002. This increase was the result of a \$107 million increase in changes in policy reserves for structured settlements attributable to higher sales of this product.

*Interest credited.* Interest credited decreased \$24 million, or 2%, to \$1,259 million for the year ended December 31, 2003 from \$1,283 million for the year ended December 31, 2002. This decrease was primarily the result of lower credited rates on GICs and funding agreements attributable to the lower interest rate environment, offset in part by an increase in interest credited attributable to more variable annuity policyholders selecting the fixed account option on their contracts, on which we credit interest.

*Underwriting, acquisition, insurance and other expenses, net of deferrals.* Underwriting, acquisition, insurance and other expenses, net of deferrals increased by \$11 million, or 5%, to \$232 million for the year ended December 31, 2003 from \$221 million for the year ended December 31, 2002. This increase was primarily the result of an increase in general operating expenses, offset in part by an increase in deferrals of acquisition costs resulting from increased sales of variable annuities with bonus features, for which a portion of the benefit expense is deferred and amortized over the life of the product.

*Amortization of deferred acquisition costs and intangibles.* Amortization of deferred acquisition costs and intangibles decreased \$20 million, or 10%, to \$190 million for

the year ended December 31, 2003 from \$210 million for the year ended December 31, 2002. This decrease was primarily the result of the impact of a \$26 million increase in accelerated amortization of deferred acquisition costs in 2002 that was primarily attributable to lower equity valuations of assets in our variable annuity separate accounts.

*Provision for income taxes.* Provision for income taxes decreased \$9 million, or 10%, to \$78 million for the year ended December 31, 2003 from \$87 million for the year ended December 31, 2002. The effective tax rate was 34.1% and 31.9% for the year ended December 31, 2003 and 2002, respectively. This increase in effective tax rate was the result of the impact of higher dividends received deduction benefits related to separate account annuity products in 2002.

89

*Segment net earnings.* Segment net earnings decreased \$35 million, or 19%, to \$151 million for the year ended December 31, 2003 from \$186 million for the year ended December 31, 2002. This decrease in segment net earnings was primarily the result of lower policy fees and other income and declining yields on invested assets. The decrease in segment net earnings reflects decreases in net earnings for structured settlement, fixed annuity and GIC products and an increase in net earnings for variable annuity products. The decrease in structured settlements and GICs was primarily attributable to lower reinvestment rates. The decrease in fixed annuities was primarily attributable to higher amortization of deferred acquisition costs. The increase in variable annuities was primarily attributable to tax benefits resulting from higher dividend deductions on our separate accounts.

#### **Year Ended December 31, 2002 Compared to Year Ended December 31, 2001**

*Premiums.* Premiums decreased \$32 million, or 3%, to \$991 million for the year ended December 31, 2002 from \$1,023 million for the year ended December 31, 2001. This decrease was primarily the result of a \$185 million decrease in premiums for life-contingent structured settlements attributable to lower sales of these products. This decrease was offset in part by a \$151 million increase in premiums for income annuities attributable to higher sales.

*Net investment income.* Net investment income increased \$40 million, or 2%, to \$2,522 million for the year ended December 31, 2002 from \$2,482 million for the year ended December 31, 2001. This increase was primarily the result of an increase in invested assets, offset in part by declining yields on investments in the lower interest rate environment.

*Policy fees and other income.* Policy fees and other income increased \$27 million, or 13%, to \$243 million for the year ended December 31, 2002 from \$216 million for the year ended December 31, 2001. This increase was primarily the result of a \$39 million increase in fee income attributable to the acquisition of a small asset management company at the end of 2001. This increase was offset in part by a \$14 million decrease in fee income on variable annuities primarily attributable to lower equity values in our variable annuity separate accounts.

*Benefits and other changes in policy reserves.* Benefits and other changes in policy reserves increased \$33 million, or 2%, to \$1,769 million for the year ended December 31, 2002 from \$1,736 million for the year ended December 31, 2001. This increase was primarily the result of a \$186 million increase in changes in policy reserves that was attributable to higher sales of life-contingent income annuities. This increase was offset in part by a \$146 million reduction in changes in policy reserves established for structured settlements that was attributable to lower sales of structured settlements.

*Interest credited.* Interest credited increased \$5 million to \$1,283 million for the year ended December 31, 2002 from \$1,278 million for the year ended December 31, 2001. This increase was primarily the result of an increase in policyholder account balances attributable to higher sales of annuity products, including GICs, funding agreements, fixed annuities, income annuities and fixed accounts of variable annuities. This increase was offset in part by lower interest crediting rates, particularly on GICs and funding agreements, attributable to the lower interest rate environment.

*Underwriting, acquisition, insurance and other expenses, net of deferrals.* Underwriting, acquisition, insurance and other expenses, net of deferrals, increased \$34 million, or 18%, to \$221 million for the year ended December 31, 2002 from \$187 million for the year ended December 31, 2001. This increase was primarily the result of expenses attributable to the operations of a small asset management company that we acquired at the end of 2001.

*Amortization of deferred acquisition costs and intangibles.* Amortization of deferred acquisition costs and intangibles increased \$29 million, or 16%, to \$210 million for the year ended December 31, 2002 from \$181 million for the year ended December 31, 2001. This increase was primarily the result of an increase of \$26 million that was attributable to accelerated amortization of deferred acquisition costs for our variable annuity products associated with the decrease in separate account asset values resulting from declines in the equity markets.

90

*Provision for income taxes.* Provision for income taxes decreased \$37 million, or 30%, to \$87 million for the year ended December 31, 2002 from \$124 million for the year ended December 31, 2001. The effective tax rate was 31.9% and 36.6% for the years ended December 31, 2002 and 2001, respectively. This decrease in effective tax rate was the result of higher dividend received deduction benefits related to separate account annuity products, an increase in tax reserves related to the segment's products and the discontinuation of goodwill amortization in accordance with SFAS 142.

*Segment net earnings.* Segment net earnings decreased \$29 million, or 13%, to \$186 million for the year ended December 31, 2002 from \$215 million for the year ended December 31, 2001. This decrease in segment net earnings was primarily the result of declining yields on invested assets. The decrease in segment net earnings reflects decreases in net earnings for fixed and variable annuity and structured settlement products and an increase in net earnings for GIC products. The decrease in variable annuities was attributable to declining fee income associated with lower equity values of the assets in our separate accounts and accelerated amortization of deferred acquisition costs. The decrease for fixed annuities and structured settlements was primarily attributable to declining yields on investments. The increase in GICs was primarily attributable to growth in the in-force block.

#### **Mortgage Insurance segment**

The following table presents the historical results of operations relating to our Mortgage Insurance segment. The Mortgage Insurance segment's results of operations are not affected by any of the pro forma adjustments.

(Dollar amounts in millions)	Historical		
	Years ended December 31,		
	2003	2002	2001
Revenues:			
Premiums	\$ 716	\$ 677	\$ 698
Net investment income	218	231	227
Policy fees and other income	48	38	40

Total revenues	982	946	965
Benefits and expenses:			
Benefits and other changes in policy reserves	115	46	150
Underwriting, acquisition and insurance expenses, net of deferrals	299	233	180
Amortization of deferred acquisition costs and intangibles	37	39	51
Total benefits and expenses	451	318	381
Earnings before income taxes	531	628	584
Provision for income taxes	162	177	156
Segment net earnings	\$ 369	\$ 451	\$ 428

**Year Ended December 31, 2003 Compared to Year Ended December 31, 2002**

*Premiums.* Premiums increased \$39 million, or 6%, to \$716 million for the year ended December 31, 2003 from \$677 million for the year ended December 31, 2002. This increase was primarily the result of an \$88 million increase in premiums in our international mortgage insurance business, \$24 million of which was attributable to changes in foreign exchange rates. This increase in international premiums was offset in part by a \$26 million decrease in premiums in our U.S. mortgage insurance business that was primarily attributable to higher premiums ceded in captive reinsurance transactions and a \$23 million decrease in premiums that was primarily attributable to lower persistency resulting from increased refinancing activity.

*Net investment income.* Net investment income decreased \$13 million, or 6%, to \$218 million for the year ended December 31, 2003 from \$231 million for the year ended December 31, 2002. This

91

decrease was primarily the result of a \$42 million decrease in net investment income that was primarily attributable to a decrease in invested assets resulting from the payment of dividends by the U.S. mortgage insurance business to our holding company. The decrease was also the result of declining yields on investments. These decreases were offset in part by a \$29 million increase in net investment income resulting from additional invested assets in our international mortgage insurance business, \$10 million of which was due to changes in foreign exchange rates.

*Policy fees and other income.* Policy fees and other income increased \$10 million, or 26%, to \$48 million for the year ended December 31, 2003 from \$38 million for the year ended December 31, 2002. This increase was the result of a \$5 million increase in fees for contract underwriting services attributable to higher refinancing activity in the U.S. and a \$5 million increase in fees from increased volume in our international mortgage insurance business.

*Benefits and other changes in policy reserves.* Benefits and other changes in policy reserves increased \$69 million, or 150%, to \$115 million for the year ended December 31, 2003 from \$46 million for the year ended December 31, 2002. This increase was the result of a \$60 million increase primarily attributable to a lower amount of favorable loss development on prior year reserves and a \$9 million increase in paid claims on U.S. flow mortgage insurance offset in part by a \$4 million decrease primarily attributable to favorable loss development on U.S. bulk mortgage insurance, and a \$4 million increase primarily attributable to an increase in loans in default associated with higher insurance in force levels in our international mortgage insurance business.

*Underwriting, acquisition, insurance and other expenses, net of deferrals.* Underwriting, acquisition, insurance and other expenses, net of deferrals, increased \$66 million, or 28%, to \$299 million for the year ended December 31, 2003 from \$233 million for the year ended December 31, 2002. This increase was the result of a \$37 million increase in expenses that was primarily attributable to a significant increase in underwriting volume associated with refinancing activity in the U.S., an \$11 million increase attributable to higher indemnity liabilities for U.S. contract underwriting claims as the result of updating of the assumptions we used to calculate these indemnity liabilities to reflect recent underwriting experience and the increase in the volume of mortgage loans underwritten due to significant refinancing activity and a \$18 million increase attributable to continued investment in our international mortgage insurance business.

*Amortization of deferred acquisition costs and intangibles.* Amortization of deferred acquisition costs and intangibles decreased \$2 million, or 5%, to \$37 million for the year ended December 31, 2003 from \$39 million for the year ended December 31, 2002. This decrease was primarily the result of the amortization of a lower amount of U.S. deferred expenses, offset by the higher volume in our international mortgage insurance business.

*Provision for income taxes.* Provision for income taxes decreased \$15 million, or 8%, to \$162 million for the year ended December 31, 2003 from \$177 million for the year ended December 31, 2002. The effective tax rate was 30.5% and 28.2% for the year ended December 31, 2003 and 2002, respectively. This increase in effective tax rate was primarily the result of a greater proportion of foreign income taxed at a higher rate than in the U.S. Our Mortgage Insurance segment's effective tax rate is significantly below the statutory rate primarily as the result of tax-exempt investment income.

*Segment net earnings.* Segment net earnings decreased \$82 million, or 18%, to \$369 million for the year ended December 31, 2003 from \$451 million for the year ended December 31, 2002. This decrease was primarily the result of a \$141 million decrease in U.S. net earnings, offset in part by a \$59 million increase in international net earnings. The decrease in U.S. net earnings was primarily attributable to greater losses from less favorable loss development on prior year reserves, decreases in premiums from increased ceding and lower persistency, and increases in underwriting expenses from refinancing activity and contract underwriting indemnification liabilities as the result of our updating the assumptions used to calculate these indemnity liabilities to reflect recent underwriting experience

92

and increased volume. The increase in international net earnings was primarily the result of growth in our international mortgage insurance business.

**Year Ended December 31, 2002 Compared to Year Ended December 31, 2001**

*Premiums.* Premiums decreased \$21 million, or 3%, to \$677 million for the year ended December 31, 2002 from \$698 million for the year ended December 31, 2001. This decrease was primarily the result of a \$37 million decrease in premiums in our U.S. mortgage insurance business attributable to higher premiums ceded in captive reinsurance transactions. The decrease was also the result of a \$13 million decrease in premiums in our U.S. mortgage insurance business primarily attributable to lower persistency associated with increased refinancing activity in the U.S. These decreases were offset in part by a \$29 million increase in premiums primarily attributable to growth

in our international mortgage insurance business.

*Net investment income.* Net investment income increased \$4 million, or 2%, to \$231 million for the year ended December 31, 2002 from \$227 million for the year ended December 31, 2001. This increase was primarily the result of an \$11 million increase that was primarily attributable to an increase in invested assets in our international mortgage insurance business, offset in part by a \$7 million decrease that was primarily attributable to declining yields on U.S. investments in the lower interest rate environment.

*Policy fees and other income.* Policy fees and other income decreased \$2 million, or 5%, to \$38 million for the year ended December 31, 2002 from \$40 million for the year ended December 31, 2001. This decrease was primarily the result of the impact of a \$13 million gain recognized in 2001 on the sale of our flood zone determination business. This decrease was offset in part by an \$11 million increase in fees for contract underwriting services attributable to higher refinancing activity in the U.S.

*Benefits and other changes in policy reserves.* Benefits and other changes in policy reserves decreased \$104 million, or 69%, to \$46 million for the year ended December 31, 2002 from \$150 million for the year ended December 31, 2001. This decrease was the result of a \$73 million decrease primarily attributable to favorable loss development on prior year reserves on U.S. flow mortgage insurance. During 2002, we updated our loss reserve factors to reflect our recent favorable experience with respect to severity and frequency of defaults. Our severity and frequency of defaults were favorably affected by housing appreciation, increased housing supply and demand and other U.S. macroeconomic factors, in addition to our loss mitigation activities. This decrease was offset by an \$8 million increase in paid claims on U.S. flow mortgage insurance, a \$26 million decrease primarily attributable to favorable loss development on prior year reserves for U.S. bulk mortgage insurance and a \$13 million decrease primarily attributable to a lower number of loans in default and favorable loss development on prior-year reserves in our international mortgage business.

*Underwriting, acquisition, insurance and other expenses, net of deferrals.* Underwriting, acquisition, insurance and other expenses, net of deferrals, increased \$53 million, or 29%, to \$233 million for the year ended December 31, 2002 from \$180 million for the year ended December 31, 2001. This increase was primarily the result of a \$12 million increase attributable to growth in our international mortgage insurance business, a \$6 million increase in expenses in the U.S. primarily attributable to the significant increase in underwriting volume associated with higher refinancing activity, and the impact of a \$35 million decrease in 2001 for U.S. contract underwriting indemnification liabilities as the result of our updating of the assumptions we used to calculate these indemnity liabilities to reflect recent underwriting experience where loss experience was lower than we had anticipated.

*Amortization of deferred acquisition costs and intangibles.* Amortization of deferred acquisition costs and intangibles decreased \$12 million, or 24%, to \$39 million for the year ended December 31, 2002 from \$51 million for the year ended December 31, 2001. This decrease was primarily the result of our discontinuation of goodwill amortization in accordance with SFAS 142 and the amortization of a lower amount of U.S. deferred expenses.

*Provision for income taxes.* Provision for income taxes increased \$21 million, or 13%, to \$177 million for the year ended December 31, 2002 from \$156 million for the year ended December 31, 2001. The effective tax rate was 28.2% and 26.7% for the years ended December 31, 2002 and 2001, respectively. This increase in effective tax rate was primarily the result of a reduced benefit from tax-exempt investment income, a greater proportion of foreign income taxed at a higher rate than in the U.S., and the impact of the 2001 release of deferred income taxes to reflect a decrease in the tax rates in certain countries in which we operate.

*Segment net earnings.* Segment net earnings increased \$23 million, or 5%, to \$451 million for the year ended December 31, 2002 from \$428 million for the year ended December 31, 2001. This increase was primarily the result of a \$23 million increase in international net earnings and flat U.S. net earnings. The increase in international net earnings was primarily attributable to increases in earned premiums and net investment income and favorable loss development on prior year reserves, offset in part by increases in expenses related to such growth. Flat U.S. net earnings were primarily attributable to lower losses resulting from a decrease in loans in default and favorable loss development on prior-year reserves, offset by decreases in premiums from higher premiums ceded and lower persistency and increases in expenses as the result of our updating of the assumptions we used to calculate U.S. contract underwriting indemnification liabilities in 2001 to reflect recent underwriting experience.

#### Affinity segment

The following table presents the historical results of operations relating to the Affinity segment. Pro forma financial information is not presented for the Affinity segment because we will not acquire any of the Affinity segment businesses from GEFAHI.

(Dollar amounts in millions)	Historical		
	Years ended December 31,		
	2003	2002	2001
<b>Revenues:</b>			
Premiums	\$ 244	\$ 247	\$ 286
Net investment income	62	70	74
Policy fees and other income	260	271	327
<b>Total revenues</b>	<b>566</b>	<b>588</b>	<b>687</b>
<b>Benefits and expenses:</b>			
Benefits and other changes in policy reserves	196	180	188
Underwriting, acquisition and insurance expenses, net of deferrals	239	312	320
Amortization of deferred acquisition costs and intangibles	110	116	156
<b>Total benefits and expenses</b>	<b>545</b>	<b>608</b>	<b>664</b>
Earnings (loss) before income taxes	21	(20)	23
Provision (benefit) for income taxes	5	(17)	(1)
<b>Segment net earnings (loss)</b>	<b>\$ 16</b>	<b>\$ (3)</b>	<b>\$ 24</b>

#### Year Ended December 31, 2003 Compared to Year Ended December 31, 2002

*Total revenues.* Total revenues decreased \$22 million, or 4%, to \$566 million for the year ended December 31, 2003 from \$588 million for the year ended December 31, 2002. This decrease was primarily the result of lower premiums and other income attributable to our decision to discontinue certain products and distribution relationships that did not meet our target return thresholds. This decrease was offset in part by an increase in premiums attributable to a reinsurance transaction in which certain premiums were

ceded to us by the purchaser of a discontinued operation.

*Total benefits and expenses.* Total benefits and expenses decreased \$63 million, or 10%, to \$545 million for the year ended December 31, 2003 from \$608 million for the year ended

94

December 31, 2002. This decrease was primarily the result of our decision to discontinue certain products and distribution relationships and implement cost savings initiatives that reduced compensation and benefits, as well as other general expenses. Our decision to discontinue certain products and distribution relationships and implement cost savings initiatives also reduced our deferrable expenses, resulting in a decrease in amortization of deferred acquisition costs and intangibles. These decreases were offset in part by an increase in benefits and expenses attributable to a reinsurance transaction in which certain benefits and expenses were ceded to us by the purchaser of a discontinued operation.

*Provision (benefit) for income taxes.* Provision (benefit) for income taxes increased \$22 million to \$5 million for the year ended December 31, 2003 from \$(17) million for the year ended December 31, 2002. This increased provision was the result of a foreign loss valuation allowance.

*Segment net earnings (loss).* Segment net earnings (loss) increased \$19 million to \$16 million for the year ended December 31, 2003 from \$(3) million for the year ended December 31, 2002. This increase was primarily the result of our discontinuation of products and distribution relationships that did not meet our target return thresholds and reductions of compensation and benefit expenses and other general expenses resulting from cost savings initiatives.

#### **Year Ended December 31, 2002 Compared to Year Ended December 31, 2001**

*Total revenues.* Total revenues decreased \$99 million, or 14%, to \$588 million for the year ended December 31, 2002 from \$687 million for the year ended December 31, 2001. This decrease was primarily the result of lower premiums and other income attributable to our decision to discontinue certain products and distribution relationships that did not meet our target return thresholds.

*Total benefits and expenses.* Total benefits and expenses decreased \$56 million, or 8%, to \$608 million for the year ended December 31, 2002 from \$664 million for the year ended December 31, 2001. This decrease was primarily the result of lower amortization of deferred acquisition costs and intangibles that was primarily attributable to an adjustment in the fourth quarter of 2002 to reflect actual membership lapse rate performance as compared with the lapse rates projected at the time of purchase. The decrease was also the result of reduced compensation and benefits, other cost-saving initiatives and decreased changes in policy reserves primarily attributable to lower revenues.

*Provision (benefit) for income taxes.* Provision (benefit) for income taxes decreased \$16 million to \$(17) million for the year ended December 31, 2002 from \$(1) million for the year ended December 31, 2001. This reduced provision was the result of our discontinuation of goodwill amortization in accordance with SFAS 142.

*Segment net earnings (loss).* Segment net earnings (loss) decreased \$27 million to \$(3) million for the year ended December 31, 2002 from \$24 million for the year ended December 31, 2001. This decrease was primarily the result of the decrease in revenues attributable to our discontinuance of products and distribution relationships that did not meet our target return thresholds.

#### **Corporate and Other segment**

The following table presents summary historical and pro forma financial results of operations relating to our Corporate and Other segment for the periods below. The pro forma financial information reflects adjustments described under "Selected Historical and Pro Forma Financial Information." There were no pro forma adjustments to premiums or policy fees and other income because there are no premiums or policy fees and other income in the Corporate and Other segment that will be ceded to UFLIC in connection with the reinsurance transactions. Pro forma net investment income increased as a result of net investment income earned on excess surplus assets that will be transferred from the Protection and Retirement Income and Investments segments to the Corporate and Other segment, offset in part by a decrease attributable to reduced net investment income related to the \$1.836 billion capital contribution that we will make to UFLIC. Pro forma total revenues increased primarily as a result of the adjustments to net investment income as described, and the

95

exclusion from our results of operations of net realized investment gains (losses) related to the long-term care insurance, structured settlement and variable annuity products we will cede to UFLIC in connection with the reinsurance transactions and net realized investment gains (losses) related to the Affinity segment. Pro forma total expenses were primarily affected by the inclusion of incremental interest expense attributable to our revised debt structure after the completion of this offering.

(Dollar amounts in millions)	Historical			Pro forma
	Years ended December 31,			Year ended
	2003	2002	2001	December 31,
	2003	2002	2001	2003
<b>Revenues:</b>				
Premiums	\$ 110	\$ 104	\$ 90	\$ 110
Net investment income (loss)	25	20	(7)	55
Net realized investment gains	10	204	201	38
Policy fees and other income	44	6	1	44
<b>Total revenues</b>	<b>189</b>	<b>334</b>	<b>285</b>	<b>247</b>
<b>Expenses:</b>				
Unallocated corporate expenses	121	77	69	121
Interest expense	137	124	126	135
Other operating expenses	88	60	54	84
<b>Total expenses</b>	<b>346</b>	<b>261</b>	<b>249</b>	<b>340</b>
Earnings (loss) before income taxes	(157)	73	36	(93)



Provision (benefit) for income taxes	(103)	(119)	10	(85)
Segment net earnings (loss)	\$ (54)	\$ 192	\$ 26	\$ (8)

**Year Ended December 31, 2003 Compared to Year Ended December 31, 2002**

*Premiums.* Premiums increased \$6 million, or 6%, to \$110 million for the year ended December 31, 2003 from \$104 million for the year ended December 31, 2002. This increase was primarily the result of a \$4 million increase in premiums attributable to our Mexican auto insurer.

*Net investment income (loss).* Net investment income (loss) increased \$5 million, or 25%, to \$25 million for the year ended December 31, 2003 from \$20 million for the year ended December 31, 2002.

*Net realized investment gains.* See the comparison for this line item under "—Historical Combined and Pro Forma Results of Operations."

*Policy fees and other income.* Policy fees and other income increased \$38 million to \$44 million for the year ended December 31, 2003 from \$6 million for the year ended December 31, 2002. This increase was primarily attributable to interest income from two securitization entities that were consolidated in our financial statements in connection with our adoption of FIN 46, beginning in the third quarter of 2003. See "—Off-Balance-Sheet Transactions."

*Unallocated corporate expenses.* Unallocated corporate expenses primarily consist of general and other expenses that are not allocated for segment reporting purposes. These amounts include items such as class-action litigation settlements, advertising and marketing costs, severance and restructuring charges and other corporate-level expenses. Unallocated corporate expenses increased \$44 million, or 57%, to \$121 million for the year ended December 31, 2003 from \$77 million for the year ended December 31, 2002. This increase was primarily the result of a \$50 million increase in litigation reserves attributable to an increase in reserves for a settlement in principle that we reached in October 2003 in connection with class action litigation relating to sales practices in our life insurance business. See "Business—Legal Proceedings."

96

*Interest expense.* Interest expense consists of interest and other financing charges related to all of our holding company debt that is not allocated for segment reporting purposes. Interest expense increased \$13 million, or 10%, to \$137 million for the year ended December 31, 2003 from \$124 million for the year ended December 31, 2002. This increase was primarily the result of \$27 million of interest expense associated with securitization entities that were consolidated in our financial statements in connection with our adoption of FIN 46, beginning in the third quarter of 2003. This increase was offset in part by a \$14 million decrease in interest expense that was primarily the result of lower average borrowings.

*Other operating expenses.* Other operating expenses primarily consist of benefits and other changes in policy reserves and general expenses of several small non-core businesses that are managed in our Corporate and Other segment. Other operating expenses increased \$28 million, or 47%, to \$88 million for the year ended December 31, 2003 from \$60 million for the year ended December 31, 2002. This increase was primarily the result of higher expenses of our Bermuda reinsurer primarily attributable to the impact of a 2002 novation of a portion of its leased equipment physical damage program to a third party, offset in part by the impact of the recognition in 2002 of \$5 million of goodwill impairment for our Mexican auto insurance business resulting from our implementation of SFAS 142.

*Provision (benefit) for income taxes.* Provision (benefit) for income taxes decreased \$16 million to \$(103) million for the year ended December 31, 2003 from \$(119) million for the year ended December 31, 2002. This decrease was the result of the recognition in 2002 of a favorable settlement with the IRS related to the treatment of certain reserves for obligations to policyholders of life insurance contracts, offset in part by lower pre-tax earnings, a one-time reduction in UK taxes related to the restructuring of our UK legal entities, and increased dividends received deduction benefits. Changes to tax expense for our Corporate and Other segment are primarily the result of tax-exempt investment income and other items not directly allocated to specific products or segments.

*Segment net earnings (loss).* Segment net earnings (loss) decreased \$246 million to \$(54) million for the year ended December 31, 2003 from \$192 million for the year ended December 31, 2002. This decrease was primarily the result of the decrease in benefit for income taxes attributable to the impact of the 2002 favorable settlement with the IRS, the decrease in net realized investment gains and higher litigation reserves for the year ended December 31, 2003.

**Year Ended December 31, 2002 Compared to Year Ended December 31, 2001**

*Premiums.* Premiums increased \$14 million, or 16%, to \$104 million for the year ended December 31, 2002 from \$90 million for the year ended December 31, 2001. This increase was the result of a \$9 million increase in premiums from our Mexican auto insurer and a \$5 million increase in premiums from our Bermuda reinsurer.

*Net investment income (loss).* Net investment income (loss) increased \$27 million to \$20 million for the year ended December 31, 2002 from \$(7) million for the year ended December 31, 2001. This increase was primarily the result of higher income on private equity investments reflecting stabilization in the equity markets.

*Net realized investment gains (losses).* See the comparison for this line item under "—Historical Combined and Pro Forma Results of Operations."

*Policy fees and other income.* Policy fees and other income increased \$5 million to \$6 million for the year ended December 31, 2002 from \$1 million for the year ended December 31, 2001. This increase was primarily the result of fee income attributable to a securitization of certain financial assets and an increase in policy fees from our Mexican auto insurer.

*Unallocated corporate expenses.* Unallocated corporate expenses increased \$8 million, or 12%, to \$77 million for the year ended December 31, 2002 from \$69 million for the year ended December 31, 2001. This increase was primarily the result of costs incurred to close certain facilities resulting from relocations to Richmond, Virginia.

97

*Interest expense.* Interest expense decreased \$2 million, or 2%, to \$124 million for the year ended December 31, 2002 from \$126 million for the year ended December 31, 2001. This decrease was primarily the result of lower interest rates on borrowings, offset in part by an increase in average borrowings.

*Other operating expenses.* Other operating expenses increased \$6 million, or 11%, to \$60 million for the year ended December 31, 2002 from \$54 million for the year ended December 31, 2001. This increase was primarily the result of a goodwill impairment charge recorded in connection with the adoption of SFAS 142.

*Provision (benefit) for income taxes.* Provision (benefit) for income taxes decreased \$129 million to \$(119) million for year ended December 31, 2002 from \$10 million for the year ended December 31, 2001. This decrease was the result of a favorable settlement with the IRS regarding the treatment of certain reserves for obligations to life insurance policyholders and reduced benefit from tax exempt investment income, offset in part by higher pre-tax earnings.

*Segment net earnings.* Segment net earnings increased \$166 million to \$192 million for the year ended December 31, 2002 from \$26 million for the year ended December 31, 2001. This increase was primarily the result of the decrease in the provision for income taxes attributable to the 2002 favorable settlement with the IRS and higher net investment income primarily resulting from higher income on private equity investments reflecting stabilization in equity markets.

## Liquidity and Capital Resources

After the completion of this offering, we will conduct all our operations through our operating subsidiaries. Dividends from our subsidiaries and permitted payments to us under our tax sharing arrangements with our subsidiaries will be our principal sources of cash to pay stockholder dividends and to meet our obligations.

Our primary uses of funds at our holding company level include payment of general operating expenses, payment of principal, interest and other expenses related to holding company debt, payment of dividends on our common and preferred stock, amounts we will owe to GE under the Tax Matters Agreement contract, adjustment payments on our Equity Units, contributions to subsidiaries, and, potentially, acquisitions. We intend to pay quarterly cash dividends on our common stock at an initial rate of \$ per share. The first such dividend will be declared in the third quarter of 2004 and paid in the fourth quarter. However, the declaration and payment of future dividends to holders of our common stock will be at the discretion of our board of directors. In addition, our payment of dividends to our stockholders will depend partly upon our receipt of dividends from our insurance and other operating subsidiaries. In addition, our Series A Preferred Stock will bear dividends at an annual rate of % of the liquidation value of \$50 per share. We also have agreed to pay quarterly contract adjustment payments with respect to our Equity Units at an annual rate of % of the stated amount of \$25 per Equity Unit.

On December 15, 2003, we paid a dividend of \$2,930 million. This included the distribution of proceeds from the sale of our Japanese life insurance and domestic auto and homeowners' insurance businesses, which closed on August 29, 2003, and other dividends received from our insurance subsidiaries. We declared and paid dividends of \$3,168 million to our parent during 2003. We declared dividends of \$171 million to our parent during 2002, of which \$107 million was paid in 2002 and \$64 million was paid in 2003. We declared dividends of \$31 million in 2001, of which \$6 million was paid in 2001 and \$25 million was paid in 2002.

The payment of dividends and other distributions to us by our insurance subsidiaries is regulated by insurance laws and regulations. In general, dividends in excess of prescribed limits are deemed "extraordinary" and require insurance regulatory approval. See "Regulation." During the years ended December 31, 2003, 2002 and 2001, we received dividends from our insurance subsidiaries of \$1,472 million (\$1,400 million of which were deemed "extraordinary"), \$840 million (\$375 million of which were deemed "extraordinary") and \$410 million (none of which were deemed "extraordinary"),

98

---

respectively. In addition, during the years ended December 31, 2003, 2002 and 2001, we received dividends from insurance subsidiaries related to discontinued operations of \$495 million, \$62 million and \$0, respectively.

Based on statutory results as of December 31, 2003, our subsidiaries could pay dividends of \$1,121 million to us in 2004 without obtaining regulatory approval. However, as a result of the dividends we will pay in connection with our corporate reorganization, most of our insurance subsidiaries will not be able to pay us any additional dividends for the twelve months following this offering without prior regulatory approval. As part of our corporate reorganization, we will retain cash at the holding company level which we believe will be adequate to fund our dividend payments, debt service, obligations under the Tax Matters Agreement and other obligations until our insurance subsidiaries can resume paying ordinary dividends to us. In addition, the ability of our insurance subsidiaries to pay dividends to us, and our ability to pay dividends to our stockholders, are also subject to various conditions imposed by the rating agencies for us to maintain our ratings.

In addition to dividends from our insurance subsidiaries, our other sources of funds will include service fees we receive from GE, as described under "—Overview—Separation from GE and related financial arrangements—Services provided to GE," payments from our subsidiaries pursuant to tax sharing arrangements that we will enter into after the completion of this offering, borrowings pursuant to credit facilities that we intend to establish shortly after the completion of this offering, and proceeds from the offering of senior notes and the sale of commercial paper, which we intend to complete shortly after the completion of this offering.

In consideration for the assets that we will acquire and the liabilities that we will assume in connection with our corporate reorganization, we will issue to GEFAHI million shares of our Class B Common Stock, \$600 million of our Equity Units, \$100 million of our Series A Preferred Stock, the \$2.4 billion Short-term Intercompany Note and the \$550 million Contingent Note. The Short-term Intercompany Note matures on , 2004. The Contingent Note is a non-interest-bearing note that matures on the first anniversary of the completion of this offering and will be repaid solely to the extent that statutory contingency reserves from our U.S. mortgage insurance business in excess of \$150 million are released and paid to us as a dividend. Under applicable insurance regulations, annual additions to the statutory contingency reserves must equal at least 50% of premiums earned, and these statutory reserves generally cannot be withdrawn for 10 years. We believe that the significant refinancing activity in the U.S. in recent years has resulted in significant excess statutory contingency reserves because an unusually large number of mortgages are being refinanced before they reach the time they historically are most likely to become delinquent. We intend to seek the accelerated release of a portion of these statutory reserves to repay the Contingent Note. The release of the statutory reserves and payment of the dividend by our U.S. mortgage insurance business to us are subject to statutory limitations, regulatory approval and the absence of any impact on our financial ratings. If regulatory approval has been obtained by the first anniversary date, but our financial ratings have not been affirmed, the term of the Contingent Note will be extended for a period up to twelve months to obtain affirmation of our financial ratings. Any portion of the Contingent Note that is not repaid by the first anniversary of the completion of this offering or by the extended term, if applicable, will be canceled. We will record any portion of the Contingent Note that is canceled as a capital contribution. See "Description of Certain Indebtedness—Contingent Note."

The liabilities we will assume from GEFAHI include the Yen Notes, which are ¥60 billion aggregate principal amount of 1.6% notes due 2011 issued by GEFAHI, ¥3 billion of which GEFAHI currently holds and will transfer to us. We have entered into arrangements to swap our obligations under these notes to a U.S. dollar obligation with a principal amount of \$491 million and bearing interest at a rate of 4.84% per annum. See "Description of Certain Indebtedness—Yen Notes." We also will be entering into a Tax Matters Agreement with GE, which represents an obligation by us to GE, estimated to have a present value of approximately \$423 million. See "Arrangements Between GE and Our Company—Tax Matters Agreement."

99

---

We intend to repay the \$2.4 billion Short-term Intercompany Note to GEFAHI with proceeds from the borrowings under a \$2.4 billion short-term credit facility that we intend to establish with a syndicate of banks concurrently with the completion of this offering. We intend to repay the borrowings under this short-term credit facility with proceeds from the issuance of approximately \$1.9 billion in senior notes and approximately \$500 million in commercial paper, both of which we intend to complete shortly after the completion of this offering. The senior notes are expected to consist of multiple series with varying maturities. The commercial paper will be issued under a \$1 billion commercial paper program we intend to establish. We may issue additional commercial paper under this program from time to time. We will enter into \$2 billion of revolving credit facilities, including a \$1 billion 364-day facility and a \$1 billion five-year facility. The revolving credit facilities will support our commercial paper program and will provide us with liquidity to meet general funding requirements. See "Description of Certain Indebtedness." However, our ability to borrow under these facilities and to issue commercial paper in excess of \$500 million may be subject to GE's right as the holder of the Class B Common Stock to approve our incurrence of debt in excess of \$700 million outstanding at any one time. See "Description of Capital Stock—Approval Rights of Holders of Class B Common Stock."

We believe the proposed senior notes and commercial paper offerings and credit facilities, together with anticipated cash flows from operations, will provide us with sufficient liquidity to meet our operating requirements for the foreseeable future.

Net cash provided by operating activities was \$3,716 million, \$4,883 million and \$2,229 million for the years ended December 31, 2003, 2002 and 2001, respectively. Cash flows from operating activities are affected by the timing of premiums received, fees received and investment income. Cash provided by operating activities decreased \$1,167 million for the year ended December 31, 2003, compared to the year ended December 31, 2002. During both periods, principal sources of cash included sales of income annuities with life contingencies and long-term care insurance, as well as sales of structured settlements with life contingencies and term-life insurance. Cash provided by operating activities decreased primarily because of a payment of \$440 million during the fourth quarter of 2003 of intercompany balances due to GE Capital included in other liabilities. Cash provided by operating activities increased \$2,654 million for the year ended December 31, 2002, compared to the year ended December 31, 2001, primarily reflecting growth in sales of the products discussed above, as well as the timing of cash settlement for other assets and liabilities.

As an insurance business, we typically generate positive cash flows from operating and financing activities, as premiums and deposits collected from our insurance and investment products exceed benefits paid and redemptions, and we invest the excess. Accordingly, in analyzing our cash flow we focus on the change in the amount of cash available and used in investing activities. Net cash used in investing activities was \$681 million, \$6,525 million and \$7,068 million for the years ended December 31, 2003, 2002, and 2001, respectively.

The decrease in net cash used in investing activities for the year ended December 31, 2003, compared to the year ended December 31, 2002, of \$5,844 million was the result of both less cash provided by operating activities of \$1,167 million, as discussed above, and more cash used in financing activities of \$5,007 million. Within our investing activities, during 2003, we received \$2,126 million of proceeds and dividends associated with the sale of our Japanese life insurance and domestic auto and homeowners' insurance businesses.

Net cash (used in) provided by financing activities was (\$2,714) million, \$2,293 million and \$4,627 million for the years ended December 31, 2003, 2002 and 2001, respectively. The increase in cash used by financing activities for the year ended December 31, 2003, compared to the year ended December 31, 2002, of \$5,007 million was primarily the result of both lower deposits and higher redemptions of investment contracts, as a result of the lower interest rate environment, equity market downturns and volatility and pricing actions we took. These factors contributed to an increase in the use of net cash from investment contracts by \$3,202 million. In addition, dividends paid to our stockholder, net of capital contributions received, increased by \$2,871 million. These increased uses of cash were partially offset by a net increase in cash provided from borrowings of \$1,066 million,

100

---

consisting of a net increase in short-term borrowings, including commercial paper, of \$466 million, and an increase in non-recourse funding obligations of \$600 million.

For the year ended December 31, 2002, compared to the year ended December 31, 2001, the \$543 million decrease in cash used in investing activities resulted from reduced cash provided by financing activities, primarily from both lower sales and higher redemptions of investment contracts, as a result of the lower interest rate environment and customer uncertainty about the direction of equity markets, combined with pricing actions we took, reducing the net cash provided from investment contracts by \$2,155 million, along with a greater increase in cash and cash equivalents of \$863 million. These decreases in sources of cash available for investment were partially offset by the increase in net cash provided by operating activities of \$2,654 million, as discussed above.

The liquidity requirements of our insurance subsidiaries principally relate to the liabilities associated with their various insurance and investment products, operating costs and expenses, the payment of dividends to us, contributions to their subsidiaries, payment of principal and interest on their outstanding debt obligations and income taxes. Liabilities arising from insurance and investment products include the payment of benefits, as well as cash payments in connection with policy surrenders and withdrawals, policy loans and obligations to redeem funding agreements under applicable put option provisions.

Historically, our insurance subsidiaries have used cash flow from operations and sales of investment securities to fund their liquidity requirements. Our insurance subsidiaries' principal cash inflows from operating activities derive from premiums, annuity deposits and policy and contract fees and other income, including commissions, cost of insurance, mortality, expense and surrender charges, contract underwriting fees, investment management fees, and dividends and distributions from their subsidiaries. The principal cash inflows from investment activities result from repayments of principal, sales of invested assets and investment income.

We also have entered into annually renewable floating rate funding agreements, which are deposit-type products that generally credit interest on deposits at a floating rate tied to an external market index. Purchasers of annually renewable funding agreements include money market funds, bank common trust funds and other short-term investors. Some of our funding agreements contain "put" provisions, through which the contractholder has an option to terminate the funding agreement for any reason after giving notice within the contract's specified notice period, which is generally 90 days but can be less than 30 days. GE Capital has agreed to guarantee our obligations under certain annually renewable funding agreements that were issued prior to November 18, 2003 and certain renewals with a final maturity on or before June 30, 2005. As of December 31, 2003, the aggregate amount of outstanding funding agreements with put option features was approximately \$2.4 billion, of which those with put option notice periods of 30 days or less was \$450 million.

Our insurance subsidiaries maintain investment strategies intended to provide adequate funds to pay benefits without forced sales of investments. Products having liabilities with longer durations, such as certain life insurance and long-term care insurance policies, are matched with investments having similar estimated lives such as long-term fixed maturities and mortgage loans. Shorter-term liabilities are matched with fixed maturities that have short- and medium-term fixed maturities. In addition, our insurance subsidiaries hold highly liquid, high-quality short-term investment securities and other liquid investment-grade fixed maturities to fund anticipated operating expenses, surrenders, and withdrawals. On a pro forma basis, as of December 31, 2003, our total cash and investment securities were \$61.3 billion. Our investments in privately placed fixed maturities, mortgage loans, policy loans, limited partnership interests, real estate and restricted investments held by securitization entities are relatively illiquid. These asset classes represented approximately 30% of the carrying value of our total cash and invested assets as of December 31, 2003, on a pro forma basis.

Total assets decreased \$14.0 billion, or 12%, on an historical combined basis, from \$117.4 billion as of December 31, 2002 to \$103.4 billion as of December 31, 2003. The decrease primarily resulted from the sale of our Japanese life insurance and domestic auto and homeowners' insurance businesses, which had total assets of \$22.1 billion classified as assets held for sale as of December 31, 2002. Excluding

101

---

this sale, total assets would have increased \$8.1 billion, or 8%. Total investments increased \$6.6 billion, or 9%, on an historical combined basis, for the same comparison period, primarily reflecting net purchases of securities. Excluding investments and the sale of our Japanese life insurance and domestic auto and homeowners' insurance businesses, all other assets increased \$1.5 billion, or 7%, over the same period, primarily resulting from a \$760 million increase in separate account assets.

Pro forma total assets were \$97.9 billion as of December 31, 2003, compared to \$103.4 billion on an historical combined basis. The decrease was primarily attributable to \$2.8 billion of assets that will not be transferred to us in connection with our corporate reorganization and a \$2.8 billion net decrease in assets in connection with the reinsurance transactions with UFLIC.

Total liabilities decreased \$13.0 billion, or 13%, on an historical combined basis, from \$100.6 billion as of December 31, 2002 to \$87.6 billion as of December 31, 2003. This decrease primarily resulted from the sale of GEFAHI's Japanese life insurance and domestic auto and homeowners' insurance businesses, which had total liabilities of \$20.0 billion classified as liabilities associated with assets held for sale as of December 31, 2002. Excluding this sale, total liabilities would have increased \$7.0 billion, or 9%.

Future annuity and contract benefits increased \$2.7 billion, or 5%, primarily as a result of growth in our annuity and long-term care businesses. The increase also included a \$760 million increase in separate account liabilities and a \$1.1 billion increase of liabilities associated with the consolidation of certain securitization entities in the third quarter of 2003 in accordance with FIN 46.

Pro forma total liabilities were \$86.9 billion as of December 31, 2003, compared to \$87.6 billion on an historical combined basis. The decrease was primarily attributable to \$3.5 billion of liabilities that will not be transferred to us in connection with our corporate reorganization. The decrease was also attributable to \$669 million of liabilities associated with reinsurance transactions with UFLIC primarily consisting of a \$657 million decrease in deferred income taxes. These decreases were partially offset by \$3.4 billion of liabilities incurred in connection with our corporate reorganization, consisting primarily of \$600 million of our Equity Units, \$100 million of our Series A Preferred Stock, which is mandatorily redeemable, the \$2.4 billion Short-term Intercompany Note and the \$550 million Contingent Note, partially offset by a net reduction in liabilities of \$313 million attributable to the joint tax election with GE under section 338(h)(10) less the liability for amounts due to GE under the Tax Matters Agreement related to this election.

### **Contractual obligations**

We enter into long-term obligations to third-parties in the ordinary course of our operations. These obligations, as of December 31, 2003, on a pro forma basis, are set forth in the table below. However, we do not believe that our cash flow requirements can be assessed based upon an analysis of these obligations. The most significant factor affecting our future cash flows is our ability to earn and collect cash from our customers. Future cash outflows, whether they are contractual obligations or not, also will vary based upon our future needs. Although some outflows are fixed, others depend on future events. Examples of fixed obligations include our obligations to pay principal and interest on fixed-rate borrowings. Examples of obligations that will vary include obligations to pay interest on variable-rate borrowings and insurance liabilities that depend on future interest rates and market performance. Many of our obligations are linked to cash-generating contracts. These obligations include payments to contractholders that assume those contractholders will continue to make deposits in accordance with

102

the terms of their contracts. In addition, our operations involve significant expenditures that are not based upon "commitments." These include expenditures for income taxes and payroll.

#### **Pro forma payments due by period**

(Dollar amounts in millions)	Total	2004	2005-2006	2007-2008	2009 and thereafter
Borrowings(1)	\$ 4,836	\$ —	\$ 2,950	\$ —	\$ 1,886
Operating lease obligations	215	48	62	78	27
Purchase obligations(2)	9	8	1	—	—
Insurance liabilities(3)	16,264	6,199	5,694	2,467	1,904
Other contractual liabilities(4)	645	23	69	83	470
<b>Total contractual obligations</b>	<b>\$ 21,969</b>	<b>\$ 6,278</b>	<b>\$ 8,776</b>	<b>\$ 2,628</b>	<b>\$ 4,287</b>

- (1) Includes our existing non-recourse funding obligations, long-term borrowings and new borrowings described in notes (i) and (m) to our pro forma financial information, included under "Selected Historical and Pro Forma Financial Information."
- (2) Includes contractual minimum programming commitments; excludes funding commitments and items described in note (o) to our pro forma financial information.
- (3) Primarily includes guaranteed investment contracts and funding agreements, structured settlements and income annuities (including contracts we will reinsure to UFLIC, because we remain the primary obligor under those contracts), based upon scheduled payouts; excludes insurance liabilities that do not have maturity dates.
- (4) Because their future cash outflows are uncertain, the following non-current liabilities are excluded from this table: deferred taxes (except the Tax Matters Agreement, which is included, as described in note (k) to our pro forma financial information), derivatives, deferred revenue and certain other items.

### **Impairments of investment securities**

We regularly review investment securities for impairment in accordance with our impairment policy, which includes both quantitative and qualitative criteria. Quantitative measures include length of time and amount that each security position is in an unrealized loss position, and for fixed maturities, whether the issuer is in compliance with terms and covenants of the security. Our qualitative criteria include the financial strength and specific prospects for the issuer as well as our intent to hold the security until recovery. Our impairment reviews involve our finance and risk teams as well as the portfolio management and research capabilities of GEAM. Our qualitative review attempts to identify those issuers with a greater than 50% chance of default in the coming twelve months. These securities are characterized as "at-risk" of impairment. As of December 31, 2003, securities "at risk" of impairment had aggregate unrealized losses of \$40 million.

For fixed maturities, we recognize an impairment charge to earnings in the period in which we determine that we do not expect either to collect principal and interest in accordance with the contractual terms of the instruments or to recover based upon underlying collateral values, considering events such as a payment default, bankruptcy or disclosure of fraud. For equity securities, we recognize an impairment charge in the period in which we determine that the security will not recover to book value within a reasonable period. We determine what constitutes a reasonable period on a security-by-security basis based upon consideration of all the evidence available to us, including the magnitude of an unrealized loss and its duration. In any event, this period does not exceed 18 months for common equity securities. We measure impairment charges based upon the difference between the book value of a security and its fair value. Fair value is based upon quoted market price, except for certain infrequently traded securities where we estimate values using internally developed pricing models. These models are based upon common valuation techniques and require us to make assumptions regarding credit quality, liquidity and other factors that affect estimated values. The carrying value of infrequently traded securities as of December 31, 2003 was \$14.1 billion.

103

In the years ended December 31, 2003, 2002 and 2001, we recognized impairment losses of \$224 million, \$343 million and \$289 million, respectively. We generally intend to hold securities in unrealized loss positions until they recover. However, from time to time, we sell securities in the ordinary course of managing our portfolio to meet diversification, credit quality, yield and liquidity requirements. In the year ended December 31, 2003, the pre-tax realized investment loss incurred on the sale of fixed maturities and equity securities was \$239 million. The aggregate fair value of securities sold during that year was \$5,220 million, which was approximately 96% of book value.

The following tables present the gross unrealized losses and estimated fair values of our investment securities, on an historical basis, aggregated by investment type and length of time that individual investment securities have been in a continuous unrealized loss position, as of December 31, 2003:

Less Than 12 Months						
(Dollar amounts in millions)	Amortized cost or cost	Estimated fair value	Gross unrealized losses	% underwater	# of securities	
<b>Fixed maturities:</b>						
U.S. government and agencies	\$ 228	\$ 210	\$ (18)	7.9%	11	
State and municipal	119	118	(1)	0.8%	31	
Government—non U.S.	501	493	(8)	1.6%	142	
U.S. corporate (including public utilities)	5,948	5,738	(210)	3.5%	458	
Corporate—non U.S.	1,573	1,530	(43)	2.7%	198	
Asset backed	914	900	(14)	1.5%	95	
Mortgage backed	2,065	2,001	(64)	3.1%	247	
Subtotal, fixed maturities	11,348	10,990	(358)	3.2%	1,182	
Equity securities	53	51	(2)	3.8%	58	
<b>Total temporarily impaired securities</b>	<b>\$ 11,401</b>	<b>\$ 11,041</b>	<b>\$ (360)</b>	<b>3.2%</b>	<b>1,240</b>	
<b>% Underwater—fixed maturities:</b>						
<20% Underwater	\$ 11,219	\$ 10,898	\$ (321)	2.9%	1,144	
20-50% Underwater	128	92	(36)	28.1%	24	
>50% Underwater	1	—	(1)	100.0%	14	
Total fixed maturities	11,348	10,990	(358)	3.2%	1,182	
<b>% Underwater—equity securities:</b>						
<20% Underwater	53	51	(2)	3.8%	40	
20-50% Underwater	—	—	—	—	9	
>50% Underwater	—	—	—	—	9	
Total equity securities	53	51	(2)	3.8%	58	
<b>Total temporarily impaired securities</b>	<b>\$ 11,401</b>	<b>\$ 11,041</b>	<b>\$ (360)</b>	<b>3.2%</b>	<b>1,240</b>	
Investment grade	\$ 10,471	\$ 10,185	\$ (286)	2.7%	1,032	
Below investment grade	810	739	(71)	8.8%	141	
Not rated—fixed maturities	67	66	(1)	1.5%	9	
Not rated—equities	53	51	(2)	3.8%	58	
<b>Total temporarily impaired securities</b>	<b>\$ 11,401</b>	<b>\$ 11,041</b>	<b>\$ (360)</b>	<b>3.2%</b>	<b>1,240</b>	

104

12 Months or More						
(Dollar amounts in millions)	Amortized cost or cost	Estimated fair value	Gross unrealized losses	% underwater	# of securities	
<b>Fixed maturities:</b>						
U.S. government and agencies	\$ —	\$ —	\$ —	—	—	
State and municipal	1	1	—	—	1	
Government—non U.S.	12	12	—	—	6	
U.S. corporate (including public utilities)	1,084	975	(109)	10.1%	134	
Corporate—non U.S.	158	148	(10)	6.3%	30	
Asset backed	111	110	(1)	0.9%	9	
Mortgage backed	172	171	(1)	0.6%	19	
Subtotal, fixed maturities	1,538	1,417	(121)	7.9%	199	
Equity securities	49	43	(6)	12.2%	47	
<b>Total temporarily impaired securities</b>	<b>\$ 1,587</b>	<b>\$ 1,460</b>	<b>\$ (127)</b>	<b>8.0%</b>	<b>246</b>	

% Underwater—fixed maturities:

<20% Underwater	\$	1,439	\$	1,352	\$	(87)	6.0%	169
20-50% Underwater		92		63		(29)	31.5%	23
>50% Underwater		7		2		(5)	71.4%	7
Total fixed maturities		1,538		1,417		(121)	7.9%	199

% Underwater—equity securities:

<20% Underwater		26		25		(1)	3.8%	27
20-50% Underwater		23		18		(5)	21.7%	20
>50% Underwater		—		—		—	—	—
Total equity securities		49		43		(6)	12.2%	47

Total temporarily impaired securities \$ 1,587 \$ 1,460 \$ (127) 8.0% 246

Investment grade	\$	718	\$	691	\$	(27)	3.8%	90
Below investment grade		820		726		(94)	11.5%	109
Not rated—fixed maturities		—		—		—	—	—
Not rated—equities		49		43		(6)	12.2%	47

Total temporarily impaired securities \$ 1,587 \$ 1,460 \$ (127) 8.0% 246

The investment securities in an unrealized loss position for less than twelve months account for \$360 million, or 74%, of our total unrealized losses. Of the securities in this category, there were five securities with an unrealized loss in excess of \$5 million. These five securities had aggregate unrealized losses of \$30 million. The amount of the unrealized loss on these securities is driven primarily by the relative size of the holdings, the par values of which range from \$40 million to \$75 million.

The investment securities in an unrealized loss position for twelve months or more account for \$127 million, or 26%, of our total unrealized losses. There are 68 fixed-maturity securities in three industry groups that account for \$78 million or 61% of the unrealized losses in this category.

Forty-one of these 68 securities are in the transportation sector and are related to the airline industry. Ninety-nine percent of our airline securities are collateralized by commercial aircraft associated with five domestic airlines. The collateral underlying these securities consists of commercial jet aircraft. We believe these security holdings are in a loss position as a result of ongoing negative market reaction to difficulties in the commercial airline industry. In accordance with our impairment policy described above, we have recognized \$30 million and \$27 million in other-than-temporary impairments during 2003 and 2002, respectively, associated with the airline industry due to either bankruptcies or restructurings. These holdings were written down to estimated fair value based upon the present value of expected cash flows associated with revised lease terms or the value of the underlying aircraft. As of December 31, 2003 we expect to collect full principal and interest in accordance with the contractual terms of the instruments of our remaining holdings in airline securities. For those airline securities which we have previously impaired, we expect to recover our carrying amount based upon underlying aircraft collateral values.

Eighteen of these 68 securities are in the industrial sector and are primarily in the chemical and paper and timber products industries. Within this sector, there are two issuers, comprising five of the 18 securities, which represent \$17 million of the unrealized losses in this sector. Each of the other securities in this sector has unrealized losses of less than \$3 million. These two issuers, one of which is in the chemical industry and one of which is in the timber products industry, are current on all terms, show improving trends with regards to liquidity and security price and are not considered at risk of impairment. Our other holdings issued by the chemical company are in unrealized gain positions. Our other holdings issued by the timber products company are collateralized by assets, which provide greater than 100% coverage of the outstanding obligations based on the most recent valuations performed.

The remaining nine of these 68 securities are in the consumer-non cyclical sector and are primarily in the consumer products and retail industries. Within this sector, there is one issuer, comprising two of the nine securities, which represents \$13 million of the unrealized losses in this sector. This one issuer, a national retail chain, is current on all terms, shows improving trends with regard to liquidity and security price, and is not considered at risk of impairment. Our other holdings issued by this company are in unrealized gain positions. The remainder of the securities in this sector each have unrealized losses less than \$1 million.

In the remaining industry sectors, no single issuer of fixed-maturity securities has an unrealized loss greater than \$5 million.

The equity securities in an unrealized loss position for twelve months or more are preferred stocks with fixed maturity-like characteristics and mutual fund investments. No single security has an unrealized loss greater than \$5 million.

**Off-balance Sheet Transactions**

We have used off-balance sheet securitization transactions to mitigate and diversify our asset risk position and to adjust the asset class mix in our investment portfolio by reinvesting securitization proceeds in accordance with our approved investment guidelines.

We have not used securitization transactions to provide us with additional liquidity, and we do not anticipate using securitization transactions for that purpose in the future. The transactions we have used involved securitizations of some of our receivables and investments that were secured by commercial mortgage loans, fixed maturities or other receivables, consisting primarily of policy loans. Total securitized assets remaining as of December 31, 2003 and 2002 were \$1.6 billion and \$1.9 billion, respectively.

Securitization transactions resulted in net gains, before taxes, of approximately \$43 million, \$29 million and \$145 million for the years ended December 31, 2003, 2002 and 2001, respectively, and were included in net realized investment gains (losses) in our financial statements.

We have arranged for the assets that we have transferred in securitization transactions to be serviced by us directly, or pursuant to arrangements with GEAM and with General Motors Acceptance Corporation. Servicing activities include ongoing review, credit monitoring, reporting and collection activities.

We have entered into credit support arrangements in connection with our securitization transactions. Pursuant to these arrangements, as of December 31, 2003, we provided limited recourse for a maximum of \$119 million of credit losses. To date we have not been required to make any payments under any of the credit support agreements. These agreements will remain in place throughout the life of the related entities.

GE Capital, our indirect parent, provides credit and liquidity support to a funding conduit it sponsored, which exposes it to a majority of the risks and rewards of the conduit's activities and therefore makes GE Capital the primary beneficiary of the funding conduit. Upon adoption of FIN 46, GE Capital was required to consolidate the funding conduit because of this financial support. As a result, assets and liabilities of certain previously off-balance sheet securitization entities, for which we were the transferor, were required to be included in our financial statements because the funding conduit no longer qualified as a third party. Because these securitization entities lost their qualifying status, we were required to include \$1.2 billion of securitized assets and \$1.1 billion of associated liabilities in our Combined Statement of Financial Position in July 2003. The assets and liabilities associated with these securitization entities have been reported in the corresponding financial statement captions in our Combined Statement of Financial Position, and the assets are noted as restricted due to the lack of legal control we have over them. These balances will decrease as the assets mature because we will not sell any additional assets to these consolidated entities.

Our inclusion of these assets and liabilities does not change the economic or legal characteristics of the asset sales. Liabilities of these consolidated entities will be repaid with cash flows generated by the related assets. Credit recourse to us remains limited to the credit support described above. We included \$36 million of revenue, \$2 million of general expenses and \$27 million of interest expense associated with these newly consolidated entities in our historical combined financial statements for the period from July 1 to December 31, 2003. Our consolidation of these securitization entities had no effect on our previously reported earnings.

The following table summarizes the assets and liabilities associated with the securitization entities we included in our Combined Statement of Financial Position, which are part of our Corporate and Other segment as of December 31, 2003:

(Dollar amounts in millions)	Historical	
<b>Assets:</b>		
Restricted investments held by securitization entities	\$	1,069
Other assets		65
<b>Total(1)</b>	<b>\$</b>	<b>1,134</b>
<b>Liabilities:</b>		
Borrowings related to securitization entities	\$	1,018
Other liabilities		59
<b>Total</b>	<b>\$</b>	<b>1,077</b>

(1) Includes \$51 million of retained interests in securitized assets now consolidated.

For additional information regarding our securitization transactions, see notes 2 and 20 to our combined financial statements, included elsewhere in this prospectus.

## Quantitative and Qualitative Disclosures About Market Risk

Market risk is the risk of the loss of fair value resulting from adverse changes in market rates and prices, such as interest rates, foreign currency exchange rates and equity prices. Market risk is directly influenced by the volatility and liquidity in the markets in which the related underlying financial instruments are traded. The following is a discussion of our market risk exposures and our risk management practices.

We enter into market-sensitive instruments primarily for purposes other than trading. The carrying value of our investment portfolio as of December 31, 2003 and 2002 was \$77.6 billion and \$72.1 billion, respectively, of which 84% and 84%, respectively, was invested in fixed maturities. The primary market risk to our investment portfolio is interest rate risk associated with investments in fixed maturities. We mitigate the market risk associated with our fixed maturities portfolio by matching the duration of our fixed maturities with the duration of the liabilities that those securities are intended to support.

The primary market risk for our long-term borrowings and Equity Units is interest rate risk at the time of maturity or early redemption, when we may be required to refinance these obligations. We continue to monitor the interest rate environment and to evaluate refinancing opportunities as maturity dates approach.

We are exposed to equity risk on our holdings of common stocks and other equities. We manage equity price risk through industry and issuer diversification and asset allocation techniques.

We also have exposure to foreign currency exchange risk. Our international operations generate revenues denominated in local currencies, and we invest cash generated outside the U.S. in non-U.S.-denominated securities. Although investing in securities denominated in local currencies limits the effect of currency exchange rate fluctuation on local operating results, we remain exposed to the impact of fluctuations in exchange rates as we translate the operating results of our foreign operations into our historical combined financial statements. We currently do not hedge this exposure. For the year ended December 31, 2003, 2002 and 2001, respectively, 26%, 12% and 11% of our net earnings from continuing operations were generated by our international operations.

We use derivative financial instruments, such as interest rate and currency swaps, currency forwards and option-based financial instruments, as part of our risk management strategy. We use these derivatives to mitigate interest rate and currency risk by:

- Reducing the risk between the timing of the receipt of cash and its investment in the market;
- Matching the currency of invested assets with the liabilities they support;
- Converting the asset duration to match the duration of the liabilities; and

- Protecting against the early termination of an asset or liability.

As a matter of policy, we have not and will not engage in derivative market-making, speculative derivative trading or other speculative derivatives activities.

### *Sensitivity analysis*

Sensitivity analysis measures the impact of hypothetical changes in interest rates, foreign exchange rates and other market rates or prices on the profitability of market-sensitive financial instruments.

The following discussion about the potential effects of changes in interest rates, foreign currency exchange rates and equity market prices is based on so-called "shock-tests," which model the effects of interest rate, foreign exchange rate and equity market price shifts on our financial condition and results of operations. Although we believe shock tests provide the most meaningful analysis permitted by the rules and regulations of the Securities and Exchange Commission, they are constrained by several

108

factors, including the necessity to conduct the analysis based on a single point in time and by their inability to include the extraordinarily complex market reactions that normally would arise from the market shifts modeled. Although the following results of shock tests for changes in interest rates, foreign currency exchange rates and equity market prices may have some limited use as benchmarks, they should not be viewed as forecasts. These forward-looking disclosures also are selective in nature and address only the potential impacts on our financial instruments. They do not include a variety of other potential factors that could affect our business as a result of these changes in interest rates, currency exchange rates and equity market prices.

One means of assessing exposure of our fixed maturities portfolio to interest rate changes is a duration-based analysis that measures the potential changes in market value resulting from a hypothetical change in interest rates of 100 basis points across all maturities. This is sometimes referred to as a parallel shift in the yield curve. Under this model, with all other factors constant and assuming no offsetting change in the value of our liabilities, we estimated that such an increase in interest rates would decrease the market value of our fixed income securities portfolio by approximately \$4.0 billion, based on our securities positions as of December 31, 2003.

One means of assessing exposure to changes in foreign currency exchange rates is to model effects on reported earnings using a sensitivity analysis. We analyzed our combined currency exposure as of December 31, 2003, including financial instruments designated and effective as hedges to identify assets and liabilities denominated in currencies other than their relevant functional currencies. Net unhedged exposures in each currency were then remeasured, generally assuming a 10% decrease in currency exchange rates compared to the U.S. dollar. Under this model, with all other factors constant, we estimated at year end 2003 that such a decrease would have an insignificant effect on our net earnings from continuing operations for the year ended December 31, 2004.

One means of assessing exposure to changes in equity market prices is to estimate the potential changes in market values on our equity investments resulting from a hypothetical broad-based decline in equity market prices of 10%. Under this model, with all other factors constant, we estimated that such a decline in equity market prices would decrease the market value of our equity investments by approximately \$40 million, based on our equity positions as of December 31, 2003. In addition, fluctuations in equity market prices affect our revenues and returns from our separate account and private asset management products, which depend upon fees that are related primarily to the value of assets under management.

### *Counterparty credit risk*

We manage counterparty credit risk on an individual counterparty basis, which means that gains and losses are netted for each counterparty to determine the amount at risk. When a counterparty exceeds credit exposure limits in terms of amounts owed to us, typically as the result of changes in market conditions (see table below), no additional transactions are executed until the exposure with that counterparty is reduced to an amount that is within the established limit. All swaps are executed under master swap agreements containing mutual credit downgrade provisions that provide the ability to require assignment or termination in the event either party is downgraded below Moody's A3 or S&P's A-.

Swaps, purchased options and forwards with contractual maturities longer than one year are conducted within the credit policy constraints provided in the table below. Our policy allows for derivative transactions with lower rated counterparties (Moody's "Aa3" and S&P's "AA-") if the agreements governing such transactions require both parties to provide collateral supporting exposures above the unsecured credit limit. Our policy requires foreign exchange forwards with contractual maturities shorter than one year to be executed with counterparties having a credit rating by Moody's of A-1 and by S&P of P-1 and the credit limit for these transactions is \$150 million per counterparty.

109

The following table sets forth our counterparty credit rating criteria as of December 31, 2003:

	Credit rating	
	Moody's	Standard & Poor's
<b>Term of transaction</b>		
Up to five years	Aa3	AA-
Greater than five years	Aaa	AAA
<b>Credit exposure limit</b>		
Up to \$50 million	Aa3	AA-
Up to \$75 million	Aaa	AAA

The conversion of interest rate and currency risk into credit risk requires us to monitor counterparty credit risk actively. As of December 31, 2003 and 2002, there were no notional amounts of long-term derivatives for which the counterparty was rated below Aa3 by Moody's.

The following table sets forth an analysis of our counterparty credit risk exposures as of the dates indicated:

Percentage of notional derivative exposure by counterparty credit rating



	Historical			Pro forma
	December 31,			December 31,
	2003	2002	2001	2003
Moody's rating				
Aaa	95%	91%	98%	93%
Aa	5%	9%	2%	7%
	100%	100%	100%	100%

### Seasonality

In general, our business as a whole is not seasonal in nature. However, in our Mortgage Insurance segment, the level of defaults, which increases the likelihood of losses, tends to decrease in the first and second quarters of the calendar year and increase in the third and fourth quarters. As a result, we have experienced lower levels of losses resulting from defaults in the first and second quarters, as compared with the third and fourth quarters.

### Inflation

In general, we do not believe that inflation has had a material effect on our historical combined results of operations, except insofar as inflation may affect interest rates. See "—Quantitative and Qualitative Disclosures About Market Risk—Market risk" and "Risk Factors—Risks Relating to Our Business—Interest rate fluctuations could adversely affect our cash flow and profitability."

### New Accounting Standards

#### Currently effective

*FIN 46.* FIN 46, *Consolidation of Variable Interest Entities*, became effective for us on July 1, 2003. As described above, as a result of the adoption of FIN 46, GE Capital was required to consolidate a funding conduit it sponsored. As a result, assets and liabilities of certain previously off-balance sheet securitization entities were required to be included in our financial statements because the funding conduit no longer qualified as a third party.

*B36.* SFAS 133 Implementation Issue B36 ("B36"), *Modified Coinsurance Arrangements with Debt Instruments that Incorporate Credit Risk Exposures that are Unrelated or Only Partially Related to the*

110

*Creditworthiness of the Obligor under those Instruments*, became effective for us on October 1, 2003. B36 provides that modified coinsurance arrangements, where the ceding insurer withholds funds, may include an embedded derivative that must be bifurcated from the host instrument. The adoption of B36 did not have a material impact on our financial position upon adoption and, based upon our current and expected reinsurance arrangements, we do not expect a material impact on our results of operations or financial condition.

*SFAS 150.* Statement of Financial Accounting Standards 150 ("SFAS 150"), *Accounting for Certain Financial Instruments with characteristics of both Liabilities and Equity*, became effective for us for the quarter ended September 30, 2003. SFAS 150 requires issuers to classify the following three types of freestanding financial instruments as liabilities: mandatorily redeemable financial instruments, obligations to repurchase the issuer's equity interests by transferring assets and certain obligations to issue a variable number of shares. The adoption of SFAS 150 did not have a material impact on our results of operations or financial condition.

*SOP 03-1.* In July 2003, the American Institute of Certified Public Accountants issued Statement of Position 03-1 ("SOP 03-1"), *Accounting and Reporting by Insurance Enterprises for Certain Nontraditional Long-Duration Contracts and for Separate Accounts*, which we adopted on January 1, 2004. This statement provides guidance on separate account presentation and valuation, the accounting for sales inducements and the classification and valuation of long-duration contract liabilities. We do not expect the adoption of SOP 03-1 to have a material impact on our results of operations or financial condition.

111

## Corporate Reorganization

### Our History

Prior to the completion of this offering and the concurrent offerings, our businesses were owned by GE, a global diversified technology and services company. In the 1980s and 1990s, GE pursued a strategy of developing and acquiring insurance businesses, targeting attractive segments that included the U.S. and international mortgage and life insurance markets.

We entered the U.S. mortgage insurance business in 1981 through a start-up in Cincinnati, Ohio. In 1983, we acquired a competitor, American Mortgage Insurance, located in Raleigh, North Carolina and moved our mortgage insurance headquarters there. In the late 1980s and early 1990s, we acquired several other U.S. mortgage insurers or their books of business. We also acquired mortgage insurance operations in Canada and Australia and launched a start-up business in Europe as part of our strategy to expand into international markets.

We entered the life insurance business in 1993 through our acquisition of GNA Corp., a leading provider of annuities through the bank distribution channel. From 1993 to 2000, we successfully completed the acquisition and integration of 13 key businesses, which significantly expanded the breadth of our product offerings and the scope of our distribution capabilities. We maintained a disciplined focus on effectively integrating the operations of each business we acquired.

In recent years, we have been reviewing our businesses, with the objective of focusing on segments where we have competitive advantage and the greatest potential for growth and returns on capital. We began to redeploy our capital in accordance with that strategy in 2002 and have exited certain product lines, distribution relationships and business units where we lacked long-term competitive advantage, could not deploy capital efficiently or could not achieve our targeted returns. In August 2003, we sold our

Japanese life insurance operations and our domestic auto and homeowners' insurance businesses to American International Group, Inc. We also repriced certain products for higher risk-adjusted margins and lowered production targets for products that were not achieving our targeted returns on capital. At the same time, GE has been reviewing its long-term strategy and has actively sought to reduce its investment in insurance businesses and redeploy some of the capital required by those businesses to its other businesses. For example, in December 2003, GE sold substantially all of its financial guaranty insurance business to a consortium led by The PMI Group, Inc.

We have benefited from GE's commitment to operational execution, continuous process improvement, cost productivity, risk management, technology and development of managerial talent. We believe these skills and values provide us with a significant competitive advantage, and we intend to retain them as an integral part of our culture. We also believe our independence from GE will provide us with a number of benefits, allowing us to:

- execute a strategy for our insurance business independent from GE's overall corporate strategy;
- obtain direct access to capital markets;
- use our stock for selective acquisitions; and
- align employee incentive plans more closely with the performance of our company.

#### **Formation of Genworth Financial, Inc.**

We were incorporated in Delaware on October 23, 2003 in preparation for our corporate reorganization. We were incorporated solely for this purpose and have not engaged in any activities or formed any subsidiaries, except in preparation for our corporate reorganization and this offering and the concurrent offerings.

112

---

Prior to the completion of this offering, we will acquire substantially all of the assets and liabilities of GEFAHI. GEFAHI is an indirect subsidiary of GE and a holding company for a group of companies that provide life insurance, long-term care insurance, group life and health insurance, annuities and other investment products and U.S. mortgage insurance. We also will acquire certain other insurance businesses currently owned by other GE subsidiaries but managed by members of the Genworth management team. These businesses include international mortgage insurance, European payment protection insurance, Viking Insurance Company, which is a Bermuda-based reinsurer primarily of leased equipment insurance and consumer credit insurance, and mortgage contract underwriting. All of our businesses will be transferred to us prior to the completion of this offering through stock transfers, except for the European payment protection business, which will be transferred to us initially through a combination of stock transfers and reinsurance arrangements. See "Arrangements Between GE and Our Company—European Payment Protection Insurance Business Arrangements."

In consideration for the assets that we will acquire and the liabilities that we will assume in connection with our corporate reorganization, we will issue to GEFAHI the following securities:

- million shares of our Class B Common Stock. For a description of the terms of our common stock, see "Description of Capital Stock—Common Stock."
- \$600 million of our Equity Units. For a description of the terms of our Equity Units, see "Description of Equity Units." GEFAHI is offering the Equity Units for sale in a concurrent offering.
- \$100 million of our Series A Preferred Stock. For a description of the terms of our Series A Preferred Stock, see "Description of Capital Stock—Preferred Stock—Series A Preferred Stock." GEFAHI is offering shares of our Series A Preferred Stock for sale in a concurrent offering.
- \$2.4 billion Short-term Intercompany Note. For a description of the terms of this note, see "Description of Certain Indebtedness—Short-term Intercompany Note."
- \$550 million Contingent Note. For a description of the terms of this note, see "Description of Certain Indebtedness—Contingent Note."

The liabilities we will assume from GEFAHI include the Yen Notes, which are ¥60 billion aggregate principal amount of 1.6% notes due 2011 issued by GEFAHI, ¥3 billion of which GEFAHI currently holds and will transfer to us. We have entered into arrangements to swap our obligations under these notes to a U.S. dollar obligation with a principal amount of \$491 million and bearing interest at a rate of 4.84% per annum.

Prior to the completion of this offering and the concurrent offerings, GEFAHI will own 100% of our outstanding common stock, which will consist solely of Class B Common Stock. Shares of Class B Common Stock convert automatically into shares of Class A Common Stock when they are held by any person other than GE or an affiliate of GE. As a result, all the shares of common stock offered in this offering consist of Class A Common Stock. Upon the completion of this offering and the concurrent offerings, GE will beneficially own (through GEFAHI) approximately % of our outstanding common stock, if the underwriters' over-allotment option is not exercised, and %, if it is exercised in full. GE has informed us that, after completion of this offering, it intends, subject to market conditions, to divest its remaining interest in us as soon as practicable. GE has also informed us that, in any event, it expects to reduce its interest to below 50% within two years of the completion of this offering. GE currently expects to reduce its interest through one or more additional public offerings of our common stock, but it is not obligated to divest our shares in this or any other manner.

Prior to the completion of this offering, we will enter into a number of arrangements with GE governing our separation from GE and a variety of transition and other matters, including our relationship with GE while GE remains a significant stockholder in our company. These arrangements

113

---

include several significant reinsurance transactions with Union Fidelity Life Insurance Company, or UFLIC, an indirect, wholly-owned subsidiary of GE. As part of these transactions, we will cede to UFLIC, effective as of January 1, 2004, policy obligations under our structured settlement contracts, which had reserves of \$12.0 billion, and our variable annuity contracts, which had general account reserves of \$2.8 billion and separate account reserves of \$7.9 billion. These contracts represent substantially all of our contracts that were in force as of December 31, 2003 for these products. In addition, effective as of January 1, 2004, we will cede to UFLIC policy obligations under a block of long-term care insurance policies that we reinsured from Travelers, which had reserves of \$1.5 billion. In the aggregate, these blocks of business do not meet our target return thresholds, and although we remain liable under these contracts and policies as the ceding insurer, the reinsurance transactions will have the effect of transferring the financial results of the reinsured blocks to UFLIC. We are continuing new sales of structured settlement, variable annuity and long-term care insurance products, and we expect to achieve our targeted returns on these new sales. In addition, we will continue to service these blocks of business, which will preserve our operating scale and enable us to service and grow our new sales of these products. See "Arrangements Between GE and Our Company."

114

---

## Business

We are a leading insurance company in the U.S., with an expanding international presence, serving the life and lifestyle protection, retirement income, investment and mortgage insurance needs of more than 15 million customers. We have leadership positions in key products that we expect will benefit from a number of significant demographic, governmental and market trends. We distribute our products and services through an extensive and diversified distribution network that includes financial intermediaries, independent producers and dedicated sales specialists. We conduct operations in 20 countries and have approximately 5,850 employees.

We have the following three operating segments:

- **Protection.** We offer U.S. customers life insurance, long-term care insurance and, for companies with fewer than 1,000 employees, group life and health insurance. In Europe, we offer payment protection insurance, which helps consumers meet their payment obligations in the event of illness, involuntary unemployment, disability or death. In 2003, we were the leading provider of individual long-term care insurance and the sixth-largest provider of term life insurance in the U.S., according to LIMRA International (in each case based upon gross written premiums). We believe we are a leading provider of term life insurance through brokerage general agencies in the U.S. and that this channel is the largest and fastest-growing distribution channel for term life insurance. Our leadership in long-term care insurance is based upon almost 30 years of product underwriting and claims experience. This experience has enabled us to build and benefit from what we believe is the largest actuarial database in the long-term care insurance industry. For the year ended December 31, 2003, our Protection segment had pro forma segment net earnings of \$481 million.
- **Retirement Income and Investments.** We offer U.S. customers fixed, variable and income annuities, variable life insurance, asset management, and specialized products, including guaranteed investment contracts, funding agreements and structured settlements. We are an established provider of these products and, in 2003, we were the leading provider of income annuities in the U.S., according to LIMRA International (based upon total premiums and deposits). For the year ended December 31, 2003, our Retirement Income and Investments segment had pro forma segment net earnings of \$93 million.
- **Mortgage Insurance.** In the U.S., Canada, Australia and Europe, we offer mortgage insurance products that facilitate homeownership by enabling borrowers to buy homes with low-down-payment mortgages. These products generally also aid financial institutions in managing their capital efficiently by reducing the capital required for low-down-payment mortgages. In 2003, according to *Inside Mortgage Finance*, we were the fourth-largest provider of mortgage insurance in the U.S. (based upon new insurance written), and we believe we are the largest provider of private mortgage insurance outside the U.S., with leading mortgage insurance operations in Canada, Australia and the U.K. and a growing presence in Continental Europe. The net premiums written in our international mortgage insurance business have increased by a compound annual growth rate of 46% for the three years ended December 31, 2003. For the year ended December 31, 2003, our Mortgage Insurance segment had pro forma segment net earnings of \$369 million.

We also have a Corporate and Other segment, which consists primarily of net realized investment gains (losses), interest and other financing expenses that are incurred at our holding company level, unallocated corporate income and expenses, and the results of several small, non-core businesses that are managed outside our operating segments. For the year ended December 31, 2003, our Corporate and Other segment had a pro forma segment net loss of \$8 million.

115

---

We had \$11.0 billion of total stockholder's interest and \$97.9 billion of total assets as of December 31, 2003, on a pro forma basis. For the year ended December 31, 2003, on a pro forma basis, our revenues were \$9.8 billion and our net earnings from continuing operations were \$935 million. Upon the completion of this offering, we expect our principal life insurance companies to have financial strength ratings of "AA-" (Very Strong) from S&P, "Aa3" (Excellent) from Moody's and "A+" (Superior) from A.M. Best, and we expect our rated mortgage insurance companies to have financial strength ratings of "AA" (Very Strong) from S&P, "Aa2" (Excellent) from Moody's and "AA" (Very Strong) from Fitch. The "AA" and "AA-" ratings are the third- and fourth-highest of S&P's 21 ratings categories, respectively. The "Aa2" and "Aa3" ratings are the third- and fourth-highest of Moody's 21 ratings categories, respectively. The "A+" rating is the second-highest of A.M. Best's 15 ratings categories. The "AA" rating is the third-highest of Fitch's 24 ratings categories.

### Market Environment and Opportunities

We believe we are well positioned to benefit from a number of significant demographic, governmental and market trends, including the following:

- **Aging U.S. population with growing retirement income needs.** According to the U.S. Social Security Administration, from 1945 to 2001, U.S. life expectancy at birth increased from 62.9 years to 73.8 years for men and from 68.4 years to 79.4 years for women, respectively, and life expectancy is expected to increase further. In addition, increasing numbers of baby boomers are approaching retirement age. The U.S. Census Bureau projects that the percentage of the U.S. population aged 55 or older will increase from approximately 21% (61 million) in 2002 to more than 29% (95 million) in 2020. These increases in life expectancy and the average age of the U.S. population heighten the risk that individuals will outlive their retirement savings. In addition, approximately \$4.4 trillion of invested financial assets (25% of all U.S. invested financial assets) are held by people within 10 years of retirement and are expected to be converted to income as those people retire, according to a survey conducted by SRI Consulting Business Intelligence in 2002. We believe these trends will lead to growing demand for products, such as our annuities and other investment products, that help consumers accumulate assets and provide reliable retirement income.
- **Growing lifestyle protection gap.** The aging U.S. population and a number of other factors are creating a significant lifestyle protection gap for a growing number of individuals. This gap is the result of individuals not having sufficient financial resources, including insurance coverage, to ensure that their future assets and income will be adequate to support their desired future lifestyle. Other factors contributing to this gap include declining individual savings rates, rising healthcare and nursing home costs, and a shifting of the burden for funding protection needs from governments and employers to individuals. For example, many companies have reduced employer-paid benefits in recent years, and the Social Security Administration projected in 2003 that the annual costs of Social Security will exceed the program's tax revenue under current law in 2018, creating the potential for both long-term benefit reductions from these traditional sources and the need for individuals to identify alternative sources for these benefits. In addition, according to the U.S. Bureau of Economic Analysis, personal savings rates decreased from 10.9% in 1982 to 3.7% in 2002. Consumers are exposed to the rising costs of healthcare and nursing care during their retirement years, and some experts believe that many consumers are underinsured with respect to their protection needs. For example, according to the American Society on Aging and Conning Research & Consulting, approximately 70% of individuals in the U.S. aged 65 and older will require long-term care at some time in their lives, but in 2001, only 7% of individuals in the U.S. aged 55 and older had long-term care insurance. Moreover, the most recent Survey of Consumer Finances conducted by the Federal Reserve Board found that the median household's life insurance coverage decreased in recent years to 1.4 times household

116

---

income, which we believe leaves a significant life insurance protection gap for individuals and families. We expect these trends to result in increased demand for our life, long-term care and small group life and health insurance products.

- **Increasing opportunities for mortgage insurance in the U.S. and other countries.** We believe a number of factors have contributed and will contribute to the

growth of mortgage insurance in the U.S., Canada and Australia, where we have significant mortgage insurance operations. These factors include increasing homeownership levels (spurred in part by government housing policies that favor homeownership); expansion of low-down-payment mortgage loan offerings; legislative and regulatory policies that provide capital incentives for lenders to transfer the risks of low-down-payment mortgages to mortgage insurers; and expansion of secondary mortgage markets that require credit enhancements, such as mortgage insurance. We believe a number of these factors also are becoming evident in some European and Asian markets, where lenders increasingly are using mortgage insurance to manage the risks of their loan portfolios and to expand low-down-payment lending.

## Competitive Strengths

We believe the following competitive strengths will enable us to capitalize on opportunities in our targeted markets:

- **Leading positions in diversified targeted markets.** We have established leading positions in our targeted markets. In our Protection segment, we are a leading provider of several core products including term life insurance and individual long-term care insurance in the U.S. and payment protection insurance in Europe. In our Retirement Income and Investments segment, we are the leading provider of income annuities. In our Mortgage Insurance segment, we have leading operations in the U.S., Canada, Australia, and the U.K. We believe our leading positions provide us with the scale necessary to compete effectively in these markets as they continue to grow. We also believe our strong presence in multiple markets provides balance to our business, reduces our exposure to adverse economic trends affecting any one market and provides stable cash flow to fund growth opportunities.
- **Product innovation and smart breadth.** We have a tradition of developing innovative financial products to serve the needs of our customers. For example, we were the first to introduce long-term care insurance plans that enable married couples to share long-term care insurance benefits. We also introduced the GE Retirement Answer®, a guaranteed income annuity product that mitigates a number of the risks that accompany traditional guaranteed minimum income benefits offered by many of our competitors. We offer a breadth of products that meet the needs of consumers throughout the various stages of their lives. We refer to our approach to product diversity as "smart" breadth because we are selective in the products we offer and strive to maintain appropriate return and risk thresholds when we expand the scope of our product offerings. We believe our reputation for innovation and our smart breadth of products enable us to sustain strong relationships with our distributors. It also positions us to benefit from the current trend among distributors to reduce the number of insurers with whom they maintain relationships, while at the same time providing distributors continued access to a breadth of products.
- **Extensive, multi-channel distribution network.** We have extensive distribution reach and offer consumers access to our products through a broad network of financial intermediaries, independent producers and dedicated sales specialists. In addition, we maintain strong relationships with leading distributors by providing a high level of specialized and differentiated distribution support, such as product training, advanced marketing and sales solutions, financial

117

---

product design for affluent customers and technology solutions that support the distributors' sales efforts, and by pursuing joint business improvement efforts. For example, in our mortgage insurance business, our AU Central® Internet platform provides lenders real-time access to multiple automated underwriting systems at the point of sale, helping them to originate loans more easily and efficiently. We also offer a joint business improvement program (originally developed by GE), called "At the Customer For the Customer," or ACFC, through which we help our independent sales intermediaries increase sales and realize greater cost and operational efficiencies in their businesses. We believe programs such as AU Central® and ACFC have been favorably received by our distributors and helped to differentiate us from our competitors.

- **Technology-enhanced, scalable, low-cost operating platform.** We have pursued an aggressive approach to cost-management and continuous process improvement. We employ an extensive array of cost management disciplines, including aggressive integration efforts, forming dedicated teams to identify opportunities for cost reductions and the continuous improvement of business processes. This has enabled us to reduce our recurring operating expenses and provide funds for new growth and technology investments. We also have developed sophisticated technological tools that enhance performance by automating key processes and reducing response times and process variations. These tools also make it easier for our customers and distributors to do business with us. For example, we recently introduced GENIUS®, a proprietary digital platform that automates our term life and long-term care insurance new business processing and improves the consistency and accuracy of our underwriting decisions. GENIUS® is designed to substantially shorten the cycle time from receipt-of-application to issuance-of-policy and significantly reduce our policy acquisition costs. In addition, we have centralized our operations and have established scalable, low-cost operating centers in Virginia, North Carolina, India and Ireland.
- **Disciplined risk management with strong compliance practices.** Risk management and regulatory compliance are critical parts of our business, and we are recognized in the insurance industry for our excellence in these areas. We employ comprehensive risk management processes in virtually every aspect of our operations, including product development, underwriting, investment management, asset-liability management and technology development programs. We have an experienced group of more than 130 professionals dedicated exclusively to our risk management processes. As part of GE, we have been able to develop and share best practices for risk management across GE's financial services businesses. These best practices include an in-force product review process, an early-warning system to identify emerging risks and leading-edge tools for investment risk assessment. We believe our disciplined risk management processes have enabled us to avoid a number of the pricing and product design pitfalls that have affected other participants in the insurance industry. For example, we have not offered a traditional guaranteed minimum income benefit with our variable annuities as offered by many of our competitors because we concluded the exposures inherent in these benefits exceed our permissible risk tolerance. In our mortgage insurance business, we have substantially limited our exposure to the riskier portions of the bulk and sub-prime mortgage insurance market. We take a similar disciplined approach to legal and regulatory compliance and have approximately 200 professionals dedicated to these matters. Throughout our company we instill a strong commitment to integrity in business dealings and compliance with applicable laws and regulations. In recognition of this commitment, we have received the American Council of Life Insurers' Integrity First Award for compliance in both 2001 and 2002.
- **Strong balance sheet and high-quality investment portfolio.** We believe our size, ratings and capital strength provide us with a significant competitive advantage. We have a diversified, high-quality investment portfolio with \$59.8 billion of investment securities, as of December 31, 2003, on a pro forma basis. More than 93% of our fixed maturities had ratings equivalent to investment-

118

---

grade, and less than 1% of our total investment portfolio consisted of equity securities, as of December 31, 2003, on a pro forma basis. We also actively manage the relationship between our investment assets and our insurance liabilities. Our prudent approach to managing our balance sheet reflects our commitment to maintaining financial strength.

- **Experienced and deep management team.** Our senior management team has an average of approximately 17 years of experience in the financial services industry. We have adopted GE's recognized practices for successfully developing managerial talent at all levels of our organization and have instilled a performance- and execution-oriented corporate culture that we will continue to foster as an independent company.

## Growth Strategies

Our objective is to increase operating earnings and enhance returns on equity. We intend to pursue this objective by focusing on the following strategies:

- **Capitalize on attractive growth trends in three key markets.** We have positioned our product portfolio and distribution relationships to capitalize on the attractive growth prospects in three key markets:
  - Retirement income*, where we believe growth will be driven by a variety of favorable demographic trends and the approximately \$4.4 trillion of invested financial assets in the U.S. that are held by people within 10 years of retirement (according to SRI Consulting Business Intelligence). Our products are designed to enable the growing retired population to convert their invested assets into reliable retirement income.
  - Protection*, particularly long-term care insurance, where we believe growth will be driven by the increasing protection needs of the expanding aging population and a shifting of the burden for funding these needs to individuals from governments and employers. For example, according to the American Society on Aging and Conning Research & Consulting, approximately 70% of individuals in the U.S. aged 65 and older will require long-term care at some time in their lives, but in 2001, only 7% of individuals in the U.S. aged 55 and older had long-term care insurance.
  - International mortgage insurance*, where we continue to see attractive growth opportunities with the expansion of homeownership and low-down-payment loans. The net premiums written in our international mortgage insurance business have increased by a compound annual growth rate of 46% for the three years ended December 31, 2003. Our international mortgage insurance operations had net earnings of \$144 million for the year ended December 31, 2003, or 39% of the total net earnings of our Mortgage Insurance segment.
- **Further strengthen and extend our distribution channels.** We intend to further strengthen and extend our distribution channels by continuing to differentiate ourselves in areas where we believe we have distinct competitive advantages. These areas include:
  - Product and service innovations*, as illustrated by new product introductions, such as the introduction in 2002 of our GE Retirement Answer® and our introduction of innovative private mortgage insurance products in the European market, which we believe have been well received by customers and have generated new distribution relationships for us. Our service innovations include programs such as our policyholder wellness initiatives in our long-term care insurance business and our AU Central® Internet platform in our mortgage insurance business.

119

---

*Collaborative approach to key distributors*, which includes a joint business improvement program (originally developed by GE), called "At the Customer, For the Customer," or ACFC, and our platinum customer service desks, which have benefited our distributors and helped strengthen our relationships with them.

*Technology initiatives*, such as our GENIUS® underwriting system, which makes it easier for distributors to do business with us by improving our term life and long-term care insurance underwriting speed and accuracy and also lowering operating costs.

- **Enhance returns on capital and increase margins.** We believe we will be able to enhance our returns on capital and increase our margins through the following:
  - Rigorous product pricing and return discipline.* We intend to maintain strict product pricing disciplines that are designed to achieve our target returns on capital. Over the past two years, we introduced restructured pricing on newly issued policies in a number of product lines in each of our operating segments, which we believe will increase our expected returns on new business. In addition, we exited products that were not achieving our target returns. We expect our returns on capital to improve as the benefits of these actions emerge over time and as we continue our focus on maintaining target returns in the future.
  - Capital efficiency enhancements.* We continually seek opportunities to use our capital more efficiently to support our business, while maintaining our ratings and strong capital position. For example, in 2003, we took actions to reduce the statutory capital required to support most of our new term and universal life insurance policies. We expect these actions will enhance the returns on equity on these blocks of business over time. In addition, we expect that the returns for our U.S. mortgage insurance business will increase as a result of our 2003 decision to reduce excess capital at our mortgage insurance subsidiaries by operating at an "AA/Aa2" rating level.
  - Investment income enhancements.* As part of GE, the yield on our investment portfolio has been affected by the practice in recent years of realizing investment gains through the sale of appreciated securities and other assets during a period of historically low interest rates. This strategy was pursued to offset impairments in our bond portfolio, fund consolidations and restructurings in our business and provide current income. As we transition to being an independent public company, our investment strategy will be to optimize investment income without relying on realized investment gains. As a result of this strategy, we expect the yield on our investment portfolio to stabilize, with the potential for increases in a rising interest rate environment. We also will seek to improve our investment yield by continuously evaluating our asset class mix and pursuing additional investment classes.
  - Ongoing operating cost reductions and efficiencies.* We will continually focus on reducing our cost base while maintaining strong service levels for our customers. We expect to accomplish this in each of our operating units through a wide range of cost management disciplines, including consolidating operations, using low-cost operating locations, reducing supplier costs, leveraging Six Sigma and other process improvement efforts, forming dedicated teams to identify opportunities for cost reductions and investing in new technology, particularly for web-based, digital end-to-end processes.
- **Pursue acquisitions opportunistically.** We intend to continue to complement our core growth strategy through selective acquisitions designed to enhance our earnings and returns, the breadth of our product portfolio, or our distribution reach. We have successfully completed the acquisition and integration of 13 key businesses since 1993. As a public company, we will have direct access to capital markets, which we believe will enable us to raise external capital in an efficient manner to facilitate selective acquisitions.

120

---

## Protection

Through our Protection segment, we offer life insurance, long-term care insurance, European payment protection insurance and employment-based group life and health insurance. The following table sets forth, on an actual and pro forma basis, selected financial information regarding our Protection segment as of the dates and for the periods indicated:

Pro forma

	Historical			As of or for the year ended December 31,
	As of or for the years ended December 31,			2003
	2003	2002	2001	2003
<b>(Dollar amounts in millions)</b>				
<b>Net earned premiums</b>				
Life insurance	\$ 698	\$ 685	\$ 711	\$ 698
Long-term care insurance	1,775	1,543	1,433	1,568
European payment protection insurance	1,507	1,242	1,161	1,507
Group life and health insurance	608	618	610	608
Total net earned premiums	\$ 4,588	\$ 4,088	\$ 3,915	\$ 4,381
<b>Revenues, net of reinsurance</b>				
Life insurance	\$ 1,444	\$ 1,432	\$ 1,511	\$ 1,444
Long-term care insurance	2,417	2,087	1,921	2,103
European payment protection insurance	1,615	1,372	1,303	1,615
Group life and health insurance	677	714	708	677
Total revenues, net of reinsurance	\$ 6,153	\$ 5,605	\$ 5,443	\$ 5,839
<b>Segment net earnings</b>				
Life insurance	\$ 211	\$ 252	\$ 287	\$ 211
Long-term care insurance	171	164	159	165
European payment protection insurance	64	82	58	64
Group life and health insurance	41	56	34	41
Total segment net earnings	\$ 487	\$ 554	\$ 538	\$ 481
<b>Assets</b>				
Life insurance	\$ 11,742	\$ 10,710	\$ 10,218	\$ 11,742
Long-term care insurance	11,757	10,711	8,651	11,304
European payment protection insurance	4,074	3,866	4,108	4,074
Group life and health insurance	1,681	1,817	1,670	1,681
Total assets	\$ 29,254	\$ 27,104	\$ 24,647	\$ 28,801

## Life insurance

### Overview

Life insurance provides protection against financial hardship after the death of an insured by providing cash payments to the beneficiaries of the policyholder. According to the American Council of Life Insurers, sales of new life insurance coverage in the U.S. were \$2.9 trillion in 2002, and total life insurance coverage in the U.S. was \$16.3 trillion as of December 31, 2002. Excluding variable life insurance, the sales of which have been adversely affected by recent stock market volatility, annualized premiums for life insurance increased by an average of 9.1% per year from 1999 to 2002, according to LIMRA International.

Our principal life insurance product is term life, which provides life insurance coverage with guaranteed level premiums for a specified period of time with little or no buildup of cash value that is payable upon lapse of the coverage. We have been a leading provider of term life insurance for more than two decades, and, in 2003, we were the sixth-largest provider of term life insurance in the U.S., based upon gross written premiums, according to LIMRA International, and we believe we are a leading provider of term life insurance through brokerage general agencies in the U.S. In addition to term life insurance, we offer universal life insurance products, which are designed to provide protection for the entire life of the insured and may include a buildup of cash value that can be used to meet the policyholder's particular financial needs during his lifetime. Our life insurance business also includes a closed block of whole life insurance that is in run-off. Whole life insurance offers the beneficiary benefits in the event of the insured's death for his entire life, provided premiums have been paid when due. Whole life insurance also allows for the buildup of cash value but has no investment feature.

We price our insurance policies based primarily upon our own historical experience in the risk categories that we target. Our pricing strategy is to target individuals in preferred risk categories and offer them attractive products at competitive prices. Preferred risks include healthier individuals who generally have family histories that do not present increased mortality risk. As of December 31, 2003, approximately 82% of our in-force life insurance policies covered individuals in preferred risk categories. We also have significant expertise in evaluating people with health problems and offer appropriately priced coverage for people who meet our underwriting criteria. Our mortality experience generally has compared favorably to the assumptions we have used in pricing our products, and we believe this is indicative of the quality of our underwriting decision-making. In addition, the persistency of our policies also has compared favorably to our pricing assumptions.

We have been able to improve our returns on equity on new business by implementing pricing, reinsurance and capital management actions in response to Regulation XXX, which requires insurers to establish additional statutory reserves for term and universal life insurance policies with long-term premium guarantees. Virtually all our newly issued term and universal life insurance business is now affected by Regulation XXX.

We offer our life insurance products primarily through an extensive network of independent brokerage general agencies located throughout the U.S. We also offer our life insurance products through affluent market producer groups, financial intermediaries and dedicated sales specialists. We believe there are opportunities to expand our sales through each of these distribution channels.

The following table sets forth selected financial information regarding our life insurance products as of the dates and for the periods indicated:

	Historical		
	As of or for the years ended December 31,		
	2003	2002	2001
<b>(Dollar amounts in millions)</b>			
<b>Term life insurance</b>			
Net earned premiums	\$ 664	\$ 635	\$ 661
Annualized first-year premiums(1)	106	138	105
Revenues, net of reinsurance	747	720	753
Future policy benefits/policy account balances, net of reinsurance	634	567	559
Life insurance in force, net of reinsurance (face amount)	296,942	263,622	278,720
Life insurance in force, before reinsurance (face amount)	457,738	416,305	375,244
<b>Universal and whole life insurance</b>			
Net earned premiums and deposits	402	406	412
Annualized first-year deposits(1)	57	57	41
Revenues, net of reinsurance	697	712	758
Future policy benefits/policy account balances, net of reinsurance	4,509	4,439	4,393
Life insurance in force, net of reinsurance (face amount)	43,726	44,663	45,721
Life insurance in force, before reinsurance (face amount)	53,074	54,587	54,228
<b>Total life insurance(2)</b>			
Net earned premiums and deposits	1,066	1,041	1,073
Annualized first-year premiums(1)	106	138	105
Annualized first-year deposits(1)	57	57	41
Revenues, net of reinsurance	1,444	1,432	1,511
Future policy benefits/policy account balances, net of reinsurance	5,143	5,006	4,952
Life insurance in force, net of reinsurance (face amount)	340,668	308,285	324,441
Life insurance in force, before reinsurance (face amount)	510,812	470,892	429,472

- (1) Annualized first-year premiums for term life insurance and deposits for universal life insurance reflect the amount of business we generated during each period shown and do not include renewal premiums or deposits on policies written during prior periods. We consider annualized first-year premiums and deposits to be a measure of our operating performance because they represent a measure of new sales of insurance policies during a specified period, rather than a measure of our revenues or profitability during that period. This operating measure enables us to compare our operating performance across periods without regard to revenues or profitability related to policies sold in prior periods or from investments or other sources.
- (2) Excludes life insurance written through our group life and health insurance business, a corporate-owned life insurance run-off block managed by our long-term care insurance business and variable life insurance written through our Retirement Income and Investments segment.

## Products

### Term life insurance

Our term life insurance policies provide a death benefit if the insured dies while the coverage is in force. Term life policies lapse with little or no required payment by us at the end of the coverage period if the insured is still alive. We also offer policyholders the right to convert most of our term insurance policies to specified universal or variable universal life insurance policies issued by us. We seek to reduce the mortality risk associated with conversion by restricting its availability to certain ages and by limiting the period during which the conversion option can be exercised.

Our primary term life insurance products have guaranteed level premiums for initial terms of 5, 10, 15, 20 or 30 years. In addition, our 5-year products offer, at the end of the initial term, a second 5-year term of level premiums, which may or may not be guaranteed. After the guaranteed period expires, premiums increase annually and the policyholder has the option to continue under the current policy by paying the increased premiums without demonstrating insurability or qualifying for a new policy by submitting again to the underwriting process. Coverage continues until the insured reaches the policy expiration age or the policyholder ceases to make premium payments or otherwise terminates the policy, including potentially converting to a permanent plan of insurance. The termination of coverage is called a lapse. For newer policies, we seek to reduce lapses at the end of the guaranteed period by gradually grading premiums to the attained age scale of the insured over the five years following the guaranteed period. After this phase-in period, premiums continue to increase as the insured ages.

### Universal life insurance

Our universal life insurance policies provide policyholders with lifetime death benefit coverage, the ability to accumulate assets on a flexible, tax-deferred basis, and the option to access the cash value of the policy through a policy loan, partial withdrawal or full surrender. Our universal life products allow policyholders to adjust the timing and amount of premium payments. We credit premiums paid, less certain expenses, to the policyholder's account and from that account deduct regular expense charges and certain risk charges, known as cost of insurance, which generally increase from year to year as the insured ages. Our universal life insurance policies accumulate cash value that we pay to the insured when the policy lapses or is surrendered. Most of our universal life policies also include provisions for surrender charges for early termination and partial withdrawals. As of December 31, 2003, 65% of our in-force block of universal life insurance was subject to surrender charges. We also sell joint, second-to-die policies that are typically used for estate planning purposes. These policies insure two lives rather than one, with the policy proceeds paid after the death of both insured individuals.

We credit interest on policyholder account balances at a rate determined by us, but not less than a contractually guaranteed minimum. Our in-force universal life insurance

policies generally have minimum guaranteed crediting rates ranging from 4.0% to 6.0% for the life of the policy, with a majority of those products currently crediting rates between 4.0% and 5.5%. The most frequent minimum guaranteed crediting rate as of December 31, 2003 was 4%. With interest rates currently at or near historical lows, we are seeking regulatory authorization to reduce our minimum guaranteed crediting rates for new policies.

### ***Underwriting and pricing***

We believe that effective underwriting and pricing are significant drivers of the profitability of our life insurance business, and we have established rigorous underwriting and pricing practices to maximize our profitability. We retain approximately 89% of the risk we currently underwrite, thereby minimizing the premiums ceded to reinsurers. Our retention policy is to reinsure all risks in excess of \$1 million

124

---

per life, and the reinsured amount is generally based on the policy amount at the time of issue. We set pricing assumptions for expected claims, lapses, investment returns, expenses and customer demographics based on our own relevant experience and other factors. Our strategy is to price our products competitively for our target risk categories and not, necessarily, to be equally competitive in all categories.

Our current underwriting guidelines place each insurable life insurance applicant in one of eight primary risk categories, depending upon current health, medical history and other factors. Each of these eight categories has specific health criteria, including the applicant's history of using nicotine products. We consider each life insurance application individually and apply our guidelines to place each applicant in the appropriate risk category, regardless of face value or net amount at risk. We may decline an applicant's request for coverage if his health or lifestyle assessment is unacceptable to us. We do not delegate underwriting decisions to independent sales intermediaries or to our dedicated sales specialists. Instead, all underwriting decisions are made by our own underwriting personnel or by our automated underwriting system. We often share information with our reinsurers to gain their insights on potential mortality and underwriting risks and to benefit from their broad expertise. We use the information we obtain from the reinsurers to help us develop effective strategies to manage those risks.

We use independent laboratories to analyze blood and urine samples from applicants and to report their findings to us using standard laboratory techniques and metrics. For applicants of certain ages and for policies with higher face amounts, we collect and evaluate other medical information, such as EKGs and treadmill tests. We ask for comprehensive medical reports on an applicant when we believe existing medical risk factors make it appropriate to do so. We also actively monitor emerging medical technologies and diagnostic indicators, and we incorporate those in our underwriting process based on cost-effectiveness and market acceptance. We believe our monitoring and evaluation process facilitates more effective underwriting decisions and thereby improves our mortality performance.

A key part of our life insurance underwriting program is the streamlined, technology-enhanced process called GENIUS®, which automates new business processing for term life insurance. With this proprietary digital platform, our automated systems are capable of making up to 50% of our underwriting decisions. GENIUS® is designed to significantly shorten the cycle time from receipt-of-application to issuance-of-policy and to reduce our policy acquisition costs. GENIUS® also improves the consistency and accuracy of our underwriting decisions by reducing information and decision-making variation.

### **Long-term care insurance**

#### ***Overview***

We offer individual long-term care insurance products that provide protection against the high and escalating costs of long-term health care provided in the insured's home and in assisted living and nursing facilities. Insureds become eligible for benefits when they are incapable of performing certain activities of daily living or when they become cognitively impaired. In contrast to health insurance, long-term care insurance provides coverage for skilled and custodial care provided outside of a hospital. The typical claim covers a duration of care of 3 to 24 months.

We were the leading provider of individual long-term care insurance in 2003, according to LIMRA International, based upon number of policies sold and annualized first-year premiums. We established ourselves as a pioneer in long-term care insurance almost 30 years ago. Since that time, we have accumulated extensive pricing and claims experience, which we believe is the most comprehensive in the industry and has enabled us to build what we believe is the largest actuarial database in the industry. We believe our experience gives us a deep understanding of what is required for long term,

125

---

consistent success and has enabled us to develop a disciplined growth strategy built on a foundation of strong risk management, product innovation and a diversified distribution strategy.

Total individual long-term care insurance premiums for in-force policies in the U.S. increased from approximately \$2.4 billion in 1997 to \$6.6 billion in 2003, according to LIMRA International, representing a compound annual growth rate of 18.4%. We believe the long-term care insurance market will continue to expand over time as the result of aging demographics, increasing medical costs, the lack of alternate sources to cover these costs (such as Medicare) and increasing public awareness of the need for long-term care insurance. According to the American Society on Aging and Conning Research & Consulting, approximately 70% of individuals in the U.S. aged 65 and older will require long-term care at some time in their lives, but in 2001, only 7% of individuals in the U.S. aged 55 and older had long-term care insurance.

Given the relatively low penetration rate for long-term care insurance, we expect that sales of this product will increase with the growing public awareness of the discrepancy between long-term care costs and Medicare and other public benefits. As the leading provider of individual long-term care insurance, we have made significant investments to further the education and awareness of the benefits of long-term care insurance. Examples of these investments include the national sponsorship of the Alzheimer's Association annual Memory Walk, the creation of a national long-term care awareness day, and free access to our Center for Financial Learning website.

Our rigorous focus on risk management in long-term care insurance is a key part of our disciplined growth strategy and we believe it has differentiated us from our competitors. This focus includes strong pricing disciplines, intelligent product positioning, experienced-based underwriting, sound claims adjudication, disciplined asset-liability management and extensive in-force monitoring processes. Our critical product pricing assumptions such as lapse rates, investment yields, mortality and morbidity are based upon 30 years of experience. As part of our approach to product pricing we stress test all our morbidity and other pricing assumptions through stochastic modeling. Our products are positioned to be particularly attractive to certain segments of the population, based on age and marital status, where we see consistent, favorable claims experience. Our extensive pricing and claims experience and databases enable us to perform in depth analysis so that we can respond to emerging experience and execute product pricing strategies to achieve target returns. We have comprehensive underwriting processes including an experienced team of underwriters, the use of field underwriting procedures that leverage our 1,800 long term care sales specialists, and advanced analytics and technology to improve our risk assessment and operating efficiency. We believe we have one of the largest and most experienced claims organizations in the industry. Our claims adjudication process includes a pre-eligibility assessment by an experienced health professional to establish preliminary claims eligibility, followed by an on-site assessment and care coordination phase to validate eligibility and to design an appropriate plan of care. To mitigate exposure to interest rate risk, including interest rate risk on the investment of in-force premiums, we execute investment and hedging strategies designed to closely match the duration of assets and liabilities related to our long-term care policies. Finally, our in-force monitoring processes include on-going evaluations of product performance, external validation of risks and various simulation tests including stochastic modeling.



Throughout our history, we have consistently been a leader in product innovation. We were one of the first long-term care insurers to offer home care coverages and the first to offer shared plan coverage for married couples. We developed these innovations based upon our risk analytics and in response to policyholder needs and emerging claims experience. Our most recent innovations have included our policyholder wellness initiatives that are designed to improve the overall health of our policyholders. These initiatives provide valuable services to our policyholders, reduce claims expenses and differentiate us from our competitors.

We have a network of diversified sales channels for our long-term care insurance products and services, including a dedicated sales team of approximately 1,800 specialists that account for approximately 55% of our annualized first-year premiums. The balance of our new business comes from various other distribution relationships with financial intermediaries, independent producers and other affinity programs. More than 300 dedicated associates support these diversified distribution channels.

The following table sets forth, on an actual and pro forma basis, selected financial information regarding our long-term care insurance business, which includes long-term care insurance, Medicare supplement insurance, as well as several run-off blocks of accident and health insurance and corporate-owned life insurance, as of the dates and for the periods indicated:

	Historical			Pro forma
	As of or for the years ended December 31,			As of or for the year ended December 31,
	2003	2002	2001	2003
Net earned premiums	\$ 1,775	\$ 1,543	\$ 1,433	\$ 1,568
Annualized first-year premiums(1)	240	257	255	240
Revenues, net of reinsurance	2,417	2,087	1,921	2,103
Reserves	8,907	7,606	6,473	8,926

(Dollar amounts in millions)

- (1) Annualized first-year premiums reflect the amount of business we generated during each period shown and do not include renewal premiums on policies written during prior periods. We consider annualized first-year premiums to be a measure of our operating performance because they represent a measure of new sales of insurance policies during a specified period, rather than a measure of our revenues or profitability during that period. This operating measure enables us to compare our operating performance across periods without regard to revenues or profitability related to policies sold in prior periods or from investments or other sources.

#### Products

Our principal product is individual long-term care insurance. Prior to the mid-1990s, we issued primarily indemnity policies, which provide for fixed daily amounts for long-term care benefits. Since the mid-1990s, we have offered primarily reimbursement policies, which provide for reimbursement of documented expenses for nursing home, assisted living facilities or home care expenses. As of December 31, 2003, our in-force policies consisted of approximately 84% reimbursement policies and 16% indemnity policies, measured on a pro forma premium-weighted basis. Reimbursement policies permit us to review individual claims expenses and, therefore, provide greater control over claims cost management than indemnity policies.

Our current long-term care insurance product offerings include a comprehensive coverage product that includes features such as no elimination period for home-care benefits, international coverage and a choice between monthly maximum expense limits and daily limits. We also offer a lower-priced alternative that allows customization of individual benefit plans, including an option that provides reimbursement for 50% of home-care benefits.

Our products provide customers with a choice of a maximum period of coverage from two years to ten years, as well as lifetime coverage. Our current products also provide customers with different choices for the maximum reimbursement limit for their policy, with \$100 to \$150 per day being the most common choices nationwide. Our new policies can be purchased with a benefit increase option that provides for increases in the maximum reimbursement limit at a fixed rate of 5% per year, which helps to mitigate customers' exposure to increasing long-term care costs. Many long-term care insurance policies sold in the industry have a feature referred to as an elimination period that is a

minimum period of time that an insured must incur the direct cost of care before becoming eligible for policy benefits. Although many of our new policies have no elimination period for home care coverage, the majority of our new policies do have an elimination period for care provided in assisted living and nursing facilities. All of these product features allow customers to tailor their coverage to meet their specific requirements and allow us to price our products with better predictability regarding future claim costs.

We sell our long-term care insurance policies on a guaranteed renewable basis, which means that we are required to renew the policies each year as long as the premium is paid. The terms of all our long-term care insurance policies permit us to increase premiums during the premium-paying period if appropriate in light of our experience with a relevant group of policies, although historically it has been our practice not to do so. We may increase premiums on a group of policies in response to those policies' performance, subject to the receipt of regulatory approvals. However, we may not increase premiums due to changes in an individual's health status or age.

In addition to our individual long-term care insurance products, we also offer a group long-term care insurance program for GE employees in the U.S. This group program currently consists of approximately 40,000 long-term care insurance policies and accounted for approximately \$24 million of premiums for the year ended December 31, 2003.

We also offer Medicare supplement insurance that provides coverage for Medicare-qualified expenses that are not covered by Medicare because of applicable deductibles or maximum limits. Medicare supplement insurance often appeals to a similar sector of the population as long-term care insurance, and we believe we will be able to use our marketing and distribution strengths for long-term care insurance products to increase sales of Medicare supplement insurance.

The financial results of our long-term care insurance business also include the results of our Medicare supplement insurance product and several small run-off blocks of accident and health insurance products and corporate-owned life insurance. We believe that these blocks of business do not have a material effect on the results of our long-term care insurance business.

Prior to the completion of this offering, we will reinsure a block of our in-force long-term care insurance business with UFLIC, and we will assume a small in-force block of Medicare supplement insurance from UFLIC. See "Arrangements Between GE and Our Company—Reinsurance Transactions."

## ***Underwriting and pricing***

We employ extensive medical underwriting policies and procedures to assess and quantify risks before we issue our long-term care insurance policies. For individual long-term care products, we use underwriting criteria that are similar to, but separate from, those we use in underwriting life insurance products. Depending upon an applicant's age and health status, we use a variety of underwriting information sources to determine morbidity risk, or the probability that an insured will be unable to perform activities of daily living or suffer cognitive impairment, and eligibility for insurance. The process entails a comprehensive application that requests health, prescription drug and lifestyle- and activity-related information. Higher-risk applicants are also required to participate in an assessment process by telephone or in person. A critical element of this assessment process is a cognitive exam to identify early cognitive impairments. In addition, an experienced long-term care insurance underwriter conducts a comprehensive review of the application, the results of the assessment process and, in many cases, complete medical records from the applicant's physicians.

To streamline the underwriting process and improve the accuracy and consistency of our underwriting decisions, we implemented the GENIUS® automated underwriting technology in our long-term care insurance business beginning in January 2003. We currently process approximately 25% of our long-term care insurance applications through GENIUS®, and we expect to introduce further

128

---

enhancements in 2004 that will increase the use of GENIUS® in processing our long-term care insurance applications.

We believe we have one of the largest and most experienced long-term care insurance claims management operations in the industry. Our claims adjudication process includes, with respect to newer policies, a pre-claim assessment by an experienced health professional who establishes preliminary claims eligibility, followed by an on-site assessment and care coordination phase to validate eligibility and to work with the customer in determining an appropriate plan of care. Continued claims eligibility is verified through an ongoing eligibility assessment for existing claimants. We will continue to make investments in new processes and technologies that will improve the efficiency and effectiveness of our long-term care insurance expense tracking and claims decision-making process.

The overall profitability of our long-term care insurance policies depends to a large extent on the degree to which our claims experience, morbidity and mortality experience, lapse rates and investment yields match our pricing assumptions. We believe we have the largest actuarial database in the industry, derived from almost 30 years of experience in offering long-term care insurance products. This database has provided substantial claims experience and statistics regarding morbidity risk, which has helped us to develop a sophisticated pricing methodology tailored to segmented risk categories, depending upon marital status, medical history and other factors. We continually monitor trends and developments that may affect the risk, pricing and profitability of our long-term care insurance products and adjust our new product pricing and other terms as appropriate. We also work with a Medical Advisory Board, composed of independent experts from the medical and nursing care industries, that provides insights on emerging morbidity and medical trends, enabling us to be more proactive in our risk segmentation, pricing and product development strategies.

## **European payment protection insurance**

### ***Overview***

We provide payment protection insurance to customers throughout Europe. Payment protection insurance helps consumers meet their payment obligations on outstanding financial commitments, such as mortgages, personal loans or credit cards, in the event of a misfortune such as illness, involuntary unemployment, temporary incapacity, permanent disability or death. We currently offer payment protection insurance in the U.K., where we have offered the product for more than 30 years, and in 12 other European markets, including Denmark, Finland, France, Germany, Ireland, Italy, The Netherlands, Norway, Portugal, Spain, Sweden and Switzerland.

Finaccord, an industry research firm, estimates that, in 2002, gross written premiums for payment protection insurance with an involuntary unemployment, temporary incapacity, permanent disability or death element were approximately €25.7 billion in the U.K. and the six other European countries it reviewed. Between 1998 to 2002, Finaccord estimates that the average annual growth rates in these seven countries were approximately 10% for retail lending balances and 16.9% for mortgage loans. The U.K. is the largest and most mature market compared to the Republic of Ireland and countries in Continental Europe. Although recent growth rates and margins have varied throughout Continental Europe, they are generally significantly higher than in the U.K.

We distribute our payment protection products primarily through financial institutions, such as major European banks, which offer our insurance products in connection with underlying loans or other financial products they sell to their customers. Under these arrangements, the distributors typically take responsibility for branding and marketing the products, allowing us to take advantage of their distribution capabilities, while we take responsibility for pricing, underwriting and claims payment. As of December 31, 2003, we had arrangements with approximately 87 distributors, including 63 outside the U.K.

We continue to implement innovative methods for distributing our payment protection insurance products, including using web-based tools that provide our distributors with a cost-effective means of

129

---

applying and selling our products in combination with a broad range of underlying financial products. We believe these innovative methods also will make it easier to establish arrangements with new distributors.

During the year ended December 31, 2003, we entered into 31 new arrangements with financial institutions in Continental Europe and the Republic of Ireland and one new arrangement in the U.K. As we enter into new arrangements and as existing arrangements become due for renewal, we are focused on maintaining a disciplined approach to growth, with an emphasis on arrangements that achieve our targeted returns on capital and increase our operating earnings.

For a description of the arrangements pursuant to which we will acquire the European payment protection business from affiliates of GE, see "Arrangements Between GE and Our Company—European Payment Protection Insurance Business Arrangements."

### ***Products***

Our principal product is payment protection insurance, which can support any loan, credit agreement or other financial commitment. Depending upon the type of financial product or commitment, our policies may cover all or a portion of the policyholder's obligation or may cover monthly payments for a fixed period of time. We are able to customize the circumstances under which benefits are paid from among the range of events that can prevent policyholders from meeting their payment obligations. In the event of a policyholder's illness, involuntary unemployment or other temporary inability to work, we cover monthly payment obligations until the policyholder is able to return to work, usually subject to a maximum period of 24 months. In the event of a policyholder's death or permanent disability, we typically repay the entire covered obligation.

In addition to payment protection insurance, we offer related consumer protection products, primarily in the U.K., including:

- Personal accident insurance, which provides a lump-sum benefit in the event that the policyholder sustains a temporary or permanent disability or death as the result of an accident;
- Guaranteed asset protection, which, in the event of an automobile accident, covers any shortfall between the insured value of the vehicle and any outstanding balance under the related loan;
- Purchase protection, which covers losses in the event that products purchased with a credit or debit card are lost, damaged or stolen within a specified period after purchase; and
- Travel insurance, which provides benefits following certain events, such as trip cancellation, medical emergency or death, and the incurrence of legal expenses while traveling. We decided to discontinue this business as of January 1, 2004 because of unfavorable returns, although we will continue to write new consumer policies under our existing contracts with distributors until these contracts expire.

With the exception of our travel insurance arrangements, we will continue to evaluate opportunities to take advantage of our European operations and distribution infrastructure to offer these, and other consumer protection insurance products, more broadly throughout Europe.

130

The following table sets forth selected financial information regarding our payment protection insurance and other related consumer protection insurance products as of the dates and for the periods indicated:

	Historical		
	As of or for the years ended December 31,		
	2003	2002	2001
<b>(Dollar amounts in millions)</b>			
Gross written premiums	\$ 1,532	\$ 1,548	\$ 1,229
Net earned premiums	1,507	1,242	1,161
Annualized first-year premiums <sup>(1)</sup>	1,735	1,611	1,131
Total revenues, net of reinsurance	1,615	1,372	1,303
Losses and loss adjustment expenses	376	307	266
Reserves	2,425	2,342	1,949

- (1) Annualized first-year premiums reflect the amount of business we generated during each period shown and do not include renewal premiums on policies written during prior periods. We consider annualized first-year premiums to be a measure of our operating performance because they represent a measure of new sales of insurance policies during a specified period, rather than a measure of our revenues or profitability during that period. This operating measure enables us to compare our operating performance across periods without regard to revenues or profitability related to policies sold in prior periods or from investments or other sources.

We work with our distributors to design and promote insurance products in ways that best complement their product strategies and risk profiles and to ensure that our products comply with all applicable consumer regulations. Through this close cooperation, we believe there are opportunities to increase the benefit of these arrangements by extending our payment protection insurance products across the full range of consumer finance products offered by our distributors. We are also working closely with our distributors to help them increase the percentage of their customers who purchase our protection insurance at the time they enter into a loan or financial commitment and reduce the percentage of customers who elect not to renew our policies upon expiration. Consumers generally pay premiums for our insurance to our distributors, who in turn forward these payments to us, typically net of commissions.

The following table sets forth gross written premiums for payment protection insurance and other related consumer protection products, based upon the residence of the consumer (not the location of the distributor) for each of the periods indicated:

	Historical		
	Years ended December 31,		
	2003	2002	2001
<b>(Dollar amounts in millions)</b>			
<b>Gross written premiums by region</b>			
U.K. and Republic of Ireland	\$ 1,097	\$ 1,231	\$ 960
France	193	147	130
Nordic region <sup>(1)</sup>	136	104	76
Southern region <sup>(2)</sup>	76	43	47
Central region <sup>(3)</sup>	30	23	16
<b>Total gross written premiums</b>	<b>\$ 1,532</b>	<b>\$ 1,548</b>	<b>\$ 1,229</b>

- (1) Finland, Sweden, Norway and Denmark.
- (2) Portugal, Spain and Italy.
- (3) Germany, Switzerland and The Netherlands.

Our payment protection insurance business is concentrated with relatively few large distributors, and our top five distributors accounted for 64% of our annualized first-

ended December 31, 2003, compared to 68% during the year ended December 31, 2002. Similarly, during the year ended December 31, 2003, the U.K. accounted for approximately 58% of our annualized first-year premiums. Our top five U.K. distributors accounted for 52% of our total annualized first-year premiums.

For the years ended December 31, 2003 and 2002, GE's consumer finance division and other relaxed GE entities accounted for 19% and 14% of our European payment protection insurance gross written premiums, respectively. Prior to the completion of this offering, we will enter into a five-year agreement, subject to certain early termination provisions, that extends our relationship with GE's consumer finance division and provides us with the right to be the exclusive provider of payment protection insurance in Europe for GE's consumer finance operations in jurisdictions where we offer these products.

Consistent with our focus on disciplined growth and returns on capital, as we enter into new arrangements and review existing arrangements with distributors, we will seek to manage these arrangements and deploy capital where we believe we can achieve the highest returns while strengthening our client relationships. In some cases, particularly in the U.K., we have arrangements in place that account for significant revenue without a corresponding benefit to returns on capital. As these arrangements come up for renewal, we intend to reprice these arrangements more favorably, or if this is not possible for competitive or other reasons, in most cases we will not renew them. For example, we did not renew arrangements with our largest distributor (as measured by gross written premiums), a large U.K. bank, which accounted for 25% of gross written premiums during the year ended December 31, 2003, when these arrangements expired at the end of 2003. Although we expect our revenue to decline significantly over the next few years as existing policies from these less profitable arrangements begin to run off, we believe this will not have a material impact on our operating earnings and will have a favorable effect on our returns as capital is released and redeployed into markets with potential for higher growth and returns.

We are continuing to diversify and expand our base of distributors. We are also exploring growth opportunities in Central and Eastern Europe, which we believe will be increasingly receptive to payment protection insurance as consumer lending further develops in those markets. In addition, we believe the accession of additional countries to the European Union will facilitate our entry into those markets.

### *Underwriting and pricing*

We have more than 30 years of experience in underwriting payment protection insurance. Consistent with market practices, our payment protection insurance currently is underwritten and priced on a program basis, by type of product and by distributor, rather than on the basis of the characteristics of the individual policyholder. In setting prices, we take into account the underlying obligation, the particular product features and the average customer profile of the distributor (including data such as customer age, gender and occupation). We also consider morbidity and mortality rates, lapse rates and investment yields in pricing our products. We believe our experience in underwriting allows us to provide competitive pricing to distributors and generate targeted returns and profits for our business.

### **Group life and health insurance**

#### *Overview*

We offer a full range of employment-based benefit products and services to employers with fewer than 1,000 employees, as well as select groups within larger companies that require highly customized benefit plans. We refer to our group life and health insurance business as the Employee Benefits Group. This group's products include group non-medical insurance products, such as dental, vision, life and disability insurance; group medical insurance products, such as stop loss insurance and fully insured medical; and individual voluntary products. We use an independent network of approximately 5,000 licensed group life and health insurance brokers and agents, supported by our nationwide sales force of approximately 100 employees, to distribute our group life and health insurance products. Individual voluntary products are sold through employers and other worksite-based groups using a network of independent insurance producers. As of December 31, 2003, our Employee Benefits Group provided employment-based benefit products and services to more than 29,000 organizations, including approximately 2.2 million plan participants.

Many of the employers in our target market do not have large human resource departments with individuals devoted to benefit design, administration and budgeting. As a result, we work closely with independent group benefit brokers and the end customer or employer to design benefit plans to meet the employer's particular requirements. Our customers are small and mid-size employers that require knowledgeable independent group benefit brokers and insurance company representatives to understand their individual financial needs and employee profiles and to structure benefit plans that are appropriate for their particular size, geographical markets and resources. We believe our extensive experience and expertise in group life and health insurance products provide us with opportunities to foster close broker relationships and to assist employers in designing benefit plans, as well as selling traditional insurance products.

The following table sets forth selected financial information regarding our group life and health insurance products as of the dates and for the periods indicated:

	Historical		
	As of or for the years ended December 31,		
	2003	2002	2001
<i>(Dollar amounts in millions)</i>			
<b>Net earned premiums</b>			
Group non-medical insurance	\$ 393	\$ 402	\$ 440
Group medical insurance	179	178	136
Individual voluntary products	36	38	34
<b>Total net earned premiums</b>	<b>\$ 608</b>	<b>\$ 618</b>	<b>\$ 610</b>
<b>Annualized first-year premiums(1)</b>			
Group non-medical insurance	\$ 95	\$ 93	\$ 79
Group medical insurance	35	58	57
Individual voluntary products	14	17	13
<b>Total annualized first-year premiums</b>	<b>\$ 144</b>	<b>\$ 168</b>	<b>\$ 149</b>

<b>Revenues, net of reinsurance</b>			
Group non-medical insurance	\$ 428	\$ 448	\$ 491
Group medical insurance	210	224	179
Individual voluntary products	39	42	38
<b>Total revenues, net of reinsurance</b>	<b>\$ 677</b>	<b>\$ 714</b>	<b>\$ 708</b>
<b>Reserves</b>			
Group non-medical insurance	\$ 1,034	\$ 1,036	\$ 1,021
Group medical insurance	62	72	64
Individual voluntary products	40	39	38
<b>Total reserves</b>	<b>\$ 1,136</b>	<b>\$ 1,147</b>	<b>\$ 1,123</b>
<b>Coverages(2)</b>			
Group non-medical insurance	40,802	41,234	40,689
Group medical insurance	1,517	1,823	1,745
Individual voluntary products	3,446	3,320	3,531

- (1) Annualized first-year premiums reflect the amount of business we generated during each period shown and do not include renewal premiums on policies written during prior periods. We consider annualized first-year premiums to be a measure of our operating performance because they

133

represent a measure of new sales of insurance policies during a specified period, rather than a measure of our revenues or profitability during that period. This operating measure enables us to compare our operating performance across periods without regard to revenues or profitability related to policies sold in prior periods or from investments or other sources.

- (2) "Coverages" refers to covered groups within a line of coverage. A "covered group" consists of all the employees of a covered company or a select group of employees within a company. A covered group with multiple lines of coverage is counted separately for each line of coverage.

### **Products**

We offer a full range of employee benefits products for the group, group voluntary and individual voluntary markets. We sell group benefits exclusively to employers, which pay all or most of the applicable premiums. We sell group voluntary and individual voluntary benefits through employers to employees, who generally pay all or most of the premiums through payroll deductions. Coverage in both group and group voluntary benefits generally ceases upon the termination of employment, whereas coverage in individual voluntary benefits continues after the termination of employment. Voluntary benefit products enable an employer to expand its available employee benefits without adding to the company's costs. As a result, these programs allow employees to select benefit packages to meet their individual and family needs and budgets, generally at lower premiums than they would pay for comparable benefit packages assembled independently. Employers help to administer group and group voluntary benefits, and we administer individual voluntary benefits with little involvement from employers.

#### *Group non-medical insurance*

Our group non-medical insurance consists of dental and vision, life and disability insurance products.

*Dental and vision insurance.* Our group dental coverage provides benefits to insured employees and their eligible dependents for specified dental services. We also offer dental managed-care plans, which provide differentiated benefit levels depending upon whether the dental provider is a member of a nationwide network. Vision coverage generally is offered as a supplement to dental coverage.

*Life insurance.* Our group term life insurance product provides benefits in the event of an insured employee's death. The death benefit can be based upon an individual's earnings or occupation, or can be fixed at a set dollar amount. Our products also include optional accidental death and dismemberment coverage as a supplement to our term life insurance policies. This coverage provides benefits for an insured employee's loss of life, limb or sight as a result of accidental death or injury.

*Disability insurance.* Our group long-term disability coverage is designed to cover the risk of employee loss of income during prolonged periods of disability. Our group short-term disability coverage provides partial replacement of an insured employee's weekly earnings in the event of disability resulting from an injury or illness. Benefits can be a set dollar amount or based upon a percentage of earnings.

#### *Group medical insurance*

Our group medical insurance consists of stop loss insurance and fully insured medical.

*Stop loss insurance.* Our stop loss insurance coverage is written for employers that self-insure their employee medical benefits and covers the risk of higher-than-expected claims experience. Our coverage provides reimbursement for claims in excess of a predetermined level.

134

We recently launched GE Health Manager™, which is an integrated self-funded medical benefits program that provides employers with stop-loss reinsurance coverage coupled with administrative services. GE Health Manager™ provides simplified on-line administration and effective claims management to employers in our target market.

This integrated product provides us with the ability to analyze claims expenses and frequencies and suggest alternative premium structures and customized services to reduce employers' benefits costs.

*Fully insured medical.* Our group medical coverage provides benefits for insured employees and their dependents for hospital, surgical and ancillary medical expenses. We offer several types of plans with a wide range of plan features, such as indemnity plans, which contain deductibles and co-insurance payments, and preferred provider organization plans, or PPO plans, which reduce deductibles and co-insurance payments for medical services provided by members of a preferred provider network of healthcare providers.

We have purchased excess-of-loss reinsurance coverage to limit our exposure to losses from our group medical insurance policies. This reinsurance covers losses in excess of specified amounts arising from individual claims, as well as aggregate claims from a single group. Our annualized first-year premiums for group medical coverage declined in recent years in part as a result of our decision to concentrate our fully-insured medical plans in limited segments of the employer market where we believe we can achieve our target returns.

#### *Individual voluntary products*

We offer individual voluntary life and health insurance and annuity contracts through worksite marketing programs in which our representatives visit employer premises and make presentations to employees. Our individual health coverage consists primarily of short-term disability benefits with benefit periods generally ranging from nine months to two years. Although the policies are sold in connection with a benefit package offered to company employees, each policyholder receives an individual policy, and coverage can continue after termination of employment if the policyholder continues to make premium payments.

#### **Underwriting and pricing**

Group insurance pricing is different from individual product pricing in that it reflects the group's claims experience, when appropriate. The risk characteristics of each group are reviewed at the time the policy is issued and each year thereafter, resulting in ongoing adjustments to the group's pricing. The key rating and underwriting criteria are the group's demographic composition, including the age, gender and family composition of the group's members, the industry of the group, geographic location, regional economic trends, plan design and the group's prior claims experience.

We have a data warehouse that is integrated with all our claims processing systems. The data warehouse contains at least seven years of experience for each product that helps us predict future experience by modeling the impact of changes in current rates against historic claims. Our automated underwriting quotation and renewal systems efficiently process low-risk cases and identify high-risk cases for further underwriter review. We also have developed proprietary automated underwriting techniques that enhance the speed and accuracy of, and reduce variations in, our underwriting decision-making.

#### **Competition**

We face significant competition in all our Protection segment operations. Our competitors include other large and highly rated insurance carriers. Some of these competitors have greater resources than we do, and many of them offer similar products and use similar distribution channels. We also face competition in our life, long-term care and group insurance product lines for independent sales

135

---

intermediaries and our dedicated sales specialists. This competition is based primarily upon product pricing and features, compensation and benefits structure and support services offered. We continuously provide technology upgrades and enhanced training, and we seek to improve service for our independent sales intermediaries and dedicated sales specialists.

In our European payment protection insurance business, we are one of the few payment protection insurance providers with operations across Europe. Our competitors are divided into two broad groups: the large pan-European payment protection providers and local competitors, consisting principally of smaller national insurance companies. We also compete with captive insurers, particularly in the U.K., as our distributors increasingly consider the benefits of providing payment protection insurance directly to their customers.

### **Retirement Income and Investments**

#### **Overview**

Through our Retirement Income and Investments segment, we offer fixed deferred, fixed immediate, and variable deferred annuities. We offer these products to a broad range of consumers, generally aged 45 and older, who want to accumulate tax-deferred assets for retirement, desire a tax-efficient source of income during their retirement, and seek to protect against outliving their assets during retirement. According to LIMRA International, sales of individual annuities were \$220 billion in 2002, the last year for which industry data regarding aggregate sales of individual annuities is available, compared to \$185 billion in 2001. For the year ended December 31, 2003, based upon total premiums and deposits, we were the largest provider of income annuities in the U.S., according to LIMRA International.

We offer fixed and variable deferred annuities, in which assets accumulate until the contract is surrendered, the contractholder dies or the contractholder begins receiving benefits under an annuity payout option, as well as retirement or fixed immediate annuities, in which payments begin within one year of issue and continue for a fixed period or for life. We believe our wide range of fixed annuity products has provided a stable source of asset growth during volatile equity and bond markets in recent years, and our variable annuity offerings continue to appeal to contractholders who wish to participate in returns linked to equity and bond markets. We also offer variable life insurance through our Retirement Income and Investments segment because this product provides investment features that are similar to our variable annuity products.

In addition to our annuity and variable life insurance products, we also offer a number of specialty products, including guaranteed investment contracts, or GICs, funding agreements and structured settlements. We sell GICs to ERISA-qualified plans, such as pension and 401(k) plans, and we sell funding agreements to money market funds that are not ERISA-qualified and to other institutional investors. Our structured settlements provide an alternative to a lump sum settlement generally in a personal injury lawsuit and typically are purchased by property and casualty insurance companies for the benefit of an injured claimant with benefits scheduled to be paid throughout a fixed period or for the life of the claimant. In addition, we offer private asset management services for affluent individual investors.

We structure our annuity products through a rigorous pricing and underwriting process designed to achieve targeted returns based upon each product's risk profile and our expected rate of investment returns. We compete for sales of annuities through competitive pricing policies and innovative product design. For example, we recently introduced the GE Retirement Answer®, or GERA™, which is an annuity product that guarantees a minimum income stream to the contractholder at the end of an accumulation period, but avoids a number of the risks to the insurer that generally accompany traditional products with guaranteed minimum income benefits. We also expect to continue to

136

---

differentiate ourselves through other innovative products, and we are developing a suite of additional retirement income products for launch in 2004.

We offer our annuities and other investment products primarily through financial institutions and specialized brokers, as well as independent accountants and independent advisers associated with our captive broker dealer.

The following table sets forth selected information regarding the products we offer through our Retirement Income and Investments segment as of the dates and for the periods indicated:

	Historical		
	As of or for the years ended December 31,		
	2003	2002	2001
<b>(Dollar amounts in millions)</b>			
<b>Spread-Based Retail Products</b>			
<b>Fixed annuities</b>			
Account value net of reinsurance, beginning of period	\$ 13,753	\$ 11,965	\$ 10,753
Deposits	1,069	2,663	2,434
Interest credited	603	606	552
Surrenders and benefits	(1,248)	(1,471)	(1,763)
Product charges	(11)	(10)	(11)
Account value net of reinsurance, end of period	\$ 14,166	\$ 13,753	\$ 11,965
<b>Income annuities</b>			
Account value net of reinsurance, beginning of period	\$ 4,673	\$ 4,002	\$ 3,456
Net earned premiums and deposits	717	979	786
Interest credited	292	277	253
Surrenders and benefits	(650)	(562)	(471)
Product charges	(24)	(23)	(22)
Account value net of reinsurance, end of period	\$ 5,008	\$ 4,673	\$ 4,002
<b>Structured settlements(1)</b>			
Account value, beginning of period	\$ 11,544	\$ 11,098	\$ 10,279
Net earned premiums and deposits	581	516	856
Interest credited	827	797	770
Surrenders and benefits	(912)	(847)	(778)
Product charges	(23)	(20)	(29)
Account value, end of period	\$ 12,017	\$ 11,544	\$ 11,098
Total annualized first-year premiums from spread-based retail products(2)	\$ 1,045	\$ 991	\$ 1,023
Total deposits on spread-based retail products(3)	1,322	3,167	3,053
<b>Spread-Based Institutional Products</b>			
<b>GICs and funding agreements</b>			
Account value, beginning of period	\$ 10,274	\$ 8,693	\$ 5,800
Deposits (4)	3,702	3,862	4,228
Interest credited	296	230	315
Surrenders and benefits (4)	(4,745)	(2,511)	(1,650)
Account value, end of period	\$ 9,527	\$ 10,274	\$ 8,693
Total deposits on spread-based institutional products(3)(4)	\$ 3,702	\$ 3,862	\$ 4,228

As of or for the years ended  
December 31,

2003                      2002                      2001

(Dollar amounts in millions)

**Fee-Based Products**

**Variable annuities(1)**

Account value, beginning of period	\$ 9,048	\$ 10,168	\$ 10,700
Deposits	2,102	1,667	2,309
Interest credited and investment performance	1,356	(1,091)	(1,530)
Surrenders and benefits	(1,483)	(1,571)	(1,172)
Product charges	(119)	(125)	(139)
Account value, end of period	<u>\$ 10,904</u>	<u>\$ 9,048</u>	<u>\$ 10,168</u>

**Variable life insurance**

Deposits	\$ 45	\$ 47	\$ 53
Future policy benefits/policy account balances, net of reinsurance	12	8	3
Separate account liability	269	220	255
Life insurance in force	3,630	3,628	3,476

**Asset management**

Revenues	\$ 32	\$ 40	\$ —
Deposits(5)	760	650	—
Assets under management	2,395	1,762	1,836
Total deposits on fee-based products(3)	2,907	2,364	2,362

- (1) Prior to the completion of this offering, we will cede to UFLIC, effective as of January 1, 2004, all of our in-force structured settlement contracts and substantially all of our in-force variable annuity contracts.
- (2) Represents annualized first-year premiums earned on spread-based income annuities and structured settlements with life contingencies. Annualized first-year premiums reflect the amount of business we generated during each period shown and do not include renewal premiums on policies written during prior periods. We consider annualized first-year premiums to be a measure of our operating performance because they represent a measure of new sales of insurance policies during a specified period, rather than a measure of our revenues or profitability during that period. This operating measure enables us to compare our operating performance across periods without regard to revenues or profitability related to policies sold in prior periods or from investments or other sources.
- (3) Represents deposits received on spread-based non-life-contingent products and on fee-based products. We consider deposits, like annualized first-year premiums, to be a measure of our operating performance because they represent a measure of additional investments by our customers during a specified period, rather than a measure of our revenues or profitability during that period.
- (4) "Surrenders and benefits" include contracts that have matured but are redeposited with our company and reflected as deposits. In the years ended December 31, 2003, 2002 and 2001, surrenders and benefits of spread-based institutional products included \$1,675 million, \$800 million and \$485 million, respectively, that was redeposited and reflected under "Deposits."
- (5) Our clients own the assets deposited in our asset management products, and we receive a management fee based on the amount of assets under management.

138

The following table sets forth, on an actual and pro forma basis, selected financial information regarding our Retirement Income and Investments segment as of the dates and for the periods indicated:

	As of or for the years ended December 31,			Pro forma
	2003	2002	2001	As of or for the year ended December 31,
	2003			
<b>(Dollar amounts in millions)</b>				
<b>Net earned premiums</b>				
Spread-based retail products	\$ 1,045	\$ 991	\$ 1,023	\$ 1,045
Spread-based institutional products	—	—	—	—
Fee-based products	—	—	—	—
Total net earned premiums	<u>\$ 1,045</u>	<u>\$ 991</u>	<u>\$ 1,023</u>	<u>\$ 1,045</u>
<b>Revenues, net of reinsurance</b>				
Spread-based retail products	\$ 3,111	\$ 3,028	\$ 2,992	\$ 2,238



Spread-based institutional products	346	419	464	346
Fee-based products	324	309	265	123
Total revenues, net of reinsurance	\$ 3,781	\$ 3,756	\$ 3,721	\$ 2,707
<b>Segment net earnings</b>				
Spread-based retail products	\$ 109	\$ 119	\$ 164	\$ 60
Spread-based institutional products	29	47	43	29
Fee-based products	13	20	8	4
Total segment net earnings	\$ 151	\$ 186	\$ 215	\$ 93
<b>Assets</b>				
Spread-based retail products	\$ 34,255	\$ 33,493	\$ 30,377	\$ 32,122
Spread-based institutional products	9,346	10,175	9,129	9,346
Fee-based products	12,013	9,956	11,006	11,207
Total assets	\$ 55,614	\$ 53,624	\$ 50,512	\$ 52,675

## Products

### *Spread-Based Retail Products*

#### *Fixed annuities*

We offer fixed single premium deferred annuities, or SPDAs, which provide for a single premium payment at time of issue, an accumulation period and an annuity payout period at some future date. We also offer fixed annuities that permit additional deposits to be made into the contract after the time of issue. During the accumulation period, we credit the account value of the annuity with interest earned at an interest rate, called the crediting rate. The crediting rate is guaranteed initially for a period of one to seven years, at the contractholders' option, and thereafter is subject to change based upon competitive factors, prevailing market rates and product profitability. Each contract also has a minimum guaranteed crediting rate. Our fixed annuity contracts are funded by our general account, and the accrual of interest during the accumulation period is generally on a tax-deferred basis to the owner. The majority of our fixed annuity contractholders retain their contracts for 5 to 10 years. After the period specified in the annuity contract, the contractholder may elect to take the proceeds of the annuity as a single payment or over time.

139

Our fixed annuity contracts permit the contractholder at any time during the accumulation period to withdraw all or part of the single premium paid, plus the amount credited to his account, subject to contract provisions such as surrender charges that vary depending upon the terms of the product. The contracts impose surrender charges that typically vary from 5.0% to 8.0% of the account value, starting in the year of deposit and decreasing to zero over a 5- to 9-year period. The contractholder also may withdraw annually up to 10% of the account value without penalty. Approximately \$10.4 billion, or 73.8% of the total account value of our fixed annuities as of December 31, 2003, were subject to surrender charges.

At least once each month, we set an interest crediting rate for newly issued fixed SPDAs and additional deposits. We maintain the initial crediting rate for a minimum period of one year or the guarantee period, whichever is longer. Thereafter, we may adjust the crediting rate no more frequently than once per year for any given deposit. Our in-force fixed annuity products generally have minimum guaranteed crediting rates ranging from 3.0% to 5.5% for the life of the contract, and currently we are crediting rates between 3.0% and 4.0% on a majority of those products. The most frequent minimum guaranteed crediting rate as of December 31, 2003 was 3.0%. We are in the process of filing new products with lower minimum guaranteed crediting rates and, as of December 31, 2003, we have received regulatory approval from 45 states. Minimum guaranteed rates will not change for our in-force contracts.

Our earnings from fixed annuities are based upon the spread between the crediting rate on our fixed annuity contracts and the returns we earn on our investment of premiums in our general account.

#### *Income annuities*

We offer income annuities, also known in the industry as single premium immediate annuities, or SPIAs, which provide for a single premium at the time of issue and guarantee a series of payments beginning within one year of the issue date and continuing over a period of years.

Our income annuities differ from deferred annuities in that they provide for contractually guaranteed payments that begin within one year of issue. Income annuities are not subject to surrender or borrowing by the contractholder, and therefore they provide us with the opportunity to match closely the underlying investment of the deposit received to the cash benefits to be paid under a policy and provide for an anticipated margin for expenses and profit, subject to credit, reinvestment and, in some cases, mortality risk.

The two most common types of income annuities are the life-contingent annuity, which makes payments for the life of a contractholder, and the joint and survivor annuity, which continues to make payments to a second contractholder, such as a spouse, after the death of the contractholder. We also offer period certain annuities, which make payments for a minimum period from 5 to 20 years even if the contractholder dies within the term certain period. Income annuities typically are sold to contractholders approaching retirement. We anticipate higher sales of income annuities with the demographic shift toward more people reaching retirement age and focusing on their need for dependable retirement income.

#### *Structured settlements*

Structured settlement contracts provide an alternative to a lump-sum settlement, generally in a personal injury lawsuit, and typically are purchased by property and casualty insurance companies for the benefit of an injured claimant. The structured settlements provide scheduled payments over a fixed period or, in the case of a life-contingent structured settlement, for the life of the claimant with a guaranteed minimum period of payments. These settlements offer tax-advantaged, long-range financial security to the injured party and facilitate claim settlement for the property and casualty insurance

140

carrier. Structured settlement contracts are long-term in nature, guarantee a fixed benefit stream and generally do not permit surrender or borrowing against the amounts

outstanding under the contract.

Prior to the completion of this offering, GE Capital guaranteed some of our structured settlement contracts. After the completion of this offering, GE Capital will no longer guarantee any of our new structured settlement contracts.

Prior to the completion of this offering, we will reinsure all of our in-force structured settlements business with UFLIC. See "Arrangements Between GE and Our Company—Reinsurance Transactions." We intend to continue to write structured settlements on a limited, opportunistic basis at targeted returns, capitalizing on our experience and relationships in this product which may result in decreased sales of structured settlements.

### ***Spread-Based Institutional Products***

#### *Guaranteed investment contracts and funding agreements*

We offer guaranteed investment contracts, or GICs, and funding agreements, which are deposit-type products that pay a guaranteed return to the contractholder on specified dates. GICs are purchased by ERISA-qualified plans, including pension and 401(k) plans. Funding agreements are purchased by institutional accredited investors for various kinds of funds and accounts that are not ERISA-qualified. Purchasers of funding agreements include money market funds, bank common trust funds and other corporate and trust accounts and private investors in the U.S. and other countries.

Substantially all our GICs allow for the payment of benefits at contract value to ERISA plan participants prior to contract maturity in the event of death, disability, retirement or change in investment election. We carefully underwrite these risks before issuing a GIC to a plan and historically have been able to effectively manage our exposure to these benefit payments. Our GICs typically credit interest at a fixed interest rate and have a fixed-maturity generally ranging from two to six years. Contractholders may terminate our GICs upon 90 days' notice, but subject to an adjustment to the contract value for changes in the level of interest rates from the time the GIC was issued.

Our funding agreements generally credit interest on deposits at a floating rate tied to an external market index. To hedge our exposure to fluctuations in interest rates, we invest the proceeds backing floating-rate funding agreements in floating-rate assets. Some of our funding agreements are purchased by money market funds, bank common trust funds and other short-term investors. These funding agreements typically are renewed annually, and generally contain "put" provisions, through which the contractholder has an option to terminate the funding agreement for any reason after giving notice within the contract's specified notice period, which is generally 90 days but can be less than 30 days. GE Capital has agreed to guarantee our obligations under these funding agreements that were issued prior to November 18, 2003 and certain renewals with a final maturity on or before June 30, 2005. As of December 31, 2003, the aggregate amount outstanding of these funding agreements was approximately \$2.9 billion, including \$450 million with put option notice periods of 30 days or less, compared to an aggregate of \$3.7 billion as of December 31, 2002. We issue the remainder of our funding agreements to trust accounts to back medium-term notes purchased by investors. These funding agreements contain no early termination provisions and typically are issued for terms of one to seven years. As of December 31, 2003, the aggregate amount of these type of funding agreements was \$3.0 billion, compared to \$3.1 billion as of December 31, 2002.

In addition to the GICs that we offer, prior to the completion of this offering, we also will enter into three agreements with affiliates of GE to manage a pool of municipal guaranteed investment contracts issued by those affiliates. Pursuant to these agreements, we will originate GIC liabilities and advise the GE affiliates regarding the investment, administration and management of their assets that support those liabilities. Under two of those agreements, we will receive an administration fee of

141

---

0.165% per annum of the maximum program size for those GE affiliates, which was an aggregate of \$15.0 billion as of December 31, 2003. The agreements also provide for termination fees in the event of early termination at the option of either affiliate. Under a third agreement with another affiliate, we will receive a management fee of 0.10% per annum of the book value of the investment contracts or similar securities issued by this affiliate after January 1, 2003, which was \$912 million as of December 31, 2003. The fee we will receive on the contracts issued by that affiliate before January 1, 2003 will be based upon a pricing arrangement that will vary depending upon the maturities of those contracts and that affiliate's cost of capital. The book value of the contracts issued before January 1, 2003 was \$2,008 million as of December 31, 2003 and is expected to generate a weighted average fee of approximately 0.35% in 2004. We also will receive reimbursement of our operating expenses under each of the agreements. The initial term of each of the three agreements will expire December 31, 2006, and unless terminated at the option of either party, each agreement will automatically renew on January 1 of each year for successive terms of one year. See "Arrangements Between GE and Our Company—Relationship with GE—Liability and Portfolio Management Agreements."

### ***Fee-Based Products***

#### *Variable annuities*

We offer variable annuities that allow the contractholder to make payments into separate investment accounts, as determined by the contractholder. Like a deferred fixed annuity, a deferred variable annuity has an accumulation period and a payout period. The main difference between our fixed annuity products and our variable annuity products is that the variable annuities allow the contractholder to allocate all or a portion of his account value to separate accounts that invest in investment accounts that are distinct from our general account and track the performance of selected mutual funds, including offerings from Fidelity, AIM and GE. There is no guaranteed minimum rate of return in these subaccounts, and the contractholder bears the entire risk associated with the performance of these subaccounts. Some of our variable annuities also permit the contractholder to allocate all or a portion of his account value to our general account, in which case we credit interest at specified rates, subject to certain guaranteed minimums, which are comparable to the minimum rates in effect for our fixed annuities.

Similar to our fixed annuities, our variable annuity contracts permit the contractholder to withdraw all or part of the premiums paid, plus the amount credited to his account, subject to contract terms such as surrender charges. The cash surrender value of a variable annuity contract depends upon the value of the assets that have been allocated to the contract, how long those assets have been in the contract and the investment performance of the mutual funds to which the contractholder has allocated assets.

Variable annuities provide us with fee-based revenue in the form of expense charges and, in some cases, mortality charges. These fees equal a percentage of the contractholder's assets in the separate account and typically range from 1.25% to 1.70% per annum. We also receive fees charged on assets allocated to our separate account to cover administrative costs, as well as a portion of the management fees from the mutual funds in which assets are invested.

We also offer variable annuities with fixed account options and with bonus features. Variable annuities with fixed account options enable the contractholder to allocate a portion of his account value to the fixed account, which pays a fixed interest crediting rate. The portion of the account value allocated to the fixed account option represents general account liability for us and functions similarly to a traditional fixed annuity, whereas for the portion allocated to the separate account, the contractholder bears the investment risk. Our variable annuities with bonus features entitle the contractholder to an additional increase to his account value upon making a deposit. However, variable

142

---

annuities with bonus features are subject to different surrender charge schedules and expense charges than variable annuities without the bonus feature.

We provide our variable annuity contractholders with the option to purchase, as a separate rider, a guaranteed minimum death benefit, or GMDB, which provides the contractholder's survivors a minimum account value upon the contractholder's death. As of December 31, 2003, the account value of our variable annuities with GMDBs was approximately \$10.5 billion, with related death benefit exposure of approximately \$1.6 billion. We have reinsured approximately 62% of the account value and 86% of this in-force exposure. Assuming every contractholder died on December 31, 2003, as of that date, contracts with GMDB features not covered by reinsurance had an account value of \$3.9 billion and a related death benefit exposure of \$234 million net amount at risk. In addition to reinsurance, we establish reserves equal to the accumulated value of the charges for the benefit less any actual death benefit claims. In recent years, because of adverse claims experience and other factors, reinsurers began to withdraw from this market. Consequently, in June 2003, we stopped reinsuring all of our newly issued variable annuity contracts with GMDB features. In May 2003, we raised prices of, and reduced certain benefits under, our newly issued GMDBs. We continue to evaluate our pricing of GMDB features and intend to seek regulatory approval for additional price increases when appropriate.

We continually review potential new variable annuity products and pursue only those where we believe we can achieve targeted returns in light of the risks involved. For example, unlike several of our competitors, we have not offered variable annuity products with traditional guaranteed minimum income benefits, or GMIBs, or with guaranteed minimum accumulation benefits, or GMABs. Traditional GMIB products guarantee a specified minimum appreciation rate for a defined period of time after annuity payments commence. GMAB products guarantee a customer's account value will be no less than the original investment at the end of a specified accumulation period, plus a specified interest rate.

Although we do not offer traditional GMIBs or GMABs, we have been able to capitalize on the demand for products with guarantees with our GERA™ product, which we launched in April 2002. GERA™ is a variable deferred annuity that has a minimum 10-year scheduled deposit period for customers who desire guaranteed minimum income streams at the end of an accumulation period. If a contractholder makes the required scheduled deposits, he is guaranteed a minimum income stream at the end of the accumulation period. The income stream may exceed the guaranteed minimum based upon the performance of the separate accounts underlying the product. As of December 31, 2003, we had \$139 million of lump-sum deposits and collected scheduled periodic deposits for this product. Based on key product design features, some of which have patents pending, we believe GERA™ allows us to provide our customers a guaranteed income annuity product that mitigates a number of the risks that accompany traditional guaranteed minimum income benefits offered by many of our competitors.

Prior to the completion of this offering, we will reinsure our in-force variable annuities business, excluding the GERA™ product and a small block of contracts in run-off, with UFLIC. See "Arrangements Between GE and Our Company—Reinsurance Transactions."

#### *Variable life insurance*

We offer variable life insurance products that provide insurance coverage through a policy that gives the policyholder flexibility in investment choices and, in some products, in premium payments and coverage amounts. Our variable life products enable the policyholder to allocate all or a portion of his premiums to separate accounts that invest in investment accounts that are distinct from our general account and track the performance of selected mutual funds, including funds from Fidelity, AIM and GE. There is no guaranteed minimum rate of return in these subaccounts, and the policyholder bears the entire risk associated with the performance of these subaccounts. Some of our variable life insurance products also permit the policyholder to allocate all or a portion of his account value to our

143

---

general account, in which case we credit interest at specified rates, subject to certain guaranteed minimums, which are comparable to the minimum rates in effect for our fixed annuities.

Similar to our variable annuity products, we collect specified mortality and expense charges, fees charged on assets allocated to the separate account to cover administrative services and costs, and a portion of the management fees from the various underlying mutual funds in which the assets are invested. We collect cost of insurance charges on our variable life insurance products to compensate us for the mortality risk of the guaranteed death benefit, particularly in the early years of the policy when the death benefit is significantly higher than the value of the policyholder's account.

#### *Asset management*

We offer asset management services to affluent individual investors. Most of our clients for these services have accumulated significant retirement capital, and our principal asset management strategy is to help protect their retirement assets while taking advantage of opportunities for capital appreciation. Our asset management clients are referred to us through their financial advisers. We work with these financial advisers to develop portfolios consisting of individual securities, mutual funds and variable annuities designed to meet each client's particular investment objectives. Our products consist of separately managed accounts, managed mutual funds accounts, and managed variable annuity services. For each of these products, we receive a management fee based upon the amount of assets under management.

A separately managed account is an individually managed client account in which multiple institutional money managers purchase a diversified portfolio of individual stocks on a client's behalf, in accordance with the client's defined needs and objectives. Our clients directly own the stocks in their individual portfolios, and we continuously monitor and evaluate each money manager and the investment performance in each portfolio. We also offer clients access to managed accounts investing in a variety of mutual funds, including funds offered by GE. By working in cooperation with our clients' financial advisers, we seek to achieve each client's investment objectives by selecting the optimal mutual funds.

Our asset management services generally require minimum investments of \$50,000. As of December 31, 2003, we managed more than \$2 billion for more than 15,000 accounts worldwide.

Prior to the completion of this offering, we offered a broad range of institutional asset management services to third parties. GEAM provided the portfolio management services for this business, and we provided marketing, sales and support services. We will not acquire the institutional asset management services business from GEFAHI, but we will continue to provide services to GEAM and GEFAHI related to this asset management business, including client introduction services, asset retention services and compliance support. GEFAHI will pay us a fee of up to \$10 million per year for four years to provide these services. The fee will be determined based upon the level of third-party assets under management managed by GEAM over the four-year term.

#### **Underwriting and pricing**

We generally do not underwrite individual lives in our annuity products, other than structured settlements and some income annuities. Instead, we price our products based upon our expected investment returns and our expectations for mortality, longevity and persistency for the group of our contractholders as a whole, taking into account mortality improvements in the general population and our historical experience. We price variable and immediate deferred annuities by analyzing longevity and persistency risk, volatility of expected earnings on our assets under management, and the expected time to retirement. We price our GICs using customized pricing models that estimate both expected cash flows and likely variance from those expectations caused by reallocations of assets by plan participants. We price income annuities and structured settlements using our mortality experience and

144

---

assumptions regarding continued improvement in annuitant longevity, as well as assumptions regarding investment yields at the time of issue and thereafter.

## Competition

As in our Protection segment, we face significant competition in all our Retirement Income and Investments businesses. Many other companies actively compete for sales in our markets, including other major insurers, banks, other financial institutions, mutual fund and money asset management firms and specialty providers. In many of our product lines, we face competition from competitors that have greater market share or breadth of distribution, offer a broader range of products, services or features, assume a greater level of risk, have lower profitability expectations or have higher claims-paying ratings than we do. Many competitors offer similar products and use similar distribution channels. The substantial expansion of banks' and insurance companies' distribution capacities and expansion of product features in recent years has intensified pressure on margins and production levels and has increased the level of competition in many of our business lines.

We believe competition in our Retirement Income and Investments businesses is based on several factors, including product features, customer service, brand reputation, penetration of key distribution channels, breadth of product offering, product innovations and price.

## Mortgage Insurance

### Overview

Through our Mortgage Insurance segment, we offer mortgage insurance in the U.S., Australia, Canada and Europe.

Private mortgage insurance expands homeownership opportunities by enabling borrowers to buy homes with "low-down-payment mortgages," which are usually defined as loans with a down payment of less than 20% of the home's value. Low-down-payment mortgages are sometimes also referred to as high loan-to-value mortgages. Mortgage insurance products increase the funds available for residential mortgages by protecting mortgage lenders and investors against loss in the event of a borrower's default. These products generally also aid financial institutions in managing their capital efficiently by reducing the capital required for low-down-payment mortgages. If a borrower defaults on mortgage payments, private mortgage insurance reduces and, in some instances, eliminates the loss to the insured institution. Private mortgage insurance also facilitates the sale of mortgage loans in the secondary mortgage market.

We have been providing mortgage insurance products and services in the U.S. since 1981 and now operate in all 50 states in the U.S. and the District of Columbia. For the year ended December 31, 2003, according to *Inside Mortgage Finance*, we were the fourth-largest provider of mortgage insurance in the U.S. (based upon new insurance written). We expanded our operations internationally throughout the 1990s and today we believe we are the largest provider of mortgage insurance outside the U.S. In 2002, we were the leading provider in Australia based upon new policies written according to Insurance Statistics Australia Limited, and one of two major insurers in Canada. We also are one of the leading private mortgage insurance providers in the U.K. and have a growing presence in the developing private mortgage insurance market in Continental Europe. In addition to private mortgage insurance, we provide lenders with various underwriting and other products and services related to home mortgage lending.

145

The following table sets forth selected financial information regarding our U.S. and international mortgage insurance business, as of and for the periods indicated:

	Historical		
	As of or for the years ended December 31,		
	2003	2002	2001
<b>(Dollar amounts in millions)</b>			
<b>Assets</b>			
U.S. mortgage insurance	\$ 3,806	\$ 4,650	\$ 4,801
International mortgage insurance	2,304	1,416	1,029
Total assets	\$ 6,110	\$ 6,066	\$ 5,830
<b>Primary insurance in force</b>			
U.S. mortgage insurance	\$ 122,200	\$ 120,600	\$ 125,400
International mortgage insurance	136,300	79,800	53,900
Total primary insurance in force	\$ 258,500	\$ 200,400	\$ 179,300
<b>Risk in force</b>			
U.S. mortgage insurance	\$ 26,900	\$ 29,600	\$ 32,100
International mortgage insurance(1)	43,400	25,700	16,700
Total risk in force	\$ 70,300	\$ 55,300	\$ 48,800
<b>New insurance written</b>			
U.S. mortgage insurance	\$ 67,400	\$ 46,900	\$ 47,100
International mortgage insurance	39,200	28,200	16,100
Total new insurance written	\$ 106,600	\$ 75,100	\$ 63,200
<b>Net premiums written</b>			
U.S. mortgage insurance	\$ 486	\$ 529	\$ 592

International mortgage insurance	464	311	205
Total net premiums written	\$ 950	\$ 840	\$ 797
<b>Net premiums earned</b>			
U.S. mortgage insurance	\$ 501	\$ 550	\$ 600
International mortgage insurance(2)	215	127	98
Total net premiums earned	\$ 716	\$ 677	\$ 698
<b>Total revenues, net of reinsurance</b>			
U.S. mortgage insurance	\$ 665	\$ 750	\$ 812
International mortgage insurance	317	196	153
Total revenues, net of reinsurance	\$ 982	\$ 946	\$ 965
<b>Benefits and expenses</b>			
U.S. mortgage insurance	\$ 358	\$ 254	\$ 316
International mortgage insurance	93	64	65
Total benefits and expenses	\$ 451	\$ 318	\$ 381
<b>Segment net earnings</b>			
U.S. mortgage insurance	\$ 225	\$ 366	\$ 366
International mortgage insurance	144	85	62
Total segment net earnings	\$ 369	\$ 451	\$ 428

146

<b>Loss ratio(3)</b>			
U.S. mortgage insurance	20%	6%	21%
International mortgage insurance	7%	9%	24%
Total loss ratio	16%	7%	21%
<b>Expense ratio(4)</b>			
U.S. mortgage insurance	53%	41%	32%
International mortgage insurance	17%	17%	20%
Total expense ratio	35%	32%	29%

- (1) Our businesses in Australia, New Zealand and Canada currently provide 100% coverage on the majority of the loans we insure in those markets. For the purpose of representing our risk in-force, we have computed an "Effective Risk in Force" amount, which recognizes that the loss on any particular loan will be reduced by the net proceeds received upon sale of the property. Effective risk in-force has been calculated by applying to insurance in-force a factor that represents our highest expected average per-claim payment for any one underwriting year over the life of our businesses in Australia, New Zealand and Canada. As of December 31, 2003 this factor was 35% in each of Australia, New Zealand and Canada.
- (2) Most of our international mortgage insurance policies provide for single premiums at the time that loan proceeds are advanced. We initially allocate most of the single premiums to unearned premium reserves and recognize the premium earned over time according to an actuarially determined multi-year schedule. As of December 31, 2003, our unearned premium reserves were \$1.2 billion.
- (3) The ratio of incurred losses and loss adjustment expense to net premiums earned.
- (4) The ratio of an insurer's general expenses to net premiums written. In our business, general expenses consist of underwriting, acquisition and insurance expenses, net of deferrals, and amortization of DAC and intangibles.

#### U.S. mortgage insurance

##### Overview

The U.S. private mortgage insurance industry is defined in large part by the requirements and practices of Fannie Mae, Freddie Mac and other large mortgage investors. Fannie Mae and Freddie Mac purchase residential mortgages from mortgage lenders and investors, as part of their governmental mandate to provide liquidity in the secondary mortgage market. In 2003, Fannie Mae purchased approximately 38% of all the mortgage loans originated in the U.S., and Freddie Mac purchased approximately 22%, according to information published by *Inside the GSEs*. Mortgages guaranteed by Fannie Mae or Freddie Mac totaled more than \$3.35 trillion as of December 31, 2003, or approximately 45% of the total outstanding mortgage debt in the U.S. In connection with these activities, Fannie Mae and Freddie Mac also have established mortgage loan origination, documentation, servicing and selling requirements and standards for the loans they purchase. Fannie Mae and Freddie Mac are "government sponsored enterprises," and we refer to them in this prospectus as the "GSEs."

The GSEs may purchase mortgages with unpaid principal amounts up to a specified maximum. The maximum single-family principal balance loan limit eligible for

purchase by the GSEs is called the "conforming loan limit." It is currently \$333,700 and subject to annual adjustment. Each GSE's Congressional charter generally prohibits it from purchasing a mortgage where the loan-to-value ratio exceeds 80% of home value unless the portion of the unpaid principal balance of the mortgage which is

in excess of 80% of the value of the property securing the mortgage is insured against default by lender recourse, participation or by a qualified insurer. As a result, high loan-to-value mortgages purchased by Fannie Mae or Freddie Mac generally are insured with private mortgage insurance. Fannie Mae and Freddie Mac purchased approximately 68% of the loans we insured as of December 31, 2003.

The aggregate value of non-FHA and non-VA mortgage loans originated below the conforming loan limit and with loan-to-value ratios above 80% was \$694 billion, \$460 billion and \$340 billion for the years ended December 2003, 2002 and 2001, respectively, according to *Inside Mortgage Finance* and *Marketrac*.

The majority of our U.S. mortgage insurance policies provide default loss protection on a portion (typically 10%-40%) of the balance of an individual mortgage loan. Most of our primary mortgage insurance policies are "flow" insurance policies, which cover individual loans at the time the loan is originated. We also enter into "bulk" transactions with lenders and investors in selected instances, under which we insure a portfolio of loans for a negotiated price. Bulk insurance constituted less than 2% of our new risk written for the years ended December 31, 2003 and 2002.

In addition to flow and bulk primary mortgage insurance business, we have previously written mortgage insurance on a pool basis. Under pool insurance, the mortgage insurer provides coverage on a group of specified loans, typically for 100% of all losses on every loan in the portfolio, subject to an agreed aggregate loss limit. We ceased writing pool insurance in 1993, with the exception of a limited amount of insurance we wrote for state housing finance agencies and in connection with a sale of loans by an affiliate.

The following table sets forth new risk written and risk in force in our U.S. mortgage insurance business, by product type, as of and for the periods indicated:

	Historical		
	As of or for the years ended December 31,		
	2003	2002	2001
<b>(Dollar amounts in millions)</b>			
<b>New risk written</b>			
Flow insurance	\$ 12,612	\$ 10,547	\$ 9,843
Bulk insurance(1)	189	53	998
Pool insurance(2)	2	—	—
<b>Total</b>	<b>\$ 12,803</b>	<b>\$ 10,600</b>	<b>\$ 10,841</b>
<b>Risk in force</b>			
Flow insurance	\$ 25,396	\$ 27,573	\$ 28,620
Bulk insurance	410	431	652
Pool insurance	1,046	1,638	2,824
<b>Total</b>	<b>\$ 26,852</b>	<b>\$ 29,642</b>	<b>\$ 32,096</b>

(1) A small portion of our bulk insurance is classified as pool insurance under MICA reporting rules.

(2) We do not offer traditional pool insurance, which generally is characterized as providing 100% per loan coverage (except for a limited amount that we wrote for state housing finance agencies and in connection with a sale of loans by an affiliate).

**Products and services**

*Primary mortgage insurance*

*Flow insurance.* Flow insurance is primary mortgage insurance placed on an individual loan when the loan is originated. Our primary mortgage insurance covers default risk on first mortgage loans

generally secured by one- to four-unit residential properties, and can be used to protect mortgage lenders and investors from default on any type of residential mortgage loan instrument that we have approved. Our insurance covers a specified coverage percentage of a "claim amount" consisting of unpaid loan principal, delinquent interest and certain expenses associated with the default and subsequent foreclosure. As the insurer, we generally are required to pay the coverage percentage of a claim amount specified in the primary policy, but we also have the option to pay the lender an amount equal to the unpaid loan principal, delinquent interest and certain expenses incurred with the default and foreclosure, and acquire title to the property. In addition, the claim amount may be reduced or eliminated if the loss on the defaulted loan is reduced as a result of the lender's disposition of the property. The lender selects the coverage percentage at the time the loan is originated, often to comply with investor requirements to reduce the loss exposure on loans purchased by the investor.

For a 30-year fixed-rate mortgage, the most common mortgage product in the U.S., the GSEs generally require coverage percentages of 30% for loan-to-value ratios, determined at loan origination, of 90.01%-95.00%, 25% for loan-to-value ratios of 85.01%-90.00% and 12% for loan-to-value ratios of 80.01%-85.00%. However, the GSEs may alter their coverage requirements and propose different product structures, and we also offer a range of other mortgage insurance products that provide greater or lesser coverage amounts.

The borrower's mortgage loan instrument generally requires the borrower to pay the mortgage insurance premium. In other cases, no insurance requirement is imposed

upon the borrower, in which case the lender pays the premium and recovers those payments through the interest rate charged on the mortgage. Our mortgage insurance premiums for flow insurance typically are paid monthly, but premiums also may be paid annually or in a single, lump-sum payment. During each of the last three years, the monthly premium plan represented more than 98% of our flow new insurance written, with the annual premium plan and the single premium plan representing the balance of our new insurance written.

We are not permitted to terminate our mortgage insurance coverage in force, except for non-payment of premium or material breach of policy conditions. The insurance remains renewable at the option of the policyholder, usually at the renewal rate fixed when the loan was initially insured. As a result, we are not able to raise prices on existing policies to respond to unanticipated default patterns. In addition, our policyholders may cancel their insurance at any time at their option, including when a mortgage is repaid, which may be accelerated by mortgage refinancings in times of falling interest rates. Cancellations are generally driven primarily by the prevailing interest rate environment and the cancellation policies of the GSEs and other investors.

Under the U.S. Homeowners Protection Act, or the HPA, a borrower generally has the right to terminate private mortgage insurance coverage on loans closed after July 28, 1999 that are secured by a single-dwelling property that is the borrower's primary residence when certain loan-to-value ratio thresholds are met. In general, a borrower may stop making mortgage insurance payments when the loan-to-value ratio is scheduled to reach 80% (based upon the loan's amortization schedule established at loan origination) if the borrower so requests and if certain requirements relating to the borrower's payment history and the property's value since origination are satisfied. In addition, a borrower's obligation to make payments for private mortgage insurance generally terminates regardless of whether a borrower so requests when the loan-to-value ratio reaches 78% of the unpaid principal balance of the mortgage. Some states require mortgage servicers to notify borrowers periodically of the circumstances in which they may request a mortgage servicer to cancel private mortgage insurance. Some states allow

---

the borrower to request that the mortgage servicer cancel private mortgage insurance or require the mortgage servicer to cancel such insurance automatically when the circumstances permitting cancellation occur.

Refinancings due to declining interest rates, coupled with strong appreciation of housing values, resulted in relatively high policy cancellation rates of 54% for the year ended December 31, 2003, compared to 43% and 36% for the years ended December 31, 2002 and 2001, respectively. However, the relatively high cancellation rates during these periods were partially offset by relatively high volumes of new insurance written. Our flow new risk written was 20% higher in 2003 than in 2002, 7% higher in 2002 than in 2001, and 59% higher in 2001 than in 2000. The significant increase in 2001 was due primarily to the significant refinancing activity that began that year.

*Bulk insurance.* Under our primary bulk insurance, we insure a portfolio of loans in a single, bulk transaction. Generally, in our bulk insurance, the individual loans in the insured portfolio are insured to specified levels of coverage, and there is an aggregate loss limit applicable to all of the insured loans. We base the premium on our bulk insurance upon our evaluation of the overall risk of the insured loans included in a transaction, and we negotiate the premium directly with the securitizer or other owner of the loans. Most of our bulk insurance business relates to loans financed by lenders who participate in the mortgage programs sponsored by the Federal Home Loan Banks. Premiums for bulk transactions generally are paid monthly by lenders or investors or a securitization vehicle in connection with a securitization transaction or the sale of a loan portfolio.

The loans we insure in bulk transactions typically consist of prime credit-quality loans with loan-to-value ratios of 50% to 95%. Because of the relatively high credit quality of these borrowers, some of these loans are made based upon less documentation of borrower income or assets than is typically required by GSEs and other investors. We generally have avoided the riskier portions of the sub-prime segments of the market, because we believe market pricing for mortgage insurance on sub-prime bulk transactions has not been adequate and we have had concerns regarding the volatility of this segment. However, we may consider insuring such loans where we believe our return and risk criteria are met. Loans that we insure in bulk transactions with loan-to-value ratios above 80% typically have primary mortgage insurance on a flow basis, written either by us or another private mortgage insurer. Our mortgage insurance coverage levels in bulk transactions typically range from 10% to 40%.

#### *Pool insurance*

In addition to our flow and bulk primary mortgage insurance, we previously have written mortgage insurance on a pool basis. Pool insurance generally is used as an additional credit enhancement for secondary market mortgage transactions. We ceased writing pool insurance in 1993 (with the exception of a limited amount of insurance that we wrote for state housing finance agencies and have routinely reinsured and in connection with a sale of loans by an affiliate) because of relatively high losses on pool policies, resulting primarily from inadequate pricing, loss severity and risk concentration in certain parts of the country. However, we will consider writing pool insurance for state housing finance agencies and others where we believe our return and risk criteria are met.

Our remaining pool insurance in force, which relates primarily to policies written between 1990 and 1993, generally covers the loss on a defaulted mortgage loan that exceeds either the claim payment under the primary coverage (if primary insurance is required on that loan) or the total loss (if that loan does not require primary insurance), in each case up to a stated aggregate loss limit. Mortgage loans that we insured in pool insurance with loan-to-value ratios above 80% typically are covered by flow mortgage insurance, written either by us or another private mortgage insurer.

---

#### *Contract underwriting services*

We perform fee-based contract underwriting services for mortgage lenders. Historically, lenders and mortgage insurers each maintained underwriting staffs and performed separate, and in many ways duplicative, underwriting activities with respect to each mortgage loan. Over time, lenders and mortgage insurers have developed a number of arrangements designed to eliminate those inefficiencies. The provision of underwriting services by mortgage insurers serves this purpose and speeds the approval process.

The principal contract underwriting service we provide is determining whether the data relating to a borrower and a proposed loan contained in a mortgage loan application file complies with the lender's loan underwriting guidelines or the investor's loan purchase requirements. In connection with that service, we also compile the application data and submit it to the automated underwriting systems of Fannie Mae and Freddie Mac, which independently analyze the data to determine if the proposed loan complies with their investor requirements. If the loan being reviewed requires mortgage insurance under the applicable lender or investor criteria, we also underwrite the loan to our mortgage insurance guidelines and issue the appropriate mortgage insurance coverage. We believe our contract underwriting services appeal to mortgage lenders because they enable lenders to reduce their costs and improve their operating efficiencies.

Under the terms of our contract underwriting agreements, we agree to indemnify the lender against losses incurred in the event that we make material errors in determining whether loans processed by our contract underwriters meet specified underwriting or purchase criteria.

New risk written by our contract underwriters represented 23% of our new risk written for the year ended December 31, 2003, compared to 26% and 21% for the years ended December 31, 2002 and 2001, respectively.

#### *Risk mitigation arrangements*

*Preferred Partner Program.* We have established a Preferred Partner Program, pursuant to which we pay lenders fees for services that improve the quality of the loans that they refer to us for primary mortgage insurance. These services include:

- counseling services provided to individual borrowers designed to improve the quality of the loans and thereby reduce the chance that they will default on their loans;
- consumer education programs designed to explain the benefits of private mortgage insurance to consumers generally; and
- technology services that facilitate efficient interaction with lenders, which enables us to process applications more quickly and accurately.

The credit characteristics of the mortgage loans generated through the Preferred Partner Program generally are stronger than the average credit characteristics across our entire loan portfolio, as measured by OmniScore®, our proprietary mortgage scoring model. We believe the benefits and cost savings we derive through the enhanced credit characteristics of these loans exceed our costs of maintaining the Preferred Partner Program.

*Secondary market coverage.* We have entered into secondary market coverage, or SMC, arrangements with Fannie Mae and Freddie Mac under which the existing primary insurance coverage on an identified portfolio of eligible loans purchased by a GSE is restructured to reallocate risk of loss between the insurer and the insured. The restructured loans are eligible loans purchased in a given year by the GSE from identified originating lenders. The restructuring involves our reducing primary

coverage on each loan in the portfolio to the minimum level permitted under the GSEs' charters, and adding supplemental coverage that is subject to a "stop-loss" which, if reached, results in the GSE suffering greater losses than they would suffer if the primary coverage were not reduced. In addition, the GSEs provide us with a variety of services under these agreements, including providing various periodic reports, property marketing services, and information on product and market trends.

*Captive reinsurance.* Captive reinsurance is a reinsurance program in which we share portions of our U.S. mortgage insurance risk written on loans originated or purchased by lenders with captive reinsurance companies, or captive reinsurers, affiliated with these lenders. In return, we cede to the captive reinsurers an agreed portion of our gross premiums on flow insurance written. New insurance written through the bulk channel generally is not subject to these arrangements.

The following table sets forth selected financial information regarding our captive reinsurance arrangements, as of and for the periods indicated:

	Historical		
	As of or for the years ended December 31,		
	2003	2002	2001
Primary new risk written subject to captive reinsurance arrangements, as a percentage of total primary new risk written	75%	77%	61%
Primary risk in force subject to captive reinsurance arrangements, as a percentage of total primary risk in force	64%	55%	42%
Gross written premiums ceded pursuant to captive reinsurance arrangements, as a percentage of total gross written premiums	23%	18%	12%

We believe that the increases in the percentages of primary new risk written and primary risk in force subject to captive reinsurance agreements were driven by a higher percentage of new insurance written generated by lenders having captive reinsurance programs during a period of high refinancing activity. Many large mortgage lenders have developed captive reinsurance affiliates, and the recent consolidation among large mortgage lenders has resulted in an increased percentage of mortgage loans originated by lenders with captive reinsurance programs. The recent low-interest-rate environment has generated significant refinancing activity in recent years, which has resulted in increased concentration of mortgage loans with larger lenders that tend to use captive reinsurance arrangements.

In order to increase our return on capital, we announced in August 2003 that, effective January 1, 2004, we generally would not renew, on their existing terms, our existing excess-of-loss risk sharing arrangements with net premium cessions in excess of 25%. Most large mortgage lenders have developed reinsurance operations that obtain net premium cessions from mortgage insurers of 25% to 40%. We expect that these actions will result in a significant reduction in business from these lenders. We recently decided that we may, in selected cases, enter into captive reinsurance arrangements that involve premium cessions in excess of 25% in situations where the terms and conditions, including the level of reinsurance coverage, will enable us to achieve our target returns on capital.

As of December 31, 2003, other than reinsurance under captive arrangements, we reinsured less than 1% of our mortgage insurance in force.

#### **Customers**

Our principal mortgage insurance customers are originators of residential mortgage loans, such as mortgage banks, savings institutions, commercial banks, mortgage brokers, credit unions and other lenders, who typically determine which mortgage insurer or insurers they will use for the placement of mortgage insurance written on loans they originate. To obtain primary insurance written on a flow

basis, a mortgage lender must first apply for and receive from us a mortgage guaranty master policy. In recent years, there has been significant consolidation among the largest lenders, which now underwrite a substantial portion of all the mortgages written in the U.S. The top ten lenders accounted for 48% of our flow new insurance written for the year ended December 31, 2003, compared to 40% for the year ended December 31, 1998.

We are focused on expanding our presence throughout the mortgage loan market by providing superior customer sales support, product offerings designed to meet the specific needs of our customers, and technology products designed to enable customers to reduce costs and expand revenues. In addition, as discussed under "—Operations and Technology," we have developed web based technology services that enable our customers to interact more efficiently with us.

#### **Underwriting and pricing**

Loan applications for all loans we insure are reviewed to evaluate each individual borrower's ability to repay the proposed mortgage loan, the characteristics of the loan and the value of the underlying property. This analysis generally includes reviewing the following criteria:

- the borrower's credit strength and history, as reported by credit reporting agencies;



- the borrower's debt-to-income ratios;
- the loan-to-value ratio;
- the type of mortgage instrument;
- the purpose of the loan;
- the type of property; and
- appraisals to confirm the property market value is fairly stated.

Loan applications for primary mortgage insurance are reviewed by our employees directly as part of our traditional underwriting process or by our contract underwriters as we process mortgage loan applications that require mortgage insurance. Some mortgage lenders also underwrite loan applications for mortgage insurance under a delegated underwriting program, in which we permit approved lenders to commit us to insure loans using underwriting guidelines that we have previously approved. Before granting a lender delegated underwriting authority, our risk management personnel review the lender's underwriting experience and processes, loan quality and specific loan programs to be included in the delegated program. In addition, we conduct audits on a sample of the delegated loans we insure to confirm that lenders with delegated authority adhere to approved underwriting guidelines and procedures.

The majority of mortgage loans we insure today are underwritten using Fannie Mae's and Freddie Mac's automated underwriting systems, or AUS, which lenders have widely adopted due to the GSEs' requirements and the efficiencies that AUS provide. We have evaluated loans approved by Fannie Mae's and Freddie Mac's AUS and, like other mortgage insurers, we generally have agreed to insure loans approved by these systems. Under the delegated underwriting program, lenders may use their own AUS provided that we have reviewed and approved their system. AUS have automated many of the underwriting steps that were previously performed by underwriters on a manual basis and use sophisticated mortgage scoring methodologies to evaluate borrower default risk. Although we review AUS before allowing their use under our delegated program, under which lenders have the responsibility to determine whether the loans comply with our approved underwriting guidelines, a potential risk to us of using AUS is that factors that we might otherwise evaluate in making an underwriting decision are not considered if not required by the AUS.

153

Loans insured under our delegated underwriting program accounted for approximately 59% of our total risk in force as of December 31, 2003, compared to 56% and 52% as of December 31, 2002 and 2001, respectively. The percentage of new risk written by delegated underwriters was 62% for the year ended December 31, 2003, compared to 61% for the year ended December 31, 2002 and 60% for the year ended December 31, 2001.

In pricing mortgage insurance policies, we generally target substantially similar returns on capital regardless of the loan-to-value ratio, product type and depth of coverage. We establish premium rates principally on the basis of long-term claims experience in the industry, reflecting periods of lower and higher losses and various regional economic downturns. We believe that over the long term each region of the U.S. will be subject to similar factors affecting risk of loss on insurance written, and therefore we generally use a nationally based premium rate policy, rather than a regional, local or lender-based policy. Our premium rates vary with the coverage percentage and the perceived risk of a claim on the insured loan, which takes into account the loan-to-value ratio, the type of mortgage and the term of the mortgage. Our premium rates also reflect our expectations, based upon our analysis of historical data, of the persistency of the policies in our book of business. Our premium rates also take into account competitive alternatives available to consumers, including rates offered by other mortgage insurers.

Our premium rates also consider the location of the borrower's credit score within a range of credit scores. In accordance with industry practice, we use the "FICO" score as one indicator of a borrower's credit quality. Fair Isaac and Company, or FICO, developed the "FICO" credit scoring model to calculate a FICO score based upon a borrower's credit history. The higher the credit score, the lower the likelihood that a borrower will default on a loan. FICO credit scores range up to 850, with a score of 620 or more generally viewed as a "prime" loan and a score below 620 generally viewed as a "sub-prime" loan. "A minus" loans generally are loans where the borrowers have FICO credit scores between 575 and 660, and where the borrower has a blemished credit history. As of December 31, 2003, on a risk in force basis, approximately 92% of our flow insurance loans had FICO credit scores of at least 620, approximately 6% had FICO credit scores between 575 and 619, and approximately 2% had FICO scores of 574 or less.

As of December 31, 2003, on a risk in force basis, approximately 87% of our bulk insurance loans had FICO credit scores of at least 620, approximately 7% had FICO credit scores between 575 and 619, and approximately 6% had FICO scores of 574 or less. The majority of loans we currently insure in bulk transactions meet the conforming loan limit and have FICO credit scores of at least 620. After 2001, we significantly reduced writing insurance of loans in bulk transactions that included non-conforming and lesser-quality loans, such as "A minus" loans and "sub-prime" loans, because we believe market pricing was inadequate to compensate us for the risk.

154

### ***Loan portfolio***

The following table sets forth selected financial information regarding our U.S. primary mortgage insurance loan portfolio as of the dates indicated:

	Historical		
	December 31,		
	2003	2002	2001
<b>(Dollar amounts in millions)</b>			
Primary risk-in-force lender concentration (by original applicant)	\$ 25,805	\$ 28,004	\$ 29,272
Top 10 lenders	12,047	12,538	11,979
Top 20 lenders	14,392	15,360	15,118
Loan-to-value ratio			
95.01% and above	3,431	2,538	1,909
90.01% to 95.00%	10,759	12,313	13,129
80.01% to 90.00%	10,868	11,681	12,582
80.00% and below	747	1,472	1,652

Total	\$ 25,805	\$ 28,004	\$ 29,272
<b>Loan grade</b>			
Prime	\$ 23,408	\$ 26,025	\$ 27,687
A minus and sub-prime	2,397	1,979	1,585
Total	\$ 25,805	\$ 28,004	\$ 29,272
<b>Loan type</b>			
Fixed rate mortgage	\$ 24,354	\$ 26,619	\$ 27,798
Adjustable rate mortgage	1,451	1,385	1,474
Total	\$ 25,805	\$ 28,004	\$ 29,272
<b>Mortgage term</b>			
15 years and under	\$ 1,489	\$ 1,214	\$ 940
More than 15 years	24,316	26,790	28,332
Total	\$ 25,805	\$ 28,004	\$ 29,272

### Loans in default and claims

Our default management process begins with notification by the loan servicer of a default on an insured loan. "Default" is defined in our master policies as the borrower's failure to pay when due an amount equal to the scheduled monthly mortgage payment under the terms of the mortgage. Generally, the master policies require an insured to notify us of a default no later than 10 days after the borrower has been in default by three monthly payments. In most cases, however, defaults are reported earlier. We generally consider a loan to be in default and establish reserves if the borrower has failed to make a required mortgage payment for two consecutive months. Borrowers default for a variety of reasons, including a reduction of income, unemployment, divorce, illness, inability to manage credit and interest rate levels. Borrowers may cure defaults by making all of the delinquent loan payments or by selling the property in full satisfaction of all amounts due under the mortgage. In most cases, defaults that are not cured result in a claim under our policy.

155

The following table sets forth the number of loans insured, the number of loans in default and the default rate for our U.S. mortgage insurance portfolio:

	Historical		
	December 31,		
	2003	2002	2001
<b>Primary Insurance</b>			
Insured loans in force	950,157	993,906	1,064,880
Loans in default	32,207	33,278	33,387
Percentage of loans in default (default rate)	3.4%	3.3%	3.1%
Flow loans in force	839,891	948,224	1,018,895
Flow loans in default	29,787	30,194	30,906
Percentage of flow loans in default (default rate)	3.5%	3.2%	3.0%
Bulk loans in force	110,266	45,682	45,985
Bulk loans in default	2,420	3,084	2,481
Percentage of bulk loans in default (default rate)	2.2%	6.8%	5.4%
A minus and sub-prime loans in force	75,584	63,646	52,934
A minus and sub-prime loans in default	6,881	5,547	4,271
Percentage of A minus and sub-prime loans in default (default rate)	9.1%	8.7%	8.1%
<b>Pool Insurance</b>			
Insured loans in force	37,702	55,195	88,987
Loans in default	855	1,505	2,135
Percentage of loans in default (default rate)	2.3%	2.7%	2.4%

Primary insurance default rates differ from region to region in the U.S. at any one time depending upon economic conditions and cyclical growth patterns. The two tables below set forth our primary default rates for the various regions of the U.S. and the ten largest states by our risk in force as of December 31, 2003. Default rates are shown by region based upon location of the underlying property, rather than the location of the lender.

Percent of primary risk in force as of December 31,	Default rate
	December 31,

	2003	2003	2002	2001
<b>U.S. Regions</b>				
Southeast(1)	22%	3.59%	3.51%	3.36%
South Central(2)	16%	3.65%	3.45%	3.06%
Northeast(3)	13%	3.88%	3.87%	3.85%
Pacific(4)	13%	2.54%	2.94%	2.90%
North Central(5)	12%	2.71%	2.94%	2.84%
Great Lakes(6)	9%	4.33%	4.08%	3.47%
Plains(7)	6%	2.54%	2.43%	2.23%
Mid-Atlantic(8)	5%	2.94%	3.25%	3.26%
New England(9)	4%	2.79%	2.82%	2.48%
<b>Total</b>	<b>100%</b>	<b>3.38%</b>	<b>3.34%</b>	<b>3.14%</b>

- (1) Alabama, Arkansas, Florida, Georgia, Mississippi, North Carolina, South Carolina and Tennessee.
- (2) Arizona, Colorado, Louisiana, New Mexico, Oklahoma, Texas and Utah.
- (3) New Jersey, New York and Pennsylvania.
- (4) Alaska, California, Hawaii, Nevada, Oregon and Washington.
- (5) Illinois, Minnesota, Missouri and Wisconsin.
- (6) Indiana, Kentucky, Michigan and Ohio.
- (7) Idaho, Iowa, Kansas, Montana, Nebraska, North Dakota, South Dakota and Wyoming.
- (8) Delaware, Maryland, Virginia, Washington, D.C. and West Virginia.
- (9) Connecticut, Maine, Massachusetts, New Hampshire, Rhode Island and Vermont.

156

	Percent of primary risk in force as of December 31,	Default rate		
		December 31,		
		2003	2002	2001
Florida	7.79%	2.75%	3.08%	3.39%
California	7.14%	1.91%	2.45%	2.69%
Texas	6.73%	4.15%	3.80%	3.41%
New York	5.61%	3.47%	3.46%	3.70%
Illinois	5.31%	3.23%	3.66%	3.76%
Pennsylvania	3.82%	4.38%	4.49%	4.34%
North Carolina	3.82%	4.12%	3.68%	3.27%
Georgia	3.57%	4.68%	4.40%	3.95%
Ohio	3.52%	4.64%	4.20%	3.67%
Arizona	3.52%	3.18%	3.52%	2.92%

Claim activity is not spread evenly throughout the coverage period of a primary insurance book of business. Based upon our experience, the majority of claims on primary mortgage insurance loans occur in the third through seventh years after loan origination, and relatively few claims are paid during the first two years after loan origination. Primary insurance written from the period from January 1, 1998 through December 31, 2001 represented 20% of our primary insurance in force as of December 31, 2003. This portion of our loan portfolio is in its expected peak claim period with respect to traditional primary loans. We believe our "A minus" and "sub-prime" loans will have earlier incidences of default than our prime loans. "A minus" loans represented 2.7% of our primary insurance in force as of December 31, 2003 and 1.5% as of December 31, 2002, and "sub-prime" loans represented 5.1% of our primary insurance in force as of December 31, 2003 and 5.1% as of December 31, 2002.

The following table sets forth the dispersion of our primary insurance in force and risk in force as of December 31, 2003, by year of policy origination and average annual mortgage interest rate since we began operations in 1981:

Policy Year	Average rate	Primary insurance in force	Percent of total	Primary risk in force	Percent of total
1981-92	9.20%	\$ 2,163	1.77%	\$ 480	1.86%
1993	7.41%	1,585	1.30%	329	1.28%
1994	7.66%	1,803	1.47%	391	1.52%
1995	8.21%	1,294	1.06%	347	1.34%
1996	7.90%	1,499	1.23%	402	1.56%
1997	7.82%	1,375	1.12%	367	1.42%
1998	7.11%	3,846	3.15%	973	3.77%
1999	7.26%	4,915	4.02%	1,198	4.64%
2000	8.06%	3,404	2.78%	808	3.13%
2001	7.44%	12,076	9.88%	2,819	10.93%
2002	6.51%	25,776	21.09%	5,861	22.71%
2003	5.63%	62,491	51.13%	11,830	45.84%

Total portfolio	6.37%	\$	122,227	100.00%	\$	25,805	100.00%
-----------------	-------	----	---------	---------	----	--------	---------

Primary mortgage insurance claims paid for the year ended December 31, 2003 were \$99 million, compared to \$80 million and \$81 million for the years ended December 31, 2002 and 2001, respectively. Pool insurance claims paid for the year ended December 31, 2003 were \$1 million, compared to \$2.8 million and \$4.0 million for the years ended December 31, 2002 and 2001, respectively.

The frequency of defaults may not correlate directly with the number of claims received because the rate at which defaults are cured is influenced by borrowers' financial resources and circumstances and regional economic differences. Whether an uncured default leads to a claim principally depends upon the borrower's equity at the time of default and the borrower's or the insured's ability to sell the home for an amount sufficient to satisfy all amounts due under the mortgage loan. When we receive notice of a default, we use a proprietary model to determine whether a delinquent loan is a candidate for work-out. When the model identifies such a candidate, our loan workout specialists prioritize cases for loss mitigation based upon the likelihood that the loan will result in a claim. Loss mitigation actions include loan modification, extension of credit to bring a loan current, foreclosure forbearance, pre-foreclosure sale, and deed-in-lieu. We believe these loss mitigation efforts often are an effective way to reduce our claim exposure and ultimate payouts.

Our policies require the insured to file a claim with us, specifying the claim amount (unpaid principal, interest and expenses), no later than 60 days after it has acquired title to the underlying property, usually through foreclosure. The claim amount is subject to our review and possible adjustment. Depending upon the applicable state foreclosure law, an average of approximately 16 months elapse from the date of default to the filing of a claim on an uncured default. Our master policies exclude coverage for physical damage whether caused by fire, earthquake or other hazard where the borrower's default was caused by an uninsured casualty.

We have the right to rescind coverage and refuse to pay a claim if it is determined that the insured or its agents misrepresented material information in the insurance application. In addition, where loans are underwritten by lenders through our delegated underwriting program, we have the right to rescind coverage if the loan was not underwritten in compliance with our approved guidelines.

Within 60 days after a claim and supporting documentation have been filed, we have the option:

- to pay the claim amount, multiplied by coverage percentage specified in the certificate of insurance;
- in the event the property is sold pursuant to an agreement made prior to payment of the claim, which we refer to as a pre-arranged sale, to pay the lesser of 100% of the claim amount less the proceeds of sale of the property, or the claim amount multiplied by the coverage percentage; or
- to pay the lender an amount equal to the unpaid loan principal, delinquent interest and certain expenses incurred with the default and foreclosure, and acquire title to the property. We bear the risk of any loss in connection with the acquisition and sale of the property.

For the year ended December 31, 2003, we settled a majority of the primary insurance claims processed for payment on the basis of a pre-arranged sale.

Titles to the properties that we purchased have been sold to, and will continue to be held by, GE Mortgage Services, an affiliate of GE. As of December 31, 2003, GE Mortgage Services owned approximately \$5 million of residential properties from claim settlements. In addition, GE Mortgage Services held \$11 million in residential loans as of December 31, 2003 relating to loss mitigation activities, for which we have indemnified it against loss.

The ratio of the claim paid to the unpaid principal amount multiplied by the coverage percentage is referred to as "claim severity." The main determinants of claim severity are the age of the mortgage loan, the value of the underlying property, accrued interest on the loan, expenses advanced by the insured and foreclosure expenses. These amounts depend partly upon the time required to complete foreclosure, which varies depending upon state laws. Pre-foreclosure sales, acquisitions and other early workout efforts help to reduce overall claim severity. Our average primary mortgage insurance claim severity was 93%, 93% and 97% for the years 2003, 2002 and 2001, respectively.

### Competition

We compete primarily with U.S. and state government agencies, other private mortgage insurers, mortgage lenders and other investors, the GSEs and, potentially, the Federal Home Loan Banks. We also compete, indirectly, with structured transactions in the capital markets and with other financial instruments designed to mitigate credit risk.

*U.S. and state government agencies.* We and other private mortgage insurers compete for flow business directly with U.S. federal and state governmental and quasi-governmental agencies, principally the FHA and, to a lesser degree, the VA. The following table sets forth the relative mortgage insurance market share of FHA/VA and private mortgage insurers over the past five years:

U.S. federal government and private mortgage insurance market share					
December 31,					
	2003	2002	2001	2000	1999
FHA/VA	36.4%	35.6%	37.3%	41.4%	47.6%
Private mortgage insurance	63.6%	64.4%	62.7%	58.6%	52.4%
Total	100.0%	100.0%	100.0%	100.0%	100.0%

Source: *MICA 2002 Factbook (1999-2002)*, *IMF (2003)*

Loans insured by the FHA cannot exceed maximum principal amounts that are determined by a percentage of the conforming loan limit. For 2004, the maximum FHA loan amount for homes with one dwelling unit in "high cost" areas is \$290,319. Although the VA does not specify a maximum loan limit, VA loans are generally \$240,000 or less. We and other private mortgage insurers are not limited as to maximum individual loan amounts that we can insure.

In January 2001, the FHA reduced the up-front mortgage insurance premium it charges on loans from 2.25% to 1.5% of the original loan amounts. The FHA has also

streamlined its down-payment formula, making FHA insurance more competitive with private mortgage insurance in areas with higher home prices. These and other legislative and regulatory changes could cause future demand for private mortgage insurance to decrease.

In addition to competition from the FHA and the VA, we and other private mortgage insurers face competition from state-supported mortgage insurance funds in several states, including California, Illinois and New York. From time to time, other state legislatures and agencies consider expansions of the authority of their state governments to insure residential mortgages.

Government entities with which we compete typically do not have the same capital requirements and do not have the same profit objectives as we do. Although private companies establish pricing terms for their products to achieve targeted returns, these government entities may offer products on terms designed to accomplish social or political objectives or reflect other non-economic goals.

*Private mortgage insurers.* The private mortgage insurance industry is highly competitive. The private mortgage insurance industry currently consists of seven mortgage insurers plus our company.

159

---

The other companies are Mortgage Guaranty Insurance Corporation; PMI Mortgage Insurance Company; CMG Mortgage Insurance Company, a joint venture in which PMI is one of the partners; Radian Guaranty Inc.; Republic Mortgage Insurance Co., an affiliate of Old Republic International; Triad Guaranty Insurance Corp.; and United Guaranty Residential Insurance Company, an affiliate of American International Group, Inc. Assured Guaranty Ltd., currently a subsidiary of ACE Limited, has announced its intention to offer mortgage insurance in the U.S., and we believe other companies also may be considering offering mortgage insurance.

*Mortgage lenders and other investors.* We and other mortgage insurers compete with transactions structured by mortgage lenders to avoid mortgage insurance on low-down-payment mortgage loans. These transactions include self-insuring and simultaneous second loans, which separate a mortgage with a loan-to-value ratio of more than 80%, which generally would require mortgage insurance, into two loans, a first mortgage with a loan-to-value-ratio of 80% and a simultaneous second mortgage for the excess portion of the loan. Simultaneous second loans are also often known as "80-10-10 loans," because they often comprise a first mortgage with an 80% loan-to-value ratio, a second mortgage with a 10% loan-to-value ratio and the remaining 10% paid in cash by the buyer, rather than a first mortgage with a 90% loan-to-value ratio. However, simultaneous seconds also can be structured as 80-15-5 loans or 80-20-0 loans, as well as other configurations.

Over the past several years, we believe the volume of simultaneous second loans as an alternative to loans requiring private mortgage insurance has increased substantially. We believe this recent increase reflects the following factors:

- the lower cost of simultaneous second loans compared to the cost of mortgage insurance, due to the current low-interest-rate environment and the emerging popularity of 15- and 30-year amortizing simultaneous seconds;
- the fact that second mortgage interest is generally tax-deductible, whereas mortgage insurance payments currently are not tax-deductible (although from time to time there have been proposed legislative initiatives to permit deductions for mortgage insurance payments); and
- adverse consumer, broker and realtor perceptions of private mortgage insurance.

Mortgage lenders also may compete with mortgage insurers as a result of legislation that has removed restrictions on affiliations between banks and insurers. The Graham-Leach-Bliley Act of 1999 permits the combination of banks, insurers and securities firms under one holding company. This legislation may increase competition by increasing the number, size and financial strength of potential competitors. In addition, mortgage lenders that establish or affiliate with competing mortgage insurers may reduce their purchases of our products.

We also compete with structured transactions in the capital markets and with other financial instruments designed to mitigate the risk of mortgage defaults, such as credit default swaps and credit linked notes, with lenders who forego mortgage insurance (self-insure) on loans held in their portfolios, and with mortgage lenders who maintain captive mortgage insurance and reinsurance programs.

*The GSEs—Fannie Mae and Freddie Mac.* As the predominant purchasers of conventional mortgage loans in the U.S., Fannie Mae and Freddie Mac provide a direct link between mortgage origination and capital markets. As discussed above under "—Primary mortgage insurance," most high loan-to-value mortgages purchased by Fannie Mae or Freddie Mac are insured with private mortgage insurance issued by an insurer deemed qualified by the GSEs. Our mortgage insurance company is a qualified insurer with both GSEs.

Private mortgage insurers may be subject to competition from Fannie Mae and Freddie Mac to the extent the GSEs are compensated for assuming default risk that would otherwise be insured by the private mortgage insurance industry. Fannie Mae and Freddie Mac each have programs under which an

160

---

up-front delivery fee may be paid to the GSE so that primary mortgage insurance coverage may be substantially reduced compared to the coverage requirements that would apply in the absence of the fee payment. Moreover, in October 1998, Freddie Mac's charter was amended to give Freddie Mac flexibility to use credit enhancements other than private mortgage insurance for low-down-payment mortgages. Although this amendment was repealed, if the legislation is reintroduced and adopted, and the GSEs permitted to purchase low-down-payment loans that are not insured by private mortgage insurance, it is likely that the size of the market for private mortgage insurance would contract significantly.

The GSEs are currently subject to oversight by the Department of Housing and Urban Development, or HUD. In October 2000, HUD announced new GSE mortgage purchase requirements, known as affordable housing goals. Under these goals, which became effective in 2001, at least 50% of all loans purchased by the GSEs must support low- and moderate-income homebuyers, and 31% of such loans must be on properties in underserved areas. We believe that the GSEs' goals to expand purchases of affordable housing loans have increased the size of the mortgage insurance market. The GSEs also have expanded programs to include commitments to purchase certain volumes of loans with loan-to-value ratios greater than 95%.

Private mortgage insurers must satisfy requirements set by the GSEs to be eligible to insure loans sold to the GSEs, and the GSEs have the ability to implement new eligibility requirements for mortgage insurers. They also have the authority to change the pricing arrangements for purchasing retained-participation mortgages as compared to insured mortgages, increase or reduce required mortgage insurance coverage percentages, and alter or liberalize underwriting standards on low-down-payment mortgages they purchase.

*Federal Home Loan Banks.* In October 1999, the Federal Housing Finance Board, or FHF Board, adopted resolutions that authorize each Federal Home Loan Bank, or FHLB, to offer Mortgage Partnership Finance Programs, or MPF Programs, to purchase single-family conforming mortgage loans originated by participating member

institutions. In July 2000, the FHF Board gave permanent authority to each FHLB to purchase these loans from member institutions without any volume cap. Purchases of loans under the MPF Program have steadily increased in the past several years.

The MPF Program is similar to the purchase of mortgage loans by the GSEs. Although not required to do so, the FHLBs currently use mortgage insurance on substantially all mortgage loans with a loan-to-value ratio above 80% and have become a source of increasing new business for us. However, to the extent that the FHLBs purchased uninsured mortgage loans or used other credit-enhancement products, the MPF Program could result in a decrease in the size of the market for private mortgage insurance.

### **International mortgage insurance**

We have significant mortgage insurance operations in Australia and Canada, two of the largest markets for mortgage insurance products outside the U.S., as well as in the smaller New Zealand market and the developing European market. The net premiums written in our international mortgage insurance business have increased by a compound annual growth rate of 46% for the three years ended December 31, 2003. Insurance in-force for our international mortgage insurance business contributed 53% of our total insurance in-force as of December 31, 2003, compared to 40% as of December 31, 2002.

The mortgage loan markets in the U.S., Canada, Australia and New Zealand are well developed. Although mortgage insurance plays an important role in each of these markets, the markets vary significantly and are influenced in large part by the different cultural, economic and regulatory

161

---

conditions in each market. We believe the following factors have contributed to the growth of robust mortgage insurance demand in these countries:

- A desire by lenders to offer low-down-payment mortgage loans to facilitate the expansion of their business;
- The recognition of the higher default risk inherent in low-down-payment lending and the need for specialized underwriting expertise to conduct this business prudently;
- Government housing policies that support increased homeownership;
- Government policies that support the use of securitization and secondary market mortgage sales, in which third-party credit enhancement is often used, as a source of funding and liquidity for mortgage lending; and
- Bank regulatory capital policies that provide incentives to lenders to transfer some or all of the increased credit risk on low-down-payment mortgages to third parties, such as mortgage insurers.

We believe a number of these factors are becoming evident in certain markets throughout Europe and Asia and provide attractive opportunities for us to expand our mortgage insurance business in those markets.

Based upon our experience in the mature markets, we believe a favorable regulatory framework is important to the development of an environment in which lenders routinely extend high loan-to-value loans and use products such as mortgage insurance to protect against default risk or obtain capital relief. As a result, we have advocated that governmental and policymaking agencies throughout our markets adopt legislative and regulatory policies that support increased homeownership and capital relief for lenders and mortgage investors that insure their loan portfolios with private mortgage insurance. Although the products we offer in each of our international markets differ, they represent substantially similar risk propositions and involve similar business practices. We have developed significant expertise in mature markets, and we intend to leverage this experience in developing markets as we continue to encourage regulatory authorities to implement incentives for private mortgage insurance as an effective risk management strategy.

We believe the proposed revisions to a set of regulatory rules and procedures governing global bank capital standards that were introduced by the Basel Committee of the Bank for International Settlements, known as Basel II, also may encourage further growth of international mortgage insurance. Basel II, which is expected to become effective in 2006, has been designed to reward banks that have developed effective risk management systems by allowing them to hold less capital than banks with less effective systems. For example, Basel II may reward a lender that transfers some risk of mortgage default to a third-party insurer by reducing the amount of capital that the lender must hold to back a mortgage. However, the details of the regulatory capital requirements in Basel II remain under discussion, and therefore we cannot predict the benefits that ultimately will be provided to lenders, or how any such benefits may affect the opportunities for the growth of mortgage insurance.

We also intend to expand into Asian countries that have high demand for mortgage loan financing and underserved housing needs. We believe lenders in these countries will seek to expand their consumer mortgage loan portfolios, while maintaining strong risk and capital management routines. With the expected implementation of the new Basel II standards, we believe we will be well positioned to assist lenders in these markets in meeting those goals and in complying with the anticipated complexity of the risk-based capital and operating standards.

### ***Canada***

We entered the Canadian mortgage insurance market in 1995 with our acquisition of certain assets and employees from the Mortgage Insurance Corporation of Canada, and we now operate in every

162

---

province and territory. We are the only private mortgage insurer in the Canadian market. Our mortgage insurance operations in Canada accounted for approximately 55% of our total international mortgage insurance revenues for the year ended December 31, 2003.

### ***Products***

We offer two products in Canada: primary flow insurance and portfolio credit enhancement insurance. As of December 31, 2003, primary flow insurance represented 77% and portfolio credit enhancement represented 23% of our mortgage insurance in force. Our principal product is primary flow insurance, which is similar to the primary flow insurance we offer in the U.S. Regulations in Canada require the use of mortgage insurance for all mortgage loans extended by banks, trust companies and insurers, where the loan-to-value ratio exceeds 75%. Mortgage insurance in Canada is typically single premium and provides 100% coverage, in contrast to the U.S., where monthly premiums and lower coverage levels are typical. Under the single-premium plan, lenders usually collect the single premium from prospective borrowers at the time the loan proceeds are advanced and remit the amount to us as the mortgage insurer. We in turn allocate most of the proceeds to unearned premium reserves, invest those proceeds and recognize the premium revenues over time according to an actuarially determined multi-year schedule.

We also provide portfolio credit enhancement insurance to lenders that have originated loans with loan-to-value ratios of less than 75%. These policies provide lenders with immediate capital relief from applicable bank regulatory capital requirements and facilitate the securitization of mortgages in the Canadian market. In both primary flow insurance and portfolio policies, our mortgage insurance in Canada provides insurance coverage for the entire unpaid loan balance, including interest, selling costs and expenses, following the sale of the underlying property.

The leading mortgage product in the Canadian market is a mortgage with the interest rate fixed for the first five years of the loan. After the fifth year, the loan becomes due and payable and the borrower must negotiate its renewal, at which time the borrower may choose to have the interest rate float or have it fixed for an additional period. Lenders typically charge a mortgage pre-payment penalty that serves as a disincentive for borrowers to refinance their mortgages. Changes in interest rates, adverse economic conditions and high levels of borrowing affect the frequency of defaults and claims with respect to these loans, which may adversely affect our loss experience.

#### *Government guarantee*

We have an agreement with the Canadian government under which it guarantees the benefits payable under a mortgage insurance policy, less 10% of the original principal amount of an insured loan, in the event that we fail to make claim payments with respect to that loan because of insolvency. We pay the Canadian government a risk premium for this guarantee and make other payments to a reserve fund in respect of the government's obligation. Because banks are not required to maintain regulatory capital on an asset backed by a sovereign guarantee, our 90% sovereign guarantee permits lenders purchasing our mortgage insurance to reduce their regulatory capital charges for credit risks on mortgages by 90%.

Our agreement with the Canadian government provides that we and the government are entitled to review the terms of the guarantee when certain pricing assumptions have changed or other events have occurred that cause either party to believe that these changes or other events have resulted in unfairness, prejudice or obvious hardship. In this event, the agreement requires us to negotiate in good faith for six months to make such modifications as are required to remove or modify the unfairness, prejudice or obvious hardship. If we and the government are unable to agree on appropriate changes to the guarantee, the matter must be referred to binding arbitration.

163

---

In addition, our agreement with the Canadian government provides that the government has the right to review the terms of the guarantee if GE's ownership of our Canadian mortgage insurance company decreases below 50% or certain other events occur that affect the purposes of the agreement or the government's risk or exposure under the guarantee. In this event, the agreement requires us to negotiate in good faith to make such modifications as are required to remove or modify any unfairness, prejudice or obvious hardship that may have resulted from the change in ownership or other events. If we are unable to agree on appropriate modifications within six months, the agreement may be terminated for any new insurance written after the termination. GE has informed us that it expects to reduce its equity ownership of us to below 50% within two years of the completion of this offering. That disposition would permit the Canadian government to review the terms of its guarantee and could lead to a modification or termination of the guarantee. Although we believe the Canadian government will preserve the guarantee to maintain competition in the Canadian mortgage insurance industry, any adverse change in the guarantee's terms and conditions or termination of the guarantee could have a material adverse effect on our ability to continue offering mortgage insurance products in Canada.

#### *Customers*

The nine largest mortgage originators in Canada, consisting of banks, trust companies, and credit unions, collectively provide more than 80% of the financing for Canada's residential mortgage financing. These nine originators provided us with 85% of our new insurance written for the year ended December 31, 2003, compared with 86% for the year ended December 31, 2002 and 89% for the year ended December 31, 2001. Other market participants include regional banks, trust companies, and credit unions.

#### *Competitors*

The only other mortgage insurance competitor in Canada is the Canada Mortgage and Housing Corporation, or CMHC, which is a Crown corporation owned by the Canadian government. Because CMHC is a government-owned entity, its mortgage insurance provides lenders with 100% capital relief from bank regulatory requirements. CMHC also operates the Canadian Mortgage Bond Program, which provides lenders the ability to efficiently guaranty and securitize their mortgage loan portfolios. We compete with CMHC primarily based upon our reputation for high-quality customer service, quick decision-making on insurance applications, strong underwriting expertise and flexibility in terms of product development. In July 2003 the CMHC announced a 15% reduction in rates, which we have matched. This rate reduction, as well as any further similar actions taken by the CMHC, may cause our future revenue in our Canadian mortgage insurance business to decline. In addition, as in other markets, we compete in Canada with alternative products and financial structures, such as credit default swaps and captive insurers owned by lenders, that are designed to transfer credit default risk on mortgage loans.

#### *Australia and New Zealand*

We entered the Australian mortgage insurance market in 1997 with our acquisition of the operating assets of the Housing Loans Insurance Corporation, or HLIC, from the Australian government. We entered the New Zealand mortgage insurance market in 1999 as an expansion of our Australian operations. Our mortgage insurance operations in Australia and New Zealand accounted for approximately 36% of our total international mortgage insurance revenues for the year ended December 31, 2003.

#### *Products*

In Australia and New Zealand, we offer primary flow insurance, known as "lenders mortgage insurance," or LMI, and portfolio credit enhancement policies. As of December 31, 2003, LMI

164

---

represented 89% and portfolio credit enhancement represented 11% of our mortgage insurance in force in Australia and New Zealand. Our principal product is LMI, which is similar to the primary flow insurance we offer in Canada, with single premiums and 100% coverage. Lenders usually collect the single premium from prospective borrowers at the time the loan proceeds are advanced and remit the amount to us as the mortgage insurer. We in turn allocate most of the proceeds to unearned premium reserves, invest those proceeds and recognize the premium revenues over time according to an actuarially determined multi-year schedule.

We provide LMI on a flow basis to two types of customers: banks, building societies and credit unions; and non-bank mortgage originators, called mortgage managers. Banks, building societies and credit unions generally acquire LMI only for residential mortgage loans with loan-to-value ratios above 80%, because reduced capital requirements apply to high loan-to-value residential mortgages only if they have been insured by an "A" rated, or equivalently rated, mortgage insurance company that is regulated by the Australian Prudential Regulation Authority, or APRA. Our insurance subsidiary that serves the Australian and New Zealand markets has financial-strength ratings of "AA" (Very Strong) from S&P and Fitch and a rating of "Aa2" (Excellent) from Moody's. There is no comparable capital incentive to purchase mortgage insurance for mortgages with loan-to-value ratios below 80%. The "AA" rating is the third-highest of S&P's 21 ratings categories and the third-highest of Fitch's 24 ratings categories. The "Aa2" rating is the third-highest of Moody's 21 ratings categories.

Mortgage managers fund their operations primarily through the issuance of mortgage-backed securities. Because they are not regulated by APRA, they do not have the same capital incentives as banks for acquiring LMI. However, they use LMI as the principal form of credit enhancement for these securities and generally purchase insurance for every loan they originate, without regard to the loan-to-value ratio.

We also provide portfolio credit enhancement policies to APRA-regulated lenders that have originated loans for securitization in the Australian market. Portfolio mortgage insurance serves as an important source of credit enhancement for the Australian securitization market, and our portfolio credit enhancement coverage generally is purchased for low loan-to-value, seasoned loans written by APRA-regulated institutions. To date, a market for these portfolio credit enhancement policies has not developed in New Zealand to the same extent as in Australia.

In both primary LMI and portfolio credit enhancement policies, our mortgage insurance provides insurance coverage for the entire unpaid loan balance, including selling costs and expenses, following the sale of the security property. Most of the loans we insure in Australia and New Zealand are variable rate mortgages with loan terms of between 20 and 30 years.

In connection with our acquisition of the operating assets of HLIC in 1997, we agreed to service a mortgage insurance portfolio that was retained by the Australian government. We receive a small amount of management fees for handling claims and providing loss mitigation and related services, but we did not acquire HLIC's originated insurance policies and do not bear any risk on those policies.

#### *Customers*

The ten largest mortgage originators in Australia, consisting of seven banks and three mortgage managers, collectively provide more than 80% of Australia's and New Zealand's residential mortgage financing. These ten originators provided us with 78% of our new insurance written for the year ended December 31, 2003, compared with 77% and 74% for the years ended December 31, 2002 and 2001, respectively. Other market participants in Australian and New Zealand mortgage lending include regional banks, building societies and credit unions.

165

---

#### *Competitors*

The Australian and New Zealand mortgage insurance markets are served by one other independent LMI company, PMI, as well as various lender-affiliated captive mortgage insurance companies. We compete with PMI primarily based upon our reputation for high-quality customer service, quick decision making on insurance applications, strong underwriting expertise and flexibility in terms of product development. As in Canada, we also compete in Australia and New Zealand with alternative products and financial structures that are designed to transfer credit default risk on mortgage loans.

APRA's license conditions require Australian mortgage insurance companies, including ours, to be mono-line insurers, which are insurance companies that offer just one type of insurance product. However, in November 2003, APRA announced that it is considering, and has sought comment on, a proposal to eliminate the requirement that mortgage insurance companies be mono-line insurers, which APRA believes could facilitate the entry of new competitors.

#### *Europe*

We began our European operations in 1994 in the U.K., which is Europe's largest market for mortgage loan originations. We expanded into five additional countries between 1999 and 2003, and we continue to explore opportunities in other European countries. Mortgage insurance originating in the U.K. accounted for approximately 81% of our European mortgage insurance in force as of December 31, 2003. This large concentration in the U.K. is attributable primarily to the fact that we have been operating in that country considerably longer than in any other European country. Our mortgage insurance operations in Europe accounted for approximately 9% of our total international mortgage insurance revenues for the year ended December 31, 2003.

#### *Products*

Our European business currently consists principally of primary flow insurance on adjustable-rate mortgages. As is the case in our other non-U.S. markets, most primary flow insurance policies written in Europe are structured with single premium payments. Our primary flow insurance generally provides first-loss coverage in the event of default on a portion (typically 10%-20%) of the balance of an individual mortgage loan. We believe that, over time, there is an opportunity to provide additional products with higher coverage percentages to reduce the risks to lenders of low-down-payment lending to levels similar to those in more mature mortgage insurance markets. We also recently began offering portfolio credit enhancement policies to lenders that have originated loans for securitization in select European markets.

#### *Customers*

As a result of our strategy to expand organically into new markets in Europe with attractive growth potential, our portfolio of international mortgage insurance in force in Europe is concentrated in the countries where we have been active for the longest period of time and with customers with whom we have been doing business for the longest period of time. We expect this concentration to diminish over time. Our customers are primarily banks and mortgage investors, and our largest customer in Europe, which is a bank in the U.K., accounted for 48% of our new insurance written in the European markets for the year ended December 31, 2003, compared with 67% and 92% for the years ended December 31, 2002 and 2001, respectively. This customer periodically reviews its needs for external risk mitigation, including mortgage insurance, and recently has indicated to us that it may cease to purchase mortgage insurance. We are in discussions regarding alternative arrangements to retain our relationship with this customer. In any event, we believe that any decline in new insurance written with this customer will be offset by increased business from our existing and future customers.

166

---

#### *Competitors*

Our European business faces competition from both traditional mortgage insurance companies as well as providers of alternative credit enhancement products. Our competitors are both public and private entities. Public mortgage guarantee facilities exist in The Netherlands, Sweden, Finland, some of the Baltic states, and, on a limited regional basis, in Italy, which provide (except in The Netherlands) first-loss coverage at premium rates and coverage levels similar to ours. We also face competition from affiliates of other U.S. private mortgage insurers, such as PMI, Radian and United Guaranty Residential Insurance Company, as well as multi-line insurers primarily in the U.K. and the Republic of Ireland, such as Norwich Union, Legal & General and Royal & SunAlliance. In April 2004, PMI purchased Royal & SunAlliance's mortgage insurance business in the U.K.

We also face competition from alternative credit enhancement products, such as personal guarantees on high loan-to-value loans, second mortgages and bank guarantees, and captive insurance companies organized by lenders. Lenders also have sought other forms of risk transfer, such as the use of capital market solutions through credit derivatives. In addition, some European lenders have chosen to price for and retain the additional credit risk, effectively self-insuring their low-down-payment loans. We believe



that our global expertise, coverage flexibility, and strong ratings provide a very valuable offering compared with competitors and alternative products.

### *Loan portfolio*

The following table sets forth selected financial information regarding the effective risk in force of our international mortgage insurance loan portfolio as of the dates indicated:

	Historical		
	December 31,		
	2003	2002	2001
<b>(Dollar amounts in millions)</b>			
<b>Loan-to-value ratio</b>			
95.01% and above	\$ 132	\$ 12	\$ 11
90.01% to 95.00%	11,549	6,884	4,486
80.01% to 90.00%	15,762	8,718	5,563
80.00% and below	15,926	10,091	6,651
<b>Total</b>	<b>\$ 43,369</b>	<b>\$ 25,705</b>	<b>\$ 16,711</b>
<b>Loan type</b>			
Fixed rate mortgage	\$ —	\$ —	\$ —
Adjustable rate mortgage	43,369	25,705	16,711
<b>Total</b>	<b>\$ 43,369</b>	<b>\$ 25,705</b>	<b>\$ 16,711</b>
<b>Mortgage term</b>			
15 years and under	\$ 17,493	\$ 11,813	\$ 8,694
More than 15 years	25,876	13,892	8,017
<b>Total</b>	<b>\$ 43,369</b>	<b>\$ 25,705</b>	<b>\$ 16,711</b>

167

Our businesses in Australia, New Zealand and Canada currently provide 100% coverage on the majority of the loans we insure in those markets. The table above presents effective risk in force, which recognizes that the loss on any particular loan will be reduced by the net proceeds received upon sale of the property. Effective risk in force has been calculated by applying to insurance in force a factor that represents our highest expected average per-claim payment for any one underwriting year over the life of our businesses in Australia, New Zealand and Canada. As of December 31, 2003 this factor was 35% in each of Australia, New Zealand and Canada.

### *Loans in default and claims*

The claim process in our international mortgage insurance business is similar to the process we follow in our U.S. mortgage insurance business. "See—Mortgage Insurance—U.S. mortgage insurance—Loans in default and claims." The following table sets forth the number of loans insured, the number of loans in default and the default rate for our international mortgage insurance portfolio:

	Historical		
	December 31,		
	2003	2002	2001
<b>Primary insurance</b>			
Insured loans in force	1,282,731	1,054,703	790,294
Loans in default	4,926	3,641	3,471
Percentage of loans in default (default rate)	0.4%	0.4%	0.4%
Flow loans in force	1,044,131	753,314	549,039
Flow loans in default	4,679	3,268	3,262
Percentage of flow loans in default (default rate)	0.5%	0.4%	0.6%
Portfolio credit enhancement loans in force	238,600	301,389	241,255
Portfolio credit enhancement loans in default	247	373	209
Percentage of portfolio credit enhancement loans in default (default rate)	0.1%	0.1%	0.1%

### **Corporate and Other**

Our Corporate and Other segment consists of net realized investment gains (losses), and unallocated corporate income and expenses (including amounts accrued in settlement of class action lawsuits), interest, and other financing expenses that are incurred at our holding company level. This segment also includes the results of Viking Insurance Company, GE Seguros and a few other small, non-core businesses that are managed outside our operating segments.

Our subsidiary, Viking Insurance Company, is a Bermuda-based reinsurer primarily of leased equipment insurance and consumer credit insurance underwritten by American Bankers Insurance Company, or ABIC. GE's Vendor Financial Services business purchases property and casualty insurance from ABIC on behalf of certain of its

lessees to cover leased equipment. ABIC then reinsures those policies with Viking. GE's Card Services business develops and markets credit insurance through credit card issuers, retailers and banks. These credit insurance policies also are underwritten by ABIC and then reinsured with Viking.

Viking also has an in-force block of reinsurance of U.S. and Canadian consumer auto warranties and property and casualty gap insurance that protects consumers from the risk of loss on any difference between the value of an automobile and any loans secured by it. We do not intend to enter into any new warranty or gap insurance reinsurance treaties, and we intend to place the existing treaties in run-off, with the remaining program expiring over the next four years.

168

GE has informed us that Vendor Financial Services intends to cease purchasing new insurance coverage on behalf of lessees through ABIC, as of March 1, 2004, and Card Services intends to phase out marketing credit insurance over the next several years. GE Capital has agreed to take all commercially reasonable efforts to maintain the relevant existing insurance and reinsurance relationships, but we expect Viking's reinsurance programs with GE's Card Services business and Vendor Financial Services to decline steadily over the next several years and, ultimately, be discontinued. With respect to Card Services' credit insurance, GE Capital may decide to encourage a switch of existing coverages to another program. In that event, GE Capital has agreed to pay Viking an amount equal to the net underwriting income that Viking is projected to receive as reinsurer from the date of discontinuation of any credit insurance program through December 31, 2008. See "Agreements Between GE and our Company—Relationship with GE—Agreement Regarding Continued Reinsurance by Viking."

Our subsidiary, GE Seguros, is a small Mexican-domiciled multi-line insurer. We acquired this business in 1995 and currently hold 99.6% of its outstanding shares. GE Seguros is licensed to sell property and casualty, life and health insurance in Mexico.

GE Seguros currently writes primarily motor vehicle coverage for personal and commercial domestic vehicles and personal coverage for tourist vehicles. It also writes a small amount of homeowners', commercial property, transport and life insurance. GE Seguros distributes its products through independent agents in Mexico and, for the tourist auto business, it also distributes its products through agents located in key U.S. border locations. GE Seguros maintains agency relationships through its branch offices in ten major Mexican cities.

Viking, GE Seguros and other small, non-core businesses had aggregate net earnings of \$28 million, \$42 million and \$47 million for the years ended December 31, 2003, 2002 and 2001.

## Distribution

We distribute our products through an extensive and diversified distribution network that is balanced between independent sales intermediaries, including financial intermediaries and independent producers, and dedicated sales specialists. We believe this access to a variety of distribution channels enables us to respond effectively to changing consumer needs and distribution trends. We have strategically positioned our multi-channel distribution network to capture a broad share of the distributor and consumer markets and to accommodate different consumer preferences in how to purchase insurance and financial services products.

### *Protection and Retirement Income and Investments segments*

Our Protection and Retirement Income and Investments segments both distribute their products through the following channels:

- Financial intermediaries, including banks, securities brokerage firms, and independent broker/dealers;
- Independent producers, including brokerage general agencies, affluent market producer groups and specialized brokers; and
- Dedicated sales specialists, including long-term care sales agents and affiliated networks of both accountants and personal financial advisers.

The following table sets forth our annualized first-year premiums and deposits for the products in our Protection and Retirement Income and Investments segments, categorized by each of our distribution channels. Annualized first-year premiums and deposits reflect the amount of business we generated during a specified period. We consider annualized first-year premiums and deposits to be a measure of our operating performance because they represent a measure of new sales of insurance

169

policies and additional investments by our customers during a specified period, rather than a measure of our revenues or profitability during that period.

	Historical			
	Year ended December 31, 2003			
	Financial Intermediaries	Independent producers	Dedicated sales specialists	Total
<b>Protection</b>				
Life insurance	\$ 10	\$ 145	\$ 8	\$ 163
Long-term care insurance	53	51	136	240
European payment protection insurance	1,447	288	—	1,735
Group life and health insurance	—	144	—	144
Total annualized first-year premiums and deposits	\$ 1,510	\$ 628	\$ 144	\$ 2,282
<b>Retirement Income and Investments</b>				
Spread-based retail products	\$ 1,386	\$ 897	\$ 84	\$ 2,367
Spread-based institutional products(1)	—	3,702	—	3,702
Fee-based products	2,005	803	99	2,907

(Dollar amounts in millions)

Total annualized first-year premiums and deposits	\$	3,391	\$	5,402	\$	183	\$	8,976
---	----	-------	----	-------	----	-----	----	-------

- (1) Deposits on spread-based institutional products includes contracts that have matured but are redeposited with our company. In the year ended December 31, 2003, deposits of spread-based institutional products included \$1,675 million that was redeposited.

#### *Financial intermediaries*

We have selling agreements with approximately 900 financial intermediaries in the U.S., including banks, securities brokerage firms and independent broker/dealers. We use financial intermediaries to distribute a significant portion of our fixed, variable and income annuities and other investment products, and long-term care insurance. They also distribute a small portion of our life insurance policies to their individual clients. We have approximately 100 wholesalers in the U.S. who are our employees and who work to develop sales relationships with new financial intermediaries and to expand sales through existing financial intermediaries. In addition, we have 87 distributors, most of which are financial intermediaries, for our European payment protection insurance products.

#### *Independent producers*

*Brokerage general agencies.* We distribute most of our products, including life insurance, annuities and long-term care insurance through approximately 500 independent brokerage general agencies, or BGAs, located throughout the U.S. Approximately 270 of these BGAs distribute our life insurance, annuities and long-term care insurance products, and approximately 230 of them are long-term care insurance specialists and generally distribute only our long-term care insurance products. These BGAs market our products, and those of other insurance companies, through a network of approximately 243,500 independent brokers who are licensed and appointed to sell our products.

*Affluent market producer groups.* We have preferred carrier relationships with several industry leading affluent market producer groups. Through these relationships, we have access to approximately 5,000 producers who are licensed and appointed to sell our products. These groups target high-net-worth individuals, which we define to include households with at least \$1 million of liquid assets, as well as small to medium-size businesses, which we define as those with fewer than 1,000

employees. We distribute life insurance, long-term care insurance and annuity products through these groups.

*Specialized brokers.* We distribute many of our products through brokers that specialize in a particular insurance or investment product and deliver customized service and support to their clients. We use a network of approximately 350 specialized independent brokers to distribute income annuities and structured settlements. We believe we have one of the oldest and largest distribution systems for structured settlements, and our relationships with many of these specialized brokers date back more than 20 years. We distribute our group life and health insurance products and services through an independent network of approximately 5,000 licensed group life and health brokers and agents that are supported by our nationwide sales force of approximately 100 employees. These group brokers and agents typically specialize in providing employee benefit and retirement solution services to employers. We also distribute GICs and funding agreements through a group of approximately 35 specialized brokers and investment managers.

#### *Dedicated sales specialists*

*Long-term care agents.* We have approximately 1,800 sales agents who specialize in selling our long-term care insurance products, 70 of which are product specialists who assist our independent sales intermediaries in selling our long-term care insurance products. They also sell our Medicare supplement insurance product and the products of other insurers on a select basis. We employ the individuals who manage and support the dedicated sales specialists. We compensate our long-term care agents primarily on a commission basis. To support lead generation for this channel, we have a comprehensive direct mail and marketing program, including mass marketing and affinity strategies that target members of various organizations, such as travel, social and professional organizations. We also identify prospective customers through educational seminars, policyholder referrals and targeted promotions linked to our national advertising campaigns.

*Accountants and personal financial advisers.* We have more than 2,000 affiliated personal financial advisers, of whom approximately 1,700 are accountants, who sell our annuity and insurance products including variable products, third-party mutual funds and other investment products through our wholly-owned broker/dealers. In the past several years, accountants have been increasingly responsible for assisting their clients with long-term financial planning, as well as traditional accounting and tax-related services. As a result, we believe accountants provide us with an opportunity for growth as a distribution channel. We distribute primarily annuities and other investment products through this distribution channel.

#### *Mortgage Insurance*

We distribute our mortgage insurance products through our dedicated sales force of more than 100 employees located throughout the U.S. This sales force primarily markets to financial institutions and mortgage originators, which in turn offer mortgage insurance products to borrowers. In addition to our field sales force, we also distribute our products through a telephone sales force serving our small lender and broker customer segments, as well as through our "Action Center" which provides live phone and web chat based support for all our customer segments.

We also maintain a dedicated sales force that markets our mortgage insurance products to lenders in Canada, Australia, New Zealand, and Europe. As in the U.S. market, our sales force markets to financial institutions and mortgage originators, who in turn offer mortgage insurance products to borrowers.

## **Marketing**

In addition to the breadth and variety of our distribution channels, we have differentiated our approach to the market through product breadth, technology services, specialized support for our distributors and innovative marketing programs tailored to particular consumer groups. We also have developed a comprehensive strategy to promote our new corporate brand after the completion of our initial public offering and our separation from GE.

We offer a breadth of products that meet the needs of consumers throughout the various stages of their lives. We refer to our approach to product diversity as "smart" breadth because we are selective in the products we offer and strive to maintain appropriate return and risk thresholds when we expand the scope of our product offerings. We believe our reputation for innovation and our smart breadth of products enable us to sustain strong relationships with our distributors and position us to benefit from the current trend among distributors to reduce the number of insurers with whom they maintain relationships, while at the same time they continue to be able to access a broad range of products. We also have developed sophisticated technological tools that enhance performance by automating key processes and reducing response times and process variations.

These tools also make it easier for our customers and distributors to do business with us.

We maintain strong relationships with leading distributors by providing a high level of specialized and differentiated distribution support, such as product training, advanced marketing and sales solutions, financial product design for affluent customers and technology solutions that support the distributors' sales efforts and by pursuing joint business improvement efforts. We also sponsor various advisory councils with independent sales intermediaries and dedicated sales specialists to gather their feedback on industry trends, new product suggestions and ways to enhance our relationships. For the past several years, we have offered programs to share our Six Sigma process quality methods with our distributors. To this end, we have participated in a joint business improvement initiative (originally developed by GE), called "At the Customer For the Customer," or ACFC, through which we help our independent sales intermediaries increase sales and realize greater efficiencies in their businesses. We believe ACFC has been favorably received by our distributors and has helped to differentiate us from our competitors. During 2003, our independent sales intermediaries initiated more than 200 projects through the ACFC program.

We have designed innovative marketing programs that target different consumer groups. For example, we sponsor the GE Center for Financial Learning, which provides a web site to promote financial literacy. The site has won more than 35 Internet and industry awards and contains detailed information about various insurance and investment products and financial decisions facing consumers. The site was developed with the help of leading academic experts and financial professionals who also serve on the GE Center for Financial Learning's Advisory Board. This website is devoted solely to financial education and does not sell or promote any products. However, we believe the website contributes to the recognition of our products and services and generates loyalty among independent sales intermediaries and consumers.

We also have been actively marketing our products to U.S. Latino customers, who we believe are substantially underserved by insurance and investment products, despite being the largest minority group in the U.S. As part of this campaign, we recruit Spanish-speaking agents, translate various marketing materials into Spanish, advertise our services on Telemundo Spanish television, participate in Latin American street fairs, and, as part of the GE Center for Financial Learning, operate a Spanish-language web site devoted to financial education for U.S. Latinos.

Our other innovative marketing programs include our two mobile marketing units that visit more than 50 communities each year to generate publicity and sales opportunities for our products, our coordination of the national Long-Term Care Awareness Day, and our sponsorship of the Alzheimer Association's annual Memory Walk across the U.S.

172

---

Branding has been, and will continue to be, an important aspect of our total marketing program. We currently use the GE brand name and logo in nearly all our marketing and distribution activities, including product names, product brochures, websites, stationery, signage, advertising and promotions. In addition, many of our insurance subsidiaries incorporate "GE," "General Electric" or "GE Capital" in their corporate names. Pursuant to a transitional trademark license agreement, GE will grant us the right to use the "GE" mark and the "GE" monogram for up to five years in connection with our products and services. GE also will grant us the right to use "GE," "General Electric" and "GE Capital" in the corporate names of our subsidiaries until the earlier of twelve months after the date on which GE owns less than 20% of our outstanding common stock and five years from the date of the trademark license agreement. In addition, insurance regulators in the U.S. and the other countries where we do business could require us to accelerate the transition to our independent brand. See "Arrangements Between GE and Our Company—Relationship with GE—Intellectual Property Arrangements—Transitional Trademark License Agreement."

Our branding strategy is to establish our new Genworth brand expeditiously while we continue to use the GE brand name and logo with customers. We are planning a phased brand rollout. Our first phase will emphasize the relationship between Genworth and the GE brand with continued references to GE and the GE brand in selective marketing materials. Within 12 months of the completion of our initial public offering, we intend to re-brand most standard communications materials with the Genworth logo, name and corporate identity, including the references to GE. During 2004 and 2005, we also intend to promote the Genworth brand through various communications, such as advertising, promotions, print media, the Internet, public relations efforts, and special events for distributors and consumers. We intend to customize our brand transition strategy for each of our distribution channels.

We expect to incur aggregate incremental expenses of approximately \$35 million in each of 2004 and 2005 for marketing, advertising and legal entity transition expenses, reflecting primarily the additional costs of establishing our new brand throughout our business, including with consumers and sales intermediaries.

## **Risk Management**

### ***Overview***

Risk management is a critical part of our business, and we have adopted rigorous risk management processes in virtually every aspect of our operations, including product development, underwriting, investment management, asset-liability management, and technology development projects. The primary objective of these risk management processes is to reduce the variations we experience from our expected results. We have an experienced group of more than 130 professionals, including actuaries, statisticians and other specialists, dedicated exclusively to our risk management process. We believe we have benefited from the sophisticated risk management techniques that GE applies throughout its businesses, and we have emphasized our adherence to those techniques as a competitive advantage in marketing and managing our products. We intend to maintain a prudent and highly disciplined risk management strategy as an independent company.

### ***New product introductions***

Our risk management process begins with the development and introduction of new products and services. We have established a rigorous product development process that specifies a series of required analyses, reviews and approvals for any new product. This process includes a review of the market opportunity and competitive landscape for each proposed product, major pricing assumptions and methodologies, return expectations, reinsurance strategies, underwriting criteria and business risks and potential mitigating factors. Before we introduce a new product in the market, we establish a monitoring program with specific performance targets and leading indicators, which we monitor frequently to identify any deviations from expected performance so that when necessary, we can take

173

---

prompt corrective action. All new products require approval by our senior management team. We use a similarly rigorous process to introduce variations to existing products and to introduce existing products through new distribution channels.

### ***Product performance reviews***

The Risk Committee for our Protection and Retirement Income and Investments segments includes our President and Chief Executive Officer, Chief Risk Officer, Chief Financial Officer, Head of Product Management, Chief Investment Officer and Chief Actuary. The Risk Committee reviews each of our products on a regular cycle, typically approximately twice per year. These reviews include an analysis of the major drivers of profitability, underwriting performance, variations from expected results, regulatory and competitive environment and other factors affecting product performance. In addition, we initiate special reviews when a product's performance fails to meet any of the indicators we established during that product's introductory review process. If a product does not meet our performance criteria, we consider adjustments in pricing, design and

marketing or ultimately discontinuing sales of that product. We review our underwriting, pricing and risk selection strategies on a regular basis to ensure that our products remain progressive, competitive and consistent with our marketing and profitability objectives. We are also subject to periodic external audits by our reinsurers, which provide us with valuable insights into other innovative risk management practices.

In managing the risks of our Mortgage Insurance segment, we carefully monitor portfolio trends and product performance, including credit quality, product concentrations and claims development. We evaluate trends in our portfolio through various means, including comparison of results to pre-established targets and to our historical experience, analysis of borrower credit scores, and use of our own proprietary mortgage scoring model, OmniScore®. We obtain borrower FICO scores and other credit data directly from credit bureaus when available, thereby enabling us to independently evaluate the credit quality of loans submitted to us. We also regularly evaluate the profitability of our products in light of market conditions and forecasts developed during the product development process. As in our other segments, if a mortgage insurance product's performance fails to meet any of the indicators we established during that product's introductory review process or otherwise shows negative trends, we consider changes to our product guidelines, price adjustments, limiting our exposure or discontinuing the offering of that product. We also assess portfolio quality and loan performance at the lender account level using OmniScore®, FICO scores and other credit data and our historical claims experience. Our risk management team conducts portfolio quality and loan performance reviews with lenders as required, during which we consider and address any significant trends and performance issues. We also review the profitability of lender accounts on a quarterly basis to ensure that our business with these lenders is achieving anticipated performance levels and to identify trends requiring remedial action. Corrective actions may include changes to our underwriting guidelines, product mix or other programs with lenders.

#### *Asset-liability management*

We maintain segmented investment portfolios for the majority of our product lines. This enables us to perform an ongoing analysis of the interest rate risks associated with each major product line, in addition to the interest rate risk for our overall enterprise. We analyze the behavior of our liability cash flows across a wide variety of future interest rate scenarios, reflecting policy features and expected policyholder behavior. We also analyze the behavior of our asset portfolio across the same scenarios. We believe this analysis shows the sensitivity of both our assets and liabilities to large and small changes in interest rates and enables us to manage our assets and liabilities more effectively.

174

---

#### *Portfolio diversification*

We use strict limits to avoid concentrations of risk in our investment portfolio. The techniques we use to manage our exposure to credit risk, interest rate risk and market valuation risk are discussed in further detail below under "—Investments."

In managing our mortgage insurance risk exposure, we carefully monitor geographic concentrations in our portfolio and the condition of housing markets in each country in which we operate. We monitor our concentration of risk in force at the regional, state and major metropolitan area levels on a quarterly basis. In the U.S., we evaluate the condition of housing markets in major metropolitan areas with our proprietary OmniMarket<sup>SM</sup> model, which rates housing markets based on variables such as economic activity, unemployment, mortgage delinquencies, home sales trends and home price changes. We also regularly monitor factors that affect home prices and their affordability by region and major metropolitan area.

#### *Actuarial databases and information systems*

Our extensive actuarial databases and innovative information systems technology are important tools in our risk management programs. We believe we have the largest actuarial database for long-term care insurance claims with almost 30 years of experience in offering those products. We also have substantial experience in offering individual life insurance products, and we have developed a large database of claims experience, particularly in preferred risk classes, which provides significant predictive experience for mortality.

We use advanced and, in some cases, proprietary technology to manage variations in our underwriting process. For example, our GENIUS® new business processing system uses digital underwriting technology that is designed to reduce policy issue times, lower our operating costs and increase the consistency and accuracy of our underwriting process by reducing decision-making variation. In our mortgage insurance business we use borrower credit scores, our proprietary mortgage scoring model, OmniScore®, and our extensive database of mortgage insurance experience to evaluate new products and portfolio performance. OmniScore® uses the borrower's credit score and additional data concerning the borrower, the loan and the property, including loan-to-value ratio, loan type, loan amount, property type, occupancy status and borrower employment to predict the likelihood of having to pay a claim. In the U.S., OmniScore® also incorporates our assessment of the housing market in which a property is located, as evaluated with our OmniMarket<sup>SM</sup> model. We believe this additional mortgage data and housing market assessment significantly enhances OmniScore's® predictive power over the life of the loan. We perform portfolio analysis on an ongoing basis to determine if modifications are required to our product offerings, underwriting guidelines or premium rates.

#### *Compliance*

We take a disciplined approach to legal and regulatory compliance practices and throughout our company instill a strong commitment to integrity in business dealings and compliance with applicable laws and regulations. In recognition of this commitment, we have received the American Council of Life Insurers' Integrity First Award in both 2001 and 2002. We have approximately 140 employees dedicated to compliance matters.

### **Operations and Technology**

#### *Service and support*

We have a dedicated team of approximately 5,000 service and support personnel (including our operations through an arrangement with a GE subsidiary in India) who assist our sales intermediaries and customers with their service needs. We use advanced and, in some cases, proprietary, patent-

175

---

pending technology to provide customer service and support, and we operate service centers that leverage technology, integrated processes, and Six Sigma process management techniques.

In our Protection and Retirement Income and Investments segments, we interact directly and cost-effectively with our independent sales intermediaries and dedicated sales specialists through secure websites, which have enabled them to transact business with us electronically, obtain information about our products, submit applications, check application and account status and view commission information. We also provide our independent sales intermediaries and dedicated sales specialists with account information to disseminate to their customers through the use of industry-standard XML communications. Our technology teams actively participate in the development of industry standards and have received early adopter awards from industry organizations such as the Association for Cooperative Operations Research and Development, or ACORD.

We also have introduced technologically advanced services to customers in our Mortgage Insurance segment. Historically, lenders submitted applications for mortgage insurance via mail, courier or fax. If we approved the loan, we would issue a certificate of insurance to the lender. Advances in technology now enable us to accept applications through electronic submission and to issue electronic insurance commitments and certificates. Our AU Central® Internet platform provides lenders real-time access to multiple automated underwriting systems at the point of sale, helping them to originate loans more easily and efficiently. For the year ended December 31, 2003, we issued approximately 82% of our U.S. mortgage insurance commitments electronically, compared to 78% for the year ended December 31, 2002 and 55% for the year ended December 31, 2001. Through our Internet-enabled information systems, lenders can receive information about their loans in our database, as well as make corrections, file notices and claims, report settlement amounts, verify loan information and access payment histories. We also assist in workouts through LMO Fast-Track, which we believe is the mortgage insurance industry's first on-line workout approval system, allowing lenders to request and obtain authorization from us for them to provide workout solutions to their borrowers.

#### ***Operating centers***

We have centralized our operations and have established scalable, low-cost operating centers in Virginia, North Carolina, India and Ireland. We expect to realize additional efficiencies from further facility rationalization, which includes centralizing additional U.S. operations and consolidating mailrooms and print centers. Through an arrangement with GE, we have a substantial team of professionals in India who provide a variety of services to us, including customer service, transaction processing, and functional support including finance, investment research, actuarial, risk and marketing resources to our insurance operations. Most of the personnel in India have college degrees, and many have graduate degrees. See "Arrangements Between GE and Our Company—Relationship with GE—Arrangements regarding our operations in India" for a description of this arrangement.

#### ***Technology capabilities***

We employ approximately 560 information technology professionals throughout our organization. These include approximately 30 project managers, all of whom have been certified by the Project Management Institute to design and develop new technological capabilities.

We rely on proprietary processes for project approval, execution, risk management and benefit verification as part of our approach to technology investment. We hold, or have applied for, more than 120 patents. Our technology team is experienced in large-scale project delivery, including many insurance administration system consolidations and the development of Internet-based servicing capabilities. We continually manage technology costs by standardizing our technology infrastructure, consolidating application systems, reducing servers and storage devices, and managing project execution risks.

176

---

We work with associates from GE's Global Research Center to develop new technologies that help deliver competitive advantages to our company. After our separation from GE, we will complete our existing projects with the GE Global Research Center under their current terms. We also may work on new projects with the GE Global Research Center in the future. All new projects will be pursuant to individual agreements that will be negotiated on mutually agreeable terms. See "Arrangements Between GE and Our Company—Relationship with GE—Transition Services Agreement."

#### ***Six Sigma***

We believe we have greatly enhanced our operating efficiency and generated significant cost savings by using a highly disciplined quality management and process optimization methodology known as Six Sigma, which relies on the rigorous use of statistical techniques to assess process variations and defects. Six Sigma is a quality program consisting of a combination of GE proprietary and licensed materials, concepts, methodologies and software tools. The program uses a disciplined methodology to define, measure, analyze, improve and control the features and performance of a company's products and processes. Six Sigma creates a rigorous process analysis supported by data to measure defect levels in a given process or product. By measuring defects and identifying their root causes, processes and products can be improved to deliver and sustain higher levels of performance as measured by timeliness, accuracy, cost and customer satisfaction.

We have a team of approximately 300 employees who have received extensive training and certification in Six Sigma, an additional 1,400 employees have received standard Six Sigma certification, and nearly all our employees have attained a basic level of competence in the Six Sigma methodology.

Pursuant to the transition services agreement that we will enter into with GE prior to the completion of this offering, GE, at no cost to us, will ensure that we will be able to continue to use our Six Sigma program in a manner consistent with our use prior to the completion of this offering.

#### **Reserves**

We calculate and maintain reserves for the estimated future payment of claims to our policyholders and contractholders based on actuarial assumptions and in accordance with U.S. GAAP and industry accounting practices. Many factors can affect these reserves and liabilities, including economic and social conditions, inflation, healthcare costs, changes in doctrines of legal liability and damage awards in litigation. Therefore, the reserves and liabilities we establish are necessarily based on extensive estimates, assumptions and our analysis of historical experience. Our results depend significantly upon the extent to which our actual claims experience is consistent with the assumptions we used in determining our reserves and pricing our products. Our reserve assumptions and estimates require significant judgment and, therefore, are inherently uncertain. We cannot determine with precision the ultimate amounts that we will pay for actual claims or the timing of those payments.

#### ***Protection***

We establish reserves for life insurance policies based generally upon actuarially recognized methods. We use mortality tables in general use in the U.S. and Europe, modified to reflect our expected claims. Persistency, expense and interest rate assumptions are based upon relevant experience and expectations for the future. We establish reserves at amounts we expect to satisfy our policy obligations, including assumptions for the receipt of additional premiums and of interest to be earned on the reserves. The liability for policy benefits for universal life insurance policies and interest-sensitive whole life policies is equal to the balance that accrues to the benefit of policyholders, including credited interest, plus any amount needed to provide for additional benefits. We also establish reserves for amounts that we have deducted from the policyholder's balance to compensate us for services to be performed in future periods, and we release these reserves as those future obligations are extinguished.

177

---

We establish reserves for long-term care insurance policies based upon a variety of factors including claim likelihood, continuance, severity, persistency, and plan of coverage. Long-term care insurance policies are long-duration products, and therefore our future claims experience may be different from what we expected when we issued the policies. Moreover, long-term care insurance does not have the claims experience history of life insurance, and as a result, our ability to forecast claims for long-term care insurance products is more limited than for life products.

Our liability for unpaid group life and health insurance claims, including our medical and non-medical lines, is an estimate of the ultimate net cost of both reported and

unreported losses not yet settled. Our liability is based upon an evaluation of historical claim run-out patterns and includes a provision for adverse claim development. Reserves for long-term disability insurance represent the actuarial present value of benefits for current claimants. Claim benefit payments on long-term disability insurance policies consist of payments made monthly, in accordance with the contractual terms of the policy. Reserves for incurred but not reported claims in our group life and health insurance business are based upon historic incidence rates.

We establish reserves for our European payment protection insurance using a number of actuarial models. Claims reserves are calculated separately for disability, life and unemployment business. Reserves are established at three different stages of a claim: incurred but not reported, reported but not paid and in the course of payment.

### **Retirement Income and Investments**

For our investment contracts, including annuities, GICs, and funding agreements, contractholder liabilities are equal to the accumulated contract account values, which generally consist of an accumulation of deposit payments plus credited interest or investment earnings, less expense and mortality charges, as applicable, withdrawals and other amounts assessed through the end of the period. We also maintain a separate reserve for expected future payments above the account value due to the death of a contractholder. Liabilities for future policy benefits on our immediate fixed annuity contracts are calculated based upon a set of actuarial assumptions that we establish and maintain throughout the lives of the contracts.

### **Mortgage Insurance**

In our mortgage insurance businesses, a significant period of time may elapse between the occurrence of the borrower's default on a mortgage payment, which is the event triggering a potential future claim payment, the reporting of such default and our eventual payment of the claim. Consistent with U.S. GAAP and industry accounting practices, we establish reserves for loans that are in default, including loans that are in default but have not yet been reported, by forecasting the percentage of loans in default on which we will ultimately pay claims and the average claim that will be paid. We generally consider a loan to be in default if the borrower has failed to make a required mortgage payment for two consecutive months. In addition to our reserves for known loans in default, we establish reserves for "loss adjustment expenses" to provide for the estimated costs of settling claims, including legal and other fees, and general expenses of administering the claims settlement process.

We estimate ultimate claims and associated costs based upon our historical loss experience, adjusted for the anticipated effect of current economic conditions and projected economic trends. Consistent with U.S. GAAP and industry accounting practices, we do not establish loss reserves for future claims on insured loans that are not currently in default.

To improve the reserve estimation process, we segregate our mortgage loan portfolio based upon a variety of factors, and we analyze each segment of the portfolio in light of our default experience to produce our reserve estimate. We review these factors on a periodic basis and adjust our loss reserves accordingly. Although inflation is implicitly included in the estimates, the impact of inflation is not

explicitly isolated from other factors influencing the reserve estimates. We do not discount our loss reserves for financial reporting purposes.

We also establish liabilities related to contract underwriting indemnification. Under the terms of our contract underwriting agreements, we agree to indemnify the lender against losses incurred in the event that we make material errors in determining that loans processed by our contract underwriters meet specified underwriting or purchase criteria. We revise our estimates of these liabilities from time to time to reflect our recent experience.

### **Reinsurance**

We follow the industry practice of reinsuring portions of our insurance risks with reinsurance companies. We use reinsurance both to diversify our risks and to manage loss exposures and capital effectively. The use of reinsurance permits us to write policies in amounts larger than the risk we are willing to retain, and also to write a larger volume of new business.

We cede insurance primarily on a treaty basis, under which risks are ceded to a reinsurer on specific blocks of business where the underlying risks meet certain predetermined criteria. To a lesser extent, we cede insurance risks on a facultative basis, under which the reinsurer's prior approval is required on each risk reinsured. Use of reinsurance does not discharge us, as the insurer, from liability on the insurance ceded. We, as the insurer, are required to pay the full amount of our insurance obligations even in circumstances where we are entitled or able to receive payments from our reinsurer. The principal reinsurers to which we cede risks have A.M. Best financial strength ratings ranging from "A++" to "A-." Historically, we have not had significant concentrations of reinsurance risk with any one reinsurer. However, prior to the completion of this offering, we will enter into reinsurance transactions with UFLIC, which will result in a significant concentration of reinsurance risk with UFLIC, as discussed under "Arrangements Between GE and Our Company—Reinsurance Transactions."

The following table sets forth, on an actual and pro forma basis, our exposure to our principal reinsurers, along with the reinsurance recoverable as of December 31, 2003, and the A.M. Best ratings of those reinsurers as of that date:

	Reinsurance recoverable	Pro forma reinsurance recoverable	A.M. Best rating
<b>(Dollar amounts in millions)</b>			
UFLIC(1)	\$ 0	\$ 16,345	A+
IDS Life Insurance Company(2)	758	758	A+
Phoenix Life Insurance Company(3)	667	667	A
Swiss Re Life & Health America Inc.	157	157	A++
Munich American Reassurance Company	120	120	A+
ERC(4)	107	107	A-
Revios Reinsurance	84	84	A-

(1) See "Arrangements Between GE and Our Company—Reinsurance Transactions."

(2) Our reinsurance arrangement with IDS covers a run-off block of single-premium life insurance policies.

(3) Our reinsurance arrangement with Phoenix covers a run-off block of corporate-owned life insurance policies. Both of these arrangements originated from acquisitions.

(4) ERC refers to Employers Reassurance Corporation (an indirect subsidiary of GE) and ERC Life Reinsurance Corporation (an indirect subsidiary of GE until December 2003).

As discussed above under "—Mortgage Insurance—Products and Services—Risk mitigation arrangements—Captive reinsurance," we have entered into a number of reinsurance agreements in which we share portions of our mortgage insurance risk written on loans originated or purchased by

lenders with captive reinsurance companies, or captive reinsurers, affiliated with these lenders. In return, we cede an agreed portion of our gross premiums on insurance written to the captive reinsurers. Substantially all of our captive mortgage reinsurance arrangements are structured on an excess-of-loss basis.

As of December 31, 2003 our total risk reinsured to all captive reinsurers was \$2.6 billion, and the total capital held in trust for our benefit by all captive reinsurers was \$410 million. These captive reinsurers are not rated, and their claims-paying obligations to us are limited to the amount of capital held in trust. We believe the capital held in trust by these captive reinsurers is sufficient to meet their anticipated obligations to us. However, we cannot ensure that each captive with which we do business can or will meet all its obligations to us.

### Financial Strength Ratings

Ratings with respect to financial strength are an important factor in establishing the competitive position of insurance companies. Ratings are important to maintaining public confidence in us and our ability to market our products. Rating organizations review the financial performance and condition of most insurers and provide opinions regarding financial strength, operating performance and ability to meet obligations to policyholders.

Upon the completion of this offering and the concurrent offerings, we expect our principal life insurance subsidiaries to be rated by A.M. Best, S&P and Moody's as follows:

Company	A.M. Best rating	S&P rating	Moody's rating
American Mayflower Life Insurance Company of New York	A+ (Superior)	AA- (Very strong)	Aa3 (Excellent)
Federal Home Life Insurance Company	A+ (Superior)	Not rated	Aa3 (Excellent)
First Colony Life Insurance Company	A+ (Superior)	AA- (Very Strong)	Aa3 (Excellent)
GE Capital Life Assurance Company of NY	A+ (Superior)	AA- (Very Strong)	Aa3 (Excellent)
GE Life and Annuity Assurance Company	A+ (Superior)	AA- (Very Strong)	Aa3 (Excellent)
GE Group Life Assurance Company	A (Excellent)	AA- (Very Strong)	Not Rated
General Electric Capital Assurance Company	A+ (Superior)	AA- (Very Strong)	Aa3 (Excellent)

Upon the completion of this offering and the concurrent offerings, we expect our mortgage insurance subsidiaries to be rated by S&P, Moody's and Fitch as follows:

Company(1)	S&P rating	Moody's rating	Fitch rating
General Electric Mortgage Insurance Corporation	AA (Very Strong)	Aa2 (Excellent)	AA (Very Strong)
GE Mortgage Insurance Company Pty. Limited	AA (Very Strong)	Aa2 (Excellent)	AA (Very Strong)
GE Mortgage Insurance Limited	AA (Very Strong)	Aa2 (Excellent)	AA (Very Strong)

(1) Our Canadian mortgage insurance company is not rated by any of the rating agencies shown above.

The A.M. Best, S&P, Moody's and Fitch ratings included in this prospectus are not designed to be, and do not serve as, measures of protection or valuation offered to investors in this offering and the concurrent offerings. These financial strength ratings should not be relied on with respect to making an investment in our securities.

A.M. Best states that its "A+" (Superior) rating is assigned to those companies that have, in its opinion, a superior ability to meet their ongoing obligations to policyholders. The "A+" (Superior) rating is the second-highest of fifteen ratings assigned by A.M. Best, which range from "A++" to "F".

S&P states that an insurer rated "AA" (Very Strong) has very strong financial security characteristics that outweigh any vulnerabilities, and is highly likely to have the ability to meet financial commitments. The "AA" range is the second-highest of the four ratings ranges that meet these criteria, and also is the second-highest of nine financial strength rating ranges assigned by S&P, which range from "AAA" to "R." A plus (+) or minus (-) shows relative standing in a rating category. Accordingly, the "AA" and "AA-" ratings are the third- and fourth-highest of S&P's 21 ratings categories.

Moody's states that insurance companies rated "Aa" (Excellent) offer excellent financial security. Moody's states that companies in this group constitute what are generally known as high-grade companies. The "Aa" range is the second-highest of nine financial strength rating ranges assigned by Moody's, which range from "Aaa" to "C." Numeric modifiers are used to refer to the ranking within the group, with 1 being the highest and 3 being the lowest. Accordingly, the "Aa2" and "Aa3" ratings are the third- and fourth-highest of Moody's 21 ratings categories.

Fitch states that "AA" (Very Strong) rated insurance companies are viewed as possessing very strong capacity to meet policyholder and contract obligations. Risk factors are modest, and the impact of any adverse business and economic factors is expected to be very small. The "AA" rating category is the second-highest of eight financial strength rating categories, which range from "AAA" to "D." The symbol (+) or (-) may be appended to a rating to indicate the relative position of a credit within a rating category. These suffixes are not added to ratings in the "AAA" category or to ratings below the "CCC" category. Accordingly, the "AA" rating is the third-highest of Fitch's 24 ratings categories.

A.M. Best, S&P, Moody's and Fitch review their ratings periodically and we cannot assure you that we will maintain our current ratings in the future. Other agencies may also rate our company or our insurance subsidiaries on a solicited or an unsolicited basis.

### Investments

As of December 31, 2003, on a pro forma basis, we had total cash and invested assets of \$61.3 billion (including \$1.1 billion of restricted investments held by securitization entities) and an additional \$8.2 billion held in our separate accounts, for which we do not bear investment risk. We manage our assets to meet diversification, credit quality, yield and liquidity requirements of our policy and contract liabilities by investing primarily in fixed-maturities, including government, municipal and corporate bonds, mortgage-backed and other asset-backed securities and mortgage loans on commercial real estate. We also invest in short-term securities and other investments, including a small position in equity securities. In all cases, investments for our particular insurance company subsidiaries are required to comply with restrictions imposed by applicable laws and insurance regulatory authorities.



Our primary investment objective is to meet our obligations to policyholders and contractholders while increasing value to our stockholders by investing in a diversified portfolio of high-quality, income-producing securities and other assets. Our investment strategy will optimize investment income without relying on realized investment gains. In an effort to achieve this objective, we intend to pursue a prudent investment strategy focusing primarily on:

- minimizing interest rate risk through rigorous management of asset durations relative to policyholder and contractholder obligations;
- selecting assets based on fundamental, research-driven strategies;
- emphasizing fixed-interest, low-volatility assets;
- maintaining sufficient liquidity to meet unexpected financial obligations;
- continuously evaluating our asset class mix and pursuing additional investment classes; and
- rigorous, continuous monitoring of asset quality.

181

We are exposed to two primary sources of investment risk:

- credit risk, relating to the uncertainty associated with the continued ability of a given issuer to make timely payments of principal and interest; and
- interest rate risk, relating to the market price and cash flow variability associated with changes in market interest rates.

We manage credit risk by analyzing issuers, transaction structures and real estate properties. We use sophisticated analytic techniques to monitor credit risk. For example, we continually measure the probability of credit default and estimated loss in the event of such a default, which provides us with early notification of worsening credits. If an issuer downgrade causes our holdings of that issuer to exceed our risk thresholds, we automatically undertake a detailed review of the issuer's credit. We also manage credit risk through industry and issuer diversification and asset allocation practices. For commercial real estate loans, we manage credit risk through geographic, property type and product type diversification and asset allocation. We routinely review different issuers and sectors and conduct more formal quarterly portfolio reviews with our Investment Committee.

We mitigate interest rate risk through rigorous management of the relationship between the duration of our assets and the duration of our liabilities, seeking to minimize risk of loss in both rising and falling interest rate environments. For further information on our management of interest rate risk, see "Management's Discussion and Analysis of Financial Condition and Results of Operations—Quantitative and Qualitative Disclosures About Market Risk."

The tables below present our investment positions and results on an historical and a pro forma basis. The pro forma data in these tables give effect to the reinsurance transactions with UFLIC described under "Arrangements Between GE and Our Company—Reinsurance Transactions." The actual investment assets that will be transferred in the reinsurance transactions have been determined on an asset-by-asset basis and the pro forma financial position adjustments have been determined based upon the actual assets that will be transferred. Because a significant portion of the assets to be transferred were not owned for the entire period, the pro forma earnings adjustments were based upon a proportional allocation of investment income from the investment assets historically identified as supporting the blocks reinsured. Under our existing investment management strategies, multiple product lines with similar characteristics can be supported by a single portfolio of investment securities, known as "multiple product portfolios." Where the reinsurance transactions with UFLIC relate to products supported by multiple product portfolios, the pro forma net investment income and net realized investment gains (losses) attributable to the reinsured liabilities were determined using an allocation approach, applying the ratio of reinsured liabilities to the total liabilities supported by the multiple product portfolio to the portfolio's net investment income and net realized investment gains (losses), respectively. As a result, the pro forma information does not represent the results we would have achieved had those reinsurance transactions been consummated at the beginning of the periods presented, and the information presented may not be a reliable indicator of our future results.

The following table sets forth, on an historical and pro forma basis, our cash and invested assets as of the dates indicated:

	Historical				Pro forma	
	December 31,					
	2003		2002		2003	
	Carrying value	% of total	Carrying value	% of total	Carrying value	% of total
<b>(Dollar amounts in millions)</b>						
Fixed-maturities, available-for-sale						
Public	\$ 51,336	64%	\$ 48,964	67%	\$ 36,852	60%
Private	14,149	18%	11,833	16%	10,590	17%
Mortgage loans	6,114	8%	5,302	7%	5,678	9%
Equity securities and other investments	4,389	5%	4,165	6%	3,971	7%
Policy loans	1,105	1%	983	1%	1,096	2%
Restricted investments held by securitization entities	1,069	1%	—	0%	1,069	2%
Cash, cash equivalents and short-term investments	2,513	3%	2,402	3%	2,034	3%
<b>Total cash and invested assets</b>	<b>\$ 80,675</b>	<b>100%</b>	<b>\$ 73,649</b>	<b>100%</b>	<b>\$ 61,290</b>	<b>100%</b>

182

### Organization

Historically, GEAM has provided investment management services for portions of the investment portfolios of the U.S. and Canadian companies in our Mortgage Insurance segment pursuant to various investment management agreements. Prior to May 2002, we managed the investment portfolios of the U.S. companies in our Protection

and Retirement Income and Investments segments through our subsidiary, General Electric Capital Assurance Company, or GECA, one of our life insurance companies. In May 2002, we and GE determined that it would be mutually beneficial for us to consolidate our investment management operations with GEAM. As a result, in May 2002, we consolidated GECA's investment operations with GEAM, and our U.S. insurance subsidiaries entered into investment management and services agreements with GEAM. GEAM has provided investment management services for our domestic operations' investment portfolios pursuant to these agreements and investment guidelines approved by the boards of directors of our respective companies. This consolidation strengthened GE's existing services to its insurance subsidiaries by centralizing investment management and credit analysis expertise, attracting superior professional talent due to improved career opportunities and establishing common research and trading teams on a unified technology platform. We incurred expenses for investment management and related administrative services provided by GEAM of \$61 million, \$39 million and \$2 million for the years ended December 31, 2003, 2002 and 2001, respectively. GEAM is a registered investment adviser that, prior to the consolidation, provided a full range of investment management services, primarily to the GE Pension Trust, the funding vehicle for GE's defined benefit pension plan, as well as a wide range of affiliated and non-affiliated institutional clients, including certain other GE-affiliated insurance entities.

Prior to the completion of this offering, GEAM managed nearly all the investment operations for the benefit of our insurance subsidiaries and other GE-affiliated insurance companies. After the completion of this offering, we will establish our own investment department with more than 100 individuals, led by our Chief Investment Officer, who will preside over our Investment Committee, which will report to our Board of Directors and the boards of directors of our insurance company subsidiaries. Our investment department will include portfolio management, risk management, finance and accounting functions. Our investment department, under the direction of the Investment Committee, will be responsible for establishing investment policies and strategies, reviewing asset-liability management and performing asset allocation. In addition, we will manage certain asset classes for our domestic insurance operations that are currently managed by GEAM, including commercial mortgage loans, privately placed debt securities and derivatives.

Our agreements with GEAM will, with limited exceptions, be amended in connection with our initial public offering and separation from GE. See "Arrangements Between GE and Our Company—Relationship with GE—Investment Agreements."

Management of investments for our non-U.S. operations will be overseen by the managing director and boards of directors of the applicable non-U.S. legal entities in consultation with our Chief Investment Officer. Substantially all the assets of our European payment protection and mortgage insurance businesses will be managed by GEAML, pursuant to agreements that are substantially similar to our agreements with GEAM in the U.S. The majority of the assets of our Canadian, Australian and New Zealand mortgage insurance businesses will continue to be managed by unaffiliated investment managers located in their respective countries.

### Investment results

The annualized yield on general account cash and invested assets, excluding net realized investment gains (losses), was 5.2% and 5.8% for the years ended December 31, 2003 and 2002, respectively.

The following table sets forth, on an historical and pro forma basis, information about our investment income, net realized investment gains (losses) and ending assets (except for restricted investments held by securitization entities) for components of our investment portfolio as of the dates and for the periods. The table also sets forth, on an historical basis, the yields based upon our average assets for the period presented. We have not presented investment yields on a pro forma basis because we have not prepared information about our average assets, on a pro forma basis for the year ended December 31, 2002, to permit the calculation of investment yields on a comparable basis to the historical yields presented below.

	Historical						Pro forma
	As of and for the years ended December 31,						As of and for the year ended December 31,
	2003		2002		2001		2003
Yield	Amount	Yield	Amount	Yield	Amount	Amount	
<b>(Dollar amounts in millions)</b>							
<b>Fixed maturities—taxable</b>							
Investment income	5.6%	\$ 3,354	6.2%	\$ 3,333	6.9%	\$ 3,232	\$ 2,346
Net realized investment gains (losses)		(25)		152		123	(2)
Total		3,329		3,485		3,355	2,344
Ending assets		62,132		57,490		50,147	44,245
<b>Fixed maturities—non-taxable</b>							
Investment income	3.8%	128	4.7%	158	5.0%	159	127
Net realized investment gains		41		157		22	41
Total		169		315		181	168
Ending assets		3,353		3,307		3,348	3,197
<b>Mortgage and other loans</b>							
Investment income	7.2%	410	7.4%	361	7.8%	348	333
Net realized investment gains (losses)		(1)		13		(10)	(1)
Total		409		374		338	332
Ending assets		6,114		5,302		4,499	5,678
<b>Equity securities</b>							
Investment income	2.8%	27	2.5%	39	2.0%	36	26
Net realized investment gains (losses)		(45)		(169)		(59)	(47)

Total		(18)		(130)		(23)		(21)
Ending assets		600		1,295		1,835		428
<b>Other investments, including policy loans</b>								
Investment income	2.4%	105	3.2%	112	5.3%	141		103
Net realized investment gains		40		51		125		47
Total		145		163		266		150
Ending assets		4,894		3,853		3,044		4,639
<b>Cash, cash equivalents and short-term investments</b>								
Investment income	2.4%	58	2.2%	37	3.1%	34		56
Ending assets		2,513		2,402		985		2,034
<b>Total cash and invested assets</b>								
Investment income before expenses and fees	5.3%	4,082	5.9%	4,040	6.6%	3,950		2,991
Investment expenses and fees		(67)		(61)		(55)		(63)
Net investment income	5.2%	4,015	5.8%	3,979	6.5%	3,895		2,928
Net realized investment gains (losses)		10		204		201		38
Total		\$ 4,025		\$ 4,183		\$ 4,096		\$ 2,966

184

### Fixed maturities

Fixed maturities, including tax-exempt bonds, consist principally of publicly traded and privately placed debt securities, and represented 81% and 83% of total cash and invested assets as of December 31, 2003 and 2002, respectively, and 77% on a pro forma basis as of December 31, 2003.

Based upon estimated fair value, public fixed maturities represented 78% and 81% of total fixed maturities as of December 31, 2003 and 2002, respectively, and 78% of total fixed maturities on a pro forma basis as of December 31, 2003. Private fixed maturities represented 22% and 19% of total fixed maturities as of December 31, 2003 and 2002, respectively, and 22% of total fixed maturities on a pro forma basis as of December 31, 2003. We invest in privately placed fixed maturities in an attempt to enhance the overall value of the portfolio, increase diversification and obtain higher yields than can ordinarily be obtained with comparable public market securities. Generally, private placements provide us with protective covenants, call protection features and, where applicable, a higher level of collateral. However, our private placements are not freely transferable because of restrictions imposed by federal and state securities laws, the terms of the securities, and illiquid trading markets.

The Securities Valuation Office of the NAIC evaluates bond investments of U.S. insurers for regulatory reporting purposes and assigns securities to one of six investment categories called "NAIC designations." The NAIC designations parallel the credit ratings of the Nationally Recognized Statistical Rating Organizations for marketable bonds. NAIC designations 1 and 2 include bonds considered investment grade (rated "Baa3" or higher by Moody's, or rated "BBB-" or higher by S&P) by such rating organizations. NAIC designations 3 through 6 include bonds considered below investment grade (rated "Ba1" or lower by Moody's, or rated "BB+" or lower by S&P).

The following tables present, on an historical and pro forma basis, our public, private and aggregate fixed maturities by NAIC and/or equivalent ratings of the Nationally Recognized Statistical Rating Organizations, as well as the percentage, based upon estimated fair value, that each designation comprises. Our non-U.S. fixed maturities generally are not rated by the NAIC and are shown based upon their equivalent rating of the Nationally Recognized Statistical Rating Organizations. Similarly, certain privately placed fixed maturities that are not rated by the Nationally Recognized Statistical Rating Organizations are shown based upon their NAIC designation. Certain securities, primarily non-U.S. securities, are not rated by the NAIC or the Nationally Recognized Statistical Rating Organizations and are so designated.

Public fixed maturities	Rating agency equivalent designation	Historical						Pro forma		
		December 31, 2003			December 31, 2002			December 31, 2003		
		Amortized cost	Estimated fair value	% of total	Amortized cost	Estimated fair value	% of total	Amortized cost	Estimated fair value	% of total
1	Aaa/Aa/A	\$ 32,095	\$ 33,212	64%	\$ 30,904	\$ 31,899	65%	\$ 24,762	\$ 25,405	69%
2	Baa	13,866	14,778	29%	13,752	14,032	29%	8,693	9,173	25%
3	Ba	1,829	1,896	4%	1,970	1,758	4%	1,306	1,371	4%
4	B	1,023	979	2%	839	681	1%	623	610	2%
5	Caa and lower	295	272	1%	370	255	1%	165	152	0%
6	In or near default	96	104	0%	158	129	0%	43	46	0%
Not rated		92	95	0%	170	210	0%	93	95	0%
Total public fixed maturities		\$ 49,296	\$ 51,336	100%	\$ 48,163	\$ 48,964	100%	\$ 35,685	\$ 36,852	100%

(Dollar amounts in millions)

185

		Historical						Pro forma		
		December 31,						December 31,		
Private fixed maturities		2003			2002			2003		
NAIC Rating	Rating agency equivalent designation	Amortized cost	Estimated fair value	% of total	Amortized cost	Estimated fair value	% of total	Amortized cost	Estimated fair value	% of total
(Dollar amounts in millions)										
1	Aaa/Aa/A	\$ 7,029	\$ 7,388	52%	\$ 5,845	\$ 6,208	53%	\$ 5,047	\$ 5,257	50%
2	Baa	5,182	5,442	38%	4,194	4,412	37%	4,099	4,268	40%
3	Ba	691	728	5%	626	636	5%	556	584	6%
4	B	234	228	2%	124	108	1%	204	199	2%
5	Caa and lower	192	177	1%	132	97	1%	152	141	1%
6	In or near default	93	86	1%	60	52	0%	54	47	0%
	Not rated	99	100	1%	317	320	3%	93	94	1%
Total private fixed maturities		\$ 13,520	\$ 14,149	100%	\$ 11,298	\$ 11,833	100%	\$ 10,205	\$ 10,590	100%

		Historical						Pro forma		
		December 31,						December 31,		
Total fixed maturities		2003			2002			2003		
NAIC rating	Rating agency equivalent designation	Amortized cost	Estimated fair value	% of total	Amortized cost	Estimated fair value	% of total	Amortized cost	Estimated fair value	% of total
(Dollar amounts in millions)										
1	Aaa/Aa/A	\$ 39,124	\$ 40,600	62%	\$ 36,749	\$ 38,107	63%	\$ 29,809	\$ 30,662	65%
2	Baa	19,048	20,220	31%	17,946	18,444	30%	12,792	13,441	28%
3	Ba	2,520	2,624	4%	2,596	2,394	4%	1,862	1,955	4%
4	B	1,257	1,207	2%	963	789	1%	827	809	2%
5	Caa and lower	487	449	1%	502	352	1%	317	293	1%
6	In or near default	189	190	0%	218	181	0%	97	93	0%
	Not rated	191	195	0%	487	530	1%	186	189	0%
Total fixed maturities		\$ 62,816	\$ 65,485	100%	\$ 59,461	\$ 60,797	100%	\$ 45,890	\$ 47,442	100%

The following table sets forth, on an historical and pro forma basis, the amortized cost and estimated fair value of fixed maturities by contractual maturity dates (excluding scheduled sinking funds) as of the dates indicated:

		Historical				Pro forma	
		December 31,				December 31,	
		2003		2002		2003	
Maturity		Amortized cost	Estimated fair value	Amortized cost	Estimated fair value	Amortized cost	Estimated fair value
(Dollar amounts in millions)							
Due in one year or less		\$ 1,747	\$ 1,761	\$ 567	\$ 562	\$ 1,690	\$ 1,702
Due after one year through five years		11,400	11,817	10,080	10,189	10,443	10,826
Due after five years through ten years		13,318	13,901	11,135	11,423	10,803	11,239
Due after ten years		24,288	25,756	25,784	26,354	12,915	13,458
Subtotal		50,753	53,235	47,566	48,528	35,851	37,225
Mortgage-backed and asset-backed		12,063	12,250	11,895	12,269	10,039	10,217
Total fixed maturities		\$ 62,816	\$ 65,485	\$ 59,461	\$ 60,797	\$ 45,890	\$ 47,442

We diversify our fixed maturities by security sector. The following table sets forth, on an historical and pro forma basis, the estimated fair value of our fixed maturities by sector, as well as the percentage of the total fixed maturities holdings that each security sector comprised as of the dates indicated:

Security Sector	Historical				Pro forma	
	December 31,				December 31,	
	2003		2002		2003	
	Estimated fair value	% of total	Estimated fair value	% of total	Estimated fair value	% of total
<b>(Dollar amounts in millions)</b>						
U.S. government and agencies	\$ 1,055	2%	\$ 1,167	2%	\$ 666	1%
State and municipal	3,350	5%	3,307	5%	3,196	7%
Government—Non-U.S.	1,551	2%	1,001	2%	1,457	3%
U.S. corporate	33,025	50%	31,027	51%	21,761	46%
Corporate—Non-U.S.	7,949	12%	5,247	9%	6,053	13%
Mortgage-backed	7,848	12%	8,293	14%	6,435	13%
Asset-backed	4,404	7%	3,976	6%	3,782	8%
Public utilities	6,303	10%	6,779	11%	4,092	9%
<b>Total fixed maturities</b>	<b>\$ 65,485</b>	<b>100%</b>	<b>\$ 60,797</b>	<b>100%</b>	<b>\$ 47,442</b>	<b>100%</b>

The following table sets forth, on an historical and pro forma basis, the major industry types that comprise our corporate bond holdings, based primarily on industry codes established by Lehman Brothers, as well as the percentage of the total corporate bond holdings that each industry comprised as of the dates indicated:

Industry	Historical				Pro forma	
	December 31,				December 31,	
	2003		2002		2003	
	Estimated fair value	% of total	Estimated fair value	% of total	Estimated fair value	% of total
<b>(Dollar amounts in millions)</b>						
Finance and insurance	\$ 13,069	28%	\$ 10,435	24%	\$ 9,507	30%
Utilities and energy	10,345	22%	10,534	24%	7,373	23%
Consumer—non cyclical	6,036	13%	4,822	11%	4,111	13%
Consumer—cyclical	4,356	9%	3,656	9%	2,963	9%
Capital goods	2,928	6%	3,408	8%	1,086	3%
Industrial	3,340	7%	3,307	8%	2,939	9%
Technology and communications	2,972	6%	2,519	6%	1,852	6%
Transportation	1,970	4%	2,251	5%	969	3%
Other	2,258	5%	2,121	5%	1,106	4%
<b>Total</b>	<b>\$ 47,274</b>	<b>100%</b>	<b>\$ 43,053</b>	<b>100%</b>	<b>\$ 31,906</b>	<b>100%</b>

We diversify our corporate bond holdings by industry and issuer. The portfolio does not have significant exposure to any single issuer. As of December 31, 2003, on an historical basis, our combined holdings in the ten issuers to which we had the greatest exposure was \$2,714 million, which was approximately 3% of our total cash and invested assets as of such dates. The exposure to the largest single issuer of corporate bonds we held as of December 31, 2003, on an historical basis, was \$315 million which was approximately 0.4% of our total cash and invested assets as of such date.

We do not have a material unhedged exposure to foreign currency risk in our invested assets. In our non-U.S. insurance operations, both our assets and liabilities are generally denominated in local currencies. Foreign currency denominated securities supporting U.S. dollar liabilities generally are swapped into U.S. dollars using derivative instruments.

#### *Mortgage-backed securities*

The following table sets forth, on an historical and pro forma basis, the types of mortgage-backed securities we held as of the dates indicated:

	Historical				Pro forma	
	December 31,				December 31,	
	2003		2002		2003	
	Estimated fair value	% of total	Estimated fair value	% of total	Estimated fair value	% of total
<b>(Dollar amounts in millions)</b>						
Commercial mortgage-backed securities	\$ 5,348	68%	\$ 5,302	64%	\$ 4,325	67%
Collateralized mortgage obligations	799	10%	1,474	18%	662	10%
Pass-through securities	32	0%	192	2%	32	1%
Sequential pay class bonds	922	12%	763	9%	751	12%
Planned amortization class bonds	265	4%	407	5%	211	3%
Other	481	6%	155	2%	454	7%
<b>Total</b>	<b>\$ 7,847</b>	<b>100%</b>	<b>\$ 8,293</b>	<b>100%</b>	<b>\$ 6,435</b>	<b>100%</b>

We purchase mortgage-backed securities to diversify our portfolio risk characteristics from primarily corporate credit risk to a mix of credit risk and cash flow risk. The principal risks inherent in holding mortgage-backed securities are prepayment and extension risks, which will affect the timing of when cash flow will be received. The majority of the mortgage-backed securities in our investment portfolio have relatively low cash flow variability. We believe our active monitoring and analysis of this portfolio, focus on stable types of securities, and limits on our holdings of more volatile types of securities reduces the effects of interest rate fluctuations on this portfolio.

Commercial mortgage-backed securities, or CMBs, which represent our largest class of mortgage-backed securities, are securities backed by a diversified pool of first mortgage loans on commercial properties ranging in size, property type and geographic location. The primary risk associated with CMBs is default risk. Prepayment risk on CMBs is generally low because of prepayment restrictions contained in the underlying collateral.

The majority of our collateralized mortgage obligations, or CMOs, are guaranteed or otherwise supported by the Federal National Mortgage Association, Federal Home Loan Mortgage Corporation or Government National Mortgage Association. CMOs separate mortgage pools into different maturity classes called tranches, which generally provides for greater cash flow stability than other mortgage-backed securities.

Pass-through securities are the most liquid assets in the mortgage-backed sector. Pass-through securities distribute, on a pro rata basis to their holders, the monthly cash flows of principal and interest, both scheduled and prepayments, generated by the underlying mortgages.

Sequential pay class bonds receive principal payments in a prescribed sequence without a pre-determined prepayment schedule. Planned amortization class bonds are bonds structured to provide more certain cash flows to the investor and therefore are subject to less prepayment and extension risk than other mortgage-backed securities.

*Asset-backed securities*

The following table sets forth, on an historical and pro forma basis, the types of asset-backed securities we held as of the dates indicated:

	Historical				Pro forma	
	December 31,				December 31,	
	2003		2002		2003	
	Estimated fair value	% of total	Estimated fair value	% of total	Estimated fair value	% of total
<b>(Dollar amounts in millions)</b>						
Automobile receivables	\$ 1,425	32%	\$ 1,741	44%	\$ 1,313	35%
Home equity loans	1,043	24%	815	20%	942	25%
Credit card receivables	1,131	26%	918	23%	1,079	28%
Other	804	18%	502	13%	448	12%
<b>Total</b>	<b>\$ 4,403</b>	<b>100%</b>	<b>\$ 3,976</b>	<b>100%</b>	<b>\$ 3,782</b>	<b>100%</b>

We purchase asset-backed securities both to diversify the overall risks of our fixed maturities portfolio and to provide attractive returns. Our asset-backed securities are diversified by type of asset, issuer and servicer. As of December 31, 2003, on an historical and pro forma basis, approximately \$3,488 million and \$2,879 million, respectively, or 79% and 76%, respectively, of the total amount of our asset-backed security investments were rated "Aaa/AAA" by Moody's or S&P.

The principal risks in holding asset-backed securities are structural, credit and capital market risks. Structural risks include the security's priority in the issuer's capital structure, the adequacy of and ability to realize proceeds from the collateral and the potential for prepayments. Credit risks include consumer or corporate credits such as credit card holders, equipment lessees, and corporate obligors. Capital market risks include the general level of interest rates and the liquidity for these securities in the marketplace.

*Mortgage loans*

Our mortgage loans are collateralized by commercial properties, including multifamily residential buildings. The carrying value of mortgage loans is stated at original cost net of prepayments and amortization.

We diversify our commercial mortgage loans by both geographic region and property type. The following table sets forth, on an historical and pro forma basis, the distribution across geographic regions and property types for commercial mortgage loans as of the dates indicated:

	Historical				Pro forma	
	December 31,				December 31,	
	2003		2002		2003	
	Carrying value	% of total	Carrying value	% of total	Carrying value	% of total
<b>(Dollar amounts in millions)</b>						
Office	\$ 2,024	33%	\$ 1,610	30%	\$ 1,923	34%
Industrial	1,812	30%	1,546	29%	1,685	30%
Retail	1,500	25%	1,476	28%	1,366	24%
Apartments	573	9%	520	10%	529	9%
Mixed use/other	205	3%	150	3%	175	3%
<b>Total</b>	<b>\$ 6,114</b>	<b>100%</b>	<b>\$ 5,302</b>	<b>100%</b>	<b>\$ 5,678</b>	<b>100%</b>

Region							
Pacific	\$	1,867	31%	\$	1,606	30%	\$ 1,746 31%
South Atlantic		1,194	20%		1,174	22%	1,098 19%
Middle Atlantic		932	15%		729	14%	840 15%
East North Central		771	12%		519	10%	730 13%
Mountain		478	8%		454	9%	423 7%
West South Central		288	5%		241	4%	281 5%
West North Central		271	4%		267	5%	259 5%
East South Central		226	4%		222	4%	214 4%
New England		87	1%		90	2%	87 1%
<b>Total</b>	<b>\$</b>	<b>6,114</b>	<b>100%</b>	<b>\$</b>	<b>5,302</b>	<b>100%</b>	<b>\$ 5,678 100%</b>

The following table sets forth, on an historical and pro forma basis, the distribution of our commercial mortgage loans by loan size as of the dates indicated:

	Historical						Pro forma		
	December 31,						December 31,		
	2003			2002			2003		
	Number of loans	Principal balance	% of total	Number of loans	Principal balance	% of total	Number of loans	Principal balance	% of total
<b>(Dollar amounts in millions)</b>									
Under \$5 million	1,627	\$ 3,153	51%	1,693	\$ 3,149	59%	1,521	\$ 2,912	51%
\$5 million but less than \$10 million	207	1,394	23%	183	1,232	23%	194	1,317	23%
\$10 million but less than \$20 million	67	948	15%	53	708	13%	62	869	15%
\$20 million but less than \$30 million	13	309	5%	7	177	3%	11	266	5%
More than \$30 million	8	358	6%	2	80	2%	8	358	6%
<b>Total</b>	<b>1,922</b>	<b>\$ 6,162</b>	<b>100%</b>	<b>1,938</b>	<b>\$ 5,346</b>	<b>100%</b>	<b>1,796</b>	<b>\$ 5,722</b>	<b>100%</b>

The following table sets forth, on an historical and pro forma basis, the scheduled maturities for our commercial mortgage loans as of the dates indicated:

	Historical						Pro forma	
	December 31,						December 31,	
	2003		2002		2003			
	Carrying value	% of total	Carrying value	% of total	Carrying value	% of total		
<b>(Dollar amounts in millions)</b>								
Due in 1 year or less	\$ 68	1%	\$ 72	1%	\$ 68	1%		
Due after 1 year through 2 years	60	1%	99	2%	60	1%		
Due after 2 year through 3 years	122	2%	81	2%	122	2%		
Due after 3 year through 4 years	64	1%	126	2%	64	1%		
Due after 4 year through 5 years	389	6%	79	2%	389	7%		
Due after 5 years	5,411	89%	4,845	91%	4,975	88%		
<b>Total</b>	<b>\$ 6,114</b>	<b>100%</b>	<b>\$ 5,302</b>	<b>100%</b>	<b>\$ 5,678</b>	<b>100%</b>		

We monitor our mortgage loans on a continual basis. These reviews include an analysis of the property, its financial statements, the relevant market and tenant creditworthiness. Through this monitoring process, we review loans that are restructured, delinquent or under foreclosure and identify those that management considers to be potentially delinquent.

The following table sets forth, on an historical and pro forma basis, the changes in allowance for losses on mortgage loans as of the dates indicated:

	Historical	Pro forma
--	------------	-----------

	As of or for the years ended December 31,			As of or for the years ended December 31,
	2003	2002	2001	2003
<b>(Dollar amounts in millions)</b>				
Balance, beginning of period	\$ 45	\$ 58	\$ 47	\$ 42
Additions	8	10	9	8
Deductions for writedowns and dispositions	(3)	(23)	2	(3)
Balance, end of period	\$ 50	\$ 45	\$ 58	\$ 47

### Equity securities and other investments

The following table sets forth, on an historical and pro forma basis, the carrying values of our investments in equity securities and other investments as of the dates indicated:

	Historical				Pro forma	
	December 31,				December 31,	
	2003		2002		2003	
	Carrying value	% of total	Carrying value	% of total	Carrying value	% of total
<b>(Dollar amounts in millions)</b>						
Equity securities	\$ 600	14%	\$ 1,295	31%	\$ 428	11%
Securities lending	3,026	68%	2,195	53%	3,026	76%
Limited partnerships	253	6%	202	5%	178	4%
Real estate	120	3%	127	3%	1	0%
Other investments	390	9%	346	8%	338	9%
Total	\$ 4,389	100%	\$ 4,165	100%	\$ 3,971	100%

Our equity securities primarily consist of investments in publicly traded common stocks and some preferred stock of U.S. and non-U.S. companies. We also participate in a securities lending program, whereby blocks of securities included in our investments are loaned primarily to major brokerage firms. We require a minimum of 102% of the fair value of the loaned securities to be separately maintained as collateral for the loans. The limited partnerships primarily represent interests in pooled investment funds that make private equity investments in U.S. and non-U.S. companies. We classify our investments in common stocks as available-for-sale. Real estate consists of ownership of real property, primarily commercial property. Other investments are primarily amounts on deposit with foreign governments, options and strategic equity investments.

### Derivative financial instruments

We use derivative financial instruments, such as interest rate and currency swaps, currency forwards and option-based financial instruments, as part of our risk management strategy. We use these derivatives to mitigate interest rate and currency risk by:

- reducing the risk between the timing of the receipt of cash and its investment in the market;
- matching the currency of invested assets with the liabilities they support;
- converting the asset duration to match the duration of the liabilities; and
- protecting against the early termination of an asset or liability.

191

As a matter of policy, we have not and will not engage in derivative market-making, speculative derivative trading or other speculative derivatives activities.

The following table sets forth, on an historical and pro forma basis, our positions in derivative financial instruments, other than equity options, as of the dates indicated:

	Historical				Pro forma	
	December 31,				December 31,	
	2003		2002		2003	
	Notional value	% of total	Notional value	% of total	Notional value	% of total
<b>(Dollar amounts in millions)</b>						
Interest rate swaps	\$ 9,960	90%	\$ 9,233	90%	\$ 7,786	92%
Foreign currency swaps	697	6%	225	2%	514	6%
Swaptions	474	4%	814	8%	193	2%
Foreign exchange contracts	30	0%	30	0%	30	0%



Total	\$	11,161	100%	\$	10,302	100%	\$	8,523	100%
-------	----	--------	------	----	--------	------	----	-------	------

## Employees

As of December 31, 2003, we had approximately 5,850 full-time and 100 part-time employees. We believe our employee relations are satisfactory. To the best of our knowledge, none of our employees are subject to collective bargaining agreements. Some of our employees in Europe may be members of trade unions, but local data privacy laws prohibit us from asking them about their membership in trade unions, and they are not required to inform us.

## Facilities

We own our headquarters facility in Richmond, Virginia, which consists of approximately 461,000 square feet in four buildings, as well as several facilities with approximately 462,000 square feet in Lynchburg, Virginia. In addition, we lease approximately 1,348,000 square feet of office space in 98 locations throughout the U.S. We also own one building outside the U.S., with approximately 2,600 square feet, and we lease approximately 421,000 square feet in various locations outside the U.S.

Most of our leases in the U.S. and other countries have lease terms of three to five years, although some leases have terms of up to eight years. Our aggregate annual rental expense under all these leases was \$30 million during the year ended December 31, 2003.

We believe our properties are adequate for our business as presently conducted.

## Legal Proceedings

We are subject to legal and regulatory actions in the ordinary course of our businesses, including class actions. Our pending legal and regulatory actions include proceedings specific to us and others generally applicable to business practices in the industries in which we operate. In our insurance operations, we are or may become subject to class actions and individual suits alleging, among other things, issues relating to sales or underwriting practices, claims payment and procedures, product design, disclosure, administration, additional premium charges for premiums paid on a periodic basis, denial or delay of benefits and breaches of fiduciary duties to customers. In our investment-related operations, we are or may become subject to litigation involving commercial disputes with counterparties or others and class action and other litigation alleging, among other things, that we made improper or inadequate disclosures in connection with the sale of assets and annuity and investment products or charged excessive or impermissible fees on these products, recommended unsuitable products to customers or breached fiduciary or other duties to customers. We are also subject to litigation arising out of our general business activities such as our contractual and

employment relationships. Further, state insurance regulatory authorities and other authorities regularly make inquiries and conduct investigations concerning our compliance with applicable insurance, investment and other laws and regulations.

Plaintiffs in class action and other lawsuits against us may seek very large or indeterminate amounts, including punitive and treble damages. Given the large or indeterminate amounts sought in certain of these matters and the inherent unpredictability of litigation, it is possible that an adverse outcome in certain matters in addition to those described below could have a material adverse effect on our financial condition or results of operations.

One of our insurance subsidiaries is named as a defendant in a lawsuit, *McBride v. Life Insurance Co. of Virginia dba GE Life and Annuity Assurance Co.*, related to the sale of universal life insurance policies. The complaint was filed on November 1, 2000, in Georgia state court as a class action on behalf of all persons who purchased certain universal life insurance policies from that subsidiary and alleges improper practices in connection with the sale and administration of universal life policies. The plaintiffs sought unspecified compensatory and punitive damages. On December 1, 2000, we removed the case to the U.S. District Court for the Middle District of Georgia. No class has been certified. We have vigorously denied liability with respect to the plaintiff's allegations. Nevertheless, to avoid the risks and costs associated with protracted litigation and to resolve our differences with policyholders, we agreed in principle on October 8, 2003 to settle the case on a nationwide class action basis with respect to the insurance subsidiary named in the lawsuit. The settlement provides benefits to the class, and allows us to continue to serve our customers' needs undistracted by disruptions caused by litigation. The settlement documents have not been finalized, nor has any proposed settlement been submitted to the proposed class or for court approval, and a final settlement is not certain. In the third quarter of 2003, we accrued \$50 million in reserves relating to this litigation, which represents our best estimate of bringing this matter to conclusion. The precise amount of payments in this matter cannot be estimated because they are dependent upon court approval of the class and related settlement, the number of individuals who ultimately will seek relief in the claim form process of any approved class settlement, the identity of such claimants and whether they are entitled to relief under the settlement terms and the nature of the relief to which they are entitled.

One of our mortgage insurance subsidiaries is named as a defendant in two lawsuits filed in the U.S. District Court for the Northern District of Illinois, *William Portis et al. v. GE Mortgage Insurance Corp.* and *Karwo v. Citimortgage, Inc. and General Electric Mortgage Insurance Corporation*. The *Portis* complaint was filed on January 15, 2004, and the *Karwo* complaint was filed on March 15, 2004. Each action seeks certification of a nationwide class of consumers who allegedly were required to pay for our private mortgage insurance at a rate higher than our "best available rate," based upon credit information we obtained. Each action alleges that the FCRA requires an "adverse action" notice to such borrowers and that we violated the FCRA by failing to give such notice. The plaintiffs in *Portis* allege in the complaint that they are entitled to "actual damages" and "damages within the Court's discretion of not more than \$1,000 for each separate violation" of the FCRA. The plaintiffs in *Karwo* allege that they are entitled to "appropriate actual, punitive and statutory damages" and "such other or further relief as the Court deems proper." Similar cases are pending against six other mortgage insurers. We intend to vigorously defend against these actions, but we cannot predict their outcome.

We agreed to an injunction as part of a September 2002 settlement of a putative class action, *Douglas v. General Electric Mortgage Insurance Corporation, dba General Electric Capital Mortgage Insurance*, and General Electric Mortgage Insurance Corporation of North Carolina, dba General Electric Capital Mortgage Insurance, alleging that we violated RESPA by providing items of value to induce lenders to refer mortgage insurance business to it. The complaint was filed on December 15, 2000, in the United States District Court for the Southern District of Georgia. Pursuant to the settlement, we paid \$9 million in damages and other costs of settlement. The injunction, which expired on December 31, 2003, provides that so long as certain products and services challenged in the lawsuit,

including contract underwriting, captive reinsurance arrangements and certain other products and services, meet the minimum requirements for risk transfer and cost recovery specified in the injunction, they will be deemed to be in compliance with RESPA, thus barring lawsuits by class members for any mortgage insurance-related claim in connection with any loan transaction closed on or before December 31, 2003. The class members gave a general release to our mortgage insurance subsidiary, lenders and the GSEs for all claims on insurance commitments issued December 17, 1997 through December 31, 2003, including claims under RESPA and related state law claims. In accordance with the terms of the injunction, we provide contract underwriting services pursuant to written agreements with lenders at fees that cover our marginal costs of providing these services.

It is not clear whether the expiration of the injunction will lead to new litigation under RESPA and related state law against mortgage insurers, including us. Any future claims made against us could allege either that we violated the terms of the injunction or that our pricing structures and business practices violate RESPA after the expiration of the injunction. We cannot predict whether any change in our pricing structure or business practices, whether in response to any changes by our competitors in their pricing structure or business practices or otherwise, or whether any services we or they may provide to mortgage lenders, could be found to violate RESPA or any future injunction that might be issued.

We also are involved in an arbitration regarding our delegated underwriting practices. A mortgage lender that underwrote loan applications for mortgage insurance under our delegated underwriting program commenced an arbitration against us after we rescinded policy coverage for a number of mortgage loans underwritten by that lender. We rescinded coverage because we believe those loans were not underwritten in compliance with applicable program standards and underwriting guidelines. However, the lender claims that we improperly rescinded coverage. We believe our maximum exposure in the arbitration, based upon the risk in force on the rescinded coverage on loans that are delinquent, is approximately \$20 million. However, this exposure may increase in the event additional rescinded policies are included in the arbitration. The arbitration currently is in the discovery phase. We believe we had valid reasons to rescind coverage on the disputed loans and therefore believe we have meritorious defenses in the arbitration. We intend to contest vigorously all the claims in this arbitration.

## Regulation

Our businesses are subject to extensive regulation and supervision.

### General

Our insurance operations are subject to a wide variety of laws and regulations. State insurance laws regulate most aspects of our U.S. insurance businesses, and our insurance subsidiaries are regulated by the insurance departments of the states in which they are domiciled and licensed. Our non-U.S. insurance operations are principally regulated by insurance regulatory authorities in the jurisdictions in which they are domiciled. Our insurance products and thus our businesses also are affected by U.S. federal, state and local tax laws, and the tax laws of non-U.S. jurisdictions. Insurance products that constitute "securities," such as variable annuities and variable life insurance, also are subject to U.S. federal and state and non-U.S. securities laws and regulations. The Securities and Exchange Commission, or SEC, the National Association of Securities Dealers, or NASD, state securities authorities and non-U.S. authorities regulate and supervise these products.

Our securities operations are subject to U.S. federal and state and non-U.S. securities and related laws. The SEC, state securities authorities, the NASD and similar non-U.S. authorities are the principal regulators of these operations.

The purpose of the laws and regulations affecting our insurance and securities businesses is primarily to protect our customers and not our stockholders. Many of the laws and regulations to which we are subject are regularly re-examined, and existing or future laws and regulations may become more restrictive or otherwise adversely affect our operations.

In addition, insurance and securities regulatory authorities (including state law enforcement agencies and attorneys general or their non-U.S. equivalents) from time to time make inquiries regarding compliance by us and our subsidiaries with insurance, securities and other laws and regulations regarding the conduct of our insurance and securities businesses. We cooperate with such inquiries and take corrective action when warranted.

### U.S. Insurance Regulation

Our U.S. insurance subsidiaries are licensed and regulated in all jurisdictions in which they conduct insurance business. The extent of this regulation varies, but most jurisdictions have laws and regulations governing the financial condition of insurers, including standards of solvency, types and concentration of investments, establishment and maintenance of reserves, credit for reinsurance and requirements of capital adequacy, and the business conduct of insurers, including marketing and sales practices and claims handling. In addition, statutes and regulations usually require the licensing of insurers and their agents, the approval of policy forms and related materials and the approval of rates for certain lines of insurance.

The types of U.S. insurance laws and regulations applicable to us or our U.S. insurance subsidiaries are described below. Our U.S. mortgage insurance subsidiaries are subject to additional insurance laws and regulations applicable specifically to mortgage insurers discussed below under "—Mortgage Insurance."

#### *Insurance holding company regulation*

All U.S. jurisdictions in which our U.S. insurance subsidiaries conduct insurance business have enacted legislation that requires each U.S. insurance company in a holding company system, except captive insurance companies, to register with the insurance regulatory authority of its jurisdiction of domicile and to furnish that regulatory authority financial and other information concerning the operations of, and the interrelationships and transactions among, companies within its holding company system that may materially affect the operations, management or financial condition of the insurers

within the system. These laws and regulations also regulate transactions between insurance companies and their parents and affiliates. Generally, these laws and regulations require that all transactions within a holding company system between an insurer and its affiliates be fair and reasonable and that the insurer's statutory surplus following any transaction with an affiliate be both reasonable in relation to its outstanding liabilities and adequate to its needs. Statutory surplus is the excess of admitted assets over the sum of statutory liabilities and capital. For certain types of agreements and transactions between an insurer and its affiliates, these laws and regulations require prior notification to, and non-disapproval or approval by, the insurance regulatory authority of the insurer's jurisdiction of domicile.

#### *Policy forms*

Our U.S. insurance subsidiaries' policy forms are subject to regulation in every U.S. jurisdiction in which they are licensed to transact insurance business. In most U.S. jurisdictions, policy forms must be filed prior to their use. In some U.S. jurisdictions, forms must also be approved prior to use.

#### *Dividend limitations*

As a holding company with no significant business operations of our own, we will depend on dividends or other distributions from our subsidiaries as the principal source of cash to meet our obligations, including the payment of interest on, and repayment of, principal of any debt obligations. The payment of dividends or other distributions to us by our U.S. insurance subsidiaries is regulated by the insurance laws and regulations of their respective states of domicile. In general, these subsidiaries may not pay an "extraordinary" dividend or distribution until 30 days after the applicable insurance regulator has received notice of the intended payment and has not objected in such period or has approved the payment within the 30-day period. In general, an "extraordinary" dividend or distribution is defined by these laws and regulations as a dividend or distribution

that, together with other dividends and distributions made within the preceding 12 months exceeds the greater (and, in some jurisdictions, the lesser) of:

- 10% of the insurer's statutory surplus as of the immediately prior year end; or
- the statutory net gain from the insurer's operations (if a life insurer) or the statutory net income (if not a life insurer) during the prior calendar year.

The laws and regulations of some of these jurisdictions also prohibit an insurer from declaring or paying a dividend except out of its earned surplus or require the insurer to obtain regulatory approval before it may do so.

#### ***Market conduct regulation***

The laws and regulations of U.S. jurisdictions include numerous provisions governing the marketplace activities of insurers, including provisions governing the form and content of disclosure to consumers, product illustrations, advertising, product replacement, sales and underwriting practices, complaint handling and claims handling. The regulatory authorities in U.S. jurisdictions generally enforce these provisions through periodic market conduct examinations.

#### ***Statutory examinations***

As part of their regulatory oversight process, insurance departments in U.S. jurisdictions conduct periodic detailed examinations of the books, records, accounts and business practices of insurers domiciled in their jurisdiction. These examinations generally are conducted in cooperation with the insurance departments of two or three other states or jurisdictions, representing each of the NAIC zones, under guidelines promulgated by the NAIC.

196

---

In the three-year period ended December 31, 2003, we have not received any material adverse findings resulting from any insurance department examinations of our U.S. insurance subsidiaries.

#### ***Guaranty associations and similar arrangements***

Most of the jurisdictions in which our U.S. insurance subsidiaries are licensed to transact business require life insurers doing business within the jurisdiction to participate in guaranty associations, which are organized to pay contractual benefits owed pursuant to insurance policies of insurers who become impaired or insolvent. These associations levy assessments, up to prescribed limits, on all member insurers in a particular jurisdiction on the basis of the proportionate share of the premiums written by member insurers in the lines of business in which the impaired, insolvent or failed insurer is engaged. Some jurisdictions permit member insurers to recover assessments paid through full or partial premium tax offsets.

Aggregate assessments levied against our U.S. subsidiaries totaled \$0.2 million, \$0.2 million and \$0.5 million for the years ended December 31, 2003, 2002 and 2001, respectively. Although the amount and timing of future assessments are not predictable, we have established liabilities for guaranty fund assessments that we consider adequate for assessments with respect to insurers that currently are subject to insolvency proceedings.

#### ***Change of control***

The laws and regulations of the jurisdictions in which our U.S. insurance subsidiaries are domiciled require that a person obtain the approval of the insurance commissioner of the insurance company's jurisdiction of domicile prior to acquiring control of the insurer. Generally, statutes provide that control over an insurer is presumed to exist if any person, directly or indirectly, owns, controls, holds with the power to vote, or holds proxies representing, 10% or more of the voting securities of the insurer. In considering an application to acquire control of an insurer, the insurance commissioner generally will consider such factors as experience, competence, the financial strength of the applicant, the integrity of the applicant's board of directors and executive officers, the acquirer's plans for the management and operation of the insurer, and any anti-competitive results that may arise from the acquisition. In addition, a person seeking to acquire control of an insurance company is required in some states to make filings prior to completing an acquisition if the acquirer and the target insurance company and their affiliates have sufficiently large market shares in particular lines of insurance in those states. Approval of an acquisition is not required in these states, but the state insurance departments could take action to impose conditions on an acquisition that could delay or prevent its consummation. These laws may discourage potential acquisition proposals and may delay, deter or prevent a change of control involving us, including through transactions, and in particular unsolicited transactions, that some or all of our stockholders might consider to be desirable.

#### ***Policy and contract reserve sufficiency analysis***

Under the laws and regulations of their jurisdictions of domicile, our U.S. life insurance subsidiaries are required to conduct annual analyses of the sufficiency of their life and health insurance and annuity statutory reserves. In addition, other jurisdictions in which these subsidiaries are licensed may have certain reserve requirements that differ from those of their domiciliary jurisdictions. In each case, a qualified actuary must submit an opinion that states that the aggregate statutory reserves, when considered in light of the assets held with respect to such reserves, make good and sufficient provision for the associated contractual obligations and related expenses of the insurer. If such an opinion cannot be provided, the affected insurer must set up additional reserves by moving funds from surplus. Our U.S. life insurance subsidiaries most recently submitted these opinions without qualification as of December 31, 2003 to applicable insurance regulatory authorities. Different reserve requirements exist for our U.S. mortgage insurance subsidiaries. See "—Reserves—Mortgage Insurance."

197

---

#### ***Surplus and capital requirements***

Insurance regulators have the discretionary authority, in connection with the ongoing licensing of our U.S. insurance subsidiaries, to limit or prohibit the ability of an insurer to issue new policies if, in the regulators' judgment, the insurer is not maintaining a minimum amount of surplus or is in hazardous financial condition. Insurance regulators may also limit the ability of an insurer to issue new life insurance policies and annuity contracts above an amount based upon the face amount and premiums of policies of a similar type issued in the prior year. We do not believe that the current or anticipated levels of statutory surplus of our U.S. insurance subsidiaries present a material risk that any such regulator would limit the amount of new policies that our U.S. insurance subsidiaries may issue.

#### ***Risk-based capital***

The NAIC has established risk-based capital standards for U.S. life insurance companies as well as a model act with the intention that these standards be applied at the state level. The model act provides that life insurance companies must submit an annual risk-based capital report to state regulators reporting their risk-based capital based upon four categories of risk: asset risk, insurance risk, interest rate risk and business risk. For each category, the capital requirement is determined by applying factors to various asset, premium and reserve items, with the factor being higher for those items with greater underlying risk and lower for less risky items. The formula is intended to be used by

insurance regulators as an early warning tool to identify possible weakly capitalized companies for purposes of initiating further regulatory action.

If an insurer's risk-based capital falls below specified levels, the insurer would be subject to different degrees of regulatory action depending upon the level. These actions range from requiring the insurer to propose actions to correct the capital deficiency to placing the insurer under regulatory control. As of December 31, 2003, the risk-based capital of each of our U.S. life insurance subsidiaries exceeded the level of risk-based capital that would require any of them to take any corrective action.

#### ***Statutory accounting principles***

Statutory accounting principles, or SAP, is a basis of accounting developed by U.S. insurance regulators to monitor and regulate the solvency of insurance companies. In developing SAP, insurance regulators were primarily concerned with assuring an insurer's ability to pay all its current and future obligations to policyholders. As a result, statutory accounting focuses on conservatively valuing the assets and liabilities of insurers, generally in accordance with standards specified by the insurer's domiciliary jurisdiction. Uniform statutory accounting practices are established by the NAIC and generally adopted by regulators in the various U.S. jurisdictions. These accounting principles and related regulations determine, among other things, the amounts our insurance subsidiaries may pay to us as dividends.

U.S. GAAP is designed to measure a business on a going-concern basis. It gives consideration to matching of revenue and expenses and, as a result, certain expenses are capitalized when incurred and then amortized over the life of the associated policies. The valuation of assets and liabilities under U.S. GAAP is based in part upon best estimate assumptions made by the insurer. Stockholder's equity represents both amounts currently available and amounts expected to emerge over the life of the business. As a result, the values for assets, liabilities and equity reflected in financial statements prepared in accordance with U.S. GAAP may be different from those reflected in financial statements prepared under SAP.

#### ***Regulation of investments***

Each of our U.S. insurance subsidiaries is subject to laws and regulations that require diversification of its investment portfolio and limit the amount of investments in certain asset categories, such as below investment grade fixed income securities, equity real estate, other equity

198

---

investments and derivatives. Failure to comply with these laws and regulations would cause investments exceeding regulatory limitations to be treated as non-admitted assets for purposes of measuring surplus, and, in some instances, would require divestiture of such non-complying investments. We believe the investments made by our U.S. insurance subsidiaries comply with these laws and regulations.

#### ***Federal regulation***

Our variable life insurance and variable annuity products generally are "securities" within the meaning of federal and state securities laws. As a result, they are registered under the Securities Act of 1933 and are subject to regulation by the SEC, the NASD and state securities authorities. Federal and state securities regulation similar to that discussed below under "—Securities Regulation" affect investment advice and sales and related activities with respect to these products. In addition, although the federal government does not comprehensively regulate the business of insurance, federal legislation and administrative policies in several other areas, including taxation, financial services regulation and pension and welfare benefits regulation, can also significantly affect the insurance industry.

#### ***Federal initiatives***

Although the federal government generally does not directly regulate the insurance business, federal initiatives often and increasingly have an impact on the business in a variety of ways. From time to time, federal measures are proposed which may significantly affect the insurance business, including limitations on antitrust immunity, the creation of more flexible tax-advantaged or tax-exempt savings accounts with higher contribution limits, and the replacement of certain traditional retirement annuities with a more general employer retirement savings account. In addition, a bill, "The Federal Insurance Consumer Protection Act of 2003" (S.1373), has been introduced in the U.S. Senate which, if enacted, would establish comprehensive and exclusive federal regulation over all "interstate insurers," including all life insurers selling in more than one state, with no option for such insurers to remain regulated by the states. This legislation would repeal the McCarran-Ferguson antitrust exemption for the business of insurance. It would also establish a Federal Insurance Regulatory Commission within the Department of Commerce that would have exclusive regulatory jurisdiction over life and property and casualty insurers that do business in more than one U.S. jurisdiction. The legislation would establish comprehensive federal regulatory oversight over such insurers, including licensing, solvency supervision, accounting and auditing practices, form and rate approval, and market conduct examination. In particular, the legislation would provide for price regulation of life insurance products, which is not now a feature of state regulation of life insurance and could affect the profitability of this business. The legislation also would establish a National Insurance Guaranty Fund which may be empowered to collect pre-funded assessments that are different from, and potentially greater than, current state guaranty fund assessment levels. We cannot predict whether these or other proposals will be adopted, or what impact, if any, such proposals may have on our business, financial condition or results of operation.

#### ***Legislative developments***

On June 7, 2001, President George Bush signed into law the Economic Growth and Taxpayer Relief Reconciliation Act, which includes the repeal of the federal estate tax over a ten-year period. We believe that the repeal of the federal estate tax has resulted in reduced sales, and could continue to affect sales, of some of our estate planning products, including survivorship/second-to-die life insurance policies. We do not expect the repeal of the federal estate tax to have a material adverse impact on our overall business, however.

On May 28, 2003, President Bush signed into law the Jobs and Growth Tax Relief Reconciliation Act, which reduces federal income tax rates that investors are required to pay on capital gains and on certain dividends paid on stock. This reduction may provide an incentive for certain of our customers

199

---

and potential customers to shift assets into mutual funds and away from our products, including annuities, designed to defer taxes payable on investment returns.

We cannot predict what other proposals may be made, what legislation may be introduced or enacted or the impact of any such legislation on our business, results of operations and financial condition.

### **U.K. Insurance Regulation**

#### ***General***

Insurance and reinsurance businesses in the U.K. are subject to close regulation by the Financial Services Authority, or FSA. We have U.K. subsidiaries that have received

authorization from the FSA to effect and carry out contracts of insurance in the U.K. An authorized insurer in the U.K. is able to operate throughout the European Union, subject to certain regulatory requirements of the FSA and in some cases, certain local regulatory requirements. Certain of our U.K. subsidiaries operate in other member states of the European Union through the establishment of branch offices.

### ***Supervision***

The FSA has adopted a risk-based approach to the supervision of insurance companies. Under this approach the FSA periodically performs a formal risk assessment of insurance companies or groups carrying on business in the U.K. After each risk assessment, the FSA will inform the insurer of its views on the insurer's risk profile. This will include details of any remedial action that the FSA requires and the likely consequences if this action is not taken.

The FSA also supervises the management of insurance companies through the approved persons regime, by which any appointment of persons to perform certain specified "controlled functions" within a regulated entity, must be approved by the FSA.

### ***Solvency requirements***

Under FSA rules, insurance companies must maintain a margin of solvency at all times, the calculation of which in any particular case depends on the type and amount of insurance business a company writes. Failure to maintain the required solvency margin is one of the grounds on which wide powers of intervention conferred upon the FSA may be exercised. In addition, an insurer (other than a pure reinsurer) that is part of a group, is required to perform and submit to the FSA a solvency margin calculation return in respect of its ultimate parent company, in accordance with the FSA's rules. Although there is no requirement for the parent company solvency calculation to show a positive result, the FSA is required to take action where it considers that the solvency of the insurance company is or may be jeopardized due to the group solvency position. As of December 31, 2003, the solvency calculation for our group's parent company in the U.K. showed a surplus.

In addition, the FSA has published proposals for the implementation of the European Union's Financial Conglomerates Directive which include a requirement for insurance groups to hold an amount of capital indicated in the calculation of the parent company's solvency margin at the European Economic Area parent level for the financial years beginning in 2005. The purpose of these proposals is to prevent the leveraging of capital by companies involved in multiple insurance groups. The FSA has stated that it will phase in these proposals.

### ***Restrictions on dividend payments***

English company law prohibits our U.K. subsidiaries from declaring a dividend to their shareholders unless they have "profits available for distribution." The determination of whether a company has profits available for distribution is based on its accumulated realized profits less its accumulated realized losses.

200

---

### ***Change of control***

The acquisition of "control" of any U.K. insurance company will require FSA approval. For these purposes, a party that "controls" a U.K. insurance company includes any company or individual that (together with its or his associates) directly or indirectly acquires 10% or more of the shares in a U.K. authorized insurance company or its parent company, or is entitled to exercise or control the exercise of 10% or more of the voting power in such authorized insurance company or its parent company. In considering whether to approve an application for approval, the FSA must be satisfied that both the acquirer is a fit and proper person to have such "control" and that the interests of consumers would not be threatened by such acquisition of "control." Failure to make the relevant prior application could result in action being taken against our U.K. subsidiaries by the FSA. These requirements could delay, deter or prevent the acquisition of control of our U.K. insurance subsidiaries.

### ***Intervention and enforcement***

The FSA has extensive powers to intervene in the affairs of an insurance company or authorized person and has the power, among other things, to enforce, and take disciplinary measures in respect of, breaches of its rules.

## **Mortgage Insurance**

### ***State regulation***

#### ***General***

Mortgage insurers generally are restricted by state insurance laws and regulations to writing mortgage insurance business only. This restriction prohibits our mortgage insurance subsidiaries from directly writing other types of insurance. Mortgage insurers are not subject to the NAIC's risk-based capital requirements, but are subject to other capital requirements placed directly on mortgage insurers. Generally, mortgage insurers are required by certain states and other regulators to maintain a risk in-force to capital ratio not to exceed 25:1. As of December 31, 2003, none of our mortgage insurance subsidiaries had a risk in-force to capital ratio in excess of 25:1.

#### ***Reserves***

Our U.S. mortgage insurance subsidiaries are required under state insurance laws to establish a special statutory contingency reserve in their statutory financial statements to provide for losses in the event of significant economic declines. Annual additions to the statutory contingency reserve must equal at least 50% of premiums earned, and these reserves cannot be withdrawn for 10 years, except under certain limited circumstances. The statutory contingency reserve as of December 31, 2003 for our mortgage insurance subsidiaries was approximately \$3.0 billion. This reserve effectively restricts our U.S. mortgage insurance subsidiaries' ability to pay dividends and other distributions because it reduces policyholders' surplus.

#### ***Federal regulation***

In addition to federal laws that directly affect mortgage insurers, private mortgage insurers are affected indirectly by federal legislation and regulation affecting mortgage originators and lenders, by purchasers of mortgage loans such as Freddie Mac and Fannie Mae, and by governmental insurers such as the FHA and VA. For example, changes in federal housing legislation and other laws and regulations that affect the demand for private mortgage insurance may have a material effect on private mortgage insurers. Legislation or regulation that increases the number of people eligible for FHA or VA mortgages could have a materially adverse effect on our ability to compete with the FHA or VA.

The Homeowners Protection Act provides for the automatic termination, or cancellation upon a borrower's request, of private mortgage insurance upon satisfaction of certain conditions. The

201

---

Homeowners Protection Act applies to owner-occupied residential mortgage loans regardless of lien priority and to borrower-paid mortgage insurance closed after July 29, 1999. FHA loans are not covered by the Homeowners Protection Act. Under the Homeowners Protection Act, automatic termination of mortgage insurance would generally occur once the loan-to-value ratio reaches 78%. A borrower generally may request cancellation of mortgage insurance once the loan-to-value reaches 80% of the home's original value or when actual payments reduce the loan balance to 80% of the home's original value, whichever occurs earlier. For borrower-initiated cancellation of mortgage insurance, the borrower must have a "good payment history" as defined by the Homeowners Protection Act.

The Real Estate Settlement and Procedures Act of 1974, or RESPA, applies to most residential mortgages insured by private mortgage insurers. Mortgage insurance has been considered in some cases to be a "settlement service" for purposes of loans subject to RESPA. Subject to limited exceptions, RESPA prohibits persons from accepting anything of value for referring real estate settlement services to any provider of such services. Although many states prohibit mortgage insurers from giving rebates, RESPA has been interpreted to cover many non-fee services as well. Both mortgage insurers and their customers are subject to the possible sanctions of this law, which is enforced by HUD and also provides for private rights of action.

In July 2002, HUD proposed a rule under RESPA entitled "Simplifying and Improving the Process of Obtaining Mortgages to Reduce Settlement Costs to Consumers." Under this proposed rule, lenders and other packagers of loans are given the choice of offering a "Guaranteed Mortgage Package" or providing a "Good Faith Estimate" where the estimated fees are subject to a 10% tolerance. Qualifying packages would be entitled to a "safe harbor" from RESPA's anti-kickback rules. Mortgage insurance is included in the package "to the extent an upfront premium is charged." It is unclear in what form, if any, HUD's proposed rule will be implemented or what impact it may have on the mortgage insurance industry.

Most originators of mortgage loans are required to collect and report data relating to a mortgage loan applicant's race, nationality, gender, marital status and census tract to HUD or the Federal Reserve under the Home Mortgage Disclosure Act of 1975, or HMDA. The purpose of HMDA is to detect possible discrimination in home lending and, through disclosure, to discourage such discrimination. Mortgage insurers are not required to report HMDA data although, under the laws of several states, mortgage insurers currently are prohibited from discriminating on the basis of certain classifications. Mortgage insurers have, through MICA, entered voluntarily into an agreement with the Federal Financial Institutions Examinations Council to report the same data on loans submitted for insurance as is required for most mortgage lenders under HMDA.

### *International regulation*

#### *Canada*

The Office of the Superintendent of Financial Institutions, or OSFI, provides oversight to all federally incorporated financial institutions, including our Canadian mortgage insurance company. The Federal Bank Act, Insurance Companies Act and Trust and Loan Companies Act prohibits Canadian banks, trust companies and insurers from extending mortgage loans where the loan value exceeds 75% of the property's value, unless mortgage insurance is obtained in connection with the loan. As a result, all mortgages issued by these financial institutions with loan-to-value ratio exceeding 75% must be insured by a qualified insurer or the CMHC. We currently are the only qualified private insurer.

We have an agreement with the Canadian government under which it guarantees the benefits payable under a mortgage insurance policy, less 10% of the original principal amount of an insured loan, in the event that we fail to make claim payments with respect to that loan because of insolvency. We pay the Canadian government a risk premium for this guarantee and make other payments to a reserve fund in respect of the government's obligation. Because banks are not required to maintain regulatory capital on an asset backed by a sovereign guarantee, our 90% sovereign guarantee permits

---

lenders purchasing our mortgage insurance to reduce their regulatory capital charges for credit risks on mortgages by 90%.

The legislative requirement in Canada to obtain mortgage insurance on high loan-to-value mortgages and the favorable capital treatment given to financial institutions because of our 90% sovereign guarantee effectively precludes these financial institutions from issuing simultaneous second mortgage products similar to those offered in the U.S.

#### *Australia*

APRA regulates all financial institutions in Australia, including general, life and mortgage insurance companies. Effective July 1, 2002, APRA provided new regulatory standards for all general insurers, including mortgage insurance companies. APRA's license conditions currently require Australian mortgage insurance companies, including us, to be mono-line insurers, which are insurance companies that offer just one type of insurance product. However, in November 2003, APRA announced that it is considering, and has sought comment on, a proposal to eliminate the requirement that mortgage insurance companies be mono-line insurers, which APRA believes could facilitate the entry of new competitors.

APRA also sets authorized capital levels and regulates corporate governance requirements, including our risk management strategy. In this regard, APRA reviews our management, controls, processes, reporting and methods by which all risks are managed, including a periodic review of outstanding insurance liabilities by an approved actuary, and a reinsurance management strategy, which outlines our use of reinsurance in Australia.

In addition, APRA determines the capital requirements for depository institutions and provides for reduced capital requirements for depository institutions that insure residential mortgages with loan-to-value ratios above 80% with an "A" rated, or equivalently rated, mortgage insurance company that is regulated by APRA. Our insurance subsidiaries that serve the Australian and New Zealand markets have financial-strength ratings of "AA" (Very Strong) from S&P and Fitch and a rating of "Aa2" (Excellent) from Moody's. The "AA" rating is the third-highest of S&P's 21 ratings categories and the third-highest of Fitch's 24 ratings categories. The "Aa2" rating is the third-highest of Moody's 21 ratings categories.

APRA currently is studying the adequacy of the capital requirements that govern lenders and mortgage insurers in Australia, particularly in the event of a severe recession accompanied by a significant decline in housing values. If APRA concludes that the capital requirements that currently govern mortgage issuers are not sufficient and decides to increase the amount of capital required for mortgage insurers, we may, depending on the amount of such increase, be required to increase the capital in our Australian mortgage insurance business. This would reduce our returns on capital from those operations.

#### *United Kingdom and Continental Europe*

The U.K. is a member of the European Union and applies the harmonized system of regulation set out in the European Union directives. Our authorization to provide mortgage insurance in the U.K. enables us to offer our products in all the European Union member states, subject to certain regulatory requirements of the FSA and, in some cases, local regulatory requirements. We can provide mortgage insurance only in the classes for which we have authorization under applicable regulations and must maintain required risk capital reserves. We are also subject to the oversight of other regulatory agencies in other countries where we do business throughout Europe. For more information about U.K. insurance regulation that affects our mortgage subsidiaries that operate in the U.K., see "—U.K. Insurance Regulation."

## **Other Non-U.S. Insurance Regulation**

We operate in a number of countries around the world in addition to the U.S., the U.K., Canada and Australia. These countries include France, Mexico, Spain, Bermuda and a number of other countries in Europe. Generally, our subsidiaries (and in some cases our branches) conducting business in these countries must obtain licenses from local regulatory authorities and satisfy local regulatory requirements, including those relating to rates, forms, capital, reserves and financial reporting.

## **Other Laws and Regulations**

### *Securities regulation*

Certain of our U.S. subsidiaries and certain policies and contracts offered by them, are subject to various levels of regulation under the federal securities laws administered by the SEC. Certain of our U.S. subsidiaries are investment advisers registered under the Investment Advisers Act of 1940. Certain of their respective employees are licensed as investment advisory representatives in the states where those employees have clients. Our U.S. investment adviser subsidiaries also manage investment companies that are registered with the SEC under the Investment Company Act of 1940. In addition, some of our insurance company separate accounts are registered under the Investment Company Act of 1940. Some annuity contracts and insurance policies issued by some of our U.S. subsidiaries are funded by separate accounts, the interests in which are registered under the Securities Act of 1933. Certain of our subsidiaries are registered and regulated as broker/dealers under the Securities Exchange Act of 1934 and are members of, and subject to regulation by, the NASD, as well as by various state and local regulators. The registered representatives of our broker/dealers are also regulated by the SEC and NASD and are further subject to applicable state and local laws.

These laws and regulations are primarily intended to protect investors in the securities markets and generally grant supervisory agencies broad administrative powers, including the power to limit or restrict the conduct of business for failure to comply with such laws and regulations. In such event, the possible sanctions that may be imposed include suspension of individual employees, limitations on the activities in which the investment adviser or broker/dealer may engage, suspension or revocation of the investment adviser or broker/dealer registration, censure or fines. We may also be subject to similar laws and regulations in the states and other countries in which we provide investment advisory services, offer the products described above or conduct other securities-related activities.

Certain of our U.S. subsidiaries also sponsor and manage investment vehicles that rely on certain exemptions from registration under the Investment Company Act of 1940 and the Securities Act of 1933. Nevertheless, provisions of the Investment Company Act of 1940 and the Securities Act of 1933 apply to these investment vehicles and the securities issued by such vehicles. The Investment Company Act of 1940 and the Securities Act of 1933, including the rules promulgated thereunder, are subject to change which may affect our U.S. subsidiaries that sponsor and manage such investment vehicles.

### *Environmental considerations*

As an owner and operator of real property, we are subject to extensive U.S. federal and state and non-U.S. environmental laws and regulations. Potential environmental liabilities and costs in connection with any required remediation of such properties also is an inherent risk in property ownership and operation. In addition, we hold equity interests in companies and have made loans secured by properties that could potentially be subject to environmental liabilities. We routinely have environmental assessments performed with respect to real estate being acquired for investment and real property to be acquired through foreclosure. We cannot provide assurance that unexpected environmental liabilities will not arise. However, based upon information currently available to us, we believe that any costs associated with compliance with environmental laws and regulations or any remediation of such properties will not have a material adverse effect on our business, financial condition or results of operations.

### *ERISA considerations*

We provide certain products and services to certain employee benefit plans that are subject to ERISA or the Internal Revenue Code. As such, our activities are subject to the restrictions imposed by ERISA and the Internal Revenue Code, including the requirement under ERISA that fiduciaries must perform their duties solely in the interests of ERISA plan participants and beneficiaries and the requirement under ERISA and the Internal Revenue Code that fiduciaries may not cause a covered plan to engage in certain prohibited transactions with persons who have certain relationships with respect to such plans. The applicable provisions of ERISA and the Internal Revenue Code are subject to enforcement by the U.S. Department of Labor, the IRS and the Pension Benefit Guaranty Corporation.

### *USA Patriot Act*

The USA Patriot Act of 2001, or the Patriot Act, enacted in response to the terrorist attacks on September 11, 2001, contains anti-money laundering and financial transparency laws and mandates the implementation of various new regulations applicable to broker/dealers and other financial services companies including insurance companies. The Patriot Act seeks to promote cooperation among financial institutions, regulators and law enforcement entities in identifying parties that may be involved in terrorism or money laundering. Anti-money laundering laws outside of the U.S. contain similar provisions. The increased obligations of financial institutions to identify their customers, watch for and report suspicious transactions, respond to requests for information by regulatory authorities and law enforcement agencies, and share information with other financial institutions, require the implementation and maintenance of internal practices, procedures and controls. We believe that we have implemented, and that we maintain, appropriate internal practices, procedures and controls to enable us to comply with the provisions of the Patriot Act.

### *Privacy of consumer information*

U.S. federal and state laws and regulations require financial institutions, including insurance companies, to protect the security and confidentiality of consumer financial information and to notify consumers about their policies and practices relating to their collection and disclosure of consumer information and their policies relating to protecting the security and confidentiality of that information. Similarly, federal and state laws and regulations also govern the disclosure and security of consumer health information. In particular, regulations promulgated by the U.S. Department of Health and Human Services regulate the disclosure and use of protected health information by health insurers and others, the physical and procedural safeguards employed to protect the security of that information and the electronic transmission of such information. Congress and state legislatures are expected to consider additional legislation relating to privacy and other aspects of consumer information.

In Europe, the collection and use of personal information is subject to strict regulation. The European Union's Data Protection Directive establishes a series of privacy requirements that EU member states are obliged to enact in their national legislation. European countries that are not EU member states have similar privacy requirements in their national laws. These requirements generally apply to all businesses, including insurance companies. In general, companies may process personal information only if consent has been obtained from the persons concerned or if certain other conditions are met. These other requirements include the provision of notice to customers and other persons concerning how their personal information is used and disclosed, limitations on the transfer of personal information to countries outside the European Union, registration with the national privacy authorities, where applicable, and the use of appropriate information security measures against the access or use of personal information by unauthorized persons.

## Management

### Directors and Executive Officers

The following table sets forth certain information concerning our directors and executive officers as of the completion of this offering:

Name	Age	Positions
Michael D. Fraizer	45	Chairman, President and Chief Executive Officer
Thomas H. Mann	53	President and Chief Executive Officer—Mortgage Insurance
Pamela S. Schutz	49	President and Chief Executive Officer—Retirement Income and Investments
George R. Zippel	45	President and Chief Executive Officer—Protection
K. Rone Baldwin	45	Senior Vice President—Employee Benefits Group
Mark W. Griffin	45	Senior Vice President—Chief Risk Officer
Debra M. Horvath	49	Senior Vice President—Chief Information Officer
Michael S. Laming	52	Senior Vice President—Human Resources
Scott J. McKay	43	Senior Vice President—Operations & Quality
Richard P. McKenney	35	Senior Vice President—Chief Financial Officer
Victor C. Moses	56	Senior Vice President—Chief Actuary
Joseph J. Pehota	43	Senior Vice President—Business Development
Leon E. Roday	50	Senior Vice President, General Counsel and Secretary
William R. Wright, Jr.	51	Senior Vice President—Chief Investment Officer
Elizabeth J. Comstock	43	Director
Pamela Daley	51	Director
Dennis D. Dammerman	58	Director
David R. Nissen	52	Director
James A. Parke	58	Director

### Executive Officers and Directors

The following sets forth certain biographical information with respect to our executive officers and directors listed above.

Michael D. Fraizer will be our Chairman, President and Chief Executive Officer upon the completion of this offering and has been a Vice President of GE since December 1995 and a Senior Vice President of GE since June 2000. Since November 1996, Mr. Fraizer has been Chairman of the Board and, since April 1997, President and Chief Executive Officer, of GEFAHI. Mr. Fraizer also has been a director of GE Capital and General Electric Capital Services, Inc. Mr. Fraizer led the Consumer Savings and Insurance Group, a predecessor of GEFAHI, from February 1996 until the formation of GEFAHI in October 1996. Prior to that time, Mr. Fraizer was President and Chief Executive Officer of GE Capital Commercial Real Estate, an affiliate of our company, from July 1993 to December 1996, leading both the GE Consumer Savings and Insurance Group and GE Capital Commercial Real Estate from February to December of 1996. From July 1991 to June of 1993, he was Vice President—Portfolio Acquisitions and Ventures of GE Capital Commercial Real Estate. From December 1989 to June 1991, Mr. Fraizer was President and Managing Director, GE Japan, an affiliate of our company. From July 1983 to November 1989 Mr. Fraizer served in various capacities as a

member of GE's Corporate Audit Staff and Corporate Business Development after joining GE in its Financial Management Program. Mr. Fraizer received a B.A. in Political Science from Carleton College in 1980. He is a member of the board of the American Council of Life Insurers.

Thomas H. Mann will be our President and Chief Executive Officer—Mortgage Insurance upon the completion of this offering and has been President, Chief Executive Officer and a Director of General Electric Mortgage Insurance Corporation, or GE Mortgage, a subsidiary of our company, since May 1996 and a Vice President of GE since April 1996. From March 1990 to April 1996, Mr. Mann served as Vice President of GE Capital and General Manager of GE Capital Vendor Financial Services. Prior to that time, he served as Executive Vice President—Operations with GE Mortgage from August 1986 to March 1990. From November 1984 to August 1986, Mr. Mann served as Manager—Finance Operations at GE Capital Commercial Real Estate, and from August 1976 to November 1984, he served in various capacities as a member of GE's Corporate Audit Staff. Mr. Mann received a B.S. in Business Administration from the University of North Carolina at Chapel Hill in 1973. He is a member of the Housing Policy Council Executive Committee, part of the Financial Services Roundtable.

Pamela S. Schutz will be our President and Chief Executive Officer—Retirement Income and Investments upon completion of this offering and has been President and Chief Executive Officer of GE Life and Annuity Assurance Company, a subsidiary of our company, since June 1998 and a Vice President of GE since October 2000. From May 1997 to July 1998, Ms. Schutz served as President of The Harvest Life Insurance Company, then an affiliate of our company. Prior to that time, Ms. Schutz served in various capacities with GE Capital Commercial Real Estate from February 1978 to May 1997, attaining the position of President, GE Capital Realty Group in May 1994.



Ms. Schutz received a B.A. in Urban Planning from Briarcliff College in 1976 and an M.S. in Business from American University in 1978. She is a member of the boards of the National Association of Variable Annuities and the Medical Information Bureau.

George R. Zippel will be our President and Chief Executive Officer—Protection upon completion of this offering and has been the President and Chief Executive Officer of Independent Brokerage Group, a business unit of our company, since September 1999 and a Vice President of GE since July 2001. From July 1997 to September 1999, he was President at GE Lighting Systems, a division of GE. Prior to that time, Mr. Zippel served in various capacities with GE Industrial Systems from July 1991 to July 1997. Prior thereto, he was a Manager of Corporate Initiatives from September 1989 to July 1991. From September 1984 to September 1989, he held various positions on GE's Corporate Audit Staff. Prior thereto, Mr. Zippel participated in GE's Financial Management Program, and upon graduating from the program, worked as a Financial Analyst for GE Semiconductor. Mr. Zippel received a B.A. in Economics from Hamilton College in 1981.

K. Rone Baldwin will be our Senior Vice President—Employee Benefits Group upon completion of this offering and has been Senior Vice President—Employee Benefits Group of GEFAHI since March 2004. He was Senior Vice President—Strategic Development at GE Insurance, a business unit of GE Capital, from September 2002 to February 2004 and a Vice President of GE since July 2000. From September 1998 to September 2002, he was the President and CEO of GE Edison Life Insurance Company, then an affiliate of our company. Prior to that time, Mr. Baldwin was President of GE Capital Japan from March 1997 to September 1998 and Vice President—Business Development at GE Capital from December 1994 to March 1997. From September 1989 to December 1994, Mr. Baldwin was Senior Vice President at Mutual of New York. Prior thereto, Mr. Baldwin held positions with Goldman, Sachs & Co. and Booz Allen & Hamilton. Mr. Baldwin received a B.A. in Physics from Amherst College in 1980 and an M.B.A. from Harvard Business School in 1982.

Mark W. Griffin will be our Senior Vice President—Chief Risk Officer upon completion of this offering and has been the Chief Risk Manager of GE Insurance, a business unit of GE Capital, since August 2002. From January 2000 to August 2002, Mr. Griffin was Chief Risk Manager of GEFAHI.

207

---

Prior thereto, Mr. Griffin was Vice President, Risk Markets & Executive Director, Pension & Insurance with Goldman, Sachs & Co. from August 1994 to December 1999. From December 1986 to August 1994, Mr. Griffin was Executive Director—Fixed Income and Principal, Fixed Income Sales with Morgan Stanley. Prior thereto, Mr. Griffin was an Assistant Actuary with the Metropolitan Life Insurance Company from July 1982 to December 1986. Mr. Griffin received a B.A. in Mathematics from the University of Waterloo in 1982. Mr. Griffin is a Fellow of the Society of Actuaries and the Canadian Institute of Actuaries, and is a Chartered Financial Analyst. He holds an FRM, or Financial Risk Manager, designation from the Global Association of Risk Professionals and a PRM, or Professional Risk Manager, designation from the Professional Risk Management International Association.

Debora M. Horvath will be our Senior Vice President—Chief Information Officer upon completion of this offering and has been a Senior Vice President, the Chief Information Officer and the Chief Technology Officer of GEFAHI since March 1997. From May 1993 to March 1997, she was Chief Information Officer of GNA Corporation, or GNA. Prior thereto, Ms. Horvath served in various capacities with GE Aircraft Engines and GE Lighting from April 1979 to May 1993. She is also a graduate of GE's Financial Management Program. Ms. Horvath received a B.A. in Business from Baldwin Wallace College in 1984. She is a member of the board of the Greater Richmond Technology Council, and is a member of Women in Technology International.

Michael S. Laming will be our Senior Vice President—Human Resources upon completion of this offering and has been a Senior Vice President of GE Insurance, a business unit of GE Capital, since August 2001 and a Vice President of GE since April 2003. From July 1996 to August 2001, Mr. Laming was a Senior Vice President at GEFAHI and its predecessor companies. Prior thereto, he held a broad range of human resource positions in operating units of GE and at GE corporate headquarters. He graduated from the GE Manufacturing Management Program in 1978. Mr. Laming received both a B.S. in Business Administration in 1974 and a Masters of Organization Development in 1983 from Bowling Green State University.

Scott J. McKay will be our Senior Vice President—Operations & Quality upon completion of this offering and has been the Senior Vice President, Operations & Quality of GEFAHI since December 2002. From July 1993 to December 2002, Mr. McKay served in various information technology related positions at GEFAHI's subsidiaries, including Chief Technology Officer, and Chief Information Officer of Federal Home Life Assurance Company. Prior thereto, he was Officer and Director of Applications for United Pacific Life Insurance Company from July 1992 to July 1993, and an IT consultant for Sycomm Systems and Data Executives, Inc. from January 1985 to July 1992. Mr. McKay received a B.S. in Computer Science from West Chester University of Pennsylvania in 1983.

Richard P. McKenney will be our Senior Vice President—Chief Financial Officer upon the completion of this offering and has been, since December 2002, a Senior Vice President and the Chief Financial Officer of GEFAHI. From May 2000 to October 2002, he was Vice President of Business Planning and Analysis of GEFAHI. Prior thereto, Mr. McKenney was Manager of Financial Planning from October 1996 to April 1998 and Chief Financial Officer from April 1998 to May 2000 at GE Life & Annuity Assurance Company, an affiliate of our company. From July 1993 to October 1996, he held various positions on GE's Corporate Audit Staff. Prior thereto, Mr. McKenney was in the GE Manufacturing Management Program from June 1991 to July 1993. Mr. McKenney received a B.S. in Mechanical Engineering from Tufts University in 1991.

Victor C. Moses will be our Senior Vice President—Chief Actuary upon completion of this offering and has been Senior Vice President—Actuarial/Capital Management of GEFAHI since January 2000. From 1971 to 1983 Mr. Moses worked in various positions at SAFECO Life Insurance Company and from 1983 to 1993 he served in various capacities with GNA, ultimately serving as both Chief Actuary and Chief Financial Officer. In 1993, GNA was acquired by GE Capital, and from then until December 1999, Mr. Moses was Senior Vice President—International Business Development at

208

---

GEFAHI and its predecessor companies. Mr. Moses received a B.A. in Math from Seattle Pacific University in 1970. Mr. Moses is a Fellow in the Society of Actuaries and a Member of the American Academy of Actuaries. He serves on the Board of Trustees of Seattle Pacific University.

Joseph J. Pehota will be our Senior Vice President—Business Development upon the completion of this offering and has been Senior Vice President—Business Development of GEFAHI since August 1998. From February 1996 to July 1998, he was the Chief Risk Manager for GE Equity, an affiliate of our company. Prior thereto, Mr. Pehota was Vice President and Manager of Global Distribution for the GE Capital Structured Finance Group, an affiliate of our company, from January 1995 to February 1996. From March to December 1994, he was the Vice President of Restructuring and Underwriting—North America, for GE Capital's Aviation Services business, an affiliate of our company. Prior thereto, Mr. Pehota held various leadership positions with GE Capital's Structured Finance Group, an affiliate of our company, from July 1988 to February 1994. Mr. Pehota received a B.S. in Finance from the University of Connecticut in 1983 and an M.B.A. from New York University in 1988.

Leon E. Roday will be our Senior Vice President, General Counsel and Secretary upon the completion of this offering and has been Senior Vice President, General Counsel, Secretary and a Director of GEFAHI and its predecessor companies since May 1996 and a Vice President of GE since November 2002. From October 1982 through May 1996, Mr. Roday was at the law firm of LeBoeuf, Lamb, Greene & MacRae, LLP, and he was a partner at that firm from 1991 to 1996. Mr. Roday received a B.A. in Political Science from the University of California at Santa Barbara in 1977 and a J.D. from Brooklyn Law School in 1982. Mr. Roday is a member of the New York Bar Association.

William R. Wright, Jr. will be our Senior Vice President—Chief Investment Officer upon completion of the offering, and has been Executive Vice President and CIO of

Fixed Income—Insurance at GEAM, since April 2003. From March 2000 to March 2003, he was the Managing Director and Chief Investment Officer of GE Edison Life Insurance Company, in Tokyo, Japan. From January 1996 to March 2000 he was the Managing Director of GEAM's first non-U.S. subsidiary in London. Before this, Mr. Wright was the Vice President/Portfolio Manager of International Fixed Income for GE Investments Corporation from May 1993 to January 1996. Prior to joining GE, he was a global fixed income portfolio manager at Continental Asset Management, a subsidiary of Continental Corporation, from 1985 to 1993. From 1980 to 1985 he held various positions with Bankers Trust Company. Mr. Wright received an MBA in Finance from New York University Stern School of Business Administration in 1987, a Diploma in Chinese Mandarin from Defense Language Institute, and a B.A. in Political Science and East Asian Studies from Wittenberg University in 1975. He is a member of both the New York Society of Security Analysts and the Association of Investment Management and Research.

Elizabeth J. Comstock will be a member of our board of directors upon completion of this offering. Ms. Comstock has been Vice President and Chief Marketing Officer of GE since July 2003. From 1998 to 2003 Ms. Comstock was Vice President of Corporate Communications at GE. From 1996 to 1998 Ms. Comstock was Senior Vice President of NBC Communications and from 1993 to 1996 was Vice President of NBC News Communications. Prior thereto, Ms. Comstock served as an entertainment media director at CBS Television from 1992 to 1993 and as the New York-based head of communications for Turner Broadcasting from 1990 to 1992. Prior thereto, from 1986 to 1990 she held various positions at NBC News. Ms. Comstock received a B.S. degree in Biology from the College of William and Mary in 1982. Ms. Comstock was designated to our board of directors by GE.

Pamela Daley will be a member of our board of directors upon completion of this offering. Ms. Daley has been Vice President and Senior Counsel for Transactions at GE since 1991, was Senior Counsel for Transactions at GE from 1990 to 1991 and was Tax and Finance Counsel at GE from 1989 to 1990. Prior thereto, Ms. Daley was a partner at Morgan, Lewis & Bockius LLP, from 1986 to 1989 and an associate at that firm from 1979 to 1986. Ms. Daley received an A.B. in Romance Languages

209

---

and Literatures from Princeton University in 1974 and a J.D. from the University of Pennsylvania in 1979. Ms. Daley was designated to our board of directors by GE.

Dennis D. Dammerman will be a member of our board of directors upon completion of this offering. Mr. Dammerman has been a Vice Chairman and Executive Officer of GE and the CEO of GE Capital Services, Inc. since 1998. Mr. Dammerman has also been a Director of GE since 1994. From 1984 to 1998 he was Senior Vice President—Finance and Chief Financial Officer at GE, and from 1981 to 1984 he was Vice President and General Manager of GE Capital's Real Estate Financial Services Division. Prior thereto, from 1967 to 1981 he had various financial assignments in several GE businesses. Mr. Dammerman received a B.A. from the University of Dubuque in 1967. Mr. Dammerman was designated to our board of directors by GE.

David R. Nissen will be a member of our board of directors upon completion of this offering. Mr. Nissen has been President and CEO of Global Consumer Finance at GE since 1993 and a Senior Vice President at GE since 2001. From 1990 to 1993, Mr. Nissen was General Manager of U.S. Consumer Financial Services at Monogram Bank, an affiliate of GE. Prior thereto, from 1980 to 1990 he held various management positions in several GE businesses. Mr. Nissen received a B.A. in Economics from Northwestern University in 1973 and an M.B.A. from the University of Chicago in 1975. Mr. Nissen was designated to our board of directors by GE.

James A. Parke will be a member of our board of directors upon completion of this offering. Mr. Parke has been Vice Chairman and Chief Financial Officer of GE Capital and a Senior Vice President at GE since 2002. From 1989 to 2002 he was Senior Vice President and Chief Financial Officer at GE Capital and a Vice President of GE. Prior thereto, from 1981 to 1989 he held various management positions in several GE businesses. Mr. Parke received a B.A. in History, Political Science and Economics from Concordia College in Minnesota in 1968. Mr. Parke was designated to our board of directors by GE.

#### **Composition of the Board of Directors**

Upon completion of this offering, and until the first date on which GE owns 50% or less of our outstanding common stock, our board of directors will consist of nine persons, each of whom will serve a one-year term. When GE owns at least 10% but not more than 50% of our outstanding common stock, our board of directors will consist of eleven persons. Beginning on the first date on which GE owns less than 10% of our outstanding common stock, the number of persons constituting our board of directors may be fixed from time to time by resolution of our board of directors, but under our certificate of incorporation, cannot be less than one nor more than fifteen. So long as GE owns more than 50% of our outstanding common stock, the board of directors will consist of nine members, and GE, in its capacity as the holder of our Class B Common Stock, will have the right to elect five members, and holders of our Class A Common Stock will have the right to elect four members. The size of our board of directors and the election rights of the holders of each class of our common stock will change as GE's percentage ownership of our common stock decreases and are subject to the rights of the holders of any outstanding series of our preferred stock to elect directors under certain limited circumstances. For a detailed description of these election rights, see "Description of Capital Stock—Common Stock—Voting Rights."

#### **Committees of the Board of Directors**

Upon completion of this offering, the standing committees of our board of directors will include the Audit Committee, the Nominating and Corporate Governance Committee, and the Management Development and Compensation Committee. These committees are described below. Our board of directors may also establish various other committees to assist it in its responsibilities. However, our certificate of incorporation provides that until the first date on which GE owns less than 20% of our

210

---

outstanding common stock, our board of directors will not establish an executive committee or any other committee having authority typically reserved for an executive committee.

*Audit Committee.* This committee will be primarily concerned with the accuracy and effectiveness of the audits of our financial statements by our internal audit staff and by our independent auditors. Its duties will include:

- selecting independent auditors;
- reviewing the scope of the audit to be conducted by them, as well as the results of their audit;
- approving non-audit services provided to us by the independent auditor;
- reviewing the organization and scope of our internal system of audit, financial and disclosure controls;
- appraising our financial reporting activities, including our annual report, and the accounting standards and principles followed; and
- conducting other reviews relating to compliance by our employees with our policies and applicable laws.

The Audit Committee will be comprised of three "independent" directors as defined under the applicable rules of The New York Stock Exchange. We intend to appoint these directors to serve on our board and the Audit Committee as soon as practicable after completion of this offering, but in any event within the time period prescribed by the listing rules.

*Nominating and Corporate Governance Committee.* This committee's responsibilities will include the selection of potential candidates for our board of directors and the development and annual review of our governance principles. So long as GE owns more than 50% of our outstanding common stock, this committee will make recommendations of candidates for election to our board of directors directly to our stockholders. When GE owns 50% or less of our outstanding common stock, this committee will make recommendations of candidates for election to our board of directors directly to our board of directors, and our board of directors will make recommendations directly to our stockholders. This committee will not make recommendations regarding directors designated by GE. This committee will also annually review director compensation and benefits, and oversee the annual self-evaluations of our board and its committees. It will also make recommendations to our board of directors concerning the structure and membership of the other board committees. So long as GE beneficially owns more than 50% of our outstanding common stock, the Nominating and Corporate Governance Committee will be comprised of five directors, one of which will be designated by GE, one of which will be our chief executive officer and three of which will be "independent" under the applicable rules of The New York Stock Exchange. When GE beneficially owns 50% or less of our outstanding common stock, the Nominating and Corporate Governance Committee will be comprised of three directors, each of whom will be "independent" under the applicable rules of The New York Stock Exchange.

*Management Development and Compensation Committee.* This committee will have two primary responsibilities: (i) to monitor our management resources, structure, succession planning, development and selection process as well as the performance of key executives; and (ii) to review and approve executive compensation and broad-based and incentive compensation plans. So long as GE beneficially owns more than 50% of our outstanding common stock, the Management Development and Compensation Committee will be comprised of three directors, one of which will be designated by GE, two of which will be "independent" under the applicable rules of The New York Stock Exchange and all of which will qualify as outside directors for purposes of Section 162(m) of the Internal Revenue Code. When GE beneficially owns 50% or less of our outstanding common stock, the Management Development and Compensation Committee will be comprised of three directors, each of whom will be "independent" under the applicable rules of The New York Stock Exchange.

211

## Director Compensation

Each independent director will be paid an annual fee of \$160,000 in quarterly installments, following the end of each quarter of service. Of this amount, 40% (or \$64,000) of the annual fee will be paid in cash and 60% (or \$96,000) will be paid in deferred stock units, or DSUs. The board has elected not to adopt a policy of meeting fees because attendance is expected at all scheduled board and committee meetings, absent exceptional cause. Each DSU will be equal in value to a share of our stock, but will not have voting rights. DSUs will accumulate regular quarterly dividends which will be reinvested in additional DSUs. The DSUs will be paid out in cash beginning one year after the director leaves the board. Directors may elect to take their DSU payments as a lump sum or in equal payments spread out for up to ten years.

## Executive Compensation

The following table sets forth the compensation paid or awarded to our chief executive officer and to each of the persons who were the four other most highly compensated executive officers in 2003 who will be continuing as executive officers after the completion of this offering. We refer to these individuals as our "named executive officers."

### SUMMARY COMPENSATION

Name and principal position	Year	Annual compensation			Long-term compensation			
		Salary (\$)	Bonus (\$)	Other annual compensation(1) (\$)	Awards		Payouts	
					Restricted stock units(2) (\$)	Securities underlying options/SARs (#)(3)	LTIP payouts(4) (\$)	All other compensation(5)(6)(7) (\$)
Michael D. Fraizer(8) President, Chief Executive Officer and Director	2003	962,500	1,525,000	—	1,366,321	195,000	—	94,390
	2002	900,000	1,375,000	—	—	300,000	2,881,300	113,629
	2001	750,000	1,250,000	—	1,574,000	300,000	—	106,626
Thomas H. Mann President and Chief Executive Officer— Mortgage Insurance	2003	500,000	1,150,000	—	940,360	54,000	—	67,388
	2002	460,000	1,050,000	—	—	90,000	1,232,400	59,317
	2001	410,000	930,000	—	—	112,500	—	57,327
Pamela S. Schutz President and Chief Executive Officer—Retirement Income and Investments	2003	392,500	560,000	—	721,763	22,800	—	35,712
	2002	365,000	510,000	—	—	38,000	197,200	32,407
	2001	320,000	485,000	53,872	983,750	42,000	—	49,281
K. Rone Baldwin(9) Senior Vice President— Employee Benefits Group	2003	450,000	490,000	—	751,180	27,000	—	51,692
	2002	430,000	415,000	—	—	45,000	256,000	50,100
	2001	378,333	375,000	—	—	52,500	—	46,741
Leon E. Roday(10) Senior Vice President, General Counsel and Secretary	2003	425,000	360,000	73,224	658,703	13,800	—	40,999
	2002	388,584	310,000	—	270,500	20,000	—	28,037
	2001	341,981	280,000	—	—	22,500	—	23,923

- (1) Includes the aggregate incremental cost of providing perquisites and personal benefits to our named executive officers for each of the last three years. The amounts reported in this column for Ms. Schutz and Mr. Roday, which represent at least 25% of the total amounts reported for a particular year, are \$27,879 for financial counseling and \$25,993 for the use of a company vehicle and \$40,045 for financial counseling and \$23,681 for the use of a company vehicle, respectively. No other named executive officer received perquisites or other personal benefits in an aggregate amount exceeding \$50,000 in any of the periods included in this column.

- (2) Shows the market value of GE restricted stock unit awards, or RSUs, on the date of grant. The aggregate holdings and market value of RSUs held on December 31, 2003, by the individuals reported in this column are: Mr. Fraizer, 297,084 units/\$9,203,662; Mr. Mann, 134,500 units/\$4,166,810; Ms. Schutz, 77,567 units/\$2,403,026; Mr. Baldwin, 94,750 units/\$2,935,355; and Mr. Roday, 49,317 units/\$1,527,841. The restrictions on most of these units lapse on a scheduled basis over the executive officer's career, or upon death, with the restrictions on 25% of the units generally scheduled to lapse three and seven years after the date of grant, and the restrictions on the remaining 50% scheduled to lapse at retirement. The restrictions on RSUs granted in February 2003 will lapse in two 50% increments, the first increment upon the completion of this offering and the second increment one year after the completion of this offering. Regular quarterly dividend equivalents are paid on the RSUs held by these individuals.
- (3) All amounts, except amounts for Mr. Fraizer in 2003, are denominated in shares of GE stock. Amounts shown for Mr. Fraizer in 2003 are denominated in GE SARs. SARs refer to stock appreciation rights.
- (4) Represents the dollar value of payouts pursuant to the GE contingent long-term performance incentive awards granted in 2000.
- (5) Includes payments made pursuant to GE employee savings plans. These amounts are: Mr. Fraizer (\$62,850 in 2003, \$53,400 in 2002 and \$43,750 in 2001); Mr. Mann (\$35,620 in 2003, \$32,400 in 2002 and \$27,950 in 2001); Ms. Schutz (\$21,300 in 2003, \$21,300 in 2002 and \$18,250 in 2001); Mr. Baldwin (\$21,600 in 2003, \$21,600 in 2002 and \$18,450 in 2001); and Mr. Roday (\$22,070 in 2003, \$18,500 in 2002 and \$16,150 in 2001).
- (6) This column includes the estimated dollar value of GE's portion of insurance premium payments for supplemental split-dollar life insurance provided to GE officers prior to the effective date of the Sarbanes-Oxley Act on July 30, 2002. GE will recover all split-dollar premiums paid by it from the policies. The estimated value is calculated, in accordance with SEC rules, as if the 2002 premiums were advanced to the named executive officers without interest until the time GE expects to recover its premium payments. This column also includes taxable payments made to executives to cover premiums for a universal life insurance policy owned by the executive, which is provided to more than 4,400 of GE's executives, including the named executives. These amounts are: Mr. Fraizer (\$9,500 in 2003, \$44,430 in 2002 and \$48,777 in 2001); Mr. Mann (\$24,716 in 2003, \$21,938 in 2002 and \$24,932 in 2001); Ms. Schutz (\$7,045 in 2003, \$4,514 in 2002 and \$25,132 in 2001); Mr. Baldwin (\$21,775 in 2003, \$21,074 in 2002 and \$21,661 in 2001); and Mr. Roday (\$10,762 in 2003, \$3,891 in 2002 and \$2,732 in 2001).
- (7) Includes the difference between market interest rates determined pursuant to SEC rules and the 9.5% to 14% interest contingently credited by GE on salary deferred by the executive officers under various salary deferral plans. Under all such plans, the executive officers generally must remain employed by GE and its affiliates for at least four years following the deferrals, or retire or transfer to a successor employer (in this case, including Genworth when GE ceases to own 50% or more of our outstanding common stock) after a year of deferral, in order to obtain the stated interest rate. These amounts are: Mr. Fraizer (\$22,040 in 2003, \$15,799 in 2002 and \$14,099 in 2001); Mr. Mann (\$7,052 in 2003, \$4,979 in 2002 and \$4,445 in 2001); Ms. Schutz (\$7,367 in 2003, \$6,593 in 2002 and \$5,899 in 2001); Mr. Baldwin (\$8,317 in 2003, \$7,426 in 2002 and \$6,630 in 2001); and Mr. Roday (\$8,167 in 2003, \$5,646 in 2002 and \$5,041 in 2001).
- (8) Does not include a special one-time incentive bonus of \$2 million (net of applicable taxes) to be paid by GE to Mr. Fraizer in his capacity as an officer of GE for executing GE's overall insurance strategy of selling or repositioning various GE insurance businesses and completing this offering. This bonus will be paid by GE upon completion of this offering.
- (9) Excludes certain cost of living allowances and tax gross-up payments paid by GE in connection with Mr. Baldwin's overseas assignment from July 2000 to August 2002. These amounts were \$98,530 in 2003, \$195,699 in 2002 and \$333,193 in 2001.
- (10) Does not include amounts earned pursuant to an executive annuity program to be paid by us. Under the annuity program, Mr. Roday is eligible to receive ten annual payments of \$50,000 beginning in 2007, ten years after the original date of his grant. Mr. Roday's interest in the annuity payments vests over ten years at the rate of five-sixths of one percent for each completed month of employment. As of December 31, 2003, Mr. Roday was vested in and entitled to receive approximately 74% of his annual annuity payments or \$37,000 per year.

#### Executive Officer Stock Ownership Guidelines

In order to help demonstrate the alignment of the personal interests of our executive officers with the interests of our stockholders, we have established the following stock ownership requirements, as multiples of the executive officer's base salary, that must be held by our executive officers:

Position	Multiple
Genworth Chief Executive Officer	5x
Presidents and Senior Vice Presidents	2x

The number of shares of our stock that must be held is determined by multiplying the executive officer's annual base salary in 2003 by the applicable multiple shown above, and dividing the result by the average closing price of our stock during the immediately preceding 12 months. In order to meet this stock ownership requirement, an executive officer may count all shares of our stock owned by the executive officer, including stock held in our 401(k) plan, stock units held in any deferral plan and any company RSUs, including RSUs issued to the executive officer upon conversion of GE RSUs in connection with this offering, but excluding any RSUs that lapse upon retirement. Each executive officer must attain ownership of the required stock ownership level within five years after GE ceases to own more than 50% of our outstanding stock (or if later, within five years of becoming an executive officer) and maintain ownership of at least such amount of our stock while they hold office.

In order to assist any particular executive officer in obtaining the required level of stock ownership, each executive officer will be given the option, exercisable at any time during the five year period above, to elect to receive a portion of his or her annual incentive compensation, including LTIPs, in our common stock. In the event that an executive officer fails to reach a required level of stock ownership during the five year period above, we will require the executive officer to be paid, in lieu of any annual incentive payments, in common stock until the applicable required level of stock ownership is obtained.

#### Benefit Plans—Transition from GE to Genworth Plans

Prior to this offering, our employees have been covered under GE benefit plans. These GE benefit plans include the GE 1990 Long-Term Incentive Plan providing stock options, stock appreciation rights, or SARs, restricted stock unit awards, or RSUs, and long-term contingent performance incentive awards; GE Incentive Compensation Plan; retirement programs providing pension, 401(k), health and life insurance benefits; medical, dental and vision benefits for active employees; disability and life insurance protection; and severance. We have reimbursed GE for benefits it has provided to our employees under these benefit plans.

After the completion of this offering, and for so long as GE owns more than 50% of our outstanding common stock, we will be part of the GE group, and our employees generally will continue to be eligible to participate in the GE benefit plans, except as noted below. When GE ceases to own more than 50% of our outstanding common stock, we anticipate that these employees will be covered by the benefit plans that we expect to establish. However, to the extent these employees are non-U.S. employees, benefit transition may be delayed, by mutual agreement between GE and us, for up to six months following the date that GE ceases to own more than 50% of our outstanding common stock (such date, whether delayed or not, is referred to as the "International Benefit Transition Date").

Prior to this offering, some of the employees of our business received certain awards under the GE 1990 Long-Term Incentive Plan. The treatment of these outstanding awards in connection with this offering are described below under "—GE 1990 Long-Term Incentive Plan." After the completion of this offering, our employees will no longer be eligible to participate in the GE 1990 Long-Term Incentive Plan.

Prior to the completion of this offering, we will establish, adopt and maintain plans for our selected employees providing for cash or other bonus awards, stock options, stock awards, restricted stock, other equity-related awards and long-term performance awards. However, certain of our employees will continue to participate in the GE Incentive Compensation Plan based on our company- and individual-specific performance measures, and our corresponding plan providing for annual cash or other bonus awards will not become effective until the date that GE ceases to own more than 50% of our outstanding common stock. See "—Omnibus Incentive Plan" and "—Incentive Compensation Program" for information concerning these plans.

From the completion of this offering until GE ceases to own more than 50% of our outstanding common stock or, in the case of our applicable non-U.S. employees, the International Benefit Transition Date, we will reimburse GE for the costs incurred by GE and its affiliates for continuing coverage of our employees in the GE benefit plans. We will also reimburse GE for the reasonable costs incurred by GE and its affiliates for cooperating in the operation and administration of our benefit plans, including our plans providing for stock options, stock awards, restricted stock, other equity-related awards and long-term performance awards and, to some extent, for the tax benefits we realize in connection with these compensation and benefit plans and arrangements. See "Arrangements between GE and Our Company—Employee Matters Agreement" for information concerning our benefit plans, our reimbursement obligations to GE, and other employment matters after the completion of this offering, and see "Arrangements Between GE and Our Company—Tax Matters Agreement."

### Stock Option Grants and SARs

Stock options and SARs were granted to our named executive officers in 2003 by GE. Each stock option permits the named executive officer, generally for a period of ten years, to purchase one share of GE stock at the market price of GE stock on the date of grant. Each SAR expires ten years after the date of grant and permits the executive officer to receive an amount equal to the difference between the SAR exercise price and the fair market value of one share of GE stock on the date the SAR is exercised. The amount of such difference, multiplied by the number of SARs exercised, is payable and delivered in GE stock. The following tables provide information on stock options and SARs granted in 2003, and on previously granted stock options exercised by the named executive officers during 2003, as well as information on their stock option and SARs holdings at the end of 2003. See "—GE 1990 Long-Term Incentive Plan" for a description of the treatment of these options and SARs after this offering.

#### STOCK OPTION/SAR GRANTS IN 2003

Name	Individual grants(1)					Grant date present value\$(2)
	Number of options/SARs granted (#)	Percent of total GE options/SARs granted	Exercise or base price (\$/Sh)	Expiration date		
Michael D. Fraizer	195,000	1.6359%	31.53	9/12/13		1,834,642
Thomas H. Mann	54,000	0.4530%	31.53	9/12/13		508,055
Pamela S. Schutz	22,800	0.1913%	31.53	9/12/13		214,512
K. Rone Baldwin	27,000	0.2265%	31.53	9/12/13		254,027
Leon E. Roday	13,800	0.1158%	31.53	9/12/13		129,836

- (1) Options are denominated in shares of GE stock. SARs are denominated in GE SARs.
- (2) These estimated hypothetical values are based on a Black-Scholes option pricing model in accordance with SEC rules. We used the following assumptions in estimating these values: potential option term, 10 years; risk free rate of return, 3.5%; expected volatility, 34.7%; and expected dividend yield, 2.5%.

#### AGGREGATED STOCK OPTIONS/SARs EXERCISED IN 2003, AND DECEMBER 31, 2003 OPTION/SAR VALUES(1)

Name	Options/SARs exercised (#)	Value realized (\$)	Number of unexercised options/SARs at December 31, 2003 (#)		Value of unexercised in-the-money options/SARs at December 31, 2003 (\$)(2)	
			Exercisable	Unexercisable	Exercisable	Unexercisable
Michael D. Fraizer	36,000	733,680	719,000	765,000	5,845,116	943,200
Thomas H. Mann	72,000	1,654,790	413,500	271,000	3,749,245	282,960
Pamela S. Schutz	9,000	142,451	101,100	102,200	962,325	119,472
K. Rone Baldwin	—	—	177,000	125,500	1,764,729	141,480
Leon E. Roday	—	—	34,500	55,800	57,100	62,880

- (1) Options are denominated in shares of GE stock. SARs are denominated in GE SARs.
- (2) Stock option and SAR values are based upon the difference between the grant prices of all outstanding options and SARs awarded in 2003 and prior years and the December 31, 2003 closing price for GE's stock of \$30.98 per share.

### Retirement Plans

We anticipate that our U.S. employees will be covered by the GE retirement plans for so long as GE owns more than 50% of our outstanding common stock. Thereafter, we anticipate that our U.S. employees will be covered by the retirement plans that we expect to establish. See "Arrangements between GE and Our Company—Employee Matters Agreement" for information concerning our retirement plans after the completion of this offering. The summary below relates to the GE retirement plans.

Under the GE retirement plans, employees are generally eligible to retire with uncredited benefits under such plans at age 60 or later, and with social security benefits at age 62 or later. The estimated total annual retirement benefits provided under the GE retirement plans (GE Pension Plan, GE Supplementary Pension Plan and GE Excess Benefit Plan) and social security for our employees in higher salary classifications retiring directly from GE and its affiliates at age 62 or later are as follows.

Earnings credited for retirement benefits	Years of service at retirement				
	20	25	30	35	40
\$ 500,000	\$ 187,206	\$ 229,735	\$ 272,265	\$ 300,000	\$ 300,000
750,000	274,706	339,110	403,515	450,000	450,000
1,000,000	362,206	448,485	534,765	600,000	600,000
1,500,000	537,206	667,235	797,265	900,000	900,000
2,000,000	712,206	885,985	1,059,765	1,200,000	1,200,000
2,500,000	887,206	1,104,735	1,322,265	1,500,000	1,500,000
3,000,000	1,062,206	1,323,485	1,584,765	1,800,000	1,800,000

Note: The amounts shown above are applicable to employees retiring in 2004 at age 62.

Amounts shown as "earnings credited for retirement benefits" in this table represent the average annual covered compensation paid for the highest 36 consecutive months out of the last 120 months prior to retirement. For 2003, covered compensation for the individuals named in the Summary Compensation table (see "—Executive Compensation") is the same as the total of their salary and bonus amounts shown in that table. As of December 31, 2003, our named executive officers had the following years of credited service with the company: Mr. Fraizer, 23 years; Mr. Baldwin, 9 years; Mr. Mann, 30 years; Mr. Roday, 7 years; and Ms. Schutz, 25 years. The approximate annual retirement benefits provided under the GE retirement plans are payable in fixed monthly payments for life, with a guaranteed minimum term of five years.

216

### GE 1990 Long-Term Incentive Plan

Prior to this offering, some of our executive employees received stock options, SARs, RSUs and long-term contingent performance incentive awards under the GE 1990 Long-Term Incentive Plan. The following is a description of the treatment of those awards in connection with our initial public offering and our separation from GE.

*Vested GE stock options.* After the completion of this offering, all GE stock options that are vested and held by our employees (other than Mr. Fraizer's vested GE stock options) will remain exercisable in accordance with their terms and the GE 1990 Long-Term Incentive Plan. Each such GE stock option permits the holder, generally for a period of ten years from the date of grant or, if earlier, five years from the date that GE ceases to own 50% or more of our outstanding common stock, to purchase one share of GE stock from GE at the market price of GE stock on the date of grant. GE will remain responsible for the GE stock options of our employees that are vested on the date of this prospectus (other than Mr. Fraizer's vested GE stock options). We will have no obligations with respect to those options.

*Vested GE stock options of Mr. Fraizer, unvested GE stock options, SARs and RSUs.* On the date of this prospectus, all of Mr. Fraizer's GE stock options (whether or not vested) and all other GE stock options that are unvested and held by our employees as of such time will be canceled by GE and converted into options to purchase our Class A Common Stock based on a ratio equal to the initial offering price of our Class A Common Stock divided by the weighted-average stock price of GE common stock for the trading day immediately prior to the date of this prospectus (the "Conversion Ratio"). For purposes of this preliminary prospectus, the GE common stock price is assumed to be \$ per share, which was the closing price on April , 2004. These converted options, if unvested, generally will continue to vest in accordance with the terms of their original grants and the GE 1990 Long-Term Incentive Plan (generally in five equal annual installments from the first anniversary of the date of grant for options granted in 2002 and thereafter, or in two equal installments three and five years after they were originally granted for options granted before 2002) and generally will remain exercisable for a period of ten years from the date of original grant. Following cancellation of such GE stock options, GE will have no further liability with respect to these options, and we will be responsible for the converted options.

Mr. Fraizer is the only named executive officer who holds GE SARs that are exercisable for GE stock. These rights, which were granted in 2003, will be canceled by GE and converted into our SARs on the date of this prospectus based upon the Conversion Ratio. These converted SARs will continue to vest in accordance with the terms of their original grant and the GE 1990 Long-Term Incentive Plan (in five equal annual installments from the first anniversary of the date of original grant) and will remain exercisable for a period of ten years from the date of original grant.

On the date of this prospectus, all GE RSUs held by our employees (other than GE RSUs with restrictions that lapse on the date of this prospectus, as described in this paragraph) will be canceled by GE and converted into our RSUs based upon the Conversion Ratio and will generally have the same terms as their original grant and the GE 1990 Long-Term Incentive Plan. Such RSUs will entitle the holder to receive regular quarterly payments from us equal to the quarterly dividend on our stock. Also, provided the holder is still employed by us when the restrictions lapse, the holder will receive one share of our Class A Common Stock from us in exchange for each RSU. The restrictions on the converted RSUs granted in September 2003 will lapse in 50% increments after three and five years from the date of original grant. The restrictions on the GE RSUs granted in February 2003 to 21 senior executives will lapse in 50% increments, the first increment of GE RSUs on the date of this prospectus and the remaining increment of converted RSUs one year thereafter. The restrictions on most of the converted RSUs granted in 2002 will lapse in 25% increments after three, five and ten years from the date of original grant, with the final 25% lapsing at retirement. The restrictions on most of the converted RSUs granted before 2002 will lapse in 25% increments after three and seven years from the date of original grant, with the final 50% lapsing at retirement. Any converted RSUs as to

217

which restrictions have not lapsed will be forfeited if the executive leaves our company prior to the lapse of the restrictions.

GE will have no further liability with respect to the GE SARs and GE RSUs that are canceled by GE and converted into Genworth SARs and RSUs, respectively, and we will be responsible for the converted awards.

*GE long-term contingent performance awards.* In March 2003, the management development and compensation committee of GE's board of directors granted long-term contingent performance incentive awards to select GE executives for the 2003 to 2005 period to provide a continued emphasis on specified financial performance goals that the committee considered to be important contributors to GE's long-term shareowner value. The awards will only be payable if GE achieves, on an overall basis for the three-year 2003 to 2005 period, specified goals for one or more of the following four measurements, all as adjusted by the committee to remove the effects of unusual events and the effect of pensions on income: average earnings per share growth rate; average revenue growth rate; cumulative return on total capital; and cumulative cash generated. GE expects the awards to be payable in 2006 if the performance goals are met. The awards are subject to forfeiture if the executive's employment terminates for any reason other than disability, death, or retirement before December 31, 2005.

For purposes of determining eligibility for long-term contingent performance incentive awards granted to our executives in March 2003, employment with us will be deemed to be continued employment with GE (or an applicable GE affiliate). A prorated award (equal to one-third of the amount otherwise payable) will be paid by GE in 2006 when such awards are otherwise payable under the plan, provided the executives otherwise satisfy the conditions of the original award. We will not be liable for any such payments. The following table shows the multiple of our named executives' salary rate in effect and the annual bonus awarded in February 2003 that would be payable in 2006 under these awards if GE precisely attained the threshold, target, or maximum goals set by the committee for all applicable performance measurements and before taking into account the proration as described above:

	Performance period	Threshold payment	Target payment	Maximum payment
Michael D. Fraizer	1/03-12/05	1x	2x	2.5x
Thomas H. Mann	1/03-12/05	0.5x	1x	2x
Pamela S. Schutz	1/03-12/05	0.25x	0.5x	1x
K. Rone Baldwin	1/03-12/05	0.25x	0.5x	1x
Leon E. Roday	1/03-12/05	0.25x	0.5x	1x

Prior to the one-third proration described above, each measurement is weighted equally, and payments will be made for achieving any of the three goals (threshold, target or maximum) for any of the four measurements. For example, the executives in the table above would receive only one-quarter of the threshold payment if GE met at the end of the three-year period only a single threshold goal for a single measurement. Also, payments will be further prorated for performance that falls between goals.

#### Omnibus Incentive Plan

In connection with completion of this offering, subject to shareholder and board of director approval, we intend to establish the 2004 Genworth Financial, Inc. Omnibus Incentive Plan, which we refer to as the Genworth Omnibus Plan, pursuant to which we will administer the stock options, SARs and RSUs issued and cancelled by GE under the GE 1990 Long-Term Incentive Plan and replaced with our awards (see "—GE 1990 Long-Term Incentive Plan"). The Genworth Omnibus Plan will also permit us to issue stock-based, stock-denominated and other awards to employees, nonemployee directors and other individuals providing services to Genworth and our participating affiliates on and after the date of this prospectus. Available awards under the Genworth Omnibus Plan will include:

- stock options (but not incentive stock options under Section 422 of the Internal Revenue Code),

218

- SARs,
- restricted stock and RSUs (including performance shares and performance units),
- other awards valued in whole or in part by reference to or otherwise based on our common stock (other stock-based awards),
- nonemployee director awards (including DSUs),
- dividend equivalents, and
- cash-based awards.

The following is a description of the Genworth Omnibus Plan and the treatment of those awards to be made in connection with and after this offering and the concurrent offerings.

*Awards in connection with our initial public offering.* On the date of this prospectus, we anticipate granting to our executive officers an aggregate of \_\_\_\_\_ SARs and to some or all of our other employees nonqualified stock options to purchase an aggregate of \_\_\_\_\_ shares of our Class A Common Stock. The named executive officers will be granted SARs as follows: Mr. Fraizer, 1,900,000 SARs; Mr. Baldwin, 400,000 SARs; Mr. Mann, 680,000 SARs; Mr. Roday, 320,000 SARs; Ms. Schutz, 550,000 SARs; and the remaining executive officers, an aggregate of 2,260,000 SARs. The exercise price of these SARs and options will be equal to the initial offering price. These SARs and options will vest in 25% annual increments commencing on the second anniversary of the date of grant.

Each of these SARs permits the executive officer to receive an amount equal to the difference between the SAR exercise price and the fair market value of one share of our Class A Common Stock on the date the SAR is exercised. The amount of this difference, multiplied by the number of SARs exercised, is payable and delivered in shares of our Class A Common Stock. We anticipate that after the initial grant in connection with our initial public offering, we will issue annual grants to our executives and periodic grants to our other employees under the Genworth Omnibus Plan subject to the approval of our Management Development and Compensation Committee.

Under the Genworth Omnibus Plan, we also anticipate granting RSUs in 2005 to our executive officers contingent upon the achievement of one or both of the following performance goals for the 2004 performance year. The performance goals are positive annual net earnings as determined under U.S. GAAP, which we refer to as Net Earnings, and positive annual earnings from continuing operations before income taxes and accounting changes as determined under U.S. GAAP, which we refer to as Consolidated Operating Earnings. Our chief executive officer is eligible for an award of RSUs under the Genworth Omnibus Plan equal in value on the date of grant to up to one percent (1.0%) of the greater of Net Earnings or Consolidated Operating Earnings, and each of our other executive officers is eligible for an award of RSUs under the Genworth Omnibus Plan equal in value on the date of grant to up to one-half of one percent (0.5%) of the greater of Net Earnings or Consolidated Operating Earnings. However, in no event will any participant receive grants of RSUs that exceed the annual award limit under the Genworth Omnibus Plan, and the management development and compensation committee of GE's board of directors (or, for purposes of Section 162(m) of the Internal Revenue Code, its successor) has absolute discretion to reduce or eliminate the value of the RSUs to be awarded to our executive officers.

Under the Genworth Omnibus Plan, we also anticipate granting, subject to shareholder approval, long-term performance awards to our executive officers for the 2004 to 2006 period. The awards will only be payable if we achieve, on an overall basis for such period, specified goals for average annual return on equity growth or average annual operating earnings growth, or both, each as adjusted by our Management Development and Compensation Committee, to remove the effects of unusual events. We expect to pay these awards in the first quarter of 2007 in cash, our Class A Common Stock, or both, as determined by our Management Development and Compensation Committee, if the performance goals are met. The awards will be subject to forfeiture if the executive's employment terminates for any reason other than disability, death, or retirement before December 31, 2006.

219

The following table shows the multiple of the named executives' salary rate as of March 1, 2004 and the most recent annual bonus awarded by GE prior to the completion of this offering that would be payable in 2007 under these awards if we precisely attained the threshold, target, or maximum goals set by our Management Development and Compensation Committee for all applicable performance measurements:

	Performance period	Threshold payment	Target payment	Maximum payment
Michael D. Fraizer	01/04-12/06	1x	2x	2.5x
Thomas H. Mann	01/04-12/06	0.5x	1x	2x
Pamela S. Schutz	01/04-12/06	0.5x	1x	2x
K. Rone Baldwin	01/04-12/06	0.5x	1x	2x
Leon E. Roday	01/04-12/06	0.25x	0.5x	1x

Each measurement is weighted equally, and payments will be made for achieving any of the three goals (threshold, target or maximum) for any of the two measurements. For example, the executives in the table above would receive only one-half of the threshold payment if we met at the end of the three-year period only a single threshold goal for a single measurement. Also, payments will be prorated for performance that falls between goals.

*Effective date and term.* The Genworth Omnibus Plan will become effective on the date of this prospectus, subject to shareholder and board of director approval, and will authorize the granting of awards for a term of up to 10 years.

*Administration.* The Genworth Omnibus Plan will be administered by our Management Development and Compensation Committee. The Management Development and Compensation Committee will be able to select eligible participants to whom awards are granted; determine the types of awards to be granted and the number of shares covered by such awards; set the terms and conditions of such awards (including any terms and conditions relating to a change of control of our company); and cancel, suspend, and amend awards. The Management Development and Compensation Committee's determinations and interpretations under the Genworth Omnibus Plan will be binding on all interested parties. The Management Development and Compensation Committee will be empowered to delegate to one or more of its members, to one or more officers of our company or its affiliates, or to one or more agents or advisors such administrative duties or powers it may deem advisable. In addition, subject to certain restrictions, the Management Development and Compensation Committee may, by resolution, authorize one or more officers of our company to (i) designate employees and other individuals providing services to Genworth and our participating affiliates to receive awards and (ii) determine the terms and conditions of such awards.

*Eligibility.* Awards under the Genworth Omnibus Plan may be granted to employees, nonemployee directors and other individuals providing services to Genworth and our participating affiliates.

*Number of shares available for issuance.* Subject to adjustment as described below, 38,000,000 shares of our Class A Common Stock (including authorized and unissued shares and treasury shares) will be available for granting awards under the Genworth Omnibus Plan. The GE awards (including Mr. Fraizer's GE stock options (whether or not vested) and all other GE stock options that are unvested, GE SARs and GE RSUs) replaced with our awards in connection with the completion of this offering will be deemed granted under the Genworth Omnibus Plan. We anticipate the number of shares of our Class A Common Stock subject to such converted stock options, SARs and RSUs will be , and , respectively. If any shares subject to any award under the Genworth Omnibus Plan are forfeited, or if any such award terminates or is settled without the delivery of shares, the shares previously used or reserved for such awards will be available for future awards under the Genworth Omnibus Plan.

220

*Adjustments.* In the event of corporate event or transaction such as a stock split, stock dividend, or other extraordinary corporate event, the Management Development and Compensation Committee will be able to adjust the number and type of shares which may be made the subject of new awards or are then subject to outstanding awards and other award terms. The Management Development and Compensation Committee will also be authorized, for similar purposes, to make adjustments in performance award criteria or in the terms and conditions of other awards in recognition of unusual or nonrecurring events affecting our company or our financial statements or of changes in applicable laws, regulations, or accounting principles. The awards that may be granted under the Genworth Omnibus Plan after the effective date of the Genworth Omnibus Plan cannot presently be determined. In addition, nothing contained in the Genworth Omnibus Plan will prevent us or any affiliate from adopting or continuing in effect other or additional compensation arrangements.

*Awards.* Awards generally will be granted for no cash consideration. We intend that, under the Genworth Omnibus Plan, awards may provide that upon exercise the participant will receive cash, stock, other securities, other awards, other property, or any combination thereof, as the Management Development and Compensation Committee will determine. Except in the case of GE awards converted to Genworth awards, the exercise price per share of Class A Common Stock purchasable under any stock option, the grant price of any SAR, and the purchase price of any security which may be purchased under any other stock-based award will be not less than 100% of the fair market value of the stock or other security on the date of the grant of such option, SAR, or right, or, if the Management Development and Compensation Committee so determines, in the case of certain awards retroactively granted in tandem with or in substitution for other awards under the Genworth Omnibus Plan or for any other outstanding awards, on the date of grant of such other awards. It is intended that, under the Genworth Omnibus Plan, any exercise or purchase price may be paid in cash or, if permitted by the Management Development and Compensation Committee, by surrender of shares.

*Annual award limits.* The awards which may be granted under the Genworth Omnibus Plan are generally subject to the following limits (each, an "Annual Award Limit"). The maximum number of our shares of Class A Common Stock with respect to which stock options or SARs may be granted or measured to any participant in a calendar year is 5,000,000 shares. The maximum number of our shares of Class A Common Stock with respect to which restricted stock or RSUs may be granted or measured to any participant in any calendar year is 2,000,000 shares. The maximum number of our shares of Class A Common Stock with respect to which other stock-based awards, not otherwise described in the Genworth Omnibus Plan, may be granted or measured to any participant in any calendar year is 1,000,000 shares. The maximum amount that may be paid or credited to any executive officer whom the Management Development and Compensation Committee identifies as a potential "covered employee" subject to Section 162(m) of the Internal Revenue Code (a "Covered Employee") in any calendar year in respect of a Covered Employee annual incentive award is \$5,000,000. The maximum amount of any cash-based awards that may be paid, credited or vested to any participant in any calendar year is \$10,000,000. These provisions are designed so that compensation resulting from awards can qualify as tax deductible performance-based compensation under Section 162(m) of the Internal Revenue Code.

*Stock options.* A participant granted an option will be entitled to purchase a specified number of shares of Class A Common Stock during a specified term at a fixed price, affording the participant an opportunity to benefit from the appreciation in the market price of our stock from the date of grant.

*SARs.* A participant granted a SAR will be entitled to receive the excess of the fair market value (calculated as of the exercise date) of a share of our Class A Common Stock over the grant price of the SAR in cash, our shares of Class A Common Stock, a combination thereof, or any other manner approved by the Management Development and Compensation Committee in its sole discretion. The terms and conditions of any SARs will be determined by the Management Development and Compensation Committee at the time of grant.

221



*Restricted stock and RSUs.* Restricted stock and RSUs are awards that will be non-transferable and subject to a risk of forfeiture upon certain kinds of employment terminations, as determined by the Management Development and Compensation Committee, during a restricted period specified by the Management Development and Compensation Committee. Restricted stock will provide a participant with all of the rights of a share owner of our company, including the right to vote the shares and to receive dividends, at the end of a specified period. An RSU will represent a right to receive a share of Class A Common Stock, or an equivalent value as the Management Development and Compensation Committee may determine, together with dividend equivalent payments in cash or as additional shares if specified by the Management Development and Compensation Committee, at the end of a specified period. After lapse of these restrictions, settlement of RSUs may be further deferred. Restricted stock and RSUs may be awarded, or their restrictions may lapse, based upon achievement of a pre-established performance goal as described below and are referred to as performance shares and performance units, respectively. The Management Development and Compensation Committee will have discretion to vary the forfeiture conditions of restricted stock and RSUs. RSUs will be settled in cash, shares, other securities, additional awards or any combination of the foregoing, as determined by the Management Development and Compensation Committee.

*Other stock-based awards.* Other stock-based awards are awards for which the Management Development and Compensation Committee will establish virtually all terms and conditions.

*Nonemployee director awards.* Nonemployee director awards are awards to nonemployee directors for which the Management and Development Compensation Committee will establish virtually all terms and conditions, and includes awards granted in satisfaction of annual fees that are otherwise payable to nonemployee directors, such as DSUs. See "—Director Compensation" for a description of DSUs. The maximum number of our shares of Class A Common Stock that may be issued as nonemployee director awards is 1,000,000 shares, and the maximum number of our shares of Class A Common Stock with respect to which nonemployee director awards may be granted or measured to any nonemployee director in any calendar year is 25,000 shares.

*Dividend equivalents.* Dividend equivalents granted to participants will represent a right to receive payments equivalent to dividends or interest with respect to a specified number of shares.

*Cash-based awards.* Cash-based awards are awards for which the Management Development and Compensation Committee will establish virtually all terms and conditions. For example, the three-year contingent long-term performance award which we intend to grant as described above under "—Omnibus Incentive Plan—Awards in connection with our initial public offering" will represent a contingent right to receive a payment, the amount of which would be a multiple of the salary rate as of March 1, 2004 and the most recent annual bonus awarded by GE prior to the completion of this offering. The percentage, if any, of such compensation to be used to determine the amount payable under the performance award will be contingent upon the extent of achievement of the pre-established performance goals during the three-year period. Under a long-term performance award, the Management Development and Compensation Committee will determine, after the end of the performance period, whether a participant has become entitled to a settlement of his or her performance award, and whether that settlement will be paid in cash, a distribution of shares of Class A Common Stock, or crediting of stock units, provided that the Management Development and Compensation Committee may permit the participant to elect the form of settlement for all or a portion of the award.

*Performance-based compensation.* One type of performance-based compensation award is the Covered Employee incentive award. See "—Incentive Compensation Program" for a description of such award. In addition, the Management Development and Compensation Committee may design any award so that the granting, vesting, crediting and/or payment of such award meets the requirements for performance-based compensation. The performance goals to be established by the Management Development and Compensation Committee for performance-based compensation may be based on any

222

---

or all of the following measures applicable to our company, its affiliates, or any of their business units: net earnings or net income (before or after taxes); earnings growth; earnings per share; net sales (including net sales growth); gross profits or net operating profit; return measures (including, but not limited to, return on assets, capital, equity, or sales); cash flow (including, but not limited to, operating cash flow, free cash flow, cash flow return on capital and statutory cash measures); revenue growth; earnings before or after taxes, interest, depreciation, and/or amortization; productivity ratios; share price (including, but not limited to, growth measures and total shareholder return); expense targets; margins (including, but not limited to, gross or operating margins); operating efficiency; customer satisfaction or increase in the number of customers; attainment of budget goals; division working capital turnover; market share; cost reductions; working capital targets; and EVA® and other value-added measures.

*Change of control.* Unless the Management Development and Compensation Committee determines otherwise or unless otherwise specifically prohibited under applicable laws or by the rules and regulations of any governing governmental agencies or stock exchange on which shares of our Class A Common Stock are listed, (1) in the event of a change of control (as defined in the Genworth Omnibus Plan) in which a successor entity fails to assume and maintain awards under the Genworth Omnibus Plan, and (2) in the case of awards which we intend to grant as described above under "—Omnibus Incentive Plan—Awards in connection with our initial public offering" and GE stock options, GE SARs and GE RSUs granted in September 2003, which will be canceled by GE and replaced with our stock options, SARs and RSUs, respectively, as described above under "—GE 1990 Long-Term Incentive Plan—Vested GE stock options of Mr. Fraizer, unvested GE stock options, SARs and RSUs," in the event of a change of control in which a successor entity assumes and maintains awards under the Genworth Omnibus Plan but the participant's service with us and our affiliates is terminated without cause or for good reason within 12 months following the effective date of such change of control:

- Awards, the vesting of which depends upon a participant's continuation of service for a period of time, will fully vest as of the effective date of the change of control, will be distributed or paid to the participant, and will thereafter terminate.
- Awards, the vesting of which is based on achievement of performance criteria (other than the Covered Employee annual incentive awards), will fully vest as of the effective date of the change of control, will be deemed earned based on the target performance being attained for the performance period in which the change of control occurs, will be distributed or paid to the participant pro rata based on the portion of the performance period elapsed on the date of the change of control, and will thereafter terminate.
- Covered Employee annual incentive awards will be based on the Consolidated Operating Earnings or Net Earnings of the calendar year in which the change of control occurs (or such other method of payment as may be determined by the Management Development and Compensation Committee at the time of such award or thereafter but prior to the change of control), will be distributed or paid to the participant pro rata based on the portion of the year elapsed on the date of the change of control, and will thereafter terminate.

The foregoing change of control provisions do not apply to the GE RSUs (other than those granted in September 2003), which will be canceled by GE and replaced with our RSUs.

*Deferrals.* The Management Development and Compensation Committee also will be able to require or permit award payments to be deferred and may authorize crediting of dividends or interest or their equivalents in connection with any such deferral.

223

---

*Transferability.* Awards generally will be non-transferable except upon the death of a participant, although the Management Development and Compensation Committee

may permit a participant to transfer awards subject to such conditions as the Management Development and Compensation Committee may establish.

### ***Tax consequences***

The following is a summary of the principal U.S. federal income tax consequences of transactions under the Genworth Omnibus Plan, based on current U.S. federal income tax laws. This summary is not intended to be exhaustive, does not constitute tax advice and, among other things, does not describe state, local or foreign tax consequences.

***Nonqualified options.*** No taxable income is realized by a participant upon the grant of an option. Upon the exercise of an option, the participant will recognize ordinary compensation income in an amount equal to the excess, if any, of the fair market value of the shares of Class A Common Stock received over the aggregate option exercise price (the spread), even though that common stock may be subject to a restriction on transferability or may be subsequently forfeited, in limited circumstances. Income and payroll taxes are required to be withheld by the participant's employer on the amount of ordinary income resulting to the participant from the exercise of an option. The spread is generally deductible by the participant's employer for federal income tax purposes, subject to the possible limitations on deductibility of compensation paid to some executives under Section 162(m) of the Internal Revenue Code. The participant's tax basis in shares of common stock acquired by exercise of an option will be equal to the exercise price plus the amount taxable as ordinary income to the participant.

Upon a sale of the shares of Class A Common Stock received by the participant upon exercise of the option, any gain or loss will generally be treated for federal income tax purposes as long-term or short-term capital gain or loss, depending upon the holding period of that stock. The participant's holding period for shares acquired after the exercise of an option begins on the date of exercise of that option.

If the participant pays the exercise price in full or in part by using shares of previously acquired Class A Common Stock, the exercise will not affect the tax treatment described above and no gain or loss generally will be recognized to the participant with respect to the previously acquired shares. The shares received upon exercise which are equal in number to the previously acquired shares used will have the same tax basis as the previously acquired shares surrendered to us, and will have a holding period for determining capital gain or loss that includes the holding period of the shares used. The value of the remaining shares received by the participant will be taxable to the participant as compensation, even though those shares may be subject to sale restrictions. The remaining shares will have a tax basis equal to the fair market value recognized by the participant as compensation income and the holding period will commence on the exercise date. Shares used to pay applicable income and payroll taxes arising from that exercise will generate taxable income or loss equal to the difference between the tax basis of those shares and the amount of income and payroll taxes satisfied with those shares. The income or loss will be treated as long-term or short-term capital gain or loss depending on the holding period of the shares used. Where the shares used to pay applicable income and payroll taxes arising from that exercise generate a loss equal to the difference between the tax basis of those shares and the amount of income and payroll taxes satisfied with those shares, that loss may not be currently recognizable if, within a period beginning 30 days before the exercise date and ending 30 days after that date, the participant acquires or enters into a contract or option to acquire additional common stock.

***SARs.*** The grant of a SAR will create no tax consequences for the participant or us. Upon the exercise of a SAR, the participant will recognize compensation income, in an amount equal to the cash or the fair market value of the Class A Common Stock received from the exercise. The participant's tax basis in the shares of Class A Common Stock received in the exercise of the SAR will be equal to the compensation income recognized with respect to the Class A Common Stock. The participant's holding

---

period for shares acquired after the exercise of a SAR begins on the exercise date. Income and payroll taxes are required to be withheld on the amount of compensation attributable to the exercise of the SAR, whether the income is paid in cash or shares. Upon the exercise of a SAR, we generally will be entitled to a deduction in the amount of the compensation income recognized by the participant.

***Other awards.*** Other awards under the Genworth Omnibus Plan, including restricted stock, RSUs and performance awards, generally will result in ordinary income to the participant at the later of the time of delivery of cash, shares or other property, or (in the absence of an appropriate election) the time that either the risk of forfeiture or restriction on transferability lapses on previously delivered cash, shares or other property. We generally would be entitled to a tax deduction equal to the amount recognized as ordinary income by the participant in connection with an award.

***Certain limitations on deductibility of executive compensation.*** With some exceptions, Section 162(m) of the Internal Revenue Code limits our deduction to us for compensation paid to employees in excess of \$1 million per executive per taxable year. However, compensation paid to employees will not be subject to that deduction limit if it is considered "qualified performance-based compensation" within the meaning of Section 162(m) of the Internal Revenue Code. Compensation to be paid to employees under the Genworth Omnibus Plan is generally intended to be qualified performance-based compensation.

***Amendment and termination.*** The Genworth Omnibus Plan may be amended or terminated by our board of directors at any time, subject to certain limitations, and the awards granted under the plan may be amended or terminated by the Management Development and Compensation Committee at any time, provided that no such action may, without a participant's written consent, adversely affect in any material way any previously granted award, and no amendment that would require shareholder approval under applicable law may become effective without shareholder approval.

### **Incentive Compensation Program**

We anticipate that our key employees (including officers) will be covered by the GE Incentive Compensation Plan (the "GE IC Plan") until the date that GE ceases to own more than 50% of our outstanding common stock, although the performance measures will be specifically based on our company-specific and individual-specific performance measures subject to the approval of the management development and compensation committee of GE's board of directors. For 2004, the performance goals for our executive officers are Net Earnings and Consolidated Operating Earnings. Our chief executive officer is eligible for an award under the GE IC Plan of up to one percent (1.0%) of the greater of Net Earnings or Consolidated Operating Earnings, and each of our other executive officers is eligible for an award under the GE IC Plan of up to one-half of one percent (0.5%) of the greater of Net Earnings or Consolidated Operating Earnings. However, in no event will any participant receive an award greater than one percent (1.0%) of Net Earnings or Consolidated Operating Earnings, or the total amount available under the terms of the GE IC Plan, and the management development and compensation committee of GE's board of directors (or, for purposes of Section 162(m) of the Internal Revenue Code, its successor) has absolute discretion to reduce or eliminate the amount of incentive compensation to be awarded to our executive officers.

Prior to the completion of this offering, we intend to establish, subject to shareholder and board of director approval, an incentive compensation program or programs (the "Genworth IC Program"), which may be part of the Genworth Omnibus Plan, and provide our key employees (including officers) with the opportunity to earn annual incentives based on company-wide, business unit and individual performance measures, although the Genworth IC Program will not become effective until the date that GE ceases to own more than 50% of our outstanding common stock. Until the date that GE ceases to own more than 50% of our outstanding common stock, GE will pay incentive compensation awards to our employees under the GE IC Plan, and we will reimburse GE for its cost of such awards.

---

Under the Genworth IC Program, the annual incentive compensation payment in any calendar year to a Covered Employee will be based on a percentage of one or both of (1) our Net Earnings for the calendar year, and (2) our Consolidated Operating Earnings for the calendar year. Our Management Development and Compensation Committee

retains absolute discretion to adjust these awards downward. We refer to these awards as Covered Employee incentive awards.

The following summary relates to the GE IC Plan:

*Reserve.* The GE IC Plan authorizes its board of directors to appropriate to an Incentive Compensation Reserve (the "Reserve") each year an amount based on the consolidated net earnings of the company. The maximum amount that may be appropriated for this Reserve in any year is 10% of the amount by which consolidated net earnings exceed 5% of average capital investment, each as defined in the GE IC Plan. Any amounts in the Reserve appropriated but not awarded in any year may be carried forward and used for future awards.

*Administration.* The management development and compensation committee of GE's board of directors determines eligibility for participation in the GE IC Plan, the aggregate amount to be awarded from the Reserve in any year, and the specific amount to be awarded to any executive officer upon the achievement of a performance goal or goals.

*Eligibility.* Incentive compensation allotments are granted to key employees (including officers) of GE and its affiliates.

*Payment of allotments.* Incentive compensation allotments under the GE IC Plan are paid as soon as practicable following award, except that participants may elect to defer all or part of their allotment. The management development and compensation committee of GE's board of directors may determine that portions of deferred allotments are forfeitable for activity deemed to be harmful to the interests of GE or its affiliates occurring either during employment or after termination.

*Method of accounting for deferred allotments.* Participants may elect to have deferred allotments (including deferred allotments after termination of employment) accounted for as (i) GE stock units, (ii) the Standard and Poor's 500 Stock Index (S&P Index) units or (iii) cash units. The value of a GE stock unit will be equal to the average of the closing price of GE common stock as reported on the consolidated tape of New York Stock Exchange Listed Securities for the twenty trading days immediately preceding the date of allotment. The value of an S&P Index unit is equal to the average value of such unit as reported by Standard and Poor's for the twenty trading days immediately preceding the date of allotment. Deferred allotments, to the extent accounted for as GE stock units or S&P Index units, are credited with dividend equivalents applicable to such accounting media, and deferred allotments accounted for as cash units are credited with interest equivalents.

*Switching.* A participant may elect up to four times a year to change the method or methods of accounting for all deferred allotments.

*Method of payment.* The portion if any of an allotment not made on a deferred payment basis may, in the discretion of the management development and compensation committee of GE's board of directors, be made wholly or partly in cash, GE common stock, other securities, or any combination thereof. The deferred allotment is paid following the termination of a participant's employment with GE and its affiliates, subject to the terms and conditions, and in accordance with the procedures, of the GE IC Plan. The management development and compensation committee of GE's board of directors has discretionary authority to pay any installment of any deferred allotment entirely in cash or in such other manner as it may specify.

*Termination and amendment.* The GE IC Plan may be amended or terminated by GE's board of directors at any time, without the approval of shareholders or participants, provided that no action may, without a participant's consent, apply to the payment to the participant of any allotment made to such participant prior to the effective date of such action and no amendment may be made which will

226

---

increase the amount which may be appropriated to the Reserve under the GE IC Plan without stockholder approval.

*Section 162(m).* Compensation to be paid to the applicable employees under the GE IC Plan is intended to be qualified performance-based compensation within the meaning of Section 162(m) of the Internal Revenue Code.

#### **Executive Deferred Salary Plan**

Our named executive officers, other executives and top managers currently participate in various GE executive deferred salary plans in effect between 1991 and 2003. Under all these plans, salary deferrals are contingently credited by GE with 9.5% to 14% interest. The participants generally must remain employed by GE and its affiliates for at least four years following the deferral, or retire or transfer to a successor employer (in this case, including Genworth when GE ceases to own 50% or more of our outstanding common stock) after a year of deferral, in order to obtain the stated interest rate on salary deferrals, otherwise the applicable interest rate on salary deferrals will be 0% to 3% interest. We are deemed an affiliate of GE for so long as GE owns 50% or more of our outstanding common stock. The Summary Compensation table (see "—Executive Compensation") includes the difference between market interest rates determined pursuant to SEC regulations and the contingently credited interest on such salary deferrals.

#### **Other Potential Arrangements**

Management has an understanding with GE that, shortly after the completion of our initial public offering, management intends to ask our Management Development and Compensation Committee and our board of directors to consider implementing arrangements which will protect or otherwise compensate management in the event of a change in control of our company.

227

---

### **Arrangements Between GE and Our Company**

#### **Relationship with GE**

Historically, GE has provided a variety of products and services to us, and we have provided various products and services to GE. These arrangements are described below under "—Historical Related-Party Transactions."

Prior to the completion of this offering, we will enter into a master agreement and a number of other agreements with GE for the purpose of accomplishing our separation from GE, transferring the businesses described in this prospectus to us and setting forth various matters governing our relationship with GE while GE remains a significant stockholder in our company. These agreements will govern the relationship between GE and us after our initial public offering and will provide for the allocation of employee benefit, tax and other liabilities and obligations attributable or related to periods or events prior to and in connection with our initial public offering. In addition, a number of the existing agreements between us and our subsidiaries and GE and its subsidiaries relating to various aspects of our business will remain in effect following our initial public offering. The agreements summarized below have been filed as exhibits to the registration statement of which this prospectus forms a part. The summaries of these agreements are qualified in their entirety by reference to the full text of the agreements.

## *Master Agreement*

We will enter into a master agreement with GE prior to the completion of this offering. We refer to this agreement in this prospectus as the Master Agreement. The Master Agreement will set forth our agreements with GE regarding the principal transactions required to effect the transfer of assets and the assumption of liabilities necessary to separate our company from GE. It also will set forth other agreements governing our relationship after the separation.

### *The separation*

To effect the separation, GE will, and will cause its affiliates to, transfer to us the assets related to our businesses as described in this prospectus. We or our subsidiaries will assume and agree to perform, discharge and fulfill the liabilities related to our businesses (which, in the case of tax liabilities, will be governed by the Tax Matters Agreement) in accordance with their terms. Most of these transfers will be effected by a transfer of stock held by GE's subsidiaries to us. If any governmental approval or other consent required to transfer any assets to us or for us to assume any liabilities is not obtained prior to the completion of this offering, we will agree with GE that such transfer or assumption will be deferred until the necessary approvals or consents are obtained. GE will continue to hold the assets and be responsible for the liabilities for our benefit and at our expense until the necessary approvals or consents are obtained. For a discussion of certain assets and liabilities, the transfer and assumption of which are expected to be deferred until after completion of this offering, see "*Reinsurance Transactions—European Payment Protection Insurance Business Arrangements.*"

In consideration for the assets that we will acquire and the liabilities that we will assume in connection with our corporate reorganization, we will issue to GEFAHI million shares of our Class B Common Stock, \$600 million of our Equity Units, \$100 million of our Series A Preferred Stock, the \$2.4 billion Short-term Intercompany Note and the \$550 million Contingent Note.

Except as expressly set forth in the Master Agreement or in any other transaction document, neither we nor GE will make any representation or warranty as to:

- the assets, businesses or liabilities transferred or assumed as part of the separation;
- any consents or approvals required in connection with the transfers;
- the value, or freedom from any security interests, of, or any other matter concerning, any assets transferred;

228

- 
- the absence of any defenses or right of set-off or freedom from counterclaim with respect to any claim of either us or GE; or
  - the legal sufficiency of any document or instrument delivered to convey title to any asset transferred.

Except as expressly set forth in any transaction document, all assets will be transferred on an "as is," "where is" basis, and we and our subsidiaries will agree to bear the economic and legal risks that any conveyance was insufficient to vest in us good title, free and clear of any security interest, and that any necessary consents or approvals are not obtained or that any requirements of laws or judgments are not complied with.

### *Financial information*

We will agree that, for so long as GE owns shares of our common stock, we will provide GE with quarterly and annual historical financial information needed by GE to issue its own earnings releases and public filings. We also will agree that for so long as GE owns at least 5% of our outstanding common stock, we will provide GE with certain financial projections. We further agree that, for so long as GE owns more than 20% of our outstanding common stock (or is required to account for its investment in us on a consolidated basis or under the equity method of accounting), we will provide GE with information requested by GE in connection with its press releases and public filings and advance notice of all meetings to be held by us with financial analysts. We will also agree during this time to issue our quarterly and annual earnings releases and file our quarterly and annual reports with the SEC immediately following the time that GE issues its quarterly and annual earnings releases and files its quarterly and annual reports with the SEC. For so long as GE owns more than 50% of our outstanding common stock (or is required to account for its investment in us on a consolidated basis), in addition to the items described above, we will agree to provide GE with monthly historical financial information, access to our books and records so that it may conduct audits of our financial statements, notice of any proposed material changes in our accounting estimates or discretionary accounting principles, a quarterly representation of our chief executive officer and our chief financial or accounting officer as to the accuracy and completeness of our financial and accounting records and copies of correspondence with and reports submitted by our accountants.

We also will agree, for so long as GE owns more than 50% of our outstanding common stock (or is required to account for its investment in us on a consolidated basis), to conduct our strategic and operational review process on the same schedule on which GE conducts its strategic and operational review process. GE has agreed that it will conduct its strategic and operational reviews of our business through the involvement in such process of the members of our board of directors who are elected by GE in its capacity as the beneficial holder of the Class B Common Stock, as well as others invited at GE's request.

### *Exchange of other information*

The Master Agreement will also provide for other arrangements with respect to the mutual sharing of information between us and GE in order to comply with reporting, filing, audit or tax requirements, for use in judicial proceedings, and in order to comply with our respective obligations after the completion of this offering. We will also agree to provide mutual access to historical records relating to businesses that may be in our possession.

### *Releases and indemnification*

Except for each party's obligations under the Master Agreement, the other transaction documents and certain other specified liabilities, we and GE will release and discharge each other and each of our affiliates from all liabilities existing or arising between us on or before the separation, including in connection with the separation and our initial public offering. The release will not extend to obligations or liabilities under any agreements between us and GE that remain in effect following the separation.

229

---

We will indemnify, hold harmless and defend GE, each of its affiliates and each of their respective directors, officers and employees, on an after-tax basis, from and against all liabilities relating to, arising out of or resulting from:

- the failure by us or any of our affiliates or any other person or entity to pay, perform or otherwise promptly discharge any liabilities or contractual obligations associated with our businesses, whether arising before or after the separation;

- the operations, liabilities and obligations of our business;
- any guarantee, indemnification obligation, surety bond or other credit support arrangement by GE or any of its affiliates for our benefit;
- any breach by us or any of our affiliates of the Master Agreement, certain of the other transaction documents or our certificate of incorporation or by-laws;
- any untrue statement of, or omission to state, a material fact in GE's public filings to the extent it was as a result of information that we furnished to GE or which GE incorporated by reference from our public filings, if that statement or omission was made or occurred after the separation; and
- any untrue statement of, or omission to state, a material fact in any registration statement or prospectus related to our initial public offering, the Equity Units offering, the Series A Preferred Stock offering or the senior notes offering, except to the extent the statement was made or omitted in reliance upon information provided to us by GE expressly for use in any such registration statement or prospectus or information relating to and provided by any underwriter expressly for use in any such registration statement or prospectus.

GE will indemnify, hold harmless and defend us, each of our affiliates and each of our and their respective directors, officers and employees, on an after-tax basis, from and against all liabilities relating to, arising out of or resulting from:

- the failure of GE or any affiliate of GE or any other person or entity to pay, perform or otherwise promptly discharge any liabilities of GE or its affiliates other than liabilities associated with our businesses, whether arising before or after the separation;
- the liabilities of GE and its affiliates' businesses other than liabilities associated with our businesses;
- any breach by GE or any of its affiliates of the Master Agreement or certain of the other transaction documents;
- any untrue statement of, or omission to state, a material fact in our public filings to the extent it was as a result of information that GE furnished to us or which we incorporated by reference from GE's public filings (other than any registration statement or prospectus related to our initial public offering, the Equity Units offering, the Series A Preferred Stock offering or the senior notes offering); and
- any untrue statement of, or omission to state, a material fact contained in any registration statement or prospectus related to our initial public offering, the Equity Units offering, the Series A Preferred Stock offering or the senior notes offering, but only to the extent the untrue statement or omission was made or omitted in reliance upon information provided by GE expressly for use in any such registration statement or prospectus.

The Master Agreement will also specify procedures with respect to claims subject to indemnification and related matters and provide for contribution in the event that indemnification is not available to an indemnified party.

#### *Expenses of the separation and our initial public offering*

GE will pay or reimburse us for all out-of-pocket fees, costs and expenses (including all legal, accounting and printing expenses) incurred prior to the completion of our initial public offering in connection with our separation from GE and our initial public offering, the Equity Units offering, the Series A Preferred Stock offering and the senior notes offering, and in connection with the other debt and credit facilities described in this prospectus that we have entered into or intend to incur or enter into concurrently with or shortly after the completion of this offering.

#### *GE's use of restricted marks and certain other commercial arrangements*

GE has generally agreed for five years after this offering not to use the "GE" mark or the "GE" monogram or the name "General Electric" in connection with the marketing or underwriting on a primary basis of life insurance, long-term care insurance, annuities, or worksite benefits insurance in the U.S., or of auto insurance products in Mexico, and the underwriting or issuing of mortgage insurance products anywhere in the world. GE's agreement to restrict the use of its brand will terminate earlier upon the occurrence of certain events, including termination of our transitional trademark license agreement with GE and our discontinuation of the use of the "GE" mark or the "GE" monogram. In addition, GE has agreed generally to distribute on an exclusive basis our payment protection insurance products in certain European countries for five years, unless earlier terminated. See "Business—Protection—European Payment Protection Insurance."

#### *Dispute resolution procedures*

We will agree with GE that neither party will commence any court action to resolve any dispute or claim arising out of or relating to the Master Agreement. Instead, any dispute that is not resolved in the normal course of business will be submitted to senior executives of each business entity involved in the dispute for resolution. If the dispute is not resolved by negotiation within 45 days, either party may submit the dispute to mediation. If the dispute is not resolved by mediation within 30 days of the selection of a mediator, either party may submit the dispute to binding arbitration before a panel of three arbitrators. The arbitrators will determine the dispute in accordance with New York law. Most of the other agreements between us and GE have similar dispute resolution provisions.

These dispute resolution procedures will not apply to any dispute or claim related to GE's rights as a holder of our Class B Common Stock, including its approval rights over certain corporate actions by us that are set forth in our certificate of incorporation, and both parties will submit to the exclusive jurisdiction of the Delaware courts for resolution of any such dispute. In addition, both parties will be permitted to seek injunctive or interim relief in the event of any actual or threatened breach of the provisions of the Master Agreement relating to confidentiality, use of restricted marks and composition of certain of our board committees, and any of the provisions of the Employee Matters Agreement, Registration Rights Agreement, Intellectual Property Cross-License or the Transitional Trademark License Agreement. If an arbitral tribunal has not been appointed, both parties may seek injunctive or interim relief from any court with jurisdiction over the matter.

#### *Other provisions*

The Master Agreement also will contain covenants between us and GE with respect to:

- confidentiality of our and GE's information;
- our right to continue coverage under GE's insurance policies for so long as GE owns more than 50% of our outstanding common stock;
- restrictions on our ability to take any action or enter into any agreement that would cause GE to violate any law, agreement or judgment;
- restrictions on our ability to take any action that limits GE's ability to freely sell, transfer, pledge or otherwise dispose of our stock;

- our obligation to comply with GE's policies applicable to its subsidiaries for so long as GE owns more than 50% of our outstanding common stock, except (1) to the extent such policies conflict with our certificate of incorporation or bylaws or any of the agreements between us and GE, or (2) as otherwise agreed with GE or superseded by any policies adopted by our board of directors.;
- restrictions on our ability to enter into any agreement that binds or purports to bind GE;
- litigation and settlement cooperation between us and GE;
- GE's right to appoint one member of our Management Development and Compensation Committee and one member of our Nominating and Corporate Governance Committee for so long as GE owns more than 50% of our outstanding common stock; and
- proposed intercompany transactions, including material amendments to the agreements accomplishing our separation from GE, all of which must be approved by a majority of our independent directors.

#### ***Transition Services Agreement***

We will enter into a transition services agreement with GE prior to the completion of this offering to provide each other, on a transitional basis, certain administrative and support services and other assistance in the U.S. consistent with the services provided before the separation. To comply with European regulatory requirements, we will enter into a separate transition services agreement relating to transition services in Europe with respect to our payment protection insurance business. The types of services to be provided under the European transition services agreement will be substantially similar to the services to be provided under the U.S. transition services agreement, and we refer to these agreements in this prospectus collectively as the Transition Services Agreement.

Pursuant to the Transition Services Agreement, we will provide GE various services related to the businesses not transferred to us that had received services from GEFAHI prior to the separation, including information systems and network services, legal services and sourcing support. GE will provide services to us, including:

- treasury, payroll and other financial related services;
- human resources and employee benefits;
- legal and related services;
- information systems, network and related services;
- investment services;
- corporate services; and
- procurement and sourcing support.

We also will provide each other, on a transitional basis, additional services that we and GE may identify during the term of the agreement.

GE has agreed to pay us an aggregate of \$40 million in eight equal quarterly installments during the first two years after this offering for our provision of the transition services to GE. The charges for the transition services generally are intended to allow the providing company to fully recover the allocated direct costs of providing the services, plus all out-of-pocket costs and expenses, generally without profit. The agreement also will specify certain one-time costs associated with enabling us to provide the services to ourselves or to receive them directly from a third party, and will provide that those costs, up to an agreed upon cap, will be borne by GE. GE will also agree to bear the costs, up to an agreed upon cap, of obtaining specified software, licenses, consents, approvals, notices, registrations, recordings, filings and other actions that need to be obtained in connection with this offering and the separation of our business from GE.

Under the Transition Services Agreement, we and GE will each have the right to purchase goods or services, use intellectual property licensed from third parties and realize other benefits and rights under the other party's agreements with third-party vendors to the extent allowed by such vendor agreements. With respect to GE's Six Sigma program, GE, at no cost to us, will ensure that we will be able to continue to use our Six Sigma program in a manner consistent with our use prior to the completion of this offering. The Transition Services Agreement also will provide for the lease or sublease of certain facilities used in the operation of our respective businesses and for access to each other's computing and telecommunications systems to the extent necessary to perform or receive the transition services. In addition, GE's Global Research Center will continue to provide research and development services and related consulting services to us for certain existing projects under their current terms. The Transition Services Agreement will also provide that we may work on new projects with the GE Global Research Center in the future. All new projects will be pursuant to individual agreements that will be negotiated on an arms' length basis.

We will also provide management consulting services to GE for a period of five years. These services will include delivering training, providing consultation and strategic advice with respect to historical and emerging issues, planning and participating in meetings with rating agencies and regulators, participating in government relations activities and various other activities. In consideration for these services, GE will pay us a fee of \$1 million per month during the first four years following the offering and \$500,000 per month during the fifth year. GE cannot terminate this arrangement before the expiration of the five-year term.

The services provided under the Transition Services Agreement will terminate at various times specified in the agreement (generally ranging from 3 months to 60 months after the completion of this offering), but the receiving party may terminate any service by giving at least 60 days' prior written notice to the provider of the service. However, GE may not, without our consent, terminate the receipt of any service without cause prior to the expiration of two years from the date of this offering. Under the terms of the Transition Services Agreement, a provider of services will not be liable to a receiving party for or in connection with any services rendered pursuant to the Transition Services Agreement or for any actions or inactions taken by a provider in connection with the provision of services. However, a provider of services will be liable for, and will indemnify a receiving party for, liabilities resulting from its gross negligence, willful misconduct, improper use or disclosure of customer information or violations of law subject to a cap on GE's liability of \$15 million and a cap on our liability of \$10 million. Additionally, a receiving party will indemnify a provider for any losses arising from the provision of services, except to the extent the liabilities are caused by the provider's negligence or breach of the agreement, and except to the extent that the provider has indemnified the receiving party for the liabilities under the terms of the agreement.

The services to be provided under the European transition services agreement are similar to the services to be provided under the U.S. transition services agreement. The European transition services agreement will be governed by English law and differs from the U.S. transition services agreement only where dictated by specific regulation, law, practice or local business requirements. In particular, under the European transition services agreement, GE will not be restricted from terminating the agreement during the two

years from the date of the completion of this offering, and the European transition services agreement provides for a marginal profit for the service provider. In addition, each of GE's and our liability as provider of services under the agreement is limited to £5 million.

### ***Registration Rights Agreement***

We will enter into a registration rights agreement with GE prior to the completion of this offering to provide GE with registration rights relating to shares of our common stock held by GE after this offering. We refer to this agreement in this prospectus as the Registration Rights Agreement. GE may assign its rights under the Registration Rights Agreement to any person that acquires shares of our common stock subject to the agreement and agrees to be bound by the terms of the agreement. GE

233

---

and its permitted transferees may require us to register under the Securities Act of 1933 all or any portion of these shares, a so-called "demand request." The demand registration rights are subject to certain limitations. We are not obligated to effect:

- a demand registration within 60 days after the effective date of a previous demand registration, other than a shelf registration pursuant to Rule 415 under the Securities Act of 1933;
- a demand registration within 180 days after the effective date of the registration statement of which this prospectus is a part;
- a demand registration unless the demand request is for a number of shares with a market value that is equal to at least \$150 million; and
- more than two demand registrations during the first 12 months after completion of this offering or more than three demand registrations during any 12-month period thereafter.

We may defer the filing of a registration statement after a demand request has been made if (i) at the time of such request we are engaged in confidential business activities, which would be required to be disclosed in the registration statement, and our board of directors determines that such disclosure would be materially detrimental to us and our stockholders, or (ii) prior to receiving such request, our board of directors had determined to effect a registered public offering of our securities for our account and we have taken substantial steps to effect such offering. However, with respect to two demand requests only, if GE or any of its affiliates makes a demand request during the two-year period after the completion of this offering, we will not have the right to defer such demand registration or to not file such registration statement during that period.

In addition, GE and its permitted transferees have so-called "piggyback" registration rights, which means that GE and its permitted transferees may include their respective shares in any future registrations of our equity securities, whether or not that registration relates to a primary offering by us or a secondary offering by or on behalf of any of our stockholders. The demand registration rights and piggyback registrations are each subject to market cut-back exceptions.

GE or its permitted transferees will pay all costs and expenses in connection with any demand registration. We will pay all costs and expenses in connection with any "piggyback" registration, except underwriting discounts, commissions or fees attributable to the shares of common stock sold by our stockholders. In addition, we are required to bear the fees and expenses of one firm of counsel for the selling stockholders in any "piggyback" registration. The Registration Rights Agreement will set forth customary registration procedures, including an agreement by us to make our management available for road show presentations in connection with any underwritten offerings. We will also agree to indemnify GE and its permitted transferees with respect to liabilities resulting from untrue statements or omissions in any registration statement used in any such registration, other than untrue statements or omissions resulting from information furnished to us for use in the registration statement by GE or any permitted transferee.

The rights of GE and its permitted transferees under the Registration Rights Agreement will remain in effect with respect to the shares covered by the agreement until those shares:

- have been sold pursuant to an effective registration statement under the Securities Act of 1933;
- have been sold to the public pursuant to Rule 144 under the Securities Act of 1933;
- have been transferred in a transaction where subsequent public distribution of the shares would not require registration under the Securities Act of 1933; or
- are no longer outstanding.

In addition, the registration rights under the agreement will cease to apply to a holder other than GE or its affiliates when such holder holds less than 3% of the then outstanding shares covered by the agreement and such shares are eligible for sale pursuant to Rule 144(k) under the Securities Act of 1933.

234

---

### ***Investment agreements***

Our U.S., Canadian and Bermudan insurance subsidiaries are parties to investment management and services agreements with GEAM, a GE-owned provider of investment management services. The agreement with our Canadian insurance subsidiary will terminate in connection with this offering. The agreements with our U.S. and Bermudan insurance subsidiaries will, with limited exceptions, be amended in connection with this offering. GEAM will provide investment management services for our U.S. and Bermudan investment portfolios pursuant to these amended agreements and investment guidelines approved by the boards of directors of our respective companies. These services include, but are not limited to:

- researching and identifying investment opportunities;
- investing the account assets;
- selling and disposing of investments as appropriate;
- assisting in developing an overall investment strategy for the account assets;
- assisting with cash management and cash flow forecasting;
- assisting with developing reinvestment strategies and establishing hedging strategies; and

- providing other investment management services as we and GEAM may agree.

We will pay GEAM a management fee for these services on a quarterly basis, which will be equal to a percentage of the value of the assets under management and will be paid quarterly in arrears. The percentage will be established annually by agreement between GEAM and us and is intended to reflect the cost to GEAM of providing its services.

The initial term of our amended agreements with GEAM will be three years. We will have the option to extend the initial term for up to two additional one-year terms. We also will have the right to terminate the amended agreements upon one year's prior notice to GEAM or immediately upon a change of control of our company. In addition, we will have the right to terminate the agreements immediately for cause, which is defined as GEAM's fraud or willful misconduct, material breach of the agreement, material or repeated non-compliance with our investment guidelines and objectives or materially deficient investment performance for our accounts. Our amended agreements with GEAM will be non-exclusive, and we will be permitted to engage unaffiliated investment advisers. However, if we withdraw more than 15% of our total assets managed by GEAM during the initial three-year term of our agreements for the purpose of having the assets managed by another investment adviser or by us internally, we have agreed to negotiate in good faith with GEAM to reset the management fee for the remainder of the calendar year in which the withdrawal is made in order that GEAM will be able to recover its costs of providing services to us. GEAM also will have the ability to terminate the agreements at any point if the SEC suspends or withdraws GEAM's investment adviser registration or if a change in applicable law would materially and adversely affect GEAM's ability to provide services under the agreements. If GEAM were to terminate the agreements upon the occurrence of either event, GEAM would be required to use its best efforts to extend the termination date for the agreements to the maximum date consistent with the requirements of the termination event. After expiration of the initial three-year term, GEAM may terminate the agreements upon the occurrence of certain other specified events.

Substantially all the assets of our European payment protection and mortgage insurance businesses will be managed by GE Asset Management Limited, GEAM's affiliate in the U.K., pursuant to agreements that are substantially similar to our agreements with GEAM in the U.S. However, the management fee in our European investment agreements includes an agreed margin of 5% and will be reset if our European companies withdraw more than one-third of their assets in the first year of the agreements or more than two-thirds of their assets in the second year of the agreements. In addition,

235

---

we will have the right to terminate the European agreements upon six months' prior notice, rather than one year's notice, in the case of the U.S. agreements.

#### ***Derivatives Management Services Agreement***

In 2002, GE Capital, GEFAHI, GEAM and certain of our insurance company subsidiaries that use derivative instruments entered into a derivatives management services agreement and a related administrative services agreement which set forth the parties' responsibilities with respect to derivatives transactions. Pursuant to this agreement, GE Capital agreed to execute, manage and administer derivatives transactions on behalf of our insurance company subsidiaries and to delegate authority to perform these services to GEAM, as investment adviser to those subsidiaries. GEFAHI agreed, as necessary, to provide guarantees on behalf of the insurance company subsidiaries for the benefit of derivative counterparties.

In connection with this offering, we, GE Capital, and our insurance company subsidiaries that use derivative instruments will enter into a new derivatives management services agreement on substantially the same terms as the prior agreement, except that GE Capital may delegate authority to execute, manage and administer derivatives transactions to us, rather than to GEAM, which will no longer manage our derivatives. In addition, we, rather than GEFAHI, will be responsible for providing any required guarantees to derivative counterparties unless otherwise agreed by GE Capital and us. The existing administrative services agreement will remain in effect and GE Capital will continue to provide certain administrative services, including providing legal services related to the negotiation of master swap arrangements and serving as paying agent on behalf of our subsidiaries that enter into derivatives contracts. We do not expect to pay any compensation to GE Capital under the derivatives management services agreement, other than reimbursement of GE Capital's expenses, if any. The initial term of the derivatives management services agreement will end on December 31, 2004 and will automatically renew on January 1 of each year for successive terms of one year. The derivatives management services agreement will be able to be terminated by either GE Capital or us during the initial term or any renewal term upon 60 days' prior written notice. Both agreements will automatically terminate when GE ceases to beneficially own at least 50% of our outstanding common stock.

#### ***Asset Management Services Agreement***

Prior to the completion of this offering, we offered a broad range of institutional asset management services to third parties. GEAM provided the portfolio management services for this business, and we provided marketing, sales and support services. We will not acquire the institutional asset management services business from GEFAHI, but pursuant to an agreement among GEAM, GEFAHI and us, we will continue to provide services to GEAM and GEFAHI related to this asset management business, including client introduction services, asset retention services and compliance support. GEFAHI will pay us a fee of up to \$10 million per year for four years to provide these services. The fee will be determined based upon the level of third-party assets under management managed by GEAM over the four-year term. The agreement may not be terminated by GEAM or GEFAHI, except for non-performance or in the event that we commence a similar institutional asset management business.

#### ***Liability and Portfolio Management Agreements***

We will enter into three liability and portfolio management agreements with affiliates of GE prior to the completion of this offering. We refer to these agreements in this prospectus as the Liability and Portfolio Management Agreements. Pursuant to two of the Liability and Portfolio Management Agreements we will agree to manage a pool of municipal guaranteed investment contracts issued by Trinity Plus Funding Company, LLC and Trinity Funding Company, LLC, which we refer to collectively as Trinity. Pursuant to these agreements, we will originate GIC liabilities, advise Trinity as to the investment of the assets that support these liabilities and administer these assets.

236

---

Under each of the Trinity Liability and Portfolio Management Agreements, we will be entitled to receive an administration fee at a rate equal to 0.165% per annum of the maximum program size for those GE affiliates, which was an aggregate of \$15.0 billion as of December 31, 2003. We also will receive reimbursement of our operating expenses under each of these agreements.

Trinity can terminate each Liability and Portfolio Management Agreement in the event that Trinity exercises its option to replace substantially all of its portfolio with GE Capital debt, upon the payment of a break-up fee equal to 0.165% per annum of the program size, multiplied by the percentage derived by dividing the number of days remaining in the initial three-year term of each agreement by 365.

We also will enter into a Liability and Portfolio Management Agreement with GE Capital and with FGIC Capital Market Services, Inc., a GE affiliate, which we refer to as FCMS. Pursuant to this agreement, we will agree to provide liability management and other services relating to FCMS's origination and issuance of guaranteed investment contracts or similar liabilities. Under this Liability Management and Portfolio Agreement, we will receive a management fee of 0.10% per annum of the book value of the investment contracts or similar securities issued by FCMS after January 1, 2003, which was \$912 million as of December 31, 2003. The fee we will receive on the contracts issued by FCMS before January 1, 2003 will be based upon a pricing arrangement that will vary depending upon the maturities of those contracts and FCMS's cost of capital. The book value of the contracts issued before January 1, 2003 was \$2,008 million as of December 31, 2003 and is expected to generate a weighted average fee of approximately



0.35% in 2004. We also will receive reimbursement of our operating expenses under each of the Liability and Portfolio Management Agreements.

The initial term of each Liability and Portfolio Management Agreement will expire December 31, 2006, and unless terminated at the option of either party, each agreement automatically will renew on January 1 of each year for successive terms of one year.

#### *Agreement regarding continued reinsurance by Viking*

Prior to the completion of this offering, Viking Insurance Company and GE Capital will enter into an agreement relating to the continued engagement of Viking as reinsurer of credit insurance covering the credit card accounts of certain customers of GE Capital's GE Consumer Finance—Americas unit, or GECFA, and as reinsurer of collateral protection insurance purchased by GE's Vendor Financial Services unit, or VFS. This agreement will provide that GE Capital will cause GECFA to take all commercially reasonable efforts to maintain the existing relationship with the relevant insurer and to retain Viking as the reinsurer of the credit insurance provided or offered by GECFA. To the extent that GE terminates or replaces this credit insurance program, GE Capital will be obligated to pay Viking an amount equal to the net underwriting income that Viking was projected to receive as the reinsurer of such terminated or replaced credit insurance from the time of such termination or replacement through December 31, 2008. The agreement will further provide that GE Capital will, through March 1, 2004, cause VFS to continue to use American Bankers Insurance Group as direct insurer and Viking as the reinsurer of collateral protection insurance that VFS may place. This agreement will terminate no later than December 31, 2008. If, however, Viking continues to reinsure GECFA credit insurance or VFS collateral protection insurance beyond December 31, 2008, Viking will be obligated to pay to GE Capital 90% of Viking's net underwriting income on such reinsured business, and GE Capital will be obligated to pay to Viking 110% of Viking's net underwriting loss on such reinsured business.

#### *Mortgage Services Agreement*

We will enter into a mortgage services agreement with GE Mortgage Services, an affiliate of GE. We refer to this agreement in this prospectus as the Mortgage Services Agreement. Under this agreement, we will provide a variety of management services to GE Mortgage Services until December 31, 2005, for which GE Mortgage Services will reimburse us for our actual personnel and other expenses incurred. In addition, GE Mortgage Services will manage and service any residential

237

---

loans that it agrees to purchase from us from time to time in connection with the loss mitigation activities of our U.S. mortgage insurance business, for which we have agreed to reimburse GE Mortgage Services for its out of pocket expenses incurred in connection with the acquisition and disposition of those loans and to indemnify it for any losses relating to those loans. We also have agreed to purchase from GE Mortgage Services at fair market value any residential loans (or real estate resulting from foreclosure thereon) that it still holds at the termination of the Mortgage Services Agreement.

#### *Arrangements regarding our operations in India*

We will enter into an outsourcing services separation agreement with GE Capital International Services, or GECIS, an affiliate of GE, prior to the completion of this offering. We refer to this agreement in this prospectus as the Outsourcing Services Separation Agreement. The Outsourcing Services Separation Agreement will provide for the continuity of services currently provided by GECIS to certain of our subsidiaries. Our arrangement with GECIS provides us with a substantial team of professionals in India who provide a variety of services to us, including customer service, transaction processing, and functional support including finance, investment research, actuarial, risk and marketing resources to our insurance operations. This team was established in 1998 and is managed as a dedicated operations center apart from other GECIS operations. The Outsourcing Services Separation Agreement also will provide us with an option to cause GECIS to transfer to us some of the resources GECIS uses to provide these services, including hardware and equipment, software, employees of GECIS and third-party agreements. The consideration for this transfer is based upon a formula specified in the Outsourcing Services Separation Agreement. If we exercise that option, GECIS also would be required to assist us in obtaining comparable facilities and substitute software licenses and other third-party agreements that are not transferable to us by GECIS. This option will be exercisable upon:

- a change of control of GECIS or a transfer of some of its operations used to provide services to us;
- the expiration of the master outsourcing agreements, which are described below;
- certain breaches of the master outsourcing agreements or project-specific agreements by GECIS; or
- certain circumstances in which GECIS's liabilities to us exceed the caps described below.

Our arrangements with GECIS currently are governed by a series of master outsourcing agreements and related project-specific agreements, which, subject to regulatory approvals, will be amended pursuant to the Outsourcing Services Separation Agreement. Each of the amended master outsourcing agreements will have an initial term that will expire three years from the date on which GE ceases to own at least 50% of our common stock. We also will have the right, in our sole option, to renew all, but not less than all, of the amended master outsourcing agreements for an additional two-year period upon expiration of the initial term. We also will have the right to terminate any project-specific agreement in whole or in part for cause upon the occurrence of certain specified events and the right to terminate any project-specific agreement in whole or in part at any time without cause upon at least 90 days' written notice to GECIS. Under the new fee and cost structure, GECIS will provide its services to us at current pricing, subject to agreed discounts and to adjustment for changes in GECIS' cost of providing the services and in the volume of services provided by GECIS. Increases in unit costs (excluding the costs of foreign currency hedges) are limited to 5% per year. If we renew the initial term of the master outsourcing agreements for an additional two-year period, we and GECIS will agree upon revised charges and other terms applicable to the services provided to us during the renewal term.

The amended master outsourcing agreements also will provide, subject to regulatory approval, that upon the change of control of our company to any third party (other than GE and its affiliates),

238

---

GECIS will have the right, unless we otherwise agree during a 120-day negotiation period following the change of control, to terminate all, but not fewer than all, master outsourcing agreements upon the later of (1) the end of the 18-month period after the change of control and (2) the expiration of the initial term of the master outsourcing agreements. GECIS's liability to us, and our liability to GECIS, for certain specified breaches of the master outsourcing agreements or negligence in the performance of services is limited to 50% of all direct damages incurred in excess of \$25,000 for each matter, subject to a cap of \$5 million in the aggregate over the initial term of the agreement. Our respective liability to one another for other more significant matters, including gross negligence and willful misconduct, improper use of information, violation of law and voluntary withholding of services, is limited to direct damages of \$25 million in the aggregate. GECIS also has agreed that until the date on which either (1) the number of full-time equivalent employees used by GECIS to perform the services under all of the amended master outsourcing agreements is less than 50% of the number of such employees as of the completion of this offering or (2) the aggregate salaries of those employees are less than 50% of the budgeted aggregate compensation and benefits expense of such employees for the first twelve months after the completion of the offering, it will not market, sell or provide similar services to any third party (other than GE and its affiliates) that competes with us in certain of our businesses.

Each of the amended master outsourcing agreements will provide that GECIS will own all technology and intellectual property (other than trademarks, service marks, trade dress, or logos) developed or acquired by GECIS in performing services for us. However, particular project-specific agreements may provide that we will own some technology or intellectual property. Unless otherwise agreed in any project-specific agreement, we and GECIS will license to each other on substantially similar license terms as those contained in the Intellectual Property Cross-License all technology and intellectual property owned by GECIS or us that is used in the provision of services (except that the licenses to GECIS will terminate on the expiration or termination of the related amended master outsourcing agreements and project-specific agreements).

#### *Tax Matters Agreement*

We will enter into the Tax Matters Agreement with GE prior to the completion of this offering. The Tax Matters Agreement, among other things, will govern our continuing tax sharing arrangements with GE relating to pre-separation periods, and also will allocate responsibility and benefits associated with the elections to be made in connection with the separation as described below. The Tax Matters Agreement also will allocate rights, obligations and responsibilities in connection with certain administrative matters relating to taxes.

#### *Tax elections*

In connection with our separation from GE, GE will make, and we will join GE in making, tax elections under section 338 of the Internal Revenue Code that will treat (for tax purposes) many of the companies in our group as having sold all their assets in fully taxable sales. Under the Tax Matters Agreement, GE will control the making of these elections and related determinations. GE will be responsible for all current taxes resulting from the making of these tax elections.

#### *Tax benefit payments*

As a result of the section 338 tax elections, we will become entitled to certain tax benefits that are expected to be realized by us in the future in the ordinary course of our business and otherwise would not have been available to us, which we refer to as the Noncontingent Benefits. These benefits are generally attributable to increased tax deductions for amortization of intangibles and to increased tax basis in nonamortizable investment assets. Under the Tax Matters Agreement, we will be required to make payments to GE equal to 80% of the amount of tax we are projected to save for each tax period as a result of these increased tax benefits. We estimate that these payments will aggregate

239

---

approximately \$640 million. The estimated present value of the projected payments is approximately \$423 million.

The actual amount and timing of our projected payments under the Tax Matters Agreement will vary depending upon a number of factors, including the actual value of our company and its individual assets at the time of our separation from GE. GE will control the preparation and filing of our tax returns on which the section 338 elections, reflecting these factors, are reported. Subject to a maximum amount on total payments (described below), the amount of our obligation under the Tax Matters Agreement will be reduced (or increased) if and to the extent that the expected tax savings are reduced (or increased) as a result of a change in the tax returns on which the section 338 sales are reported. However, if, and to the extent, the actual tax savings are less than the projected tax savings because we fail to generate sufficient taxable income of the appropriate character, we will remain obligated to pay 80% of the full projected tax savings (as opposed to the actual tax savings) to GE. We also will remain obligated to pay 80% of the projected tax savings (as opposed to the actual tax savings) to GE if our actual tax savings are reduced because the applicable tax rates are reduced, but we will be entitled to retain 100% of the excess of our actual tax savings over projected tax savings if the applicable tax rates are increased. In any event, the maximum amount we will pay to GE (except for Contingent Amounts and interest on deferred payments, as described in the following paragraphs) under the Tax Matters Agreement for these Noncontingent Benefits will be \$640 million.

The timing of our payments to GE under the Tax Matters Agreement will be determined with reference to when we actually realize the projected tax savings. This timing will depend upon, among other things, the amount of our taxable income and the rate at which certain assets in our investment portfolio are sold or mature. If, as a result of these factors, payments to GE are accelerated or deferred relative to the schedule of payments projected under the Tax Matters Agreement, the Tax Matters Agreement provides for the accrual of interest to be paid to us, or by us, to account for the acceleration or deferral of our payments relative to the projected schedule of payments. Interest on deferred or accelerated payments will be paid in 2029, unless we exercise our right to accelerate the payment of deferred obligations or accrued interest or both. The payments in respect of the Noncontingent Benefits are subordinated in right of payment to all of our debt and other obligations.

In addition to Noncontingent Benefits under the Tax Matters Agreement, we have agreed to share equally with GE certain benefits or detriments, which we refer to as the Contingent Amounts, that generally will not be realized absent an intervening event we do not specifically foresee, such as the sale of a subsidiary. Contingent Amounts will also include tax benefits resulting from deductions attributable to compensation amounts funded by GE for our employees, which includes the exercise by our employees of GE stock options as well as amounts under GE-sponsored deferred compensation arrangements. In connection with these GE-funded compensation amounts, we anticipate that the Noncontingent Benefits we subsequently realize will be reduced without a corresponding reduction in the amount we owe to GE in respect of Noncontingent Benefits. Payments by us in respect of the Contingent Amounts are not subject to the \$640 million limit on our payments in respect of Noncontingent Benefits under the Tax Matters Agreement.

Under our Tax Matters Agreement with GE, if any person or group of persons other than GE or its affiliates gains the power to direct the management and policies of our company (other than through a sale of our stock by GE), we could become obligated immediately to pay to GE the total present value of all tax benefit payments due to GE under the agreement from the time of the change in control until the end of the 25-year term of the agreement. Similarly, if any person or group of persons other than us or our affiliates gains effective control of one of our subsidiaries (other than through a sale of our stock by GE), we could become obligated to pay to GE the total present value of all such payments due to GE allocable to that subsidiary, unless the subsidiary assumes the obligation to pay these future amounts under the Tax Matters Agreement and certain conditions are met. The acceleration of payments would be subject to the approval of certain state insurance regulators, and we are obligated to use our reasonable best efforts to see that these approvals are granted. As a result of

240

---

these obligations under the Tax Matters Agreement, we will be entitled to retain a portion of the tax savings generated by the Section 338 elections. If for any reason, however, some or all of the elections are not made or, if made, are invalidated for any reason (for example, if GE fails to divest itself of the requisite amount of our stock), then all or a portion of the tax savings would not be realized.

#### *Tax sharing arrangements*

We currently are a party to a number of tax sharing arrangements, both formal and informal, with the GE group. Under these arrangements, the companies in our group share financial and administrative responsibilities with GE for U.S. federal, state, local and foreign taxes for the periods during which we are affiliated. In certain respects, the Tax Matters Agreement will govern our continuing tax sharing arrangements with GE relating to pre-separation periods and will provide that tax sharing between us and GE not governed by any existing written agreements will be governed by existing tax sharing practices within GE, as determined in GE's reasonable discretion.

Under these arrangements, we generally will remain responsible for all taxes arising in pre-separation periods attributable to our companies (excluding any tax resulting

from the section 338 elections and certain other transactions done in connection with the separation). GE will generally control both the return preparation and audits and contests relating to pre-separation periods and taxes for which we are responsible, although we will not be liable for tax resulting from returns filed or matters settled by GE without our consent if the return or settlement position is found to be unreasonable, taking into account the liability that we incur as well as any non-Genworth tax benefit.

From 2000 until a time immediately prior to the pre-separation period, UFLIC was a member of our life insurance consolidated group for federal tax return purposes. Although UFLIC will be owned by GE after the completion of this offering, UFLIC will, under our tax allocation arrangements with GE, remain responsible for all of its taxes with respect to the time when it was a member of our life insurance consolidated group, including its share of any favorable or unfavorable adjustments by the IRS with respect to such taxes.

We have agreed that, if GE so elects, our life insurance group will join the GE consolidated tax group for the period during 2004 in which we are owned by GE. Under the Tax Matters Agreement, GE has agreed to reimburse us if this results in any additional cost to us, and we will pay to GE any benefit we may realize as a result of any such tax consolidation.

#### *Tax indemnities*

Under the Tax Matters Agreement, GE will indemnify us against liability for any tax relating to a pre-separation period not attributable to our group, as well as certain taxes attributable to our group, including any tax resulting from the section 338 elections and the various transactions implemented in connection with the separation (other than the reinsurance transactions with UFLIC). We will indemnify GE against any liability for all other tax attributable to our group.

#### *International tax matters agreements*

We will enter into tax matters agreements with GE prior to the completion of this offering that will cover certain non-U.S. operations which are not part of the Tax Matters Agreement described above. These agreements will vary according to the jurisdiction involved but generally will govern our continuing tax sharing arrangements with GE relating to pre-separation periods, as necessary, and will also allocate certain rights, obligations and responsibilities in connection with certain administrative matters relating to taxes.

Under the Canadian tax matters agreement, GE has the right to direct our Canadian mortgage insurance subsidiary to accelerate and pay approximately CDN\$74 million of deferred taxes. The subsidiary will recover accelerated taxes in the form of future tax savings over a period expected not to exceed two years. If we pay the accelerated tax out of our own funds, GE will compensate us for the

investment income we forego as a result. Similarly, if we require additional funds to pay the tax, GE will either provide those funds at no cost to us or will reimburse us for the cost we incur in obtaining those funds from an unrelated party.

Under the Australian tax matters agreement, we will assume from GE the liability for taxes in pre-closing periods of the company through which we formerly conducted our Australian mortgage insurance business.

#### ***Employee Matters Agreement***

We will enter into an agreement with GE prior to the completion of this offering relating to certain employee, compensation and benefits matters. We refer to this agreement in this prospectus as the Employee Matters Agreement. Under the Employee Matters Agreement, we will generally assume or retain, and agree to pay, perform, fulfill and discharge, in accordance with their respective terms, obligations and liabilities relating to the employment or services, or termination of employment or services, of any person with respect to our business before or after the completion of this offering. We will only be responsible for liabilities under the GE plans related to our business to the extent described in the Employee Matters Agreement.

***Employment.*** After the completion of this offering, we will continue to employ the employees of our business. In addition, for those employees assigned to our business but employed by a GE business prior to the completion of our offering, effective generally prior to the completion of this offering, GE will transfer, and we will employ, such employees. We will also assume the obligations of any works council agreement covering the employees of our business outside of the U.S.

***Continuation on GE payroll and in GE plans.*** Prior to this offering, some of the employees of our business have been paid through GE's payroll system. In addition, these employees have been covered under the GE plans. These employees generally will continue to be paid through GE's payroll system and be eligible to participate in the GE plans for so long as GE owns more than 50% of our outstanding common stock. GE plans include retirement programs providing pension, 401(k), health and life insurance benefits; medical, dental and vision benefits for active employees; disability and life insurance protection; and severance. For our applicable non-U.S. employees, benefit transition may be delayed, by mutual agreement between GE and us, for up to six months following the date that GE ceases to own more than 50% of our outstanding common stock (such date, whether delayed or not, is referred to as the "International Benefit Transition Date").

***Compensation.*** From the completion of this offering until at least one year after the date that GE ceases to own more than 50% of our outstanding common stock, our employees will receive at least the same (on an aggregate basis) salary, wages, bonus opportunities and, in the case of our non-U.S. employees, other compensation, as were provided to such employees prior to the completion of this offering.

***Equity/long-term performance award and incentive compensation plans.*** As described under "Management—Omnibus Incentive Plan" and "Management—Incentive Compensation Program," we will establish, adopt and maintain plans for our selected employees providing for cash or other bonus awards, stock options, stock awards, restricted stock, other equity-related awards and long-term performance awards in connection with the completion of this offering. However, certain of our employees will continue to participate in the GE Incentive Compensation Plan based on our company- and individual-specific performance measures, and our corresponding plan providing for annual cash or other bonus awards will not become effective until the date that GE ceases to own more than 50% of our outstanding common stock.

***Reimbursement to GE.*** We will reimburse GE for the costs, including expenses, incurred by GE and its affiliates for maintaining our employees on the GE payroll and in the GE plans consistent with practices and procedures established and uniformly applied to GE businesses. In no event will we be

billed more for the services relating to maintaining our U.S. employees in the GE plans than the cost we would have incurred if we had established mirror plans for our U.S. employees from the completion of this offering until the date that GE ceases to own more than 50% of our outstanding common stock. We will also reimburse GE for the reasonable costs incurred by GE and its affiliates for cooperating in the operation and administration of our plans, including our plans providing for stock options, stock awards, restricted stock, other equity-related awards and long-term performance awards, consistent with practices and procedures established for such plans in effect prior to the completion of this offering, or, in the event of a new plan, on a cost liquidation basis.

*Transition to our benefit plans.* Effective as of the date that GE ceases to own more than 50% of our outstanding common stock, our applicable U.S. employees will cease to participate in the GE plans and will participate in employee benefit plans established and maintained by us. For at least the year following the date that GE ceases to own more than 50% of our outstanding common stock, we will maintain plans that will provide our employees with benefits that are at least substantially comparable in the aggregate to the value of those benefits provided by the GE plans immediately prior to the date that GE ceases to own more than 50% of our outstanding common stock. Our plans will include retirement programs providing pension, 401(k), health and life insurance benefits; medical, dental and vision benefits for active employees; disability and life insurance protection; and severance. We will recognize prior GE service for all purposes (except benefit accrual under our pension plan) under our new plans and programs to the same extent such service is recognized under corresponding GE plans.

After completion of this offering, we will assume or continue benefit plans for our non-U.S. employees. If applicable, effective as of the International Benefit Transition Date, we will establish new benefit plans for our non-U.S. employees that, together with any benefit plans we assume or continue, will provide such non-U.S. employees with benefits that are at least substantially comparable in the aggregate to the value of those benefits provided by the benefit plans in effect immediately prior to the International Benefit Transition Date. In addition, the benefits or employment practices provided by us to our non-U.S. employees will be at such level and design so that no severance or similar payment to such non-U.S. employees will be triggered, and will comply with applicable law. In the event that any such severance or similar payment is triggered under a GE plan, we will reimburse GE for such amounts. We will maintain these existing or new plans for our non-U.S. employees for a period of at least one year following the date that GE ceases to own more than 50% of our outstanding common stock (or such longer period required by applicable law or practice).

To the extent any defined benefit or defined contribution pension plan sponsored by GE and covering both our non-U.S. employees and GE's non-U.S. employees is funded (other than the Canadian General Electric Pension Plan), there will be a transfer of assets and liabilities from the trust for such GE plan to the corresponding trust for the benefit plan we establish for our non-U.S. employees unless contrary to applicable laws. GE will determine a proportionate amount of the trust assets corresponding to, and not to exceed the liabilities under, such GE plan that is attributable to our non-U.S. employees. In the case of a defined benefit pension plan, the amount to be transferred will be determined by the plan sponsor subject to mutual agreement by GE and us and based upon generally accepted country- and plan-specific actuarial assumptions and the accrued benefit obligation method. It is anticipated that consistent treatment will be provided with respect to any funded defined benefit or defined contribution pension plan sponsored by us and covering both our non-U.S. employees and GE's non-U.S. employees.

*Treatment of our U.S. employees under certain GE plans.* Effective as of the date that GE ceases to own more than 50% of our outstanding common stock, (i) our employees will cease to accrue any benefits under the GE retirement plans and (ii) our employees will fully vest in the GE retirement plans. However, with respect to the GE Supplementary Pension Plan, only those employees who have at least ten years of qualified pension service as of the date that GE ceases to own more than 50% of our outstanding common stock will vest in such plan. GE will be responsible for paying directly to our

243

---

eligible employees (including their surviving spouses and beneficiaries) any vested benefits to which they are entitled under the GE retirement plans when eligible under the terms of such plans to receive such payments.

GE generally will remain obligated to provide post-retirement welfare benefits under the GE Life, Disability and Medical Plan, consistent with the terms of the plan as in effect from time to time, to our employees and their eligible dependents who, as of the date GE ceases to own more than 50% of our outstanding common stock, are participants in such plan and either (1) have completed 25 years of continuous service or pension qualified service with us, our affiliates and their respective predecessors or (2) have attained at least 60 years of age and have completed at least ten years of continuous service, in either case upon such employee's election to participate in the GE Life, Disability and Medical Plan. Participation by our employees will be under circumstances and at the applicable contribution levels entitling them to receive such benefits pursuant to the terms of the GE Life, Disability and Medical Plan. GE will be responsible for paying directly to our eligible employees and their eligible dependents any post-retirement welfare benefits pursuant to such coverage. We will have certain reimbursement obligations to GE.

GE generally will retain responsibility under the GE plans that are welfare benefit plans in which our employees participate with respect to all amounts that are payable by reason of, or in connection with, any and all welfare benefit claims made by such employees and their eligible dependents to the extent the claims were incurred prior to the date that GE ceases to own more than 50% of our outstanding common stock.

We will have certain obligations for reimbursing GE for any payments of welfare benefits made by GE or its affiliates on or after the date that GE ceases to own more than 50% of our outstanding common stock to our eligible employees and their eligible dependents pursuant to any self-insured GE plans with respect to claims incurred up to the day before the date that GE ceases to own more than 50% of our outstanding common stock, or any payments of welfare benefits made by GE or its affiliates on or after the date that GE ceases to own more than 50% of our outstanding common stock to our eligible employees who are inactive as of the date that GE ceases to own more than 50% of our outstanding common stock and their eligible dependents pursuant to any self-insured GE plans with respect to claims incurred the day before such employees' return to active employment with us. In addition, we will have certain obligations for reimbursing GE for any payments of premiums made by GE or its affiliates on behalf of our eligible employees who are inactive as of the date that GE ceases to own more than 50% of our outstanding common stock and their eligible dependents pursuant to any insured GE plans with respect to coverage ending the day before such employees' return to active employment with us. We will otherwise be responsible for welfare benefit claims made by our employees and their eligible dependents to the extent such claims were incurred on or after the date that GE ceases to own more than 50% of our outstanding common stock.

*Agreements not to solicit or hire GE's or our employees.* We will agree with GE that for so long as GE owns more than 50% of our outstanding common stock, neither of us will, directly or indirectly, solicit or hire for employment each other's employees. In addition, we will agree that for a period of one year from the date that GE ceases to own more than 50% of our outstanding common stock, we will not, directly or indirectly, solicit for employment certain individuals employed by GE. Finally, we will agree that for a period of two years from the date that GE ceases to own more than 50% of our outstanding common stock, we will not, directly or indirectly, solicit for employment any officer of GE.

GE will agree that for a period of one year from the date that it ceases to own more than 50% of our outstanding common stock, it will not, directly or indirectly, solicit for employment certain individuals employed by us. For a period of two years from the date that GE ceases to own more than 50% of our outstanding common stock, GE will agree that it will not, directly or indirectly, solicit for employment any person employed by us who was an officer of GE prior to the completion of this offering.

244

---

The foregoing restrictions will not prohibit GE or us from soliciting or hiring any employee subject to such restrictions after the termination of the employee's employment by the applicable employer. We and GE will also not be prohibited from placing public advertisements or conducting any other form of general solicitation for employees so long as it is not specifically targeted towards each other's employees that are subject to such restrictions.

#### ***Intellectual Property Arrangements***

We will enter into the following two intellectual property license agreements with GE prior to the completion of this offering:

- A Transitional Trademark License Agreement; and

- An Intellectual Property Cross-License.

#### *Transitional Trademark License Agreement*

Pursuant to the Transitional Trademark License Agreement, GE will grant us a limited, non-exclusive, royalty-free, non-transferable license (with no right to sublicense) to use the "GE" mark and monogram for up to five years throughout the world and in any medium in connection with our commercialized products and services and in the general promotion of our business. These products and services include both those currently sold or rendered in the current conduct of our business, and products and services sold or rendered by us in the future that are the same as or similar to those we currently sell or render.

We have agreed not to use the "GE" mark and monogram in the underwriting or marketing of primary life insurance in the U.K. (other than credit life insurance underwriting) or asset management services or products (other than asset management services or products sold on behalf of GE or otherwise currently being marketed or offered by us). GE also will grant us the right to use "GE", "General Electric" or "GE Capital" in the corporate names of our subsidiaries until the earlier of twelve months after the date on which GE owns less than 20% of our outstanding common stock and five years from the date of the agreement.

The Transitional Trademark License Agreement automatically terminates in the event of our merger or consolidation with, or sale of substantially all of our assets to, an unrelated third person, or our change of control whereby an unrelated third person acquires control over us. GE also retains the right to terminate the Transitional Trademark License Agreement in the event we materially breach its provisions. In addition, GE may terminate the Transitional Trademark License Agreement in the event of our bankruptcy, insolvency, liquidation, dissolution or similar event. The Transitional Trademark License Agreement also automatically terminates with respect to any of our subsidiaries in the event of its merger or consolidation with, or sale of substantially all of its assets to, an unrelated third person, or its change of control whereby an unrelated third person acquires control over it, or upon our subsidiary's bankruptcy, insolvency, liquidation, dissolution or similar event.

#### *Intellectual Property Cross-License*

Pursuant to the Intellectual Property Cross-License, we and GE will grant each other a non-exclusive, irrevocable, royalty-free, fully paid-up, worldwide, perpetual license under certain intellectual property rights that we each own or license. The intellectual property rights being licensed under the Intellectual Property Cross-License are patents, patent applications, statutory invention registrations, copyrights, mask work rights, trade secrets and other intellectual property rights arising from or in respect of technology (but not including trademarks, service marks, trade dress or logos). The intellectual property rights being licensed under the Intellectual Property Cross-License also must be those that we and GE have the right to license and that are used, held for use or contemplated to be used by the other person generally prior to the completion of this offering.

245

---

In addition, with respect to any third-party intellectual property licensed under the Intellectual Property Cross-License, we and GE will only grant each other sublicenses under such third-party intellectual property licenses that each party controls.

The license allows us and GE to make, have made, use, sell, have sold, import and otherwise commercialize products and services, and to use and practice the licensed intellectual property rights for internal purposes. Each party will only be able to sublicense its license rights to acquirors of its businesses, operations or assets, and only assign its license rights to an acquiror of all or substantially of its assets or equity or the surviving entity in its merger, consolidation, equity exchange or reorganization. Each party may permit its customers and suppliers in the ordinary course of business to use any training and productivity-enhancing software and documentation that is subject to the license granted by the other person and is for general use by customers and suppliers. Each person will own any modifications, derivative works and improvements it creates.

The Intellectual Property Cross-License will be perpetual and may not be terminated, even upon material breach, except upon mutual written agreement by us and GE.

## **Reinsurance Transactions**

### *General*

Prior to the completion of this offering, we will enter into several significant reinsurance transactions. We refer to these transactions in this prospectus as the Reinsurance Transactions. In these transactions, we will cede to UFLIC, an indirect, wholly-owned subsidiary of GE, in-force blocks of structured settlements, substantially all of our in-force blocks of variable annuities and a block of long-term care insurance policies that we reinsured in 2000 from Travelers. In the aggregate, these blocks of business do not meet our target return thresholds, and although we remain liable under these contracts and policies as the ceding insurer, the reinsurance transactions will have the effect of transferring the financial results of the reinsured blocks to UFLIC. As part of the Reinsurance Transactions, we will assume from UFLIC a small in-force block of Medicare supplement insurance.

We are continuing new sales of structured settlements, variable annuities and long-term care insurance products, and we expect to achieve our targeted returns on these new sales. We intend to write structured settlements on a limited, opportunistic basis at appropriate returns, capitalizing on our experience and relationships with respect to this product. We also intend to write new variable annuity contracts that we believe will provide us with more attractive returns than we were able to realize on the contracts we wrote during the extremely competitive market conditions of the late 1990s. We are retaining 88% of the earned premiums on our in-force block of long-term care insurance, based on our results for the year ended December 31, 2003. We intend to continue writing long-term care insurance after the completion of this offering. In addition, we will continue to service these blocks of business, which will preserve our operating scale and enable us to service and grow our new sales of these products.

### *Business we will cede to UFLIC*

In the Reinsurance Transactions, we will cede to UFLIC the following business:

- All of our liabilities under the in-force structured settlement annuities reflected as policyholder reserves on our U.S. GAAP statement of financial position on December 31, 2003, or reinsured by us under reinsurance agreements in effect prior to January 1, 2004. This business had aggregate reserves of \$12.0 billion as of December 31, 2003.
- All of our liabilities under the in-force variable annuity contracts reflected as policyholder reserves on our U.S. GAAP statement of financial position on December 31, 2003, other than our GERA™ product and a limited number of variable annuity products that we no longer offer. UFLIC will also assume any benefit or expense resulting from third party reinsurance that we

246

---

have on this business. This business had aggregate general account reserves of \$2.8 billion as of December 31, 2003.

- All of our liabilities under the in-force long-term care insurance policies issued by Travelers prior to January 1, 2004 and reinsured by us. This business had aggregate reserves of \$1.5 billion as of December 31, 2003.

For each of these ceded blocks of business, we will pay UFLIC an initial reinsurance premium, and UFLIC will pay us a ceding commission. With respect to the structured settlement and long-term care blocks, the initial reinsurance premium will equal our statutory reserves with respect to the ceded business. With respect to the variable annuity business, the initial reinsurance premium will equal only those statutory reserves that are attributable to the general account portion of the variable annuity business. We will retain the assets that are attributable to the separate account portion of the variable annuity business and make any payments with respect to that separate account portion directly from these assets.

The ceding commission for each of the blocks will be the sum of the following (in each case excluding, where applicable, any related mark-to-market adjustments for SFAS 115 requirements):

- an amount (which may be negative) equal to the excess of (1) our statutory general account reserves with respect to the ceded block as of the close of business on December 31, 2003 over (2) our U.S. GAAP general account reserves with respect to the ceded block of business as of such date;
- an amount equal to our unamortized PVFP intangible asset balance with respect to the ceded block as of the close of business on December 31, 2003, determined in accordance with U.S. GAAP;
- an amount equal to our unamortized DAC with respect to the ceded block as of the close of business on December 31, 2003, determined in accordance with U.S. GAAP;
- an amount (which may be negative) equal to the excess of the U.S. GAAP book value of the assets transferred to UFLIC in payment of the initial reinsurance premium with respect to the ceded block over the statutory book value of those assets measured as of the close of business on December 31, 2003; and
- with respect to the long-term care block only, an amount equal to the balance, as of the close of business on December 31, 2003, of the Loss Carry Forward Amount under our reinsurance agreement with Travelers, determined in accordance with U.S. GAAP.

The ceding commission will be netted against the initial reinsurance premium and we will transfer to UFLIC invested assets (including interest thereon) with a statutory book value equal to the amount by which the reinsurance premium exceeds the ceding commission, together with an amount equal to the cash flows on such invested assets between January 1, 2004 and the date of transfer of such invested assets. As of December 31, 2003, the fair value of the transferred assets would have been \$15.8 billion.

Under the reinsurance agreements with UFLIC, we will continue to be responsible for the administration of these three blocks of businesses, including paying claims and benefits in accordance with our current policy administration practices. To fund the payment of claims under the structured settlement and long-term care business, UFLIC will establish and periodically fund claims paying accounts from which we will be entitled to withdraw funds. To reimburse us for claims under the variable annuity business, UFLIC will establish a settlement account by which we and UFLIC will settle contractholder amounts due each other on a daily basis. UFLIC will pay us an expense allowance once every month to reimburse us for our expenses in administering this business. The expense allowance will be a specified amount per policy that will be subject to subsequent adjustments in accordance with methodologies and procedures agreed to by us and UFLIC. The expense allowance with respect to the

---

long-term care business will be based on a per policy fee, as well as on the level of pending or open claims.

UFLIC will be entitled to assume responsibility for administration of the structured settlement and variable annuity blocks and the long-term care policies that are novated to us, as described below, if (1) a voluntary or involuntary conservation, rehabilitation or liquidation proceeding is commenced in any jurisdiction by or against us, (2) there is a material breach by us that is not cured or (3) we are unable to perform the administration for a prescribed period of time. In addition, 15 years after the effective date of the Reinsurance Transactions, UFLIC will be entitled to assume administration of this business at its own expense. In these cases, the expense allowances described above payable to us will terminate.

To secure the payment of its obligations to us under these reinsurance agreements, UFLIC has agreed to establish trust accounts and to maintain in these trust accounts an aggregate amount of assets with a statutory book value at least equal to the statutory general account reserves attributable to the reinsured business less an amount equal to the amounts required to be held in the claims paying accounts described above. A trustee will administer the trust accounts solely for our benefit. We will be permitted to withdraw from the trust accounts any amount due to us pursuant to the terms of the applicable reinsurance agreements and not otherwise paid by UFLIC. Quarterly, UFLIC will be required to contribute assets to the trust accounts if the statutory book value of the assets held in the trust accounts is less than the statutory general account reserves attributable to the reinsured business (less amounts in the claims paying accounts) or we will be required to withdraw from the trust accounts and pay to UFLIC any amounts held in the trust accounts that exceed the statutory general account reserves attributable to the reinsured business (less amounts in the claims paying accounts). UFLIC will not be permitted to directly withdraw or substitute assets in the trust without our prior written consent. There are limits on the types of assets UFLIC will be permitted to place in the trust account. All interest, dividends and other income earned on the assets in the trust account will be the property of UFLIC and will be deposited in a bank account maintained by UFLIC outside of the trust.

#### ***Novation of Travelers long-term care block***

The long-term care insurance we are ceding to UFLIC originally was written by Travelers, and Travelers retains direct liability for these policies. In connection with the transaction pursuant to which we reinsured Travelers' liability for this business, we agreed to use our reasonable best efforts to "novate" these policies not later than July 31, 2008. The effect of this novation will be to substitute us for Travelers as the insurer with direct liability for any policy for which the owner thereof consents (or is deemed under applicable insurance law to consent) to the novation. The novated policies will continue to be reinsured with UFLIC.

#### ***Experience refund***

In addition to the ceding commission we will receive on the long-term care block described above, UFLIC may be required to pay us experience refunds based on the profitability of the long-term care business with respect to the period beginning on the effective date of the long-term care reinsurance agreements and ending on December 31, 2018. Specifically, unless UFLIC assumes the administration of the long-term care insurance block pursuant to the long-term care reinsurance agreement, for so long as we continue to administer all of the long-term care business, including those long-term care policies that are novated as described above, we will be entitled to receive a specified percentage of the excess (if any) of actual statutory basis pre-tax income earned on the long-term care business over projected statutory basis pre-tax income earned on that business.

#### ***Business Services Agreement***

We will enter into a Business Services Agreement with UFLIC pursuant to which we will agree to continue to perform various management and support services with

settlements business, the variable annuity business and the long-term care insurance business that we will cede to UFLIC pursuant to the Reinsurance Transactions. In consideration for our performance of these services, we will be reimbursed for expenses incurred in performing such services. These expenses will be subject to annual and tri-annual adjustment. The Business Services Agreement may be terminated by UFLIC if (1) we are unable to perform the services for any reason for thirty 30 consecutive days, other than as a result of a force majeure, or (2) a voluntary or involuntary conservation, rehabilitation or liquidation proceeding is commenced in any jurisdiction by or against us or our subsidiaries and affiliates, but only if the services performed by the subject of such proceeding are not assumed or performed by us or our subsidiaries or affiliates that are not the subject of such proceeding, or (3) there is a willful, material breach by us of our obligations under the agreement, which breach is not cured within a specified period of time. In addition, the Business Services Agreement will terminate with respect to the portion of any business reinsured in the Reinsurance Transactions as to which UFLIC becomes entitled to assume administration as described above under "—Reinsurance Transactions—Business we will cede to UFLIC."

#### ***Recapitalization of UFLIC***

At the time of the closing of the Reinsurance Transactions, GEFAHI will make a capital contribution of \$1.836 billion to UFLIC. In addition, GE Capital will contribute \$330 million to GEFAHI, which GEFAHI will also contribute to UFLIC for a total contribution of \$2.166 billion. This will provide UFLIC with additional capital needed to support its reinsurance obligations. GEFAHI will obtain the funds to make its portion of the contribution from various sources, including dividends and surplus note redemption payments from several of our subsidiaries, some of which are ceding business to UFLIC in the Reinsurance Transactions.

#### ***Capital Maintenance Agreement with GE Capital***

Pursuant to a Capital Maintenance Agreement to be entered into in connection with the Reinsurance Transactions, GE Capital will agree to maintain sufficient capital in UFLIC to maintain UFLIC's risk-based capital at not less than 150% of its company action level, as defined from time to time by the NAIC. GE Capital may not assign or amend the Capital Maintenance Agreement without the consent of the ceding companies and their domestic insurance regulators (which consent, in the case of the ceding companies, may not be unreasonably withheld). The Capital Maintenance Agreement terminates at such time as UFLIC's obligations to us under the reinsurance agreements terminate, or on such other date as may be agreed by UFLIC and GE Capital with the consent of the domestic regulators and us.

#### ***Business we will assume from UFLIC***

UFLIC will cede to us all of its liabilities under substantially all in-force Medicare supplement insurance policies it issued prior to January 1, 2004 or reinsured under reinsurance agreements in effect prior to January 1, 2004, including renewals of these policies. This business had aggregate reserves of \$19 million as of December 31, 2003.

We will assume responsibility for the administration of the Medicare supplement business we reinsure, including claims administration.

### **European Payment Protection Insurance Business Arrangements**

Our European payment protection insurance business is carried on through six insurance companies, two located in the U.K., two located in France and two located in Spain. The U.K. companies carry on their business in the U.K. and through branches in a number of other European jurisdictions.

Prior to the completion of the offering, we will acquire one of the French insurance companies. We are planning to acquire the European payment protection business of the other insurance companies pursuant to insurance business transfer arrangements carried out under U.K. and French law. These transfer arrangements require regulatory and, in the case of the U.K., court approval. We expect to receive the necessary approvals required to implement the transfer arrangements prior to December 31, 2004 but not prior to the completion of this offering. These five other insurance companies will remain as wholly-owned indirect subsidiaries of GE pending implementation of the business transfer arrangements but will be managed by members of the Genworth management team.

Pending implementation of these transfers and prior to the completion of the offering, we will enter into reinsurance arrangements with the U.K. and French insurance companies that we will not then own, which will effectively transfer to us all of the economic benefits, obligations and risks of the European payment protection businesses effective as of January 1, 2004. Under these arrangements, these companies will cede to us as of January 1, 2004 all of their in-force payment protection insurance policies. These arrangements also provide for the automatic ceding to us of payment protection insurance policies that these companies issue after that date. The European payment protection business of these companies had aggregate reserves of \$2.4 billion as of December 31, 2003.

The ceding insurance companies will retain ownership of the assets constituting the reserves supporting the European payment protection business, from which claims under the reinsured policies will be paid. In the case of the U.K. reinsurance arrangements, we will receive from the ceding insurance companies interest on the amount of reserves based upon the total realized rate of return of the assets, which will transfer to us the risks and rewards of ownership of the assets supporting the reserves. In the case of the French reinsurance arrangement, we will receive from the ceding insurance company interest on the amount of the reserves based upon a specified interest rate. Upon completion of the business transfer arrangement, we will receive from, or pay to, GE the difference between these interest amounts and the total return on the assets supporting the reserves. We will continue to administer the business of the U.K. insurance companies and their branches through a service company we will acquire from GE prior to the completion of this offering that employs the sales force and other personnel and owns the systems used by the U.K. insurance companies and their branches.

If, for any reason, the U.K. business transfer scheme is not implemented by December 31, 2004, GE has agreed to transfer the stock of the U.K. and Spanish insurance companies to us. If the French business transfer arrangements are not implemented, we still would receive the benefits and be subject to the obligations and risks with respect to the European payment protection business pursuant to the reinsurance agreement. These reinsurance agreements may only be terminated in limited circumstances, including such time as the ceding company and the reinsurer are both under our control and such time as the relevant insurance business transfer plan or stock transfer has become effective.

We have accounted for the transfer of the service companies and the reinsurance arrangements described above as a business combination between entities under common control in our historical combined financial statements.

Our payment protection insurance business in the U.K. includes a portfolio of insurance bonds and structured settlements issued to contractholders in the U.K. that had reserves of approximately \$160 million as of December 31, 2003 and net earnings of less than \$1 million for the year ended December 31, 2003. We and GE have agreed, subject to receipt of required regulatory and court approvals in the U.K., to transfer ownership of the bond and structured settlement portfolio to GE as soon as practicable following the transfer of the U.K. insurance businesses to us. Pending completion of

the transfer of the bond and structured settlement portfolio, we have agreed to use commercially reasonable efforts to enter into indemnity reinsurance arrangements with GE to transfer the economic benefits, obligations and risks of the bond and structured settlement portfolio to GE promptly following completion of the offering.

## **Historical Related-Party Transactions**

### ***Support services provided by GE***

GE historically has provided a variety of support services for our businesses, and we have reimbursed GE for the costs of providing these services to us. Our total expenses for these services were \$87 million, \$74 million and \$52 million for the years ended December 31, 2003, 2002 and 2001, respectively. The services we have received from GE include:

- Customer service, transaction processing and a variety of functional support services provided by GECIS, for which we incurred expenses of \$37 million, \$26 million and \$13 million for the years ended December 31, 2003, 2002 and 2001, respectively.
- Employee benefit processing and payroll administration, including relocation, travel, credit card processing, and related services, for which we incurred expenses of \$10 million, \$10 million and \$9 million for the years ended December 31, 2003, 2002 and 2001, respectively.
- Employee training programs, including access to GE training courses and payment for employees in management development programs, for which we incurred expenses of \$4 million, \$10 million and \$6 million for the years ended December 31, 2003, 2002 and 2001, respectively.
- Insurance coverage under the GE insurance program, for which we incurred expenses of \$17 million, \$10 million and \$9 million for the years ended December 31, 2003, 2002 and 2001, respectively.
- Information systems, network and related services, for which we incurred expenses of \$9 million, \$8 million and \$9 million for the years ended December 31, 2003, 2002 and 2001, respectively.
- Leases for vehicles, equipment and facilities, for which we incurred expenses of \$3 million for the year ended December 31, 2003 and \$2 million for each of the years ended December 31, 2002 and 2001.
- Other financial and advisory services such as tax consulting, capital markets services, research and development activities, and trademark licenses, for which we incurred expenses of \$7 million, \$8 million and \$4 million for the years ended December 31, 2003, 2002 and 2001, respectively.

GE will continue to provide us with many of the support services described above on a transitional basis after the completion of this offering, and we will arrange to procure other services pursuant to arrangements with third parties or through our own employees. See "—Relationship with GE" above. In the case of support services provided by GECIS, we will continue to receive these services pursuant to agreements that will be amended prior to the completion of this offering. See "—Relationship with GE—Arrangements regarding our operations in India" above.

### ***Allocation of corporate overhead expenses***

GE historically has allocated to us a share of its corporate overhead expenses for certain services provided to us, which are not specifically billed to us, including public relations, investor relations, treasury, and internal audit services. Our total expense for this allocation was \$50 million, \$49 million and \$43 million for the years ended December 31, 2003, 2002 and 2001, respectively. We have not reimbursed these amounts to GE, and have recorded them as a capital contribution in each year. Following the completion of this offering, GE will no longer allocate any of its corporate overhead expenses to us.

251

---

### ***Investment management services***

We receive investment management and related administrative services provided by GEAM, for which we incurred expenses of \$61 million, \$39 million and \$2 million for the years ended December 31, 2003, 2002 and 2001, respectively. We will continue to receive these services pursuant to agreements that will, with limited exceptions, be amended prior to the completion of this offering. See "—Relationship with GE—Investment Agreements."

### ***Employee benefit plans***

We have reimbursed GE for benefits it provides to our employees under various employee benefit plans.

Our employees participate in GE's retirement plan and retiree health and life insurance benefit plans. Some of our employees also participate in GE's Supplementary Pension Plan and other retiree benefit plans. Other retiree plans are not significant individually or in the aggregate. We incurred expenses associated with these plans of \$52 million, \$52 million and \$44 million for the years ended December 31, 2003, 2002 and 2001, respectively.

Our employees participate in GE's defined contribution savings plan that allows the employees to contribute a portion of their pay to the plan on a pre-tax basis. GE matches 50% of these contributions up to 7% of the employee's pay. We incurred expenses associated with these plans of \$13 million, \$15 million and \$16 million for the years ended December 31, 2003, 2002 and 2001, respectively.

We also provide life and health insurance benefits to our employees through the GE benefit program, as well as through plans sponsored by other affiliates. We incurred expenses associated with these plans of \$41 million, \$45 million and \$43 million for the years ended December 31, 2003, 2002 and 2001, respectively.

In addition to the employee benefit expenses for which we have reimbursed GE, we have incurred expenses of \$9 million, \$6 million and \$4 million for certain GE stock option and restricted stock unit grants for the years ended December 31, 2003, 2002 and 2001, respectively. As in the case of the allocation of corporate overhead, these amounts will not be paid to GE and have been recorded as a capital contribution.

See notes 12 and 18 to our audited historical combined financial statements and "Management" and "Arrangements Between GE and Our Company—Relationship with GE—Employee Matters Agreement" for information concerning the participation of our employees in GE employee benefit plans prior to and after the completion of this offering.



### ***Reinsurance transactions***

We have entered into reinsurance transactions with affiliates of GE under which we have reinsured some of the risks of our insurance policies on terms comparable to those we could obtain from third parties. We have paid premiums to ERC Life Reinsurance Company of \$56 million, \$60 million and \$58 million for the years ended December 31, 2003, 2002 and 2001, respectively. In addition, in 2002 one of our subsidiaries entered into a life reinsurance agreement with an affiliated company, GE Pensions Limited, to reinsure 95% of our liabilities under certain life policies. We have paid premiums to this affiliate of \$100 million and \$94 million for the years ended December 31, 2003 and 2002. See "Business—Reinsurance." The existing reinsurance agreements with GE will remain in force and continue in accordance with their terms after the completion of this offering.

### ***Credit arrangements and other amounts due from or owed to GE***

As of December 31, 2003 and 2002, we had several notes receivable from various GE affiliates in the aggregate amount of \$209 million and \$367 million, respectively. These notes mature at various dates through 2017 and bear interest at rates between 5.46% and 6.63%.

252

---

As of December 31, 2002, our Japanese life insurance business had ¥62.8 billion (\$530 million) of long-term borrowings from various GE affiliates. This debt was scheduled to mature at various dates through 2008 and bore interest at rates between 2.25% and 2.64%. This debt has been recorded in liabilities associated with discontinued operations.

As of December 31, 2003 and 2002, we had approximately €2 million (\$2 million) and £5 million (\$9 million), respectively, of notes payable to various GE affiliates. These notes mature in 2011 and 2007 and bear interest at the six-month Euro Interbank Offered Rate ("EURIBOR") and 8.80%, respectively.

As of December 31, 2003 and 2002, we had certain operating receivables of \$254 million and \$0 million, respectively, and payables of \$673 million and \$763 million, respectively, with certain affiliated companies.

As of December 31, 2003 and 2002, we had a line of credit with GE that had an aggregate borrowing limit of \$2.5 billion. There was an outstanding balance of \$548 million as of December 31, 2003 and no outstanding balance as of December 31, 2002. Outstanding borrowings under this line of credit bear interest at the three-month US\$ London Interbank Offered Rate ("LIBOR") plus 25 basis points. Interest is accrued and settled quarterly, in arrears. We incurred interest expense under this line of credit of \$0.5 million, \$8 million and \$11 million for the years ended December 31, 2003, 2002 and 2001, respectively. We also had a line of credit with an affiliate of GE Capital with an aggregate borrowing limit of £10 million. There was no outstanding balance as of December 31, 2003, 2002 or 2001, and we did not incur any interest expense under this line of credit.

We, along with GE Capital, are participants in a revolving credit agreement that involves an international cash pooling arrangement on behalf of a number of GE subsidiaries in Europe, including some of our European subsidiaries. In these roles, either participant may make short-term loans to the other as part of the cash pooling arrangement. Each such borrowing is repayable upon demand, but not later than 364 days after borrowed. This unsecured line of credit bears interest at a rate equal to GE Capital's cost of funds for the currency in which such borrowing is denominated. This credit facility has an annual term, but is automatically extended for successive terms of one year each, unless terminated in accordance with the terms of the agreement. We had a net receivable of \$9 million and \$85 million under this credit facility as of December 31, 2003 and 2002, respectively.

In connection with our initial public offering and separation from GE, we intend to replace the lines of credit and revolving credit agreement described above with revolving credit and other debt facilities entered into with unaffiliated third-parties. See "Management's Discussion and Analysis of Financial Condition and Results of Operations—Liquidity and Capital Resources" and "Description of Certain Indebtedness—New Credit Facilities."

### ***Sale of securities to affiliate***

During 2002, we sold certain available-for-sale fixed maturities to a subsidiary of GE Capital that is not consolidated in our financial statements, at fair value, which resulted in net realized investment gains of \$114 million.

### ***Real estate and loan transactions***

We sell to GE Mortgage Services, an affiliate of GE, properties acquired through claim settlement in our U.S. mortgage insurance business at a price equal to the product of the property's fair value and an agreed-upon price factor. Under these arrangements, we received from GE Mortgage Services \$9 million, \$13 million and \$11 million for the years ended December 31, 2003, 2002 and 2001, respectively. After the completion of this offering, we expect to phase out over time the arrangements under which we sell properties to GE Mortgage Services, as we take on the role ourselves of holding and disposing of these properties. During 2003, we also arranged for the sale to GE Mortgage Services of some residential loans acquired in connection with loss mitigation activities in our U.S. mortgage

253

---

insurance business and agreed to indemnify GE Mortgage Services for any loss relating to those loans. After the completion of this offering, we will enter into new arrangements relating to residential loans that GE Mortgage Services may purchase from us from time to time in the future. See "Business—Mortgage Insurance—U.S. Mortgage Insurance—Loans in default and claims" and "Arrangements Between GE and Our Company—Relationship with GE—Mortgage Services Agreement" relating to our arrangements with GE Mortgage Services.

### ***Guarantees provided by GE***

GE Capital from time to time has provided guarantees or other support arrangements on our behalf, including performance guarantees and support agreements relating to securitizations and comfort letters provided to government agencies. We have not incurred charges or reimbursed GE under any of these arrangements. After the completion of this offering, many of the guarantees currently in place will continue as provided under their existing terms, and we will not be required to incur any charges for the provision of these guarantees or other support arrangements, other than pursuant to our obligations under the Master Agreement to indemnify GE for losses arising out of these arrangements.

### ***GE agreements with third parties***

Historically, we have received services provided by third parties pursuant to various agreements that GE has entered into for the benefit of its affiliates. We pay the third parties directly for the services they provide to us or reimburse GE for our share of the actual costs incurred under the agreements. After the completion of this offering, we intend to continue to procure some of these third-party services through GE to the extent we are permitted (and elect to) or required to do so.

### Products and services provided to GE

We have provided various products and services to GE on terms comparable to those we provide to third parties. Except as described below, we expect to continue to provide these services following completion of the offering. These products and services include the following:

- We distribute our European payment protection insurance in part through arrangements with GE's consumer finance division and other related GE entities, for which we have received gross written premiums of \$293 million, \$218 million and \$194 million for the years ended December 31, 2003, 2002 and 2001, respectively. See "Business—Protection—European payment protection insurance."
- We reinsure lease obligation insurance and credit insurance marketed by GE Capital, for which we received premiums of \$94 million, \$105 million and \$92 million for the years ended December 31, 2003, 2002 and 2001, respectively. See "Business—Corporate and Other—Viking Insurance Company" and "Arrangements Between GE and Our Company—Relationship with GE—Agreement Regarding Continued Reinsurance by Viking."
- We provide long-term care insurance to certain GE employees, for which we have received premiums of \$24 million, \$20 million and \$20 million for the years ended December 31, 2003, 2002 and 2001. See "Business—Protection—Long-term care insurance."
- We distribute GE mutual funds through our wholly-owned broker-dealers, and provide administrative support for our variable annuity customers that have GE mutual funds within their contracts, for which we received \$4 million for each of the years ended December 31, 2003, 2002 and 2001 from the mutual funds and GEAM, the asset manager of these funds.
- We historically have marketed a mortgage unemployment credit insurance product underwritten by a GEFAHI subsidiary that will not be part of our company after the completion of this offering. We received no revenues in connection with this arrangement, but were reimbursed for actual costs. Following the offering, we intend to market and underwrite this product using a third-party provider.

254

### Ownership of Common Stock

Prior to the completion of this offering and the concurrent offerings, all shares of our common stock were owned by GEFAHI, an indirect subsidiary of GE. Upon the completion of this offering and the concurrent offerings, GE (through GEFAHI) will beneficially own approximately % of our outstanding common stock, consisting of 100% of our outstanding shares of Class B Common Stock and no shares of Class A Common Stock, assuming the underwriters' over-allotment option is not exercised, and %, if it is exercised in full.

This offering, together with the concurrent offerings, is the first step in GE's plan to dispose of more than 50% by value of its interest in us. GE's transfer of assets to us has been structured to qualify for the election under section 338 of the Internal Revenue Code, and GE has received a ruling from the IRS that the transfer will qualify for that election provided that certain conditions are met. Among those conditions is that GE must complete its disposition of more than 50% by value of its interest in our company within two years after the completion of this offering. GE has informed us that its failure to satisfy this condition and to qualify for the tax election would result both in significant additional tax liability for GE and in elimination of the section 338 benefit (and our associated liability) that is the subject of the Tax Matters Agreement, as discussed under "Arrangements Between GE and Our Company—Relationship with GE—Tax Matters Agreement." Accordingly, GE has informed us that it fully intends to and expects to meet this condition and has adopted a Plan of Divestiture under which it will effect the divestiture of our stock, more than 50% of which is to be divested by GE within two years after the completion of this offering. Although GE currently expects this divestiture to be effected through one or more additional public offerings of our common stock, if for any reason those additional public offerings are not completed or are not expected to satisfy the divestiture condition of the tax ruling and as called for in the Plan of Divestiture or if GE for any other reason decides to pursue an alternative method of disposition, GE has informed us that it intends to implement alternative methods to divest of our stock in order to carry out the Plan of Divestiture and satisfy the ruling condition.

The following table sets forth information as of April 1, 2004 regarding the beneficial ownership of our common stock by:

- all persons known by us to own beneficially more than 5% of our common stock, including GEFAHI;
- our chief executive officer and each of the named executive officers;
- each of our directors; and
- all directors and executive officers as a group.

Beneficial ownership is determined in accordance with the rules of the SEC. In computing the number of shares beneficially owned by a person and the percentage ownership of that person, shares of common stock subject to options held by that person that are currently exercisable or exercisable

255

within 60 days of April 1, 2004 are deemed to be issued and outstanding. These shares, however, are not deemed outstanding for purposes of computing percentage ownership of each other stockholder.

Name and Address of Beneficial Owner (1)	Beneficial Ownership Prior to the Completion of this Offering(2)		Number of Shares to be Sold in the Offering	Beneficial Ownership After the Completion of this Offering	
	Number	Percentage		Number	Percentage
GEFAHI (3)		100%			
Michael D. Fraizer (4)	—	—	—		*
Thomas H. Mann (5)	—	—	—		*
Pamela S. Schutz (5)	—	—	—		*
K. Rone Baldwin (5)	—	—	—		*
Leon E. Roday (5)	—	—	—		*
Elizabeth J. Comstock (6)	—	—	—	—	*

Pamela Daley (6)	—	—	—	—	*
Dennis D. Dammerman (6)	—	—	—	—	*
David R. Nissen (6)	—	—	—	—	*
James A. Parke (6)	—	—	—	—	*
All directors and executive officers as a group (19 persons)					
(5)	—	—	—		

\* Less than 1%.

- (1) The address for GE Financial Assurance Holdings, Inc. is 6620 West Broad Street, Richmond, Virginia 23230. The address for all other persons is c/o Genworth Financial, Inc., 6620 West Broad Street, Richmond, Virginia 23230. GE, as the ultimate parent of GEFAHI, beneficially owns all shares of our common stock owned of record by GEFAHI. The address for GE is 3135 Easton Turnpike, Fairfield, Connecticut 06828.
- (2) Reflects beneficial ownership in our common stock prior to the completion of this offering but after our corporate reorganization, pursuant to which we will acquire substantially all of the assets and liabilities of GEFAHI and acquire certain other GE insurance businesses, in exchange for \_\_\_\_\_ million shares of our Class B Common Stock, \$600 million of our Equity Units, \$100 million of our Series A Preferred Stock, the \$2.4 billion Short-term Intercompany Note and the \$550 million Contingent Note, all as described under "Corporate Reorganization."
- (3) Does not take into account shares that may be sold by GEFAHI in the event the underwriters' over-allotment option is exercised. If the underwriters' over-allotment option is exercised in full, GEFAHI will own approximately \_\_\_\_\_ shares of our Class B Common Stock, or approximately \_\_\_\_\_ % of all our outstanding common stock immediately after the completion of this offering.
- (4) Reflects: (a) shares of Class A Common Stock issuable upon the exercise of unvested employee stock options that will be issued on the date of this prospectus in exchange for unvested GE stock options, to the extent that such unvested employee stock options vest within 60 days of April 1, 2004, (b) shares of Class A Common Stock issuable upon the exercise of vested employee stock options that will be issued on the date of this prospectus in exchange for vested GE stock options held by Mr. Fraizer, and (c) shares of Class A Common Stock issuable upon the vesting of restricted stock units and stock appreciation rights that will be issued on the date of this prospectus in exchange for unvested GE restricted stock units and stock appreciation rights, to the extent that such restricted stock units and stock appreciation rights vest within 60 days of April 1, 2004.

256

- (5) Reflects: (a) shares of Class A Common Stock issuable upon the exercise of unvested employee stock options that will be issued on the date of this prospectus in exchange for unvested GE stock options, to the extent that such unvested employee stock options vest within 60 days of April 1, 2004, and (b) shares of Class A Common Stock issuable upon the vesting of restricted stock units that will be issued upon completion of this offering in exchange for unvested GE restricted stock units, to the extent that such restricted stock units vest within 60 days of April 1, 2004.
- (6) Each of the specified persons is a director or officer of GE and disclaims beneficial ownership of any shares of our common stock owned by GEFAHI.

257

## Description of Capital Stock

We were incorporated in Delaware on October 23, 2003. The following information reflects our amended and restated certificate of incorporation and amended and restated bylaws as these documents will be in effect upon the completion of this offering. The following descriptions are summaries of the material terms of these documents and relevant sections of the General Corporation Law of the State of Delaware, referred to as the DGCL. Our amended and restated certificate of incorporation and amended and restated bylaws have been filed as exhibits to the registration statement of which this prospectus forms a part, and we refer to them in this prospectus as the certificate of incorporation and bylaws, respectively. The summaries of these documents are qualified in their entirety by reference to the full text of the documents.

### General

Our authorized capital stock consists of \_\_\_\_\_ shares of Class A Common Stock, par value \$0.001 per share, \_\_\_\_\_ shares of Class B Common Stock, par value \$0.001 per share, and \_\_\_\_\_ shares of preferred stock, par value \$0.001 per share. Prior to this offering, there were no shares of Class A Common Stock and \_\_\_\_\_ shares of Class B Common Stock outstanding, all of which were held by GEFAHI. Immediately after the completion of this offering, \_\_\_\_\_ shares of Class A Common Stock and \_\_\_\_\_ shares of Class B Common Stock will be outstanding, assuming the over-allotment option is not exercised. \_\_\_\_\_ shares of our Series A Preferred Stock will also be outstanding immediately after the completion of this offering.

### Common Stock

#### Conversion

The Class B Common Stock may only be owned by GE and its affiliates. Upon any sale or other disposition by GE of shares of Class B Common Stock to any person other than GE or an affiliate of GE, such shares of Class B Common Stock will automatically be converted into shares of Class A Common Stock. In addition, on the first date on which GE no longer beneficially owns at least 10% of our outstanding common stock, all outstanding shares of Class B Common Stock will automatically be converted into shares of Class A Common Stock, and we will no longer be authorized to issue Class B Common Stock.

#### Voting Rights

Except for the approval rights of the holders of the Class B Common Stock over certain corporate actions and except with respect to the election and removal of directors, the holders of Class A Common Stock and Class B Common Stock have identical rights and will be entitled to one vote per share with respect to each matter presented to our stockholders on which the holders of common stock are entitled to vote. However, except as required by applicable law, holders of common stock will not be entitled to vote on any matter that solely relates to the terms of any outstanding series of preferred stock or the number of shares of such series and does not affect the number of authorized shares of preferred stock or the powers, privileges and rights pertaining to the common stock.

Subject to the rights of the holders of any outstanding series of our preferred stock, our certificate of incorporation provides that until the first date on which GE owns 50% or less of the outstanding shares of our common stock, the number of authorized directors of our company will be 9. Beginning on the first date on which GE owns 50% or less but at least 10% of the outstanding shares of our common stock, the number of authorized directors of our company will be 11. Beginning on the first date on which GE owns less than 10% of the outstanding shares of our common stock, the number of authorized directors of our company will be fixed from time to time by a resolution adopted by our

provides that until the first date on which GE owns less than 20% of our outstanding common stock, our board of directors will not establish an executive committee or any other committee having authority typically reserved for an executive committee.

At each election of members of our board of directors:

- when GE owns more than 50% of our outstanding common stock, GE as the holder of the Class B Common Stock will be entitled to elect five directors and the holders of the Class A Common Stock will be entitled to elect four directors;
- when GE owns at least 33% and no more than 50% of our outstanding common stock, GE as the holder of the Class B Common Stock will be entitled to elect four directors, the holders of the Class A Common Stock will be entitled to elect five directors, and the holders of the Class A Common Stock and the Class B Common Stock, voting together as a single class, will be entitled to elect all remaining directors entitled to be elected by the holders of our common stock;
- when GE owns at least 20% but less than 33% of our outstanding common stock, GE as the holder of the Class B Common Stock will be entitled to elect three directors, the holders of the Class A Common Stock will be entitled to elect five directors, and the holders of the Class A Common Stock and the Class B Common Stock, voting together as a single class, will be entitled to elect all remaining directors entitled to be elected by the holders of our common stock;
- when GE owns at least 10% but less than 20% of our outstanding common stock, GE as the holder of the Class B Common Stock will be entitled to elect one director, the holders of the Class A Common Stock will be entitled to elect five directors and the holders of the Class A Common Stock and the Class B Common Stock, voting together as a single class, will be entitled to elect all remaining directors entitled to be elected by the holders of our common stock; and
- when GE owns less than 10% of our common stock, all shares of Class B Common Stock held by GE will automatically convert into Class A Common Stock, and the holders of the Class A Common Stock will be entitled to elect all directors entitled to be elected by the holders of our common stock.

Each director elected by the holders of the common stock will serve until the earlier of his or her death, resignation, disqualification, removal or until his successor is elected and qualified. The common stock will not have cumulative voting rights in the election of directors.

#### ***Rights to Dividends and on Liquidation, Dissolution and Winding Up***

Subject to the prior rights of holders of preferred stock, if any, holders of Class A Common Stock and holders of Class B Common Stock are entitled to receive such dividends as may be lawfully declared from time to time by our board of directors. Upon any liquidation, dissolution or winding up of our company, whether voluntary or involuntary, holders of common stock will be entitled to receive such assets as are available for distribution to stockholders after there will have been paid or set apart for payment the full amounts necessary to satisfy any preferential or participating rights to which the holders of each outstanding series of preferred stock are entitled by the express terms of such series.

#### ***Other Rights***

The Class A Common Stock sold in this offering will not have any preemptive, subscription, redemption or conversion rights. The outstanding shares of our common stock are, and the shares of Class A Common Stock being offered hereby will be, upon payment for such shares, validly issued, fully paid and non-assessable. Subject to the approval rights of the holders of the Class B Common Stock, additional shares of authorized common stock may be issued, as determined by our board of directors

from time to time, without stockholder approval, except as may be required by applicable stock exchange requirements.

#### ***Listing***

The Class A Common Stock has been approved for listing on The New York Stock Exchange under the symbol "GNW."

#### **Approval Rights of Holders of Class B Common Stock**

In addition to any other vote required by law or by our certificate of incorporation, until the first date on which GE owns less than 15% of our outstanding common stock, the prior affirmative vote or written consent of GE as the holder of the Class B Common Stock is required to authorize us to adopt or implement any stockholder rights plan or similar takeover defense measure. Also, in addition to any other vote required by law or by our certificate of incorporation, until the first date on which GE owns less than 20% of our outstanding common stock, the prior affirmative vote or written consent of GE as the holder of the Class B Common Stock is required for the following actions (subject in each case to certain agreed exceptions):

- a merger involving us or any of our subsidiaries (other than mergers involving our subsidiaries to effect acquisitions permitted under the certificate of incorporation);
- acquisitions by us or our subsidiaries of the stock or assets of another business for a price (including assumed debt) in excess of \$700 million;
- dispositions by us or our subsidiaries of assets in a single transaction or a series of related transactions for a price (including assumed debt) in excess of \$700 million;
- incurrence or guarantee of debt by us or our subsidiaries in excess of \$700 million outstanding at any one time or that would reasonably be expected to result in a negative change in any of our credit ratings, excluding the debt described in this prospectus that we intend to incur concurrently with, and shortly after, the completion of this offering (provided that any debt in excess of \$500 million incurred under our commercial paper program and our five-year and 364-day revolving credit facilities will be subject to the \$700 million limitation described above), intercompany debt (within Genworth), debt incurred in connection with permitted securitization transactions and debt determined to constitute operating leverage by a nationally recognized statistical rating organization;
- issuance by us or our subsidiaries of capital stock or other securities convertible into capital stock;
- dissolution, liquidation or winding up of our company; and

- alteration, amendment, termination or repeal of or adoption of any provision inconsistent with, the provisions of our certificate of incorporation or our bylaws relating to our authorized capital stock, the role of our Nominating and Corporate Governance Committee, the establishment of an executive committee of our board of directors (or any committee having authority typically reserved for an executive committee), the rights granted to the holders of the Class B Common Stock, amendments to our bylaws, stockholder action by written consent, stockholder proposals and meetings, limitation of liability of and indemnification of our officers and directors, the rights of holders of our Class A Common Stock and Class B Common Stock to elect directors, the size of our board of directors, corporate opportunities and conflicts of interest between our company and GE, and Section 203 of the DGCL.

## Preferred Stock

Our certificate of incorporation authorizes our board of directors to establish one or more series of our preferred stock and to determine, with respect to any series of our preferred stock, the terms and rights of such series, including:

- the designation of the series;
- the number of shares of each series, which number our board of directors may thereafter, except where otherwise provided in the applicable certificate of designation, increase or decrease, but not below the number of shares thereof then outstanding;
- the rights in respect of any dividends or method of determining such dividends payable to the holders of the shares of such series, any conditions upon which such dividends will be paid and the dates or method of determining the dates upon which such dividends will be payable;
- whether dividends, if any, will be cumulative or noncumulative;
- the terms of redemption, if any, for shares of the series;
- the amount payable to holders of shares of the series in the event of any voluntary or involuntary liquidation, dissolution or winding up of our affairs;
- whether the shares of the series will be convertible or exchangeable into shares of any other class or series, or any other security, of our company or any other corporation, and, if so, the terms of such conversion or exchange;
- restrictions on the issuance of shares of the same series or of any other class or series;
- the voting rights, if any, of the holders of the shares of the series; and
- any other relative rights, preferences and limitations of the series.

Our board of directors has authorized the issuance of our Series A Preferred Stock, the terms of which are generally described below. We believe that the ability of our board of directors to issue one or more additional series of our preferred stock will provide us with flexibility in structuring possible future financings and acquisitions, and in meeting other corporate needs which might arise. Subject to the approval rights of the holders of the Class B Common Stock, the authorized shares of our preferred stock, as well as shares of our common stock, will be available for issuance without further action by our stockholders, unless such action is required by applicable law or the rules of any stock exchange or automated quotation system on which our securities may be listed or traded. The New York Stock Exchange currently requires stockholder approval in several instances as a prerequisite to listing shares, including where the present or potential issuance of shares could result in an increase in the number of shares of common stock, or in the amount of voting securities outstanding, of at least 20%. If the approval of our stockholders is not required for the issuance of shares of our preferred stock or our common stock, our board of directors may determine not to seek stockholder approval.

Although our board of directors has no intention at the present time of doing so, it could issue a series of our preferred stock that could, depending on the terms of such series, impede the completion of a merger, tender offer or other takeover attempt. Our board of directors will make any determination to issue such shares based on its judgment as to the best interests of us and our stockholders. Our board of directors, in so acting, could issue our preferred stock having terms that could discourage an acquisition attempt through which an acquirer may be able to change the composition of our board of directors, including a tender offer or other transaction that some, or a majority, of our stockholders might believe to be in their best interests or in which stockholders might receive a premium for their stock over the then-current market price of such stock.

### *Series A Preferred Stock*

As part of our corporate reorganization, we will issue \$100 million of Series A Preferred Stock to GEFAHI. GEFAHI will offer the Series A Preferred Stock by means of a separate prospectus concurrently with this offering.

#### *General*

The Series A Preferred Stock initially will be limited in aggregate amount to \$100 million. This amount is the sum of the aggregate liquidation amount per share of the Series A Preferred Stock. When issued and sold, the Series A Preferred Stock will have a liquidation preference per share equal to \$50 per share, plus unpaid dividends received to the date of liquidation and will be fully paid and non-assessable. The Series A Preferred Stock will rank junior to all of our indebtedness and other liabilities and will rank senior to our common stock. The Series A Preferred Stock will not be convertible into shares of common stock or any other securities of Genworth and will have no preemptive rights.

#### *Dividends*

Dividends on the Series A Preferred Stock will be fixed at an annual rate equal to \_\_\_\_\_ % of the sum of (1) the liquidation value of \$50 per share, plus (2) accumulated and unpaid dividends. Dividends will be payable quarterly in arrears on \_\_\_\_\_, \_\_\_\_\_, \_\_\_\_\_ and \_\_\_\_\_ of each year, beginning \_\_\_\_\_, 2004.

Dividends taxable as dividends to corporate holders of the Series A Preferred Stock may be eligible for the "dividends received deduction" as specified in Section 243(a)(1) of the Internal Revenue Code, subject to various limitations. In the event the percentage of the dividends received deduction is changed, certain adjustments will be made with respect to dividends on the Series A Preferred Stock.

### *Redemption*

We are required to redeem the Series A Preferred Stock on \_\_\_\_\_, 2011 in whole at a price of \$50.00 per share, plus unpaid dividends accrued to the date of redemption. There are no provisions for early redemption.

### *Voting rights*

*No voting rights.* Except as described below or otherwise required by applicable law, the holders of the Series A Preferred Stock will have no voting rights.

*Right to elect two additional directors during default period.* During any period, which we refer to in this section as the default period, in which accumulated distributions (whether or not earned or declared, and whether or not funds are then legally available in an amount sufficient therefor) have not been paid for six quarters (whether or not consecutive) or if we fail to perform our mandatory redemption obligation on \_\_\_\_\_, 2011, the number of directors constituting our board of directors will automatically be increased by two and the holders of record of the Series A Preferred Stock, together with holders of every other series of preferred stock that we may issue from time to time subsequent to this offering with the same voting rights that are then exercisable resulting from the failure to pay dividends or the failure to redeem, will possess full voting powers (to the exclusion of the holders of all other series and classes of our capital stock), voting together as a single class, to elect two directors to fill such newly created directorships.

A default period will continue unless and until all accumulated and unpaid distributions on all shares of the Series A Preferred Stock then outstanding have been paid at which time the voting rights described in the preceding paragraph will cease, subject always, however, to the reversion of such voting

262

---

power in the holders of the Series A Preferred Stock upon the commencement of an additional default period.

*Rights under applicable law.* Under current provisions of the DGCL, the holders of issued and outstanding preferred stock are entitled to vote as a class, with the consent of the majority of the class being required, to amend, alter or repeal any provision of our certificate of incorporation or by-law which would adversely affect the powers, preferences or rights of the preferred stock.

### *Liquidation rights*

In the event of any voluntary or involuntary liquidation, dissolution or winding up of our company, the holders of each share of the Series A Preferred Stock then outstanding will be entitled to receive and to be paid, out of our assets available for distribution to our shareholders after satisfying claims of creditors but before any payment or dissolution of assets is made to holders of our common stock or any other shares of our company of any class ranking junior to the Series A Preferred Stock upon such a liquidation, dissolution or winding up, liquidating distributions in an amount per share of \$50.00, plus an amount equal to accumulated and unpaid dividends (whether or not earned or declared) to and including the date of final dissolution. If, upon any such voluntary or involuntary liquidation, dissolution or winding up of the our company, the amounts payable with respect to the Series A Preferred Stock and any parity stock are not paid in full, the holders of such preferred stock will share ratably in any such distribution of assets of our company in proportion to the full respective amounts to which they are entitled.

### *Listing*

We have applied to list the Series A Preferred Stock on The New York Stock Exchange under the symbol "GNW Pr A."

### *Condition on the offering of Series A Preferred Stock*

The offering of Series A Preferred Stock is contingent upon the completion of this offering and the offering of our Equity Units, and this offering is contingent upon the completion of the offerings of the Series A Preferred Stock and our Equity Units.

## **Anti-Takeover Effects of Provisions of Our Certificate of Incorporation and Bylaws**

### *Board of Directors*

A director of our company may be removed for cause by the affirmative vote of the holders of at least a majority of the voting power of our outstanding Class A and Class B Common Stock (and any series of preferred stock entitled to vote in the election of directors), voting together as a single class. A director elected by the holders of the Class B Common Stock may be removed from office at any time, without cause, solely by the affirmative vote of the holders of the Class B Common Stock, voting as a separate class. A director elected by the vote of the holders of our Class A Common Stock, voting together as a single class, may be removed from office at any time, without cause, by the affirmative vote of the holders of a majority of our outstanding Class A Common Stock, voting together as a single class. A director elected by the vote of the holders of our Class A and Class B Common Stock, voting together as a single class, may be removed from office at any time, without cause, by the affirmative vote of the holders of a majority of our outstanding Class A and Class B Common Stock, voting together as a single class.

For so long as GE beneficially owns at least 10% of our outstanding common stock, vacancies in our board of directors resulting from an increase in the size of our board of directors from 9 to 11

263

---

when GE ceases to own more than 50% of our outstanding common stock (as provided by our certificate of incorporation) will be filled in the following manner:

- the first such vacancy will be filled by the vote of a majority of the directors elected by the holders of the Class A Common Stock; and
- the second such vacancy will be filled by the vote of a majority of the directors elected by the holders of the Class A Common Stock and the Class B Common Stock, voting together as a single class.

For so long as GE owns at least 10% of our outstanding common stock, vacancies among the directors elected by the holders of the Class B Common Stock may be filled only by the vote of a majority of the Class B Common Stock directors remaining in office or, if there are none, by the holders of the Class B Common Stock. Vacancies among the directors elected by the holders of the Class A Common Stock may be filled only by the vote of a majority of the Class A Common Stock directors remaining in office or, if there are none, by the holders of the Class A Common Stock. Vacancies among the directors elected by the holders of the Class A and Class B Common Stock voting together as a single class may be filled only by the vote of a majority of the directors elected by the holders of the Class A and Class B Common Stock remaining in office or, if there are none, by the holders of the Class A and Class B Common Stock voting together as a single class.

### ***Stockholder action by written consent; special meetings***

Our certificate of incorporation provides that except for actions taken by written consent by the holders of the Class B Common Stock with respect to matters subject to the approval only of the holders of the Class B Common Stock, any action required or permitted to be taken by our stockholders must be effected at a duly called annual or special meeting of such holders and may not be effected by any consent in writing by such holders. Until the first date on which GE owns less than 20% of our outstanding common stock, except as required by law and subject to the rights of the holders of any of our preferred stock, special meetings of our stockholders for any purpose or purposes may only be called by a majority of the whole board of directors or by GE as the holder of the Class B Common Stock. When GE owns less than 20% of our outstanding common stock, except as required by law and subject to the rights of the holders of any of our preferred stock, special meetings of our stockholders for any purpose or purposes may only be called by a majority of the whole board of directors or upon the written request of the holders of at least 40% of our outstanding common stock. No business other than that stated in the notice will be transacted at any special meeting. These provisions may have the effect of delaying consideration of a stockholder proposal until the next annual meeting unless a special meeting is called by our board, GE or our stockholders as described above.

### ***Advance notice requirements for nominations***

Except with respect to candidates nominated for election by holders of our Class B Common Stock, our bylaws contain advance notice procedures with regard to stockholder proposals related to the nomination of candidates for election as directors. These procedures provide that notice of stockholder proposals related to stockholder nominations for the election of directors must be received by our corporate secretary, in the case of an annual meeting, no later than the close of business on the 90th day nor earlier than the close of business on the 120th day prior to the anniversary date of the immediately preceding annual meeting of stockholders. However, if the annual meeting is called for a date that is more than 30 days before or more than 70 days after that anniversary date, notice by the stockholder in order to be timely must be received not earlier than the close of business on the 120th day prior to such annual meeting or not later than the close of business on the later of the 90th day prior to such annual meeting or the tenth day following the day on which public announcement is first made by us of the date of such meeting. If the number of directors to be elected to our board of directors at an annual meeting is increased and there is no public announcement by us naming the nominees for the additional directorships at least 100 days prior to the first anniversary of the

264

---

preceding year's annual meeting, a stockholder's notice will be considered timely, but only with respect to nominees for the additional directorships, if it is delivered to our corporate secretary not later than the close of business on the tenth day following the day on which such public announcement is first made by us.

Stockholder nominations for the election of directors at a special meeting must be received by our corporate secretary no earlier than the close of business on the 120th day prior to such special meeting and not later than the close of business on the later of the 90th day prior to such special meeting or the tenth day following the day on which public announcement is first made of the date of such special meeting and of the nominees proposed by our board of directors to be elected at such meeting.

A stockholder's notice to our corporate secretary must be in proper written form and must set forth information related to the stockholder giving the notice and the beneficial owner (if any) on whose behalf the nomination is made, including:

- the name and record address of the stockholder and the beneficial owner;
- the class and number of shares of our capital stock which are owned beneficially and of record by the stockholder and the beneficial owner;
- a representation that the stockholder is a holder of record of our stock entitled to vote at that meeting and that the stockholder intends to appear in person or by proxy at the meeting to bring the nomination before the meeting; and
- a representation whether the stockholder or the beneficial owner intends or is part of a group which intends to deliver a proxy statement or form of proxy to holders of at least the percentage of our outstanding capital stock required to elect the nominee, or otherwise to solicit proxies from stockholders in support of such nomination.

As to each person whom the stockholder proposes to nominate for election as a director:

- all information relating to the person that would be required to be disclosed in a proxy statement or other filings required to be made in connection with solicitations of proxies for election of directors pursuant to the Securities Exchange Act of 1934; and
- the nominee's written consent to being named in the proxy statement as a nominee and to serving as a director if elected.

### ***Advance notice requirements for stockholder proposals***

Our bylaws contain advance notice procedures with regard to stockholder proposals not related to director nominations. These notice procedures, in the case of an annual meeting of stockholders, are the same as the notice requirements for stockholder proposals related to director nominations discussed above insofar as they relate to the timing of receipt of notice by our corporate secretary.

A stockholder's notice to our corporate secretary must be in proper written form and must set forth, as to each matter the stockholder and the beneficial owner (if any) proposes to bring before the meeting:

- a description of the business desired to be brought before the meeting, the text of the proposal or business (including the text of any resolutions proposed for consideration and if such business includes a proposal to amend our bylaws, the language of the proposed amendment), the reasons for conducting the business at the meeting and any material interest in such business of such stockholder and beneficial owner on whose behalf the proposal is made;
- the name and record address of the stockholder and beneficial owner;
- the class and number of shares of our capital stock which are owned beneficially and of record by the stockholder and the beneficial owner;

265

---

- a representation that the stockholder is a holder of record of our stock entitled to vote at the meeting and that the stockholder intends to appear in person or by proxy at the meeting to propose such business; and
- a representation as to whether the stockholder or the beneficial owner intends or is part of a group which intends to deliver a proxy statement or form of proxy to holders of at least the percentage of our outstanding capital stock required to approve or adopt the business proposal, or otherwise to solicit proxies from

stockholders in support of such proposal.

### ***Amendments***

Subject to the right of the holders of our Class B Common Stock to withhold its consent to the amendment of the provisions of our certificate of incorporation relating to our authorized capital stock, the rights granted to the holders of the Class B Common Stock, the establishment of an executive committee of our board of directors (or any committee having authority typically reserved for an executive committee), amendments to our bylaws, stockholder action by written consent, the calling of stockholder meetings, limitation of liability of and indemnification of our officers and directors, the rights of holders of our Class A and Class B Common Stock to elect directors, the size of our board of directors, corporate opportunities and conflicts of interest between our company and GE, and Section 203 of the DGCL, the provisions of our certificate of incorporation may be amended by the affirmative vote of the holders of a majority of our outstanding common stock.

Subject to the right of the holders of our Class B Common Stock to withhold its consent to the amendment of the provisions of our bylaws relating to the role of our Nominating and Corporate Governance Committee in meetings of our stockholders, advance notice requirements for stockholder proposals related to directors' nominations and other proposed business, and our board of directors, the provisions of our bylaws may be amended by the affirmative vote of the holders of a majority of our outstanding common stock or by the affirmative vote of a majority of our entire board of directors.

### **Provisions of Our Certificate of Incorporation Relating to Related-Party Transactions and Corporate Opportunities**

In order to address potential conflicts of interest between us and GE, our certificate of incorporation contains provisions regulating and defining the conduct of our affairs as they may involve GE and its officers and directors, and our powers, rights, duties and liabilities and those of our officers, directors and shareholders in connection with our relationship with GE. In general, these provisions recognize that we and GE may engage in the same or similar business activities and lines of business, have an interest in the same areas of corporate opportunities and will continue to have contractual and business relations with each other, including officers and directors of GE serving as our directors.

Our certificate of incorporation provides that, subject to any written agreement to the contrary, GE will have no duty to refrain from:

- engaging in the same or similar business activities or lines of business as us; or
- doing business with any of our clients, customers or vendors.

Our certificate of incorporation provides that if GE acquires knowledge of a potential transaction or matter which may be a corporate opportunity for both us and GE, such corporate opportunity will belong to GE unless the corporate opportunity was expressly offered to GE in its capacity as a stockholder of Genworth. GE will to the fullest extent permitted by law have satisfied its fiduciary duty with respect to such a corporate opportunity and will not be liable to us or our stockholders for breach of any fiduciary duty as our stockholder by reason of the fact that GE acquires or seeks the corporate opportunity for itself, directs that corporate opportunity to another person or does not present that corporate opportunity to us.

266

---

If one of our directors or officers who is also a director or officer of GE learns of a potential transaction or matter that may be a corporate opportunity for both us and GE, our certificate of incorporation provides that the director or officer will have satisfied his or her fiduciary duties to us and our stockholders with respect to the corporate opportunity, and we will have renounced our interest in the corporate opportunity if the director or officer acts in good faith in a manner consistent with the following policy:

- a corporate opportunity offered to any of our directors who is not one of our officers and who is also a director or officer of GE will belong to us only if that opportunity is expressly offered to that person solely in his or her capacity as our director, and otherwise will belong to GE; and
- a corporate opportunity offered to any of our officers who is also an officer of GE will belong to us, unless that opportunity is expressly offered to that person solely in his or her capacity as an officer of GE, in which case that opportunity will belong to GE.

If one of our officers or directors, who also serves as a director or officer of GE, learns of a potential transaction or matter that may be a corporate opportunity for both us and GE in any manner not addressed in the foregoing descriptions, our certificate of incorporation provides that the director or officer will have no duty to communicate or present that corporate opportunity to us and will not be liable to us or our stockholders for breach of fiduciary duty by reason of GE's actions with respect to that corporate opportunity.

For purposes of our certificate of incorporation, "corporate opportunities" include, but are not limited to, business opportunities that we are financially able to undertake, that are, from their nature, in our line of business, are of practical advantage to us and are ones in which we have an interest or a reasonable expectancy, and in which, by embracing the opportunities, the self-interest of GE or its officers or directors will be brought into conflict with our self-interest.

By becoming a stockholder in our company, you will be deemed to have notice of and have consented to the provisions of our certificate of incorporation related to corporate opportunities that are described above.

### **Limitation of Liability and Indemnification Matters**

Section 145 of the DGCL provides that a corporation may indemnify directors and officers as well as other employees and individuals against expenses, including attorneys' fees, judgments, fines and amounts paid in settlement, that are incurred in connection with various actions, suits or proceedings, whether civil, criminal, administrative or investigative other than an action by or in the right of the corporation, known as a derivative action, if they acted in good faith and in a manner they reasonably believed to be in or not opposed to the best interests of the corporation, and, with respect to any criminal action or proceeding, if they had no reasonable cause to believe their conduct was unlawful. A similar standard is applicable in the case of derivative actions, except that indemnification only extends to expenses, including attorneys' fees, incurred in connection with the defense or settlement of such actions, and the statute requires court approval before there can be any indemnification if the person seeking indemnification has been found liable to the corporation. The statute provides that it is not excluding other indemnification that may be granted by a corporation's bylaws, disinterested director vote, stockholder vote, agreement or otherwise.

Our certificate of incorporation provides that each person who was or is made a party or is threatened to be made a party to or is involved in any action, suit or proceeding, whether civil, criminal, administrative or investigative, by reason of the fact that such person, or a person of whom such person is the legal representative, is or was a director or officer of us, or has or had agreed to become a director of us, or, while a director or officer of us, is or was serving at our request as a director, officer, employee or agent of another corporation or of a partnership, joint venture, trust, enterprise or nonprofit entity, including service with respect to employee benefit plans, whether the basis of such proceeding is the alleged action of such person in an official capacity as a director,

267



---

officer, employee or agent or in any other capacity while serving as a director, officer, employee or agent, will be indemnified and held harmless by us to the fullest extent authorized by the DGCL against all expense, liability and loss reasonably incurred or suffered by such person in connection therewith. Our certificate of incorporation also provides that we will pay the expenses incurred in defending any such proceeding in advance of its final disposition, subject to the provisions of the DGCL. These rights are not exclusive of any other right that any person may have or acquire under any statute, provision of our certificate of incorporation, bylaw, agreement, vote of stockholders or disinterested directors or otherwise. No repeal or modification of these provisions will in any way diminish or adversely affect the rights of any director, officer, employee or agent of us under our certificate of incorporation in respect of any occurrence or matter arising prior to any such repeal or modification. Our certificate of incorporation also specifically authorizes us to maintain insurance and to grant similar indemnification rights to our employees or agents.

Our certificate of incorporation provides that none of our directors will be personally liable to us or our stockholders for monetary damages for breach of fiduciary duty as a director, except, to the extent required by the DGCL, for liability:

- for any breach of the director's duty of loyalty to us or our stockholders;
- for acts or omissions not in good faith or which involve intentional misconduct or a knowing violation of law;
- for payments of unlawful dividends or unlawful stock purchases or redemptions under Section 174 of the DGCL; or
- for any transaction from which the director derived an improper personal benefit.

Neither the amendment nor repeal of this provision will eliminate or reduce the effect of the provision in respect of any matter occurring, or any cause of action, suit or claim that, but for the provision, would accrue or arise, prior to the amendment or repeal.

The Master Agreement also provides for indemnification by us of GE and its directors, officers and employees for specified liabilities, including liabilities under the Securities Act of 1933.

#### **Delaware Business Combination Statute**

Our certificate of incorporation contains a provision by which we expressly elect not to be governed by Section 203 of the DGCL, which is described below, until the moment in time, if ever, immediately following the time at which both of the following conditions exist: (a) Section 203 by its terms would, but for the terms of our certificate of incorporation, apply to us and (b) there occurs a transaction in which GE no longer owns at least 15% of our outstanding common stock. Accordingly, we are not currently subject to Section 203. Any person that acquires 15% or more of our outstanding common stock in the same transaction in which GE ceases to own at least 15% of our outstanding common stock will not be an interested stockholder under Section 203 as a result of that transaction.

Section 203 of the DGCL provides that, subject to exceptions set forth therein, an interested stockholder of a Delaware corporation shall not engage in any business combination, including mergers or consolidations or acquisitions of additional shares of the corporation, with the corporation for a three-year period following the time that such stockholder became an interested stockholder unless:

- prior to such time, the board of directors of the corporation approved either the business combination or the transaction which resulted in the stockholder becoming an interested stockholder;
- upon consummation of the transaction which resulted in the stockholder becoming an "interested stockholder," the interested stockholder owned at least 85% of the voting stock of the corporation outstanding at the time the transaction commenced, other than statutorily excluded shares; or

268

- 
- at or subsequent to such time, the business combination is approved by the board of directors of the corporation and authorized at an annual or special meeting of stockholders by the affirmative vote of at least 66<sup>2</sup>/<sub>3</sub>% of the outstanding voting stock which is not owned by the interested stockholder.

Except as otherwise set forth in Section 203, an interested stockholder is defined to include:

- any person that is the owner of 15% or more of the outstanding voting stock of the corporation, or is an affiliate or associate of the corporation and was the owner of 15% or more of the outstanding voting stock of the corporation at any time within three years immediately prior to the date of determination; and
- the affiliates and associates of any such person.

Our election to not be subject to Section 203 may have positive or negative consequences, depending on the circumstances. Being subject to Section 203 may make it more difficult for a person who would be an interested stockholder to effect various business combinations with us for a three-year period. Section 203 also may have the effect of preventing changes in our management. Section 203 also could make it more difficult to accomplish transactions which our stockholders may otherwise deem to be in their best interests. If the provisions of Section 203 were applicable, they may cause persons interested in acquiring us to negotiate in advance with our board of directors. In addition, because we did not elect to be subject to Section 203, GE, as a controlling stockholder, may find it easier to sell its controlling interest to a third party because Section 203 would not apply to such third party. The restrictions on business combinations set forth in Section 203 would not have been applicable to GE so long as GE continued to hold 15% or more of our common stock.

#### **Insurance Regulations Concerning Change of Control**

The insurance holding company laws of many states regulate changes of control of insurance holding companies, such as our company. Generally, these laws provide that control over an insurer is presumed to exist if any person, directly or indirectly, owns, controls, holds with the power to vote, or holds proxies representing, 10% or more of the voting securities of the insurer. Control also may be found to exist through contractual or other arrangements notwithstanding stock ownership. The Delaware, New York, North Carolina and Virginia insurance holding company laws, and similar laws in the U.K. and other jurisdictions in which we operate, require filings in connection with proposed acquisitions of control of domestic insurance companies. These laws may discourage potential acquisition proposals and may delay, deter or prevent a change of control involving us, including through transactions, and in particular unsolicited transactions, that some or all of our stockholders might consider to be desirable.

#### **Transfer Agent and Registrar**

The transfer agent and registrar for our Class A Common Stock and our Series A Preferred Stock will be The Bank of New York.

269

---

## Description of Equity Units

In this description, the words "we," "us" and "our" refer only to Genworth and not to any of its subsidiaries.

### Summary

As part of our corporate reorganization, we will issue \$600 million of our Equity Units to GEFAHI, and GEFAHI will offer these Equity Units by means of a separate prospectus concurrently with this offering. The Equity Units initially will be issued in the form of Corporate Units. Each Corporate Unit will initially consist of:

- a contract to purchase shares of our Class A Common Stock, which we refer to as the stock purchase contracts; and
- a \$25 ownership interest in our % senior notes due 2009, which we refer to as the notes.

The stock purchase contract that is a component of an Equity Unit requires the holder to purchase, and us to sell, for \$25, on , 2007, which we refer to as the purchase contract settlement date, a number of newly issued shares of our Class A Common Stock equal to a settlement rate based on the average trading price of our Class A Common Stock at that time. We will also pay quarterly contract adjustment payments on each stock purchase contract at an annual rate of % of the stated amount of \$25 per Equity Unit.

As described below, the notes will be remarketed to new purchasers immediately prior to the purchase contract settlement date to generate the cash necessary for the holders of Corporate Units to satisfy their obligations to purchase our Class A Common Stock pursuant to the stock purchase contract. The interest rate on the notes will be reset in the remarketing to whatever interest rate is necessary to induce purchasers to purchase all the notes remarketed at 100% of their principal amount. If the notes are not successfully remarketed prior to the purchase contract settlement date, all holders of notes will have the right to require us to purchase their notes on the purchase contract settlement date at a price equal to 100% of their principal amount, plus accrued interest.

### The Stock Purchase Contracts

Each stock purchase contract that is a component of an Equity Unit obligates the holder of the stock purchase contract to purchase, and obligates us to sell, on , 2007, for \$25 in cash, a number of newly issued shares of our Class A Common Stock equal to the settlement rate. The settlement rate, subject to anti-dilution adjustments, will be calculated as described below:

- if the applicable market value of our Class A Common Stock is equal to or greater than \$ , which we refer to as the threshold appreciation price, the settlement rate will be shares of our Class A Common Stock.

Accordingly, if the market value for the Class A Common Stock increases between the date of this prospectus and the period during which the applicable market value is measured and the applicable market value is greater than the threshold appreciation price, the aggregate market value of the shares of Class A Common Stock issued upon settlement of each purchase contract will be higher than the stated amount, assuming that the market price of the Class A Common Stock on the purchase contract settlement date is the same as the applicable market value of the Class A Common Stock. If the applicable market value is the same as the threshold appreciation price, the aggregate market value of the shares issued upon settlement will be equal to the stated amount, assuming that the market price of the Class A Common Stock on the purchase contract settlement date is the same as the applicable market value of the Class A Common Stock.

- if the applicable market value of our Class A Common Stock is less than the threshold appreciation price but greater than \$ , which we refer to as the reference price, the

270

---

settlement rate will be a number of shares of our Class A Common Stock equal to the stated amount of \$25 divided by the applicable market value.

Accordingly, if the market value for the Class A Common Stock increases between the date of this prospectus and the period during which the applicable market value is measured, but the applicable market value does not exceed the threshold appreciation price, the aggregate market value of the shares of Class A Common Stock issued upon settlement of each purchase contract will be equal to the stated amount, assuming that the market price of the Class A Common Stock on the purchase contract settlement date is the same as the applicable market value of the Class A Common Stock.

- if the applicable market value is less than or equal to the reference price of \$ , the settlement rate will be shares of our Class A Common Stock.

Accordingly, if the market value for the Class A Common Stock decreases between the date of this prospectus and the period during which the applicable market value is measured and the applicable market value is measured and the applicable market value is less than the reference price, the aggregate market value of the shares of Class A Common Stock issued upon settlement of each purchase contract will be less than the stated amount, assuming that the market price on the purchase contract settlement date is the same as the applicable market value of the Class A Common Stock. If the applicable market value is the same as the reference price, the aggregate market value of the shares will be equal to the stated amount, assuming that the market price of the Class A Common Stock on the purchase contract settlement date is the same as the applicable market value of the Class A Common Stock.

By applicable market value we mean the average of the closing price per share of our Class A Common Stock on The New York Stock Exchange on each of the twenty consecutive trading days ending on the third trading day immediately preceding the purchase contract settlement date. The reference price is equal to the initial public offering price of our Class A Common Stock in this offering.

We will pay holders of Equity Units quarterly contract adjustment payments on each stock purchase contract at a rate of % per year of the stated amount of \$25 per Equity Unit, or \$ per year.

On the purchase contract settlement date, an Equity Unit holder may satisfy its obligations under the stock purchase contracts by:

- in the case of the Corporate Units, (i) through the automatic application of the proceeds of the remarketing or if the Treasury portfolio has replaced the notes as a component of the Corporate Units as a result of a special event redemption, as defined below, through the automatic application of the proceeds of the Treasury portfolio, (ii) by exercising its right to require us to purchase its notes if the remarketing of the notes is not successful, or (iii) by delivering \$25 in cash; or
- in the case of the Treasury Units, as defined below, through the automatic application of the proceeds of the Treasury securities.

The ownership interest in notes that is a component of each Corporate Unit will be pledged to us to secure the holder's obligations to purchase our Class A Common Stock from us under the stock purchase contract.

The stock purchase contracts and the obligations of both us and the holders of the Equity Units under the stock purchase contracts automatically terminate without any further action upon certain events relating to our bankruptcy, insolvency or reorganization.

271

---

### Early Settlement of Stock Purchase Contracts

Holders of Equity Units may elect to settle the stock purchase contracts early by delivering \$25 in cash at any time following \_\_\_\_\_, 2005 (the date 12 calendar months following the completion of this offering) through the seventh business day immediately preceding the purchase contract settlement date in the case of Corporate Units or any time through the second business day immediately preceding the purchase contract settlement date using cash in the case of Treasury Units, in which case \_\_\_\_\_ shares of our Class A Common Stock will be issued pursuant to each stock purchase contract. We refer to this as optional early settlement. Optional early settlement of the stock purchase contracts results in the issuance of a number of shares of our Class A Common Stock equal to the minimum settlement rate, which is the same number that would be issued on the purchase contract settlement date if the applicable market value was equal to or greater than the threshold appreciation price of \$ \_\_\_\_\_, regardless of the actual market value of our Class A Common Stock at the time of the optional early settlement.

If we are involved in a merger in which at least 30% of the consideration for our Class A Common Stock consists of cash or cash equivalents, then each holder of an Equity Unit will have the right to settle the component stock purchase contract at the settlement rate in effect immediately before the closing of the cash merger, based on the applicable market value of our Class A Common Stock as if the closing date of the merger was the purchase contract settlement date, by delivering \$25 in cash. We refer to this as cash merger early settlement. If a holder elects cash merger early settlement, we will deliver to such holder on the cash merger early settlement date the kind and amount of securities, cash or other property that such holder would have been entitled to receive in the cash merger if it had settled the stock purchase contract immediately before the cash merger.

Following either optional early settlement or cash merger early settlement, the Equity Units of which the settled stock purchase contracts were a component will be cancelled and the related note or Treasury Security will be released to the holder and then will be separately transferable.

Both optional early settlement and cash merger early settlement are subject to the condition that if required under the U.S. federal securities laws, we have a registration statement under the Securities Act of 1933 in effect and a prospectus available covering the Class A Common Stock or other securities deliverable upon settlement of a stock purchase contract. We will agree to use our commercially reasonable efforts to have a registration statement in effect and to provide a prospectus covering such Class A Common Stock or other securities if so required by the U.S. federal securities laws.

### Remarketing

Remarketing allows holders of Corporate Units to satisfy their obligations under the related stock purchase contracts by reselling the notes through the remarketing agent and using the proceeds of the remarketing to pay the purchase price under the related stock purchase contracts. Holders of notes that are separate from the Corporate Units also may elect to participate in the remarketing. Unless one of the conditions to remarketing, which include the effectiveness of a registration statement under the Securities Act of 1933, if required by the U.S. federal securities laws, is not satisfied, the notes that underlie each outstanding Corporate Unit (other than Corporate Units for which the holder has elected to settle the related stock purchase contracts with separate cash on the purchase contract settlement date) as well as any other notes the holders of which have decided to have included in the remarketing will be remarketed on the fifth business day immediately preceding the purchase contract settlement date. If such remarketing is not successful, remarketings will also be attempted on the fourth business day immediately preceding the purchase contract settlement date, and, if necessary, the third business day immediately preceding the purchase contract settlement date.

Upon a successful remarketing, the portion of the proceeds equal to the aggregate principal amount of the notes remarketed that underlie the Corporate Units will automatically be applied to

272

---

satisfy in full the Corporate Units holders' obligations to purchase our Class A Common Stock under the related stock purchase contracts. If any proceeds remain after satisfying such obligations, the remarketing agent will remit such remaining proceeds to the purchase contract agent for the benefit of the holders. We will pay a separate fee to the remarketing agent for its services, and holders of notes will not in any way be responsible for paying any fee to the remarketing agent.

If the notes have not been successfully remarketed on or prior to the third business day immediately prior to the purchase contract settlement date, either because the remarketing agent cannot obtain a price of at least 100% of the total principal amount of the notes remarketed or because one of the conditions to the remarketing has not been satisfied, holders of all notes will have the right to require us to purchase their notes for an amount equal to the principal amount of their notes, plus accrued and unpaid interest, on the purchase contract settlement date. A holder of Corporate Units will be deemed to have automatically exercised this right with respect to the notes underlying such Corporate Units, unless such holder has settled the related stock purchase contracts with separate cash on or prior to the purchase contract settlement date, and will be deemed to have elected to apply the amount of the proceeds equal to the principal amount of the notes against such holder's obligations to us under the related stock purchase contracts, thereby satisfying such obligations in full. Upon the application of such proceeds, we will deliver to such holder our Class A Common Stock pursuant to the related stock purchase contracts.

### Creation of Treasury Units

At any time on or prior to the seventh business day preceding the purchase contract settlement date, holders of Corporate Units will have the right to substitute a zero coupon U.S. Treasury security with a principal amount equal to that of the notes that mature on \_\_\_\_\_, 2007, thereby creating Treasury Units. The Treasury security that underlies the Treasury Units will be pledged to us to secure the holder's obligations under the stock purchase contract. Holders of Treasury Units may recreate Corporate Units at any time on or prior to the seventh business day preceding the purchase contract settlement date by substituting notes having a principal amount equal to the aggregate principal amount at stated maturity of the Treasury securities for which substitution is being made.

The components of the Corporate Units and the Treasury Units are not separately transferable while a part of the unit. Stock purchase contracts are never transferable except as part of a Corporate Unit or Treasury Unit. Notes are not transferable except as part of a Corporate Unit unless they are separated from the Corporate Unit, either through collateral substitution and creation of a Treasury Unit or following settlement of the stock purchase contracts. Treasury securities that are a component of a Treasury Unit are not transferable except as part of such Treasury Unit.

### Notes

Initially, interest on the notes will be payable quarterly at the annual rate of \_\_\_\_\_ % of the principal amount of the notes, to, but excluding \_\_\_\_\_, 2007, the purchase contract settlement date. Holders of Corporate Units will receive their pro rata share of interest payments on the notes underlying their Corporate Units.

Upon a successful remarketing, the reset rate will be the rate determined by the remarketing agent as the interest rate the notes should bear in order for the notes

remarketed to have an aggregate market value on the remarketing date of at least 100% of the aggregate principal amount of the notes remarketed. The reset rate may not exceed the maximum rate, if any, permitted by applicable law. Following a reset of the interest rate, the interest rate on the notes will equal the reset rate from, and including, the purchase contract settlement date, to but excluding, \_\_\_\_\_, 2009, the maturity date of the notes. The interest rate on the notes will not be reset if there is not a successful remarketing and interest will continue to be payable at the initial rate from and including the purchase contract settlement date to but excluding the maturity date of the notes. Following the purchase contract

---

settlement date, interest will be paid semi-annually, commencing \_\_\_\_\_, 2007, whether or not there has been a successful remarketing.

Prior to the earlier of a successful remarketing and the purchase contract settlement date, the notes are redeemable at our option, in whole but not in part, upon the occurrence and continuance of certain tax events or accounting events. If any such redemption, which we refer to as a special event redemption, occurs, the redemption price for the notes that underlie the Corporate Units will be paid to the collateral agent holding the notes as security for the obligations of the holders under the purchase contracts, who will apply such redemption price to purchase a portfolio of United States Treasury securities. Thereafter, the applicable ownership interests in such Treasury portfolio will replace the notes as a component of the Corporate Units and will be pledged to us. Holders of notes that do not underlie the Corporate Units will receive the redemption price in the special event redemption.

The notes will rank equally and ratably with all of our other unsecured and unsubordinated obligations.

#### **Listing**

The Corporate Units have been approved for listing on The New York Stock Exchange under the symbol "GNW Pr E." Neither the Treasury Units nor the notes will initially be listed, but if they are separately traded to a sufficient extent that the applicable exchange listing requirements are met, we will endeavor to cause the Treasury Units and the notes to be listed on the exchange on which the Corporate Units are listed.

#### **Condition on the Offering of the Equity Units**

The offering of the Equity Units is conditioned upon the completion of this offering and the concurrent offering of our Series A Preferred Stock and this offering is conditioned upon the completion of the offering of the Equity Units and the concurrent offering of our Series A Preferred Stock.

#### **Accounting Treatment**

The fair value of the Corporate Units we issue to GEFAHI will be recorded in our financial statements based on an allocation between the purchase contracts and the notes in proportion to their respective fair market values. The present value of the contract adjustment payments on the purchase contracts will be recorded as a liability and a reduction of stockholders' equity. This liability increases over three years by interest charges to the statement of earnings based on a constant rate calculation. Contract adjustment payments paid on the purchase contracts will reduce this liability.

The purchase contracts are forward transactions in our Class A Common Stock. Upon settlement of each stock purchase contract, we will receive \$25 for the purchase contract and will issue the requisite number of shares of our Class A Common Stock. The \$25 that we receive will increase stockholders' equity.

Before the issuance of our Class A Common Stock upon settlement of the purchase contracts, the purchase contracts will be reflected in our diluted earnings per share calculations using the treasury stock method. Under this method, the number of shares of our Class A Common Stock used in calculating diluted earnings per share (based on the settlement rate applied at the end of the reporting period) will be deemed to be increased by the excess, if any, of the number of shares that would be issued upon settlement of the purchase contracts at such time over the number of shares that could be purchased by us in the market (at the average market price during the period) using the proceeds receivable upon settlement. Consequently, we anticipate there will be no dilutive effect on our earnings per share except during periods when the average market price of our Class A Common Stock is above the threshold appreciation price of \$ \_\_\_\_\_.

---

### **Description of Certain Indebtedness**

In this description, the words "we," "us" and "our" refer only to Genworth and not to any of its subsidiaries.

#### **Short-term Intercompany Note**

As part of the consideration for the assets to be transferred to us in connection with our corporate reorganization, we will issue to GEFAHI the \$2.4 billion Short-term Intercompany Note that matures on \_\_\_\_\_, 2004.

#### **Contingent Note**

As part of the consideration for the assets to be transferred to us in connection with our corporate reorganization, we will issue to GEFAHI the \$550 million Contingent Note, which is a non-interest-bearing note that matures on the first anniversary of the completion of this offering. The Contingent Note will be a general unsecured obligation of our company and will be subordinated in right of payment to all of our existing and future senior indebtedness. The note will be repaid solely to the extent that statutory contingency reserves from our U.S. mortgage insurance business in excess of \$150 million are released and paid to us as a dividend. The release of these reserves and payment of the dividend by our U.S. mortgage insurance business to us are subject to statutory limitations, regulatory approval and the absence of any impact on our financial ratings, including both insurance subsidiary financial strength ratings and our senior unsecured debt credit ratings. We will be required to use reasonable best efforts to obtain all regulatory approvals that are required for our principal U.S. mortgage insurance subsidiary to release statutory contingency reserves and declare and pay a dividend to us to satisfy the repayment of the Contingent Note. Once we have obtained the required regulatory approvals and rating agency affirmations, GEFAHI has the right to require repayment of the note prior to the first anniversary of the completion of this offering. If regulatory approval has been obtained by the first anniversary date, but our financial ratings have not been affirmed, the Contingent Note will be extended for a period up to 12 months from the first anniversary date, if necessary, to obtain rating agency affirmation. We will be required to repay on the first anniversary date the portion of the principal amount of the Contingent Note for which we have received the required regulatory approvals and rating agency affirmations. If rating agency affirmation of our financial ratings is not obtained in respect of the unpaid principal balance of the Contingent Note during the extended period, the unpaid balance of the Contingent Note will be canceled. We will record any portion of the Contingent Note that is canceled as a capital contribution.

#### **Short-term Credit Facility**

Prior to the completion of this offering, we will enter into a \$2.4 billion 180-day credit facility with a syndicate of banks. We intend to borrow the entire amount available under that facility upon the completion of this offering to repay the \$2.4 billion Short-term Intercompany Note. We intend to repay the lenders under this facility with net proceeds from the issuance of senior notes and commercial paper, both of which we intend to complete shortly after the completion of this offering. This facility bears interest based upon, at our option, (1) the prime rate or (2) the Eurodollar rate, plus a margin of 0.30%.

### **New Senior Notes**

Shortly after the completion of this offering, we intend to offer an aggregate principal amount of approximately \$1.9 billion of senior notes in a public offering. The senior notes offering will be made pursuant to a separate prospectus. We will issue the senior notes in multiple series of varying maturities.

The senior notes will be unsecured obligations of Genworth, equal in right of payment with all other existing and future unsecured and unsubordinated indebtedness of Genworth and senior in right

275

---

of payment to any future subordinated indebtedness of Genworth. The senior notes will not be convertible into any other security or be entitled to the benefit of any sinking fund.

Certain tranches of the senior notes will be redeemable prior to maturity at our option at redemption prices reflecting make-whole premiums determined by reference to comparable U.S. Treasury securities, but in no event at redemption prices less than par.

The senior notes indenture will contain covenants that, among other things, will restrict our ability to engage in mergers, consolidations and transfers of substantially all of our assets. The senior notes indenture will also include various events of default customary for such type of agreements, such as failure to pay principal and interest when due on the senior notes, cross defaults on other indebtedness and certain events of bankruptcy, insolvency and reorganization.

We intend to apply the net proceeds from the offering of senior notes to the repayment of the short-term credit facility.

Some of the lenders under the short-term credit facility will be affiliates of the underwriters for the offering of senior notes. Because more than 10% of the net proceeds of the offering of senior notes, not including underwriting compensation, will be paid to affiliates of members of the National Association of Securities Dealers, Inc. (the "NASD") who are participating in the offering of senior notes, that offering will be conducted in compliance with Rule 2710(h) of the NASD.

### **Commercial Paper Facility**

Shortly after the completion of this offering, we intend to establish a \$1 billion principal amount at maturity commercial paper program and to issue approximately \$500 million principal amount at maturity in commercial paper from that program. We intend to apply the net proceeds from the issuance of commercial paper to the repayment of the short-term credit facility. Issuance of commercial paper may be subject to GE's right as the holder of the Class B Common Stock to approve our incurrence of debt in excess of \$700 million outstanding at any one time. See "Description of Capital Stock—Approval Rights of Holders of Class B Common Stock."

### **New Credit Facilities**

Prior to the completion of this offering, we will enter into two revolving credit facilities, each with a syndicate of banks and each with JPMorgan Chase Bank and Bank of America, N.A. acting as co-administrative agents. One of these is a \$1 billion five-year revolving credit facility, and the other is a \$1 billion 364-day revolving credit facility. Both revolving credit facilities are unsecured.

The five-year facility bears interest based upon, at our option, (1) the prime rate or (2) the Eurodollar rate, plus a margin of 0.17% to 0.60%. The 364-day facility bears interest based upon, at our option, (1) the prime rate or (2) the Eurodollar rate, plus a margin of 0.19% to 0.625%. In each case, the margin is determined based upon our senior, unsecured long-term debt rating.

Each facility requires us to maintain stockholders' interest, excluding accumulated non-owner changes in stockholders' interest, at the end of each fiscal quarter, that exceeds the sum of (1) \$6.9 billion and (2) 40% of our consolidated net income for each completed fiscal year ending on or prior to the end of such fiscal quarter (without any deductions for any fiscal year as to which there is a consolidated net loss). Each facility also limits our ability to create liens on our assets, enter into mergers and consolidations and enter into certain transactions with our affiliates.

Events of default under each facility include (1) the acquisition of more than 50% of our common stock by any person or group (other than GE), and (2) the occupation of a majority of the seats on our board of directors by persons who were neither nominated by our board of directors or by GE or appointed by directors so nominated.

Our ability to borrow under these facilities may be subject to GE's right as the holder of the Class B Common Stock to approve our incurrence of debt in excess of \$700 million outstanding at any one time. See "Description of Capital Stock—Approval Rights of Holders of Class B Common Stock."

276

---

### **Yen Notes**

In June 2001, GEFAHI sold ¥60 billion of 1.6% notes due June 20, 2011 in a public offering. These notes were issued under an indenture dated June 26, 2001 between GEFAHI and The Chase Manhattan Bank, as Trustee. Pursuant to the terms of the indenture, we will assume all obligations under the indenture and these notes in connection with our corporate reorganization and the transfer of substantially all of GEFAHI's assets to us. GEFAHI will be released from all its obligations under the indenture and the notes.

These existing senior notes constitute unsecured senior indebtedness and are senior in right of payment to all our existing and future subordinated indebtedness. The notes are not subject to redemption prior to maturity or to any sinking fund, except that the notes are redeemable as a result of certain changes in the tax laws of the U.S. The indenture contains covenants that, among other things, will restrict our ability to engage in mergers, consolidations and transfers of substantially all of our assets.

We have entered into arrangements with Morgan Stanley Derivative Products Inc. to swap our obligations under these notes to a U.S. dollar obligation with a principal amount of \$491 million and bearing interest at a rate of 4.84% per annum.

277

---

## Shares Eligible for Future Sale

Sales of substantial amounts of our common stock in the public market after our initial public offering or the perception that such sales could occur could adversely affect the market price of our common stock and our ability to raise equity capital in the future on terms favorable to us. We can make no prediction as to the effect, if any, that market sales of shares of common stock or the availability of shares of common stock for sale will have on the market price prevailing from time to time. The Class A Common Stock has been approved for listing on The New York Stock Exchange under the symbol "GNW." The Class B Common Stock will not be listed on any stock exchange.

### Sale of Restricted Shares

Upon completion of this offering and the concurrent offerings, we will have outstanding \_\_\_\_\_ million shares of Class A Common Stock and \_\_\_\_\_ million shares of Class B Common Stock (assuming the underwriters' over-allotment option is not exercised). All the shares of Class A Common Stock sold in this offering will be freely tradable without restriction or further registration under the Securities Act of 1933, except for any shares purchased by or owned by our "affiliates," as that term is defined in Rule 144 under the Securities Act of 1933. As defined in Rule 144, an affiliate of an issuer is a person that directly, or indirectly through one or more intermediaries, controls, is controlled by or is under common control with the issuer. Shares held by affiliates may not be resold in the absence of registration under the Securities Act of 1933 or pursuant to an exemption from registration, including, among others, the exemption provided by Rule 144 under the Securities Act of 1933. Approximately \_\_\_\_\_ of our shares of Class A Common Stock will be beneficially owned by our officers, directors and other affiliates immediately after the completion of this offering.

Upon completion of this offering and the concurrent offerings, GE will beneficially own approximately \_\_\_\_\_ % of our outstanding common stock (consisting of 100% of our outstanding shares of Class B Common Stock and no shares of Class A Common Stock), if the underwriters' over-allotment option is not exercised. This offering, together with the concurrent offerings, is the first step in GE's plan to dispose of more than 50% by value of its interest in us. GE's transfer of assets to us has been structured to qualify for the election under section 338 of the Internal Revenue Code, and GE has received a ruling from the IRS that the transfer will qualify for that election provided that certain conditions are met. Among those conditions is that GE must complete its disposition of more than 50% by value of its interest in Genworth within two years after the completion of this offering. GE has informed us that its failure to satisfy this condition and to qualify for the tax election would result both in significant additional tax liability for GE and in elimination of the section 338 benefit (and our associated liability) that is the subject of the Tax Matters Agreement, as discussed under "Arrangements Between GE and Our Company—Relationship with GE—Tax Matters Agreement." Accordingly, GE has informed us that it fully intends to and expects to meet this condition and has adopted a Plan of Divestiture under which it will effect the divestiture of our stock, more than 50% of which is to be divested by GE within two years after the completion of this offering. Although GE currently expects this divestiture to be effected through one or more additional public offerings of our common stock, if for any reason those additional public offerings are not completed or are not expected to satisfy the divestiture condition of the tax ruling and as called for in the Plan of Divestiture or if GE for any other reason decides to pursue an alternative method of disposition, GE has informed us that it intends to implement alternative methods to divest of our common stock in order to carry out the Plan of Divestiture and satisfy the ruling condition.

We are unable to predict whether significant numbers of shares will be sold in the open market or otherwise in anticipation of or following any sales of our shares by GE.

278

---

### Rule 144

In general, under Rule 144 as currently in effect, beginning 90 days after the date of this prospectus, a person who has beneficially owned for at least one year shares of common stock that are restricted securities would be entitled to sell within any three-month period a number of shares that does not exceed the greater of:

- 1% of the number of shares of common stock then outstanding or approximately \_\_\_\_\_ shares of common stock immediately after this offering and the concurrent offerings; or
- the average weekly trading volume of the common stock on The New York Stock Exchange during the four calendar weeks preceding the filing of a notice on Form 144 with respect to such sale.

Sales under Rule 144 are also subject to certain restrictions on the manner of sale, certain notice requirements, and the availability of current public information about us.

Under Rule 144(k), a person who has not been one of our affiliates at any time during the three months before a sale, and who has beneficially owned the restricted shares for at least two years, is entitled to sell the shares immediately after the date of this prospectus without complying with the manner of sale, public information, volume limitation or notice provisions of Rule 144.

### Lock-up Agreements

We, our executive officers and directors and GEFAHI have agreed with the underwriters pursuant to lock-up agreements that, subject to limited exceptions described in "Underwriters," for a period of 180 days after the date of this prospectus, we and they will not directly or indirectly, offer, pledge, sell, contract to sell, sell any option or contract to purchase or otherwise dispose of any shares of common stock or any securities convertible into or exercisable or exchangeable for shares of common stock, or in any manner transfer all or a portion of the economic consequences associated with the ownership of shares of common stock, or cause a registration statement covering any shares of common stock to be filed, without the prior written consent of Morgan Stanley & Co. Incorporated and Goldman, Sachs & Co. The underwriters do not have any present intention or arrangement to release any shares of common stock subject to lock-up agreements prior to the expiration of the lock-up period.

### Registration Rights

As described in "Arrangements Between GE and Our Company—Relationship with GE—Registration Rights Agreement," we will enter into a registration rights agreement with GE. We do not have any other contractual obligations to register our common stock.

279

---

## Certain United States Federal Tax Consequences for Non-U.S. Holders of Common Stock

This section summarizes certain material U.S. federal income and, to a limited extent, certain U.S. federal estate tax consequences to Non-U.S. Holders of the purchase, ownership and disposition of our common stock. A "Non-U.S. Holder" is a beneficial owner of our common stock that holds such stock as a capital asset and is generally an individual, corporation, estate or trust other than:

- an individual who is a citizen or resident of the U.S.;
- a corporation (or an entity taxed as a corporation for U.S. federal income tax purposes) created or organized in the U.S. or under the laws of the U.S. or of any subdivision thereof;
- an estate the income of which is includible in gross income for U.S. federal income tax purposes regardless of its source; and
- a trust if a court within the U.S. is able to exercise primary supervision over the administration of the trust and one or more U.S. persons have the authority to control all substantial decisions of the trust.

If a partnership holds common stock, the tax treatment of a partner will generally depend upon the status of the partner and the activities of the partnership. Special rules may apply if a Non-U.S. Holder is a "controlled foreign corporation," "passive foreign investment company" or "foreign personal holding company," as defined under the Internal Revenue Code, and to certain expatriates or former long-term residents of the U.S. If you fall within any of the foregoing categories, you should consult your own tax advisor to determine the U.S. federal, state, local and foreign tax consequences that may be relevant to you.

This summary does not describe all of the U.S. federal income tax consequences that may be relevant to the purchase, ownership and disposition of our common stock by a prospective Non-U.S. Holder in light of that investor's particular circumstances. In addition, this summary does not address alternative minimum taxes or state, local or foreign taxes.

This section is based upon the Internal Revenue Code of 1986, as amended, judicial decisions, final, temporary and proposed Treasury regulations, published rulings and other administrative pronouncements, changes to any of which subsequent to the date of this prospectus may affect the tax consequences described herein, possibly with retroactive effect.

**Please consult your own tax adviser as to the particular tax consequences to you of purchasing, holding and disposing of our common stock in your particular circumstances under the Code and the laws of any other taxing jurisdiction.**

### U.S. Trade or Business Income

For purposes of the discussion below, dividends and gains on the sale, exchange or other disposition of our common stock will be considered to be "U.S. trade or business income" if such income or gain is:

- effectively connected with the Non-U.S. Holder's conduct of a U.S. trade or business; or
- in the case of a treaty resident, attributable to a U.S. permanent establishment (or, in the case of an individual, a fixed base) maintained by the Non-U.S. Holder in the U.S.

Generally, U.S. trade or business income is subject to U.S. federal income tax on a net income basis at regular graduated U.S. federal income tax rates. Any U.S. trade or business income received by a Non-U.S. Holder that is a corporation also may, under specific circumstances, be subject to an

additional "branch profits tax" at a 30% rate (or a lower rate that may be specified by an applicable tax treaty).

### Dividends

Dividends, if any, that are paid to a Non-U.S. Holder of our common stock generally will be subject to withholding of U.S. federal income tax at a 30% rate (or a lower rate that may be specified by an applicable tax treaty). However, dividends that are U.S. trade or business income are not subject to the withholding tax. To claim an exemption from withholding in the case of U.S. trade or business income, or to claim the benefits of an applicable tax treaty, a Non-U.S. Holder must provide us or our paying agent with a properly executed IRS Form W-8ECI (in the case of U.S. trade or business income) or IRS Form W-8BEN (in the case of a treaty), or any successor form that the IRS designates, as applicable, prior to the payment of the dividends. The information provided in these IRS forms must be periodically updated. In certain circumstances, a Non-U.S. Holder who is claiming the benefits of an applicable tax treaty may be required (a) to obtain and to provide a U.S. taxpayer identification number or (b) to provide certain documentary evidence issued by governmental authorities of a foreign country to prove the Non-U.S. Holder's residence in that country. Also, Treasury regulations provide special procedures for payments of dividends through qualified intermediaries.

### Sale or Exchange of Our Common Stock

Except as described below and subject to the discussion below concerning backup withholding, any gain realized by a Non-U.S. Holder on the sale or exchange of our common stock generally will not be subject to U.S. federal income or withholding tax, unless:

- the gain is U.S. trade or business income;
- subject to certain exceptions, the Non-U.S. Holder is an individual who is present in the U.S. for 183 days or more in the taxable year of the disposition and meets certain other requirements; or
- we are or have been a "U.S. real property holding corporation" ("USRPHC") for U.S. federal income tax purposes at any time during the shorter of the five-year period ending on the date of disposition of our common stock and the Non-U.S. Holder's holding period for our common stock.

The tax relating to stock in a USRPHC does not apply to a Non-U.S. Holder whose holdings, actual and constructive, amount to 5% or less of our common stock at all times during the applicable period, provided that our common stock is regularly traded on an established securities market. As of the date of this offering, our common stock will be traded on an established securities market.

Generally, a corporation is a USRPHC if the fair market value of its "U.S. real property interests" equals 50% or more of the sum of the fair market values of (a) its worldwide real property interests and (b) its other assets used or held for use in a trade or business. We believe that we have not been and are not currently a USRPHC for U.S. federal income tax purposes, nor do we anticipate becoming a USRPHC in the future. However, no assurance can be given that we will not become a USRPHC. Non-U.S. Holders are urged to consult their tax advisers to determine the application of these rules to their disposition of our common stock.

### Federal Estate Taxes

Common stock owned or treated as owned by an individual who is a Non-U.S. Holder (as specifically defined for U.S. federal estate tax purposes) at the time of death will be included in the individual's gross estate for U.S. federal estate tax purposes and may be subject to U.S. federal estate tax, unless an applicable estate tax treaty provides

### Information Reporting Requirements and Backup Withholding

We must report annually to the IRS and to each Non-U.S. Holder any dividend that is paid to the Non-U.S. Holder. Copies of these information returns also may be made available under the provisions of a treaty or other agreement to the tax authorities of the country in which a Non-U.S. Holder resides. Treasury regulations provide that the backup withholding tax on such dividends (currently at a rate of 28%), as well as certain information reporting requirements, will not apply to dividends paid on our common stock if (a) the Non-U.S. Holder, prior to payment, provides a properly executed IRS Form W-8BEN certifying that the Non-U.S. Holder is not a U.S. person, or otherwise establishes an exemption, and (b) neither we nor our paying agent have actual knowledge, or reason to know, that the Non-U.S. Holder is a U.S. person or that the conditions of any other exemption are not, in fact, satisfied.

The payment of the gross proceeds from the sale, exchange or other disposition of our common stock to or through the U.S. office of any broker, U.S. or foreign, will be subject to information reporting and possible backup withholding unless (a) the Non-U.S. Holder, prior to payment, certifies its non-U.S. status under penalties of perjury or otherwise establishes an exemption, and (b) the broker does not have actual knowledge, or reason to know, that the Non-U.S. Holder is a U.S. person or that the conditions of any other exemption are not, in fact, satisfied. The payment of the gross proceeds from the sale, exchange or other disposition of our common stock to or through a non-U.S. office of a non-U.S. broker will not be subject to information reporting or backup withholding unless the non-U.S. broker has certain types of relationships with the U.S. that render the broker a "U.S.-related person." In the case of the payment of the gross proceeds from the sale, exchange or other disposition of our common stock to or through a non-U.S. office of a broker that is either a U.S. person or a U.S.-related person, Treasury regulations require information reporting (but not backup withholding) on the payment unless (a) the broker, prior to payment, has documentary evidence in its files that the owner is a Non-U.S. Holder, and (b) the broker has no knowledge, or reason to know, to the contrary.

Backup withholding is not an additional tax. Any amounts withheld under the backup withholding rules may be refunded or credited against the Non-U.S. Holder's U.S. federal income tax liability, provided that the required information is provided to the IRS.

**The preceding discussion of certain material U.S. federal income and estate tax consequences is general information only and is not tax advice. Accordingly, you should consult your own tax adviser as to the particular tax consequences to you of purchasing, holding or disposing of our common stock, including the applicability and effect of any state, local or Non-U.S. tax laws, and of any changes or proposed changes in applicable law.**

### Underwriters

Under the terms and subject to the conditions contained in an underwriting agreement dated the date of this prospectus, the underwriters named below, for whom Morgan Stanley & Co. Incorporated and Goldman, Sachs & Co. are acting as representatives, have severally agreed to purchase, and GEFAHI, the selling stockholder, has agreed to sell to them, severally, the number of shares of Class A Common Stock indicated below:

Name	Number of Shares
Morgan Stanley & Co. Incorporated	
Goldman, Sachs & Co.	
Banc of America Securities LLC	
Citigroup Global Markets Inc.	
Credit Suisse First Boston LLC	
Deutsche Bank Securities Inc.	
J.P. Morgan Securities Inc.	
Lehman Brothers Inc.	
Merrill Lynch, Pierce, Fenner & Smith Incorporated	
UBS Securities LLC	
Blaylock & Partners, L.P.	
Cochran, Caronia Securities LLC	
Dowling & Partners Securities LLC	
Edward D. Jones & Co., L.P.	
Fox-Pitt, Kelton Inc.	
Keefe, Bruyette & Woods, Inc.	
Legg Mason Wood Walker, Incorporated	
KeyBanc Capital Markets, a Division of McDonald Investments Inc.	
Raymond James & Associates, Inc.	
Stephens Inc.	
The Williams Capital Group, L.P.	
Total	

Morgan Stanley & Co. Incorporated and Goldman, Sachs & Co. are the joint book-running managers of this offering.

The underwriters are offering the shares of Class A Common Stock subject to their acceptance of the shares from the selling stockholder and subject to prior sale. The underwriting agreement provides that the obligations of the several underwriters to pay for and accept delivery of the shares of Class A Common Stock offered by this prospectus are subject to the approval of certain legal matters by their counsel and to certain other conditions. These conditions include a condition that the offerings of our Equity Units and Series A Preferred Stock be consummated concurrently with this offering. The underwriters are obligated to take and pay for all of the shares of Class A Common Stock offered by this prospectus if any such shares are taken. However, the underwriters are not required to take or pay for the shares covered by the underwriters' over-allotment option described below.

The underwriters initially propose to offer part of the shares of Class A Common Stock directly to the public at the public offering price listed on the cover page of this prospectus and part to certain dealers at a price that represents a concession not in excess of \$ \_\_\_\_\_ a share under the public offering price. Any underwriter may allow, and such dealers may reallow, a concession not in excess of \$ \_\_\_\_\_ a share to other underwriters or to certain dealers. After the initial offering of the shares of Class A Common Stock, the offering price and other selling terms may from time to time be varied by the representatives.



---

The selling stockholder has granted to the underwriters an option, exercisable for 30 days from the date of this prospectus, to purchase up to an aggregate of additional shares of Class A Common Stock at the public offering price set forth on the cover page of this prospectus, less underwriting discounts and commissions. The underwriters may exercise this option solely for the purpose of covering over-allotments, if any, made in connection with the offering of the shares of Class A Common Stock offered by this prospectus. To the extent the option is exercised, each underwriter will become obligated, subject to certain conditions, to purchase about the same percentage of the additional shares of Class A Common Stock as the number listed next to the underwriter's name in the preceding table bears to the total number of shares of Class A Common Stock listed next to the names of all underwriters in the preceding table. If the underwriters' option is exercised in full, the total price to the public would be \$ , the total underwriters' discounts and commissions would be \$ and total proceeds to the selling stockholder would be \$ .

The underwriting discounts and commissions will be determined by negotiations among the selling stockholder and the representatives and are a percentage of the offering price to the public. Among the factors to be considered in determining the discounts and commissions will be the size of the offering, the nature of the security to be offered and the discounts and commissions charged in comparable transactions. The estimated offering expenses are approximately \$ , which includes legal, accounting and printing costs and various other fees associated with registering and listing the Class A Common Stock. All offering expenses will be payable by GE.

The underwriters have informed us that they do not intend sales to discretionary accounts to exceed five percent of the total number of shares of Class A Common Stock offered by them.

Prior to this offering, there has been no public market for our Class A Common Stock. The Class A Common Stock has been approved for listing on The New York Stock Exchange under the symbol "GNW." In order to meet one of the requirements for listing the Class A Common Stock on The New York Stock Exchange, the underwriters have undertaken to sell lots of 100 or more shares of Class A Common Stock to a minimum of 2,000 beneficial holders.

A prospectus in electronic format may be made available on web sites maintained by one or more underwriters. The underwriters may agree to allocate a number of shares to underwriters for sale to their online brokerage account holders. Internet distributions will be allocated by the joint book-running managers to underwriters that may make Internet distributions on the same basis as other allocations.

Each of Genworth, the selling stockholder, and the directors and executive officers of our company has agreed that, without the prior written consent of Morgan Stanley & Co. Incorporated and Goldman, Sachs & Co., on behalf of the underwriters, it will not, during the period ending 180-days after the date of this prospectus:

- offer, pledge, sell, contract to sell, sell any option or contract to purchase, purchase any option or contract to sell, grant any option, right or warrant to purchase, lend, or otherwise transfer or dispose of directly or indirectly, any shares of common stock or any securities convertible into or exercisable or exchangeable for common stock;
- file or cause to be filed any registration statement with the SEC relating to the offering of any shares of common stock or any securities convertible into or exercisable or exchangeable for common stock; or
- enter into any swap or other arrangement that transfers to another, in whole or in part, any of the economic consequences of ownership of the common stock;

284

---

whether any such transaction described above is to be settled by delivery of common stock or such other securities, in cash or otherwise. The restrictions described in this paragraph do not apply to:

- the sale of shares of Class A Common Stock to the underwriters;
- the sale of Equity Units to the underwriters of the concurrent offering or the issuance by us of Class A Common Stock pursuant to the conversion of the Equity Units;
- the grant by us of stock options, restricted stock or other awards pursuant to our benefit plans as described in this prospectus, provided that such options, restricted stock or awards do not become exercisable or vest during such 180-day period;
- the issuance by us of shares of Class A Common Stock in connection with the acquisition of another corporation or entity or the acquisition of assets or properties of any such corporation or entity, so long as the aggregate amount of such issuances does not exceed \$500 million and each of the recipients of the Class A Common Stock agrees in writing to be bound by the restrictions described in this paragraph for the remainder of such 180-day period;
- the private transfer by the selling stockholder of restricted shares of common stock, so long as the recipient of such common stock agrees in writing to be bound by the restrictions described in this paragraph for the remainder of such 180-day period;
- the issuance by us of shares of common stock upon the exercise of an option or a warrant or the conversion of a security outstanding on the date of this prospectus and which is

described in this prospectus of which the underwriters have been advised in writing (including, without limitation, the conversion of GE stock options, stock appreciation rights and restricted stock units into our stock options and restricted stock units and the issuance of common stock upon exercise or exchange thereof as described in this prospectus);

- transfers by directors or executive officers of shares of common stock by gift or to immediate family members, so long as the recipient of such common stock agrees in writing to be bound by the restrictions described in this paragraph for the remainder of such 180-day period;
- transactions by any person other than us relating to shares of common stock or other securities acquired in open market transactions after the closing of the offering of the shares; or
- the filing of a registration statement on Form S-8 relating to the issuance of stock options, restricted stock and other awards pursuant to our benefit plans as described in this prospectus.

The 180-day restricted period described above is subject to extension such that, in the event that either (1) during the last 17 days of the 180-day restricted period, we issue an earnings release or material news or a material event relating to us occurs or (2) prior to the expiration of the 180-day restricted period, we announce that we will release earnings results during the 16-day period beginning on the last day of the 180-day period, the "lock-up" restrictions described above subject to limited exceptions, will continue to apply until the expiration of the 18-day period beginning on the earnings release or the occurrence of the material news or material event.

In order to facilitate the offering of the Class A Common Stock, the underwriters may engage in transactions that stabilize, maintain or otherwise affect the price of the Class A Common Stock. Specifically, the underwriters may sell more shares than they are obligated to purchase under the underwriting agreement, creating a short position. A short sale or position may be either "covered" or "naked." A short sale is covered if the aggregate short position is no greater than the number of shares available for purchase by the underwriters under the over-allotment option. The underwriters can close out a covered short sale by exercising the over-allotment option or purchasing shares in the open market. In determining the source of shares to close out a covered short sale, the underwriters will consider, among other things, the open market price of shares compared to the price available under

285

---

the over-allotment option. The underwriters may also sell shares in excess of the over-allotment option, creating a naked short position to the extent of the excess. The underwriters must close out any naked short position by purchasing shares in the open market. A naked short position is more likely to be created if the underwriters are concerned that there may be downward pressure on the price of the Class A Common Stock in the open market after pricing that could adversely affect investors who purchase in the offering. As an additional means of facilitating the offering, the underwriters may bid for, and purchase, shares of Class A Common Stock in the open market to stabilize the price of the Class A Common Stock. The underwriting syndicate may also reclaim selling concessions allowed to an underwriter or a dealer for distributing the Class A Common Stock in the offering, if the syndicate repurchases previously distributed Class A Common Stock to cover syndicate short positions or to stabilize the price of the Class A Common Stock. These activities may raise or maintain the market price of the Class A Common Stock above independent market levels or prevent or retard a decline in the market price of the Class A Common Stock. The underwriters are not required to engage in these activities, and may end any of these activities at any time.

Each underwriter has represented, warranted and agreed that: (1) it has not offered or sold and, prior to the expiry of a period of six months from the closing date, will not offer or sell any shares of Class A Common Stock to persons in the United Kingdom except to persons whose ordinary activities involve them in acquiring, holding, managing or disposing of investments (as principal or agent) for the purposes of their businesses or otherwise in circumstances which have not resulted and will not result in an offer to the public in the United Kingdom within the meaning of the Public Offers of Securities Regulations 1995; (2) it has only communicated or caused to be communicated and will only communicate or cause to be communicated any invitation or inducement to engage in investment activity (within the meaning of section 21 of the Financial Services and Markets Act 2000 ("FSMA")) received by it in connection with the issue or sale of any shares in circumstances in which section 21(1) of the FSMA does not apply to the issuer; and (3) it has complied and will comply with all applicable provisions of the FSMA with respect to anything done by it in relation to the shares of Class A Common Stock in, from or otherwise involving the United Kingdom.

Neither we nor the selling stockholder has authorized any offer of the Class A Common Stock to the public in Belgium. The offering is exclusively conducted under applicable private placement exemptions and, therefore, it has not been notified to, and the prospectus or any other offering material relating to the Class A Common Stock has not been approved by, the Belgium Banking and Finance Commission (Commission Bancaire et Financière/Commissie voor het Bank- en Financiezeven). Accordingly, the offering may not be advertised and no offers, sales, resales, transfers or deliveries of the Class A Common Stock or any distributions of the prospectus or any other offering material relating to the Class A Common Stock may be made directly or indirectly, to any individual or legal entity in Belgium other than: (1) investors required to invest a minimum of €250,000 (per investor and per transaction); (2) institutional investors as defined in Article 3, 2°, of Belgian Royal Decree of 7 July 1999 on the public character of financial transactions, acting for their own account; and (3) persons for which the acquisition of the Class A Common Stock subject to the offering is necessary to enable them to exercise their professional activity.

The shares of Class A Common Stock may not be offered or sold by means of any document other than to persons whose ordinary business is to buy or sell shares or debentures, whether as principal or agent, or in circumstances which do not constitute an offer to the public within the meaning of the Companies Ordinance (Cap. 32) of Hong Kong, and no advertisement, invitation or document relating to the shares of Class A Common Stock may be issued, whether in Hong Kong or elsewhere, which is directed at, or the contents of which are likely to be accessed or read by, the public in Hong Kong (except if permitted to do so under the securities laws of Hong Kong) other than with respect to shares which are or are intended to be disposed of only to persons outside Hong Kong or only to

286

---

"professional investors" within the meaning of the Securities and Futures Ordinance (Cap. 571) of Hong Kong and any rules made thereunder.

Each underwriter has acknowledged and agreed that the securities have not been registered under the Securities and Exchange Law of Japan and are not being offered or sold and may not be offered or sold, directly or indirectly, in Japan or to or for the account of any resident of Japan, except: (i) pursuant to an exemption from the registration requirements of the Securities and Exchange Law of Japan and (ii) in compliance with any other applicable requirements of Japanese law.

The shares of Class A Common Stock may not be offered, transferred or sold in the Netherlands to any person other than to natural or legal persons who trade or invest in securities in the conduct of their profession or trade within the meaning of section 2 of the Exemption Regulation pursuant to The Netherlands Securities Market Supervision Act 1995 (*Vrijstellingsregeling Wet toezicht effectenverkeer 1995*), which includes banks, securities intermediaries (including dealers and brokers), insurance companies, central governments, large international and supranational institutions, pension funds, other institutional investors and commercial enterprises which, as an ancillary activity, regularly invest in securities in the conduct of a business or a profession.

This prospectus has not been registered as a prospectus with the Monetary Authority of Singapore. Accordingly, this prospectus and any other document or material in connection with the offer or sale, or invitation or subscription or purchase, of the shares may not be circulated or distributed, nor may the shares be offered or sold, or be made the subject of an invitation for subscription or purchase, whether directly or indirectly, to persons in Singapore other than under circumstances in which such offer, sale or invitation does not constitute an offer or sale, or invitation for subscription or purchase, of the shares to the public in Singapore.

From time to time, the underwriters or their affiliates have provided, and continue to provide, investment banking and other financial services to GE, us and other GE affiliates in the ordinary course of business. Certain underwriters in this offering will participate as underwriters in the concurrent offerings and the subsequent offering of senior notes. In addition, certain affiliates of the underwriters will be lenders under the short-term credit facility and the new revolving credit facilities.

We, the selling stockholder and the underwriters have agreed to indemnify each other against certain liabilities, including liabilities under the Securities Act of 1933.

### **Pricing of the Offering**

Prior to this offering, there has been no public market for the shares of Class A Common Stock. The initial public offering price will be determined by negotiations among Genworth, the selling stockholder and the representative of the underwriters. Among the factors to be considered in determining the initial public offering price will be the future prospects of our company and our industry in general, sales, earnings and certain other financial operating information of our company in recent periods, and the price-earnings ratios, price-to-book-value ratios, market prices of comparable companies and certain financial and operating information of companies engaged in activities similar to those of our company. The estimated initial public offering price range set forth on the cover page of this preliminary prospectus is subject to change as a result of market conditions and other factors.

287

---

---

## Legal Matters

The validity of the shares of Class A Common Stock offered hereby will be passed upon for us by Weil, Gotshal & Manges LLP, New York, New York. Certain legal matters will be passed upon for the underwriters by Davis Polk & Wardwell, New York, New York.

## Experts

The combined financial statements and schedule for Genworth Financial, Inc. as of December 31, 2003 and 2002, and for each of the years in the three-year period ended December 31, 2003 have been included herein in reliance upon the report of KPMG LLP, independent accountants, appearing elsewhere herein, and upon the authority of said firm as experts in accounting and auditing. The audit report refers to a change in accounting for variable interest entities in 2003, goodwill and other intangible assets in 2002, and derivative instruments and hedging activities in 2001.

The statement of financial position of Genworth Financial, Inc. as of December 31, 2003 has been included herein in reliance upon the report of KPMG LLP, independent accountants, appearing elsewhere herein, and upon the authority of said firm as experts in accounting and auditing.

## Additional Information

We have filed with the SEC a registration statement on Form S-1 with respect to the Class A Common Stock offered hereby. This prospectus, which constitutes a part of the registration statement, does not contain all the information set forth in the registration statement or the exhibits and schedules that are part of the registration statement. For further information with respect to us and our Class A Common Stock, reference is made to the registration statement and exhibits and schedules thereto. You may read and copy any document we file at the SEC's public reference room at 450 Fifth Street, N.W., Washington, D.C. 20549. Please call the SEC at 1-800-SEC-0330 for further information about the public reference room. Our SEC filings are also available to the public from the SEC's website at <http://www.sec.gov>.

Upon completion of this offering, we will become subject to the information and periodic reporting requirements of the Securities Exchange Act of 1934 and file periodic reports, proxy statements and other information with the SEC. These periodic reports, proxy statements and other information are available for inspection and copying at the SEC's public reference rooms and the website of the SEC referred to above.

You should rely only on the information contained in this prospectus. Neither we, nor the selling stockholder, nor the underwriters, have authorized anyone to provide you with information different from that contained in this prospectus. The selling stockholder is offering to sell and seeking offers to buy shares of Class A Common Stock only in jurisdictions where offers and sales are permitted. The information contained in this prospectus is accurate only as of the date of this prospectus, regardless of the time of delivery of this prospectus or of the sale of Class A Common Stock.

288

---

## Index to Financial Statements

	Page
<b>Combined Financial Statements:</b>	
Independent Auditors' Report of KPMG LLP	F-2
Combined Statement of Earnings for the years ended December 31, 2003, 2002 and 2001	F-3
Combined Statement of Financial Position as of December 31, 2003 and 2002	F-4
Combined Statement of Stockholder's Interest for the years ended December 31, 2003, 2002 and 2001	F-5
Combined Statement of Cash Flows for the years ended December 31, 2003, 2002 and 2001	F-6
Notes to Combined Financial Statements	F-7
<b>Genworth Financial, Inc.:</b>	
Independent Auditors' Report of KPMG LLP	F-57
Statement of Financial Position as of December 31, 2003	F-58
Note to Statement of Financial Position	F-58

F-1

---

WHEN THE TRANSACTIONS REFERRED TO IN NOTE 1 OF THE NOTES TO THE COMBINED FINANCIAL STATEMENTS HAVE BEEN CONSUMMATED, WE WILL BE IN A POSITION TO RENDER THE FOLLOWING REPORT.

/s/ KPMG LLP

## Independent Auditors' Report

The Board of Directors  
Genworth Financial, Inc.:

We have audited the accompanying combined statement of financial position of Genworth Financial, Inc. (the "Company") as of December 31, 2003 and 2002, and the related combined statements of earnings, stockholder's interest, and cash flows for each of the years in the three-year period ended December 31, 2003. These combined financial statements are the responsibility of the Company's management. Our responsibility is to express an opinion on these combined financial statements based on our audits.

We conducted our audits in accordance with auditing standards generally accepted in the United States of America. Those standards require that we plan and perform the

audit to obtain reasonable assurance about whether the financial statements are free of material misstatement. An audit includes examining, on a test basis, evidence supporting the amounts and disclosures in the financial statements. An audit also includes assessing the accounting principles used and significant estimates made by management, as well as evaluating the overall financial statement presentation. We believe that our audits provide a reasonable basis for our opinion.

In our opinion, the combined financial statements referred to above present fairly, in all material respects, the financial position of Genworth Financial, Inc. as of December 31, 2003 and 2002, and the results of its operations and its cash flows for each of the years in the three-year period ended December 31, 2003, in conformity with accounting principles generally accepted in the United States of America.

As discussed in note 2 to the combined financial statements, the Company changed its method of accounting for variable interest entities in 2003, its method of accounting for goodwill and other intangible assets in 2002, and its method of accounting for derivative instruments and hedging activities in 2001.

Richmond, Virginia  
February 6, 2004, except as to  
note 1, which is as of \_\_\_\_\_, 2004

F-2

**Genworth Financial, Inc.**  
**Combined Statement of Earnings**  
**(Dollar amounts in millions)**

	Years Ended December 31,		
	2003	2002	2001
<b>Revenues:</b>			
Premiums	\$ 6,703	\$ 6,107	\$ 6,012
Net investment income	4,015	3,979	3,895
Net realized investment gains	10	204	201
Policy fees and other income	943	939	993
<b>Total revenues</b>	<b>11,671</b>	<b>11,229</b>	<b>11,101</b>
<b>Benefits and expenses:</b>			
Benefits and other changes in policy reserves	5,232	4,640	4,474
Interest credited	1,624	1,645	1,620
Underwriting, acquisition, and insurance expenses, net of deferrals	1,942	1,808	1,823
Amortization of deferred acquisition costs and intangibles	1,351	1,221	1,237
Interest expense	140	124	126
<b>Total benefits and expenses</b>	<b>10,289</b>	<b>9,438</b>	<b>9,280</b>
Earnings from continuing operations before income taxes and accounting changes	1,382	1,791	1,821
Provision for income taxes	413	411	590
Net earnings from continuing operations before accounting changes	969	1,380	1,231
Net earnings (loss) from discontinued operations	186	(206)	180
Loss on sale of discontinued operations	(74)	—	—
<b>Net earnings before accounting changes</b>	<b>1,081</b>	<b>1,174</b>	<b>1,411</b>
Cumulative effect of accounting changes, net of taxes	—	—	(15)
<b>Net earnings</b>	<b>\$ 1,081</b>	<b>\$ 1,174</b>	<b>\$ 1,396</b>
<b>Pro forma earnings per share:</b>			
Basic			
Diluted			

See Notes to Combined Financial Statements

F-3

**Genworth Financial, Inc.**  
**Combined Statement of Financial Position**  
**(Dollar amounts in millions)**

	December 31,	
	2003	2002
<b>Assets</b>		
Investments:		
Fixed maturities available-for-sale, at fair value	\$ 65,485	\$ 60,797
Equity securities available-for-sale, at fair value	600	1,295
Mortgage and other loans, net of valuation allowance of \$50 and \$45	6,114	5,302
Policy loans	1,105	983
Short-term investments	531	833
Restricted investments held by securitization entities	1,069	—
Other invested assets	3,789	2,870
Total investments	78,693	72,080
Cash and cash equivalents	1,982	1,569
Accrued investment income	1,247	1,245
Deferred acquisition costs	5,788	5,332
Intangible assets	1,346	1,592
Goodwill	1,728	1,702
Reinsurance recoverable	2,334	2,202
Other assets (\$65 and \$0 restricted in securitization entities)	2,069	2,073
Separate account assets	8,244	7,484
Assets associated with discontinued operations	—	22,078
Total assets	\$ 103,431	\$ 117,357
<b>Liabilities and Stockholder's Interest</b>		
Liabilities:		
Future annuity and contract benefits	\$ 59,257	\$ 56,538
Liability for policy and contract claims	3,207	3,014
Unearned premiums	3,616	3,007
Other policyholder liabilities	465	636
Other liabilities	7,051	6,504
Non-recourse funding obligations	600	—
Short-term borrowings	2,239	1,850
Long-term borrowings	529	472
Deferred income taxes	1,405	1,088
Borrowings related to securitization entities	1,018	—
Separate account liabilities	8,244	7,484
Liabilities associated with discontinued operations	—	20,012
Total liabilities	87,631	100,605
Commitments and contingencies		
Stockholder's interest:		
Paid-in capital	8,377	8,079
Accumulated nonowner changes in stockholder's interest		
Net unrealized investment gains	1,518	1,218
Derivatives qualifying as hedges	(5)	(98)
Foreign currency translation adjustments	159	(285)
Total accumulated nonowner changes in stockholder's interest	1,672	835
Retained earnings	5,751	7,838
Total stockholder's interest	15,800	16,752
Total liabilities and stockholder's interest	\$ 103,431	\$ 117,357

See Notes to Combined Financial Statements

Genworth Financial, Inc.

Combined Statement of Stockholder's Interest

(Dollar amounts in millions)

	Paid-in capital	Accumulated nonowner changes in stockholder's interest	Retained earnings	Total stockholder's interest
Balances at January 1, 2001	\$ 7,941	\$ (424)	\$ 5,470	\$ 12,987
Changes other than transactions with stockholder:				
Net earnings	—	—	1,396	1,396
Net unrealized gains (losses) on investment securities	—	(55)	—	(55)
Cumulative effect on adoption of SFAS 133	—	(351)	—	(351)
Derivatives qualifying as hedges	—	183	—	183
Foreign currency translation adjustments	—	(17)	—	(17)
Total changes other than transactions with stockholder	—	—	—	1,156
Contributed capital	53	—	—	53
Dividends declared	—	—	(31)	(31)
Balances at December 31, 2001	7,994	(664)	6,835	14,165
Changes other than transactions with stockholder:				
Net earnings	—	—	1,174	1,174
Net unrealized gains (losses) on investment securities	—	1,514	—	1,514
Derivatives qualifying as hedges	—	70	—	70
Foreign currency translation adjustments	—	(85)	—	(85)
Total changes other than transactions with stockholder	—	—	—	2,673
Contributed capital	85	—	—	85
Dividends declared	—	—	(171)	(171)
Balances at December 31, 2002	8,079	835	7,838	16,752
Changes other than transactions with stockholder:				
Net earnings	—	—	1,081	1,081
Net unrealized gains (losses) on investment securities	—	300	—	300
Derivatives qualifying as hedges	—	93	—	93
Foreign currency translation adjustments	—	444	—	444
Total changes other than transactions with stockholder	—	—	—	1,918
Contributed capital	298	—	—	298
Dividends declared	—	—	(3,168)	(3,168)
Balances at December 31, 2003	\$ 8,377	\$ 1,672	\$ 5,751	\$ 15,800

See Notes to Combined Financial Statements

F-5

Genworth Financial, Inc.

Combined Statement of Cash Flows

(Dollar amounts in millions)

	Years Ended December 31,		
	2003	2002	2001
Cash flows from operating activities:			
Net earnings	\$ 1,081	\$ 1,174	\$ 1,396
Adjustments to reconcile net earnings to net cash provided by operating activities:			
Accretion (amortization) of investment discounts and premiums	18	(5)	(70)
Net realized investment gains	(10)	(204)	(201)
Charges assessed to policyholders	(295)	(198)	(312)
Acquisition costs deferred	(1,758)	(1,906)	(1,721)
Amortization of deferred acquisition costs and intangibles	1,351	1,221	1,237

Deferred income taxes	(63)	(55)	307
Corporate overhead allocation	36	31	27
Cumulative effect of accounting changes, net of taxes	—	—	15
Net (earnings) loss from discontinued operations	(186)	206	(180)
Net loss from sale of discontinued operations	74	—	—
Change in certain assets and liabilities:			
Accrued investment income and other assets	(136)	(223)	33
Insurance reserves	3,105	3,218	2,403
Other liabilities and other policy-related balances	499	1,624	(705)
Cash provided by operating activities	3,716	4,883	2,229
Cash flows from investing activities:			
Proceeds from maturities and repayments of investments:			
Fixed maturities	8,198	5,999	4,827
Mortgage, policy and other loans	1,711	533	979
Other invested assets	73	9	4
Proceeds from sales and securitizations of investments:			
Fixed maturities and equity securities	16,253	22,266	18,428
Other invested assets	110	74	158
Purchases and originations of investments:			
Fixed maturities and equity securities	(26,597)	(33,004)	(30,133)
Mortgage, policy and other loans	(2,653)	(1,438)	(1,100)
Other invested assets	(248)	(236)	(202)
Dividends received from discontinued operations	495	62	—
Payments for businesses purchased, net of cash acquired	44	(61)	(90)
Proceeds from sale of discontinued operations	1,631	—	—
Short-term investment activity, net	302	(729)	61
Cash used in investing activities	(681)	(6,525)	(7,068)
Cash flows from financing activities:			
Proceeds from issuance of investment contracts	8,262	9,749	10,507
Redemption and benefit payments on investment contracts	(8,994)	(7,279)	(5,882)
Proceeds from short-term borrowings	1,300	2,747	2,834
Payments on short-term borrowings	(927)	(3,036)	(2,794)
Proceeds from non-recourse funding obligations	600	—	—
Proceeds from long-term borrowings	—	—	488
Net commercial paper borrowings (repayments)	16	212	(551)
Dividend paid to stockholder	(3,232)	(132)	(6)
Capital contribution received from stockholder	261	32	31
Cash (used in) provided by financing activities	(2,714)	2,293	4,627
Effect of exchange rate changes on cash and cash equivalents	92	37	26
Net increase (decrease) in cash and cash equivalents	413	688	(186)
Cash and cash equivalents at beginning of year	1,569	881	1,067
Cash and cash equivalents at end of year	\$ 1,982	\$ 1,569	\$ 881

See Notes to Combined Financial Statements

F-6

**Genworth Financial, Inc.**

**Notes to Combined Financial Statements**

**Years Ended December 31, 2003, 2002 and 2001**

**(1) Formation of Genworth and Basis of Presentation**

Genworth Financial, Inc. ("Genworth") was incorporated in Delaware on October 23, 2003 in preparation for the corporate reorganization of certain insurance and related subsidiaries of General Electric Company ("GE") and a public offering of Genworth common stock. Genworth is a wholly-owned subsidiary of GE Financial Assurance Holdings, Inc. ("GEFAHI"). GEFAHI is an indirect subsidiary of General Electric Capital Corporation ("GE Capital"), which in turn is an indirect subsidiary of GE. GEFAHI is a holding company for a group of companies that provide life insurance, long-term care insurance, group life and health insurance, annuities and other investment products

and U.S. mortgage insurance. Immediately prior to the completion of the offering, Genworth acquired substantially all of the assets and liabilities of GEFAHI. At the same time, Genworth also acquired certain other insurance businesses currently owned by other GE subsidiaries. These businesses include international mortgage insurance, European payment protection insurance, a Bermuda reinsurer, and mortgage contract underwriting.

In consideration for the assets and liabilities Genworth acquired in connection with the corporate reorganization, Genworth issued to GEFAHI shares of its Class B Common Stock, \$600 million of its % Equity Units, \$100 million of its Series A cumulative preferred stock, which is mandatorily redeemable, a \$2.4 billion short-term note, and a \$550 million contingent non-interest-bearing note that matures on the first anniversary of the completion of the offering and will be repaid solely to the extent that statutory contingency reserves from Genworth's mortgage insurance business in excess of \$150 million are released and paid to Genworth as a dividend after the date of the offering. The liabilities Genworth assumed included ¥60 billion aggregate principal amount of 1.6% notes due 2011 issued by GEFAHI. Shares of Class B Common Stock convert automatically into shares of Class A Common Stock when they are held by any person other than GE or an affiliate of GE or when GE no longer beneficially owns at least 10% of our outstanding common stock. As a result, all the shares of common stock offered in Genworth's contemplated initial public offering consist of Class A Common Stock. Genworth's capital structure immediately following the completion of its corporate reorganization will consist of the securities described above, together with the non-recourse funding obligations described in note 14 and the borrowings associated with the securitization entities described in note 2.

The accompanying combined financial statements include the accounts of certain indirect subsidiaries and businesses of GE that represent the predecessor of Genworth. The companies and business included in the predecessor combined financial statements are GEFAHI, Financial Insurance Company Ltd., FIG Ireland Ltd., WorldCover Direct Ltd., RD Plus S.A., CFI Administrators Ltd., Financial Assurance Company Ltd., Financial Insurance Group Services Ltd., Consolidated Insurance Group Ltd., Viking Insurance Co., Ltd., GE Mortgage Insurance Ltd., GE Mortgage Insurance Pty Ltd., GE Mortgage Insurance (Guernsey) Ltd., GE Capital Mortgage Insurance Company Canada, GE Capital Mortgage Insurance Corp. (Australia) Pty Ltd., The Terra Financial Companies, Ltd., GE Capital Insurance Agency, Inc., CFI Pension Trustees Ltd., Financial Insurance Guernsey PCC Ltd., GE Financial Assurance Compania De Seguros y Reaseguros de Vida S.A., GE Financial Insurance Compania De Seguros y Reaseguros de Vida S.A. and GE Residential Connections Corp., and the consumer protection insurance business of Vie Plus S.A. All of the combined companies and Vie Plus S.A. are indirect subsidiaries of GE. We refer to the combined predecessor companies and business as the "Company", "we", "us", or "our" unless the context otherwise requires.

F-7

---

Following completion of the corporate reorganization, as described above, Genworth has million shares of common stock outstanding. Basic and diluted pro forma earnings per share were calculated by dividing net earnings for the year ended December 31, 2003 by million pro forma basic shares outstanding and by million pro forma diluted shares outstanding, respectively. Pro forma shares outstanding used in our calculation of pro forma diluted earnings per share increased by shares over the pro forma basic shares outstanding, resulting from million shares of Class A Common Stock available under restricted stock units and million shares of Class A Common Stock available under stock options, based on the treasury stock method.

## (2) Summary of Significant Accounting Policies

Our combined financial statements have been prepared on the basis of accounting principles generally accepted in the United States of America ("U.S. GAAP"). Preparing financial statements in conformity with U.S. GAAP requires us to make estimates and assumptions that affect reported amounts and related disclosures. Actual results could differ from those estimates. All significant intercompany accounts and transactions have been eliminated in combination.

### *a) Nature of Business*

Directly and indirectly through our subsidiaries we sell a variety of insurance and investment-related products in the U.S. and internationally. We have five segments: (i) Protection, (ii) Retirement Income and Investments, (iii) Mortgage Insurance, (iv) Affinity, and (v) Corporate and Other. During 2003, we sold our Japanese life and domestic auto and homeowners' insurance businesses, which are shown as discontinued operations.

Protection includes life insurance, long-term care insurance and, for companies with fewer than 1,000 employees, group life and health insurance. Protection also includes European consumer payment protection insurance, which helps consumers meet their payment obligations in the event of illness, involuntary unemployment, disability or death.

Retirement Income and Investments includes fixed, variable and income annuities, variable life insurance, asset management and specialized products, including guaranteed investment contracts ("GICs"), funding agreements and structured settlements.

Mortgage Insurance includes mortgage insurance products offered in the U.S., Canada, Australia, and Europe that facilitate homeownership by enabling borrowers to buy homes with low-down-payment mortgages.

Affinity includes life and health insurance and other financial products and services offered directly to consumers through affinity marketing arrangements with a variety of organizations, an institutional asset management business and several other small businesses that are not part of our core ongoing business.

Corporate and Other includes net realized investment gains (losses), interest and other debt financing expenses that are incurred at our holding company level, unallocated corporate income and expenses (including amounts accrued in settlement of class action lawsuits), and the results of several small, non-core businesses that are managed outside our operating segments.

F-8

---

### *b) Premiums*

For traditional long-duration insurance contracts (including guaranteed renewable term life, life contingent structured settlements and immediate annuities and long term care insurance), we report premiums as earned when due.

For short-duration insurance contracts (including payment protection insurance), we report premiums as revenue over the terms of the related insurance policies on a pro-rata basis or in proportion to expected claims.

For mortgage insurance contracts, we report premiums over the policy life in accordance with the expiration of risk.

Premiums received under annuity contracts without significant mortality risk and premiums received on investment and universal life products are not reported as revenues but rather as deposits and are included in liabilities for future annuity and contract benefits.

### *c) Net Investment Income and Net Realized Investment Gains and Losses*



Investment income is recorded when earned. Realized investment gains and losses are calculated on the basis of specific identification.

Investment income on mortgage-backed and asset-backed securities is initially based upon yield, cash flow, and prepayment assumptions at the date of purchase. Subsequent revisions in those assumptions are recorded using the retrospective or prospective method. Under the retrospective method, used for mortgage-backed and asset-backed securities of high credit quality (ratings equal to or greater than AA or that are U.S. Agency backed) and cannot be contractually prepaid, amortized cost of the security is adjusted to the amount that would have existed had the revised assumptions been in place at the date of purchase. The adjustments to amortized cost are recorded as a charge or credit to net investment income. Under the prospective method, which is used for other mortgage-backed and asset-backed securities, future cash flows are estimated and interest income is recognized going forward using the new internal rate of return. As of December 31, 2003, all our mortgage-backed and asset-backed securities that have had subsequent revisions in yield, cash flow or prepayment assumptions were accounted for under the retrospective method.

*d) Policy Fees and Other Income*

Policy fees and other income consists primarily of insurance charges assessed on universal life contracts, fees assessed against policyholder account values and commission income. Charges to policyholder accounts for universal life cost of insurance is recognized as revenue when due. Variable product fees are charged to variable annuity and variable life policyholders based upon the daily net assets of the policyholder's account values and are recognized as revenue when charged. Policy surrender fees are recognized as income when the policy is surrendered. Consumer protection package dues are recognized as income over the membership period.

*e) Investment Securities*

We have designated all of our investment securities as available-for-sale and report them in our Combined Statement of Financial Position at fair value. We obtain values for actively traded securities from external pricing services. For infrequently traded securities, we obtain quotes from brokers, or we

F-9

---

estimate values using internally developed pricing models. These models are based upon common valuation techniques and require us to make assumptions regarding credit quality, liquidity and other factors that affect estimated values. Changes in the fair value of available-for-sale investments, net of the effect on deferred acquisition costs ("DAC"), present value of future profits ("PVFP") and deferred income taxes, are reflected as unrealized investment gains or losses in a separate component of accumulated nonowner changes in stockholder's interest and, accordingly, have no effect on net income.

We regularly review investment securities for impairment in accordance with our policy, which includes both quantitative and qualitative criteria. Quantitative measures include length of time and amount that each security position is in an unrealized loss position, and for fixed maturities, whether the issuer is in compliance with terms and covenants of the security. Our qualitative criteria include the financial strength and specific prospects for the issuer as well as our intent to hold the security until recovery. We actively perform comprehensive market research, monitor market conditions and segment our investments by credit risk in order to minimize impairment risks. The risks inherent in reviewing the impairment of any investment security include the risk that market results may differ from expectations; facts and circumstances may change in the future and differ from estimates and assumptions; or we may later decide to sell an investment security before it recovers in value as a result of changed circumstances. If we change our estimate to conclude that a decline in the value of an investment security is other than temporary, we will reflect a charge for the impairment in the period our estimate changes.

*f) Mortgage, Policy and Other Loans*

Mortgage, policy and other loans are stated at the unpaid principal balance of such loans, net of allowances for estimated uncollectible amounts. The allowance for losses is determined on the basis of management's best estimate of probable losses, including specific allowances for known troubled loans, if any.

*g) Cash and Cash Equivalents*

Certificates of deposit, money market funds, and other time deposits with original maturities of less than 90 days are considered cash equivalents in the Combined Statement of Financial Position and Combined Statement of Cash Flows. Items with maturities greater than 90 days but less than one year at the time of acquisition are included in short-term investments.

*h) Securities Lending Activity*

We engage in certain securities lending transactions, which require the borrower to provide collateral, primarily consisting of cash and government securities, on a daily basis, in amounts equal to or exceeding 102% of the fair value of the applicable securities loaned. We maintain effective control over all loaned securities and, therefore, continue to report such securities as fixed maturities in the Combined Statement of Financial Position.

Cash collateral received on securities lending transactions is invested in other invested assets with an offsetting liability recognized in other liabilities for the obligation to return the collateral. Non-cash collateral, such as a security received by us, is not reflected in our assets in the Combined Statement of Financial Position as we have no right to sell or repledge the collateral. The fair value of collateral held

F-10

---

and included in other invested assets was \$3.0 billion and \$2.2 billion at December 31, 2003 and 2002, respectively. We had no non-cash collateral at December 31, 2003 and 2002.

*i) Deferred Acquisition Costs (DAC)*

Acquisition costs include costs which vary with and are primarily related to the acquisition of insurance and investment contracts and consumer protection packages. Such costs are deferred and amortized as follows:

*Long-Duration Contracts*—Acquisition costs include commissions in excess of ultimate renewal commissions, solicitation and printing costs, sales material and some support costs, such as underwriting and contract and policy issuance expenses. Amortization for traditional long-duration insurance products is determined as a level proportion of premium based on commonly accepted actuarial methods and reasonable assumptions established when the contract or policy is issued about mortality, morbidity, lapse rates, expenses and future yield on related investments. Amortization for annuity contracts without significant mortality risk and investment and universal life products is based on estimated gross profits and is adjusted as those estimates are revised.

*Short-Duration Contracts*—Acquisition costs consist primarily of commissions and premium taxes and are amortized ratably over the terms of the underlying policies.

*Consumer Protection Packages*—Acquisition costs, consisting of incremental direct, third party costs, as well as payroll and related costs for the portion of employees who are directly associated with direct-response advertising, are deferred when (1) the purpose of the advertising is to elicit sales to customers who can be shown to have responded specifically to the advertising, and (2) it is probable that future primary revenues from customers obtained through direct-response advertising will exceed the amount capitalized. Amortization of costs deferred is in proportion to the anticipated revenue to be recognized from club memberships specific to the deferrals, over the expected life of the applicable customer relationship, which varies by product. As of December 31, 2003, the average amortization period was approximately two years.

We regularly review all of these assumptions and periodically test DAC for recoverability. For deposit products, if the current present value of estimated future gross profits is less than the unamortized DAC for a line of business, a charge to income is recorded for additional DAC amortization. For other products, if the benefit reserve plus anticipated future premiums and interest earnings for a line of business are less than the current estimate of future benefits and expenses (including any unamortized DAC), a charge to income is recorded for additional DAC amortization or for increased benefit reserves.

*j) Intangible Assets*

*Present Value of Future Profits*—In conjunction with the acquisition of a block of insurance policies or investment contracts, a portion of the purchase price is assigned to the right to receive future gross profits arising from existing insurance and investment contracts. This intangible asset, called PVFP, represents the actuarially estimated present value of future cash flows from the acquired policies. PVFP is amortized, net of accreted interest, in a manner similar to the amortization of DAC.

We regularly review all of these assumptions and periodically test PVFP for recoverability. For deposit products, if the current present value of estimated future gross profits is less than the

F-11

---

unamortized PVFP for a line of business, a charge to income is recorded for additional PVFP amortization. For other products, if the benefit reserve plus anticipated future premiums and interest earnings for a line of business are less than the current estimate of future benefits and expenses (including any unamortized PVFP), a charge to income is recorded for additional PVFP amortization or for increased benefit reserves.

*Other Intangible Assets*—We amortize the costs of other intangibles over their estimated useful lives unless such lives are deemed indefinite. Amortizable intangible assets are tested for impairment at least annually based on undiscounted cash flows, which requires the use of estimates and judgment, and, if impaired, written down to fair value based on either discounted cash flows or appraised values. Intangible assets with indefinite lives are tested at least annually for impairment and written down to fair value as required.

*k) Goodwill*

As of January 1, 2002, we adopted Statement of Financial Accounting Standard (SFAS) 142, *Goodwill and Other Intangible Assets*. Under SFAS 142, goodwill is no longer amortized but is tested for impairment at least annually using a fair value approach, which requires the use of estimates and judgment, at the "reporting unit" level. A reporting unit is the operating segment, or a business one level below that operating segment (the "component" level) if discrete financial information is prepared and regularly reviewed by management at the component level. We recognize an impairment charge for any amount by which the carrying amount of a reporting unit's goodwill exceeds its fair value. We use discounted cash flows to establish fair values. When available and as appropriate, we use comparative market multiples to corroborate discounted cash flow results. When a business within a reporting unit is disposed of, goodwill is allocated to the business using the relative fair value methodology to measure the gain or loss on disposal.

Before January 1, 2002, we amortized goodwill over our estimated period of benefit on a straight-line basis; we amortized other intangible assets on appropriate bases over their estimated lives. No amortization period exceeded 40 years. When an intangible asset's carrying value exceeded associated expected operating cash flows, we considered it to be impaired and wrote it down to fair value, which we determined based on either discounted future cash flows or appraised values.

*l) Reinsurance*

Premium revenue, benefits, underwriting, acquisition and insurance expenses are reported net of the amounts relating to reinsurance ceded to other companies. Amounts due from reinsurers for incurred and estimated future claims are reflected in the reinsurance recoverable asset. The cost of reinsurance is accounted for over the terms of the related treaties using assumptions consistent with those used to account for the underlying reinsured policies.

*m) Separate Accounts*

The separate account assets represent funds for which the investment income and investment gains and losses accrue directly to the variable annuity contract holders and variable life policyholders. We assess mortality risk fees and administration charges on the variable mutual fund portfolios. The separate account assets are carried at fair value and are equal to the liabilities that represent the policyholders' equity in those assets.

F-12

---

*n) Future Annuity and Contract Benefits*

Future annuity and contract benefits consist of the liability for investment contracts, insurance contracts and accident and health contracts. Investment contract liabilities are generally equal to the policyholder's current account value. The liability for life insurance and accident and health contracts is calculated based upon actuarial assumptions as to mortality, morbidity, interest, expense and withdrawals, with experience adjustments for adverse deviation where appropriate.

*o) Liability for Policy and Contract Claims*

The liability for policy and contract claims represents the amount needed to provide for the estimated ultimate cost of settling claims relating to insured events that have occurred on or before the end of the respective reporting period. The estimated liability includes requirements for future payments of (a) claims that have been reported to the insurer, (b) claims related to insured events that have occurred but that have not been reported to the insurer as of the date the liability is estimated, and (c) claim adjustment expenses. Claim adjustment expenses include costs incurred in the claim settlement process such as legal fees and costs to record, process, and adjust claims.

For our mortgage insurance policies, reserves are established for loans that are delinquent (including loans that are delinquent but have not yet been reported) by forecasting the percentage of delinquent loans where we will ultimately pay claims and the average claim that will be paid based on our historical experience.

Management considers the liability for policy and contract claims provided to be satisfactory to cover the losses that have occurred. Management monitors actual experience, and where circumstances warrant, will revise its assumptions. The methods of determining such estimates and establishing the reserves are reviewed continuously

and any adjustments are reflected in operations in the period in which they become known. Future developments may result in losses and loss expenses greater or less than the liability for policy and contract claims provided.

*p) Income Taxes*

Our non-life insurance entities are included in the consolidated federal income tax return of GE. These entities are subject to a tax-sharing arrangement that allocates tax on a separate company basis, but provides benefit for current utilization of losses and credits. Our U.S. life insurance entities file a consolidated life insurance federal income tax return and are subject to a separate tax-sharing agreement, as approved by state insurance regulators, which also allocates taxes on a separate company basis but provides benefit for current utilization of losses and credits. Intercompany balances are settled at least annually.

Deferred federal and foreign taxes are provided for temporary differences between the carrying amounts of assets and liabilities and their tax bases and are stated at enacted tax rates expected to be in effect when taxes are actually paid or recovered.

With the exception of our Canadian subsidiary, we have not established any U.S. deferred income taxes on temporary differences related to the financial statement carrying amounts and tax bases of investments in foreign subsidiaries. We have elected to permanently reinvest the earnings of our material foreign subsidiaries.

F-13

*q) Foreign Currency Translation*

The local currency is the functional currency of our foreign operations. The determination of the functional currency is made based on the appropriate economic and management indicators. The assets and liabilities of foreign operations are translated into U.S. dollars at the exchange rates in effect at the Combined Statement of Financial Position date. Revenue and expenses of the foreign operations are translated into U.S. dollars at the average rates of exchange prevailing during the year. Translation adjustments are included, net of tax, as a separate component of accumulated nonowner changes in stockholder's interest. Gains and losses arising from transactions denominated in a foreign currency are included in earnings.

*r) Accounting Changes*

We adopted FASB Interpretation 46 ("FIN 46"), *Consolidation of Variable Interest Entities* on July 1, 2003.

GE Capital, our indirect parent, provides credit and liquidity support to a funding conduit it sponsored, which exposes it to a majority of the risks and rewards of the conduit's activities and therefore makes GE Capital the primary beneficiary of the funding conduit. Upon adoption of FIN 46, GE Capital was required to consolidate the funding conduit because of this financial support. As a result, assets and liabilities of certain previously off-balance sheet securitization entities, for which we were the transferor, were required to be included in our financial statements because the funding conduit no longer qualified as a third party. Because these securitization entities lost their qualifying status, we were required to include \$1.2 billion of securitized assets and \$1.1 billion of associated liabilities in our Combined Statement of Financial Position in July 2003. The assets and liabilities associated with these securitization entities have been reported in the corresponding financial statement captions in our Combined Statement of Financial Position, and the assets are noted as restricted due to the lack of legal control we have over them. We apply the same accounting policies to these restricted assets and liabilities as we do to our unrestricted assets and liabilities.

As of December 31, 2003, restricted investments held by securitization entities consisted of \$639 million of fixed maturities and \$430 million of commercial mortgage loans. These balances will decrease as the assets mature because we will not sell any additional assets to these consolidated entities. In addition, as of December 31, 2003, the borrowings related to securitization entities consisted of \$608 million at a fixed interest rate of 5.528% due June 2025 and \$410 million at a fixed rate of 6.0175% due October 2023. These borrowings are required to be paid down as principal is collected on the restricted investments held by the securitization entities and accordingly the repayment of these borrowings follows the maturity or prepayment, as permitted, of the restricted investments.

While FIN 46 represents a significant change in accounting principles governing consolidation, it does not change the economic or legal characteristics of asset sales. Entities consolidated are those that GE Capital sponsored and/or to which GE Capital provided financial support, but are not controlled by GE Capital or us. These entities were associated with asset securitization and other asset sales. Liabilities included in these entities are not our legal obligations but will be repaid with cash flows generated by the related assets, which are designated solely for the repayment of these liabilities and are not available for sale by us. As we no longer sell or securitize assets into these entities, the carrying amounts of assets and liabilities will decrease over time. Our July 1, 2003 consolidation of FIN 46 entities had no effect on previously reported earnings.

F-14

We included in the Combined Statement of Earnings for the year ended December 31, 2003 \$36 million of revenue, \$2 million of general expenses and \$27 million of interest expense associated with our newly consolidated entities.

The following table summarizes the assets and liabilities associated with these newly consolidated entities, which are included in our Corporate and Other segment for reporting purposes, at December 31, 2003:

(Dollar amounts in millions)

<b>Assets</b>	
Restricted investments held by securitization entities	\$ 1,069
Other assets	65
	<hr/>
Total <sup>(a)</sup>	\$ 1,134
	<hr/>
<b>Liabilities</b>	
Borrowings related to securitization entities	\$ 1,018
Other liabilities	59
	<hr/>
Total	\$ 1,077
	<hr/>

(a) Includes \$51 million of former retained interests in securitized assets now consolidated.

As of December 31, 2003, the amortized cost, gross unrealized gains and losses, and estimated fair value of our restricted fixed maturities held by securitization entities were as follows:

	<u>Amortized cost</u>	<u>Gross unrealized gains</u>	<u>Gross unrealized losses</u>	<u>Estimated fair value</u>
(Dollar amounts in millions)				
<b>Fixed maturities:</b>				
U.S. government and agencies	\$ 26	\$ 1	\$ —	\$ 27
U.S. corporate	564	18	(21)	561
Public utilities	4	—	—	4
Mortgage and asset-backed	45	3	(1)	47
	<u>639</u>	<u>22</u>	<u>(22)</u>	<u>639</u>
Total restricted fixed maturities	\$ 639	\$ 22	\$ (22)	\$ 639

None of these restricted fixed maturities were in an unrealized loss position for more than 6 months. No single security had an unrealized loss greater than \$5 million.

F-15

The scheduled maturity distribution of these restricted fixed maturities as of December 31, 2003 is set forth below. Actual maturities may differ from contractual maturities because issuers of securities may have the right to call or prepay obligations with or without call or prepayment penalties.

	<u>Amortized cost</u>	<u>Estimated fair value</u>
(Dollar amounts in millions)		
Due 2004	\$ 73	\$ 71
Due 2005–2008	303	309
Due 2009–2013	160	158
Due 2014 and later	58	54
	<u>594</u>	<u>592</u>
Mortgage and asset-backed	45	47
Total restricted fixed maturities	\$ 639	\$ 639

The following table presents our restricted fixed maturities by NAIC designations or equivalent ratings of the Nationally Recognized Statistical Rating Organizations, as well as the percentage, based upon estimated fair value, that each designation comprised as of December 31, 2003.

NAIC Rating	Rating Agency Equivalent Designation	<u>Amortized cost</u>	<u>Estimated Fair Value</u>	<u>% of total</u>
(Dollar amounts in millions)				
1	Aaa/Aa/A	\$ 222	\$ 224	35%
2	Baa	415	413	65%
5	Caa and lower	2	2	0%
	Total restricted fixed maturities	<u>\$ 639</u>	<u>\$ 639</u>	<u>100%</u>

F-16

The following table sets forth the distribution across geographic regions and property types for restricted commercial mortgage loans as of December 31, 2003:

	<u>Carrying value</u>	<u>% of total</u>
(Dollar amounts in millions)		
<b>Property Type</b>		
Retail	\$ 208	48%
Office	106	25%
Industrial	61	14%
Apartments	28	7%
Mixed use/other	27	6%
	<u>430</u>	<u>100%</u>
Total	\$ 430	100%

**Region**

South Atlantic	\$	117	27%
Pacific		90	21%
East North Central		54	13%
Mountain		42	10%
Middle Atlantic		41	10%
West South Central		25	6%
West North Central		23	5%
East South Central		23	5%
New England		15	3%
		<hr/>	
Total	\$	430	100%
		<hr/>	

There is no allowance for losses related to these restricted commercial mortgage loans.

Assets in entities that were either sponsored by GE Capital or to which GE Capital provided financial support were \$1.9 billion at December 31, 2003 and 2002. Of the total, \$1.1 billion was held by entities that were consolidated and \$0.8 billion remained off balance sheet. New disclosure requirements related to off-balance sheet arrangements that became effective this year encompass a broader array of arrangements than those at risk for consolidation. These arrangements include transactions with term securitization entities, as well as transactions with conduits that are sponsored by third parties. At December 31, 2003 assets in these entities, which are QSPes, were \$1.6 billion as compared to \$1.9 billion at December 31, 2002. The most meaningful analysis of securitization activity

F-17

before FIN 46 adoption (primarily conducted through sponsored and supported entities) and activity subsequent to that adoption, is a comparison of total "securitized assets", as follows:

(Dollar amounts in millions)	December 31, 2003	December 31, 2002
Receivables secured by:		
Commercial mortgage loans	\$ 1,246	\$ 428
Fixed maturities	639	679
Other assets	865	825
	<hr/>	<hr/>
Total securitized assets	\$ 2,750	\$ 1,932
	<hr/>	<hr/>
Consolidated assets held by securitization entities	\$ 1,134	\$ —
Off-balance sheet:		
Sponsored and supported	800	1,932
Other	816	—
	<hr/>	<hr/>
Total securitized assets	\$ 2,750	\$ 1,932
	<hr/>	<hr/>

We have entered into credit support arrangements in connection with our securitization transactions. Pursuant to these arrangements, as of December 31, 2003, we provided limited recourse for a maximum of \$119 million of credit losses. We have not been required to make any payments under any of the credit support agreements. These agreements will remain in place throughout the life of the related entities.

In April 2003, the FASB issued SFAS 133 Implementation Issue B36, *Modified Coinsurance Arrangements with Debt Instruments that Incorporate Credit Risk Exposures that are Unrelated or Only Partially Related to the Creditworthiness of the Obligor under those Instruments* (B36), which was effective for us on October 1, 2003. B36 provides that modified coinsurance arrangements, where the ceding insurer withholds funds, may include an embedded derivative that must be bifurcated from the host instrument. The adoption of B36 did not have a material impact on our results of operations or financial condition.

We adopted SFAS 150, *Accounting for Certain Financial Instruments with Characteristics of both Liabilities and Equity*, as of July 1, 2003. SFAS 150 requires certain financial instruments previously classified as either entirely equity or between the liabilities section and the equity section of the Combined Statement of Financial Position be classified as liabilities. SFAS 150 requires issuers to classify as liabilities the following three types of freestanding financial instruments: mandatory redeemable financial instruments, obligations to repurchase the issuers equity shares by transferring assets and certain obligations to issue a variable number of shares. The adoption of SFAS 150 did not have a material impact on our results of operations or financial condition.

We adopted SFAS 142, *Goodwill and Other Intangible Assets*, effective January 1, 2002. Under SFAS 142, goodwill is no longer amortized but is tested for impairment using a fair value methodology. We discontinued amortization of goodwill effective January 1, 2002. Goodwill amortization was \$84 million in 2001, excluding goodwill amortization included in discontinued operations. Had we not been amortizing goodwill in the year ended December 31, 2001, net earnings from continuing operations would have been \$1.3 billion.

F-18

Under SFAS 142, we were required to test all existing goodwill for impairment as of January 1, 2002, on a reporting unit basis, and recorded a non-cash charge of \$376 million, net of tax, which relates to the domestic auto and homeowners' insurance business, primarily as a result of heightened price competition in the auto insurance industry. This is reflected in net earnings (loss) from discontinued operations in the combined financial statements. No impairment charge had been required under our previous goodwill impairment policy, which was based on undiscounted cash flows. Further information about goodwill is provided in note 8.

In 2002, we adopted the stock option expense provisions of SFAS 123, *Accounting for Stock-Based Compensation*, for stock options granted by GE to our employees. A comparison of reported and pro forma net earnings, including effects of expensing stock options, follows:

	2003	2002	2001
<b>(Dollar amounts in millions)</b>			
Net earnings, as reported	\$ 1,081	\$ 1,174	\$ 1,396
Stock option expense included in net earnings	2	1	—
Total stock option expense <sup>(a)</sup>	(8)	(10)	(9)
Net earnings, on pro forma basis	\$ 1,075	\$ 1,165	\$ 1,387

(a) As if we had applied SFAS 123 to expense stock options in all periods. Includes \$2 million and \$1 million actually recognized in net earnings for the years ended December 31, 2003 and 2002, respectively.

In June 2002, the FASB issued SFAS 146, *Accounting for Costs Associated with Exit or Disposal Activities*. Previous guidance required expenses for exit or disposal activities to be accrued when the exit or disposal plan was approved by management and the liability was probable and quantifiable regardless of when the expense would be incurred. This standard requires that liabilities or costs associated with such activities be recognized when incurred. This standard also requires that any such liability be recognized initially at fair value. The provisions of this standard are effective for exit or disposal activities initiated after December 31, 2002. The adoption of this standard did not have an impact on our results of operations or financial condition.

At January 1, 2001, we adopted SFAS 133, *Accounting for Derivative Instruments and Hedging Activities*, as amended. Under SFAS 133, all derivative instruments (including certain derivative instruments embedded in other contracts) are recognized in the Combined Statement of Financial Position at their fair values and changes in fair value are recognized immediately in earnings, unless the derivatives qualify as hedges of future cash flows, in which case the effective portion of changes in fair value is recorded temporarily in stockholder's interest, then recognized in earnings along with the related effects of the hedged items. Any ineffective portion of hedges is reported in earnings as it occurs. Further information about derivatives and hedging is provided in note 19.

F-19

The cumulative effect of adopting this accounting change at January 1, 2001, was as follows:

	Earnings <sup>(a)</sup>	Stockholder's interest
<b>(Dollar amounts in millions)</b>		
Adjustment to fair value of derivatives	\$ (23)	\$ (555)
Income tax effects	8	204
Total	\$ (15)	\$ (351)

(a) For earnings effect, amount shown is net of adjustment to hedged items.

The cumulative effect on both earnings and stockholder's interest of adopting SFAS 133 was primarily attributable to marking to market currency swap contracts used to hedge non-functional currency investments and swap contracts used to hedge variable-rate borrowings. Decreases in the fair values of these instruments were attributable to declines in interest rates since inception of the hedging arrangements.

As a matter of policy, we ensure that funding, including the effect of derivatives, of our investment and other financial asset positions are substantially matched in character (e.g., fixed vs. floating) and duration. As a result, declines in the fair values of these effective derivatives are offset by unrecognized gains on the related financing assets and hedged items, and future net earnings will not be subject to volatility arising from interest rate changes.

In October 2001, the Financial Accounting Standards Board (FASB) issued SFAS 144, *Accounting for the Impairment or Disposal of Long-Lived Assets*. SFAS 144 addresses accounting and reporting for the impairment or disposal of long-lived assets. This statement supersedes SFAS 121, *Accounting for the Impairment of Long-Lived Assets and for Long-Lived Assets to be Disposed Of*. Effective January 1, 2002, we adopted SFAS 144 for impairments of long-lived assets and for long-lived assets to be disposed of on or after January 1, 2002. See note 4 for a description of our discontinued operations.

#### s) Accounting Pronouncements Not Yet Adopted

In July 2003, the American Institute of Certified Public Accountants issued Statement of Position (SOP) 03-1, *Accounting and Reporting by Insurance Enterprises for Certain Nontraditional Long-Duration Contracts and for Separate Accounts*, which we will adopt on January 1, 2004. This statement provides guidance on separate account presentation and valuation, the accounting for sales inducements and the classification and valuation of long-duration contract liabilities. We do not expect the adoption of SOP 03-1 to have a material impact on our results of operations or financial condition.

### (3) Acquisitions

Each of the following acquisitions has been accounted for using the purchase method of accounting and, accordingly, the accompanying combined financial statements reflect the corresponding results of operations from the respective dates of acquisition (or date of the transfer as described below).

F-20

In May 2003, we acquired Spread Eagle Insurance Company Limited, renamed GE Mortgage Insurance (Guemsey) Limited, for approximately \$54 million, including identifiable intangible assets of approximately \$20 million.

In April 2002, GE Edison Life Insurance Company ("GE Edison") acquired Saison Life Insurance Company Limited ("Saison Life") from Credit Saison Co., Ltd., Saison Group, Ltd. and its other shareholders for ¥7.8 billion, or approximately \$61 million, representing ¥12.8 billion of payments to shareholders less ¥5.0 billion of contingent debt. On the date of acquisition, Saison Life had approximately \$4.3 billion of assets, including \$2.4 billion of cash and \$1.9 billion of other assets, and \$4.3 billion of liabilities and

equity, including \$82 million of perpetual subordinated debt. Goodwill of \$307 million was recorded as a result of the acquisition at December 31, 2002. This business has been accounted for as discontinued operations in the accompanying combined financial statements (for further discussion see note 4).

In December 2001, we acquired Centurion Capital Group ("Centurion"), renamed GE Private Asset Management, for approximately \$92 million, including goodwill of \$94 million. Centurion is a West Coast-based asset management company.

#### (4) Discontinued Operations

Upon completion of the reorganization described in note 1, we no longer have continuing involvement with the Japanese life insurance and domestic auto and homeowners' insurance businesses (together "Japan/Auto") and accordingly, those operations have been accounted for as discontinued operations. Therefore, the results of operations of these businesses are reflected as discontinued operations and removed from the Combined Statement of Cash Flows for all periods presented in the combined financial statements.

On August 29, 2003, we completed the sale of our Japan/Auto businesses to American International Group, Inc. for aggregate cash proceeds of approximately \$2.1 billion, consisting of \$1.6 billion paid to us and \$0.5 billion paid to other GE affiliates, plus pre-closing dividends of \$495 million. The sale resulted in a loss of \$74 million (net of taxes of \$158 million).

F-21

Summary operating results of discontinued operations for the years ended December 31, are as follows:

	2003	2002	2001
<b>(Dollar amounts in millions)</b>			
Revenues	\$ 1,985	\$ 2,622	\$ 2,706
Earnings before income taxes and accounting changes	\$ 284	\$ 229	\$ 279
Provision for income taxes	98	59	99
Earnings before accounting changes	186	170	180
Cumulative effect of accounting changes, net of taxes	—	(376)	—
Net earnings (loss) from discontinued operations	\$ 186	\$ (206)	\$ 180

The domestic auto and homeowners' insurance business declared and paid a dividend of \$62 million in 2002.

The assets and liabilities associated with discontinued operations prior to the sale have been segregated in the Combined Statement of Financial Position. The major asset and liability categories at December 31, 2002 are as follows:

	2002
<b>(Dollar amounts in millions)</b>	
Investments	\$ 17,906
Cash and cash equivalents	1,135
Deferred acquisition costs	646
Intangible assets and goodwill	1,409
Other assets	982
Assets associated with discontinued operations	\$ 22,078
Future annuity and contract benefits	\$ 16,733
Liability for policy and contract claims	781
Unearned premiums	259
Short-term borrowings	—
Long-term borrowings	530
Other liabilities	1,709
Liabilities associated with discontinued operations	\$ 20,012

F-22

#### (5) Investments

##### (a) Net Investment Income

For the years ended December 31, sources of net investment income were as follows:

	2003	2002	2001
<b>(Dollar amounts in millions)</b>			
Fixed maturities	\$ 3,482	\$ 3,491	\$ 3,391

Equity securities	27	39	36
Mortgage and other loans	410	361	348
Policy loans	88	71	64
Other	75	78	111
	<u>          </u>	<u>          </u>	<u>          </u>
Gross investment income	4,082	4,040	3,950
Investment expenses	(67)	(61)	(55)
	<u>          </u>	<u>          </u>	<u>          </u>
Net investment income	\$ 4,015	\$ 3,979	\$ 3,895
	<u>          </u>	<u>          </u>	<u>          </u>

(b) Fixed Maturities and Equity Securities

For the years ended December 31, gross realized investment gains and losses resulting from the sales of investment securities classified as available for sale were as follows:

	<u>2003</u>	<u>2002</u>	<u>2001</u>
<b>(Dollar amounts in millions)</b>			
Gross realized investment:			
Gains	\$ 473	\$ 790	\$ 814
Losses, including impairments <sup>(a)</sup>	(463)	(586)	(613)
	<u>          </u>	<u>          </u>	<u>          </u>
Net realized investment gains	\$ 10	\$ 204	\$ 201
	<u>          </u>	<u>          </u>	<u>          </u>

(a) Impairments were \$224 million, \$343 million and \$289 million in 2003, 2002 and 2001, respectively.

Net unrealized gains and losses on investment securities classified as available for sale are reduced by deferred income taxes and adjustments to PVFP and DAC that would have resulted had such gains and losses been realized. Net unrealized gains and losses on available-for-sale investment securities

F-23

reflected as a separate component of accumulated nonowner changes in stockholder's interest at December 31, are summarized as follows:

	<u>2003</u>	<u>2002</u>	<u>2001</u>
<b>(Dollar amounts in millions)</b>			
Net unrealized gains (losses) on available-for-sale investment securities:			
Fixed maturities	\$ 2,669	\$ 1,336	\$ (508)
Equity securities	52	(208)	(206)
	<u>          </u>	<u>          </u>	<u>          </u>
Subtotal	2,721	1,128	(714)
Adjustments to present value of future profits and deferred acquisition costs	(388)	(74)	60
Deferred income taxes, net	(815)	(372)	230
	<u>          </u>	<u>          </u>	<u>          </u>
Subtotal	1,518	682	(424)
Net unrealized gains on investment securities included in assets associated with discontinued operations, net of deferred taxes of \$0, \$(295) and \$(66)	—	536	128
	<u>          </u>	<u>          </u>	<u>          </u>
Net unrealized gains (losses) on available-for-sale investment securities	\$ 1,518	\$ 1,218	\$ (296)
	<u>          </u>	<u>          </u>	<u>          </u>

The change in the net unrealized gains (losses) on available-for-sale investment securities reported in accumulated nonowner changes in stockholder's interest for the years ended December 31, is as follows:

	<u>2003</u>	<u>2002</u>	<u>2001</u>
<b>(Dollar amounts in millions)</b>			
Net unrealized gains (losses) on investment securities at January 1	\$ 1,218	\$ (296)	\$ (241)
Unrealized gains on investment arising during the period:			
Unrealized gain on investment securities	1,569	2,046	212
Adjustment to deferred acquisition costs	(231)	(75)	(17)
Adjustment to present value of future profits	(83)	(59)	8
Provision for deferred income taxes	(434)	(677)	(46)
	<u>          </u>	<u>          </u>	<u>          </u>
Unrealized gains on investment securities	821	1,235	157
Reclassification adjustments to net realized investment gains (losses) net of deferred taxes of \$9, \$(75) and \$(72)	15	(129)	(129)
Unrealized gains (losses) on investment securities included in assets associated with discontinued operations arising during the period, net of deferred taxes	(532)	511	(49)



Reclassification adjustment to net earnings from discontinued operations, net of deferred taxes of \$(2), \$(55) and \$(18)

	(4)	(103)	(34)
Net unrealized gains (losses) on investment securities at December 31	\$ 1,518	\$ 1,218	\$ (296)

F-24

At December 31, the amortized cost or cost, gross unrealized gains and losses, and estimated fair value of our fixed maturities and equity securities classified as available for sale were as follows:

2003	Amortized cost or cost	Gross unrealized gains	Gross unrealized losses	Estimated fair value
<b>(Dollar amounts in millions)</b>				
<b>Fixed maturities:</b>				
U.S. government and agencies	\$ 1,025	\$ 48	\$ 18	\$ 1,055
State and municipal	3,221	130	1	3,350
Government—non U.S.	1,510	49	8	1,551
U.S. corporate	31,454	1,863	292	33,025
Corporate—non U.S.	7,624	378	53	7,949
Public utilities	5,919	411	27	6,303
Mortgage and asset-backed	12,063	269	80	12,252
<b>Total fixed maturities</b>	<b>62,816</b>	<b>3,148</b>	<b>479</b>	<b>65,485</b>
Equity securities	548	60	8	600
<b>Total available-for-sale securities</b>	<b>\$ 63,364</b>	<b>\$ 3,208</b>	<b>\$ 487</b>	<b>\$ 66,085</b>
	<b>Amortized cost or cost</b>	<b>Gross unrealized gains</b>	<b>Gross unrealized losses</b>	<b>Estimated fair value</b>
<b>2002</b>				
<b>(Dollar amounts in millions)</b>				
<b>Fixed maturities:</b>				
U.S. government and agencies	\$ 1,131	\$ 54	\$ 18	\$ 1,167
State and municipal	3,203	117	13	3,307
Government—non U.S.	957	47	3	1,001
U.S. corporate	30,359	1,401	733	31,027
Corporate—non U.S.	5,131	219	103	5,247
Public utilities	6,785	239	245	6,779
Mortgage and asset-backed	11,895	428	54	12,269
<b>Total fixed maturities</b>	<b>59,461</b>	<b>2,505</b>	<b>1,169</b>	<b>60,797</b>
Equity securities	1,503	54	262	1,295
<b>Total available-for-sale securities</b>	<b>\$ 60,964</b>	<b>\$ 2,559</b>	<b>\$ 1,431</b>	<b>\$ 62,092</b>

F-25

We regularly review investment securities for impairment in accordance with our impairment policy, which includes both quantitative and qualitative criteria. Quantitative measures include length of time and amount that each security position is in an unrealized loss position, and for fixed maturities, whether the issuer is in compliance with terms and covenants of the security. Our qualitative criteria include the financial strength and specific prospects for the issuer as well as our intent to hold the security until recovery. Our impairment reviews involve our finance and risk teams as well as the portfolio management and research capabilities of GE Asset Management ("GEAM"). Our qualitative review attempts to identify those issuers with a greater than 50% chance of default in the coming twelve months. These securities are characterized as "at-risk" of impairment. As of December 31, 2003, securities "at risk" of impairment had aggregate unrealized losses of \$40 million.

For fixed maturities, we recognize an impairment charge to earnings in the period in which we determine that we do not expect either to collect principal and interest in accordance with the contractual terms of the instruments or to recover based upon underlying collateral values, considering events such as a payment default, bankruptcy or disclosure of fraud. For equity securities, we recognize an impairment charge in the period in which we determine that the security will not recover to book value within a reasonable period. We determine what constitutes a reasonable period on a security-by-security basis based upon a consideration of all the evidence available to us, including the magnitude of an unrealized loss and its duration. In any event, this period does not exceed 18 months for common equity securities. We measure impairment charges based upon the difference between the book value of a security and its fair value. Fair value is based upon quoted market price, except for certain infrequently traded securities where we estimate values using internally developed pricing models. These models are based upon common valuation techniques and require us to make assumptions regarding credit quality, liquidity and other factors that affect estimated values. The carrying value of infrequently traded securities as of December 31, 2003 was \$14.1 billion.

In the years ended December 31, 2003, 2002 and 2001, we recognized impairment losses of \$224 million, \$343 million and \$289 million, respectively. We generally intend to hold securities in unrealized loss positions until they recover. However, from time to time, we sell securities in the ordinary course of managing our portfolio to meet diversification, credit quality, yield and liquidity requirements. In the year ended December 31, 2003, the pre-tax realized investment loss incurred on the sale of fixed maturities and equity securities was \$239 million. The aggregate fair value of securities sold during that year was \$5,220 million, which was approximately 96% of book value.

The following tables present the gross unrealized losses and estimated fair values of our investment securities, aggregated by investment type and length of time that individual investment securities have been in a continuous unrealized loss position, as of December 31, 2003:

Less Than 12 Months						
	Amortized cost or cost	Estimated fair value	Gross unrealized losses	% underwater	# of securities	
<b>(Dollar amounts in millions)</b>						
<b>Fixed maturities:</b>						
U.S. government and agencies	\$ 228	\$ 210	\$ (18)	7.9%	11	
State and municipal	119	118	(1)	0.8%	31	
Government—non U.S.	501	493	(8)	1.6%	142	
U.S. corporate (including public utilities)	5,948	5,738	(210)	3.5%	458	
Corporate—non U.S.	1,573	1,530	(43)	2.7%	198	
Asset backed	914	900	(14)	1.5%	95	
Mortgage backed	2,065	2,001	(64)	3.1%	247	
Subtotal, fixed maturities	11,348	10,990	(358)	3.2%	1,182	
Equity securities	53	51	(2)	3.8%	58	
<b>Total temporarily impaired securities</b>	<b>\$ 11,401</b>	<b>\$ 11,041</b>	<b>\$ (360)</b>	<b>3.2%</b>	<b>1,240</b>	
Investment grade	\$ 10,471	\$ 10,185	\$ (286)	2.7%	1,032	
Below investment grade	810	739	(71)	8.8%	141	
Not rated—fixed maturities	67	66	(1)	1.5%	9	
Not rated—equities	53	51	(2)	3.8%	58	
<b>12 Months or More</b>						
	Amortized cost or cost	Estimated fair value	Gross unrealized losses	% underwater	# of securities	
<b>(Dollar amounts in millions)</b>						
<b>Fixed maturities:</b>						
U.S. government and agencies	\$ —	\$ —	\$ —	—	—	—
State and municipal	1	1	—	—	1	
Government—non U.S.	12	12	—	—	6	
U.S. corporate (including public utilities)	1,084	975	(109)	10.1%	134	
Corporate—non U.S.	158	148	(10)	6.3%	30	
Asset backed	111	110	(1)	0.9%	9	
Mortgage backed	172	171	(1)	0.6%	19	
Subtotal, fixed maturities	1,538	1,417	(121)	7.9%	199	
Equity securities	49	43	(6)	12.2%	47	
<b>Total temporarily impaired securities</b>	<b>\$ 1,587</b>	<b>\$ 1,460</b>	<b>\$ (127)</b>	<b>8.0%</b>	<b>246</b>	
Investment grade	\$ 718	\$ 691	\$ (27)	3.8%	90	
Below investment grade	820	726	(94)	11.5%	109	
Not rated—fixed maturities	—	—	—	—	—	
Not rated—equities	49	43	(6)	12.2%	47	

The investment securities in an unrealized loss position for less than twelve months account for \$360 million, or 74%, of our total unrealized losses. Of the securities in this category, there were five securities with an unrealized loss in excess of \$5 million. These five securities had aggregate unrealized losses of \$30 million. The amount of the unrealized loss on these securities is driven primarily by the relative size of the holdings, the par values of which range from \$40 million to \$75 million.

The investment securities in an unrealized loss position for twelve months or more account for \$127 million, or 26%, of our total unrealized losses. There are 68 fixed-maturity securities in three industry groups that account for \$78 million or 61% of the unrealized losses in this category.

Forty-one of these 68 securities are in the transportation sector and are related to the airline industry. Ninety-nine percent of our airline securities are collateralized by commercial aircraft associated with five domestic airlines. The collateral underlying these securities consists of commercial jet aircraft. We believe these security holdings are in a loss position as a result of ongoing negative market reaction to difficulties in the commercial airline industry. In accordance with our impairment policy described above, we have recognized \$30 million and \$27 million in other-than-temporary impairments during 2003 and 2002, respectively, associated with the airline industry due to either

bankruptcies or restructurings. These holdings were written down to estimated fair value based upon the present value of expected cash flows associated with revised lease terms or the value of the underlying aircraft. As of December 31, 2003, we expect to collect full principal and interest in accordance with the contractual terms of the instruments of our remaining holdings in airline securities. For those airline securities which we have previously impaired, we expect to recover our carrying amount based upon underlying aircraft collateral values.

Eighteen of these 68 securities are in the industrial sector and are primarily in the chemical and paper and timber products industries. Within this sector, there are two issuers, comprising five of the 18 securities, which represent \$17 million of the unrealized losses in this sector. Each of the other securities in this sector has unrealized losses less than \$3 million. These two issuers, one of which is in the chemical industry and one of which is in the timber products industry, are current on all terms, show improving trends with regards to liquidity and security price and are not considered at risk of impairment. Our other holdings issued by the chemical company are in unrealized gain positions. Our other holdings issued by the timber products company are collateralized by assets, which provide greater than 100% coverage of the outstanding obligations based on the most recent valuations performed.

The remaining nine of these 68 securities are in the consumer-non cyclical sector and are primarily in the consumer products and retail industries. Within this sector, there is one issuer, comprising two of the nine securities, which represents \$13 million of the unrealized losses in this sector. This one issuer, a national retail chain, is current on all terms, shows improving trends with regard to liquidity and security price, and is not considered at risk of impairment. Our other holdings issued by this company are in unrealized gain positions. The remainder of the securities in this sector each have unrealized losses less than \$1 million.

In the remaining industry sectors, no single issuer of fixed-maturity securities has an unrealized loss greater than \$5 million.

F-28

The equity securities in an unrealized loss position for twelve months or more are preferred stocks with fixed maturity-like characteristics and mutual fund investments. No single security has an unrealized loss greater than \$5 million.

The scheduled maturity distribution of fixed maturities as of December 31, 2003 is set forth below. Actual maturities may differ from contractual maturities because issuers of securities may have the right to call or prepay obligations with or without call or prepayment penalties.

	Amortized cost or cost	Estimated fair value
<b>(Dollar amounts in millions)</b>		
Due 2004	\$ 1,747	\$ 1,761
Due 2005—2008	11,400	11,817
Due 2009—2013	13,318	13,901
Due 2014 and later	24,288	25,756
<b>Subtotal</b>	<b>50,753</b>	<b>53,235</b>
Mortgage and asset-backed	12,063	12,250
<b>Total</b>	<b>\$ 62,816</b>	<b>\$ 65,485</b>

At December 31, 2003, \$7,998 million of our investments (excluding mortgage and asset-backed securities) were subject to certain call provisions.

At December 31, 2003, securities issued by finance and insurance, utilities and energy and consumer—non cyclical industry groups represented approximately 28%, 22% and 13% of our domestic and foreign corporate fixed maturities portfolio, respectively. No other industry group comprises more than 10% of our investment portfolio. This portfolio is widely diversified among various geographic regions in the U.S. and internationally, and is not dependent on the economic stability of one particular region.

At December 31, 2003, we did not hold any fixed maturities in any single issuer, other than securities issued or guaranteed by the U.S. government, which exceeded 10% of stockholder's interest.

At December 31, 2003 and 2002, \$203 million and \$174 million, respectively, of securities were on deposit with various state or foreign government insurance departments in order to comply with relevant insurance regulations.

The Securities Valuation Office of the National Association of Insurance Commissioners (NAIC) evaluates bond investments of U.S. insurers for regulatory reporting purposes and assigns securities to one of six investment categories called "NAIC designations." The NAIC designations parallel the credit ratings of the Nationally Recognized Statistical Rating Organizations for marketable bonds. NAIC designations 1 and 2 include bonds considered investment grade (rated "Baa3" or higher by Moody's, or rated "BBB-" or higher by S&P) by such rating organizations. NAIC designations 3 through 6 include bonds considered below investment grade (rated "Ba1" or lower by Moody's, or rated "BB+" or lower by S&P).

The following table presents our fixed maturities by NAIC and/or equivalent ratings of the Nationally Recognized Statistical Rating Organizations, as well as the percentage, based upon estimated fair value, that each designation comprises. Our non-U.S. fixed maturities generally are not rated by the

F-29

NAIC and are shown based upon the equivalent rating of the Nationally Recognized Statistical Rating Organizations. Similarly, certain privately placed fixed maturities that are not rated by the Nationally Recognized Statistical Rating Organizations are shown based upon their NAIC designation. Certain fixed maturities, primarily non-U.S. fixed maturities, are not rated by the NAIC or the Nationally Recognized Statistical Rating Organizations and are so designated.

As of December 31,

2003	2002

NAIC Rating	Rating Agency Equivalent Designation	Amortized cost	Estimated fair value	% of total	Amortized cost	Estimated fair value	% of total
<b>(Dollar amounts in millions)</b>							
1	Aaa/Aa/A	\$ 39,124	\$ 40,600	62%	\$ 36,749	\$ 38,107	63%
2	Baa	19,048	20,220	31%	17,946	18,444	30%
3	Ba	2,520	2,624	4%	2,596	2,394	4%
4	B	1,257	1,207	2%	963	789	1%
5	Caa and lower	487	449	1%	502	352	1%
6	In or near default	189	190	0%	218	181	0%
Not rated	Not rated	191	195	0%	487	530	1%
Total fixed maturities		\$ 62,816	\$ 65,485	100%	\$ 59,461	\$ 60,797	100%

(c) *Mortgage Loans*

Our mortgage loans are collateralized by commercial properties, including multifamily residential buildings. The carrying value of mortgage loans is stated at original cost net of prepayments and amortization.

F-30

We diversify our commercial mortgage loans by both geographic region and property type. The following table sets forth the distribution across geographic regions and property types for commercial mortgage loans as of the dates indicated:

	As of December 31,			
	2003		2002	
	Carrying value	% of total	Carrying value	% of total
<b>(Dollar amounts in millions)</b>				
<b>Property Type</b>				
Office	\$ 2,024	33%	\$ 1,610	30%
Industrial	1,812	30%	1,546	29%
Retail	1,500	25%	1,476	28%
Apartments	573	9%	520	10%
Mixed use/other	205	3%	150	3%
Total	\$ 6,114	100%	\$ 5,302	100%
<b>Region</b>				
Pacific	\$ 1,867	31%	\$ 1,606	30%
South Atlantic	1,194	20%	1,174	22%
Middle Atlantic	932	15%	729	14%
East North Central	771	12%	519	10%
Mountain	478	8%	454	9%
West South Central	288	5%	241	4%
West North Central	271	4%	267	5%
East South Central	226	4%	222	4%
New England	87	1%	90	2%
Total	\$ 6,114	100%	\$ 5,302	100%

We were committed to fund \$56 million and \$163 million at December 31, 2003 and 2002, respectively, in U.S. mortgage loans.

"Impaired" loans are defined by U.S. GAAP as loans for which it is probable that the lender will be unable to collect all amounts due according to original contractual terms of the loan agreement. That definition excludes, among other things, leases, or large groups of smaller-balance homogeneous loans, and therefore applies principally to our commercial loans.

Under these principles, we may have two types of "impaired" loans: loans requiring specific allowances for losses (none as of December 31, 2003 and 2002) and loans expected to be fully recoverable because the carrying amount has been reduced previously through charge-offs or deferral of income recognition (\$5 million and \$4 million, as of December 31, 2003 and 2002, respectively). Average investment in impaired loans during 2003, 2002 and 2001 was \$5 million, \$7 million and \$12 million, respectively, and interest income recognized on these loans while they were considered impaired was \$1 million in each of the three years.

F-31

The following table presents the activity in the allowance for losses during the years ended December 31:

	2003	2002	2001
<b>(Dollar amounts in millions)</b>			
Balance at January 1	\$ 45	\$ 58	\$ 47
Provision charged to operations	8	10	9
Amounts written off, net of recoveries	(3)	(23)	2
Balance at December 31	\$ 50	\$ 45	\$ 58

#### (6) Deferred Acquisition Costs

Activity impacting deferred acquisition costs for the years ended December 31:

	2003	2002	2001
<b>(Dollar amounts in millions)</b>			
Unamortized balance at January 1	\$ 5,386	\$ 4,452	\$ 3,665
Impact of foreign currency translation	111	88	(1)
Costs deferred	1,758	1,906	1,721
Amortization	(1,182)	(1,060)	(933)
Unamortized balance at December 31	6,073	5,386	4,452
Accumulated effect of net unrealized investment (gains) losses	(285)	(54)	21
Balance at December 31	\$ 5,788	\$ 5,332	\$ 4,473

Amortization includes advertising costs related to Consumer Protection Packages of \$42 million, \$36 million and \$40 million for the years ended December 31, 2003, 2002 and 2001, respectively. None of these amounts represent write-downs to net realizable value.

#### (7) Intangible Assets

The following table presents the activity in intangible assets for the years ended December 31:

	2003		2002	
	Gross carrying amount	Accumulated amortization	Gross carrying amount	Accumulated amortization
<b>(Dollar amounts in millions)</b>				
Present value of future profits ("PVFP")	\$ 2,744	\$ (1,593)	\$ 2,810	\$ (1,481)
Capitalized software	235	(141)	249	(107)
Other	372	(271)	369	(248)
Total	\$ 3,351	\$ (2,005)	\$ 3,428	\$ (1,836)

F-32

#### *Present Value of Future Profits*

The method we use to value PVFP in connection with acquisitions of life insurance entities is summarized as follows: (1) identify the future gross profits attributable to certain lines of business, (2) identify the risks inherent in realizing those gross profits, and (3) discount those gross profits at the rate of return that we must earn in order to accept the inherent risks.

The following table presents the activity in PVFP for the years ended December 31:

	2003	2002	2001
<b>(Dollar amounts in millions)</b>			
Unamortized balance at January 1	\$ 1,349	\$ 1,460	\$ 1,709
Acquisitions	16	(20)	(91)
Impact of foreign currency translation	1	—	—
Interest accreted at 4.1%, 4.1%, 3.9%, respectively	51	57	63
Amortization	(163)	(148)	(221)
Unamortized balance at December 31	1,254	1,349	1,460
Accumulated effect of net unrealized investment (gains) losses	(103)	(20)	39
Balance at December 31	\$ 1,151	\$ 1,329	\$ 1,499

The estimated percentage of the December 31, 2003 balance, before the effect of unrealized investment gains or losses, to be amortized over each of the next five years is as follows:

2004	9.5%
2005	8.8%
2006	8.0%
2007	7.2%
2008	6.5%

Amortization expenses for PVFP in future periods will be affected by acquisitions, dispositions, realized capital gains/losses or other factors affecting the ultimate amount of gross profits realized from certain lines of business. Similarly, future amortization expenses for other intangibles will depend on future acquisitions, dispositions and other business transactions.

F-33

## (8) Goodwill

Our goodwill balance by segment and activity during the year follows:

	Protection	Retirement Income and Investments	Mortgage Insurance	Affinity	Total
<b>(Dollar amounts in millions)</b>					
Balance, December 31, 2001	\$ 1,037	\$ 307	\$ 37	\$ 205	\$ 1,586
Acquisitions	—	25	—	—	25
Other <sup>(a)</sup>	15	—	(3)	79	91
Balance, December 31, 2002	1,052	332	34	284	1,702
Acquisitions	6	5	—	—	11
Other <sup>(a)</sup>	13	—	2	—	15
Balance, December 31, 2003	\$ 1,071	\$ 337	\$ 36	\$ 284	\$ 1,728

(a) Other adjustments include reclassifications of certain intangible assets into goodwill upon the adoption of SFAS 142 in 2002 and the impact of foreign exchange translation adjustments.

Goodwill associated with our Japanese life insurance and domestic auto and homeowners' insurance business is included in assets associated with discontinued operations for 2002.

## (9) Reinsurance

Certain policy risks are reinsured with other insurance companies to limit the amount of loss exposure. Reinsurance contracts do not relieve us from our obligations to policyholders. In the event that the reinsurers are unable to meet their obligations, we remain liable for the reinsured claims. We monitor both the financial condition of individual reinsurers and risk concentrations arising from similar geographic regions, activities and economic characteristics of reinsurers to lessen the risk of default by such reinsurers. We do not have significant concentrations of reinsurance with any one reinsurer that could have a material impact on our results of operations.

The maximum amount of individual ordinary life insurance normally retained by us on any one life policy is \$1 million. Net domestic life insurance in force as of December 31, is summarized as follows:

	2003	2002	2001
<b>(Dollar amounts in millions)</b>			
Direct life insurance in force	\$ 553,690	\$ 520,008	\$ 534,369
Amounts assumed from other companies	23,749	31,965	39,578
Amounts ceded to other companies	(170,961)	(157,898)	(111,989)
Net life insurance in force	\$ 406,478	\$ 394,075	\$ 461,958
Percentage of amount assumed to net	6%	8%	9%

F-34

The effects of reinsurance on premiums written and earned for the years ended December 31, were as follows:

	Written			Earned		
	2003	2002	2001	2003	2002	2001
<b>(Dollar amounts in millions)</b>						

<b>Direct:</b>						
Life insurance	\$ 2,262	\$ 2,654	\$ 2,583	\$ 2,279	\$ 2,414	\$ 2,413
Accident and health insurance	3,212	2,583	2,166	3,311	2,547	2,301
Property and casualty insurance	160	109	94	156	105	94
Mortgage insurance	1,093	954	875	857	795	779
<b>Total Direct</b>	<b>6,727</b>	<b>6,300</b>	<b>5,718</b>	<b>6,603</b>	<b>5,861</b>	<b>5,587</b>
<b>Assumed:</b>						
Life insurance	507	535	344	505	502	319
Accident and health insurance	541	519	671	543	529	666
Property and casualty insurance	57	40	46	27	51	47
Mortgage insurance	6	12	8	5	4	4
<b>Total Assumed</b>	<b>1,111</b>	<b>1,106</b>	<b>1,069</b>	<b>1,080</b>	<b>1,086</b>	<b>1,036</b>
<b>Ceded</b>						
Life insurance	(713)	(660)	(393)	(693)	(591)	(402)
Accident and health insurance	(155)	(118)	(110)	(128)	(118)	(112)
Property and casualty insurance	(11)	(9)	(11)	(13)	(9)	(11)
Mortgage insurance	(149)	(127)	(86)	(146)	(122)	(86)
<b>Total Ceded</b>	<b>(1,028)</b>	<b>(914)</b>	<b>(600)</b>	<b>(980)</b>	<b>(840)</b>	<b>(611)</b>
<b>Net premiums</b>	<b>\$ 6,810</b>	<b>\$ 6,492</b>	<b>\$ 6,187</b>	<b>\$ 6,703</b>	<b>\$ 6,107</b>	<b>\$ 6,012</b>
Percentage of amount assumed to net				16%	18%	17%

Reinsurance recoveries recognized as a reduction of benefit expenses amounted to \$809 million, \$682 million and \$486 million during 2003, 2002 and 2001, respectively.

#### (10) Future Annuity and Contract Benefits

##### Investment Contracts

Investment contracts are broadly defined to include contracts without significant mortality or morbidity risk. Payments received from sales of investment contracts are recognized by providing a liability equal to the current account value of the policyholder's contracts. Interest rates credited to investment contracts are guaranteed for the initial policy term with renewal rates determined as necessary by management.

F-35

##### Insurance Contracts

Insurance contracts are broadly defined to include contracts with significant mortality and/or morbidity risk. The liability for future benefits of insurance contracts is the present value of such benefits less the present value of future net premiums based on mortality, morbidity, and other assumptions, which were appropriate at the time the policies were issued or acquired. These assumptions are periodically evaluated for potential reserve deficiencies. Reserves for cancelable accident and health insurance are based upon unearned premiums, claims incurred but not reported, and claims in the process of settlement. This estimate is based on our historical experience and that of the insurance industry, adjusted for current trends. Any changes in the estimated liability are reflected in earnings as the estimates are revised.

The following chart summarizes the major assumptions underlying our recorded liabilities for future annuity and contract benefits at December 31:

	Withdrawal assumption	Mortality/ morbidity assumption	Interest rate assumption	Future annuity and contract benefit liabilities	
				2003	2002
<b>(Dollar amounts in millions)</b>					
Investment contracts	N/A	N/A	N/A	\$ 31,206	\$ 30,962
Limited-payment contracts	None	(a)	3.3%–12.0%	12,655	11,873
Traditional life insurance contracts	Company Experience	(b)	5.5%–7.5%	2,537	3,576
Universal life-type contracts	N/A	N/A	N/A	5,867	4,183
Accident and health	Company Experience	(c)	7.5% grading to 4.75%	131	121
Long-term care	Company Experience	(d)	4.5%–7.0%	6,861	5,823
<b>Total future annuity and contract benefits</b>				<b>\$ 59,257</b>	<b>\$ 56,538</b>

(a) Either the U.S Population Table, 1983 Group Annuitant Mortality Table or 1983 Individual Annuitant Mortality Table.

(b) Principally modifications of the 1965-70 or 1975-80 Select and Ultimate Tables, 1958 and 1980 Commissioner's Standard Ordinary Tables and (IA) Standard Table

1996 (modified).

- (c) The 1958 and 1980 Commissioner's Standard Ordinary Tables, 1964 modified and 1987 Commissioner's Disability Tables and Company experience.
- (d) The 1983 Individual Annuitant Mortality Table or 1980 Commissioner's Standard Ordinary Table and the 1985 National Nursing Home Study and Company experience.

F-36

### (11) Liability for Policy and Contract Claims

Changes in the liability for policy and contract claims for the years ended December 31:

	2003	2002	2001
<i>(Dollar amounts in millions)</i>			
Balance at January 1	\$ 3,014	\$ 2,713	\$ 2,083
Less reinsurance recoverables	(406)	(275)	(157)
<b>Net balance at January 1</b>	<b>2,608</b>	<b>2,438</b>	<b>1,926</b>
Incurring related to insured events of:			
Current year	2,200	2,401	2,583
Prior years	(73)	(193)	(173)
<b>Total incurred</b>	<b>2,127</b>	<b>2,208</b>	<b>2,410</b>
Paid related to insured events of:			
Current year	(1,236)	(1,208)	(1,010)
Prior years	(807)	(851)	(877)
<b>Total paid</b>	<b>(2,043)</b>	<b>(2,059)</b>	<b>(1,887)</b>
Foreign currency translation	43	21	(11)
<b>Net balance at December 31</b>	<b>2,735</b>	<b>2,608</b>	<b>2,438</b>
Add reinsurance recoverables	472	406	275
<b>Balance at December 31</b>	<b>\$ 3,207</b>	<b>\$ 3,014</b>	<b>\$ 2,713</b>

For each of the three years presented above, the change in prior years incurred liabilities primarily relates to positive development in claims incurred but not reported for our mortgage insurance and certain accident and health insurance businesses. In general, our insurance contracts are not subject to premiums experience adjustments as a result of prior-year effects.

### (12) Benefit Plans

Essentially all of our employees participate in GE's retirement plan ("GE Pension Plan") and retiree health and life insurance benefit plans ("GE Retiree Benefit Plans"). The GE Pension Plan provides benefits to certain U.S. employees based on the greater of a formula recognizing career earnings or a formula recognizing length of service and final average earnings. Benefit provisions are subject to collective bargaining. The GE Retiree Benefit Plans provide health and life insurance benefits to employees who retire under the GE Pension Plan with 10 or more years of service. Retirees share in the cost of healthcare benefits. The GE Pension Plan currently is in an overfunded position. Therefore, we have not been required to contribute to this plan for the three years ended December 31, 2003. Certain company employees also participate in GE's Supplementary Pension Plan ("GE Supplementary Plan") and other retiree benefit plans. The GE Supplementary Plan is a pay-as-you-go plan providing supplementary retirement benefits primarily to higher-level, longer-service U.S. employees. Other retiree plans are not significant individually or in the aggregate. Our costs associated with these plans were \$52 million, \$52 million and \$44 million for the years ended December 31, 2003, 2002 and 2001, respectively.

F-37

Our employees participate in GE's defined contribution savings plan that allows the employees to contribute a portion of their pay to the plan on a pre-tax basis. GE matches 50% of these contributions up to 7% of the employee's pay. Our costs associated with these plans were \$13 million, \$15 million and \$16 million for the years ended December 31, 2003, 2002 and 2001, respectively.

We also provide health and life insurance benefits to our employees through the GE Company's benefit program, as well as through plans sponsored by other affiliates. Our costs associated with these plans were \$41 million, \$45 million and \$43 million for the years ended December 31, 2003, 2002 and 2001, respectively.

We reimburse GE monthly for our share of the plan costs.

Effective as of the date that GE ceases to own more than 50% of our outstanding common stock, our applicable employees will cease to participate in the GE plans and will participate in employee benefit plans established and maintained by us. For non-U.S. employees, this date may be delayed, by mutual agreement between GE and us, for up to six months following the date that GE ceases to own more than 50% of our outstanding common stock.

### (13) Borrowings

- (a) *Short-Term Borrowings*



Total short-term borrowings at December 31:

	2003	2002
<b>(Dollar amounts in millions)</b>		
Commercial paper	\$ 1,691	\$ 1,675
Current portion of long-term borrowings	—	175
Short-term line of credit with GE Capital	548	—
Total	\$ 2,239	\$ 1,850

The weighted average interest rate on commercial paper outstanding at December 31, 2003 and 2002 was 1.1% and 1.4%, respectively.

The weighted average interest rate on the current portion of long-term borrowings at December 31, 2002 was 6.6%.

The weighted average interest rate on the short-term line of credit with GE Capital at December 31, 2003 was 1.3%.

F-38

*(b) Long-Term Borrowings*

Total long-term borrowings at December 31:

	2003	2002
<b>(Dollar amounts in millions)</b>		
1.6% Notes (Japanese Yen), due 2011	\$ 529	\$ 472
6.625% First Colony Life Insurance Company Senior Note, due 2003	—	175
Less current portion of long-term borrowings	—	(175)
Total	\$ 529	\$ 472

In June 2001, GEFAHI issued ¥60.0 billion of notes through a public offering at a price of ¥59.9 billion. ¥3.0 billion of the notes were purchased by GE Edison following the original issuance. These notes were subsequently purchased by GEFAHI and were held by GEFAHI as of December 31, 2003. We have entered into arrangements to swap our obligations under these notes to a U.S. dollar obligation with a principal amount of \$491 million and bearing interest at a rate of 4.84% per annum. The notes are unsecured and mature at par in 2011.

There are no scheduled maturities in the years 2004-2008.

*(c) Liquidity*

Our liquidity requirements are principally met through dividends from our insurance subsidiaries, the Commercial Paper program and the credit line with GE Capital. At December 31, 2003, we have an unused credit capacity within our line of credit with GE Capital of \$1.95 billion.

*(d) Interest Rate Risk*

A variety of instruments, including interest rate and currency swaps and currency forwards (for further information relating to interest rate swaps, see *cash flow hedges* in note 19), are employed to achieve management's interest rate objectives. As of December 31, 2003 and 2002, we had long-term interest rate swaps with a notional value of \$1.1 billion that effectively converted the floating rate nature of short-term borrowings into fixed-rate borrowings. These swaps have interest rates ranging from 5.9% to 7.3% and maturities ranging from 2007 to 2017.

**(14) Non-recourse Funding Obligations**

On July 28, 2003 and December 16, 2003, River Lake Insurance Company, a wholly owned captive reinsurance subsidiary of our company, issued \$300 million and \$300 million, respectively, of non-recourse funding obligations, which bear a floating rate of interest and mature in 2033. As of December 31, 2003, \$600 million of obligations were outstanding. The weighted average yield at December 31, 2003 is 1.2%.

F-39

**(15) Income Taxes**

The total provision (benefit) for income taxes for the years ended December 31:

	2003	2002	2001
<b>(Dollar amounts in millions)</b>			
Current federal income taxes	\$ 444	\$ 441	\$ 233

Deferred federal income taxes	(103)	(76)	323
<b>Total federal income taxes</b>	<b>341</b>	<b>365</b>	<b>556</b>
Current state income taxes	(16)	(26)	(12)
Deferred state income taxes	(11)	21	3
<b>Total state income taxes</b>	<b>(27)</b>	<b>(5)</b>	<b>(9)</b>
Current foreign income taxes	48	51	62
Deferred foreign income taxes	51	—	(19)
<b>Total foreign income taxes</b>	<b>99</b>	<b>51</b>	<b>43</b>
<b>Total provision for income taxes</b>	<b>\$ 413</b>	<b>\$ 411</b>	<b>\$ 590</b>

The reconciliation of the federal statutory tax rate to the effective income tax rate is as follows:

	2003	2002	2001
Statutory U.S. federal income tax rate	35.0%	35.0%	35.0%
Increase (reduction) in rate resulting from:			
State income tax, net of federal income tax effect	(0.6)	(0.3)	(0.5)
Non-deductible goodwill amortization	—	—	1.0
IRS settlement <sup>(a)</sup>	—	(8.5)	—
Tax exempt income	(2.8)	(2.7)	(2.8)
Other, net	(1.7)	(0.6)	(0.3)
<b>Effective rate</b>	<b>29.9%</b>	<b>22.9%</b>	<b>32.4%</b>

(a) In 2002, we reached a favorable settlement with the Internal Revenue Service regarding the treatment of certain reserves for obligations to policyholders on life insurance contracts resulting in a benefit of \$152 million. The benefits associated with the settlement are non-recurring.

F-40

The components of the net deferred income tax liability at December 31, are as follows:

	2003	2002
<b>(Dollar amounts in millions)</b>		
<b>Assets:</b>		
Investments	\$ 129	\$ —
Future annuity and contract benefits	1,394	1,028
Net unrealized losses on derivatives	33	18
Other	126	8
<b>Total deferred income tax assets</b>	<b>1,682</b>	<b>1,054</b>
<b>Liabilities:</b>		
Net unrealized gains on investment securities	815	372
Investments	—	63
Present value of future profits	526	501
Deferred acquisition costs	1,631	928
Statutory contingency reserve	—	248
Other	115	30
<b>Total deferred income tax liabilities</b>	<b>3,087</b>	<b>2,142</b>
<b>Net deferred income tax liability</b>	<b>\$ 1,405</b>	<b>\$ 1,088</b>

Based on an analysis of our tax position, management believes it is more likely than not that the results of future operations and implementation of tax planning strategies will generate sufficient taxable income to enable us to realize all of our deferred tax assets. Accordingly, no valuation allowance for deferred tax assets has been established.

Federal income tax law allows mortgage guaranty insurance companies to deduct from current taxable income amounts added to statutory contingency loss reserves required by state law or regulation, subject to certain limitations. This federal tax deduction is permitted only to the extent that U.S. Mortgage Guaranty Insurance Company Tax and Loss Bonds ("Tax and Loss Bonds") are purchased in the amount of the tax benefit attributable to the deduction. Tax and Loss Bonds are non-interest bearing and mature ten years from the designated issue date. Unrecaptured amounts previously deducted for statutory contingency loss reserves must be included in federal taxable income in the tenth subsequent tax year or earlier voluntary redemption. Tax and Loss Bond redemptions in December 2003 reduced the deferred tax liability for statutory contingency reserves by

\$248 million.

Our current income tax liability was \$222 million and \$507 million, at December 31, 2003 and 2002, respectively.

#### (16) Supplemental Cash Flow Information

Net taxes paid were \$798 million, \$291 million and \$20 million and interest paid was \$95 million, \$73 million and \$151 million for the years ended December 31, 2003, 2002 and 2001, respectively. At the date we acquired Saison Life in 2002, its assets included \$2.4 billion of cash which is not included in our Combined Statement of Cash Flows because this amount is presented with assets associated with discontinued operations.

F-41

#### (17) Stock Compensation

Certain Company employees have been granted GE stock options and restricted stock units ("RSUs") under GE's 1990 Long-Term Incentive Plan. RSUs give the recipients the right to receive shares of GE stock upon the lapse of their related restrictions. In the past, restrictions on most RSUs lapsed for 25% of the total shares awarded after three years, 25% after seven years, and 50% at retirement. Beginning in 2002, GE changed the vesting schedule for RSUs granted so that 25% of the restrictions lapse after three, five and ten years, with the final 25% lapsing at retirement. At December 31, 2003, our employees had 1,170,972 RSUs outstanding. Each RSU is convertible into one share of GE stock. We have recorded stock based compensation expense in the amount of \$9 million, \$6 million and \$4 million for 2003, 2002 and 2001, respectively, related to the cost of the RSUs and stock options.

Stock options expire 10 years from the date they are granted. Options vest over service periods that range from one to five years.

GE employees have routinely transferred employment between various GE subsidiaries, including to/from Genworth and our subsidiaries. GE stock options held by these employees have been reflected as transfers in and out in the following table. Our combined financial statements include compensation expense related to these awards, if any, for the portion of an employee's vesting period that accrued during Genworth employment. After our reorganization, employment transfers will no longer occur between Genworth and other GE subsidiaries.

After our reorganization, we will establish, adopt and maintain plans for selected employees, which will provide for stock options, stock awards, restricted stock or other equity-related awards. Under these plans, unvested GE stock options, vested stock options held by our Chairman, President and Chief Executive Officer, GE stock appreciation rights and GE restricted stock units will be canceled and converted into awards of our company.

The following table summarizes stock option activity related to our employees for the three years ended December 31, 2003:

(Shares in thousands)	Shares Subject to Option	Average per Share	
		Exercise Price	Market Price
<b>Balance at December 31, 2000</b>	7,270	\$ 23.89	\$ 47.94
Options granted	2,266	41.01	41.01
Options transferred in	726	26.78	—
Options exercised	(524)	9.21	44.03
Options transferred out	(251)	26.69	—
Options terminated	(194)	39.22	—
<b>Balance at December 31, 2001</b>	9,293	28.71	40.08
Options granted	1,774	27.08	27.08
Options transferred in	426	27.85	—
Options exercised	(618)	9.41	32.17
Options transferred out	(787)	25.67	—
Options terminated	(252)	38.13	—
<b>Balance at December 31, 2002</b>	9,836	29.47	24.35
Options granted	258	31.53	31.53
Options transferred in	331	26.89	—
Options exercised	(906)	9.50	27.84

F-42

Options transferred out	(1,249)	31.02	—
Options terminated	(341)	37.69	—
<b>Balance at December 31, 2003</b>	7,929	\$ 31.13	\$ 30.98

Outstanding options expire on various dates through 2013.

The following table summarizes information about stock options related to our employees outstanding at December 31, 2003:

Exercise price range	Outstanding			Exercisable	
	Shares in thousands	Average life <sup>(a)</sup>	Average exercise price	Shares in thousands	Average exercise price
\$8.16 — 14.73	1,479	1.7	\$ 11.20	1,479	\$ 11.20
22.08 — 26.42	877	4.2	24.58	877	24.57
27.05 — 30.45	1,512	8.6	27.08	323	27.20

31.53 — 40.19	1,830	6.8	36.24	729	37.20
42.33 — 57.31	2,231	7.0	45.45	1,203	45.31
Total	7,929	6.0	\$ 31.13	4,611	\$ 27.88

(a) Average contractual life remaining in years.

At year-end 2002, options with an average exercise price of \$21.14 were exercisable on 4,579 thousand shares; at year-end 2001, options with an average exercise price of \$15.66 were exercisable on 4,323 thousand shares.

The following table contains the weighted-average grant-date fair value information for 2003, 2002 and 2001. The fair value is estimated using the Black-Scholes option pricing model.

	2003	2002	2001
Fair value per option <sup>(a)</sup>	\$ 9.55	\$ 7.68	\$ 13.53
Valuation assumptions			
Expected option term (years)	6.0	6.0	6.0
Expected volatility	34.7%	33.7%	30.5%
Expected dividend yield	2.5%	2.7%	1.6%
Risk-free interest rate	3.5%	3.5%	4.9%

(a) Weighted averages of option grants during each period.

F-43

## (18) Related Party Transactions

GE provides a variety of products and services to us, and we provide a variety of products and services to GE. The services we receive from GE included:

- customer service, transaction processing and a variety of functional support services provided by GE Capital International Services, or GECIS;
- employee benefit processing and payroll administration, (see notes 12 and 17);
- employee training programs, including access to GE training courses;
- insurance coverage under the GE insurance program;
- information systems, network and related services;
- leases for vehicles, equipment and facilities; and
- other financial advisory services such as tax consulting, capital markets services, research and development activities, and trademark licenses.

Our total expenses for these services were \$87 million, \$74 million and \$52 million for the years ended December 31, 2003, 2002 and 2001, respectively. We also receive investment management and related administrative services provided by GEAM, for which we incurred expenses of \$61 million, \$39 million and \$2 million for the years ended December 31, 2003, 2002 and 2001, respectively.

In addition, we have recorded our allocated share of GE's corporate overhead for certain services provided to us, which are not specifically billed to us, including public relations, investor relations, treasury, and internal audit services in the amount of \$50 million, \$49 million and \$43 million for the years ended December 31, 2003, 2002 and 2001, respectively. We have also recorded expenses associated with GE stock option and restricted stock unit grants in the amount of \$9 million, \$6 million and \$4 million for the years ended December 31, 2003, 2002 and 2001, respectively, as described in note 17. These amounts will not be paid to GE and have been recorded as a capital contribution in each year.

We have entered into certain insurance transactions with affiliates of GE. During each of 2003, 2002 and 2001 we collected \$24 million, \$20 million and \$20 million, respectively, of premiums from various GE affiliates for long-term care insurance provided to employees of such affiliates. We have also reinsured some of the risks of our insurance policies with affiliates, and paid premiums of \$56 million, \$60 million and \$58 million to ERC Life Reinsurance Company (an affiliate until December 2003), and \$100 million, \$94 million and \$0 million to GE Pension Limited in 2003, 2002 and 2001, respectively.

We distribute some of our products through affiliates. We distribute our European payment protection insurance, in part, through arrangements with GE's consumer finance division and other GE entities, for which we have received gross written premiums of \$293 million, \$218 million and \$194 million during 2003, 2002 and 2001, respectively. We have also reinsured lease obligation insurance and credit insurance marketed by GE's consumer finance division and other GE entities, for which we received premiums of \$94 million, \$105 million and \$92 million during 2003, 2002 and 2001.

We sell to GE Mortgage Services, an affiliate of GE, properties acquired through claim settlement in our U.S. mortgage insurance business at a price equal to the product of the property's fair value and an agreed upon price factor. Under these arrangements, we received proceeds of \$9 million, \$13 million and \$11 million for the years ended December 31, 2003, 2002 and 2001, respectively.

F-44

During 2002, we sold certain available-for-sale fixed maturities to a subsidiary of GE Capital that is not consolidated in our financial statements at fair value, which resulted in net realized investment gains of \$114 million.

As of December 31, 2003 and 2002, we had several notes receivable from various GE affiliates in the amount of \$209 million and \$367 million, respectively. These notes mature at various dates through 2017 and bear interest at rates between 5.46% and 6.63%.

As of December 31, 2003 and 2002, we had approximately €2 million (\$2 million) and £5 million (\$9 million), respectively, of notes payable to various GE affiliates. These notes mature in 2011 and 2007 and bear interest at the six-month Euro Interbank Offered Rate ("EURIBOR") and 8.80%, respectively.

As of December 31, 2002, our Japanese life insurance business had ¥62.8 billion of long-term borrowings from various GE affiliates, which were carried at the translated amount of \$530 million. As described in note 4, we sold our Japanese life insurance and domestic auto and homeowners' insurance businesses to American International Group, Inc. in 2003.

As of December 31, 2003 and 2002, we had certain operating receivables of \$254 million and \$0 million, respectively, and payables of \$673 million and \$763 million, respectively, with certain affiliated companies.

As of December 31, 2003, we held \$47 million of commercial paper issued by GE Capital.

As of December 31, 2003 and 2002, we had a line of credit with GE that had an aggregate borrowing limit of \$2.5 billion. There was an outstanding balance of \$548 million as of December 31, 2003 and no outstanding balance as of December 31, 2002. Outstanding borrowings under this line of credit bear interest at the three-month U.S.\$ London Interbank Offered Rate ("LIBOR") plus 25 basis points. Interest is accrued and settled quarterly, in arrears. We incurred interest expense under this line of credit of \$0.5 million, \$8 million and \$11 million for the years ended December 31, 2003, 2002, and 2001, respectively. We also had a line of credit with an affiliate of GE Capital with an aggregate borrowing line of £10 million. There was no outstanding balance as of December 31, 2003 or 2002.

We, along with GE Capital, are participants in a revolving credit agreement that involves an international cash pooling arrangement on behalf of a number of GE subsidiaries in Europe, including some of our European subsidiaries. In these roles, either participant may make short-term loans to the other as part of the cash pooling arrangement. Each such borrowing shall be repayable upon demand, but not to exceed 364 days. This unsecured line of credit has an interest rate per annum equal to GE Capital Services' cost of funds for the currency in which such borrowing is denominated. This credit facility has an annual term, but is automatically extended for successive terms of one year each, unless terminated in accordance with the terms of the agreement. We had a net receivable of \$9 million and \$85 million under this credit facility as of December 31, 2003 and 2002, respectively.

GE Capital from time to time has provided guarantees and other support arrangements on our behalf, including performance guarantees and support agreements relating to securitization and comfort letters provided to government agencies. We have not incurred any charges for the provision of these guarantees and other support arrangements.

F-45

## (19) Fair Value of Financial Instruments

Assets and liabilities that are reflected in the accompanying combined financial statements at fair value are not included in the following disclosure of fair value; such items include cash and cash equivalents, investment securities, separate accounts and derivative financial instruments. Other financial assets and liabilities—those not carried at fair value—are discussed below. Apart from certain of our borrowings and certain marketable securities, few of the instruments discussed below are actively traded and their fair values must often be determined using models. The fair value estimates are made at a specific point in time, based upon available market information and judgments about the financial instruments, including estimates of the timing and amount of expected future cash flows and the credit standing of counterparties. Such estimates do not reflect any premium or discount that could result from offering for sale at one time our entire holdings of a particular financial instrument, nor do they consider the tax impact of the realization of unrealized gains or losses. In many cases, the fair value estimates cannot be substantiated by comparison to independent markets, nor can the disclosed value be realized in immediate settlement of the financial instrument.

The bases on which we estimate fair values are as follows:

*Mortgage loans.* Based on quoted market prices, recent transactions and/or discounted future cash flows, using rates at which similar loans would have been made to similar borrowers.

*Other financial instruments.* Based on comparable market transactions, discounted future cash flows, quoted market prices, and/or estimates of the cost to terminate or otherwise settle obligations.

*Borrowings.* Based on market quotes or comparables.

*Investment contract benefits.* Based on expected future cash flows, discounted at currently offered discount rates for immediate annuity contracts or cash surrender values for single premium deferred annuities.

*Insurance—credit life.* Based on future cash flows, considering expected renewal premiums, claims, refunds and servicing costs, discounted at a current market rate.

*Insurance—mortgage.* Based on carrying value which approximates fair value.

The following represents the fair value of financial assets and liabilities at December 31:

	2003			2002		
	Notional amount	Carrying amount	Estimated fair value	Notional amount	Carrying amount	Estimated fair value
<b>(Dollar amounts in millions)</b>						
<b>Assets:</b>						
Mortgage loans	\$	(a) \$	6,114	\$	(a) \$	5,684
Other financial instruments		(a)	34		(a)	44
<b>Liabilities:</b>						
<b>Borrowing and related instruments:</b>						
Borrowings <sup>(b) (c)</sup>		(a)	2,768		(a)	2,322
Investment contract benefits		(a)	31,206		(a)	30,962
Insurance — credit life	11,321		2,249	12,365		2,070
Performance guarantees, principally letters of credit	119		—	119		—

Insurance — mortgage	70,300	1,556	1,556	55,300	1,077	1,077
----------------------	--------	-------	-------	--------	-------	-------

F-46

Other firm commitments:

Ordinary course of business lending commitments	56	—	—	163	—	—
Commitments to fund limited partnerships	41	—	—	88	—	—

(a) These financial instruments do not have notional amounts.

(b) See note 13.

(c) Includes effects of interest rate and currency swaps.

On January 1, 2001, we adopted SFAS 133, *Accounting for Derivative Instruments and Hedging Activities*, as discussed in note 2. The paragraphs that follow provide additional information about derivatives and hedging relationships in accordance with SFAS 133.

The nature of our business activities necessarily involves the management of various financial and market risks, including those related to changes in interest rates. As discussed more fully in note 2 of the combined financial statements, we use derivative financial instruments to mitigate or eliminate certain of those risks. The January 1, 2001, accounting change previously described affected only the pattern and timing of non-cash accounting recognition.

A reconciliation of current period changes for the years ended December 31, 2003 and 2002, net of applicable income taxes in the separate component of stockholder's interest labeled "derivatives qualifying as hedges", follows:

	2003	2002
<b>(Dollar amounts in millions)</b>		
Derivatives qualifying as hedges as of January 1	\$ (98)	\$ (168)
Current period (decreases) increases in fair value, net	37	21
Reclassification to earnings, net	20	49
Reclassification adjustment from discontinued operations, net	36	—
<b>Balance at December 31</b>	<b>\$ (5)</b>	<b>\$ (98)</b>

*Derivatives and Hedging.* Our business activities routinely deal with fluctuations in interest rates in currency exchange rates and other asset prices. We follow strict policies for managing each of these risks, including prohibition on derivatives market-making, speculative derivatives trading or other speculative derivatives activities. These policies require the use of derivative instruments in concert with other techniques to reduce or eliminate these risks.

*Cash flow hedges.* Under SFAS 133, cash flow hedges are hedges that use simple derivatives to offset the variability of expected future cash flows. Variability can appear in floating rate assets, floating rate liabilities or from certain types of forecasted transactions, and can arise from changes in interest rates or currency exchange rates. For example, we may borrow funds at a variable rate of interest. If we need these funds to make a floating rate loan, there is no exposure to interest rate changes, and no hedge is necessary. However, if a fixed rate loan is made, we may contractually commit to pay a fixed rate of interest to a counterparty who will pay us a variable rate of interest (an "interest rate swap"). This swap will then be designated as a cash flow hedge of the associated variable rate borrowing. If, as

F-47

would be expected, the derivative is highly effective in offsetting variable rates in the borrowing, changes in its fair value are recorded in a separate component of accumulated nonowner changes in stockholder's interest and released to earnings contemporaneously with the earnings effects of the hedged item. Further information about hedge effectiveness is provided below.

We use currency forwards and interest rate and currency swaps, to optimize investment returns and borrowing costs. For example, currency swaps and non-functional currency borrowings together provide lower funding costs than could be achieved by issuing debt directly in a given currency.

At December 31, 2003, amounts related to derivatives qualifying as cash flow hedges resulted in an increase of stockholder's interest of \$93 million, of which \$8 million was expected to be transferred to earnings in 2004, along with the earnings effects of the related forecasted transactions in 2003.

*Fair value hedges.* Under SFAS 133, fair value hedges are hedges that eliminate the risk of changes in the fair values of assets, liabilities and certain types of firm commitments. For example, we often purchase assets which pay a fixed rate of interest. If these assets were purchased to support fixed rate liabilities, there is consistency in the interest rate exposure of both, and no hedge is necessary. However, if the assets were purchased to offset floating rate liabilities, we will contractually commit to pay a fixed rate of interest to a counterparty who will pay us a floating rate of interest (an "interest rate swap"). This swap will then be designated as a fair value hedge of the asset purchased. Changes in fair value of derivatives designated and effective as fair value hedges are recorded in earnings and are offset by corresponding changes in the fair value of the hedged item.

We use interest rate swaps, currency swaps and interest rate and currency forwards to hedge the effect of interest rate and currency exchange rate changes on local and non functional currency denominated fixed rate borrowings and certain types of fixed rate assets. Equity options are used to hedge price changes in equity indexed annuity liabilities.

*Net investment hedges.* The net investment hedge designation under SFAS 133 refers to the use of derivative contracts or cash instruments to hedge the foreign currency exposure of a net investment in a foreign operation. Currency exposures that result from net investments in affiliates are managed principally by funding assets denominated in local currency with liabilities denominated in that same currency.

*Derivatives not designated as hedges.* SFAS 133 specifies criteria that must be met in order to apply any of the three forms of hedge accounting. For example, hedge accounting is not permitted for hedged items that are marked to market through earnings. We use derivatives to hedge exposures when it makes economic sense to do so,

including circumstances in which the hedging relationship does not qualify for hedge accounting as described in the following paragraph. We will also occasionally receive derivatives in the ordinary course of business. Under SFAS 133, derivatives that do not qualify for hedge accounting are marked to market through earnings.

We use option contracts, including floors, as an economic hedge of changes in interest rates, currency exchange rates and equity prices on certain types of liabilities. Although these instruments are considered to be derivatives under SFAS 133, our economic risk is similar to, and managed on the same basis as other equity instruments we hold.

F-48

*Earnings effects of derivatives.* The table that follows provides additional information about the earnings effects of derivatives. In the context of hedging relationships, "effectiveness" refers to the degree to which fair value changes in the hedging instrument offset corresponding fair value changes in the hedged item. Certain elements of hedge positions cannot qualify for hedge accounting under SFAS 133 whether effective or not, and must therefore be marked to market through earnings. Time value of purchased options is the most common example of such elements in instruments we use. Pre-tax earnings effects of such items for the year ended December 31, 2003 are shown in the following table as "Amounts excluded from the measure of effectiveness."

(Dollar amounts in millions)	Cash flow hedges	Fair value hedges
Ineffectiveness	\$ 1	\$ 5
Amounts excluded from the measure of effectiveness	—	—

At December 31, 2003, the fair value of derivatives in a gain position and recorded in Other assets was \$252 million and the fair value of derivatives in a loss position and recorded in Other liabilities was \$281 million.

*Counterparty credit risk.* The risk that counterparties to derivative contracts will be financially unable to make payments to us according to the terms of the agreements is counterparty credit risk. We manage counterparty credit risk on an individual counterparty basis, which means that we net gains and losses for each counterparty to determine the amount at risk. When a counterparty exceeds credit exposure limits in terms of amounts they owe us, typically as a result of changes in market conditions (see table below), no additional transactions are permitted to be executed until the exposure with that counterparty is reduced to an amount that is within the established limit. All swaps are required to be executed under master swap agreements containing mutual credit downgrade provisions that provide the ability to require assignment or termination in the event either party is downgraded below A3 or A-. If the downgrade provisions had been triggered at December 31, 2003, we could have been required to disburse up to \$190 million and could have claimed \$161 million from counterparties—the net fair value losses and gains. At December 31, 2003 and 2002, gross fair value gains were \$252 million and \$278 million, respectively. At December 31, 2003 and 2002, gross fair value losses were \$281 million and \$275 million, respectively.

Except for such positions, all other swaps, purchased options and forwards with contractual maturities longer than one year are conducted within the credit policy constraints provided in the table below. We may, however, enter into derivative transactions for durations of five years or longer with lower rated counterparties (Moody's Aa3 and S&P's AA-) if the agreements governing such transactions require both us and the counterparties to provide collateral in certain circumstances. Foreign exchange forwards with contractual maturities shorter than one year must be executed with counterparties having an A-1/ P-1 credit rating and the credit limit for these transactions is \$150 million.

F-49

#### Counterparty credit criteria

	Credit Rating	
	Moody's	Standard & Poor's
Term of transaction		
Up to five years	Aa3	AA-
Greater than five years	Aaa	AAA
Credit exposure limit		
Up to \$50 million	Aa3	AA-
Up to \$75 million	Aaa	AAA

#### (20) Non-Controlled Entities

One of the most common forms of off-balance sheet arrangements is asset securitization. We use GE Capital-sponsored and third party entities to facilitate asset securitizations. As part of this strategy, management considers the relative risks and returns of our alternatives and predominately uses GE Capital-sponsored entities. Management believes these transactions could be readily executed through third party entities at insignificant incremental cost.

The following table summarizes the current balance of assets sold to Qualified Special Purposes Entities (QSPE's) at December 31:

(Dollar amounts in millions)	2003	2002
Assets—collateralized by:		
Commercial mortgage loans	\$ 816	\$ 428
Fixed maturities	—	679
Other receivables	800	825

Total assets

\$ 1,616 \$ 1,932

We evaluate the economic, liquidity and credit risk related to the above QSPEs and believe that the likelihood is remote that any such arrangements could have a significant adverse effect on our financial position, results of operations, or liquidity. Financial support for certain SPE's is provided under credit support agreements, in which we provide limited recourse for a maximum of \$119 million of credit losses in qualifying entities. Assets with credit support are funded by demand notes that are further enhanced with support provided by GE Capital. We record liabilities for such guarantees based on our best estimate of probable losses. To date, we have not been required to make any payments under any of the credit support agreements. These agreements will remain in place throughout the life of the related entities.

Sales of securitized assets to SPEs result in a gain or loss amounting to the net of sales proceeds, the carrying amount of net assets sold, the fair value of servicing rights and retained interests and an

F-50

allowance for losses. Amounts recognized in our combined financial statements related to sales to sponsored or supported SPEs at December 31 are as follows:

	2003		2002	
	Cost	Fair value	Cost	Fair value
<i>(Dollar amounts in millions)</i>				
Retained interests—assets	\$ 143	\$ 171	\$ 76	\$ 103
Servicing asset	—	—	—	—
Recourse liability	—	—	—	—
Total	\$ 143	\$ 171	\$ 76	\$ 103

**Retained interests.** In certain securitization transactions, we retain an interest in transferred assets. Those interests take various forms and may be subject to credit prepayment and interest rate risks.

**Servicing assets.** Following a securitization transaction, we retain the responsibility for servicing the receivables, and, as such, are entitled to receive an ongoing fee based on the outstanding principal balances of the receivables. There are no servicing assets nor liabilities recorded as the benefits of servicing the assets are adequate to compensate an independent servicer for its servicing responsibilities.

**Recourse liability.** As described previously, under credit support agreements we provide recourse for credit losses in special purpose entities. We provide for expected credit losses under these agreements and such amounts approximate fair value.

## (21) Restrictions on Dividends

Our insurance companies are restricted by state and foreign insurance departments as to the aggregate amount of dividends they may pay to their parent without regulatory approval, the purpose of which is to protect affected insurance policyholders, depositors or investors. Dividends in excess of regulatory prescribed limits are deemed "extraordinary" and require formal insurance department approval. Based on statutory results as of December 31, 2003, our subsidiaries could pay dividends of \$1,121 million to us in 2004 without obtaining regulatory approval.

We received from our insurance subsidiaries dividends of \$1,472 (\$1,400 million of which were deemed "extraordinary") million, \$840 million (\$375 million of which were deemed "extraordinary") and \$410 million, during 2003, 2002 and 2001, respectively. During 2003, we also received dividends from insurance subsidiaries related to discontinued operations of \$495 million. We declared and paid dividends of \$3,168 to our parent during 2003. We declared dividends of \$171 million during 2002 of which \$107 million was paid in 2002 and \$64 million was paid in 2003. We declared dividends of \$31 million in 2001 of which \$6 million was paid in 2001 and \$25 million was paid in 2002.

F-51

## (22) Supplementary Financial Data

Our U.S. domiciled insurance subsidiaries file financial statements with state insurance regulatory authorities and the "NAIC" that are prepared on an accounting basis prescribed or permitted by such authorities (statutory basis). Statutory accounting practices differ from U.S. GAAP in several respects, causing differences in reported net earnings and stockholder's interest. Permitted statutory accounting practices encompass all accounting practices not so prescribed but that have been specifically allowed by state insurance authorities. Our insurance subsidiaries have no significant permitted accounting practices.

Combined statutory net income for our U.S. domiciled insurance subsidiaries for the years ended December 31, 2003, 2002 and 2001 was \$389 million, \$26 million and \$648 million, respectively. The combined statutory capital and surplus as of December 31, 2003 and 2002 was 7.0 billion and 7.2 billion, respectively.

The NAIC has adopted Risk-Based Capital (RBC) requirements to evaluate the adequacy of statutory capital and surplus in relation to risks associated with: (i) asset risk, (ii) insurance risk, (iii) interest rate risk, and (iv) business risk. The RBC formula is designated as an early warning tool for the states to identify possible undercapitalized companies for the purpose of initiating regulatory action. In the course of operations, we periodically monitor the RBC level of each of our insurance subsidiaries. At December 31, 2002 and 2001, each of our insurance subsidiaries exceeded the minimum required RBC levels.

For statutory purposes, our mortgage insurance subsidiaries are required to maintain a statutory contingency reserve. Annual additions to the statutory contingency reserve equal 50% of earned premiums and are maintained for ten years.

## (23) Operating and Geographic Segments

### (a) Operating Segment Information



We conduct our operations through five business segments: (1) Protection, which includes our life insurance, long-term care insurance, group life and health insurance and European payment protection insurance; (2) Retirement Income and Investments, which includes our fixed, variable and income annuities, variable life insurance, asset management and specialized products, including GICs, funding agreements and structured settlements; (3) Mortgage Insurance, which includes our mortgage insurance products that facilitate homeownership by enabling borrowers to buy homes with low-down-payment mortgages; (4) Affinity, which includes life and health insurance and other financial products and services offered directly to consumers through affinity marketing arrangements with a variety of organizations, an institutional asset management business and several other small businesses that are not part of our core ongoing business; and (5) Corporate and Other, which includes net realized investment gains (losses), interest and other debt financing expenses and unallocated corporate income and expenses, as well as the results of several small, non-core businesses that are managed outside our operating segments.

F-52

The following is a summary of segment activity for 2003, 2002 and 2001:

2003—Segment Data	Protection	Retirement Income and Investments	Mortgage Insurance	Affinity	Corporate and Other	Combined
<b>(Dollar amounts in millions)</b>						
Premiums	\$ 4,588	\$ 1,045	\$ 716	\$ 244	\$ 110	\$ 6,703
Net investment income	1,199	2,511	218	62	25	4,015
Net realized investment gains	—	—	—	—	10	10
Policy fees and other income	366	225	48	260	44	943
<b>Total revenues</b>	<b>6,153</b>	<b>3,781</b>	<b>982</b>	<b>566</b>	<b>189</b>	<b>11,671</b>
Benefits and other changes in policy reserves	2,997	1,871	115	196	53	5,232
Interest credited	365	1,259	—	—	—	1,624
Underwriting acquisition and insurance expenses, net of deferrals	1,029	232	299	239	143	1,942
Amortization of deferred acquisition costs and intangibles	1,001	190	37	110	13	1,351
Interest expense	3	—	—	—	137	140
<b>Total benefits and expenses</b>	<b>5,395</b>	<b>3,552</b>	<b>451</b>	<b>545</b>	<b>346</b>	<b>10,289</b>
Earnings (loss) from continuing operations before income taxes	758	229	531	21	(157)	1,382
Provision (benefit) for income taxes	271	78	162	5	(103)	413
<b>Net earnings (loss) from continuing operations</b>	<b>\$ 487</b>	<b>\$ 151</b>	<b>\$ 369</b>	<b>\$ 16</b>	<b>\$ (54)</b>	<b>\$ 969</b>
<b>Total assets</b>	<b>\$ 29,254</b>	<b>\$ 55,614</b>	<b>\$ 6,110</b>	<b>\$ 2,315</b>	<b>\$ 10,138</b>	<b>\$ 103,431</b>
2002—Segment Data	Protection	Retirement Income and Investments	Mortgage Insurance	Affinity	Corporate and Other	Combined
<b>(Dollar amounts in millions)</b>						
Premiums	\$ 4,088	\$ 991	\$ 677	\$ 247	\$ 104	\$ 6,107
Net investment income	1,136	2,522	231	70	20	3,979
Net realized investment gains	—	—	—	—	204	204
Policy fees and other income	381	243	38	271	6	939
<b>Total revenues</b>	<b>5,605</b>	<b>3,756</b>	<b>946</b>	<b>588</b>	<b>334</b>	<b>11,229</b>
Benefits and other changes in policy reserves	2,630	1,769	46	180	15	4,640
Interest credited	362	1,283	—	—	—	1,645
Underwriting acquisition and insurance expenses, net of deferrals	930	221	233	312	112	1,808
Amortization of deferred acquisition costs and intangibles	846	210	39	116	10	1,221
Interest expense	—	—	—	—	124	124
<b>Total benefits and expenses</b>	<b>4,768</b>	<b>3,483</b>	<b>318</b>	<b>608</b>	<b>261</b>	<b>9,438</b>
Earnings (loss) from continuing operations before income taxes	837	273	628	(20)	73	1,791
Provision (benefit) for income taxes	283	87	177	(17)	(119)	411
<b>Net earnings (loss) from continuing operations</b>	<b>\$ 554</b>	<b>\$ 186</b>	<b>\$ 451</b>	<b>\$ (3)</b>	<b>\$ 192</b>	<b>\$ 1,380</b>
<b>Total assets</b>	<b>\$ 27,104</b>	<b>\$ 53,624</b>	<b>\$ 6,066</b>	<b>\$ 2,317</b>	<b>\$ 28,246</b>	<b>\$ 117,357</b>

2001—Segment Data	Protection	Retirement Income and Investments	Mortgage Insurance	Affinity	Corporate and Other	Combined
<b>(Dollar amounts in millions)</b>						
Premiums	\$ 3,915	\$ 1,023	\$ 698	\$ 286	\$ 90	\$ 6,012
Net investment income (losses)	1,119	2,482	227	74	(7)	3,895
Net realized investment gains	—	—	—	—	201	201
Policy fees and other income	409	216	40	327	1	993
<b>Total revenues</b>	<b>5,443</b>	<b>3,721</b>	<b>965</b>	<b>687</b>	<b>285</b>	<b>11,101</b>
Benefits and other changes in policy reserves	2,380	1,736	150	188	20	4,474
Interest credited	342	1,278	—	—	—	1,620
Underwriting acquisition and insurance expenses, net of deferrals	1,043	187	180	320	93	1,823
Amortization of deferred acquisition costs and intangibles	839	181	51	156	10	1,237
Interest expense	—	—	—	—	126	126
<b>Total benefits and expenses</b>	<b>4,604</b>	<b>3,382</b>	<b>381</b>	<b>664</b>	<b>249</b>	<b>9,280</b>
Earnings from continuing operations before income taxes	839	339	584	23	36	1,821
Provision (benefit) for income taxes	301	124	156	(1)	10	590
<b>Net earnings from continuing operations</b>	<b>\$ 538</b>	<b>\$ 215</b>	<b>\$ 428</b>	<b>\$ 24</b>	<b>\$ 26</b>	<b>\$ 1,231</b>
Total assets	\$ 24,647	\$ 50,512	\$ 5,830	\$ 2,211	\$ 20,798	\$ 103,998

*(b) Revenues of Major Product Groups*

<b>(Dollar amounts in millions)</b>	2003	2002	2001
Long-term care insurance	\$ 2,417	\$ 2,087	\$ 1,921
European payment protection insurance	1,615	1,372	1,303
Life insurance	1,444	1,432	1,511
Group life and health insurance	677	714	708
<b>Total Protection segment revenues</b>	<b>6,153</b>	<b>5,605</b>	<b>5,443</b>
Spread-based products	3,457	3,447	3,456
Fee-based products	324	309	265
<b>Total Retirement Income and Investments segment revenues</b>	<b>3,781</b>	<b>3,756</b>	<b>3,721</b>
U.S. mortgage insurance	665	750	812
International mortgage insurance	317	196	153
<b>Total Mortgage Insurance segment revenues</b>	<b>982</b>	<b>946</b>	<b>965</b>
<b>Affinity segment revenues</b>	<b>566</b>	<b>588</b>	<b>687</b>
<b>Corporate and Other segment revenues</b>	<b>189</b>	<b>334</b>	<b>285</b>
<b>Total revenues</b>	<b>\$ 11,671</b>	<b>\$ 11,229</b>	<b>\$ 11,101</b>

*(c) Geographic Segment Information*

We conduct our operations in two geographic regions: (1) United States and (2) International.

The following is a summary of geographic region activity as of and for the years ended December 31, 2003, 2002 and 2001.

2003	United States	International	Combined
<b>(Dollar amounts in millions)</b>			
Total revenues	\$ 9,620	\$ 2,051	\$ 11,671
Net earnings from continuing operations	\$ 717	\$ 252	\$ 969
Total assets	\$ 96,452	\$ 6,979	\$ 103,431
<b>2002</b>			
Total revenues	\$ 9,622	\$ 1,607	\$ 11,229
Net earnings from continuing operations	\$ 1,217	\$ 163	\$ 1,380
Total assets	\$ 111,739	\$ 5,618	\$ 117,357
<b>2001</b>			
Total revenues	\$ 9,577	\$ 1,524	\$ 11,101
Net earnings from continuing operations	\$ 1,094	\$ 137	\$ 1,231
Total assets	\$ 98,569	\$ 5,429	\$ 103,998

#### (24) Litigation

We are subject to legal and regulatory actions in the ordinary course of our businesses, including class actions. Our pending legal and regulatory actions include proceedings specific to us and others generally applicable to business practices in the industries in which we are operating. Plaintiffs in class action and other lawsuits against us may seek very large or indeterminate amounts, including punitive and treble damages. Given the large or indeterminate amounts sought in certain of these matters and the inherent unpredictability of litigation, it is possible that an adverse outcome in some of our matters could have a material adverse effect on our combined financial condition or results of operations.

One of our insurance subsidiaries is named as a defendant in a lawsuit in Georgia (*McBride v. Life Insurance Co. of Virginia dba GE Life and Annuity Assurance Co.* ("GE Life")) related to the sale of universal life insurance policies. The complaint was filed on November 1, 2000 as a class action on behalf of all persons who purchased certain universal life insurance policies from that subsidiary and alleges improper practices in connection with the sale and administration of universal life policies. We have vigorously denied liability with respect to the plaintiff's allegations. Nevertheless, to avoid the risks and costs associated with protracted litigation and to resolve its differences with policyholders, GE Life agreed in principle on October 8, 2003, to settle the case on a nationwide class action basis. The

F-55

settlement documents have not been finalized, nor has any proposed settlement been submitted to the proposed class and the U.S. District Court for approval, and a final settlement is not certain. In the third quarter of 2003, we accrued \$50 million in reserves relating to this litigation, which represents our best estimate of bringing this matter to conclusion. The precise amount of payments in this matter cannot be estimated because they are dependent upon court approval of the class and related settlement, the number of individuals who ultimately will seek relief in the claim form process of any approved class settlement, the identity of such claimants and whether they are entitled to relief under the settlement terms and the nature of the relief to which they are entitled.

One of our mortgage insurance subsidiaries is named as a defendant in two lawsuits filed in the U.S. District Court for the Northern District of Illinois, *William Portis et al. v. GE Mortgage Insurance Corp. and Karwo v. Citimortgage, Inc. and General Electric Mortgage Insurance Corporation*. The *Portis* complaint was filed on January 15, 2004, and the *Karwo* complaint was filed on March 15, 2004. Each action seeks certification of a nationwide class of consumers who allegedly were required to pay for our private mortgage insurance at a rate higher than our "best available rate," based upon credit information we obtained. Each action alleges that the Federal Fair Credit Reporting Act (the "FCRA") requires an "adverse action" notice to such borrowers and that we violated the FCRA by failing to give such notice. The plaintiffs in *Portis* allege in the complaint that they are entitled to "actual damages" and "damages within the Court's discretion of not more than \$1,000 for each separate violation" of the FCRA. The plaintiffs in *Karwo* allege that they are entitled to "appropriate actual, punitive and statutory damages" and "such other or further relief as the Court deems proper." Similar cases are pending against six other mortgage insurers. We intend to vigorously defend against these actions, but we cannot predict their outcome.

F-56

#### Independent Auditors' Report

The Board of Directors  
Genworth Financial inc.:

We have audited the accompanying statement of financial position of Genworth Financial, Inc. (the "Company") as of December 31, 2003. This financial statement is the responsibility of the Company's management. Our responsibility is to express an opinion on this financial statement based on our audit.

We conducted our audit in accordance with auditing standards generally accepted in the United States of America. Those standards require that we plan and perform the audit to obtain reasonable assurance about whether the statement of financial position is free of material misstatement. An audit of a statement of financial position includes examining, on a test basis, evidence supporting the amounts and disclosures in that statement. An audit of a statement of financial position also includes assessing the accounting principles used and significant estimates made by management, as well as evaluating the overall statement presentation. We believe that our audit of the statement of financial position provides a reasonable basis for our opinion.

In our opinion, the statement of financial position referred to above presents fairly, in all material respects, the financial position of Genworth Financial, Inc. as of December 31, 2003, in conformity with accounting principles generally accepted in the United States of America.

/s/ KPMG LLP  
 Richmond, Virginia  
 February 6, 2004

F-57

**Genworth Financial, Inc.**  
**Statement of Financial Position**  
**December 31, 2003**

<b>Assets</b>	
Cash	\$ 1,000
<b>Total Assets</b>	<b>\$ 1,000</b>
<b>Stockholder's Interest</b>	
Common stock, \$0.01 par value; 1,000 shares authorized, issued and outstanding	\$ 10
Capital in excess of par value	990
<b>Total Stockholder's Interest</b>	<b>\$ 1,000</b>

**Note to Statement of Financial Position**

**1. Organization and Purpose**

Genworth Financial, Inc. ("Genworth") was incorporated in Delaware on October 23, 2003. In connection with its formation, Genworth issued 1,000 shares of common stock for \$1,000 to GE Financial Assurance Holdings, Inc. ("GEFAHI"), an indirect subsidiary of General Electric Company ("GE").

Genworth was formed in preparation for the corporate reorganization of certain insurance and related subsidiaries of GE and an initial public offering of Genworth common stock. Genworth will acquire substantially all of the assets and liabilities of GEFAHI, a holding company for a group of companies that provide annuities and other investment products, life insurance, long-term care insurance, group life and health insurance and mortgage insurance. Genworth will also acquire certain other insurance businesses currently owned by other GE subsidiaries and enter into several significant reinsurance transactions with an affiliate of GE.

Other than the receipt and deposit of its initial capital and the filing of a Registration Statement with the Securities and Exchange Commission in connection with the planned initial public offering of its common stock, Genworth has not undertaken commercial activities.

F-58

**Glossary of Selected Insurance Terms**

The following Glossary includes definitions of certain insurance, reinsurance, investment and other terms.

A.M. Best	A.M. Best Company, a rating agency.
Account value	The amount of investment products held for the benefit of a policyholder or contract holder. For mutual funds, account value is equal to fair market value.
Accumulation period	The period during which an individual makes regular contributions to a deferred annuity or retirement plan. The period ends when the income payments begin.
Annualized first-year premiums	Premium payments related only to new sales and calculated as if they were consistently paid for the full year of the sale even if they were actually paid for only a portion of the year of the sale.
Annuity	A contract that provides for periodic payments to an annuitant for a specified period, often until the annuitant's death.
Assets under management	Assets we manage directly in our proprietary products, such as our mutual funds and variable annuities, in our separate accounts and in our general account, and assets invested in investment options included in our products that are managed by third-party sub-managers.
Bulk insurance	Primary mortgage insurance whereby a portfolio of loans is insured in a single, bulk transaction.
Captive reinsurance	In the mortgage insurance industry, a reinsurance program in which the mortgage insurer shares portions of the mortgage insurance risk written on loans originated or purchased by lenders with captive reinsurance companies affiliated with these lenders.
Captive reinsurer	In the mortgage insurance industry, any reinsurance company that is wholly-owned by another organization (generally the lender or an affiliate of the lender), the main purpose of which is to insure the risks of the parent organization.
Cash value	The amount of cash available to a policyholder on the surrender of or withdrawal from a life insurance policy or annuity contract.
Cede	Reinsuring with another insurance company all or a portion of the risk we insure.
Credit ratings	The opinions of rating agencies regarding an entity's ability to repay its indebtedness.

	<p>The purpose of Moody's credit ratings is to provide investors with a simple system of gradation by which relative creditworthiness of securities may be noted. Moody's long-term obligation ratings currently range from "Aaa" (highest quality) to "C" (lowest rated). Moody's long-term obligation ratings grade debt according to its investment quality. Moody's considers "Aa2" and "A3" rated long-term obligations to be upper-medium grade obligations and subject to low risk. Moody's short-term credit ratings range from "P-1" (superior) to "NP" (not prime).</p> <p>S&amp;P's credit ratings range from "AAA" (highest rating) to "D" (payment default). S&amp;P publications indicate that an "A+" rated issue is somewhat more susceptible to the adverse effects of changes in circumstances and economic condition than obligations in higher rated categories; however, the obligor's capacity to meet its financial commitment to the obligation is still strong. S&amp;P short-term ratings range from "A-1" (highest category) to "D" (payment default). Within the A-1 category some obligations are designated with a plus sign (+) indicating that the obligor's capacity to meet its financial commitment on the obligation is extremely strong.</p>
Crediting rate	The interest rate credited on a life insurance policy or annuity contract, which may be a guaranteed fixed rate, a variable rate or some combination of both.
Deferred acquisition costs (DAC)	Commissions and other selling and issuance expenses which vary with and are primarily related to the sale and issuance of our insurance policies and investment contracts that are deferred and amortized over the estimated life of the related insurance policies in conformity with U.S. GAAP. These costs include commissions in excess of ultimate renewal commissions, direct mail and printing costs, sales material and some support costs, such as underwriting and policy and contract issuance expenses.
Deferred annuities	Annuity contracts that delay income payments until the holder chooses to receive them.
Defined benefit pension plan	A pension plan that promises to pay a specified amount to each eligible plan member who retires.
Defined contribution plan	A plan established under Section 401(a), 401(k), 403(b) or 457(b) of the Internal Revenue Code, under which the benefits to a participant depend on contributions made to, and the investment return on, the participant's account.
Earned premium	The portion of written premium, net of any amount ceded, that represents coverage already provided or that belongs to the insurer based on the part of the policy period that has passed.
Financial strength ratings	The opinions of rating agencies regarding the financial ability of an insurance company to meet its obligations under its insurance policies.

G-2

	<p>A.M. Best's financial strength ratings for insurance companies currently range from "A++" (superior) to "F" (in liquidation). A.M. Best's ratings reflect its opinion of an insurance company's financial strength, operating performance and ability to meet its obligations to policyholders. A.M. Best considers "A" and "A-" rated companies to have an excellent ability to meet their ongoing obligations to policyholders and "B++" companies to have a good ability to meet their ongoing obligations to policyholders.</p> <p>Fitch's financial strength ratings currently range from "AAA" (exceptionally strong) to "D" (distressed). These ratings provide an assessment of the financial strength of an insurance organization and its capacity to meet senior obligations to policyholders and contract holders on a timely basis. According to Fitch's publications, "AA" (very strong) rated insurance companies are viewed as possessing very strong capacity to meet policyholder and contract obligations. Risk factors are modest, and the impact of any adverse business and economic factors is expected to be very small. The symbol (+) or (-) may be appended to a rating to indicate the relative position of a credit within a rating category. Such suffixes are not added to ratings in the "AAA" category or to ratings below the "CCC" category.</p>
	<p>Moody's financial strength ratings currently range from "Aaa" (exceptional) to "C" (lowest rated). Moody's ratings reflect the ability of insurance companies to repay punctually senior policy-holder claims and obligations. Moody's indicates that "A1" rated insurance companies offer good financial security, but elements may be present which suggest a susceptibility to impairment sometime in the future. The symbol "1" following "A" shows a company's relative standing within the "A" rating category.</p> <p>S&amp;P's financial strength ratings currently range from "AAA" (extremely strong) to "R" (regulatory action). These ratings reflect S&amp;P's opinion of an operating insurance company's financial capacity to meet the obligations of its insurance policies and contracts in accordance with their terms. According to S&amp;P's publications, "A+" rated insurance companies have strong financial security characteristics, but are somewhat more likely to be affected by adverse business conditions than insurers with higher ratings. The symbol (+) following "A" shows a company's relative standing within the "A" rating category.</p>
First-year premiums	The amount of premiums received during the first year on insurance policies sold plus the amount of deposits on variable and universal life policies sold or additional premiums or deposits from conversions received over the specified period. This figure does not reflect policies that lapse in their first year.

G-3

Fitch	Fitch Ratings Ltd. and its subsidiaries, a rating agency.
Fixed annuities	An annuity under which the interest rate credited on the annuity during the accumulation phase is a fixed rate, which may change periodically, until it matures.
Flow insurance	Primary mortgage insurance placed on an individual loan when the loan is originated.
Funding agreements	A contract that guarantees a minimum rate of return, which may be fixed or floating, on the amount invested.
General account	All of the assets of our insurance companies recognized for statutory accounting purposes other than those specifically allocated to a separate account. We bear the risk of our investments held in our general account.
Gross written premiums	Total premiums for insurance written and reinsurance assumed during a given period.
Group insurance	Insurance which is issued to a group, such as an employer, credit union, or trade association, and which provides coverage for individuals and sometimes their dependents.

Guaranteed investment contract (GIC)	A contract, usually purchased by ERISA qualified plans, that guarantees a minimum rate of return, which may be fixed or floating, on the amount invested.
Immediate annuities	Annuity contracts under which the benefits payable to the annuitant begin to be paid within one year of contract issuance.
Income annuities	Annuity contracts that provide for a single premium at the time of issue and guarantee a series of payments beginning within one year of the issue date and continuing over a period of years.
In-force	Policies and contracts reflected on our applicable records that have not expired or been terminated as of a given date.
Insurance in force	The value of mortgage insurance policies, based on the original principal amount of mortgages covered by mortgage insurance policies that remain in effect.
LIMRA International	Life Insurance Marketing and Research Association, an association of life insurance and other financial services companies.
Loan-to-value	The ratio of the original principal balance of a mortgage loan to the property's fair market value or appraised value at the time of the loan.
Long-term care insurance	Insurance that protects the insured from certain costs of care at home or in an outside facility.
Loss adjustment expense	The expense involved in settling a loss, excluding the actual value of the loss.

G-4

Medical stop loss insurance	Insurance that provides protection against catastrophic or unpredictable losses. It is purchased by employers who have decided to self-fund their employee benefit plans, but do not want to assume 100% of the liability for losses arising from the plans. Under a medical stop loss policy, the insurance company becomes liable for losses that exceed certain limits called deductibles.
Medicare supplement insurance	Insurance that provides coverage for Medicare-qualified expenses that are not covered by Medicare because of applicable deductibles or maximum limits.
Moody's	Moody's Investors Service, Inc., a rating agency.
Morbidity	The incidence of disease or disability in a specific population over a specific period of time.
Mortality	The number of deaths in a specific population over a specific period of time.
New insurance written	The original principal balance of mortgages covered by newly issued primary mortgage insurance.
New risk written	The original principal balance of mortgage loans covered by newly issued primary mortgage insurance, multiplied by the applicable coverage percentage.
Non-admitted assets	Certain assets or portions thereof that are not permitted to be reported as admitted assets in an insurer's statutory financial statement. As a result, certain assets which normally would be accorded value in the financial statements of non-insurance corporations are accorded no value and thus reduce the reported statutory policyholder surplus of the insurer.
Payment protection insurance	Insurance that helps consumers meet their payment obligations on outstanding financial commitments, such as mortgage, personal loans or credit cards, in the event of a misfortune, such as accident, illness, involuntary unemployment, temporary incapacity, permanent disability or death.
Persistency	Measurement by premiums of the percentage of insurance policies or annuity contracts remaining in force between specified measurement dates.
Policy loans	Loans from an insurer secured by the cash surrender value of a life insurance policy.
Pool insurance	In the U.S., mortgage insurance coverage on portfolios of loans, typically with an aggregate coverage limit, which is used as a credit enhancement in connection with the securitization of the related portfolio.
Portfolio credit enhancement	In our international mortgage insurance businesses, a form of primary mortgage insurance purchased by lenders on loans in a portfolio to reduce capital requirements or as a credit enhancement in anticipation of securitization.

G-5

Premiums	Payments and other consideration received on insurance policies issued or reinsured by an insurance company, which are earned in accordance with U.S. GAAP over the terms of the related insurance policies or in proportion to expected claims or expiration of risk, depending on the nature of the policy. Under U.S. GAAP, premiums on investment-type contracts are not accounted for as revenues.
Present value of future profits (PVFP)	An intangible asset that represents the actuarially estimated present value of future cash flows from an acquired block of insurance policies or investment contracts and that is amortized over the estimated life of the related insurance policies or contracts in conformity with U.S. GAAP.
Primary mortgage insurance	Mortgage insurance, including flow and bulk but excluding pool, that protects mortgage lenders and investors from default-related losses on mortgage loans.
Primary mortgage insurance in force	Primary mortgage insurance, as determined by the value of mortgage insurance policies that remain in effect, based on the original principal amount of mortgages covered by such policies.
Private mortgage insurance	Mortgage insurance provided by nongovernmental insurers that protects a lender or investor against loss if the borrower defaults.
Qualified insurer	A mortgage guaranty insurer that is approved by each of Fannie Mae and Freddie Mac, pursuant to their respective charters, as meeting their requirements for insuring against credit losses on high loan-to-value loans.
Reinsurance	The ceding by one insurance company to another company of all or a portion of a risk for a premium. The ceding of risk, other than in the case of assumption reinsurance, does not relieve the original insurer of its liability to the insured.
Reserves	Liabilities established by insurers and reinsurers to reflect the estimated costs of claim payments and the related expenses that the insurer or reinsurer will ultimately be required to pay in respect of insurance or reinsurance it has written. Reserves are established losses, future benefits, claims, loss expenses and unearned premiums. With respect to mortgage insurance, a statutory contingency reserve is also required to be established by applicable law to protect against catastrophic losses.
Risk in force	The original principal amount of mortgage loans, multiplied by the coverage percentage under the mortgage insurance policies that remain in effect.
S&P	Standard & Poor's Ratings Group, a rating agency.

Separate accounts	Assets of our insurance companies allocated under certain policies and contracts that are segregated from the general account and other separate accounts. The policyholder or contractholder bears the risk of investments held in a separate account.
Statutory accounting principles (SAP)	Accounting practices prescribed or permitted by an insurer's domiciliary state insurance regulator for purposes of financial reporting to regulators.
Statutory reserves	Monetary amounts established by state insurance law that an insurer must have available to provide for future obligations with respect to all policies. Statutory reserves are liabilities on the balance sheet of financial statements prepared in conformity with statutory accounting practices.
Statutory surplus	The excess of admitted assets over statutory liabilities as shown on an insurer's statutory financial statements.
Structured settlements	Customized annuities used to provide to a claimant ongoing periodic payments instead of a lump-sum payment. Structured settlements provide an alternative to a lump-sum settlement generally in a personal injury lawsuit and typically are purchased by property and casualty insurance companies for the benefit of an injured claimant with benefits scheduled to be paid throughout a fixed period or for the life of the claimant.
Surrender charge	An amount specified in an insurance policy or annuity contract that is charged to a policyholder or contractholder for early cancellations of, or withdrawal under, that policy or contract.
Surrenders and withdrawals	Amounts taken from life insurance policies and annuity contracts representing the full or partial values of these policies or contracts.
Term life insurance	Life insurance written for a specified period and under which no cash value is generally available on surrender.
Traditional flow mortgage insurance	Primary mortgage insurance placed on individual loans at or shortly after loan origination. Coverage is generally limited to 50% or less of the original loan balance.
Underwriting	The process of examining, accepting or rejecting insurance risks and classifying those risks that are accepted, in order to charge policyholders an appropriate premium.
Unearned premiums	The portion of a premium, net of any amount ceded, that represents coverage that has not yet been provided or that will belong to the insurer based on the part of the policy period to elapse in the future.
Universal life insurance	Interest sensitive life insurance under which separately identified interest, and mortality and expense charges are made to the policy fund, typically with flexible premiums.
U.S. GAAP	Generally accepted accounting principles in the U.S.

Variable annuity	An annuity contract under which values during the accumulation phase fluctuate according to the investment performance of a separate account or accounts supporting such contract that are designated by the contractholder.
Variable life insurance	A life insurance policy under which the benefits payable to the beneficiary upon the death of the insured or the surrender of the policy will vary to reflect the investment performance of a separate account or accounts supporting such policy that are designated by the contractholder.
Whole life insurance	A life insurance policy for an insured's entire life that offers the beneficiary benefits in the event of the insured's death, provided premiums have been paid when due; it also allows for the buildup of cash value but has no investment feature.
Written premium	The premium entered on an insurer's books for a policy issued during a given period of time, whether coverage is provided only during that period of time or also during subsequent periods.

## Shares



**Genworth**  
Financial

*Built on GE Heritage*

### Class A Common Stock

### Prospectus

, 2004

## PART II

## INFORMATION NOT REQUIRED IN PROSPECTUS

## Item 13. Other Expenses of Issuance and Distribution

The expenses, other than underwriting commissions, expected to be incurred in connection with the issuance and distribution of the securities being registered under this Registration Statement are estimated to be as follows:

Securities and Exchange Commission Registration Fee	\$	40,450
National Association of Securities Dealers, Inc. Filing Fee	\$	30,500
New York Stock Exchange Listing Fee	\$	*
Printing and Engraving	\$	*
Legal Fees and Expenses	\$	*
Accounting Fees and Expenses	\$	*
Miscellaneous	\$	*
Total	\$	

\* To be completed by amendment

All offering expenses will be payable by the selling stockholder.

## Item 14. Indemnification of Directors and Officers

Section 145 of the Delaware General Corporation Law provides that a corporation may indemnify directors and officers, as well as other employees and individuals, against expenses (including attorneys' fees), judgments, fines and amounts paid in settlement actually and reasonably incurred by such person in connection with any threatened, pending or completed actions, suits or proceedings in which such person is made a party by reason of such person being or having been a director, officer, employee or agent of such corporation. The Delaware General Corporation Law provides that Section 145 is not excluding other rights to which those seeking indemnification may be entitled under any certificate of incorporation, bylaws, agreement, vote of stockholders or disinterested directors or otherwise.

Section 102(b)(7) of the Delaware General Corporation Law permits a corporation to provide in its certificate of incorporation that a director of the corporation shall not be personally liable to the corporation or its stockholders for monetary damages for breach of fiduciary duty as a director, except for liability (i) for any breach of the director's duty of loyalty to the corporation or its stockholders, (ii) for acts or omissions not in good faith or which involve intentional misconduct or a knowing violation of law, (iii) for unlawful payments of dividends or unlawful stock repurchases, redemptions or other distributions, or (iv) for any transactions from which the director derived an improper personal benefit.

The amended and restated certificate of incorporation of Genworth Financial, Inc. (the "Registrant") provides that the Registrant will indemnify its directors and officers to the fullest extent permitted by law and that no director shall be liable for monetary damages to the Registrant or its stockholders for any breach of fiduciary duty, except to the extent provided by applicable law.

The General Electric Company (the ultimate parent of the Registrant) maintains liability insurance for its directors and officers and for the directors and officers of its majority-owned subsidiaries, including the Registrant. This insurance provides for coverage against loss from claims made against directors and officers in their capacity as such, including, subject to certain exceptions, liabilities under the federal securities laws. Prior to the completion of this offering, the Registrant intends to obtain additional liability insurance for its directors and officers to reduce the deductible payable under the policy maintained by the General Electric Company.

## Item 15. Recent Sales of Unregistered Securities

The Registrant was incorporated on October 23, 2003 under the laws of the State of Delaware. In connection with its formation, the Registrant issued 1,000 shares of common stock for \$1,000 to GE Financial Assurance Holdings, Inc., an indirect subsidiary of the General Electric Company, pursuant to the exemption provided by Section 4(2) of the Securities Act of 1933.

II-1

## Item 16. Exhibits and Financial Statement Schedules

(a) Exhibits

Number	Description
1.1*	Form of Underwriting Agreement
3.1**	Amended and Restated Certificate of Incorporation of Genworth Financial, Inc.
3.2**	Amended and Restated Bylaws of Genworth Financial, Inc.
3.3***	Form of Certificate of Designations for Series A Cumulative Preferred Stock.
4.1*	Specimen Class A Common Stock certificate
4.2**	Indenture, dated as of June 26, 2001, between GE Financial Assurance Holdings, Inc. and The Chase Manhattan Bank, as Trustee.
4.3**	First Supplemental Indenture, dated as of June 26, 2001, among GE Financial Assurance Holdings, Inc., The Chase Manhattan Bank, as Trustee, Paying Agent and Exchange Rate Agent, and The Chase Manhattan Bank, Luxembourg, S.A., as Paying Agent
4.4***	Form of Second Supplemental Indenture among GE Financial Assurance Holdings, Inc., Genworth Financial, Inc. and JPMorgan Chase Bank (formerly known as The Chase Manhattan Bank.), as Trustee
4.5**	ISDA Master Agreement, dated as of March 2, 2000, between Morgan Stanley Derivative Products Inc. and GE Financial Assurance Holdings, Inc.
4.6**	Confirmation Letter, dated as of September 29, 2003, from Morgan Stanley Derivative Products Inc. to GE Financial Assurance Holdings, Inc.
4.7***	Form of Indenture between Genworth Financial, Inc. and The Bank of New York, as Trustee
4.8***	Form of Supplemental Indenture No. 1 between Genworth Financial, Inc. and The Bank of New York, as Trustee



- 4.9\*\*\* Form of Purchase Contract and Pledge Agreement between Genworth Financial, Inc. and The Bank of New York, as Purchase Contract Agent, Collateral Agent, Custodial Agent and Securities Intermediary
- 5.1\* Opinion of Weil, Gotshal & Manges LLP
- 10.1\*\*\* Form of Master Agreement among Genworth Financial, Inc., General Electric Company, General Electric Capital Corporation, GEI, Inc. and GE Financial Assurance Holdings, Inc.
- 10.2\*\* Form of Registration Rights Agreement between Genworth Financial, Inc. and GE Financial Assurance Holdings, Inc.
- 10.3\*\*\* Form of Transition Services Agreement among General Electric Company, General Electric Capital Corporation, GEI Inc., GE Financial Assurance Holdings, Inc., GNA Corporation, GE Asset Management Incorporated, General Electric Mortgage Holdings LLC and Genworth Financial, Inc.
- 10.4\*\*\* Form of Liability and Portfolio Management Agreement between Trinity Funding Company, LLC and Genworth Financial Asset Management, LLC
- 10.5\*\*\* Form of Liability and Portfolio Management Agreement among FGIC Capital Market Services, Inc., Genworth Financial Asset Management, LLC and General Electric Capital Corporation

II-2

- 
- 10.6\*\*† Form of Outsourcing Services Separation Agreement among Genworth Financial, Inc., General Electric Company, General Electric Capital Corporation and GE Capital International Services, Inc.
  - 10.7\*\*\* Form of Tax Matters Agreement by and among General Electric Company, General Electric Capital Corporation, GE Financial Assurance Holdings, Inc., GEI, Inc. and Genworth Financial, Inc.
  - 10.8\*\*\* Form of Employee Matters Agreement among Genworth Financial, Inc., General Electric Company, General Electric Capital Corporation, GEI, Inc. and GE Financial Assurance Holdings, Inc.
  - 10.9\*\*\* Form of Transitional Trademark License Agreement between GE Capital Registry, Inc. and Genworth Financial, Inc.
  - 10.10\*\*\* Form of Intellectual Property Cross-License between Genworth Financial, Inc. and General Electric Company
  - 10.11\*\*\* Coinsurance Agreement, dated as of April 15, 2004, by and between GE Life and Annuity Assurance Company and Union Fidelity Life Insurance Company
  - 10.12\*\*\* Coinsurance Agreement, dated as of April 15, 2004, by and between Federal Home Life Insurance Company and Union Fidelity Life Insurance Company
  - 10.13\*\*\* Coinsurance Agreement, dated as of April 15, 2004, by and between General Electric Capital Assurance Company and Union Fidelity Life Insurance Company
  - 10.14\*\*\* Coinsurance Agreement, dated as of April 15, 2004, by and between GE Capital Life Assurance Company of New York and Union Fidelity Life Insurance Company
  - 10.15\*\*\* Coinsurance Agreement, dated as of April 15, 2004, by and between American Mayflower Life Insurance Company of New York and Union Fidelity Life Insurance Company
  - 10.16\*\*\* Retrocession Agreement, dated as of April 15, 2004, by and between General Electric Capital Assurance Company and Union Fidelity Life Insurance Company
  - 10.17\*\*\* Retrocession Agreement, dated as of April 15, 2004 by and between GE Capital Life Assurance Company of New York and Union Fidelity Life Insurance Company
  - 10.18\*\*\* Reinsurance Agreement, dated as of April 15, 2004, by and between GE Life and Annuity Assurance Company and Union Fidelity Life Insurance Company
  - 10.19\*\*\* Reinsurance Agreement, dated as of April 15, 2004, by and between GE Capital Life Assurance Company of New York and Union Fidelity Life Insurance Company
  - 10.20\*\*\* Coinsurance Agreement, dated as of April 15, 2004, by and between Union Fidelity Life Insurance Company and Federal Home Life Insurance Company
  - 10.21\*\*\* Capital Maintenance Agreement, dated as of January 1, 2004, by and between Union Fidelity Life Insurance Company and General Electric Capital Corporation
  - 10.22\*\*\* Form of Reinsurance Agreement by and between Financial Insurance Company Limited and Viking Insurance Company, Limited
  - 10.23\*\*\* Form of Reinsurance Agreement by and between Financial Assurance Company Limited and Viking Insurance Company, Limited
  - 10.24\*\*\* Form of Reinsurance Agreement by and between Vie Plus S.A. and RD Plus S.A.
  - 10.25\*\*\* Form of Mortgage Services Agreement by and among GE Mortgage Services, LLC, General Electric Mortgage Holdings LLC, GE Mortgage Contract Services Inc. and Genworth Financial, Inc.

II-3

- 
- 10.26\*\*\*† Form of Framework Agreement between GEFA International Holdings, Inc. and GE Capital Corporation
  - 10.27\*\*\*† Form of Business Services Agreement between GNA Corporation and Union Fidelity Life Insurance Company
  - 10.28\*\*\* Derivatives Management Services Agreement, dated as of April 15, 2004, by and among Union Fidelity Life Insurance Company, GE Asset Management Incorporated and General Electric Capital Corporation
  - 10.29\*\* Form of Agreement Regarding Continued Reinsurance of Insurance Products by and between General Electric Capital Company and Viking Insurance Company Ltd.
  - 10.30\*\*\* Form of Transitional Services Agreement between Financial Insurance Group Services Limited and GE Life Services Limited
  - 10.31\*\*\*† Form of Amended and Restated Investment Management and Services Agreement between General Electric Capital Assurance Company and GE Asset Management Incorporated
  - 10.32\*\*\*† Form of Investment Management Agreement between Financial Assurance Company Limited and GE Asset Management Limited
  - 10.33\*\*\* Asset Management Services Agreement, dated as of January 1, 2004, by and among Genworth Financial, Inc., General Electric Financial Assurance Holdings, Inc. and GE Asset Management Incorporated
  - 10.34\*\*\*† Form of Amended and Restated Master Outsourcing Agreement by and between General Electric Capital Assurance Company and GE Capital International Services
  - 10.35\*† Form of Amended and Restated Master Outsourcing Agreement by and between First Colony Life Insurance Company and GE Capital International Services
  - 10.36\*† Form of Amended and Restated Master Outsourcing Agreement by and between GE Life and Annuity Assurance Company and GE Capital International Services
  - 10.37\*† Form of Amended and Restated Master Outsourcing Agreement by and between GEFA International Holdings, Inc. and GE Capital International Services
  - 10.38\* Form of 180-Day Bridge Credit Agreement among Genworth Financial, Inc., as borrower, and the Lenders Named therein
  - 10.39\* Form of 364-Day Credit Agreement among Genworth Financial, Inc., as borrower, the Lenders Named therein, and JPMorgan Chase Bank and Bank of America, N.A., as Co-Administrative Agents
  - 10.40\* Form of Five-Year Credit Agreement among Genworth Financial, Inc., as borrower, the Lenders Named therein, and JPMorgan Chase Bank and Bank of America, N.A., as Co-Administrative Agents

- 10.41\*\*\* Form of Scheme for the Transfer to Financial New Life Company Limited of the Insurance Business of Financial Assurance Company Limited (pursuant to Part VII of the Financial Services and Markets Act 2000)
- 10.42\*\*\* Form of Agreement for the Sale and Purchase of shares in Financial Assurance Company Limited between GE Insurance Holdings Limited as seller and GEFA UK Holdings Limited as buyer
- 10.43\*\*\* Form of Agreement on Transfer of a Portfolio of Insurance Contracts between Vie Plus and Financial New Life Company Limited

II-4

- 10.44\*\*\* Form of Business Transfer Agreement between Vie Plus S.A. and Financial New Life Company Limited
- 10.45\*\*\* Form of Administrative Services Agreement by and between GE Group Life Assurance Company and Union Fidelity Life Insurance Company
- 10.46\*\*\* Form of Subordinated Contingent Promissory Note between Genworth Financial, Inc. and GE Financial Assurance Holdings, Inc.
- 10.47\*\*\* Canadian Tax Matters Agreement among General Electric Company, General Electric Capital Corporation, GECMIC Holdings Inc., GE Capital Mortgage Insurance Company (Canada) and Genworth Financial, Inc.
- 10.48\*\*\* Trust Agreement, dated as of April 15, 2004, among Union Fidelity Life Insurance Company, General Electric Capital Assurance Company and The Bank of New York
- 10.49\*\*\* Trust Agreement, dated as of April 15, 2004, among Union Fidelity Insurance Company, American Mayflower Life Insurance Company of New York and The Bank of New York
- 10.50\*\*\* Trust Agreement, dated as of April 15, 2004, among Union Fidelity Life Insurance Company, GE Life and Annuity Assurance Company and The Bank of New York
- 10.51\*\*\* Trust Agreement, dated as of April 15, 2004, among Union Fidelity Life Insurance Company, Federal Home Life Insurance Company and The Bank of New York
- 10.52\*\*\* Trust Agreement, dated as of April 15, 2004, among Union Fidelity Life Insurance Company, GE Capital Life Assurance Company of New York and The Bank of New York
- 10.53\*\*\* Trust Agreement, dated as of April 15, 2004, among Union Fidelity Life Insurance Company, First Colony Life Insurance Company and The Bank of New York
- 10.54\*\*\* Coinsurance Agreement, dated as of April 15, 2004, between First Colony Life Insurance Company and Union Fidelity Life Insurance Company
- 10.55\*\*\* Form of Liability and Portfolio Management Agreement between Trinity Plus Funding Company, LLC and Genworth Financial Asset Management, LLC
- 10.56\* Form of 2004 Genworth Financial, Inc. Omnibus Incentive Plan
- 12.1\*\*\* Statement of Ratio of Earnings to Fixed Charges
- 21.1\*\* Subsidiaries of the registrant
- 23.1\*\*\* Consent of KPMG LLP
- 23.2\* Consent of Weil, Gotshal & Manges LLP (included in Exhibit 5.1)
- 24.1\*\* Powers of Attorney

\* To be filed by amendment.

\*\* Previously filed.

\*\*\* Filed herewith

† The registrant has applied for Confidential Treatment with respect to portions of this Exhibit. An unredacted version of this Exhibit has been filed separately with the Securities and Exchange Commission.

(b) Financial Statement Schedule

Number	Description
Schedule III	Supplementary Insurance Information

II-5

### Item 17. Undertakings

The undersigned hereby undertakes as follows:

(a) To provide to the underwriters at the closing specified in the underwriting agreement certificates in such denominations and registered in such names as required by the underwriters to permit prompt delivery to each purchaser.

(b) Insofar as indemnification for liabilities arising under the Securities Act of 1933 may be permitted to directors, officers and controlling persons of the registrant pursuant to the foregoing provisions, or otherwise, the registrant has been advised that in the opinion of the Securities and Exchange Commission such indemnification is against public policy as expressed in the Act and is, therefore, unenforceable. In the event that a claim for indemnification against such liabilities (other than the payment by the registrant of expenses incurred or paid by a director, officer or controlling person of the registrant in the successful defense of any action, suit or proceeding) is asserted by such director, officer or controlling person in connection with the securities being registered, the registrant will, unless in the opinion of its counsel the matter has been settled by controlling precedent, submit to a court of appropriate jurisdiction the question whether such indemnification by it is against public policy as expressed in the Act and will be governed by the final adjudication of such issue.

(c) (1) For purposes of determining any liability under the Securities Act of 1933, the information omitted from the form of prospectus filed as part of this registration statement in reliance upon Rule 430A and contained in a form of prospectus filed by the registrant pursuant to Rule 424(b)(1) or (4) or 497(h) under the Securities Act of 1933 shall be deemed to be part of this Registration Statement as of the time it was declared effective.

(2) For the purpose of determining any liability under the Securities Act of 1933, each post-effective amendment that contains a form of prospectus shall be deemed to be a new registration statement relating to the securities offered therein, and the offering of such securities at that time shall be deemed to be the initial bona fide offering thereof.

**SIGNATURES**

Pursuant to the requirements of the Securities Act of 1933, the Registrant has duly caused this Amendment No. 3 to the Registration Statement to be signed on its behalf by the undersigned, thereunto duly authorized, in Richmond, Virginia, on this 19th day of April, 2004.

GENWORTH FINANCIAL, INC.

By: /s/ RICHARD P. MCKENNEY

Name: Richard P. McKenney  
Title: Senior Vice President—  
Chief Financial Officer

Pursuant to the requirements of the Securities Act of 1933 this Amendment No. 3 to the Registration Statement has been signed by the following persons in the capacities indicated on the 19th day of April, 2004.

Signature	Title
*	
Michael D. Fraizer	Chairman of the Board of Directors, President and Chief Executive Officer (Principal Executive Officer)
/s/ RICHARD P. MCKENNEY	Senior Vice President—Chief Financial Officer (Principal Financial Officer)
Richard P. McKenney	
*	Vice President and Controller (Principal Accounting Officer)
Jamie S. Miller	
*	
Elizabeth J. Comstock	Director
*	
Pamela Daley	Director
*	
Dennis D. Dammerman	Director
*	
David R. Nissen	Director
*	
James A. Parke	Director

\*By: /s/ RICHARD P. MCKENNEY

Richard P. McKenney  
*Attorney-in-fact*

WHEN THE TRANSACTIONS REFERRED TO IN NOTE 1 TO THE AUDITED COMBINED FINANCIAL STATEMENTS ON PAGE F-7 HAVE BEEN CONSUMMATED, WE WILL BE IN A POSITION TO RENDER THE FOLLOWING REPORT.

/s/ KPMG LLP

**Independent Auditors' Report**

The Board of Directors  
Genworth Financial, Inc.:

Under date of February 6, 2004, except as to note 1 which is as of \_\_\_\_\_, 2004, we reported on the combined statement of financial position of Genworth Financial, Inc. (the "Company") as of December 31, 2003 and 2002, and the related combined statements of earnings, stockholder's interest, and cash flows for each of the years in the three-year period ended December 31, 2003, which are included in the prospectus. In connection with our audits of the aforementioned combined financial statements, we also audited the related combined financial statement schedule in the registration statement. The financial statement schedule is the responsibility of the Company's management. Our responsibility is to express an opinion on the financial statement schedule based on our audits.

In our opinion, such financial statement schedule, when considered in relation to the basic combined financial statements taken as a whole, presents fairly, in all material respects, the information set forth therein.

As discussed in note 2 to the combined financial statements, the Company changed its method of accounting for variable interest entities in 2003, its method of accounting for goodwill and other intangible assets in 2002, and its method of accounting for derivative instruments and hedging activities in 2001.

Richmond, Virginia  
February 6, 2004, except as to  
note 1 of the combined financial statements,  
which is as of \_\_\_\_\_, 2004

S-1

Schedule III

**Genworth Financial, Inc.**  
Supplemental Insurance Information  
(Dollar amounts in millions)

Segment	Deferred Acquisition Costs	Future Annuity and Contract Benefits & Liability for Policy and Contract Claims	Unearned Premiums	Other Policyholder Liabilities	Premium Revenue
<b>December 31, 2003</b>					
Protection	\$ 4,155	\$ 17,871	\$ 2,314	\$ 63	\$ 4,588
Retirement Income and Investments	1,249	43,744	—	351	1,045
Mortgage Insurance	89	340	1,216	44	716
Affinity	198	493	19	7	244
Corporate and Other	97	16	67	—	110
<b>Total</b>	<b>\$ 5,788</b>	<b>\$ 62,464</b>	<b>\$ 3,616</b>	<b>\$ 465</b>	<b>\$ 6,703</b>
<b>December 31, 2002</b>					
Protection	\$ 3,677	\$ 16,274	\$ 2,203	\$ 31	\$ 4,088
Retirement Income and Investments	1,373	42,473	—	561	991
Mortgage Insurance	68	345	732	40	677
Affinity	208	450	34	5	247
Corporate and Other	6	10	38	(1)	104
<b>Total</b>	<b>\$ 5,332</b>	<b>\$ 59,552</b>	<b>\$ 3,007</b>	<b>\$ 636</b>	<b>\$ 6,107</b>
<b>December 31, 2001</b>					
Protection					\$ 3,915
Retirement Income and Investments					1,023
Mortgage Insurance					698
Affinity					286
Corporate and Other					90
<b>Total</b>					<b>\$ 6,012</b>
Segment	Net Investment Income	Interest Credited & Benefits and Other Changes in Policy Reserves	Amortization of Deferred Acquisition Costs	Other Operating Expenses	Premiums Written
<b>December 31, 2003</b>					
Protection	\$ 1,199	\$ 3,362	\$ 889	\$ 1,144	\$ 4,454
Retirement Income and Investments	2,511	3,130	166	256	1,046
Mortgage Insurance	218	115	33	303	950
Affinity	62	196	89	260	236
Corporate and Other	25	53	5	288	124
<b>Total</b>	<b>\$ 4,015</b>	<b>\$ 6,856</b>	<b>\$ 1,182</b>	<b>\$ 2,251</b>	<b>\$ 6,810</b>
<b>December 31, 2002</b>					
Protection	\$ 1,136	\$ 2,992	\$ 769	\$ 1,007	\$ 4,397
Retirement Income and Investments	2,522	3,052	168	263	989
Mortgage Insurance	231	46	37	235	840
Affinity	70	180	84	344	226

Corporate and Other	20	15	2	244	40
Total	\$ 3,979	\$ 6,285	\$ 1,060	\$ 2,093	\$ 6,492
December 31, 2001					
Protection	\$ 1,119	\$ 2,722	\$ 682	\$ 1,200	\$ 4,073
Retirement Income and Investments	2,482	3,014	121	247	1,023
Mortgage Insurance	227	150	45	186	797
Affinity	74	188	82	394	248
Corporate and Other	(7)	20	3	226	46
Total	\$ 3,895	\$ 6,094	\$ 933	\$ 2,253	\$ 6,187

S-2

## INDEX TO EXHIBITS

Number	Description
1.1*	Form of Underwriting Agreement
3.1**	Amended and Restated Certificate of Incorporation of Genworth Financial, Inc.
3.2**	Amended and Restated Bylaws of Genworth Financial, Inc.
3.3***	Form of Certificate of Designations for Series A Cumulative Preferred Stock.
4.1*	Specimen Class A Common Stock certificate
4.2**	Indenture, dated as of June 26, 2001, between GE Financial Assurance Holdings, Inc. and The Chase Manhattan Bank, as Trustee.
4.3**	First Supplemental Indenture, dated as of June 26, 2001, among GE Financial Assurance Holdings, Inc., The Chase Manhattan Bank, as Trustee, Paying Agent and Exchange Rate Agent, and The Chase Manhattan Bank, Luxembourg, S.A., as Paying Agent
4.4***	Form of Second Supplemental Indenture among GE Financial Assurance Holdings, Inc., Genworth Financial, Inc. and JPMorgan Chase Bank (formerly known as The Chase Manhattan Bank.), as Trustee
4.5**	ISDA Master Agreement, dated as of March 2, 2000, between Morgan Stanley Derivative Products Inc. and GE Financial Assurance Holdings, Inc.
4.6**	Confirmation Letter, dated as of September 29, 2003, from Morgan Stanley Derivative Products Inc. to GE Financial Assurance Holdings, Inc.
4.7***	Form of Indenture between Genworth Financial, Inc. and The Bank of New York, as Trustee
4.8***	Form of Supplemental Indenture No. 1 between Genworth Financial, Inc. and The Bank of New York, as Trustee
4.9***	Form of Purchase Contract and Pledge Agreement between Genworth Financial, Inc. and The Bank of New York, as Purchase Contract Agent, Collateral Agent, Custodial Agent and Securities Intermediary
5.1*	Opinion of Weil, Gotshal & Manges LLP
10.1***	Form of Master Agreement among Genworth Financial, Inc., General Electric Company, General Electric Capital Corporation, GEI, Inc. and GE Financial Assurance Holdings, Inc.
10.2**	Form of Registration Rights Agreement between Genworth Financial, Inc. and GE Financial Assurance Holdings, Inc.
10.3***	Form of Transition Services Agreement among General Electric Company, General Electric Capital Corporation, GEI Inc., GE Financial Assurance Holdings, Inc., GNA Corporation, GE Asset Management Incorporated, General Electric Mortgage Holdings LLC and Genworth Financial, Inc.
10.4***	Form of Liability and Portfolio Management Agreement between Trinity Funding Company, LLC and Genworth Financial Asset Management, LLC
10.5***	Form of Liability and Portfolio Management Agreement among FGIC Capital Market Services, Inc., Genworth Financial Asset Management, LLC and General Electric Capital Corporation
10.6**†	Form of Outsourcing Services Separation Agreement among Genworth Financial, Inc., General Electric Company, General Electric Capital Corporation and GE Capital International Services, Inc.
10.7***	Form of Tax Matters Agreement by and among General Electric Company, General Electric Capital Corporation, GE Financial Assurance Holdings, Inc., GEI, Inc. and Genworth Financial, Inc.
10.8***	Form of Employee Matters Agreement among Genworth Financial, Inc., General Electric Company, General Electric Capital Corporation, GEI, Inc. and GE Financial Assurance Holdings, Inc.
10.9***	Form of Transitional Trademark License Agreement between GE Capital Registry, Inc. and Genworth Financial, Inc.
10.10***	Form of Intellectual Property Cross-License between Genworth Financial, Inc. and General Electric Company
10.11***	Coinsurance Agreement, dated as of April 15, 2004, by and between GE Life and Annuity Assurance Company and Union Fidelity Life Insurance Company
10.12***	Coinsurance Agreement, dated as of April 15, 2004, by and between Federal Home Life Insurance Company and Union Fidelity Life Insurance Company
10.13***	Coinsurance Agreement, dated as of April 15, 2004, by and between General Electric Capital Assurance Company and Union Fidelity Life Insurance Company
10.14***	Coinsurance Agreement, dated as of April 15, 2004, by and between GE Capital Life Assurance Company of New York and Union Fidelity Life Insurance Company
10.15***	Coinsurance Agreement, dated as of April 15, 2004, by and between American Mayflower Life Insurance Company of New York and Union Fidelity Life Insurance Company
10.16***	Retrocession Agreement, dated as of April 15, 2004, by and between General Electric Capital Assurance Company and Union Fidelity Life Insurance Company
10.17***	Retrocession Agreement, dated as of April 15, 2004 by and between GE Capital Life Assurance Company of New York and Union Fidelity Life Insurance Company
10.18***	Reinsurance Agreement, dated as of April 15, 2004, by and between GE Life and Annuity Assurance Company and Union Fidelity Life Insurance Company
10.19***	Reinsurance Agreement, dated as of April 15, 2004, by and between GE Capital Life Assurance Company of New York and Union Fidelity Life Insurance Company
10.20***	Coinsurance Agreement, dated as of April 15, 2004, by and between Union Fidelity Life Insurance Company and Federal Home Life Insurance Company
10.21***	Capital Maintenance Agreement, dated as of January 1, 2004, by and between Union Fidelity Life Insurance Company and General Electric Capital Corporation
10.22***	Form of Reinsurance Agreement by and between Financial Insurance Company Limited and Viking Insurance Company, Limited

10.23***	Form of Reinsurance Agreement by and between Financial Assurance Company Limited and Viking Insurance Company, Limited
10.24***	Form of Reinsurance Agreement by and between Vie Plus S.A. and RD Plus S.A.
10.25***	Form of Mortgage Services Agreement by and among GE Mortgage Services, LLC, General Electric Mortgage Holdings LLC, GE Mortgage Contract Services Inc. and Genworth Financial, Inc.
10.26***†	Form of Framework Agreement between GEFA International Holdings, Inc. and GE Capital Corporation
10.27***†	Form of Business Services Agreement between GNA Corporation and Union Fidelity Life Insurance Company

---

10.28***	Derivatives Management Services Agreement, dated as of April 15, 2004, by and among Union Fidelity Life Insurance Company, GE Asset Management Incorporated and General Electric Capital Corporation
10.29**	Form of Agreement Regarding Continued Reinsurance of Insurance Products by and between General Electric Capital Company and Viking Insurance Company Ltd.
10.30***	Form of Transitional Services Agreement between Financial Insurance Group Services Limited and GE Life Services Limited
10.31***†	Form of Amended and Restated Investment Management and Services Agreement between General Electric Capital Assurance Company and GE Asset Management Incorporated
10.32***†	Form of Investment Management Agreement between Financial Assurance Company Limited and GE Asset Management Limited
10.33***	Asset Management Services Agreement, dated as of January 1, 2004, by and among Genworth Financial, Inc., General Electric Financial Assurance Holdings, Inc. and GE Asset Management Incorporated
10.34***†	Form of Amended and Restated Master Outsourcing Agreement by and between General Electric Capital Assurance Company and GE Capital International Services
10.35†	Form of Amended and Restated Master Outsourcing Agreement by and between First Colony Life Insurance Company and GE Capital International Services
10.36†	Form of Amended and Restated Master Outsourcing Agreement by and between GE Life and Annuity Assurance Company and GE Capital International Services
10.37†	Form of Amended and Restated Master Outsourcing Agreement by and between GEFA International Holdings, Inc. and GE Capital International Services
10.38*	Form of 180-Day Bridge Credit Agreement among Genworth Financial, Inc., as borrower, and the Lenders Named therein
10.39*	Form of 364-Day Credit Agreement among Genworth Financial, Inc., as borrower, the Lenders Named therein, and JPMorgan Chase Bank and Bank of America, N.A., as Co-Administrative Agents
10.40*	Form of Five-Year Credit Agreement among Genworth Financial, Inc., as borrower, the Lenders Named therein, and JPMorgan Chase Bank and Bank of America, N.A., as Co-Administrative Agents
10.41***	Form of Scheme for the Transfer to Financial New Life Company Limited of the Insurance Business of Financial Assurance Company Limited (pursuant to Part VII of the Financial Services and Markets Act 2000)
10.42***	Form of Agreement for the Sale and Purchase of shares in Financial Assurance Company Limited between GE Insurance Holdings Limited as seller and GEFA UK Holdings Limited as buyer
10.43***	Form of Agreement on Transfer of a Portfolio of Insurance Contracts between Vie Plus and Financial New Life Company Limited
10.44***	Form of Business Transfer Agreement between Vie Plus S.A. and Financial New Life Company Limited
10.45***	Form of Administrative Services Agreement by and between GE Group Life Assurance Company and Union Fidelity Life Insurance Company
10.46***	Form of Subordinated Contingent Promissory Note between Genworth Financial, Inc. and GE Financial Assurance Holdings, Inc.

---

10.47***	Canadian Tax Matters Agreement among General Electric Company, General Electric Capital Corporation, GECMIC Holdings Inc., GE Capital Mortgage Insurance Company (Canada) and Genworth Financial, Inc.
10.48***	Trust Agreement, dated as of April 15, 2004, among Union Fidelity Life Insurance Company, General Electric Capital Assurance Company and The Bank of New York
10.49***	Trust Agreement, dated as of April 15, 2004, among Union Fidelity Insurance Company, American Mayflower Life Insurance Company of New York and The Bank of New York
10.50***	Trust Agreement, dated as of April 15, 2004, among Union Fidelity Life Insurance Company, GE Life and Annuity Assurance Company and The Bank of New York
10.51***	Trust Agreement, dated as of April 15, 2004, among Federal Home Life Insurance Company and The Bank of New York
10.52***	Trust Agreement, dated as of April 15, 2004, among Union Fidelity Life Insurance Company, GE Capital Life Assurance Company of New York and The Bank of New York
10.53***	Trust Agreement, dated as of April 15, 2004, among Union Fidelity Life Insurance Company, First Colony Life Insurance Company and The Bank of New York
10.54***	Coinsurance Agreement, dated as of April 15, 2004, between First Colony Life Insurance Company and Union Fidelity Life Insurance Company
10.55***	Form of Liability and Portfolio Management Agreement between Trinity Plus Funding Company, LLC and Genworth Financial Asset Management, LLC
10.56*	Form of 2004 Genworth Financial, Inc. Omnibus Incentive Plan
12.1***	Statement of Ratio of Earnings to Fixed Charges
21.1**	Subsidiaries of the registrant
23.1***	Consent of KPMG LLP
23.2*	Consent of Weil, Gotshal & Manges LLP (included in Exhibit 5.1)
24.1**	Powers of Attorney

\* To be filed by amendment.

\*\* Previously filed.

\*\*\* Filed herewith

† The registrant has applied for Confidential Treatment with respect to portions of this Exhibit. An unredacted version of this Exhibit has been filed separately with the Securities and Exchange Commission.

## QuickLinks

[TABLE OF CONTENTS](#)

[Prospectus Summary](#)

[The Offering](#)

[Summary Historical and Pro Forma Financial Information](#)

[Risk Factors](#)  
[Forward-Looking Statements](#)  
[Use of Proceeds](#)  
[Dividend Policy](#)  
[Capitalization](#)  
[Selected Historical and Pro Forma Financial Information](#)  
[Pro Forma Financial Information](#)  
[Pro Forma Financial Information](#)  
[Management's Discussion and Analysis of Financial Condition and Results of Operations](#)  
[Corporate Reorganization](#)  
[Business](#)  
[Regulation](#)  
[Management](#)  
[Arrangements Between GE and Our Company](#)  
[Ownership of Common Stock](#)  
[Description of Capital Stock](#)  
[Description of Equity Units](#)  
[Description of Certain Indebtedness](#)  
[Shares Eligible for Future Sale](#)  
[Certain United States Federal Tax Consequences for Non-U.S. Holders of Common Stock](#)  
[Underwriters](#)  
[Legal Matters](#)  
[Experts](#)  
[Additional Information](#)  
[Index to Financial Statements](#)  
[Independent Auditors' Report](#)  
[Genworth Financial, Inc. Combined Statement of Earnings](#)  
[Genworth Financial, Inc. Combined Statement of Financial Position](#)  
[Genworth Financial, Inc. Combined Statement of Stockholder's Interest](#)  
[Genworth Financial, Inc. Combined Statement of Cash Flows](#)  
[Genworth Financial, Inc. Notes to Combined Financial Statements Years Ended December 31, 2003, 2002 and 2001](#)  
[Independent Auditors' Report](#)  
[Genworth Financial, Inc. Statement of Financial Position](#)  
[Note to Statement of Financial Position](#)  
[Glossary of Selected Insurance Terms](#)  
[PART II INFORMATION NOT REQUIRED IN PROSPECTUS](#)  
[SIGNATURES](#)  
[Independent Auditors' Report](#)  
[Genworth](#)  
[INDEX TO EXHIBITS](#)

**CERTIFICATE OF DESIGNATIONS, POWERS, PREFERENCES  
AND RIGHTS OF % SERIES A CUMULATIVE PREFERRED STOCK**

of

**GENWORTH FINANCIAL, INC.**

Pursuant to Section 151 of the General Corporation Law  
of the State of Delaware

The undersigned, Leon E. Roday, Senior Vice President, General Counsel and Secretary of Genworth Financial, Inc., a Delaware corporation (hereinafter called the “**Corporation**”), pursuant to the provisions of Sections 103 and 151 of the General Corporation Law of the State of Delaware, hereby makes this Certificate of Designations, Powers, Preferences and Rights and hereby states and certifies that pursuant to the authority expressly vested in the Board of Directors of the Corporation by its Certificate of Incorporation, the Board of Directors duly adopted the following resolutions:

RESOLVED, that, pursuant to Article IV of the Corporation’s Amended and Restated Certificate of Incorporation (which authorizes shares of preferred stock, par value \$.001 per share (“**Preferred Stock**”), the Board of Directors hereby, creates a series of Preferred Stock designated % Series A Cumulative Preferred Stock (“**Series A Preferred Stock**”) and fixes the powers, designations, preferences and relative, participating, optional and other special rights, and the qualifications, limitations and restrictions, of such series of Preferred Stock as follows:

RESOLVED, that each share of such series of Preferred Stock shall rank equally in all respects and shall be subject to the following provisions:

1. *Number and Designation.* 2,000,000 shares of the Preferred Stock of the Corporation shall be designated as “ % Series A Cumulative Preferred Stock”.

2. *Rank.* The Series A Preferred Stock shall, with respect to dividend rights and amounts payable upon liquidation, dissolution and winding-up, rank prior to all other classes or series of common stock of the Corporation, including the Corporation’s Class A Common Stock, par value \$.001 per share, and Class B Common Stock, par value \$.001 per share (collectively, “**Common Stock**”). All capital stock of the Corporation to which the Series A Preferred Stock ranks prior (whether with respect to dividends or amounts payable upon liquidation, dissolution, winding-up or otherwise), including the Common Stock, are collectively the “**Junior Securities**.” All capital stock of the Corporation with which the Series A Preferred Stock ranks on a parity (whether with respect to

---

dividends or amounts payable upon liquidation, dissolution, winding-up or otherwise) are collectively the “**Parity Securities**.” The respective definitions of Junior Securities and Parity Securities shall also include any future class or series of capital stock of the Corporation including any Junior Securities and Parity Securities, as the case may be, issued upon conversion of warrants, rights, calls or options. The Series A Preferred Stock shall be subject to the creation of Junior Securities and Parity Securities.

3. *Dividends.* (a) Holders of Series A Preferred Stock shall be entitled to receive with respect to each share of Series A Preferred Stock, when, as and if declared by the Board of Directors, out of funds legally available for the payment of dividends, cash dividends in an amount equal to % per annum of the sum of (i) \$50 per share of Series A Preferred Stock (the “**Liquidation Preference**”) plus (ii) the amount of any Accumulated Dividends (as defined below) accrued with respect to such share. Such dividends shall be payable in arrears quarterly on , , and of each year (unless such day is not a business day, in which event on the next succeeding business day unless the next succeeding business day falls in the next calendar year in which case the payment will be made on the preceding business day) (each of such dates being a “**Dividend Payment Date**” and each such quarterly period being a “**Dividend Period**”). Such dividends shall be cumulative from the date of issue, whether or not funds of the Corporation are legally available for the payment of such dividends. Each such dividend shall be payable to the holders of record of shares of the Series A Preferred Stock, as they appear on the Corporation’s stock register at the close of business on the applicable record dates, which record dates shall be not more than 60 days or less than 10 days prior to the respective Dividend Payment Date, as shall be fixed by the Board of Directors. Any dividend payment made on shares of Series A Preferred Stock will first be credited against the Accumulated Dividends with respect to the earliest Dividend Period for the shares of Series A Preferred Stock for which dividends have not been paid in full. Accumulated Dividends for any Dividend Period, which have not been paid on the regular Dividend Payment Date, may be declared and paid at any time, without reference to any Dividend Payment Date, to holders of record of the Series A Preferred Stock on such date as may be fixed by the Board of Directors.

(b) The amount of dividends payable for each full Dividend Period for the Series A Preferred Stock shall be computed by dividing the annual dividend rate by four. The amount of dividends payable for the initial Dividend Period, or any other period shorter or longer than a full Dividend Period, on the Series A Preferred Stock shall be computed on the basis of 30-day months and a 12-month year. Holders of Series A Preferred Stock shall not be entitled to any dividends, whether payable in cash, property or stock, in excess of Accumulated Dividends, as herein provided, on the Series A Preferred Stock.

(c) Subject to the following sentence, so long as any shares of the Series A Preferred Stock are outstanding, the Corporation shall not

2

---

declare, pay or set apart for payment any dividends or distributions on Parity Securities for any period, or redeem or otherwise acquire any Parity Securities unless full cumulative dividends have been or contemporaneously are declared and paid or declared and a sum sufficient for the payment thereof set apart for such payment on the Series A Preferred Stock for all Dividend Periods terminating on or before the date of the payment of such Parity Securities. If dividends are not paid in full or a sum sufficient for such payment is not set apart, all dividends declared upon shares of the Series A Preferred Stock and all dividends declared upon any other Parity Securities shall be declared ratably in proportion to the respective amounts of dividends accumulated and unpaid on the Series A Preferred Stock and accumulated and unpaid on such Parity Securities.

(d) So long as any shares of the Series A Preferred Stock are outstanding, the Corporation shall not, and shall cause its subsidiaries not to, directly or indirectly, declare, pay or set apart for payment any dividends or other distributions on Junior Securities (other than dividends or distributions paid in shares of, or options, warrants or rights to subscribe for or purchase shares of, Junior Securities) or redeem or otherwise acquire any Junior Securities (all such dividends, distributions, redemptions or acquisitions being a “**Junior Securities Distribution**”) for any consideration (including any moneys to be paid to or made available for a sinking fund for the redemption of any shares of any such stock), except by conversion into or exchange for Junior Securities, unless in each case the full cumulative dividends on all outstanding shares of the Series A Preferred Stock and any other Parity Securities have been paid or set apart for payment for all past and current Dividend Periods with respect to the Series A Preferred Stock and all past and current dividend periods with respect to such Parity Securities.

4. *Liquidation Preference.* (a) In the event of any liquidation, dissolution or winding-up of the Corporation, whether voluntary or involuntary, before any payment or distribution of the Corporation’s assets (whether capital or surplus) shall be made to or set apart for the holders of Junior Securities, holders of Series A Preferred Stock shall be entitled to receive in cash the sum of (i) the Liquidation Preference, (ii) any Accumulated Dividends accrued with respect to such share and (iii) any dividends accrued during the current Dividend Period to, but not including, the date of final distribution with respect to such share; *provided* that the Liquidation Preference shall be subject to equitable adjustment if and whenever there shall occur a stock split, combination or reclassification of, or other similar event affecting, the Series A Preferred Stock.



If, upon any liquidation, dissolution or winding-up of the Corporation, the Corporation's assets, or proceeds thereof, distributable among the holders of Series A Preferred Stock are insufficient to pay in full the preferential amount aforesaid and liquidating payments on any Parity Securities, then such assets, or the proceeds thereof, shall be distributed among the holders of Series A Preferred Stock and

3

---

any other Parity Securities ratably in accordance with the respective amounts that would be payable on such shares of Series A Preferred Stock and any such other Parity Securities if all amounts payable thereon were paid in full. Notwithstanding anything else in the Corporation's Amended and Restated Certificate of Incorporation, neither the sale, lease or exchange (for cash, stock, securities or other consideration) of all or substantially all of the property and assets of the Corporation, nor the merger or consolidation of the Corporation with or into any other corporation or entity nor the merger or consolidation of any other corporation or entity with or into the Corporation, shall be deemed to be a voluntary or involuntary liquidation, dissolution or winding up of the Corporation for purposes of the foregoing.

(b) After payment of the full amount of the liquidating distributions to which they are entitled, the holder or holders of the Series A Preferred Stock will have no further right or claim to any of the Corporation's remaining assets. Subject to the rights of the holders of any Parity Securities, after payment has been made in full to the holders of the Series A Preferred Stock, as provided in this Section 4, holders of Junior Securities (and Parity Securities, if the terms so provide) shall, subject to the respective terms and provisions (if any) applying thereto, be entitled to receive any and all assets remaining to be paid or distributed, and the holder or holders of Series A Preferred Stock shall not be entitled to share therein.

5. *Redemption.* (a) The Series A Preferred Stock shall not be redeemable by the Corporation before \_\_\_\_\_, 2011. On \_\_\_\_\_, 2011, the Corporation shall redeem all outstanding shares of the Series A Preferred Stock, at a redemption price of \$50 per share, plus an amount equal to Accumulated Dividends thereon to the redemption date, in cash.

(b) Shares of Series A Preferred Stock that have been issued and reacquired in any manner, including shares purchased, shall (upon compliance with any applicable provisions of the laws of the State of Delaware) have the status of authorized and unissued shares of the class of Preferred Stock undesignated as to series and may be redesignated and reissued as part of any series of the Preferred Stock; *provided* that no such issued and reacquired shares of Series A Preferred Stock shall be reissued or sold as Series A Preferred Stock.

(c) If and so long as the Corporation fails to redeem for any reason all outstanding shares of Series A Preferred Stock pursuant to Section 5(a), the Corporation shall not, and shall cause its subsidiaries not to, directly or indirectly, (i) redeem or otherwise acquire any Parity Securities or discharge any mandatory or optional redemption, sinking fund or other similar obligation in respect of any Parity Securities (except in connection with a redemption, sinking fund or other similar obligation in which shares of Series A Preferred Stock receive a pro rata share) or (ii)

4

---

in accordance with Section 3(d), declare or make any distribution of Junior Securities, or redeem or otherwise acquire any Junior Securities, or discharge any mandatory or optional redemption, sinking fund or other similar obligation in respect of the Junior Securities.

(d) Notwithstanding the foregoing provisions of this Section 5, unless full cumulative cash dividends (whether or not declared) on all outstanding shares of Series A Preferred Stock have been paid or contemporaneously are declared and paid or set apart for payment for all dividend periods terminating on or before the applicable redemption date, none of the shares of Series A Preferred Stock shall be redeemed, and no sum shall be set aside for such redemption, unless shares of Series A Preferred Stock are redeemed pro rata.

6. *Procedure for Redemption.* (a) Notice of redemption of shares of Series A Preferred Stock shall be given by first class mail, postage prepaid, mailed not less than 30 days nor more than 60 days before the mandatory redemption date of \_\_\_\_\_, 2011, to each holder of record of the shares to be redeemed at such holder's address as the same appears on the Corporation's stock register; *provided* that neither the failure to give such notice nor any defect therein shall affect the validity of the giving of such notice except as to the holder to whom the Corporation has failed to give said notice or whose notice was defective. Each such notice shall state: (i) the redemption date; (ii) the redemption price; (iii) the place or places where certificates for such shares are to be surrendered for payment of the redemption price; and (iv) that dividends on the shares to be redeemed will cease to accrue on such redemption date.

(b) Notice having been mailed as aforesaid, from and after the redemption date (unless the Corporation defaults in providing money for the payment of the redemption price of the shares called for redemption), dividends on the shares of Series A Preferred Stock so called for redemption shall cease to accrue, and all rights of the holders thereof as stockholders of the Corporation (except the right to receive from the Corporation the redemption price) shall cease. Upon surrender in accordance with said notice of the certificates for any shares so redeemed (properly endorsed or assigned for transfer, if the Board of Directors of the Corporation shall so require and the notice shall so state), such shares shall be redeemed by the Corporation at the redemption price aforesaid.

7. *Additional Dividends in Respect of Certain Legislation Affecting the DRD.* (a) If, prior to eighteen (18) months after the date of issuance of the shares of Series A Preferred Stock, one or more amendments to the Internal Revenue Code of 1986, as amended (the "Code") are enacted that reduce the dividends received deduction (the "DRD") percentage (as of the initial date of issuance, 70%), as specified in Section 243(a)(1) of the Code or any successor provision (the "Dividends Received Percentage" or the "DRP"), the Corporation shall make certain additional dividend payments in respect of the dividends on the

5

---

Series A Preferred Stock (as set forth herein), except that no adjustments will be made with respect to any reduction of the DRP below 50%.

(b) With respect to each dividend declared and payable per share of Series A Preferred Stock for dividend payments to which such change in the Code applies, the Corporation shall provide holders of record with an additional dividend payment in cash equal to the excess of (x) the after-tax amount (assuming a 35% effective combined tax rate) which would have been received assuming a DRD percentage of 70% over (y) the after-tax amount (assuming a 35% effective combined tax rate) calculated using the greater of the new DRP and 50%, divided by 0.65, and rounding the result to the nearest cent (with one-half cent rounded up) (the "DRD Formula").

(c) For the purposes of the DRD Formula as set forth in Section 7(b), "DRP" means the dividends-received percentage applicable to the dividend in question; *provided, however*, that if the DRP applicable to the dividend in question shall be less than 50%, then the DRP shall equal 50%. No amendment to the Code, other than a change in the DRP set forth in Section 243(a)(1) of the Code or any successor provision thereto enacted prior to eighteen (18) months after the date of original issuance of the shares of Series A Preferred Stock, will give rise to an additional dividend payment under the DRD Formula. Notwithstanding the foregoing provisions, if, with respect to any such amendment to the Code, the Corporation receives either an unqualified opinion of nationally recognized independent tax counsel or a private letter ruling or similar form of guidance from the Internal Revenue Service (the "IRS"), to the effect that such amendment does not apply to a dividend payable on the Series A Preferred Stock, then such amendment will not result in an additional dividend payment by the Corporation pursuant to the DRD Formula with respect to such dividend.

(d) Notwithstanding the foregoing, if any such amendment to the Code is enacted after the dividend payment payable on the Dividend Payment Date has been declared but prior to the Dividend Payment Date, and if such amendment is effective with respect to such dividend payment, the amount payable on such Dividend Payment Date will not be increased; instead, additional dividend payments (the “**Post Declaration Date Payments**”), equal to the additional amount that would be paid pursuant to the DRP formula, will be paid to holders of Series A Preferred Stock on the record date applicable to the next succeeding Dividend Payment Date, in addition to any other amounts otherwise payable on such date. If any such amendment to the Code is enacted and the reduction in the DRP retroactively applies to a Dividend Payment Date on which the Corporation previously paid dividends on the Series A Preferred Stock (each, an “**Affected Dividend Payment Date**”), the Corporation will pay additional dividend amounts (the “**Retroactive Payments**”) to holders of

6

---

Series A Preferred Stock, on the record date applicable to the next succeeding Dividend Payment Date, equal to the amount described in this section.

(e) Notwithstanding the foregoing provisions, if, with respect to any such amendment to the Code, the Corporation receives either an unqualified opinion of nationally recognized independent tax counsel or a private letter ruling or similar form of guidance from the IRS to the effect that such amendment does not apply to a dividend payable on an Affected Dividend Payment Date or on a post declaration date for the Series A Preferred Stock, then such amendment will not result in an additional dividend payment.

(f) Notwithstanding the foregoing, no dividend payments by the Corporation will be made in respect of the enactment of any amendment to the Code eighteen (18) months or more after the date of issuance that reduces the DRP or to the extent such amendment reduces the DRP to less than 50%.

(g) In the event that additional dividend amounts become payable in respect of the Series A Preferred Stock pursuant to these provisions, the Corporation will give notice of each such payment to the holders of record of Series A Preferred Stock.

(h) The Corporation’s calculation of such dividend amounts payable, and certified as accurate as to calculation and reasonable as to method by the independent certified public accountants then regularly engaged by the Corporation, will be final and not subject to review absent manifest error.

8. *Voting Rights.* (a) Holders of record of shares of Series A Preferred Stock are not entitled to any voting rights except as provided in this Section 8 or otherwise by law.

(b) If and whenever six quarterly dividends (whether or not consecutive) payable on the Series A Preferred Stock have not been paid in full or if the Corporation fails to redeem for any reason all outstanding shares of Series A Preferred Stock on \_\_\_\_\_, 2011, the authorized number of directors then constituting the Board of Directors shall be increased by two in accordance with Article IV of the Amended and Restated Certificate of Incorporation and the holders of Series A Preferred Stock, together with the holders of every other series of preferred stock upon which like rights to vote for the election of two additional directors have been conferred and are exercisable (resulting from either the failure to pay dividends or the failure to redeem) (any such other series being the “**Preferred Shares**”), voting as a single class regardless of series, shall be entitled to elect the two additional directors to serve on the Board of

7

---

Directors at any annual meeting of stockholders or special meeting held in place thereof, or at a special meeting of the holders of the Series A Preferred Stock and, if applicable, the Preferred Shares called as hereinafter provided. These directors must qualify as “independent directors” under the applicable rules of the New York Stock Exchange. When all arrears in dividends on the Series A Preferred Stock and, if applicable, the Preferred Shares then outstanding have been paid and dividends thereon for the current quarterly dividend period have been paid or declared and set apart for payment, or the Corporation has redeemed all outstanding shares of Series A Preferred Stock on \_\_\_\_\_, 2011, as the case may be, then the right of the holders of the Series A Preferred Stock and, if applicable, the Preferred Shares to elect such additional two directors shall cease (but subject always to the same provisions for the vesting of such voting rights in the case of any similar future arrearages in six quarterly dividends), and the terms of office of all Persons elected as directors by the holders of the Series A Preferred Stock and, if applicable, the Preferred Shares shall immediately terminate and the authorized number of directors then constituting the Board of Directors shall be reduced accordingly.

(c) Within five days following the accrual of any right of the holders of the Series A Preferred Stock and, if applicable, the Preferred Shares to elect two additional directors as described above, the Corporation shall mail or cause to be mailed to the holders of the Series A Preferred Stock and, if applicable, the Preferred Shares notice of a special meeting of stockholders for a date not less than ten days nor more than 45 days after the date of such notice, such call to be made by notice similar to that provided in the Corporation’s by-laws for a special meeting or as required by law. If the Corporation does not mail or cause to be mailed notice of such meeting as provided above within 20 days after the vesting of such voting rights, a meeting may be called by any holder of the Series A Preferred Stock or, if applicable, the Preferred Shares, upon the notice above provided, and for that purpose shall have access to the Corporation’s stock books. The Corporation shall notify the registrar of the date on which such right accrued, and such date will be the record date for determining the holders of stock entitled to notice of and to vote at the special meeting. The directors elected at any such special meeting shall hold office until the next annual meeting of the stockholders or special meeting held in lieu thereof if such office shall not have terminated as above provided. If any vacancy shall occur among the directors elected by the holders of the Series A Preferred Stock and, if applicable, the Preferred Shares, a successor shall be elected by the Board of Directors, upon the nomination of the then-remaining director elected by the holders of the Series A Preferred Stock and, if applicable, the Preferred Shares or the successor of such remaining director or as otherwise provided in this paragraph, to serve until the next annual meeting of the stockholders or

8

---

special meeting held in place thereof if such office shall not have terminated as provided above.

(d) In addition to any other vote required by law, the affirmative vote or consent of the holders of a majority of the outstanding shares of Series A Preferred Stock shall be required to amend, alter or repeal (by merger, consolidation, combination, reclassification or otherwise) any provision of the Amended and Restated Certificate of Incorporation or by-laws of the Corporation so as to adversely affect the preferences, rights or powers of the Series A Preferred Stock; *provided* that any such amendment that changes the dividend payable on or the liquidation preference of the Series A Preferred Stock requires the affirmative vote at a meeting of holders of Series A Preferred Stock duly called for such purpose or written consent of the holder of each share of Series A Preferred Stock.

(e) In exercising the voting or consent rights set forth in this Section 8, at any such special meeting and at each meeting held during the period in which holders of the Series A Preferred Stock and, if applicable, the Preferred Shares retain voting rights as described above, such relevant holders will vote in such elections on the basis of one noncumulative vote per share, and the holder or holders of shares with one-third of the total voting power of such Series A Preferred Stock and, if applicable, of such Preferred Shares then outstanding, present in person or by proxy, will constitute a quorum for the election of directors by them. At any such meeting or adjournment thereof in the absence of a quorum, the holder or holders of shares with a majority of the total voting powers present in person or by proxy shall have the power to adjourn the meeting for the election of such directors without notice, other than by an announcement at the meeting, until a quorum is present. Except as otherwise required by applicable law or as set forth herein, the shares of Series A Preferred Stock shall not have any relative, participating, optional or other special voting rights and powers and the consent of the holders thereof shall not be required for the taking of any corporate action.



---

GE FINANCIAL ASSURANCE HOLDINGS, INC.

Company

GENWORTH FINANCIAL, INC.

Successor Company

and

JPMORGAN CHASE BANK

Trustee

---

**Second Supplemental Indenture**

Dated as of \_\_\_\_\_, 2004

to the

**Indenture**

Dated as of June 26, 2001

as amended by

**First Supplemental Indenture**

Dated as of June 26, 2001

---

Providing for the Issuance of Debt Securities  
(Unlimited as to Aggregate Principal Amount)

---

**SECOND SUPPLEMENTAL INDENTURE**

SECOND SUPPLEMENTAL INDENTURE (this "**Second Supplemental Indenture**"), dated as of May \_\_\_\_\_, 2004, between GE Financial Assurance Holdings, Inc., a Delaware corporation (the "**Company**"), Genworth Financial, Inc., a Delaware corporation (the "**Successor Company**"), and JPMorgan Chase Bank, a New York banking corporation (formerly known as The Chase Manhattan Bank) (the "**Trustee**"), to the Indenture, dated as of June 26, 2001, between the Company and the Trustee (the "**Base Indenture**"), as amended by the First Supplemental Indenture, dated as of June 26, 2001 (the "**First Supplemental Indenture**," and together with the Base Indenture, the "**Indenture**").

**RECITALS:**

WHEREAS, the Company and the Trustee have heretofore entered into the Indenture to provide for the issuance of the Company's unsecured debentures, notes or other evidences of indebtedness to be issued in one or more series;

WHEREAS, Section 11.01 of the Indenture permits the sale, conveyance, transfer or other disposition of all or substantially all of the Company's assets to any other Person, provided that the successor Person shall be a corporation or a limited liability company organized and existing under the laws of the United States of America or a state thereof and such corporation or limited liability company shall expressly assume (1) the due and punctual payment of the principal of, and premium, if any, and interest, if any, on all the Securities according to their tenor, and (2) the due and punctual performance and observance of all of the covenants and conditions of the Indenture to be performed by the Company, by supplemental indenture satisfactory to the Trustee, executed and delivered to the Trustee by the corporation which shall have acquired such assets;

WHEREAS, Section 10.01(a) of the Indenture permits the Company and the Trustee to enter into a supplemental indenture to the Indenture without the consent of the holders of the Securities to evidence the succession of another corporation to the Company and the assumption by the successor corporation of the covenants, agreements and other obligations of the Company pursuant to Article Eleven of the Indenture;

WHEREAS, the Company has transferred substantially all of its assets to the Successor Company and the Successor Company desires to assume the due and punctual payment of the principal of, and premium, if any, and interest, if any, on all of the Securities according to their tenor, and the due and punctual performance and observance of all of the covenants and conditions of the Indenture to be performed by the Company and, in connection therewith, the Trustee has agreed to enter into this

Second Supplemental Indenture to reflect such assumption;

WHEREAS, the Trustee has received an Opinion of Counsel and an Officers' Certificate, pursuant to Sections 10.05, 11.03 and 14.05 of the Indenture, stating that (i) the Second Supplemental Indenture complies with the requirements of Article Ten of the Indenture, (ii) the transfer of substantially all of the Company's assets to the Successor Company and the Second Supplemental Indenture comply with the provisions of Article Eleven of the Indenture, and (iii) all conditions precedent provided for in the Indenture to the execution and delivery by the Trustee of the Second Supplemental Indenture have been complied with; and

WHEREAS, all things necessary to make this Second Supplemental Indenture a valid agreement of the Company, the Successor Company and the Trustee, in accordance with its terms, have been done.

---

NOW, THEREFORE, in consideration of the above premises, each party covenants and agrees, for the benefit of the other parties and for the equal and ratable benefit of all of the holders of the Securities, as follows:

## ARTICLE ONE

### ASSUMPTION OF COMPANY OBLIGATIONS

#### Section 1.1      Assumption of Company Obligations.

The Successor Company hereby assumes the obligations of the Company under the Indenture with respect to the due and punctual payment of the principal of, and premium, if any, and interest, if any, on all the Securities according to their tenor, and the due and punctual performance and observance of all of the covenants and conditions of the Indenture to be performed by the Company;

#### Section 1.2      The Successor Company to be Substituted for the Company.

Pursuant to Section 11.02 of the Indenture and not in limitation of any other provisions thereof, upon execution and delivery of the Second Supplemental Indenture, the Successor Company shall succeed to and be substituted for the Company, with the same effect as if it had been named in the Indenture as the party of the first part and the Company shall be relieved of any further obligation under the Indenture and the Securities.

#### Section 1.3      Agencies.

The Successor Company hereby confirms all agency appointments made by the Company under the Indenture.

#### Section 1.4      Notices.

For purposes of Section 14.03 of the Base Indenture, the address of the Successor Company is:

Genworth, Financial, Inc.  
6620 West Broad Street  
Richmond, Virginia 23230

#### Section 1.5      Notation on Securities.

All of the 1.6% Notes due 2011 authenticated and delivered after the date hereof shall bear the following notation, which may be stamped or imprinted thereon:

"In connection with the transfer of substantially all of the Company's assets to Genworth Financial, Inc. and pursuant to the Second Supplemental Indenture dated as of \_\_\_\_\_, 2004, Genworth Financial, Inc. has assumed the due and punctual payment of the principal of, premium, if any, and interest, on, this Note and the due and punctual performance and observance of all of the covenants and conditions of the Indenture to be performed by the Company."

## ARTICLE TWO

### MISCELLANEOUS

#### Section 2.1      Definitions.

---

Except as otherwise expressly provided or unless the context otherwise requires, all terms used herein which are defined in the Indenture shall have the meanings assigned to them in the Indenture.

#### Section 2.2      Confirmation of the Indenture.

The Indenture, as supplemented by this Second Supplemental Indenture, is in all respects ratified and confirmed, and the Indenture, this Second Supplemental Indenture and all indentures supplemental thereto shall be read, taken and construed as one and the same instrument.

#### Section 2.3      Effective Date; Termination.

This Second Supplemental Indenture will take effect as of the date first set forth above.

#### Section 2.4      Governing Law.

This Second Supplemental Indenture shall be deemed to be a contract made under the laws of the State of New York, and for all purposes shall be construed in accordance with the laws of said State.

Section 2.5      Counterparts.

This Second Supplemental Indenture may be executed in any number of counterparts each of which shall be an original, but such counterparts shall together constitute but one and the same instrument.

Section 2.6      Trustee.

The Trustee makes no representations as to the validity or sufficiency of this Second Supplemental Indenture. The recitals and statements contained in this Second Supplemental Indenture are deemed to be those of the Company and the Successor Company and not of the Trustee.

\*\*\*\*\*

[THE REMAINDER OF THIS PAGE HAS BEEN INTENTIONALLY LEFT BLANK]

---

IN WITNESS WHEREOF, the parties hereto have caused this Second Supplemental Indenture to be duly executed, all as of the day and year first written above.

**GE FINANCIAL ASSURANCE HOLDINGS, INC.**

By: \_\_\_\_\_  
Name:  
Title:

**GENWORTH FINANCIAL, INC.**

By: \_\_\_\_\_  
Name:  
Title:

**JPMORGAN CHASE BANK**

By: \_\_\_\_\_  
Name:  
Title:

---

GENWORTH FINANCIAL, INC.

THE BANK OF NEW YORK, Trustee

Indenture

Dated as of \_\_\_\_\_, 2004

---

**TABLE OF CONTENTS**

**ARTICLE 1**  
**DEFINITIONS**

Section 1.01. Definitions

**ARTICLE 2**  
**DESCRIPTION, EXECUTION, REGISTRATION AND EXCHANGE OF SECURITIES**

Section 2.01. Forms  
Section 2.02. Amount Unlimited; Issuable in Series  
Section 2.03. Authentication  
Section 2.04. Date and Denomination of Securities  
Section 2.05. Execution of Securities  
Section 2.06. Exchange and Registration of Transfer of Securities  
Section 2.07. Mutilated, Destroyed, Lost or Stolen Securities  
Section 2.08. Temporary Securities  
Section 2.09. Cancellation of Securities Paid, etc  
Section 2.10. Computation of Interest  
Section 2.11. Form of Legend for Global Securities

**ARTICLE 3**  
**REDEMPTION OF SECURITIES; SINKING FUNDS**

Section 3.01. Applicability of Article  
Section 3.02. Notice of Redemption; Selection of Securities  
Section 3.03. Payment of Securities Called for Redemption  
Section 3.04. Satisfaction of Mandatory Sinking Fund Payments with Securities  
Section 3.05. Redemption of Securities for Sinking Fund  
Section 3.06. Repayment at the Option of the Holder

**ARTICLE 4**  
**PARTICULAR COVENANTS OF THE COMPANY**

Section 4.01. Payment of Principal, Premium and Interest  
Section 4.02. Offices for Notices and Payments, etc  
Section 4.03. Appointment to Fill Vacancies in Trustee's Office  
Section 4.04. Provision as to Paying Agent  
Section 4.05. Statement as to Compliance  
Section 4.06. Additional Amounts

i

---

**ARTICLE 5**  
**SECURITYHOLDER LISTS AND REPORTS BY THE COMPANY AND THE TRUSTEE**

Section 5.01. Securityholder Lists  
Section 5.02. Reports by the Company  
Section 5.03. Reports by the Trustee

**ARTICLE 6**  
**REMEDIES OF THE TRUSTEE AND SECURITYHOLDERS ON EVENT OF DEFAULT**

Section 6.01. Events of Default  
Section 6.02. Payment of Securities on Default; Suit Therefor  
Section 6.03. Application of Moneys Collected by Trustee  
Section 6.04. Proceedings by Securityholders  
Section 6.05. Proceedings by Trustee  
Section 6.06. Remedies Cumulative and Continuing  
Section 6.07. Direction of Proceedings and Waiver of Defaults by Securityholders  
Section 6.08. Notice of Defaults  
Section 6.09. Undertaking to Pay Costs

ARTICLE 7  
CONCERNING THE TRUSTEE

Section 7.01. Duties and Responsibilities of Trustee  
Section 7.02. Reliance on Documents, Opinions, etc  
Section 7.03. No Responsibility for Recitals, etc  
Section 7.04. Ownership of Securities  
Section 7.05. Moneys to be Held in Trust  
Section 7.06. Compensation and Expenses of Trustee  
Section 7.07. Officers' Certificate as Evidence  
Section 7.08. Indentures Not Creating Potential Conflicting Interests for the Trustee  
Section 7.09. Eligibility of Trustee  
Section 7.10. Resignation or Removal of Trustee  
Section 7.11. Acceptance by Successor Trustee  
Section 7.12. Succession by Merger, etc  
Section 7.13. Other Matters Concerning the Trustee  
Section 7.14. Appointment of Authenticating Agent

ARTICLE 8  
CONCERNING THE SECURITYHOLDERS

Section 8.01. Action of Securityholders  
Section 8.02. Proof of Execution by Securityholders  
Section 8.03. Who Are Deemed Absolute Owners  
Section 8.04. Company-Owned Securities Disregarded

ii

---

Section 8.05. Revocation of Consents: Future Holders Bound

ARTICLE 9  
SECURITYHOLDERS' MEETINGS

Section 9.01. Purposes of Meetings  
Section 9.02. Call of Meetings by Trustee  
Section 9.03. Call of Meetings by Company or Securityholders  
Section 9.04. Qualifications for Voting  
Section 9.05. Quorum: Adjourned Meetings  
Section 9.06. Regulations  
Section 9.07. Voting  
Section 9.08. No Delay of Rights by Meeting

ARTICLE 10  
SUPPLEMENTAL INDENTURES

Section 10.01. Supplemental Indentures without Consent of Securityholders  
Section 10.02. Supplemental Indentures with Consent of Securityholders  
Section 10.03. Compliance with Trust Indenture Act; Effect of Supplemental Indentures  
Section 10.04. Notation on Securities  
Section 10.05. Evidence of Compliance of Supplemental Indenture to be Furnished Trustee

ARTICLE 11  
CONSOLIDATION, MERGER, SALE OR CONVEYANCE

Section 11.01. Company May Not Consolidate, etc., Except Under Certain Conditions  
Section 11.02. Successor Corporation or Limited Liability Company to be Substituted  
Section 11.03. Documents to be Given Trustee

ARTICLE 12  
SATISFACTION AND DISCHARGE OF INDENTURE

Section 12.01. Discharge of Indenture  
Section 12.02. Legal Defeasance  
Section 12.03. Covenant Defeasance  
Section 12.04. Deposited Moneys to be Held in Trust by Trustee; Miscellaneous Provisions  
Section 12.05. Paving Agent to Repay Moneys Held  
Section 12.06. Return of Unclaimed Moneys  
Section 12.07. Reinstatement

iii

---

ARTICLE 13  
IMMUNITY OF INCORPORATORS, STOCKHOLDERS, OFFICERS AND DIRECTORS

Section 13.01. Indenture and Securities Solely Corporate Obligations

ARTICLE 14  
MISCELLANEOUS PROVISIONS

Section 14.01. Provisions Binding on Company's Successors



[Section 14.02. Official Acts by Successor Corporation](#)  
[Section 14.03. Addresses for Notices, Notice to Holders, Waiver](#)  
[Section 14.04. New York Contract](#)  
[Section 14.05. Evidence of Compliance with Conditions Precedent](#)  
[Section 14.06. Legal Holidays](#)  
[Section 14.07. Securities in a Specified Currency other than Dollars](#)  
[Section 14.08. Trust Indenture Act to Control](#)  
[Section 14.09. Table of Contents, Headings, etc](#)  
[Section 14.10. Execution in Counterparts](#)  
[Section 14.11. Separability; Benefits](#)

THIS INDENTURE, dated as of \_\_\_\_\_, 2004 between Genworth Financial, Inc., a Delaware corporation (the “Company”), and The Bank of New York, a banking corporation duly organized and existing under the laws of the State of New York (the “Trustee”),

WITNESSETH:

WHEREAS, the Company has duly authorized the issue from time to time of its unsecured debentures, notes or other evidences of indebtedness to be issued in one or more series (the “Securities”) up to such principal amount or amounts as may from time to time be authorized in accordance with the terms of this Indenture and to provide, among other things, for the authentication, delivery and administration thereof, the Company has duly authorized the execution and delivery of this Indenture; and

WHEREAS, all things necessary to make this Indenture a valid indenture and agreement according to its terms have been done;

NOW, THEREFORE:

In consideration of the premises and the purchases of the Securities by the holders thereof, the Company and the Trustee mutually covenant and agree for the equal and proportionate benefit of the respective holders from time to time of the Securities as follows:

ARTICLE I  
DEFINITIONS

Section 1.01. *Definitions.* The terms defined in this Section 1.01 (except as herein otherwise expressly provided or unless the context otherwise requires) for all purposes of this Indenture shall have the respective meanings specified in this Section 1.01. All other terms used in this Indenture which are defined in the Trust Indenture Act of 1939, as amended, or which are by reference therein defined in the Securities Act of 1933, as amended (except as herein otherwise expressly provided or unless the context otherwise requires), shall have the meanings assigned to such terms in said Trust Indenture Act and in said Securities Act as in force at the date of this Indenture as originally executed. The words “herein,” “hereof,” and “hereunder” and other words of similar import refer to this Indenture as a whole and not to any particular Article, Section or other subdivision.

Authenticating Agent:

The term “Authenticating Agent” shall mean any Person authorized by the Trustee pursuant to Section 7.14 to act on behalf of the Trustee to authenticate Securities.

---

Beneficial Owner:

The term “Beneficial Owner” shall mean a Person who is the beneficial owner of an interest in a Global Security as reflected on the books of the Depository or on the books of a Person maintaining an account with such Depository (directly as a Depository participant or as an indirect participant, in each case in accordance with the rules of such Depository).

Board of Directors:

The term “Board of Directors” shall mean the Board of Directors of the Company or any Committee of such Board or specified officers and employees of the Company to which the powers of such Board have been lawfully delegated.

Company:

The term “Company” shall mean Genworth Financial, Inc., a Delaware corporation, until any successor corporation or limited liability company shall have become such pursuant to the provisions of Article Eleven, and thereafter “Company” shall mean such successor, except as otherwise provided in Section 11.02.

Depository:

The term “Depository” shall mean, with respect to Securities of any series issuable in whole or in part in the form of one or more Global Securities, a clearing agency registered under the Securities Exchange Act of 1934, as amended, that is designated to act as Depository for such Securities as contemplated by Section 2.02.

Dollar:

The term “Dollar” shall mean the coin or currency of the United States of America as at the time of payment is legal tender for the payment of public and private debts.

Event of Default:

The term “Event of Default” shall have the meaning specified in Section 6.01.

Global Security:

The term “Global Security” shall mean a Security that evidences all or part of the Securities of any series and bears the legend set forth in Section 2.11 (or such legend as may be specified as contemplated by Section 2.02 for such Securities).

Indenture:

The term "Indenture" shall mean this instrument as originally executed or as it may be amended or supplemented from time to time as herein provided, and shall include the form and terms of particular series of Securities established as contemplated hereunder.

Interest:

The term "interest," when used with respect to a non-interest bearing Security, means interest payable after the principal thereof has become due and payable whether at maturity, by declaration of acceleration, by call for redemption, pursuant to a sinking fund, or otherwise.

Officers' Certificate:

The term "Officers' Certificate" shall mean a certificate signed by the President, the Chairman or any Vice Chairman of the Board or any Vice President and by the Treasurer or any Assistant Treasurer, the Comptroller or the Secretary or any Assistant Secretary of the Company and delivered to the Trustee. Each such certificate shall comply with Section 314 of the Trust Indenture Act of 1939 and include the statements provided for in Section 14.05 if and to the extent required by the provisions of such Section.

Opinion of Counsel:

The term "Opinion of Counsel" shall mean an opinion in writing signed by legal counsel, who may be an employee of or of counsel to the Company, or may be other counsel, in any case, satisfactory to the Trustee. Each such opinion shall comply with Section 314 of the Trust Indenture Act of 1939 and include the statements provided for in Section 14.05 if and to the extent required by the provisions of such Sections.

Original Issue Discount Security:

The term "Original Issue Discount Security" shall mean any Security which provides for an amount less than the principal amount thereof to be due and payable upon a declaration of acceleration of the maturity thereof pursuant to Section 6.01.

Overdue Rate:

The term "Overdue Rate" with respect to each series of Securities shall mean the rate of interest designated as such in the resolution of the Board of Directors or the supplemental indenture, as the case may be, relating to such series as contemplated by Section 2.02, or if no such rate is specified, the rate at which such Securities shall bear interest.

3

---

Person:

The term "Person" shall mean any individual, corporation, partnership, joint venture, association, joint stock company, trust, unincorporated organization or government or any agency or political subdivision thereof.

Principal Office of the Trustee:

The term "principal office of the Trustee," or other similar term, shall mean the office of the Trustee at which at any particular time its corporate trust business shall be principally administered.

Responsible Officer:

The term "Responsible Officer" when used with respect to the Trustee shall mean any officer of the Trustee within the Corporate Trust Division-Corporate Finance Unit (or any successor unit or department) of the Trustee located at the address designated by reference in or pursuant to Section 14.03 hereof who has direct responsibility for administration of the Indenture and, for purposes of Sections 6.08 and 7.01 hereof, also includes any officer or assistant officer of the Trustee customarily performing similar functions to whom any corporate trust matter is referred because of his knowledge of and familiarity with the particular subject.

Security or Securities: Outstanding:

The terms "Security" or "Securities" shall mean any Security or Securities, as the case may be, authenticated and delivered under this Indenture.

The term "Outstanding," when used with reference to Securities, shall, subject to the provisions of Section 8.04, mean, as of any particular time, all Securities authenticated and delivered by the Trustee under this Indenture, except

- (a) Securities theretofore cancelled by the Trustee or delivered to the Trustee for cancellation;
- (b) Securities, or portions thereof, for the payment or redemption of which moneys in the necessary amount shall have been deposited in trust with the Trustee or with any paying agent (other than the Company) or shall have been set aside and segregated in trust by the Company (if the Company shall act as its own paying agent), provided that if such Securities are to be redeemed prior to the maturity thereof, notice of such redemption shall have been mailed as in Article Three provided, or provision satisfactory to the Trustee shall have been made for mailing such notice;
- (c) Securities as to which defeasance has been effected pursuant to Section 12.02; and

4

---

(d) Securities in lieu of or in substitution for which other Securities shall have been authenticated and delivered, or which shall have been paid, pursuant to the terms of Section 2.07, unless proof satisfactory to the Trustee is presented that any such Securities are held by persons in whose hands any of such Securities is a valid, binding and legal obligation of the Company.

In determining whether the holders of the requisite principal amount of Outstanding Securities have given any request, demand, authorization, direction, notice, consent or waiver hereunder, the principal amount of an Original Issue Discount Security that shall be deemed to be Outstanding for such purposes shall be the amount of the principal thereof that would be due and payable as of the date of such determination upon a declaration of acceleration of the maturity thereof pursuant to Section 6.01.

Securityholder:

The term “Securityholder,” “holder of Securities,” or other similar terms, shall mean any person in whose name at the time a particular Security is registered on the books of the Company kept for that purpose in accordance with the terms hereof.

Significant Subsidiary:

The term “Significant Subsidiary” shall have the same meaning as the definition of that term set forth in Rule 1-02 of Regulation S-X as promulgated by the Securities and Exchange Commission.

Specified Currency:

The term “Specified Currency” shall mean the currency in which a Security is denominated, which may include Dollars, any foreign currency or any composite of two or more currencies.

Trust Indenture Act of 1939:

The term “Trust Indenture Act of 1939” shall mean the Trust Indenture Act of 1939 as it was in force at the date of execution of this Indenture, except as provided in Section 10.03.

Trustee:

The term “Trustee” shall mean the corporation or association named as Trustee in this Indenture and, subject to the provisions of Article Seven hereof,

5

---

shall also include its successors and assigns as Trustee hereunder. If pursuant to the provisions of this Indenture there shall be at any time more than one Trustee hereunder, the term “Trustee” as used with respect to Securities of any series shall mean the Trustee with respect to Securities of that series.

U.S. Government Obligations:

The term “U.S. Government Obligations” shall have the meaning specified in Section 12.02.

ARTICLE 2  
DESCRIPTION, EXECUTION, REGISTRATION AND EXCHANGE OF SECURITIES

Section 2.01. *Forms.* (a) The Securities of each series shall be in substantially such form as shall be established by or pursuant to a resolution of the Board of Directors or in one or more indentures supplemental hereto, in each case with such appropriate insertions, omissions, substitutions and other variations as are required or permitted by this Indenture, and may have such legends or endorsements placed thereon as the officers executing the same may approve (execution thereof to be conclusive evidence of such approval) and as are not inconsistent with the provisions of this Indenture, or as may be required to comply with any law or with any rule or regulation made pursuant thereto or with any rule or regulation of any stock exchange on which the Securities of such series may be listed, or to conform to usage.

(b) The resolutions adopted by the Board of Directors establishing the form and terms of the Securities of any series pursuant to Sections 2.01 and 2.02, respectively, of this Indenture, may provide for issuance of Global Securities. If Securities of a series are so authorized to be issued as Global Securities, any such Global Security may provide that it shall represent that aggregate amount of Securities from time to time endorsed thereon and may also provide that the aggregate amount of Outstanding Securities represented thereby may from time to time be reduced to reflect exchanges. Any endorsement of a Global Security to reflect the amount, or any increase or decrease in the amount or changes in the rights of holders of Securities represented thereby, shall be made in such manner and by such person or persons as shall be specified therein.

(c) The Trustee’s Certificate of Authentication on all Securities shall be in substantially the following form:

“This is one of the Securities of the series designated therein described in the within-mentioned Indenture.

6

---

THE BANK OF NEW YORK, as Trustee

By: \_\_\_\_\_  
Authorized Officer

Section 2.02. *Amount Unlimited; Issuable in Series.* The aggregate principal amount of Securities which may be authenticated and delivered under this Indenture is unlimited.

The Securities may be issued in one or more series. There shall be established in or pursuant to a resolution of the Board of Directors or established in one or more indentures supplemental hereto, prior to the issuance of Securities of any series:

- (1) the title of the Securities of the series (which shall distinguish the Securities of the series from all other Securities);
- (2) any limit upon the aggregate principal amount of the Securities of the series which may be authenticated and delivered under this Indenture (except for Securities authenticated and delivered upon registration of transfer of, or in exchange for, or in lieu of, other Securities of the series pursuant to Sections 2.06, 2.07, 2.08, 3.03, 3.06 or 10.04);
- (3) the date or dates on which the principal and premium, if any, of the Securities of the series is payable;
- (4) the rate or rates, or the method of determination thereof, at which the Securities of the series shall bear interest, if any, the date or dates from which such interest shall accrue, the interest payment dates on which such interest shall be payable and, if other than as set forth in Section 2.04, the record dates for the determination of holders to whom interest is payable;
- (5) in addition to the office or agency of the Company in the Borough of Manhattan, The City of New York required to be maintained pursuant to Section 4.02, any other place or places where the principal of, and premium, if any, and any interest on Securities of the series shall be payable;

- (6) the Specified Currency of the Securities of the series;
- (7) the currency or currencies in which payments on the Securities of the series are payable, if other than the Specified Currency;
- (8) the price or prices at which, the period or periods within which and the terms and conditions upon which Securities of the series may be redeemed, in whole or in part, at the option of the Company, pursuant to any sinking fund or otherwise;

7

---

- (9) the obligation, if any, of the Company to redeem, purchase or repay Securities of the series pursuant to any sinking fund or analogous provisions or at the option of a holder thereof and the price at which or process by which and the period or periods within which and the terms and conditions upon which Securities of the series shall be redeemed, purchased or repaid, in whole or in part, pursuant to such obligation;
- (10) if other than denominations of \$1,000 and any integral multiple thereof, the denominations in which Securities of the series shall be issuable;
- (11) if other than the principal amount thereof, the portion of the principal amount of Securities of the series which shall be payable upon declaration of acceleration of the maturity thereof pursuant to Section 6.01;
- (12) if the principal of or interest on the Securities of the series are to be payable, at the election of the Company or a holder thereof, in a coin or currency other than the Specified Currency, the period or periods within which, and the terms and conditions upon which, such election may be made;
- (13) if the amount of payments of principal of and interest on the Securities of the series may be determined with reference to an index based on a coin or currency other than the Specified Currency, the manner in which such amounts shall be determined;
- (14) any Events of Default with respect to the Securities of the series, if not set forth herein;
- (15) if other than the rate of interest stated in the title of the Securities of the series, the applicable Overdue Rate;
- (16) in the case of any series of non-interest bearing Securities, the applicable dates for purposes of clause (a) of Section 5.01;
- (17) if other than The Bank of New York is to act as Trustee for the Securities of the series, the name and Principal Office of such Trustee;
- (18) if either or both of Sections 12.02 and 12.03 do not apply to any Securities of the series;
- (19) if applicable, that any Securities of the series shall be issuable in whole or in part in the form of one or more Global Securities and, in such case, the name of the respective Depositories for such Global Securities, the form of any legend or legends which shall be borne by any such Global Security in addition to or in lieu of that set forth in Section

8

---

2.11 and any circumstances in addition to or in lieu of those set forth in clause (2) of Section 2.06 in which any such Global Security may be exchanged in whole or in part for Securities registered, and any transfer of such Global Security in whole or in part may be registered, in the name or names of Persons other than the Depository for such Global Security or a nominee thereof;

- (20) any addition to the covenants set forth in Article Four which applies to Securities of the series and whether any such covenant shall be subject to covenant defeasance under Section 12.03; and
- (21) any other terms of the series (which terms shall not be inconsistent with the provisions of this Indenture).

All Securities of any one series shall be substantially identical except as to denomination and except as may otherwise be provided in or pursuant to such resolution of the Board of Directors or in any such indenture supplemental hereto.

Section 2.03. *Authentication.* At any time and from time to time after the execution and delivery of this Indenture, the Company may deliver Securities of any series executed by the Company to the Trustee for authentication. Except as otherwise provided in this Article Two, the Trustee shall thereupon authenticate and deliver said Securities to or upon the written order of the Company, signed by its President, its Chairman or any Vice Chairman of the Board or one of its Vice Presidents and by its Treasurer, its Controller or its Secretary. In authenticating such Securities, and accepting the additional responsibilities under this Indenture in relation to such Securities, the Trustee shall be entitled to receive and (subject to Section 7.01) shall be fully protected in relying upon:

- (1) a copy of any resolution or resolutions of the Board of Directors relating thereto and, if applicable, an appropriate record of any action taken pursuant to such resolution, in each case certified by the Secretary or an Assistant Secretary of the Company;
- (2) an executed supplemental indenture, if any, relating thereto;
- (3) an Officers' Certificate prepared in accordance with Section 14.05 which shall also state to the best knowledge of the signers of such Certificate that no Event of Default with respect to any series of Securities shall have occurred and be continuing; and
- (4) an Opinion of Counsel prepared in accordance with Section 14.05 to the effect

9

---

(a) that the form of such Securities has been established by or pursuant to a resolution of the Board of Directors or by a supplemental indenture as permitted by Section 2.01 in conformity with the provisions of this Indenture;

(b) that the terms of such Securities have been established by or pursuant to a resolution of the Board of Directors or by a supplemental indenture as permitted by Section 2.02 in conformity with the provisions of this Indenture;

(c) that such Securities, when authenticated and delivered by the Trustee and issued by the Company in the manner and subject to any conditions specified in such Opinion of Counsel, will constitute legal, valid and binding obligations of the Company, enforceable in accordance with their terms, subject to bankruptcy, insolvency, reorganization and other laws of general applicability relating to or affecting the enforcement of creditors' rights and to general equity principles;

(d) that the Company has the corporate power to issue such Securities, and has duly taken all necessary corporate action with respect to such issuance;

(e) that the issuance of such Securities will not contravene the organizational certificate or by-laws of the Company or result in any violation of any of the terms or provisions of any law or regulation or of any indenture, mortgage or other agreement known to such Counsel by which the Company or any of its Subsidiaries is bound; and

(f) that all laws and requirements in respect of the execution and delivery by the Company of such Securities and the related supplemental indenture, if any, have been complied with and that authentication and delivery of such Securities and the execution and delivery of the related supplemental indenture, if any, by the Trustee will not violate the terms of this Indenture.

The Trustee shall have the right to decline to authenticate and deliver or cause to be authenticated and delivered any Securities under this Section 2.03 if the Trustee, being advised by counsel, determines that such action may not lawfully be taken or if the Trustee in good faith by its board of directors or trustees, executive committee, or a trust committee of directors or trustees and/or vice presidents shall determine that such action would expose the Trustee to personal liability to existing Securityholders.

Section 2.04. *Date and Denomination of Securities.* The Securities of each series shall be issuable in registered form without coupons in such denominations as shall be specified as contemplated by Section 2.02. In the absence of any such specification with respect to the Securities of any series, the Securities of such series shall be issuable in denominations of \$1,000 and any multiple of \$1,000. Securities of each series shall be numbered, lettered or otherwise distinguished in such manner or in accordance with such plan as the

10

---

officers of the Company executing the same may determine with the approval of the Trustee.

Every Security shall be dated the date of its authentication.

The person in whose name any Security of a particular series is registered at the close of business on any record date (as hereinafter defined) with respect to any interest payment date for such series shall be entitled to receive the interest payable on such interest payment date notwithstanding the cancellation of such Security upon any registration of transfer or exchange subsequent to the record date and prior to such interest payment date; *provided, however*, that if and to the extent that the Company shall default in the payment of the interest due on such interest payment date, such defaulted interest shall be paid to the persons in whose names Outstanding Securities of such series are registered on a subsequent record date established by notice given by mail by or on behalf of the Company to the holders of such Securities not less than 15 days preceding such subsequent record date, such record date to be not less than five days preceding the date of payment of such defaulted interest. Except as otherwise specified as contemplated by Section 2.02 for Securities of a particular series, the term "record date" as used in this Section 2.04 with respect to any regular interest payment date, shall mean, the last day of the calendar month preceding such interest payment date if such interest payment date is the fifteenth day of such calendar month, and shall mean the fifteenth day of the calendar month preceding such interest payment date if such interest payment date is the first day of a calendar month, whether or not such day shall be a day on which banking institutions in The City of New York are authorized or required by law or executive order to close or remain closed.

Interest on the Securities may at the option of the Company be paid by check mailed to the persons entitled thereto at their respective addresses as such appear on the registry books of the Company.

Section 2.05. *Execution of Securities.* The Securities shall be signed in the name and on behalf of the Company by the manual or facsimile signature of its President, its Chairman of the Board or Chief Financial Officer and its Treasurer or Assistant Treasurer, its Secretary or Assistant Secretary, under its corporate seal (which may be printed, engraved or otherwise reproduced thereon, by facsimile or otherwise). Only such Securities as shall bear thereon a certificate of authentication substantially in the form herein recited, executed by the Trustee by the manual signature of an authorized officer, shall be entitled to the benefits of this Indenture or be valid or obligatory for any purpose. Such certificate by the Trustee upon any Security executed by the Company shall be conclusive evidence that the Security so authenticated has been duly authenticated and delivered hereunder and that the holder is entitled to the benefits of this Indenture.

In case any officer of the Company who shall have signed any of the Securities shall cease to be such officer before the Securities so signed shall have

11

---

been authenticated and delivered by the Trustee, or disposed of by the Company, such Securities nevertheless may be authenticated and delivered or disposed of as though the person who signed such Securities had not ceased to be such officer of the Company; and any Security may be signed on behalf of the Company by such persons as, at the actual date of the execution of such Security, shall be the proper officers of the Company, although at the date of the execution of this Indenture any such person was not such an officer.

Section 2.06. *Exchange and Registration of Transfer of Securities.* Securities of any series may be exchanged for a like aggregate principal amount of Securities of the same series of other authorized denominations. Securities to be exchanged shall be surrendered, at the option of the holders thereof, either at the office or agency designated and maintained by the Company for such purpose in the Borough of Manhattan, The City of New York, in accordance with the provisions of Section 4.02 or at any of such other offices or agencies as may be designated and maintained by the Company for such purpose in accordance with the provisions of Section 4.02, and the Company shall execute and register and the Trustee shall authenticate and deliver in exchange therefor the Security or Securities which the Securityholder making the exchange shall be entitled to receive. Each person designated by the Company pursuant to the provisions of Section 4.02 as a person authorized to register and register transfer of the Securities is sometimes herein referred to as a "Security registrar".

The Company shall keep, at each such office or agency, a register for each series of Securities issued hereunder (the registers of all Security registrars being herein sometimes collectively referred to as the "Security register" or the "registry books of the Company") in which, subject to such reasonable regulations as it may prescribe, the Company shall register Securities and shall register the transfer of Securities as in this Article Two provided. The Security register shall be in written form or in any other form capable of being converted into written form within a reasonable time. At all reasonable times the Security registrar shall be open for inspection by the Trustee and any Security registrar other than the Trustee. Upon due presentation for registration or registration of transfer of any Security of any series at any designated office or agency, the Company shall execute and register and the Trustee shall authenticate and deliver in the name of the transferee or transferees a new Security or Securities of the same series for an equal aggregate principal amount. Registration or registration of transfer of any Security by any Security registrar in the registry books of the Company maintained by such Security registrar, and delivery of such Security, duly authenticated, shall be deemed to complete the registration or registration of transfer of such Security.

No person shall at any time be designated as or act as a Security registrar unless such person is at such time empowered under applicable law to act as such under and to the extent required by applicable law and regulations.

12

---

All Securities presented for registration of transfer or for exchange, redemption or payment shall (if so required by the Company or the Trustee) be duly endorsed by,

or be accompanied by a written instrument or instruments of transfer or exchange in form satisfactory to the Company and the Trustee duly executed by, the holder or his attorney duly authorized in writing.

No service charge shall be made for any exchange or registration of transfer of Securities, but the Company may require payment of a sum sufficient to cover any tax or other governmental charge that may be imposed in connection therewith.

The Company shall not be required to exchange or register a transfer of (a) any Securities of any series for the period of 15 days next preceding the selection of Securities of that series to be redeemed and thereafter until the date of the mailing of a notice of redemption of Securities of that series selected for redemption, or (b) any Securities selected, called or being called for redemption in whole or in part except, in the case of any Security to be redeemed in part, the portion thereof not so to be redeemed.

The provisions of clauses (1), (2), (3), (4), (5), (6) and (7) below shall apply only to Global Securities:

(1) Each Global Security authenticated under this Indenture shall be registered in the name of the Depository designated for such Global Security or a nominee thereof and delivered to such Depository or nominee thereof or custodian therefor, and each such Global Security shall constitute a single Security for all purposes under this Indenture.

(2) Notwithstanding any other provision in this Indenture, no Global Security may be exchanged in whole or in part for Securities registered, and no transfer of a Global Security in whole or in part may be registered, in the name of any Person other than the Depository for such Global Security or a nominee thereof unless (A) such Depository (i) has notified the Company that it is unwilling or unable to continue its services as Depository for such Global Security and no successor Depository has been appointed within 90 days after such notice or (ii) ceases to be a "clearing agency" registered under Section 17A of the Securities Exchange Act of 1934 when the Depository is required to be so registered to act as the Depository and so notifies the Company, and no successor Depository has been appointed within 90 days after such notice, (B) to the extent permitted by the Depository, the Company determines that the Global Securities shall be exchangeable for definitive Securities or (C) a Beneficial Owner requests to exchange such Beneficial Owner's interest in the Global Securities for definitive Securities.

(3) Subject to clause (2) above, any exchange of a Global Security for other Securities may be made in whole or in part, and all

13

---

Securities issued in exchange for a Global Security or any portion thereof shall be registered in such names as the Depository for such Global Security shall direct.

(4) Every Security authenticated and delivered upon registration of transfer of, or in exchange for or in lieu of, a Global Security or any portion thereof shall be authenticated and delivered in the form of, and shall be, a Global Security, unless such Security is registered in the name of a Person other than the Depository for such Global Security or a nominee thereof.

(5) Subject to the provisions of clause (7) below, the registered Holder may grant proxies and otherwise authorize any Person, including Agent Members (as defined below in clause (7)) and persons that may hold interests through Agent Members, to take any action which a Holder is entitled to take under this Indenture or the Securities.

(6) In the event of the occurrence of any of the events specified in clause (2) above, the Company will promptly make available to the Trustee a reasonable supply of certificated Securities in definitive, fully registered form, without interest coupons.

(7) Neither any members of, or participants in, the Depository (collectively, the "Agent Members") nor any other Persons on whose behalf Agent Members may act shall have any rights under this Indenture with respect to any Global Security registered in the name of the Depository or any nominee thereof, or under any such Global Security, and the Depository or such nominee, as the case may be, may be treated by the Company, the Trustee and any agent of the Company or the Trustee as the absolute owner and holder of such Global Security for all purposes whatsoever. Notwithstanding the foregoing, nothing herein shall prevent the Company or the Trustee or any agent of the Company or the Trustee from giving effect to any written certification, proxy or other authorization furnished by the Depository or such nominee, as the case may be, or impair, as between the Depository, its Agent Members and any other person on whose behalf an Agent Member may act, the operation of customary practices of such Persons governing the exercise of the rights of a holder of any Security.

Section 2.07. *Mutilated, Destroyed, Lost or Stolen Securities.* In case any temporary or definitive Security shall become mutilated or be destroyed, lost or stolen, the Company in the case of a mutilated Security shall, and in the case of a lost, stolen or destroyed Security may in its discretion, execute and, upon the written request or authorization of any officer of the Company, the Trustee shall authenticate and deliver, a new Security of the same series, bearing a number not contemporaneously Outstanding, in exchange and substitution for the mutilated

14

---

Security, or in lieu of and in substitution for the Security so destroyed, lost or stolen. In every case the applicant for a substituted Security shall furnish to the Company and to the Trustee such security or indemnity as may be required by them to save each of them harmless, and, in every case of destruction, loss or theft, the applicant shall also furnish the Company and to the Trustee evidence to their satisfaction of the destruction, loss or theft of such Security and the ownership thereof.

Upon the issuance of any substituted Security, the Company may require the payment of a sum sufficient to cover any tax or other governmental charge that may be imposed in relation thereto and any other expenses connected therewith. In case any Security which has matured or is about to mature shall become mutilated or be destroyed, lost or stolen, the Company may, instead of issuing a substituted Security, pay or authorize the payment of the same (without surrender thereof except in the case of a mutilated Security) if the applicant for such payment shall furnish to the Company and to the Trustee such security or indemnity as may be required by them to save each of them harmless and, in case of destruction, loss or theft, evidence satisfactory to the Company and the Trustee of the destruction, loss or theft of such Security and the ownership thereof.

Every substituted Security issued pursuant to the provisions of this Section 2.07 by virtue of the fact that any Security is destroyed, lost or stolen shall constitute an additional contractual obligation of the Company, whether or not the destroyed, lost or stolen Security shall be found at any time, and shall be entitled to all the benefits of this Indenture equally and proportionately with any and all other Securities of the same series duly issued hereunder. All Securities shall be held and owned upon the express condition that the foregoing provisions are exclusive with respect to the replacement or payment of mutilated, destroyed, lost or stolen Securities and shall preclude (to the extent lawful) any and all other rights or remedies with respect to the replacement or payment of negotiable instruments or other securities without their surrender.

Section 2.08. *Temporary Securities.* Pending the preparation of definitive Securities of any series the Company may execute and the Trustee shall authenticate and deliver temporary Securities (printed, lithographed or typewritten). Temporary Securities shall be issuable in any authorized denomination and substantially in the form of the definitive Securities in lieu of which they are issued, but with such omissions, insertions and variations as may be appropriate for temporary Securities, all as may be determined by the Company. Every such temporary Security shall be authenticated by the Trustee upon the same conditions and in substantially the same manner, and with the same effect, as the definitive Securities in lieu of which they are issued. Without unreasonable delay the Company will execute and deliver to the Trustee definitive Securities of such series and thereupon any or all temporary Securities of such series may be surrendered in exchange therefor, at the option of the holders thereof, either at the office or agency to be designated and maintained by the

Company for such purpose in the Borough of Manhattan, The City of New York, in accordance with the provisions of Section 4.02 or at any of such other offices or agencies as may be designated and maintained by the Company for such purpose in accordance with the provisions of Section 4.02, and the Trustee shall authenticate and deliver in exchange for such temporary Securities an equal aggregate principal amount of definitive Securities of the same series. Such exchange shall be made by the Company at its own expense and without any charge therefor. Until so exchanged, the temporary Securities of any series shall in all respects be entitled to the same benefits under this Indenture as definitive Securities of the same series authenticated and delivered hereunder.

Section 2.09. *Cancellation of Securities Paid, etc.* All Securities surrendered for the purpose of payment, redemption, repayment, exchange or registration of transfer or for credit against any sinking fund shall, if surrendered to the Company, any Security registrar, any paying agent or any other agent of the Company or of the Trustee, be delivered to the Trustee and promptly cancelled by it, or, if surrendered to the Trustee, shall be promptly cancelled by it, and no Securities shall be issued in lieu thereof except as expressly permitted by any of the provisions of this Indenture. The Trustee may dispose of cancelled Securities in accordance with its customary procedures and deliver a certificate of such disposition to the Company or, at the written request of the Company, shall deliver cancelled Securities to the Company. If the Company shall acquire any of the Securities, however, such acquisition shall not operate as a redemption or satisfaction of the indebtedness represented by such Securities unless and until the same are delivered to the Trustee for cancellation.

Section 2.10. *Computation of Interest.* Except as otherwise specified as contemplated by Section 2.02 for Securities of any series, interest on the Securities of each series shall be computed on the basis of a 360-day year of twelve 30-day months.

Section 2.11. *Form of Legend for Global Securities.* Unless otherwise specified as contemplated by Section 2.02 for the Securities evidenced thereby, every Global Security authenticated and delivered hereunder shall bear a legend in substantially the following form (or such other form as a securities exchange or Depository may request or require):

THIS SENIOR NOTE IS A GLOBAL SECURITY WITHIN THE MEANING OF THE INDENTURE HEREINAFTER REFERRED TO AND IS REGISTERED IN THE NAME OF THE DEPOSITORY TRUST COMPANY OR A NOMINEE OF THE DEPOSITORY TRUST COMPANY. THIS SENIOR NOTE IS EXCHANGEABLE FOR SECURITIES REGISTERED IN THE NAME OF A PERSON OTHER THAN THE DEPOSITORY TRUST COMPANY OR ITS NOMINEE ONLY IN THE LIMITED CIRCUMSTANCES DESCRIBED IN THE INDENTURE AND MAY NOT BE TRANSFERRED EXCEPT AS A WHOLE BY THE DEPOSITORY TRUST COMPANY TO A

NOMINEE OF THE DEPOSITORY TRUST COMPANY OR BY A NOMINEE OF THE DEPOSITORY TRUST COMPANY TO THE DEPOSITORY TRUST COMPANY OR ANOTHER NOMINEE OF THE DEPOSITORY TRUST COMPANY.

UNLESS THIS CERTIFICATE IS PRESENTED BY AN AUTHORIZED REPRESENTATIVE OF THE DEPOSITORY TRUST COMPANY, A NEW YORK CORPORATION ("DTC"), TO THE ISSUER OR ITS AGENT FOR REGISTRATION OF TRANSFER, EXCHANGE, OR PAYMENT, AND ANY CERTIFICATE ISSUED IS REGISTERED IN THE NAME OF CEDE & CO. OR IN SUCH OTHER NAME AS IS REQUESTED BY AN AUTHORIZED REPRESENTATIVE OF DTC (AND ANY PAYMENT IS MADE TO CEDE & CO. OR TO SUCH OTHER ENTITY AS IS REQUESTED BY AN AUTHORIZED REPRESENTATIVE OF DTC), ANY TRANSFER, PLEDGE, OR OTHER USE HEREOF FOR VALUE OR OTHERWISE BY OR TO ANY PERSON IS WRONGFUL INASMUCH AS THE REGISTERED OWNER HEREOF, CEDE & CO., HAS AN INTEREST HEREIN.

### ARTICLE 3 REDEMPTION OF SECURITIES; SINKING FUNDS

Section 3.01. *Applicability of Article.* The provisions of this Article shall be applicable, as the case may be, (i) to the Securities of any series which are redeemable before their maturity and (ii) to any sinking fund for the retirement of Securities of any series, in either case except as otherwise specified as contemplated by Section 2.02 for Securities of such series.

The minimum amount of any sinking fund payment provided for by the terms of Securities of any series is herein referred to as a "mandatory sinking fund payment", and any payment in excess of such minimum amount provided for by the terms of Securities of any series is herein referred to as an "optional sinking fund payment".

Section 3.02. *Notice of Redemption; Selection of Securities.* In case the Company shall desire to exercise any right to redeem all, or, as the case may be, any part of, the Securities of any series in accordance with their terms, it shall fix a date for redemption and shall mail a notice of such redemption at least 30 and not more than 60 days prior to the date fixed for redemption to the holders of Securities of such series so to be redeemed as a whole or in part at their last addresses as the same appear on the registry books of the Company and to the Trustee, except as the resolutions adopted by the Board of Directors to establish the terms of any series of Securities may otherwise provide. Such mailing shall be by first class mail. The notice if mailed in the manner herein provided shall be conclusively presumed to have been duly given, whether or not the holder receives such notice. In any case, failure to give such notice by mail or any defect

in the notice to the holder of any Security of a series designated for redemption as a whole or in part shall not affect the validity of the proceedings for the redemption of any other Security of such series.

Each such notice of redemption shall specify the date fixed for redemption, the redemption price at which the Securities of such series are to be redeemed (or if not then ascertainable, the manner of calculation thereof), the place or places of payment, that payment will be made upon presentation and surrender of such Securities, that any interest accrued to the date fixed for redemption will be paid as specified in said notice, and that on and after said date any interest thereon or on the portions thereof to be redeemed will cease to accrue. Where the redemption price is not ascertainable at the time the notice of redemption is given as aforesaid, the Company shall notify the Trustee of said redemption price promptly after the calculation thereof. If less than all the Securities of a series are to be redeemed the notice of redemption shall specify the number or numbers of the Securities of that series to be redeemed. In case any Security of a series is to be redeemed in part only, the notice of redemption shall state the portion of the principal amount thereof to be redeemed and shall state that on and after the date fixed for redemption, upon surrender of such Security, a new Security or Securities of that series in principal amount equal to the unredeemed portion thereof will be issued.

Prior to the redemption date specified in the notice of redemption given as provided in this Section 3.02, the Company will deposit with the Trustee or with one or more paying agents (or if the Company is acting as its own paying agent will segregate and hold in trust as provided in Section 4.04) an amount of money sufficient to redeem on the redemption date all the Securities or portions thereof so called for redemption, together with accrued interest to the date fixed for redemption. If less than all the Securities of a series are to be redeemed the Company will give the Trustee notice not less than 60 days (or such shorter period as may be acceptable to the Trustee) prior to the redemption date as to the aggregate principal amount of Securities of such series to be redeemed and the Trustee shall select or cause to be selected, in such manner as in its sole discretion it shall deem appropriate and fair, the Securities of that series or portions thereof to be redeemed. Securities of a series may be redeemed in part only in

multiples of the smallest authorized denomination of that series.

Section 3.03. *Payment of Securities Called for Redemption.* If notice of redemption has been given as provided in Section 3.02 or Section 3.05, the Securities or portions of Securities of the series with respect to which such notice has been given shall become due and payable on the date and at the place or places stated in such notice at the applicable redemption price, together with any interest accrued to the date fixed for redemption, and on and after said date (unless the Company shall default in the payment of such Securities or portions of such Securities, together with any interest accrued to said date) any interest on the Securities of such series or portions of Securities of such series so called for

18

---

redemption shall cease to accrue. On presentation and surrender of such Securities at a place of payment in said notice specified, the said Securities or the specified portions thereof shall be paid and redeemed by the Company at the applicable redemption price, together with any interest accrued thereon to the date fixed for redemption; *provided, however,* that any regularly scheduled installment of interest becoming due on or prior to the date fixed for redemption shall be payable to holders of such Securities registered as such on the relevant record date according to their terms.

Upon presentation of any Security redeemed in part only, the Company shall execute and the Trustee shall authenticate and deliver to the holder thereof, at the expense of the Company, a new Security or Securities of the same series, of authorized denominations, in aggregate principal amount equal to the unredeemed portion of the Security so presented.

Section 3.04. *Satisfaction of Mandatory Sinking Fund Payments with Securities.* In lieu of making all or any part of any mandatory sinking fund payment with respect to any Securities of a series in cash, the Company may at its option (a) deliver to the Trustee Securities of that series theretofore purchased or otherwise acquired by the Company, or (b) receive credit for the principal amount of Securities of that series which have been redeemed either at the election of the Company pursuant to the terms of such Securities or through the application of permitted optional sinking fund payments pursuant to the terms of such Securities; *provided* that such Securities have not been previously so credited. Such Securities shall be received and credited for such purpose by the Trustee at the redemption price specified in such Securities for redemption through operation of the sinking fund and the amount of such mandatory sinking fund payment shall be reduced accordingly.

Section 3.05. *Redemption of Securities for Sinking Fund.* Not less than 60 days prior to each sinking fund payment date for any series of Securities, the Company will deliver to the Trustee a certificate signed by the Treasurer or any Assistant Treasurer of the Company specifying the amount of the next ensuing sinking fund payment for that series pursuant to the terms of that series, the portion thereof, if any, which is to be satisfied by payment of cash (which cash may be deposited with the Trustee or with one or more paying agents, or if the Company is acting as its own paying agent segregated and held in trust as provided in Section 4.04) and the portion thereof, if any, which is to be satisfied by delivering and crediting Securities of that series pursuant to Section 3.04 (which Securities, if not theretofore delivered, will accompany such certificate) and whether the Company intends to exercise its right to make a permitted optional sinking fund payment with respect to such series. Such certificate shall also state that no Event of Default has occurred and is continuing with respect to such series. Such certificate shall be irrevocable and upon its delivery the Company shall be obligated to make the cash payment or payments therein referred to, if any, on or before the next succeeding sinking fund payment date. In

19

---

the case of the failure of the Company to deliver such certificate (or to deliver the Securities specified in this paragraph), the sinking fund payment due on the next succeeding sinking fund payment date for that series shall be paid entirely in cash and shall be sufficient to redeem the principal amount of such Securities subject to a mandatory sinking fund payment without the option to deliver or credit Securities as provided in Section 3.04 and without the right to make any optional sinking fund payment, if any, with respect to such series.

Any sinking fund payment or payments (mandatory or optional) made in cash plus any unused balance of any preceding sinking fund payments made in cash which shall equal or exceed \$100,000 or the equivalent amount in the Specified Currency (if other than Dollars) (or a lesser sum if the Company shall so request or determine) with respect to the Securities of any particular series shall be applied by the Trustee (or by the Company if the Company is acting as its own paying agent) on the sinking fund payment date on which such payment is made (or, if such payment is made before a sinking fund payment date, on the next sinking fund payment date following the date of such payment) to the redemption of such Securities at the redemption price specified in such Securities for operation of the sinking fund together with accrued interest, if any, to the date fixed for redemption. Any sinking fund moneys not so applied or allocated by the Trustee (or by the Company if the Company is acting as its own paying agent) to the redemption of Securities shall be added to the next cash sinking fund payment received by the Trustee (or if the Company is acting as its own paying agent, segregated and held in trust as provided in Section 4.04) for such series and, together with such payment (or such amount so segregated), shall be applied in accordance with the provisions of this Section 3.05. Any and all sinking fund moneys with respect to the Securities of any particular series held by the Trustee (or if the Company is acting as its own paying agent, segregated and held in trust as provided in Section 4.04) on the last sinking fund payment date with respect to Securities of such series and not held for the payment or redemption of particular Securities of such series shall be applied by the Trustee (or by the Company if the Company is acting as its own paying agent), together with other moneys, if necessary, to be deposited (or segregated) sufficient for the purpose, to the payment of the principal of the Securities of that series at maturity.

The Trustee shall select or cause to be selected the Securities to be redeemed upon such sinking fund payment date in the manner specified in the last paragraph of Section 3.02 and the Company shall cause notice of the redemption thereof to be given in the manner provided in Section 3.02 except that the notice of redemption shall also state that the Securities are being redeemed by operation of the sinking fund. Such notice having been duly given, the redemption of such Securities shall be made upon the terms and in the manner stated in Section 3.03.

On or before each sinking fund payment date, the Company shall pay to the Trustee in cash (or if the Company is acting as its own paying agent will segregate and hold in trust as provided in Section 4.04) a sum equal to any interest

20

---

accrued to the date fixed for redemption of Securities or portions thereof to be redeemed on such sinking fund payment date pursuant to this Section.

Neither the Trustee nor the Company shall redeem any Securities of a series with sinking fund moneys or mail any notice of redemption of such Securities by operation of the sinking fund for such series during the continuance of a default in payment of interest, if any, on such Securities or of any Event of Default (other than an Event of Default occurring as a consequence of this paragraph) with respect to such Securities, except that if the notice of redemption of any such Securities shall theretofore have been mailed in accordance with the provisions hereof, the Trustee (or the Company if the Company is acting as its own paying agent) shall redeem such Securities if cash sufficient for that purpose shall be deposited with the Trustee (or segregated by the Company) for that purpose in accordance with the terms of this Article. Except as aforesaid, any moneys in the sinking fund for such series at the time when any such default or Event of Default shall occur and any moneys thereafter paid into such sinking fund shall, during the continuance of such default or Event of Default, be held as security for the payment of such Securities; *provided, however,* that in case such default or Event of Default shall have been cured or waived as provided herein, such moneys shall thereafter be applied on the next sinking fund payment date for such Securities on which such moneys may be applied pursuant to the provisions of this Section.

Section 3.06. *Repayment at the Option of the Holder.* Any series of Securities may be made, by provision contained in or established pursuant to a supplemental indenture or a resolution of the Board of Directors pursuant to Section 2.02 hereof, subject to repayment, in whole or in part, at the option of the holder on a date or dates



specified prior to maturity, at a price equal to 100% of the principal amount thereof, together with accrued interest to the date of repayment, on such notice as may be required, provided, however, that the holder of a Security may only elect partial repayment in an amount that will result in the portion of such Security that will remain Outstanding after such repayment constituting an authorized denomination, or combination thereof, of such Securities.

ARTICLE 4  
PARTICULAR COVENANTS OF THE COMPANY

Section 4.01. *Payment of Principal, Premium and Interest.* The Company covenants and agrees for the benefit of each series of Securities that it will duly and punctually pay or cause to be paid the principal of, premium, if any, and interest, if any, on each of the Securities of that series at the places, at the respective times and in the manner provided in such Securities.

21

---

Section 4.02. *Offices for Notices and Payments, etc.* As long as any of the Securities of a series remain Outstanding, the Company will designate and maintain in the Borough of Manhattan, The City of New York, an office or agency where the Securities of that series may be presented for payment, an office or agency where the Securities of that series may be presented for registration of transfer and for exchange as in this Indenture provided and an office or agency where notices and demands to or upon the Company in respect of the Securities of that series or of this Indenture may be served. In addition to such office or offices or agency or agencies, the Company may from time to time designate and maintain one or more additional offices or agencies within or outside the Borough of Manhattan, The City of New York, where the Securities of that series may be presented for registration of transfer or for exchange, and the Company may from time to time rescind such designation, as it may deem desirable or expedient. The Company will give to the Trustee written notice of the location of each such office or agency and of any change of location thereof. In case the Company shall fail to maintain any such office or agency in the Borough of Manhattan, The City of New York, or shall fail to give such notice of the location or of any change in the location thereof, presentations and demands may be made and notices may be served at the principal office of the Trustee.

The Company hereby initially designates the office of the Trustee located at 101 Barclay Street, 8W, New York, New York 10286 as the office or agency of the Company in the Borough of Manhattan, The City of New York, where the Securities of each series may be presented for payment, for registration of transfer and for exchange as in this Indenture provided and where notices and demands to or upon the Company in respect of the Securities of each series or of this Indenture may be served.

Section 4.03. *Appointment to Fill Vacancies in Trustee's Office.* The Company, whenever necessary to avoid or fill a vacancy in the office of Trustee, will appoint, in the manner provided in Section 7.10, a successor trustee, so that there shall at all times be a Trustee with respect to each series of Securities hereunder.

Section 4.04. *Provision as to Paying Agent.* (a) If the Company shall appoint a paying agent other than the Trustee with respect to the Securities of any series, it will cause such paying agent to execute and deliver to the Trustee an instrument in which such agent shall agree with the Trustee, subject to the provisions of this Section 4.04:

(1) that it will hold all sums held by it as such agent for the payment of the principal of, premium, if any, or interest, if any, on the Securities of such series (whether such sums have been paid to it by the Company or by any other obligor on the Securities of such series) in trust for the benefit of the holders of the Securities of such series;

22

---

(2) that it will give the Trustee notice of any failure by the Company (or by any other obligor on the Securities of such series) to make any payment of the principal of, premium, if any, or interest, if any, on the Securities of such series when the same shall be due and payable; and

(3) that at any time during the continuance of any failure by the Company (or by any other obligor on the Securities of such series) specified in the preceding paragraph (2), such payment agent will, upon the written request of the Trustee, forthwith pay to the Trustee all sums so held in trust by it.

(b) If the Company shall act as its own paying agent with respect to the Securities of any series, it will, on or before each due date of the principal of, premium, if any, or interest, if any, on the Securities of such series, set aside, segregate and hold in trust for the benefit of the holders of such Securities a sum sufficient to pay such principal, premium, if any, or interest, if any, so becoming due and will promptly notify the Trustee of any failure to take such action and of any failure by the Company (or by any other obligor on the Securities of such series) to make any payment of the principal of, premium, if any, or interest, if any, on the Securities of such series when the same shall become due and payable.

(c) Anything in this Section 4.04 to the contrary notwithstanding, the Company may, at any time, for the purpose of obtaining a satisfaction and discharge of this Indenture, or for any other reason, pay or cause to be paid to the Trustee all sums held in trust by it, or any paying agent hereunder, as required by this Section, such sums to be held by the Trustee upon the trusts herein contained.

(d) Anything in this Section 4.04 to the contrary notwithstanding, the agreement to hold sums in trust as provided in this Section 4.04 is subject to Sections 12.05 and 12.06.

(e) Whenever the Company shall have one or more paying agents with respect to the Securities of any series, it will, prior to each due date of the principal of, premium, if any, or interest, if any, on the Securities of such series, deposit with a designated paying agent a sum sufficient to pay the principal, premium, if any, and interest, if any, so becoming due, such sum to be held in trust for the benefit of the persons entitled to such principal, premium, if any, or interest, if any, and (unless such paying agent is the Trustee) the Company will promptly notify the Trustee of any failure so to act.

Section 4.05. *Statement as to Compliance.* The Company will furnish to the Trustee on or before June 1, in each year (beginning with the first June 1 following the first date of issuance of any Securities under this Indenture) the brief certificate (which need not comply with Section 14.05) from the principal executive, financial or accounting officer of the Company required by Section 314(a)(4) of the Trust Indenture Act of 1939.

23

---

Section 4.06. *Additional Amounts.* If the Securities of a series provide for the payment of additional amounts, at least 10 days prior to the first interest payment date with respect to that series of Securities and at least 10 days prior to each date of payment of principal of, premium, if any, or interest on the Securities of that series if there has been a change with respect to the matters set forth in the below-mentioned Officers' Certificate, the Company shall furnish to the Trustee and the principal paying agent, if other than the Trustee, an Officers' Certificate instructing the Trustee and such paying agent whether such payment of principal of or interest on the Securities of that series shall be made to holders of the Securities of that series without withholding or deduction for or on account of any tax, assessment or other governmental charge described in the Securities of that series. If any such withholding or deduction shall be required, then such Officers' Certificate shall specify by country the amount, if any, required to be withheld or deducted on such payments to such holders and shall certify the fact that additional amounts will be payable and the amounts so payable to each holder, and the Company shall pay to the Trustee or such paying agent the additional amounts required to be paid by this Section. The Company covenants to indemnify the Trustee and any paying agent for, and to hold them harmless against, any loss, liability or expense reasonably incurred without negligence or bad faith on their part arising out of or in connection with actions taken or omitted by any of them in reliance on any Officers' Certificate furnished pursuant to this Section.

Whenever in this Indenture there is mentioned, in any context, the payment of the principal of or any premium, interest or any other amounts on, or in respect of, any Security of any series, such mention shall be deemed to include mention of the payment of additional amounts provided by the terms of such series established hereby or pursuant hereto to the extent that, in such context, additional amounts are, were or would be payable in respect thereof pursuant to such terms, and express mention of the payment of additional amounts (if applicable) in any provision hereof shall not be construed as excluding the payment of additional amounts in those provisions hereof where such express mention is not made.

ARTICLE 5  
SECURITYHOLDER LISTS AND REPORTS BY THE COMPANY AND THE TRUSTEE

Section 5.01. *Securityholder Lists.* If and so long as the Trustee shall not be the Security registrar for the Securities of any series, the Company and any other obligor on the Securities will furnish or cause to be furnished to the Trustee a list in such form as the Trustee may reasonably require of the names and addresses of the holders of the Securities of such series pursuant to Section 312 of the Trust Indenture Act of 1939 (a) semi-annually not more than 15 days after each record date for the payment of interest on such Securities, as hereinabove specified, as of such record date, and on dates to be determined pursuant to

24

---

Section 2.02 for non-interest bearing Securities in each year, and (b) at such other times as the Trustee may request in writing, within thirty days after receipt by the Company of any such request as of a date not more than 15 days prior to the time such information is furnished.

Section 5.02. *Reports by the Company.* The Company covenants to file with the Trustee, within 15 days after the Company is required to file the same with the Securities and Exchange Commission, copies of the annual reports and of the information, documents and other reports that the Company may be required to file with the Securities and Exchange Commission pursuant to Section 13 or Section 15(d) of the Securities Exchange Act of 1934 or pursuant to Section 314 of the Trust Indenture Act of 1939.

Delivery of such reports, information and documents to the Trustee is for informational purposes only and the Trustee's receipt of such shall not constitute constructive notice of any information contained therein, including the Company's compliance with any of its covenants hereunder (as to which the Trustee is entitled to rely exclusively on Officers' Certificates).

Section 5.03. *Reports by the Trustee.* Any Trustee's report required under Section 313(a) of the Trust Indenture Act of 1939 shall be transmitted on or before March 15 in each year beginning March 15, 2005, as provided in Section 313(c) of the Trust Indenture Act of 1939, so long as any Securities are Outstanding hereunder, and shall be dated as of a date convenient to the Trustee no more than 60 days prior thereto.

ARTICLE 6  
REMEDIES OF THE TRUSTEE AND SECURITYHOLDERS ON EVENT OF DEFAULT

Section 6.01. *Events of Default.* The term "Event of Default" whenever used herein with respect to Securities of any series means any one of the following events and such other events as may be established with respect to the Securities of such series as contemplated by Section 2.02 hereof, continued for the period of time, if any, and after the giving of notice, if any, designated in this Indenture or as may be established with respect to such Securities as contemplated by Section 2.02 hereof, as the case may be, unless it is either inapplicable or is specifically deleted or modified in the applicable resolution of the Board of Directors or in the supplemental indenture under which such series of Securities is issued, as the case may be, as contemplated by Section 2.02:

(a) default in the payment of any installment of interest upon any Security of such series as and when the same shall become due and payable, and continuance of such default for a period of 30 days; or

25

---

(b) default in the payment of the principal of, or premium, if any, on any Security of such series as and when the same shall become due and payable whether at maturity, upon redemption, by declaration, repayment or otherwise; or

(c) default in the making or satisfaction of any sinking fund payment or analogous obligation as and when the same shall become due and payable by the terms of the Securities of such series; or

(d) failure on the part of the Company duly to observe or perform any other of the covenants or agreements on the part of the Company in respect of the Securities of such series contained in this Indenture (other than a covenant or agreement in respect of the Securities of such series a default in whose observance or performance is elsewhere in this Section 6.01 specifically dealt with) continued for a period of 60 days after the date on which written notice of such failure, requiring the Company to remedy the same, shall have been given to the Company by the Trustee by registered mail, or to the Company and the Trustee by the holders of at least twenty-five percent in aggregate principal amount of the Securities of such series at the time Outstanding; or

(e) an event of default with respect to any other series of Securities issued or hereafter issued pursuant to this Indenture or as defined in any indenture or instrument evidencing or under which the Company has at the date of this Indenture or shall hereafter have outstanding any indebtedness for borrowed money shall happen and be continuing and such other series of Securities or such indebtedness, as the case may be, shall have been accelerated so that the same shall be or become due and payable prior to the date on which the same would otherwise have become due and payable, and the aggregate principal amount of any indebtedness with respect to which such acceleration has occurred exceeds \$100,000,000, and such acceleration shall not be rescinded or annulled within ten days after written notice thereof shall have been given to the Company by the Trustee or to the Company and the Trustee by the holders of at least twenty-five percent in aggregate principal amount of the Securities of such series at the time Outstanding; *provided, however,* that if such event of default with respect to such other series of Securities or under such indenture or instrument, as the case may be, shall be remedied or cured by the Company, or waived by the holders of such other series of Securities or of such indebtedness, as the case may be, then the Event of Default hereunder by reason thereof shall be deemed likewise to have been thereupon remedied, cured or waived without further action upon the part of either the Trustee or any of the Securityholders of such series; and *provided further that,* subject to the provisions of Sections 6.08 and 7.01, the Trustee shall not be charged with knowledge of any such event of default or any remedy, cure or waiver thereof or any such acceleration unless written notice thereof shall have been given to the Trustee by the Company, by a holder or an agent of a holder of any Securities of such other series or of any such indebtedness, as the case may be, or by the Trustee then acting under this Indenture with respect to such other series of Securities or under any other indenture or instrument, as the case may be,

26

---

under which such event of default shall have occurred, or by the holders of at least twenty-five percent in aggregate principal amount of the Securities of such series at the time Outstanding; or

(f) a decree or order by a court having jurisdiction in the premises shall have been entered adjudging the Company or any of its Significant Subsidiaries

bankrupt or insolvent, or approving as properly filed a petition seeking reorganization of the Company or any of its Significant Subsidiaries under the Federal Bankruptcy Code or any other similar applicable Federal or State law, and such decree or order shall have continued undischarged and unstayed for a period of 60 days; or a decree or order of a court having jurisdiction in the premises for the appointment of a receiver or liquidator or trustee or assignee (or other similar official) in bankruptcy or insolvency of the Company or any of its Significant Subsidiaries or of all or substantially all of the property of the Company or any of its Significant Subsidiaries, or for the winding up or liquidation of the affairs of the Company or any of its Significant Subsidiaries, shall have been entered, and such decree or order shall have continued undischarged and unstayed for a period of 60 days; or

(g) the Company or any of its Significant Subsidiaries shall institute proceedings to be adjudicated a voluntary bankrupt, or shall consent to the filing of a bankruptcy proceeding against the Company or such Significant Subsidiary, or shall file a petition or answer or consent seeking reorganization under the Federal Bankruptcy Code or any other similar applicable Federal or State law, or shall consent to the filing of any such petition, or shall consent to the appointment of a receiver or liquidator or trustee or assignee (or other similar official) in bankruptcy or insolvency of it or of its property, or shall make an assignment for the benefit of creditors, or shall admit in writing the inability of the Company or such Significant Subsidiary to pay its debts generally as they become due; or

(h) any other Event of Default provided in the applicable resolution of the Board of Directors or in the supplemental indenture under which such series of Securities is issued, as the case may be, as contemplated by Section 2.02.

If an Event of Default as contemplated by Sections 6.01(f) or 6.01(g) occurs, the principal amount (or, if the Securities of such series are Original Issue Discount Securities, such portions of the principal amount as may be specified in the terms of such series) with respect to Securities of any series at the time Outstanding will become due and payable immediately. If any other Event of Default with respect to Securities of any series at the time Outstanding occurs and is continuing, then and in each and every such case, unless the principal of all of the Securities of such series shall have already become due and payable, either the Trustee or the holders of not less than twenty-five percent in aggregate principal amount of the Securities of such series then Outstanding hereunder, by notice in writing to the Company (and to the Trustee if given by Securityholders of such series), may declare the principal amount (or, if the Securities of such series are

---

27

Original Issue Discount Securities, such portion of the principal amount as may be specified in the terms of such series) of all the Securities of such series to be due and payable immediately, and upon any such declaration the same shall become and shall be immediately due and payable, anything in this Indenture or in the Securities of such series contained to the contrary notwithstanding. This provision, however, is subject to the condition that if, at any time after the principal amount (or, if the Securities of such series are Original Issue Discount Securities, such portion of the principal amount as may be specified in the terms of such series) of the Securities of any series shall have been so declared or otherwise become due and payable, and before any judgment or decree for the payment of the moneys due shall have been obtained or entered as hereinafter provided, the Company shall pay or shall deposit with the Trustee a sum sufficient to pay all matured installments of interest, if any, upon all of the Securities of such series and the principal of, and premium, if any, on any and all Securities of such series which shall have become due otherwise than by acceleration (with interest on overdue installments of interest (to the extent that payment of such interest is enforceable under applicable law) and on such principal at the Overdue Rate applicable to such series, to the date of such payment or deposit) and all amounts payable to the Trustee pursuant to the provisions of Section 7.06, and any and all defaults under this Indenture with respect to such series of Securities, other than the nonpayment of principal of and accrued interest on Securities of such series which shall have become due solely by acceleration, shall have been remedied or cured or waived or provision shall have been made therefor to the satisfaction of the Trustee - then and in every such case the holders of a majority in aggregate principal amount of the Securities of such series then Outstanding, by written notice to the Company and to the Trustee, may waive all defaults with respect to such series and rescind and annul such declaration or acceleration and its consequences; but no such waiver or rescission and annulment shall extend to or shall affect any subsequent default or shall impair any right consequent thereon.

In case the Trustee shall have proceeded to enforce any right under this Indenture and such proceeding shall have been discontinued or abandoned because of such rescission or annulment or for any other reason or shall have been determined adversely to the Trustee, then and in every such case the Company and the Trustee shall be restored respectively to their several positions and rights hereunder, and all rights, remedies and powers of the Company and the Trustee shall continue as though no such proceeding had been taken.

Section 6.02. *Payment of Securities on Default; Suit Therefor.* The Company covenants that (a) in case default shall be made in the payment of any installment of interest upon any Security of any series as and when the same shall become due and payable, and such default shall have continued for a period of 30 days, (b) in case default shall be made in the payment of the principal of, or premium, if any, on any Security of any series as and when the same shall become due and payable, whether at maturity of the Securities of that series or upon

---

28

redemption or by declaration, repayment or otherwise or (c) in case of default in the making or satisfaction of any sinking fund payment or analogous obligation when the same becomes due by the terms of the Securities of any series - then, upon demand of the Trustee, the Company will pay to the Trustee, for the benefit of the holder of any such Security (or holders of any series of Securities in the case of clause (c) above) the whole amount that then shall have become due and payable on any such Security (or Securities of any such series in the case of clause (c) above) for principal, premium, if any, and interest, if any, with interest upon the overdue principal and premium, if any, and (to the extent that payment of such interest is enforceable under applicable law) upon the overdue installments of interest, if any, at the Overdue Rate applicable to any such Security (or Securities of any such series in the case of clause (c) above); and, in addition thereto, such further amount as shall be sufficient to cover costs and expenses of collection, and any further amounts payable to the Trustee pursuant to the provisions of Section 7.06.

In case the Company shall fail forthwith to pay such amounts upon such demand, the Trustee, in its own name and as trustee of any express trust, shall be entitled and empowered to institute any actions or proceedings at law or in equity for the collection of the sums so due and unpaid, and may prosecute any such action or proceeding to judgment or final decree, and may enforce any such judgment or final decree against the Company or any other obligor upon such Securities and collect in the manner provided by law out of the property of the Company or any other obligor on such Securities wherever situated the moneys adjudged or decreed to be payable.

In case there shall be pending proceedings for the bankruptcy, for the insolvency or for the reorganization of the Company or any other obligor on the Securities of any series under the Federal Bankruptcy Code or any other similar applicable Federal or State law, or in case a receiver or trustee (or other similar official) shall have been appointed for the property of the Company or such other obligor, or in the case of any other similar judicial proceedings relative to the Company or other obligor on the Securities of any series, or to the creditors or property of the Company or such other obligor, the Trustee, irrespective of whether the principal of the Securities of any series shall then be due and payable as therein expressed or by declaration or otherwise and irrespective of whether the Trustee shall have made any demand pursuant to the provisions of this Section 6.02, shall be entitled and empowered, by intervention in such proceedings or otherwise, to file and prove a claim or claims for the whole amount of principal (or, if the Securities of any series are Original Issue Discount Securities, such portion of the principal amount as may be due and payable with respect to such series pursuant to a declaration in accordance with Section 6.01), premium, if any, and interest, if any, owing and unpaid in respect of the Securities of any series and, in case of any judicial

---

29

proceedings, to file such proofs of claim and other papers or documents as may be necessary or advisable in order to have the claims of the Trustee and of the Securityholders of any series allowed in such judicial proceedings relative to the Company or any other obligor on the Securities of any series, its or their creditors, or its or their property, and

to collect and receive any moneys or other property payable or deliverable on any such claims, and to distribute the same after the deduction of costs and expenses of collection, and any further amounts payable to the Trustee pursuant to the provisions of Section 7.06 and incurred by it up to the date of such distribution; and any receiver, assignee or trustee (or other similar official) in bankruptcy or reorganization is hereby authorized by each of the Securityholders to make such payments to the Trustee, and, in the event that the Trustee shall consent to the making of such payments directly to the Securityholders, to pay to the Trustee costs and expenses of collection and any further amounts payable to the Trustee pursuant to the provisions of Section 7.06 and incurred by it up to the date of such distribution.

Nothing herein contained shall be deemed to authorize the Trustee to authorize or consent to or accept or adopt on behalf of any Securityholder any plan of reorganization, arrangement, adjustment or composition affecting any of the Securities of any series or the rights of any holder thereof, or to authorize the Trustee to vote in respect of the claim of any Securityholder in any such proceeding.

All rights of action and of asserting claims under this Indenture, or under the Securities of any series, may be enforced by the Trustee without the possession of any of the Securities of such series or the production thereof in any trial or other proceeding relative thereto, and any such suit or proceeding instituted by the Trustee shall be brought in its own name as trustee of an express trust, and any recovery of judgment shall be for the ratable benefit of the holders of the Securities in respect of which such action was taken. In any proceedings brought by the Trustee (and also any proceedings in which a declaratory judgment of a court may be sought as to the interpretation or construction of any provision of this Indenture, to which the Trustee shall be a party) the Trustee shall be held to represent all the holders of the Securities to which such proceedings relate, and it shall not be necessary to make any holders of such Securities parties to any such proceedings.

Section 6.03. *Application of Moneys Collected by Trustee.* Any moneys collected by the Trustee pursuant to this Article and, after an Event of Default has occurred, any money or other property distributable in respect of the Company's obligations under the Indenture shall be applied in the order following, at the date or dates fixed by the Trustee for the distribution of such moneys, upon presentation of the several Securities in respect of which moneys have been collected, and the notation thereon of the payment, if only partially paid, and upon surrender thereof if fully paid:

FIRST: To the payment of all amounts due the Trustee (including any predecessor Trustee) pursuant to the provisions of Section 7.06;

30

---

SECOND: In case the principal of the Outstanding Securities in respect of which such moneys have been collected shall not have become due (at maturity, upon redemption, by declaration, repayment or otherwise) and be unpaid, to the payment of interest, if any, on such Securities, in the order of the maturity of the installments of such interest, with interest (to the extent that such interest has been collected by the Trustee) upon the overdue installments of interest at the Overdue Rate applicable to such Securities, such payments to be made ratably to the person entitled thereto;

THIRD: In case the principal of the Outstanding Securities in respect of which such moneys have been collected shall have become due (at maturity, upon redemption, by declaration, repayment or otherwise), to the payment of the whole amount then owing and unpaid upon such Securities for principal, premium, if any, and interest, if any, with interest on the overdue principal, and premium, if any, and (to the extent that such interest has been collected by the Trustee) upon overdue installments of interest, if any, at the Overdue Rate applicable to such Securities; and in case such moneys shall be insufficient to pay in full the whole amounts so due and unpaid upon such Securities, then to the payment of such principal, premium, if any, and interest, if any, without preference or priority of principal, and premium, if any, over interest, if any, or of interest, if any, over principal, and premium, if any, or of any installment of interest, if any, over any other installment of interest, if any, or of any such Security over any other such Security, ratably to the aggregate of such principal, premium, if any, and accrued and unpaid interest, if any; and

FOURTH: To the payment of the remainder, if any, to the Company, its successors or assigns, or to whosoever may be lawfully entitled to receive the same, or as a court of competent jurisdiction may direct.

Section 6.04. *Proceedings by Securityholders.* No holder of any Security of any series shall have any right by virtue of or by availing of any provision of this Indenture to institute any suit, action or proceeding in equity or at law upon or under or with respect to this Indenture or for the appointment of a receiver or trustee (or other similar official), or for any other remedy hereunder, unless such holder previously shall have given to the Trustee written notice of default with respect to Securities of such series and of the continuance thereof, as hereinbefore provided, and unless also the holders of not less than twenty-five percent in aggregate principal amount of the Securities of such series then Outstanding shall have made written request upon the Trustee to institute such action, suit or proceeding in its own name as Trustee hereunder and shall have offered to the Trustee such reasonable indemnity as it may require against the costs, expenses and liabilities to be incurred therein or thereby, and the Trustee for 60 days after

31

---

its receipt of such notice, request and offer of indemnity, shall not have received from the holders of a majority in principal amount of the Securities of such series then Outstanding a direction inconsistent with that request, and shall have neglected or refused to institute any such action, suit or proceeding, it being understood and intended, and being expressly covenanted by the taker and holder of every Security with every other taker and holder and the Trustee, that no one or more holders of Securities of such series shall have any right in any manner whatever by virtue of or by availing of any provision of this Indenture to affect, disturb or prejudice the rights of any other holder of Securities of such series, or to obtain or seek to obtain priority over or preference to any other such holder, or to enforce any right under this Indenture, except in the matter herein provided and for the equal, ratable and common benefit of all holders of Securities of such series.

Notwithstanding any other provisions in this Indenture, however, the right of any holder of any Security to receive payment of the principal of, premium, if any, and interest, if any, on such Security, on or after the respective due dates expressed in such Security, or upon redemption, by declaration, repayment or otherwise, or to institute suit for the enforcement of any such payment on or after such respective dates, shall not be impaired or affected without the consent of such holder, and no provision of the Securities of any series or of this Indenture shall alter or impair the obligation of the Company, which is absolute and unconditional, to pay the principal of, premium, if any, and interest, if any, on the Securities of such series at the respective places, at the respective times, at the respective rates and in the coin or currency, therein and herein prescribed.

Section 6.05. *Proceedings by Trustee.* In case of an Event of Default hereunder the Trustee may in its discretion proceed to protect and enforce the rights vested in it by this Indenture by such appropriate judicial proceedings as the Trustee shall deem most effectual to protect and enforce any of such rights, either by suit in equity or by action at law or by proceeding in bankruptcy or otherwise, whether for the specific enforcement of any covenant or agreement contained in this Indenture or in aid of the exercise of any power granted in this Indenture, or to enforce any other legal or equitable right vested in the Trustee by this Indenture or by law.

Section 6.06. *Remedies Cumulative and Continuing.* All powers and remedies given by this Article Six to the Trustee or to the Securityholders of any series shall, to the extent permitted by law, be deemed cumulative and not exclusive of any thereof or of any other powers and remedies available to the Trustee or the holders of such Securities, by judicial proceedings or otherwise, to enforce the performance or observance of the covenants and agreements contained in this Indenture, and no delay or omission of the Trustee or of any holder of any such Securities to exercise any right or power accruing upon any default occurring and continuing as aforesaid shall impair any such right or power, or shall be construed to be a waiver of any such default or an acquiescence

32

---

therein; and, subject to the provisions of Section 6.04, every power and remedy given by this Article Six or by law to the Trustee or to the Securityholders of any series may be exercised from time to time, and as often as shall be deemed expedient, by the Trustee or by the Securityholders of such series.

Section 6.07. *Direction of Proceedings and Waiver of Defaults by Securityholders.* (a) The holders of a majority in aggregate principal amount of the Securities of any series at the time Outstanding shall have the right to direct the time, method and place of conducting any proceeding for any remedy available to the Trustee, or exercising any trust or power conferred on the Trustee, with respect to the Securities of such series; *provided, however*, that (subject to the provisions of Section 7.01) the Trustee shall have the right to decline to follow any such direction if the Trustee, being advised by counsel, determines that the action or proceeding so directed may not lawfully be taken or if the Trustee in good faith by its board of directors or trustees, executive committee, or a trust committee of directors or trustees and/or Responsible Officers shall determine that the action or proceeding so directed would involve the Trustee in personal liability.

(b) Prior to any acceleration or declaration accelerating the maturity of the Securities of any series, the holders of a majority in aggregate principal amount of the Securities of such series at the time Outstanding may on behalf of the holders of all of the Securities of such series waive any past default or Event of Default with respect to such series and its consequences except a default in the payment of interest, if any, on, or the principal of or premium, if any, on any Security of such series, or in the payment of any sinking fund installment or analogous obligation with respect to Securities of such series, or in respect of a covenant or provision hereof which under Section 10.02 cannot be modified or amended without the consent of the holder of each Security affected. Upon any such waiver the Company, the Trustee and the holders of the Securities of that series shall be restored to their former positions and rights hereunder, respectively; but no such waiver shall extend to any subsequent or other default or Event of Default or impair any right consequent thereon. Whenever any default or Event of Default hereunder shall have been waived as permitted by this Section 6.07(b), said default or Event of Default shall for all purposes of the Securities of such series and this Indenture be deemed to have been cured and to be not continuing.

Section 6.08. *Notice of Defaults.* The Trustee shall, within 90 days after the occurrence of a default with respect to the Securities of any series, mail to all holders of Securities of such series, as the names and addresses of such holders appear upon the registry books of the Company, notice of all defaults with respect to such series known to the Trustee, unless such defaults shall have been cured or waived before the giving of such notice (the term "defaults" for the purpose of this Section 6.08 being hereby defined to be the events specified in Section 6.01 or established with respect to such Securities as contemplated by Section 2.02, not

33

---

including the periods of grace, if any, provided for therein or established with respect to such Securities as contemplated by Section 2.02 and irrespective of the giving of the notices specified in clauses (d) and (e) of Section 6.01 or established with respect to such Securities as contemplated by Section 2.02); *provided, however*, that except in the case of default in the payment of the principal of, premium, if any, or interest, if any, on any of the Securities of such series or in the making of any sinking fund installment or analogous obligation with respect to such series, the Trustee shall be protected in withholding such notice if and so long as the board of directors, the executive committee, or a trust committee of directors and/or Responsible Officers of the Trustee in good faith determines that the withholding of such notice is in the interest of the holders of Securities of such series.

Section 6.09. *Undertaking to Pay Costs.* All parties to this Indenture agree, and each holder of any Security by his acceptance thereof shall be deemed to have agreed, that any court may in its discretion require, in any suit for the enforcement of any right or remedy under this Indenture, or in any suit against the Trustee for any action taken, omitted or suffered by it as Trustee, the filing by any party litigant in such suit of an undertaking to pay the costs of such suit, and that such court may in its discretion assess reasonable costs, including reasonable attorneys' fees, against any party litigant in such suit, having due regard to the merits and good faith of the claims or defenses made by such party litigant; but the provisions of this Section 6.09 shall not apply to any suit instituted by the Trustee, to any suit instituted by any holder of Securities of any series or group of such holders, holding in the aggregate more than ten percent in principal amount of the Outstanding Securities of such series or to any suit instituted by any Securityholder for the enforcement of the payment of the principal of, premium, if any, or interest, if any, on any Security on or after the due date expressed in such Security, on or after the date fixed for redemption or repayment or after such Security shall have become due by declaration.

#### ARTICLE 7 CONCERNING THE TRUSTEE

Section 7.01. *Duties and Responsibilities of Trustee.* (a) With respect to the holders of any series of Securities issued hereunder, the Trustee, prior to the occurrence of an Event of Default with respect to the Securities of such series and after the curing or waiving of all Events of Default which may have occurred with respect to such series,

(1) undertakes to perform such duties and only such duties as are specifically set forth in this Indenture and no implied covenants or obligations shall be read into this Indenture against the Trustee; and

34

---

(2) in the absence of bad faith on the part of the Trustee, the Trustee may conclusively rely, as to the truth of the statements and the correctness of the opinions expressed therein, upon any certificates or opinions furnished to the Trustee and conforming to the requirements of this Indenture; but in the case of any such certificates or opinions which by any provision hereof are specifically required to be furnished to the Trustee, the Trustee shall be under a duty to examine the same to determine whether or not they conform to the requirements of this Indenture;

(b) In case an Event of Default with respect to the Securities of a series has occurred (which has not been cured or waived), the Trustee shall exercise such of the rights and powers vested in it by this Indenture with respect to such series, and use the same degree of care and skill in their exercise, as a prudent man would exercise or use under the circumstances in the conduct of his own affairs.

(c) No provision of this Indenture shall be construed to relieve the Trustee from liability for its own negligent action, its own negligent failure to act, or its own willful misconduct, except that

(1) prior to the occurrence of an Event of Default with respect to the Securities of a series and after the curing or waiving of all Events of Default with respect to such series which may have occurred:

(i) the duties and obligations of the Trustee with respect to the Securities of a series shall be determined solely by the express provisions of this Indenture, and the Trustee shall not be liable except for the performance of such duties and obligations as are specifically set forth in this Indenture, and no implied covenants or obligations shall be read into this Indenture against the Trustee;

(ii) the Trustee shall not be liable for any error of judgment made in good faith by a Responsible Officer or Officers of the Trustee, unless it shall be proved that the Trustee was negligent in ascertaining the pertinent facts; and

(2) the Trustee shall not be liable with respect to any action taken, omitted or suffered to be taken by it in good faith in accordance with the direction of the holders of Securities of any series pursuant to Section 6.07 relating to the time, method and place of conducting any proceeding for any remedy available to the Trustee, or exercising any trust or power conferred upon the Trustee, under this Indenture with respect to Securities of such series; and

(3) This subsection shall not be construed to limit the effect of subsection (d) of this Section.

(d) None of the provisions of this Indenture shall be construed as requiring the Trustee to expend or risk its own funds or otherwise to incur any personal financial liability in the performance of any of its duties hereunder, or in the exercise of any of its rights or powers, if there shall be reasonable grounds for believing that repayment of such funds or adequate indemnity against such risk or liability is not reasonably assured to it.

(e) The provisions of this Section 7.01 are in furtherance of and subject to Section 315 of the Trust Indenture Act of 1939. Whether or not expressly provided, every provision of this Indenture relating to or affecting the liability of or affording protection to the Trustee shall be subject to the provisions of this Section.

Section 7.02. *Reliance on Documents, Opinions, etc.* In furtherance of and subject to the Trust Indenture Act of 1939, and subject to the provisions of Section 7.01:

(a) the Trustee may rely and shall be protected in acting or refraining from acting upon any resolution, certificate, statement, instrument, opinion, report, notice, request, direction, consent, order, or other paper or document believed by it to be genuine and to have been signed or presented by the proper party or parties;

(b) any request, direction, order or demand of the Company mentioned herein shall be sufficiently evidenced by an instrument signed in the name of the Company by its President, its Chairman of the Board or any Vice President and its Treasurer or its Comptroller (unless other evidence in respect thereof be herein specifically prescribed); and any resolution of the Board of Directors of the Company may be evidenced to the Trustee by a copy thereof certified by the Secretary, an Assistant Secretary or an Attesting Secretary of the Company;

(c) the Trustee may consult with counsel and the advice of such counsel or any Opinion of Counsel shall be full and complete authorization and protection in respect of any action taken, omitted or suffered to be taken by it hereunder in good faith and in reliance thereon;

(d) the Trustee shall be under no obligation to exercise any of the rights or powers vested in it by this Indenture at the request, order or direction of any of the Securityholders, pursuant to the provisions of this Indenture, unless such Securityholders shall have offered to the Trustee reasonable security or indemnity against the costs, expenses and liabilities which might be incurred therein or thereby;

(e) the Trustee shall not be liable for any action taken, omitted or suffered by it in good faith and believed by it to be authorized or within the discretion or rights or powers conferred upon it by this Indenture;

(f) the Trustee shall not be bound to make any inquiry or investigation into the facts or matters stated in any resolution, certificate, statement, instrument, opinion, report, notice, request, direction, consent, order, bond, note or other paper or document unless requested in writing so to do by the holders of a majority in aggregate principal amount of the Securities of any series affected then Outstanding; *provided, however*, that if the payment within a reasonable time to the Trustee of the costs and expenses or liabilities likely to be incurred by it in the making of such investigation is, in the opinion of the Trustee, not reasonably assured to the Trustee by the security conferred upon it by the terms of this Indenture, the Trustee may require reasonable indemnity against such costs, expenses or liabilities as a condition to so proceeding; and the reasonable expense of such investigation shall be paid by the Company, or, if paid by the Trustee, shall be repaid by the Company upon demand; and

(g) the Trustee may execute any of the trusts or powers hereunder or perform any duties hereunder either directly or by or through agents or attorneys, and the Trustee shall not be responsible for any misconduct or negligence on the part of any agent or attorney appointed with due care by it hereunder.

Section 7.03. *No Responsibility for Recitals, etc.* The recitals contained herein and in the Securities shall be taken as the statements of the Company (except in the Trustee's certificates of authentication), and the Trustee assumes no responsibility for the correctness of the same. The Trustee makes no representations as to the validity or sufficiency of this Indenture or the Securities, *provided* that the Trustee shall not be relieved of its duty to authenticate Securities only as authorized by this Indenture. The Trustee shall not be accountable for the use or application by the Company or any of the Securities or of the proceeds thereof.

Section 7.04. *Ownership of Securities.* The Trustee and any agent of the Company or of the Trustee, in its individual or any other capacity, may become the owner or pledgee of Securities with the same rights it would have if it were not Trustee or such agent.

Section 7.05. *Moneys to be Held in Trust.* Subject to the provisions of Sections 12.05 and 12.06 hereof, all moneys received by the Trustee or any paying agent shall, until used or applied as herein provided, be held in trust for the purposes for which they were received, but need not be segregated from other funds except to the extent required by law. Neither the Trustee nor any paying agent shall be under any liability for interest on any moneys received by it hereunder except such as it may agree with the Company to pay thereon. So long as no Event of Default shall have occurred and be continuing, all interest allowed

on any such moneys shall be paid from time to time upon the written order of the Company, signed by its President, Chairman or any Vice Chairman of the Board, or any Vice President, Treasurer or Comptroller.

Section 7.06. *Compensation and Expenses of Trustee.* The Company covenants and agrees to pay to the Trustee from time to time, and the Trustee shall be entitled to, reasonable compensation (which shall not be limited by any provision of law in regard to the compensation of a trustee of an express trust) and, except as otherwise expressly provided, the Company will pay or reimburse the Trustee upon its request for all reasonable expenses, disbursements and advances incurred or made by the Trustee in accordance with any of the provisions of this Indenture (including the reasonable compensation and the expenses and disbursements of its counsel and of all persons not regularly in its employ) except any such expense, disbursement or advance as may arise from its negligence or bad faith. If any property other than cash shall at any time be subject to the lien of this Indenture, the Trustee, if and to the extent authorized by a receivership or bankruptcy court of competent jurisdiction or by the supplemental instrument subjecting such property to such lien, shall be entitled to make advances for the purpose of preserving such property or of discharging tax liens or other prior liens or encumbrances thereon. The Company also covenants to indemnify the Trustee (which shall be deemed to include, without limitation, agents, employees, directors and officers of the Trustee) for, and to hold it harmless against, any loss, liability or expense incurred without negligence or bad faith on the part of the Trustee, arising out of or in connection with the acceptance or administration of this trust and its duties hereunder, including the costs and expenses of defending itself against any claim of liability in the premises. The obligations of the Company under this Section 7.06 to compensate and indemnify the Trustee and to pay or reimburse the Trustee for expenses, disbursements and advances shall constitute additional indebtedness hereunder and, together with the lien provided for in the immediately succeeding sentence, shall survive the satisfaction and discharge of this Indenture, the resignation or removal of the Trustee and the termination of this Indenture. Such additional indebtedness shall be secured by a lien prior to that of the Securities upon all property and funds held or collected by the Trustee as such, except funds held in trust for the benefit of the holders of particular Securities.

In addition to and without prejudice to its other rights hereunder, when the Trustee incurs expenses or renders services in connection with an Event of Default specified in Sections 6.01(f) or 6.01(g), the expenses (including reasonable charges and expenses of its counsel) and the compensation for the services are intended to constitute expenses of administration under any applicable Federal or state bankruptcy, insolvency or other similar law.

Section 7.07. *Officers' Certificate as Evidence.* Subject to the provisions of Sections 7.01 and 7.02, whenever in the administration of the provisions of this Indenture the Trustee shall deem it necessary or desirable that a matter be proved

38

---

or established prior to taking, omitting or suffering any action to be taken hereunder, such matter (unless other evidence in respect thereof be herein specifically prescribed) may, in the absence of negligence or bad faith on the part of the Trustee, be deemed to be conclusively proved and established by an Officers' Certificate delivered to the Trustee, and such certificate, in the absence of negligence or bad faith on the part of the Trustee, shall be full warrant to the Trustee for any action taken, omitted or suffered by it under the provisions of this Indenture upon the faith thereof.

Section 7.08. *Indentures Not Creating Potential Conflicting Interests for the Trustee.* The following indentures are hereby specifically described for the purposes of Section 310(b)(1) of the Trust Indenture Act of 1939: this Indenture with respect to the Securities of any other series.

Section 7.09. *Eligibility of Trustee.* The Trustee hereunder shall at all times be a corporation organized and doing business under the laws of the United States or any state, which (a) is authorized under such laws to exercise corporate trust powers and (b) is subject to supervision or examination by Federal or State authority and (c) shall have at all times a combined capital and surplus of not less than fifty million dollars. If such corporation publishes reports of condition at least annually, pursuant to law, or to the requirements of the aforesaid supervising or examining authority, then for the purposes of this Section 7.09, the combined capital and surplus of such corporation at any time shall be deemed to be its combined capital and surplus as set forth in its most recent report of condition so published. In case at any time the Trustee shall cease to be eligible in accordance with the provisions of this Section 7.09, the Trustee shall resign immediately in the manner and with the effect specified in Section 7.10.

The provisions of this Section 7.09 are in furtherance of and subject to Section 310(a) of the Trust Indenture Act of 1939.

Section 7.10. *Resignation or Removal of Trustee.* (a) The Trustee, or any trustee or trustees hereafter appointed, may at any time resign with respect to any one or more or all series of Securities by giving written notice of resignation to the Company and by mailing notice thereof to the holders of the applicable series of Securities at their addresses as they shall appear on the registry books of the Company. Upon receiving such notice of resignation, the Company shall promptly appoint a successor trustee or trustees with respect to the applicable series by written instrument, in duplicate, executed by order of the Board of Directors of the Company, one copy of which instrument shall be delivered to the resigning Trustee and one copy to the successor trustee. If no successor trustee shall have been so appointed with respect to any series and have accepted appointment within 60 days after the giving of such notice of resignation, the resigning Trustee may petition any court of competent jurisdiction for the appointment of a successor trustee, or any Securityholder who has been a bona fide holder of a Security or Securities of the applicable series for at least six

39

---

months may, subject to the provisions of Section 6.09, on behalf of himself and all others similarly situated, petition any such court for the appointment of a successor trustee. Such court may thereupon, after such notice, if any, as it may deem proper and prescribe, appoint a successor trustee.

(b) In case at any time any of the following shall occur —

(1) the Trustee shall fail to comply with the provisions of Section 310(b) of the Trust Indenture Act of 1939 with respect to any series of Securities after written request therefor by the Company or by any Securityholder who has been a bona fide holder of a Security or Securities of such series for at least six months, or

(2) the Trustee shall cease to be eligible in accordance with the provisions of Section 7.09 and Section 310(a) of the Trust Indenture Act of 1939 with respect to any series of Securities and shall fail to resign after written request therefor by the Company or by any such Securityholder, or

(3) the Trustee shall become incapable of acting with respect to any series of Securities, or shall be adjudged a bankrupt or insolvent, or a receiver of the Trustee or of its property shall be appointed or any public officer shall take charge or control of the Trustee or of its property or affairs for the purpose of rehabilitation, conservation or liquidation -

then, in any such case, the Company may remove the Trustee with respect to such series and appoint a successor trustee with respect to such series by written instrument, in duplicate, executed by order of the Board of Directors of the Company, one copy of which instrument shall be delivered to the Trustee so removed and one copy to the successor trustee, or, subject to the provisions of Section 315(e) of the Trust Indenture Act of 1939, any Securityholder who has been a bona fide holder of a Security or Securities of such series for at least six months may, on behalf of himself and all others similarly situated, petition any court of competent jurisdiction for the removal of the Trustee and the appointment of a successor trustee with respect to such series. Such court may thereupon, after such notice, if any, as it may deem proper and prescribe, remove the Trustee and appoint a successor trustee with respect to such series.

(c) The holders of a majority in aggregate principal amount of the Securities of one or more series (each series voting as a class) or all series at the time Outstanding may at any time remove the Trustee with respect to the applicable series or all series, as the case may be, and appoint with respect to the applicable series or all series, as the case may be, a successor trustee by written notice of such action to the Company, the Trustee and the successor trustee.

(d) Any resignation or removal of the Trustee with respect to any series and any appointment of a successor trustee with respect to such series pursuant to

40

---

any of the provisions of this Section 7.10 shall become effective upon acceptance of appointment by the successor trustee as provided in Section 7.11.

(e) No predecessor Trustee shall be liable for the acts or omissions of any successor Trustee.

Section 7.11. *Acceptance by Successor Trustee.* Any successor trustee appointed as provided in Section 7.10 shall execute, acknowledge and deliver to the Company and to its predecessor trustee an instrument accepting such appointment hereunder, and thereupon the resignation or removal of the predecessor trustee with respect to any or all applicable series shall become effective and such successor trustee, without any further act, deed or conveyance, shall become vested with all the rights, powers, duties and obligations with respect to such series of its predecessor hereunder, with like effect as if originally named as trustee herein; but, nevertheless, on the written request of the Company or of the successor trustee, the trustee ceasing to act shall, upon payment (or due provision therefor) of any amounts then due it pursuant to the provisions of Section 7.06, execute and deliver an instrument transferring to such successor trustee all the rights and powers with respect to such series of the trustee so ceasing to act. Upon request of any such successor trustee, the Company shall execute any and all instruments in writing in order more fully and certainly to vest in and confirm to such successor trustee all such rights and powers. Any trustee ceasing to act shall, nevertheless, retain a lien upon all property or funds held or collected by such trustee to secure any amounts then due it pursuant to the provisions of Section 7.06.

In case of the appointment hereunder of a successor trustee with respect to the Securities of one or more (but not all) series, the Company, the predecessor trustee and each successor trustee with respect to the Securities of any applicable series shall execute and deliver an indenture supplemental hereto which shall contain such provisions as

shall be deemed necessary or desirable to confirm that all the rights, powers, trusts and duties of the predecessor trustee with respect to the Securities of any series as to which the predecessor trustee is not retiring shall continue to be vested in the predecessor trustee, and shall add to or change any of the provisions of this Indenture as shall be necessary to provide for or facilitate the administration of the trusts hereunder by more than one trustee, it being understood that nothing herein or in such supplemental indenture shall constitute such trustees co-trustees of the same trust and that each such trustee shall be trustee of a trust or trusts hereunder separate and apart from any trust or trusts hereunder administered by any other such trustee.

No successor trustee with respect to a series of Securities shall accept appointment as provided in this Section 7.11 unless at the time of such acceptance such successor trustee shall, with respect to such series, be qualified under Section 310(b) of the Trust Indenture Act of 1939 and eligible under the provisions of Section 7.09.

41

---

Upon acceptance of appointment by a successor trustee with respect to any series as provided in this Section 7.11, the Company shall mail notice of the succession of such trustee hereunder to the holders of Securities of such series at their addresses as they shall appear on the registry books of the Company. If the Company fails to mail such notice within ten days after the acceptance of appointment by the successor trustee, the successor trustee shall cause such notice to be mailed at the expense of the Company.

Section 7.12. *Succession by Merger, etc.* Any Person into which the Trustee may be merged or converted or with which it may be consolidated, or any Person resulting from any merger, conversion or consolidation to which the Trustee shall be a party, or any corporation succeeding to all or substantially all of the corporate trust business of the Trustee, shall be the successor to the Trustee hereunder, provided such corporation shall be qualified under Section 310(b) of the Trust Indenture Act of 1939 and eligible under the provisions of Section 7.09, without the execution or filing of any paper or any further act on the part of any of the parties hereto, anything herein to the contrary notwithstanding.

In case at the time such successor to the Trustee shall succeed to the trust created by this Indenture with respect to one or more series of Securities, any of such Securities shall have been authenticated but not delivered, any such successor to the Trustee by merger, conversion or consolidation may adopt the certificate of authentication of any predecessor trustee, and deliver such Security so authenticated; and in case at that time any of such Securities shall not have been authenticated, any successor to the Trustee may authenticate such Securities either in the name of such successor to the Trustee or, if such successor to the Trustee is a successor by merger, conversion or consolidation the name of any predecessor hereunder; and in all such cases such certificate shall have the full force which it is anywhere in such Securities or in this Indenture provided that the certificate of the Trustee shall have.

Section 7.13. *Other Matters Concerning the Trustee.* The principal corporate trust office of the Trustee at the date of this Indenture is located at 101 Barclay Street, 8W, New York, New York 10286, Attn: Corporate Trust Division-Corporate Finance Unit.

Section 7.14. *Appointment of Authenticating Agent.* The Trustee may appoint an Authenticating Agent or Agents which shall be authorized to act on behalf of the Trustee to authenticate Securities issued upon original issue and upon exchange, registration of transfer, partial conversion or partial redemption or pursuant to Section 2.07, and Securities so authenticated shall be entitled to the benefits of this Indenture and shall be valid and obligatory for all purposes as if authenticated by the Trustee hereunder. Wherever reference is made in this Indenture to the authentication and delivery of Securities by the Trustee or the Trustee's certificate of authentication, such reference shall be deemed to include authentication and delivery on behalf of the Trustee by an Authenticating Agent

42

---

and a certificate of authentication executed on behalf of the Trustee by an Authenticating Agent. Each Authenticating Agent shall be acceptable to the Company and shall at all times be a corporation organized and doing business under the laws of the United States of America, any State thereof or the District of Columbia, authorized under such laws to act as Authenticating Agent, having a combined capital and surplus of not less than \$50,000,000 and subject to supervision or examination by Federal or State authority. If such Authenticating Agent publishes reports of condition at least annually, pursuant to law or to the requirements of said supervising or examining authority, then for the purposes of this Section, the combined capital and surplus of such Authenticating Agent shall be deemed to be its combined capital and surplus as set forth in its most recent report of condition so published. If at any time an Authenticating Agent shall cease to be eligible in accordance with the provisions of this Section, such Authenticating Agent shall resign immediately in the manner and with the effect specified in this Section.

Any corporation into which an Authenticating Agent may be merged or converted or with which it may be consolidated, or any corporation resulting from any merger, conversion or consolidation to which such Authenticating Agent shall be a party, or any corporation succeeding to the corporate agency or corporate trust business of an Authenticating Agent, shall continue to be an Authenticating Agent, provided such corporation shall be otherwise eligible under this Section, without the execution or filing of any paper or any further act on the part of the Trustee or the Authenticating Agent.

An Authenticating Agent may resign at any time by giving written notice thereof to the Trustee and to the Company. The Trustee may at any time terminate the agency of an Authenticating Agent by giving written notice thereof to such Authenticating Agent and to the Company. Upon receiving such a notice of resignation or upon such a termination, or in case at any time such Authenticating Agent shall cease to be eligible in accordance with the provisions of this Section, the Trustee may appoint a successor Authenticating Agent which shall be acceptable to the Company and shall mail written notice of such appointment by first-class mail, postage prepaid, to all Holders as their names and addresses appear in the Security Register. Any successor Authenticating Agent upon acceptance of its appointment hereunder shall become vested with all the rights, powers and duties of its predecessor hereunder, with like effect as if originally named as an Authenticating Agent. No successor Authenticating Agent shall be appointed unless eligible under the provisions of this Section.

The Company agrees to pay to each Authenticating Agent from time to time reasonable compensation for its services under this Section.

If an appointment is made pursuant to this Section, the Securities may have endorsed thereon, in addition to the Trustee's certificate of authentication, an alternative certificate of authentication in the following form:

43

---

Dated:

This is one of the Securities described in the within-mentioned Indenture.

THE BANK OF NEW YORK, as Trustee

By: \_\_\_\_\_  
As Authenticating Agent



By: \_\_\_\_\_  
Authorized Signatory

ARTICLE 8  
CONCERNING THE SECURITYHOLDERS

Section 8.01. *Action of Securityholders.* Whenever in this Indenture it is provided that the holders of a specified percentage in aggregate principal amount of the Securities of any or all series may take any action (including the making of any demand or request, the giving of any notice, consent or waiver or the taking of any other action) the fact that at the time of taking any such action the holders of such specified percentage have joined therein may be evidenced (a) by any instrument or any number of instruments of similar tenor executed by such Securityholders in person or by agent or proxy appointed in writing, or (b) by the record of such holders of Securities voting in favor thereof at any meeting of such Securityholders duly called and held in accordance with the provisions of Article Nine, or (c) by a combination of such instrument or instruments and any such record of such a meeting of such Securityholders.

Section 8.02. *Proof of Execution by Securityholders.* Subject to the provisions of Sections 7.01, 7.02 and 9.06, proof of the execution of any instrument by a Securityholder or his agent or proxy shall be sufficient if made in accordance with such reasonable rules and regulations as may be prescribed by the Trustee or in such manner as shall be reasonably satisfactory to the Trustee. The ownership of Securities shall be proved by the registry books of the Company.

The record of any Securityholders' meeting shall be proved in the manner provided in Section 9.07.

The Company may set a record date for purposes of determining the identity of holders of Securities of any series entitled to vote or consent to or revoke any action referred to in Section 8.01, which record date may be set at any

44

---

time or from time to time by notice to the Trustee, for any date or dates (in the case of any adjournment or reconsideration) not more than 60 days nor less than five days prior to the proposed date of such vote or consent, and thereafter, notwithstanding any other provisions hereof, with respect to Securities of any series, only holders of Securities of such series of record on such record date shall be entitled to so vote or give such consent or revoke such vote or consent.

Section 8.03. *Who Are Deemed Absolute Owners.* The Company, the Trustee and any agent of the Company or of the Trustee may deem the person in whose name any Security shall be registered upon the books of the Company to be, and may treat him as, the owner of such Security (whether or not such Security shall be overdue and notwithstanding any notation of ownership or other writing thereon) for the purpose of receiving payment of or on account of the principal of, premium, if any, and (subject to Section 2.04) interest, if any, on such Security and for all other purposes; and neither the Company nor the Trustee nor any agent of the Company or of the Trustee shall be affected by any notice to the contrary. All such payments so made to any holder for the time being, or upon his order, shall be valid, and, to the extent of the sum or sums so paid, effectual to satisfy and discharge the liability for moneys payable upon any such Security.

No Beneficial Owner in any Global Security held on its behalf by a Depository shall have any rights under this Indenture with respect to such Global Security, and such Depository may be treated by the Company, the Trustee, and any agent of the Company or the Trustee as the owner of such Security for all purposes whatsoever. None of the Company, the Trustee or any agent of the Company or the Trustee will have any responsibility or liability for any aspect of the records relating to or payments made on account of beneficial ownership interests of a Global Security or maintaining, supervising or reviewing any records relating to such beneficial ownership interests.

Section 8.04. *Company-Owned Securities Disregarded.* In determining whether the holders of the requisite aggregate principal amount of Securities have concurred in any demand, request, notice, direction, consent or waiver under this Indenture, Securities which are owned by the Company or any other obligor on the Securities with respect to which such determination is being made or by any person directly or indirectly controlling or controlled by or under direct or indirect common control with the Company or any other obligor on the Securities with respect to which such determination is being made shall be disregarded and deemed not to be Outstanding for the purpose of any such determination; *provided*, that for the purposes of determining whether the Trustee shall be protected in relying on any such demand, request, notice, direction, consent or waiver only Securities which the Trustee knows are so owned shall be so disregarded. Securities so owned which have been pledged in good faith may be regarded as Outstanding for the purposes of this Section 8.04 if the pledgee shall establish to the satisfaction of the Trustee the pledgee's right to vote such Securities and that the pledgee is not a person directly or indirectly controlling or

45

---

controlled by or under direct or indirect common control with the Company or any such other obligor. In the case of a dispute as to such right, any decision by the Trustee taken upon the advice of counsel shall be full protection to the Trustee.

Section 8.05. *Revocation of Consents; Future Holders Bound.* At any time prior to (but not after) the evidencing to the Trustee, as provided in Section 8.01, of the taking of any action by the holders of the percentage in aggregate principal amount of the Securities of any or all series, as the case may be, specified in this Indenture in connection with such action, any holder of a Security which is shown by the evidence to be included in the Securities the holders of which have consented to such action may, by filing written notice with the Trustee at its principal office and upon proof of holding as provided in Section 8.02, revoke such action so far as concerns such Security. Except as aforesaid any such action taken by the holder of any Security shall be conclusive and binding upon such holder and upon all future holders of such Security, irrespective of whether or not any notation in regard thereto is made upon such Security or any Security issued in exchange or substitution therefor.

ARTICLE 9  
SECURITYHOLDERS' MEETINGS

Section 9.01. *Purposes of Meetings.* A meeting of holders of Securities of any or all series may be called at any time and from time to time pursuant to the provisions of this Article Nine for any of the following purposes:

- (1) to give any notice to the Company or to the Trustee, or to give any directions to the Trustee, or to consent to the waiving of any default hereunder and its consequences, or to take any other action authorized to be taken by Securityholders pursuant to any of the provisions of Article Six;
- (2) to remove the Trustee and nominate a successor trustee pursuant to the provisions of Article Seven;
- (3) to consent to the execution of an indenture or indentures supplemental hereto pursuant to the provisions of Section 10.02; or
- (4) to take any other action authorized to be taken by or on behalf of the holders of any specified aggregate principal amount of the Securities of any or all series, as the case may be, under any other provision of this Indenture or under applicable law.

Section 9.02. *Call of Meetings by Trustee.* The Trustee may at any time call a meeting of holders of Securities of any or all series to take any action specified in Section 9.01, to be held at such time and at such place in the Borough

of Manhattan, The City of New York, as the Trustee shall determine. Notice of every meeting of the holders of Securities of any or all series, setting forth the time and the place of such meeting and in general terms the action proposed to be taken at such meeting, shall be mailed to holders of Securities of each series affected at their addresses as they shall appear on the registry books of the Company. Such notice shall be mailed not less than 10 nor more than 90 days prior to the date fixed for the meeting.

Section 9.03. *Call of Meetings by Company or Securityholders.* In case at any time the Company, pursuant to a resolution of its Board of Directors, or the holders of at least ten percent in aggregate principal amount of the Securities then Outstanding of any series that may be affected by the action proposed to be taken at the meeting, shall have requested the Trustee to call a meeting of the holders of Securities of all series that may be so affected, by written request setting forth in reasonable detail the action proposed to be taken at the meeting, and the Trustee shall not have mailed the notice of such meeting within 20 days after receipt of such request, then the Company or such Securityholders, in the amount specified above, may determine the time and the place in said Borough of Manhattan for such meeting and may call such meeting to take any action authorized in Section 9.01, by mailing notice thereof as provided in Section 9.02.

Section 9.04. *Qualifications for Voting.* To be entitled to vote at any meeting of Securityholders a person shall (a) be a holder of one or more Securities with respect to which such meeting is being held or (b) be a person appointed by an instrument in writing as proxy by a holder of one or more such Securities. The only persons who shall be entitled to be present or to speak at any meeting of Securityholders shall be the persons entitled to vote at such meeting and their counsel and any representatives of the Trustee and its counsel and any representatives of the Company and its counsel.

Section 9.05. *Quorum; Adjourned Meetings.* The Persons entitled to vote a majority in aggregate principal amount of the Securities of the relevant series at the time Outstanding shall constitute a quorum for the transaction of all business specified in Section 9.01. No business shall be transacted in the absence of a quorum (determined as provided in this Section 9.05). In the absence of a quorum within 30 minutes after the time appointed for any such meeting, the meeting shall, if convened at the request of the holders of Securities (as provided in Section 9.03), be dissolved. In any other case the meeting shall be adjourned for a period of not less than ten days as determined by the chairman of the meeting. In the absence of a quorum at any such adjourned meeting, such adjourned meeting shall be further adjourned for a period of not less than ten days as determined by the chairman of the meeting. Notice of the reconvening of any adjourned meeting shall be given as provided in Section 9.02, except that such notice must be mailed not less than five days prior to the date on which the meeting is scheduled to be reconvened.

Subject to the foregoing, at the second reconvening of any meeting adjourned for lack of a quorum, the Persons entitled to vote 25% in aggregate principal amount of the Securities of the relevant series then Outstanding shall constitute a quorum for the taking of any action set forth in the notice of the original meeting. Notice of the reconvening of an adjourned meeting shall state expressly the percentage of the aggregate principal amount of the Securities of the relevant series then Outstanding which shall constitute a quorum.

At a meeting or any adjourned meeting duly convened and at which a quorum is present as aforesaid, any resolution and all matters (except as limited by the proviso in Section 10.02) shall be effectively passed and decided if passed or decided by the Persons entitled to vote the lesser of (a) a majority in aggregate principal amount of the Securities of the relevant series then Outstanding and (b) 75% in aggregate principal amount of the Securities represented and voting at the meeting.

Any holder of a Security who has executed in person or by proxy and delivered to the Trustee an instrument in writing complying with the provisions of Article Eight shall be deemed to be present for the purposes of determining a quorum and be deemed to have voted; provided that such holder of a Security shall be considered as present or voting only with respect to the matters covered by such instrument in writing.

Section 9.06. *Regulations.* Notwithstanding any other provisions of this Indenture, the Trustee may make such reasonable regulations as it may deem advisable for any meeting of Securityholders, in regard to proof of the holder of Securities and of the appointment of proxies, and in regard to the appointment and duties of inspectors of votes, the submission and examination of proxies, certificates and other evidence of the right to vote, and such other matters concerning the conduct of the meeting as it shall think fit.

The Trustee shall, by an instrument in writing, appoint a temporary chairman of the meeting, unless the meeting shall have been called by the Company or by Securityholders, as provided in Section 9.03, in which case the Company or the Securityholders calling the meeting, as the case may be, shall in like manner appoint a temporary chairman. A permanent chairman and a permanent secretary of the meeting shall be elected by majority vote of the meeting.

Subject to the provisions of Section 8.04, at any meeting each holder of Securities with respect to which such meeting is being held or proxy shall be entitled to vote the principal amount (in the case of Original Issue Discount Securities, such principal amount to be determined as provided in the definition of "Security or Securities; Outstanding" in Section 1.01) of such Securities held or represented by him; *provided, however*, that no vote shall be cast or counted at any meeting in respect of any such Security challenged as not Outstanding and

ruled by the chairman of the meeting to be not Outstanding. The chairman of the meeting shall have no right to vote other than by virtue of such Securities held by him or instruments in writing as aforesaid duly designating him as the person to vote on behalf of other such Securityholders. Any meeting of holders of Securities with respect to which a meeting was duly called pursuant to the provisions of Sections 9.02 or 9.03 may be adjourned from time to time by a majority of those present, whether or not constituting a quorum, and the meeting may be held as so adjourned without further notice.

Section 9.07. *Voting.* The vote upon any resolution submitted to any meeting of holders of Securities with respect to which such meeting is being held shall be by written ballots on which shall be subscribed the signatures of such holders of Securities or of their representatives by proxy and the principal amount (in the case of Original Issue Discount Securities, such principal amount to be determined as provided in the definition of "Security or Securities; Outstanding" in Section 1.01) and number or numbers of such Securities held or represented by them. The permanent chairman of the meeting shall appoint two inspectors of votes who shall count all votes cast at the meeting for or against any resolution and who shall make and file with the secretary of the meeting their verified written reports in duplicate of all votes cast at the meeting. A record in duplicate of the proceedings of each meeting of Securityholders shall be prepared by the secretary of the meeting and there shall be attached to said record the original reports of the inspectors of votes on any vote by ballot taken thereat and affidavits by one or more persons having knowledge of the facts setting forth a copy of the notice of the meeting and showing that said notice was mailed as provided in Section 9.02. The record shall show the principal amount of the Securities (in the case of Original Issue Discount Securities, such principal amount to be determined as provided in the definition of "Security or Securities; Outstanding" in Section 1.01) voting in favor of or against any resolution. The record shall be signed and verified by the affidavits of the permanent chairman and secretary of the meeting and one of the duplicates shall be delivered to the Company and the other to the Trustee to be preserved by the Trustee, the latter to have attached thereto the ballots voted at the meeting.

Any record so signed and verified shall be conclusive evidence of the matters therein stated.

Section 9.08. *No Delay of Rights by Meeting.* Nothing in this Article Nine contained shall be deemed or construed to authorize or permit, by reason of any call of a meeting of Securityholders of any or all series or any rights expressly or impliedly conferred hereunder to make such call, any hindrance or delay in the exercise of any right or

---

ARTICLE 10  
SUPPLEMENTAL INDENTURES

Section 10.01. *Supplemental Indentures without Consent of Securityholders.* The Company, when authorized by resolution of the Board of Directors, and the Trustee may from time to time and at any time enter into an indenture or indentures supplemental hereto for one or more of the following purposes:

- (a) to evidence the succession of another corporation to the Company, or successive successions, and the assumption by the successor corporation of the covenants, agreements and obligations of the Company pursuant to Article Eleven hereof;
- (b) to add to the covenants of the Company such further covenants, restrictions or conditions for the protection of the holders of all or any series of Securities (and if such covenants are to be for the benefit of less than all series of Securities, stating that such covenants are expressly being included for the benefit of such series) as the Board of Directors of the Company and the Trustee shall consider to be for the protection of the holders of such Securities, and to make the occurrence, or the occurrence and continuance, of a default in any of such additional covenants, restrictions or conditions a default or an Event of Default permitting the enforcement of all or any of the several remedies provided in this Indenture as herein set forth; *provided, however,* that in respect of any such additional covenant, restriction or condition such supplemental indenture may provide for a particular period of grace after default (which period may be shorter or longer than that allowed in the case of other defaults) or may provide for an immediate enforcement upon such default or may limit the remedies available to the Trustee upon such default;
- (c) to provide for the issuance under this Indenture of Securities in coupon form (including Securities registrable as to principal only) and to provide for exchangeability of such Securities with the Securities of the same series issued hereunder in fully registered form and to make all appropriate changes for such purpose;
- (d) to establish the forms or terms of Securities of any series or of the Coupons appertaining to such Securities as permitted by Sections 2.01 and 2.02;
- (e) to add guarantees with respect to the Securities of any series or to secure the Securities of any series;
- (f) to modify or amend this Indenture to permit the qualification of this Indenture or any indentures supplemental hereto under the Trust Indenture Act of 1939, as amended;

---

(g) to cure any ambiguity or to correct or supplement any provision contained herein or in any supplemental indenture which may be defective or inconsistent with any other provision contained herein or in any supplemental indenture, or to make such other provisions in regard to matters or questions arising under this Indenture which shall not adversely affect the interests of the holders of any Securities; *provided, however,* that any amendment made solely to conform the provisions of this Indenture to the description of the Securities contained in the prospectus or other offering document pursuant to which the Securities were sold will not be deemed to adversely affect the interests of the holders of the Securities; and

(h) to evidence and provide for the acceptance of appointment hereunder by a successor or separate trustee with respect to the Securities of one or more series or to add to or change any of the provisions of this Indenture as shall be necessary to provide for or facilitate the administration of the trusts hereunder by more than one trustee, pursuant to the requirements of Section 7.11 or pursuant to Section 2.02(17).

The Trustee is hereby authorized to join with the Company in the execution of any such supplemental indenture, to make any further appropriate agreements and stipulations which may be therein contained and to accept the conveyance, transfer and assignment of any property thereunder, but the Trustee shall not be obligated to, but may in its discretion, enter into any such supplemental indenture which affects the Trustee's own rights, duties or immunities under this Indenture or otherwise.

Any supplemental indenture authorized by the provisions of this Section 10.01 may be executed by the Company and the Trustee without the consent of the holders of any of the Securities at the time Outstanding, notwithstanding any of the provisions of Section 10.02.

Section 10.02. *Supplemental Indentures with Consent of Securityholders.* With the consent (evidenced as provided in Sections 8.01 and 8.02) of the holders of a majority in the aggregate principal amount of the Securities of each series (each series voting as a class) affected by such supplemental indenture at the time Outstanding, the Company and the Trustee may from time to time and at any time enter into an indenture or indentures supplemental hereto for the purpose of adding any provisions to or changing in any manner or eliminating any of the provisions of this Indenture or any supplemental indenture or of modifying in any manner the rights of the holders of the Securities or each such series; *provided, however,* that no such supplemental indenture shall (i) change the stated maturity of principal of, or any installment of principal of or interest on, any Security, or reduce the rate or extend the time of payment of interest, if any, thereon, or alter the manner of calculation of interest payable on any Security, or reduce the principal amount or premium, if any, thereof, or make the principal thereof or premium, if any, or interest, if any, thereon payable in any coin or currency other

---

than that provided in any Security, or impair the right of any holder of a Security to institute suit for any such payment, or reduce the amount of the principal of an Original Issue Discount Security that would be due and payable upon an acceleration of the maturity thereof pursuant to Section 6.01 or adversely affect the right of repayment, if any, at the option of the holder, or extend the time, or reduce the amount of any payment to any sinking fund or analogous obligation relating to any Security, (ii) reduce the percentage in principal amount of Securities of any series, the holders of which are required to consent to any such supplemental indenture or any waiver of any past default or Event of Default pursuant to Section 6.07(b), (iii) change any place of payment where the Securities of any series or interest thereon is payable, or (iv) modify any provision of Section 6.07(b) or 10.02 (except to increase any such percentage or to provide that certain other provisions of the Indenture cannot be modified or waived without the consent of the holder of each Security so affected), without, in the case of each of the foregoing clauses (i), (ii), (iii) and (iv), the consent of the holder of each Security so affected. A supplemental indenture which changes or eliminates any covenant or other provision of this Indenture which has expressly been included solely for the benefit of one or more particular series of Securities, or which modifies the rights of the holders of Securities of such series with respect to such covenant or other provision, shall be deemed not to affect the rights under this Indenture of the holders of Securities of any other series.

Upon the request of the Company, accompanied by a copy of the resolutions of the Board of Directors authorizing the execution and delivery of any such supplemental indenture, and upon the filing with the Trustee of evidence of the consent of Securityholders as aforesaid, the Trustee shall join with the Company in the execution of such supplemental indenture unless such supplemental indenture affects the Trustee's own rights, duties or immunities under this Indenture or otherwise, in which case the Trustee may in its discretion but shall not be obligated to, enter into such supplemental indenture.

It shall not be necessary for the consent of the Securityholders under this Section 10.02 to approve the particular form of any proposed supplemental indenture, but it shall be sufficient if such consent shall approve the substance thereof.

Section 10.03. *Compliance with Trust Indenture Act; Effect of Supplemental Indentures.* Any supplemental indenture executed pursuant to the provisions of this Article Ten shall comply with the Trust Indenture Act of 1939, as then in effect. Upon the execution of any supplemental indenture pursuant to the provisions of this Article Ten, this Indenture shall be deemed to be modified and amended in accordance therewith and the respective rights, limitations of rights, obligations, duties and immunities under this Indenture of the Trustee, the Company and the holders of the Securities shall thereafter be determined, exercised and enforced hereunder subject in all respects to such modifications and amendments, and all the terms and conditions of any such supplemental indenture

52

---

shall be and be deemed to be part of the terms and conditions of this Indenture for any and all purposes.

Section 10.04. *Notation on Securities.* Securities authenticated and delivered after the execution of any supplemental indenture pursuant to the provisions of this Article Ten may bear a notation in form approved by the Trustee as to any matter provided for in such supplemental indenture. If the Company or the Trustee shall so determine, new Securities of any series so modified as to conform, in the opinion of the Trustee and the Board of Directors, to any modification of this Indenture contained in any such supplemental indenture may be prepared and executed by the Company, authenticated by the Trustee and delivered in exchange for the Securities of such series then Outstanding.

Section 10.05. *Evidence of Compliance of Supplemental Indenture to be Furnished Trustee.* The Trustee, subject to the provisions of Sections 7.01 and 7.02, may receive an Officers' Certificate and an Opinion of Counsel as conclusive evidence that any supplemental indenture executed pursuant hereto complies with the requirements of this Article Ten.

#### ARTICLE 11 CONSOLIDATION, MERGER, SALE OR CONVEYANCE

Section 11.01. *Company May Not Consolidate, etc., Except Under Certain Conditions.* The Company covenants that it will not merge or consolidate with any other Person or sell, convey, transfer or otherwise dispose of all or substantially all of its assets to any other Person, unless (i) either the Company shall be the continuing corporation, or the successor Person (if other than the Company) shall be a corporation or a limited liability company organized and existing under the laws of the United States of America or a state thereof or the District of Columbia and such corporation or limited liability company shall expressly assume the due and punctual payment of the principal of, and premium, if any, and interest, if any, on all the Securities according to their tenor, and the due and punctual performance and observance of all of the covenants and conditions of this Indenture to be performed by the Company by supplemental indenture satisfactory to the Trustee, executed and delivered to the Trustee by such corporation, and (ii) the Company or such successor corporation or limited liability company, as the case may be, shall not, immediately after such merger or consolidation, or such sale, conveyance, transfer or other disposition, be in default in the performance of any such covenant or condition. In the event of any such sale, conveyance (other than by way of lease), transfer or other disposition, the predecessor company may be dissolved, wound up and liquidated at any time thereafter.

53

---

Section 11.02. *Successor Corporation or Limited Liability Company to be Substituted.* In case of any such consolidation, merger, sale, conveyance (other than by way of lease), transfer or other disposition, and upon any such assumption by the successor corporation, such successor corporation or limited liability company shall succeed to and be substituted for the Company, with the same effect as if it had been named herein as the Company, and the Company shall be relieved of any further obligation under this Indenture and under the Securities. Such successor corporation or limited liability company thereupon may cause to be signed, and may issue either in its own name or in the name of Genworth Financial, Inc., any or all of the Securities issuable hereunder which theretofore shall not have been signed by the Company and delivered to the Trustee; and, upon the order of such successor corporation or limited liability company, instead of the Company, and subject to all the terms, conditions and limitations in this Indenture prescribed, the Trustee shall authenticate and shall deliver any Securities which previously shall have been signed and delivered by the officers of the Company to the Trustee for authentication, and any Securities which such successor corporation or limited liability company thereafter shall cause to be signed and delivered to the Trustee for that purpose. All the Securities so issued shall in all respects have the same legal rank and benefit under this Indenture as the Securities theretofore or thereafter issued in accordance with the terms of this Indenture as though all of such Securities had been issued at the date of the execution hereof.

In case of any such consolidation, merger, sale, conveyance, transfer or other disposition, such changes in phraseology and form (but not in substance) may be made in the Securities thereafter to be issued as may be appropriate.

Section 11.03. *Documents to be Given Trustee.* The Trustee, subject to the provisions of Sections 7.01 and 7.02, may receive an Officers' Certificate and an Opinion of Counsel as conclusive evidence that any such consolidation, merger, sale, conveyance, transfer or other disposition, and any such assumption, comply with the provisions of this Article Eleven.

#### ARTICLE 12 SATISFACTION AND DISCHARGE OF INDENTURE

Section 12.01. *Discharge of Indenture.* When (a) the Company shall deliver to the Trustee for cancellation all Securities theretofore authenticated (other than any Securities which shall have been destroyed, lost or stolen or in lieu of or in substitution for which other Securities shall have been authenticated and delivered, or which shall have been paid, pursuant to the provisions of Section 2.07 or Securities for whose payment money has theretofore been deposited in trust and thereafter repaid to the Company as provided in Section 12.06) and not theretofore cancelled, or (b) all the Securities not theretofore cancelled or delivered to the Trustee for cancellation shall have become due and

54

---

payable, or are by their terms to become due and payable within one year or are to be called for redemption within one year under arrangements satisfactory to the Trustee for the giving of notice of redemption, and the Company shall deposit with the Trustee, in trust, funds sufficient to pay at maturity or upon redemption all of the Securities (other than any (i) Securities which shall have been destroyed, lost or stolen and in lieu of or in substitution for which other Securities shall have been authenticated and delivered, or which shall have been paid, pursuant to the provisions of Section 2.07 or (ii) Securities for whose payment money has theretofore been deposited in trust and thereafter repaid to the Company as provided in Section 12.06) not theretofore cancelled or delivered to the Trustee for cancellation, including principal, premium, if any, and interest, if any, due or to become due to such date of maturity or date fixed for redemption, as the case may be, and if in either case the Company shall also pay or cause to be paid all other sums payable hereunder by the Company, then this Indenture shall cease to be of further effect (except as to (i) rights of registration of transfer and exchange of Securities, (ii) substitution of mutilated, defaced, destroyed, lost or stolen Securities, (iii) rights of holders to receive payments of principal thereof and interest thereon, and remaining rights of the holders to receive mandatory sinking fund payments, if any, (iv) the rights, obligations and immunities of the Trustee hereunder and (v) the rights of the Securityholders as beneficiaries hereof with respect to the property so deposited with the Trustee payable to all or any of them), and the Trustee, on demand of the Company accompanied by an Officers' Certificate and an Opinion of Counsel and at the cost and expense of the Company, shall execute proper instruments acknowledging satisfaction of and discharging this Indenture, the Company, however, hereby agreeing to reimburse the Trustee for any costs or expenses thereafter reasonably and properly incurred by the Trustee in connection with this Indenture or the Securities.

Section 12.02. *Legal Defeasance.* On the 91st day following the deposit referred to in clause (a), the Company will be deemed to have paid and will be discharged

from its obligations in respect of the Securities of the series with respect to which such deposit shall have been made and the Indenture with respect to such Securities, other than (i) the rights of the Securityholders of Outstanding Securities of such series to receive, solely from the trust fund described in clause (a), payments in respect of the principal of and interest on such securities when such payments are due and (ii) its obligations in Article Two and Sections 4.02, 7.06, 7.10, 12.06; and 12.07 provided the following conditions have been satisfied:

(a) The Company has irrevocably deposited in trust with the Trustee, as trust funds solely for the benefit of the Securityholders of such series, money sufficient, or U.S. Government Obligations, the principal of and interest on which shall be sufficient, or a combination thereof sufficient, in the opinion of the Board of Directors of the Company evidenced by a resolution set forth in an Officers' Certificate delivered to the Trustee, without consideration of any reinvestment, to pay principal of, premium, if any, and interest, if any, on the Securities of such

55

---

series to maturity or redemption, as the case may be, provided that any redemption before maturity has been irrevocably provided for under arrangements satisfactory to the Trustee.

(b) The deposit will not result in a breach or violation of, or constitute a default under, the Indenture or any other agreement or instrument to which the Company is a party or by which it is bound.

(c) The Company has delivered to the Trustee either (x) a ruling received from the Internal Revenue Service to the effect that the holders of the Securities of such series will not recognize income, gain or loss for federal income tax purposes as a result of the defeasance and will be subject to federal income tax on the same amount and in the same manner and at the same times as would otherwise have been the case or (y) an Opinion of Counsel, based on a change in law after the date of the Indenture, to the same effect as the ruling described in clause (x).

(d) The Company has delivered to the Trustee an Officers' Certificate and an Opinion of Counsel, in each case stating that all conditions precedent provided for herein relating to the defeasance have been complied with.

Prior to the end of the 91-day period, none of the Company's obligations under the Indenture with respect to the Securities of such series will be discharged. Thereafter, the Trustee, upon the request and at the cost and expense of the Company, will acknowledge in writing the discharge of the Company's obligations under the Securities of such series and the Indenture with respect to such series except for the surviving obligations specified above.

As used herein, "U.S. Government Obligation" means (x) any security which is (i) a direct obligation of the United States of America for the payment of which its full faith and credit is pledged or (ii) an obligation of a Person controlled or supervised by and acting as an agency or instrumentality of the United States of America, the payment of which is unconditionally guaranteed as a full faith and credit obligation by the United States of America, which, in either case (i) or (ii), is not callable or redeemable at the option of the issuer thereof, and (y) any depository receipt issued by a bank (as defined in Section 3(a)(2) of the Securities Act of 1933) as custodian with respect to any U.S. Government Obligation which is specified in clause (x) above and held by such bank for the account of the holder of such depository receipt, or with respect to any specific payment of principal of or interest on any U.S. Government Obligation which is so specified and held, *provided* that (except as required by law) such custodian is not authorized to make any deduction from the amount payable to the holder of such depository receipt from any amount received by the custodian in respect of the U.S. Government Obligation or the specific payment of principal or interest evidenced by such depository receipt.

56

---

Section 12.03. *Covenant Defeasance.* After the 91st day following the deposit referred to in clause (a) with respect to the Securities of a series, the Company's obligations set forth in the covenant or covenants for such series of Securities established as contemplated by Section 2.02(19) will terminate, and clauses (d) (to the extent relating to such covenant or covenants), (e) and (h) of Section 6.01 will no longer constitute Events of Default with respect to the Securities of a series, provided the following conditions have been satisfied:

(a) the Company has complied with clauses (a), (b) and (d) of Section 12.02; and

(b) the Company has delivered to the Trustee an Opinion of Counsel to the effect that the holders of the Securities of such series will not recognize income, gain or loss for federal income tax purposes as a result of the defeasance and will be subject to federal income tax on the same amount and in the same manner and at the same times as would otherwise have been the case.

Except as specifically stated above, none of the Company's obligations under the Indenture will be discharged.

Section 12.04. *Deposited Moneys to be Held in Trust by Trustee; Miscellaneous Provisions.* All moneys and U.S. Government Obligations (including the proceeds thereof) deposited with the Trustee pursuant to the provisions of, Section 12.02 or 12.03 shall be held in trust and applied by it to the payment, either directly or through any paying agent (including the Company if acting as its own paying agent), to the holders of the particular Securities for payment or redemption of which such moneys or U.S. Government Obligations have been deposited with the Trustee, of all sums due and to become due thereon for principal, premium, if any, and interest, if any.

The Company shall pay and indemnify the Trustee against any tax, fee or other charge imposed on or assessed against the U.S. Government Obligations deposited pursuant to Section 12.01 or 12.03 or the principal and interest received in respect thereof other than any such tax, fee or other charge which by law is for the account of the holders of the Securities.

Anything in this Article to the contrary notwithstanding, the Trustee shall deliver or pay to the Company from time to time upon request of the Company any money or U.S. Government Obligations held by it as provided in Section 12.02 or 12.03 with respect to any Securities which, in the opinion of a nationally recognized firm of independent public accountants expressed in a written certification thereof delivered to the Trustee, are in excess of the amount thereof which would then be required to be deposited to effect the legal defeasance or covenant defeasance, as the case may be, with respect to such Securities.

Section 12.05. *Paying Agent to Repay Moneys Held.* Upon the satisfaction and discharge of this Indenture all moneys then held by any paying

57

---

agent of the Securities (other than the Trustee) shall, upon demand of the Company, be repaid to the Company or paid to the Trustee, and thereupon such paying agent shall be released from all further liability with respect to such moneys.

Section 12.06. *Return of Unclaimed Moneys.* Any moneys deposited with or paid to the Trustee for payment of the principal of, premium, if any, or interest, if any, on Securities of any series and not applied but remaining unclaimed by the holders of Securities of that series for two years after the date upon which the principal of, premium, if any, or interest, if any, on such Securities, as the case may be, shall have become due and payable, shall be repaid to the Company by the Trustee on written demand; and the holder of any such Securities shall thereafter look only to the Company for any payment which such holder may be entitled to collect and all liability of the

Trustee with respect to such money shall thereupon cease.

Section 12.07. *Reinstatement.* If and for so long as the Trustee is unable to apply any money or U.S. Government Obligations held in trust pursuant to Section 12.01, 12.02 or 12.03 by reason of any legal proceeding or by reason of any order or judgment of any court or governmental authority enjoining, restraining or otherwise prohibiting such application, the Company's obligations under the Indenture and the Securities will be reinstated as though no such deposit in trust had been made. If the Company makes any payment of principal of or interest on any Securities because of the reinstatement of its obligations, it will be subrogated to the rights of the Securityholders of such Securities to receive such payment from the money or U.S. Government Obligations held in trust.

ARTICLE 13  
IMMUNITY OF INCORPORATORS, STOCKHOLDERS, OFFICERS AND DIRECTORS

Section 13.01. *Indenture and Securities Solely Corporate Obligations.* No recourse for the payment of the principal of, premium, if any, or interest, if any, on any Security, or for any claim based thereon or otherwise in respect thereof, and no recourse under or upon any obligation, covenant or agreement of the Company in this Indenture or in any supplemental indenture, or in any Security, or because of the creation of any indebtedness represented thereby, shall be had against any incorporator, stockholder, officer or director, as such, past, present or future, of the Company or of any successor corporation, either directly or through the Company or any successor corporation, whether by virtue of any constitution, statute or rule of law, or by the enforcement of any assessment or penalty or otherwise; it being expressly understood that all such liability is hereby expressly waived and released as a condition of, and as a consideration for, the execution of this Indenture and the issue of the Securities.

58

---

ARTICLE 14  
MISCELLANEOUS PROVISIONS

Section 14.01. *Provisions Binding on Company's Successors.* All the covenants, stipulations, promises and agreements in this Indenture contained by the Company shall bind its successors and assigns whether so expressed or not.

Section 14.02. *Official Acts by Successor Corporation.* Any act or proceeding by any provision of this Indenture authorized or required to be done or performed by any board, committee or officer of the Company shall and may be done and performed with like force and effect by the like board, committee or officer of any corporation that shall at the time be the lawful sole successor of the Company.

Section 14.03. *Addresses for Notices, Notice to Holders, Waiver.* Any notice or demand which by any provision of this Indenture is required or permitted to be given or served by the Trustee or by the holders of Securities on the Company may be given or served by being deposited postage prepaid by first class mail in a post office letter box addressed (until another address is filed by the Company with the Trustee) to Genworth Financial, Inc., 6620 West Broad Street, Richmond, Virginia 23230. Any notice, direction, request or demand by any Securityholder to or upon the Trustee shall be deemed to have been sufficiently given or made, for all purposes, if given or made in writing at the principal corporate trust office of the Trustee, addressed to the attention of its corporate trust office as specified in Section 7.13 hereof or to any successor office established by notice given by the Trustee to the Company pursuant to this Section 14.03.

Where this Indenture provides for notice of holders of any event, such notice shall be sufficiently given (unless otherwise herein expressly provided) if in writing and mailed, first-class postage prepaid, to each holder affected by such event, at his address as it appears in the Security register, not later than the latest date (if any), and not earlier than the earliest date (if any), prescribed for the giving of such notice. In any case where notice to holders is given by mail, neither the failure to mail such notice, nor any defect in any notice so mailed, to any particular holder shall affect the sufficiency of such notice with respect to other holders. Where this Indenture provides for notice in any manner, such notice may be waived in writing by the Person entitled to receive such notice, either before or after the event, and such waiver shall be the equivalent of such notice. Waivers of notice by holders shall be filed with the Trustee, but such filing shall not be a condition precedent to the validity of any action taken in reliance upon such waiver.

In case by reason of the suspension of regular mail service or by reason of any other cause it shall be impracticable to give such notice by mail, then such

59

---

notification as shall be made with approval of the Trustee shall constitute a sufficient notification for every purpose hereunder.

Section 14.04. *New York Contract.* This Indenture and each Security shall be deemed to be a contract made under the laws of the State of New York, and for all purposes shall be construed in accordance with the laws of said State.

Section 14.05. *Evidence of Compliance with Conditions Precedent.* Upon any application or demand by the Company to the Trustee to take any action under any of the provisions of this Indenture, the Company shall furnish to the Trustee an Officers' Certificate stating that all conditions precedent, if any, provided for in this Indenture relating to the proposed action have been complied with and an Opinion of Counsel stating that, in the opinion of such counsel, all such conditions precedent have been complied with.

Each certificate or opinion provided for in this Indenture and delivered to the Trustee with respect to compliance with a condition or covenant provided for in this Indenture shall include: (1) a statement that the person making such certificate or opinion has read such covenant or condition; (2) a brief statement as to the nature and scope of the examination or investigation upon which the statements or opinion contained in such certificate or opinion are based; (3) a statement that, in the opinion of such person, he has made such examination or investigation as is necessary to enable him to express an informed opinion as to whether or not such covenant or condition has been complied with; and (4) a statement as to whether or not, in the opinion of such person, such condition or covenant has been complied with.

Section 14.06. *Legal Holidays.* In any case where the date of maturity of interest, if any, on or principal of, or premium, if any, on the Securities or the date fixed for redemption or repayment of any Security will be in The City of New York, New York, a Saturday, a Sunday, a legal holiday or a day on which banking institutions are authorized or required by law or executive order to close or remain closed, then payment of such interest, if any, on or principal of or premium, if any, on the Securities need not be made on such date but may be made on the next succeeding day not in such city, a Saturday, a Sunday, a legal holiday or a day on which banking institutions are authorized or required by law or executive order to close or remain closed, with the same force and effect as if made on the date of maturity or a date fixed for redemption or repayment, and no interest shall accrue for the period from and after such date.

Section 14.07. *Securities in a Specified Currency other than Dollars.* Unless otherwise specified as contemplated by Section 2.02 with respect to a particular series of Securities, whenever for purposes of this Indenture any action may be taken by the holders of a specified percentage in aggregate principal amount of Securities of all series or all series affected by a particular action at the time Outstanding and, at such time, there are Outstanding any Securities of any

60

---

series which are denominated in a Specified Currency other than Dollars then the principal amount of Securities of such series which shall be deemed to be Outstanding for

the purpose of taking such action shall be that amount of Dollars that could be obtained for such amount of such Specified Currency at the Market Exchange Rate. For purposes of this Section 14.07, Market Exchange Rate shall mean the noon Dollar buying rate in New York City for cable transfers of the Specified Currency published by the Federal Reserve Bank of New York. If such Market Exchange Rate is not available for any reason with respect to such Specified Currency, the Trustee shall use, in its sole discretion and without liability on its part, such quotation of the Federal Reserve Bank of New York or such other quotations as the Trustee shall deem appropriate. The provisions of this paragraph shall apply in determining the equivalent principal amount in respect of Securities of a series denominated in a Specified Currency other than Dollars in connection with any action taken by holders of Securities pursuant to the terms of this Indenture, including, without limitation, any determination contemplated in Section 6.01(d) or (e).

All decisions and determination of the Trustee regarding the Market Exchange Rate or any alternative determination provided for in the preceding paragraph shall be in its sole discretion and shall, in the absence of manifest error, be conclusive to the extent permitted by law for all purposes and irrevocably binding upon the Company and all Securityholders.

Section 14.08. *Trust Indenture Act to Control.* If and to the extent that any provision of this Indenture limits, qualifies or conflicts with the duties imposed by, or with another provision (an "incorporated provision") included in this Indenture by operation of, Sections 310 to 318, inclusive, of the Trust Indenture Act of 1939, such imposed duties or incorporated provision shall control.

Section 14.09. *Table of Contents, Headings, etc.* The table of contents and the titles and headings of the articles and sections of this Indenture have been inserted for convenience of reference only, are not to be considered a part hereof, and shall in no way modify or restrict any of the terms or provisions hereof.

Section 14.10. *Execution in Counterparts.* This Indenture may be executed in any number of counterparts, each of which shall be an original, but such counterparts shall together constitute but one and the same instrument.

Section 14.11. *Separability; Benefits.* In case any provision in this Indenture or in the Securities shall be invalid, illegal or unenforceable, the validity, legality and enforceability of the remaining provisions shall not in any way be affected or impaired thereby.

Nothing in this Indenture or in the Securities, expressed or implied, shall give to any person, other than the parties hereto and their successors hereunder,

61

---

and the holders of the Securities, any benefit or any legal or equitable right, remedy or claim under this Indenture.

62

---

IN WITNESS WHEREOF, the parties hereto have caused this Indenture to be duly executed, and their respective corporate seals to be hereunto affixed and attested, all as of \_\_\_\_\_, 2004.

GENWORTH FINANCIAL, INC.

By \_\_\_\_\_

[CORPORATE SEAL]

Attest:

By \_\_\_\_\_

THE BANK OF NEW YORK

By \_\_\_\_\_

[CORPORATE SEAL]

Attest:

By \_\_\_\_\_

63

---

IN WITNESS WHEREOF, the parties hereto have caused this Indenture to be duly executed, and their respective corporate seals to be hereunto affixed and attested, all as of \_\_\_\_\_, 2004.

GENWORTH FINANCIAL, INC.

By \_\_\_\_\_

[CORPORATE SEAL]

Attest:

By \_\_\_\_\_

THE BANK OF NEW YORK

By \_\_\_\_\_  
Name:  
Title:

[CORPORATE SEAL]

Attest:

By \_\_\_\_\_  
Name:  
Title:



GENWORTH FINANCIAL, INC.

AND

THE BANK OF NEW YORK,

as Trustee

---

SUPPLEMENTAL INDENTURE NO. 1

Dated as of May [•], 2004

---

THIS SUPPLEMENTAL INDENTURE No. 1 (this “**Supplemental Indenture No. 1**”), dated as of May [•], 2004, is between GENWORTH FINANCIAL, INC., a Delaware corporation (the “**Company**”), and THE BANK OF NEW YORK, a New York banking corporation, as Trustee (the “**Trustee**”).

R E C I T A L S

WHEREAS, the Company has concurrently herewith executed and delivered to the Trustee an Indenture dated as of May [•], 2004, between the Company and the Trustee (the “**Base Indenture**” and together with this Supplemental Indenture No. 1, the “**Indenture**”), providing for the issuance from time to time of one or more series of the Company’s Securities;

WHEREAS, Section 10.01(d) of the Base Indenture provides for the Company and the Trustee to enter into an indenture supplemental to the Base Indenture to establish the forms or terms of Securities of any series as permitted by Section 2.01 or Section 2.02 of the Base Indenture;

WHEREAS, pursuant to Section 2.02 of the Base Indenture, the Company wishes to provide for the issuance of a new series of Securities to be known as its [•]% Senior Notes due 2009 (the “**Senior Notes**”), the form and terms of such Senior Notes and the terms, provisions and conditions thereof to be set forth as provided in this Supplemental Indenture No. 1; and

WHEREAS, the Company has requested that the Trustee execute and deliver this Supplemental Indenture No. 1, and all requirements necessary to make this Supplemental Indenture No. 1 a valid, binding and enforceable instrument in accordance with its terms, and to make the Senior Notes, when executed by the Company and authenticated and delivered by the Trustee, the valid, binding and enforceable obligations of the Company, have been done and performed, and the execution and delivery of this Supplemental Indenture No. 1 has been duly authorized in all respects;

NOW, THEREFORE, in consideration of the covenants and agreements set forth herein and for other good and valuable consideration, the receipt and sufficiency of which are hereby acknowledged, the parties hereto hereby agree as follows:

ARTICLE 1  
DEFINITIONS

Section 1.01. *Relation to Base Indenture.* This Supplemental Indenture No. 1 constitutes an integral part of the Base Indenture.

1

Section 1.02. *Definition Of Terms.* For all purposes of this Supplemental Indenture No. 1:

- (a) Capitalized terms used herein without definition shall have the meanings set forth in the Base Indenture, or, if not defined in the Base Indenture, in the Purchase Contract and Pledge Agreement or the Remarketing Agreement;
- (b) a term defined anywhere in this Supplemental Indenture No. 1 has the same meaning throughout;
- (c) the singular includes the plural and vice versa;
- (d) headings are for convenience of reference only and do not affect interpretation;
- (e) the following terms have the meanings given to them in this Section 1.02(e):

“**Accounting Event**” means the receipt, at any time prior to the earlier of the date of a Successful Remarketing and the Purchase Contract Settlement Date, by the audit committee of the Board of Directors of a written report in accordance with Statement on Auditing Standards (“SAS”) No. 97, “Amendment to SAS No. 50 — Reports on the Application of Accounting Principles”, from the Company’s independent auditors, provided at the request of management of the Company, to the effect that, as a result of a change in accounting rules after the date of original issuance of the Senior Notes, the Company must either (a) account for the Purchase Contracts as derivatives under SFAS 133 (or otherwise mark-to-market or measure the fair value of all or any portion of the Purchase Contracts with changes appearing in the Company’s income statement) or (b) account for the Units using the if-converted method under SFAS 128, and, in each case, that such accounting treatment will cease to apply upon redemption of the Senior Notes.

“**Applicable Ownership Interest in Senior Notes**” has the meaning set forth in the Purchase Contract and Pledge Agreement.

“**Applicable Principal Amount**” means the aggregate principal amount of the Senior Notes underlying the Applicable Ownership Interests in Senior Notes that are components of Corporate Units on the Special Event Redemption Date.

“**Beneficial Owner**” has the meaning set forth in the Purchase Contract and Pledge Agreement.

---

“**Board of Directors**” has the meaning set forth in the Purchase Contract and Pledge Agreement.

“**Business Day**” has the meaning set forth in the Purchase Contract and Pledge Agreement.

“**Collateral Account**” has the meaning set forth in the Purchase Contract and Pledge Agreement.

“**Corporate Unit**” has the meaning set forth in the Purchase Contract and Pledge Agreement.

“**Coupon Rate**” has the meaning set forth in Section 2.05(a).

“**Depository**” has the meaning set forth in the Purchase Contract and Pledge Agreement.

“**Depository Participant**” has the meaning set forth in the Purchase Contract and Pledge Agreement.

“**Final Remarketing Date**” has the meaning set forth in the Purchase Contract and Pledge Agreement.

“**Global Senior Notes**” has the meaning set forth in Section 2.04.

“**Interest Payment Date**” means a Quarterly Interest Payment Date or a Semiannual Interest Payment Date.

“**Interest Period**” means, with respect to any Interest Payment Date, the period from and including the immediately preceding Interest Payment Date on which interest was paid or duly provided for (or if none, the Special Interest Payment Date) to, but excluding, such Interest Payment Date

“**Maturity Date**” has the meaning set forth in Section 2.02.

“**Person**” means a legal person, including any individual, corporation, estate, partnership, joint venture, association, joint-stock company, limited liability company, trust, unincorporated organization or government or any agency or political subdivision thereof or any other entity of whatever nature.

“**Pledged Applicable Ownership Interests in Senior Notes**” has the meaning set forth in the Purchase Contract and Pledge Agreement.

“**Purchase Contract and Pledge Agreement**” means the Purchase Contract and Pledge Agreement, dated as of May [•], 2004, among the Company,

---

The Bank of New York, as Purchase Contract Agent, and attorney-in-fact for Holders of the Purchase Contract, and The Bank of New York, as Collateral Agent, Custodial Agent and Securities Intermediary, as amended from time to time.

“**Purchase Contract Settlement Date**” has the meaning set forth in the Purchase Contract and Pledge Agreement.

“**Put Price**” has the meaning set forth in Section 8.05(a).

“**Put Right**” has the meaning set forth in Section 8.05(a).

“**Quarterly Interest Payment Date**” has the meaning set forth in Section 2.05(b)(i).

“**Quotation Agent**” means any primary U.S. government securities dealer selected by the Company.

“**Record Date**” means, with respect to any Interest Payment Date for the Senior Notes, the first Business Day of the calendar month in which such Interest Payment Date falls.

“**Redemption Amount**” means, for each Senior Note, an amount equal to the product of the principal amount of such Senior Note and a fraction, the numerator of which is the Treasury Portfolio Purchase Price and the denominator of which is the Applicable Principal Amount; *provided* that in no event shall the Redemption Amount for any Senior Note be less than the principal amount of such Senior Note.

“**Redemption Price**” shall mean, for each Senior Note, the Redemption Amount plus any accrued and unpaid interest on such Senior Note to, but excluding, the Special Event Redemption Date.

“**Remarketed Senior Notes**” has the meaning set forth in the Remarketing Agreement.

“**Remarketing Agent**” means Morgan Stanley & Co. Incorporated, or any successor thereto or replacement Remarketing Agent appointed by the Company pursuant to the Remarketing Agreement.

“**Remarketing Agreement**” means the Remarketing Agreement, dated as of May [•], 2004, among the Company, Morgan Stanley & Co. Incorporated, as Remarketing Agent and The Bank of New York, as Purchase Contract Agent, as amended from time to time.

---

“**Remarketing Fee**” has the meaning set forth in the Remarketing Agreement.

“**Remarketing Price**” has the meaning set forth in the Remarketing Agreement.

“**Reset Rate**” has the meaning set forth in the Remarketing Agreement.

“**Semiannual Interest Payment Date**” has the meaning set forth in Section 2.05(b)(ii).

“**Separate Senior Notes**” has the meaning set forth in the Purchase Contract and Pledge Agreement.

“**Special Event**” shall mean either a Tax Event or an Accounting Event.

“**Special Event Redemption**” means the redemption of the Senior Notes pursuant to the terms of Article 3 hereof following the occurrence of a Special Event.

“**Special Event Redemption Date**” has the meaning set forth in Section 3.01.

“**Special Interest Payment Date**” has the meaning set forth in Section 2.05(d).

“**Tax Event**” means the receipt by the Company of an opinion of counsel, rendered by a law firm having a recognized national tax practice, at any time prior to the earlier of the date of a Successful Remarketing and the Purchase Contract Settlement Date, to the effect that, as a result of any amendment to, change in or announced proposed change in the laws (or any regulations thereunder) of the United States or any political subdivision or taxing authority thereof or therein, or as a result of any official administrative decision, pronouncement, judicial decision or action interpreting or applying such laws or regulations, which amendment or change is effective or which proposed change, pronouncement, action or decision is announced on or after the date of issuance of the Senior Notes, there is more than an insubstantial increase in the risk that interest payable by the Company on the Senior Notes is not, or within 90 days of the date of such opinion, will not be, deductible by the Company, in whole or in part, for United States federal income tax purposes.

“**Termination Event**” has the meaning set forth in the Purchase Contract and Pledge Agreement.

5

---

“**Treasury Portfolio**” means a portfolio of U.S. Treasury securities (or principal or interest strips thereof) that mature on or prior to May 15, 2007 in an aggregate amount at maturity equal to the Applicable Principal Amount and with respect to each scheduled Interest Payment Date on the Senior Notes that occurs after the Special Event Redemption Date, to and including the Purchase Contract Settlement Date, U.S. Treasury securities (or principal or interest strips thereof) that mature on or prior to the Business Day immediately preceding such scheduled Interest Payment Date in an aggregate amount at maturity equal to the aggregate interest payment (assuming no reset of the interest rate) that would be due on the Applicable Principal Amount of the Senior Notes on such date.

“**Treasury Portfolio Purchase Price**” means the lowest aggregate ask-side price quoted by a primary U.S. government securities dealer to the Quotation Agent between 9:00 a.m. and 11:00 a.m., New York City time, on the third Business Day immediately preceding the Special Event Redemption Date for the purchase of the Treasury Portfolio for settlement on the Special Event Redemption Date.

“**Treasury Unit**” has the meaning set forth in the Purchase Contract and Pledge Agreement.

The terms “**Company**,” “**Trustee**,” “**Indenture**,” “**Base Indenture**” and “**Senior Notes**” shall have the respective meanings set forth in the recitals to this Supplemental Indenture No. 1 and the paragraph preceding such recitals.

## ARTICLE 2 GENERAL TERMS AND CONDITIONS OF THE SENIOR NOTES

Section 2.01. *Designation and Principal Amount.* There is hereby authorized a series of Securities designated as [•]% Senior Notes due 2009 limited in aggregate principal amount to \$600,000,000. The Senior Notes may be issued from time to time upon written order of the Company for the authentication and delivery of Senior Notes pursuant to Section 2.03 of the Base Indenture.

Section 2.02. *Maturity.* Unless a Special Event Redemption occurs prior to the Maturity Date (defined below), the date upon which the Senior Notes shall become due and payable at final maturity, together with any accrued and unpaid interest, is May 16, 2009 (the “**Maturity Date**”).

Section 2.03. *Form, Payment and Appointment.* Except as provided in Section 2.04, the Senior Notes shall be issued in fully registered, certificated form, bearing identical terms. Principal of and interest on the Senior Notes will be payable, the transfer of such Senior Notes will be registrable, and such Senior

6

---

Notes will be exchangeable for Senior Notes of a like aggregate principal amount bearing identical terms and provisions, at the office or agency of the Company maintained for such purpose in the Borough of Manhattan, The City of New York, which shall initially be the corporate trust office of the Trustee; *provided, however*, that payment of interest may be made at the option of the Company by check mailed to the holder at such address as shall appear in the Security register or by wire transfer to an account appropriately designated by the holder entitled to payment.

No service charge shall be made for any registration of transfer or exchange of the Senior Notes, but the Company may require payment from the holder of a sum sufficient to cover any tax or other governmental charge that may be imposed in connection therewith.

The Security Registrar and Paying Agent for the Senior Notes shall initially be the Trustee.

The Senior Notes shall be issuable in denominations of \$1,000 and integral multiples of \$1,000 in excess thereof; *provided, however*, that upon the release by the Collateral Agent of Senior Notes underlying the Pledged Applicable Ownership Interests in Senior Notes (other than any release of Senior Notes underlying Pledged Applicable Ownership Interests in Senior Notes in connection with (i) the creation of Treasury Units by Collateral Substitution, (ii) a Successful Remarketing, (iii) Cash Merger Early Settlement, (iv) Early Settlement or (v) Cash Settlement, in accordance with Section 3.13, Section 5.02(b), Section 5.04, Section 5.07 or Section 5.02(a) of the Purchase Contract and Pledge Agreement, as the case may be), the Senior Notes shall be issuable in denominations of \$25 and integral multiples of \$25 in excess thereof, and the Company shall issue Senior Notes in any such denominations if requested by the Purchase Contract Agent on behalf of any Holder or Beneficial Owner.

Section 2.04. *Global Senior Notes.* Senior Notes corresponding to Applicable Ownership Interests in Senior Notes that are no longer a component of the Corporate Units and are released from the Collateral Account will be issued in permanent global form (a “**Global Senior Note**”), and if issued as one or more Global Senior Notes, the Depository shall be The Depository Trust Company or such other depository as any officer of the Company may from time to time designate. Upon the creation of Treasury Units, or the re-creation of Corporate Units, an appropriate annotation shall be made on the Schedule of Increases and Decreases on the Global Senior Notes held by the Depository. Unless and until such Global Senior Note is exchanged for Senior Notes in certificated form, Global Senior Notes may be transferred, in whole but not in part, and any payments on the Senior Notes shall be made, only to the Depository or a nominee

7

---

of the Depository, or to a successor Depository selected or approved by the Company or to a nominee of such successor Depository.

Section 2.05. *Interest.* (a) The Senior Notes will bear interest initially at the rate of  $f\%$  per year (the “**Coupon Rate**”) from and including May  $\bullet$ , 2004 to, but excluding, the Maturity Date, or in the event of a Successful Remarketing, the Purchase Contract Settlement Date. In the event of a Successful Remarketing of the Senior Notes, the Coupon Rate will be reset by the Remarketing Agent to the Reset Rate with effect from the Purchase Contract Settlement Date, as set forth in Section 8.03. If the Coupon Rate is so reset, the Senior Notes will bear interest at the Reset Rate from and including the Purchase Contract Settlement Date to, but excluding, the Maturity Date. The Senior Notes shall bear interest, to the extent permitted by law, on any overdue principal and interest at the Coupon Rate, unless a Successful Remarketing shall have occurred, in which case interest on such amounts shall accrue at the Reset Rate from and after the Purchase Contract Settlement Date, in each case, compounded quarterly through the Purchase Contract Settlement Date and compounded semi-annually, thereafter.

(b) (i) Prior to and on the Purchase Contract Settlement Date, interest on the Senior Notes shall be payable quarterly in arrears on February 16, May 16, August 16 and November 16 of each year (each, a “**Quarterly Interest Payment Date**”), commencing August 16, 2004, to the Person in whose name the relevant Senior Notes are registered at the close of business on the Record Date for such Interest Payment Date.

(ii) After the Purchase Contract Settlement Date, interest on the Senior Notes shall be payable semi-annually in arrears on May 16 and November 16 of each year (each, a “**Semiannual Interest Payment Date**”), commencing November 16, 2007, to the Person in whose name the relevant Senior Notes are registered at the close of business on the Record Date for such Interest Payment Date.

(c) The amount of interest payable for any full Interest Period will be computed on the basis of a 360-day year consisting of twelve 30-day months. The amount of interest payable for any period shorter than a full Interest Period for which interest is computed will be computed on the basis of a 30-day month and, for any period less than a month, on the basis of the actual number of days elapsed per 30-day month. In the event that any scheduled Interest Payment Date falls on a day that is not a Business Day, then payment of interest payable on such Interest Payment Date will be made on the next succeeding day which is a Business Day (and without any interest or other payment in respect of any such delay).

8

(d) In addition, the Company shall pay on May  $\bullet$ , 2004 (the “**Special Interest Payment Date**”), the interest accrued from and including May  $\bullet$ , 2004, to, but excluding, the Special Interest Payment Date to the Person in whose name the Senior Notes are registered at the close of business on the Business Day immediately preceding the Special Interest Payment Date. The interest payable on the Special Interest Payment Date shall be calculated based on the actual number of days elapsed divided by 360 and shall be paid by wire transfer to the account designated by the Person entitled to receive such payment by prior notice to the Company and the Trustee.

Section 2.06. *No Defeasance.* Section 12.02 and Section 12.03 of the Base Indenture shall not apply to the Senior Notes.

Section 2.07. *No Sinking Fund or Repayment at Option of the Holder.* The Senior Notes are not entitled to the benefit of any sinking fund and Section 3.06 of the Base Indenture shall not apply to the Senior Notes.

### ARTICLE 3 REDEMPTION OF THE SENIOR NOTES

Section 3.01. *Special Event Redemption.* If a Special Event shall occur and be continuing, the Company may, at its option, redeem the Senior Notes in whole, but not in part, on any Interest Payment Date prior to the earlier of the date of a Successful Remarketing and the Purchase Contract Settlement Date, at a price per Senior Note equal to the Redemption Price, payable on the date of redemption (the “**Special Event Redemption Date**”) to the Person in whose name the relevant Senior Notes are registered at the close of business on the Special Event Redemption Date; *provided* that if a Special Event Redemption Date falls after a Record Date, but on or prior to the corresponding Interest Payment Date, the Redemption Price shall not include any accrued and unpaid interest corresponding to such Interest Payment Date, and the full amount of interest for the relevant Interest Period will be payable to the Person in whose name the Senior Notes are registered at the close of business on the relevant Record Date.

Section 3.02. *Notice of Redemption.* If the Company so elects to redeem the Senior Notes, the Company shall appoint the Quotation Agent to assist the Company in determining the Treasury Portfolio Purchase Price. Notice of any Special Event Redemption will be mailed by the Company (with a copy to the Trustee) at least 30 days but not more than 60 days before the Special Event Redemption Date to each Person in whose name the Senior Notes are registered at its registered address. In addition, the Company shall notify the Collateral Agent

9

in writing that a Special Event has occurred and that the Company intends to redeem the Senior Notes on the Special Event Redemption Date.

Section 3.03. *Effect of Redemption.* Unless the Company defaults in the payment of the Redemption Price, on and after the Special Event Redemption Date, (a) interest shall cease to accrue on the Senior Notes, (b) the Senior Notes shall become due and payable at the Redemption Price, and (c) the Senior Notes shall be void and all rights of the holders in respect of the Senior Notes shall terminate and lapse (other than the right to receive the Redemption Price upon surrender of such Senior Notes but without interest on such Redemption Price). Following the notice of a Special Event Redemption, neither the Company nor the Trustee shall be required to register the transfer of or exchange the Senior Notes to be redeemed.

Section 3.04. *Redemption Procedures.* On or prior to the Special Event Redemption Date, the Company shall deposit with the Trustee immediately available funds in an amount sufficient to pay, on the Special Event Redemption Date, the aggregate Redemption Price for all outstanding Senior Notes. In exchange for any Senior Notes surrendered for redemption on or after the Special Event Redemption Date, the Trustee shall pay an amount equal to the Redemption Price (a) to the Collateral Agent, in the case of Senior Notes that underlie the Applicable Ownership Interests in Senior Notes included in Corporate Units, which amount shall be applied by the Collateral Agent in accordance with the terms of the Purchase Contract and Pledge Agreement, and (b) to the holders of the Separate Senior Notes, in the case of Separate Senior Notes.

Section 3.05. *No Other Redemption.* Except as set forth in this Article 3, the Senior Notes shall not be redeemable by the Company prior to the Maturity Date. The provisions of this Article 3 shall supersede any conflicting provisions contained in Article 3 of the Base Indenture.

### ARTICLE 4 FORM OF SENIOR NOTE

Section 4.01. *Form of Senior Note.* The Senior Notes and the Trustee’s Certificate of Authentication to be endorsed thereon are to be substantially in the forms attached as Exhibit A hereto, with such changes therein as the officers of the Company executing the Senior Notes (by manual or facsimile signature) may approve, such approval to be conclusively evidenced by their execution thereof.

10

ARTICLE 5  
ORIGINAL ISSUE OF SENIOR NOTES

Section 5.01. *Original Issue of Senior Notes.* Senior Notes in the aggregate principal amount of \$600,000,000 may from time to time, upon execution of this Supplemental Indenture No. 1, be executed by the Company and delivered to the Trustee for authentication, and the Trustee shall thereupon authenticate and deliver said Senior Notes to or upon the written order of the Company pursuant to Section 2.03 of the Base Indenture without any further action by the Company (other than as required by the Base Indenture).

ARTICLE 6  
SUPPLEMENTAL INDENTURES

Section 6.01. *Supplemental Indentures with Consent of holders of Senior Notes.* As set forth in Section 10.02 of the Base Indenture, with the consent of the holders of a majority in the aggregate principal amount of Senior Notes affected by such supplemental indenture at the time outstanding, the Company and the Trustee may from time to time and at any time enter into an indenture or indentures supplemental thereto or to the Base Indenture for the purpose of adding any provisions to or changing in any manner or eliminating any of the provisions of the Base Indenture or this Supplemental Indenture or of modifying in any manner the rights of the holders of the Senior Notes; *provided, however,* that, in addition to clauses (i) through (iv) of Section 10.02 of the Base Indenture, no such indenture or supplemental indenture shall (a) reduce the Put Price, (b) change the exercise date of the Put Right, (c) modify the terms of the Put Right or (d) modify the interest rate reset or Remarketing provisions of the Senior Notes, without, in the case of each of the foregoing clauses (a), (b), (c) and (d), the consent of the holder of each Senior Note affected.

ARTICLE 7  
MISCELLANEOUS

Section 7.01. *Ratification of Indenture.* The Indenture, as supplemented by this Supplemental Indenture No. 1, is in all respects ratified and confirmed, and this Supplemental Indenture No. 1 shall be deemed part of the Indenture in the manner and to the extent herein and therein provided.

Section 7.02. *Trustee Not Responsible for Recitals.* The recitals herein contained are made by the Company and not by the Trustee, and the Trustee assumes no responsibility for the correctness thereof. The Trustee makes no

11

---

representation as to the validity or sufficiency of this Supplemental Indenture No. 1.

Section 7.03. *New York Law To Govern.* THIS SUPPLEMENTAL INDENTURE NO. 1 AND EACH SENIOR NOTE SHALL BE DEEMED TO BE CONTRACTS MADE UNDER THE LAWS OF THE STATE OF NEW YORK AND SHALL BE GOVERNED BY, AND CONSTRUED IN ACCORDANCE WITH, THE LAWS OF THE STATE OF NEW YORK WITHOUT GIVING EFFECT TO THE CONFLICTS OF LAW PROVISIONS THEREOF TO THE EXTENT A DIFFERENT LAW WOULD GOVERN AS A RESULT.

Section 7.04. *Separability.* In case any one or more of the provisions contained in this Supplemental Indenture or in the Senior Notes shall for any reason be held to be invalid, illegal or unenforceable in any respect, then, to the extent permitted by law, such invalidity, illegality or unenforceability shall not affect any other provisions of this Supplemental Indenture No. 1 or of the Senior Notes, but this Supplemental Indenture No. 1 and the Senior Notes shall be construed as if such invalid or illegal or unenforceable provision had never been contained herein or therein.

Section 7.05. *Counterparts.* This Supplemental Indenture may be executed in any number of counterparts each of which shall be an original, but such counterparts shall together constitute but one and the same instrument.

ARTICLE 8  
REMARKETING

Section 8.01. *Remarketing Procedures.* (a) Unless a Special Event Redemption or a Termination Event has occurred prior to the Initial Remarketing Date, the Company shall engage the Remarketing Agent pursuant to the Remarketing Agreement for the Remarketing of the Senior Notes. The Company will request, not later than 20 Business Days prior to the Initial Remarketing Date, that the Depository or its nominee notify the Beneficial Owners or Depository Participants holding Separate Senior Notes, Corporate Units and Treasury Units of the procedures to be followed in the Remarketing, including, in the case of a Failed Final Remarketing, the procedures that must be followed by a holder of Separate Senior Notes if such holder wishes to exercise its Put Right or by a holder of Applicable Ownership Interests in Senior Notes if such Holder elects not to exercise its Put Right.

12

---

(b) Each holder of Separate Senior Notes may elect to have Separate Senior Notes held by such holder remarketed in any Remarketing. A holder making such an election must, pursuant to the Purchase Contract and Pledge Agreement, notify the Custodial Agent and deliver such Separate Senior Notes to the Custodial Agent prior to 5:00 p.m., New York City time, on the seventh Business Day immediately preceding the Purchase Contract Settlement Date (but no earlier than the Interest Payment Date immediately preceding the Initial Remarketing Date). Any such notice and delivery may not be conditioned upon the level at which the Reset Rate is established in the Remarketing. Any such notice and delivery may be withdrawn prior to 5:00 p.m., New York City time, on the seventh Business Day immediately preceding the Purchase Contract Settlement Date in accordance with the provisions set forth in the Purchase Contract and Pledge Agreement. Any such notice and delivery not withdrawn by such time will be irrevocable with respect to each Remarketing. Pursuant to Section 5.02 of the Purchase Contract and Pledge Agreement, promptly after 11:00 a.m., New York City time, on the Business Day immediately preceding the Initial Remarketing Date, the Custodial Agent, based on the notices and deliveries received by it prior to such time, shall notify the Remarketing Agent of the principal amount of Separate Senior Notes tendered for remarketing and shall cause such Separate Senior Notes to be presented to the Remarketing Agent. Under Section 5.02 of the Purchase Contract and Pledge Agreement, Senior Notes that underlie Applicable Ownership Interests in Senior Notes included in Corporate Units will be deemed tendered for Remarketing and will be remarketed in accordance with the terms of the Remarketing Agreement.

(c) The right of each holder of Remarketed Senior Notes to have such Senior Notes remarketed and sold on any Remarketing Date s shall be subject to the conditions that (i) the Remarketing Agent conducts a Remarketing pursuant to the terms of the Remarketing Agreement on such Remarketing Date, (ii) neither a Special Event Redemption nor a Termination Event has occurred prior to such Remarketing Date, (iii) the Remarketing Agent is able to find a purchaser or purchasers for Remarketed Senior Notes at the Remarketing Price based on the Reset Rate and (iv) the purchaser or purchasers deliver the purchase price therefor to the Remarketing Agent as and when required.

(d) Neither the Trustee, the Company nor the Remarketing Agent shall be obligated in any case to provide funds to make payment upon tender of Senior Notes for remarketing.

Section 8.02. *Remarketing.* (a) Unless a Special Event Redemption or a Termination Event has occurred prior to the Initial Remarketing Date, on the Initial Remarketing Date, the Remarketing Agent shall, pursuant and subject to

the terms of the Remarketing Agreement, use its reasonable efforts to remarket the Remarketed Senior Notes at the Remarketing Price.

(b) In the case of a Failed Initial Remarketing, on the Second Remarketing Date, the Remarketing Agent shall use its reasonable efforts to remarket the Remarketed Senior Notes at the Remarketing Price. In the case of a Failed Second Remarketing, on the Final Remarketing Date, the Remarketing Agent shall use its reasonable efforts to remarket the Remarketed Senior Notes at the Remarketing Price. It is understood and agreed that Remarketing on any Remarketing Date will be considered successful and no further attempts will be made if the resulting proceeds are at least equal to the Remarketing Price.

Section 8.03. *Reset Rate.* (a) In connection with each Remarketing, the Remarketing Agent shall determine the Reset Rate (rounded to the nearest one-thousandth (0.001) of one percent per annum).

(b) Anything herein to the contrary notwithstanding, the Reset Rate shall in no event exceed the maximum rate permitted by applicable law.

(c) In the event of a Failed Remarketing or if no Applicable Ownership Interests in Senior Notes are included in Corporate Units and none of the holders of the Separate Senior Notes elect to have their Senior Notes remarketed in any Remarketing, the applicable interest rate on the Senior Notes will not be reset and will continue to be the Coupon Rate.

(d) In the event of a Successful Remarketing, the Coupon Rate shall be reset on the Purchase Contract Settlement Date to the Reset Rate as determined by the Remarketing Agent under the Remarketing Agreement, and the Company shall issue a press release containing such Reset Rate and publish such information on its website.

Section 8.04. *Failed Remarketing.* If, by 4:00 p.m., New York City time, on any Remarketing Date, the Remarketing Agent is unable to remarket all of the Remarketed Senior Notes at the Remarketing Price pursuant to the terms and conditions hereof and of the Remarketing Agreement, a Failed Remarketing shall be deemed to have occurred.

Section 8.05. *Put Right.*

(a) Subject to paragraph (b) hereof, if there has not been a Successful Remarketing on or prior to the Final Remarketing Date, holders of Senior Notes will, subject to this Section 8.05, have the right (the "**Put Right**") to require the Company to purchase such Senior Notes on the Purchase Contract Settlement Date, at a price per Senior Note to be purchased equal to the principal amount of

the applicable Senior Note, plus accrued and unpaid interest to, but excluding, the Purchase Contract Settlement Date (the "**Put Price**").

(b) The Put Right of holders of Applicable Ownership Interests in Senior Notes that are part of Corporate Units will be deemed to be automatically exercised unless such holders (1) prior to 5:00 p.m., New York City time, on the second Business Day immediately preceding the Purchase Contract Settlement Date, provide written notice to the Purchase Contract Agent of their intention to settle the related Purchase Contract with separate cash, and (2) on or prior to 5:00 p.m., New York City time, on the Business Day immediately preceding the Purchase Contract Settlement Date, deliver to the Collateral Agent \$25 in cash per Purchase Contract, in each case pursuant to the Purchase Contract Agreement, and such holders shall be deemed to have elected to pay the Purchase Price for the shares of Common Stock to be issued under the related Purchase Contract from a portion of the proceeds of the Put Right of the Senior Notes underlying such Applicable Ownership Interests in Senior Notes equal to the Purchase Price in full satisfaction of such holders' obligations under the Purchase Contracts, and any remaining amount of the Put Price following satisfaction of the related Purchase Contracts will be paid to such holder.

(c) The Put Right of a holder of a Separate Senior Note shall only be exercisable upon delivery of a notice to the Trustee by such holder on or prior to the second Business Day immediately preceding the Purchase Contract Settlement Date. On or prior to the Purchase Contract Settlement Date, the Company shall deposit with the Trustee immediately available funds in an amount sufficient to pay, on the Purchase Contract Settlement Date, the aggregate Put Price of all Separate Senior Notes with respect to which a holder has exercised a Put Right. In exchange for any Separate Senior Notes surrendered pursuant to the Put Right, the Trustee shall then distribute such amount to the holders of such Separate Senior Notes.

Section 8.06. *Additional Event of Default.* In addition to the events listed as Events of Default in Section 6.01 of the Base Indenture, it shall be an additional Event of Default with respect to the Senior Notes, if the Company defaults in the payment of the Put Price with respect to any Senior Note following the exercise of the Put Right by any holder in accordance with Section 8.05.

#### ARTICLE 9 TAX TREATMENT

Section 9.01. *Tax Treatment.* The Company agrees, and by acceptance of a Corporate Unit or a Separate Senior Note, each holder will be deemed to have

agreed (1) for United States federal, state and local income and franchise tax purposes to treat the acquisition of a Corporate Unit as the acquisition of an Applicable Ownership Interest in Senior Notes and the Purchase Contract constituting the Corporate Unit and (2) to treat the Applicable Ownership Interest in Senior Notes or Separate Senior Note, as the case may be, as indebtedness for United States federal, state and local income and franchise tax purposes.

IN WITNESS WHEREOF, the parties hereto have caused this Supplemental Indenture No. 1 to be duly executed, as of the day and year first written above.

GENWORTH FINANCIAL, INC.

By: \_\_\_\_\_  
Name:  
Title:

By: \_\_\_\_\_  
Name:  
Title:

[CORPORATE SEAL]

Attest:

\_\_\_\_\_  
Name:  
Title:

THE BANK OF NEW YORK, as Trustee

By: \_\_\_\_\_  
Name:  
Title:

[CORPORATE SEAL]

Attest:

\_\_\_\_\_  
Name:  
Title:

\_\_\_\_\_  
Name:  
Title:

EXHIBIT A

[IF THIS SENIOR NOTE IS TO BE A GLOBAL SECURITY, INSERT:]

THIS SENIOR NOTE IS A GLOBAL SECURITY WITHIN THE MEANING OF THE INDENTURE HEREINAFTER REFERRED TO AND IS REGISTERED IN THE NAME OF THE DEPOSITORY TRUST COMPANY OR A NOMINEE OF THE DEPOSITORY TRUST COMPANY. THIS SENIOR NOTE IS EXCHANGEABLE FOR SECURITIES REGISTERED IN THE NAME OF A PERSON OTHER THAN THE DEPOSITORY TRUST COMPANY OR ITS NOMINEE ONLY IN THE LIMITED CIRCUMSTANCES DESCRIBED IN THE INDENTURE AND MAY NOT BE TRANSFERRED EXCEPT AS A WHOLE BY THE DEPOSITORY TRUST COMPANY TO A NOMINEE OF THE DEPOSITORY TRUST COMPANY OR BY A NOMINEE OF THE DEPOSITORY TRUST COMPANY TO THE DEPOSITORY TRUST COMPANY OR ANOTHER NOMINEE OF THE DEPOSITORY TRUST COMPANY.

UNLESS THIS CERTIFICATE IS PRESENTED BY AN AUTHORIZED REPRESENTATIVE OF THE DEPOSITORY TRUST COMPANY, A NEW YORK CORPORATION ("DTC"), TO THE ISSUER OR ITS AGENT FOR REGISTRATION OF TRANSFER, EXCHANGE, OR PAYMENT, AND ANY CERTIFICATE ISSUED IS REGISTERED IN THE NAME OF CEDE & CO. OR IN SUCH OTHER NAME AS IS REQUESTED BY AN AUTHORIZED REPRESENTATIVE OF DTC (AND ANY PAYMENT IS MADE TO CEDE & CO. OR TO SUCH OTHER ENTITY AS IS REQUESTED BY AN AUTHORIZED REPRESENTATIVE OF DTC), ANY TRANSFER, PLEDGE, OR OTHER USE HEREOF FOR VALUE OR OTHERWISE BY OR TO ANY PERSON IS WRONGFUL INASMUCH AS THE REGISTERED OWNER HEREOF, CEDE & CO., HAS AN INTEREST HEREIN.

**GENWORTH FINANCIAL, INC.**

[•]% Senior Notes due [•], 2009

CUSIP:

No. \$

GENWORTH FINANCIAL, INC., a corporation organized and existing under the laws of Delaware (hereinafter called the "Company", which term includes any successor corporation under the Indenture hereinafter referred to), for value received, hereby promises to pay to \_\_\_\_\_, or registered assigns,

the principal sum as set forth in the Schedule of Increases or Decreases In Senior Note attached hereto, which amount shall not exceed \$600,000,000, on May 16, 2009 (such date is hereinafter referred to as the "Maturity Date"), and to pay interest thereon from the Special Interest Payment Date or from the most recent Interest Payment Date to which interest has been paid or duly provided for, quarterly in arrears on February 16, May 16, August 16 and November 16 of each year (each, a "Quarterly Interest Payment Date"), commencing August 16, 2004 at the rate of [•]% per annum through and including the day immediately preceding the Purchase Contract Settlement Date, and thereafter semi-annually in arrears on May 16 and November 16 of each year (each, a "Semiannual Interest Payment Date"), commencing November 16, 2007, at the Reset Rate, or if there has not been a Successful Remarketing prior to the Purchase Contract Settlement Date, at the Coupon Rate, on the basis of a 360-day year consisting of twelve 30-day months, until the principal hereof is paid or duly provided for or made available for payment. The Senior Notes shall bear interest, to the extent permitted by law, on any overdue principal and interest at the Coupon Rate, unless a Successful Remarketing shall have occurred, in which case interest on such amounts shall accrue at the Reset Rate from and after the Purchase Contract Settlement Date, in each case, compounded quarterly through the Purchase Contract Settlement Date and compounded semi-annually thereafter. The Reset Rate, if any, shall be established pursuant to the terms of the Indenture and the Remarketing Agreement. The amount of interest payable for any period shorter than a full Interest Period for which interest is computed will be computed on the basis of a 30-day month and, for any period less than a month, on the basis of the actual number of days elapsed per 30-day month. The interest so payable, and punctually paid or duly provided for, on any Interest Payment Date will, as provided in the Indenture, be paid to the Person in whose name this Senior Note (or one or more predecessor Senior Notes) is registered at the close of business on the Record Date for such Interest Payment Date.

In addition, the Company shall pay on May [•], 2004 (the “**Special Interest Payment Date**”), the interest accrued from and including May [•], 2004, to, but excluding, the Special Interest Payment Date to the Person in whose name the Senior Notes are registered at the close of business on the Business Day immediately preceding the Special Interest Payment Date. The interest payable on the Special Interest Payment Date shall be calculated based on the actual number of days elapsed divided by 360 and shall be paid by wire transfer to the account designated by the Person entitled to receive such payment by prior notice to the Company and the Trustee.

Payment of the principal of and interest on this Senior Note will be made at the office or agency of the Company maintained for that purpose in The Borough of Manhattan, The City of New York, which shall initially be the corporate trust office of the Trustee, in such coin or currency of the United States

A-2

---

of America as at the time of payment is legal tender for payment of public and private debts; *provided, however*, that payment of interest may be made at the option of the Company by check mailed to the holder at such address as shall appear in the Security register or by wire transfer to an account appropriately designated by the holder entitled to payment.

Reference is hereby made to the further provisions of this Senior Note set forth on the reverse hereof, which further provisions shall for all purposes have the same effect as if set forth at this place.

Unless the certificate of authentication hereon has been executed by the Trustee referred to on the reverse hereof by manual signature, this Senior Note shall not be entitled to any benefit under the Indenture or be valid or obligatory for any purpose.

A-3

---

IN WITNESS WHEREOF, the Company has caused this instrument to be duly executed under its corporate seal.

Dated:

GENWORTH FINANCIAL, INC.

By: \_\_\_\_\_  
Name:  
Title:

By: \_\_\_\_\_  
Name:  
Title:

[CORPORATE SEAL]

Attest:

By: \_\_\_\_\_  
Name:  
Title:

#### TRUSTEE'S CERTIFICATE OF AUTHENTICATION

This is one of the Senior Notes referred to in the within mentioned Indenture.

Dated: \_\_\_\_\_

THE BANK OF NEW YORK,  
as Trustee

By: \_\_\_\_\_  
Authorized Signatory

---

#### REVERSE OF SENIOR NOTE

This Senior Note is one of a duly authorized issue of securities of the Company (herein called the “**Senior Notes**”), issued and to be issued in one or more series under an Indenture (the “**Base Indenture**”), dated as of May [•], 2004, between the Company and The Bank of New York, as Trustee (herein called the “**Trustee**”, which term includes any successor trustee), as amended and supplemented by Supplemental Indenture No. 1, dated as of May [•], 2004, between the Company and the Trustee (the “**Supplemental Indenture No. 1**” and together with the Base Indenture, the “**Indenture**”), to which Indenture reference is hereby made for a statement of the respective rights, limitations of rights, duties and immunities thereunder of the Company, the Trustee and the holders of the Senior Notes and of the terms upon which the Senior Notes are, and are to be, authenticated and delivered. This Senior Note is one of the series designated on the face hereof, limited in aggregate principal amount to \$600,000,000.

All terms used in this Senior Note that are defined in the Indenture shall have the meaning assigned to them in the Indenture.

If a Special Event shall occur and be continuing, the Company may, at its option, redeem the Senior Notes of this series in whole, but not in part, on any Interest Payment Date prior to the earlier of the date of a Successful Remarketing or the Purchase Contract Settlement Date, at a price per Senior Note equal to the Redemption Price as set forth in the Indenture. Except as set forth in the preceding sentence and in Article 3 of the Supplemental Indenture No. 1, the Company may not redeem the Senior Notes at its option prior to the Maturity Date.



Pursuant to Section 8.05 of the Supplemental Indenture No. 1, if there has not been a Successful Remarketing on or prior to the Final Remarketing Date, holders of Senior Notes will have the right (the "Put Right") to require the Company to purchase such Senior Notes on the Purchase Contract Settlement Date, in the case of Separate Senior Notes upon a notice to the Trustee on or prior to the second Business Day prior to the Purchase Contract Settlement Date, at a price per Senior Note to be purchased equal to the principal amount of the applicable Senior Note, plus accrued and unpaid interest to, but excluding, the Purchase Contract Settlement Date (the "Put Price").

The Senior Notes are not entitled to the benefit of any sinking fund and will not be subject to defeasance or covenant defeasance.

If an Event of Default with respect to Senior Notes of this series shall occur and be continuing, the principal of the Senior Notes of this series may be

R-1

declared due and payable in the manner and with the effect provided in the Indenture.

The Indenture permits, with certain exceptions as therein provided, the amendment thereof and the modification of the rights and obligations of the Company and the rights of the holders of the Senior Notes at any time by the Company and the Trustee with the consent of the holders of a majority in principal amount of the Senior Notes at the time outstanding. The Indenture also contains provisions permitting the holders of specified percentages in principal amount of the Senior Notes at the time outstanding, on behalf of the holders of all Senior Notes, to waive compliance by the Company with certain provisions of the Indenture and certain past defaults under the Indenture and their consequences. Any such consent or waiver by the holder of this Senior Note shall be conclusive and binding upon such holder and upon all future holders of this Senior Note and of any Senior Note issued upon the registration of transfer hereof or in exchange herefor or in lieu hereof, whether or not notation of such consent or waiver is made upon this Senior Note.

As provided in the Indenture and subject to certain limitations therein set forth, the transfer of this Senior Note is registrable in the security register, upon surrender of this Senior Note for registration of transfer at the office or agency of the Company in any place where the principal of and interest on this Senior Note are payable, duly endorsed by, or accompanied by a written instrument of transfer in form satisfactory to the Company and the Security Registrar duly executed by the holder hereof or his attorney duly authorized in writing, and thereupon one or more new Senior Notes of this series, of authorized denominations and for the same aggregate principal amount, will be issued to the designated transferee or transferees.

The Senior Notes of this series are issuable only in registered form without coupons in denominations of \$1,000 and any integral multiple thereof, except as provided for in Section 2.03 of Supplemental Indenture No. 1. As provided in the Indenture and subject to certain limitations therein set forth, Senior Notes of this series are exchangeable for a like aggregate principal amount of Senior Notes of this series of a different authorized denomination, as requested by the holder surrendering the same.

No service charge shall be made for any such registration of transfer or exchange, but the Company may require payment of a sum sufficient to cover any tax or other governmental charge payable in connection therewith.

The Trustee and any agent of the Company or the Trustee may treat the Person in whose name this Senior Note is registered as the owner hereof for all

R-2

purposes, whether or not this Senior Note is overdue, and neither the Company, the Trustee nor any such agent shall be affected by notice to the contrary.

The Company agrees, and by acceptance of a Corporate Unit or a Separate Senior Note, each holder will be deemed to have agreed (1) for United States federal, state and local income and franchise tax purposes to treat the acquisition of a Corporate Unit as the acquisition of an Applicable Ownership Interest in Senior Notes and the Purchase Contract constituting the Corporate Unit and (2) to treat the Applicable Ownership Interest in Senior Notes or Separate Senior Note, as the case may be, as indebtedness for United States federal, state and local income and franchise tax purposes.

THIS SENIOR NOTE SHALL BE GOVERNED BY, AND CONSTRUED IN ACCORDANCE WITH, THE LAWS OF THE STATE OF NEW YORK WITHOUT GIVING EFFECT TO THE CONFLICTS OF LAW PROVISIONS THEREOF TO THE EXTENT A DIFFERENT LAW WOULD GOVERN AS A RESULT.

R-3

ASSIGNMENT

FOR VALUE RECEIVED, the undersigned assigns and transfers this Senior Note to:

\_\_\_\_\_  
\_\_\_\_\_

(Insert assignee's social security or tax identification number)

\_\_\_\_\_  
\_\_\_\_\_

(Insert address and zip code of assignee)

and irrevocably appoints

\_\_\_\_\_  
\_\_\_\_\_

agent to transfer this Senior Note on the books of the Company. The agent may substitute another to act for him or her.

Date: \_\_\_\_\_

Signature:

\_\_\_\_\_

Signature Guarantee:

\_\_\_\_\_

(Sign exactly as your name appears on the other side of this Senior Note)

---

SIGNATURE GUARANTEE

Signatures must be guaranteed by an "eligible guarantor institution" meeting the requirements of the Registrar, which requirements include membership or participation in the Security Transfer Agent Medallion Program ("STAMP") or such other "signature guarantee program" as may be determined by the Registrar in addition to, or in substitution for, STAMP, all in accordance with the Securities Exchange Act of 1934, as amended.

By: \_\_\_\_\_  
Name  
Title:

\_\_\_\_\_ as Trustee

By: \_\_\_\_\_  
Name  
Title:

Attest:

By: \_\_\_\_\_  
Name  
Title:

---

SCHEDULE OF INCREASES OR DECREASES IN SENIOR NOTE

The initial principal amount of this Senior Note is \$600,000,000. The following increases or decreases in a part of this Senior Note have been made:

Date	Amount of decrease in principal amount of this Senior Note	Amount of increase in principal amount of this Senior Note	Principal amount of this Senior Note following such decrease (or increase)	Signature of authorized officer of Trustee
------	--	--	--	--

---

GENWORTH FINANCIAL, INC.

and

**The Bank of New York,**

as Purchase Contract Agent,

and

The Bank of New York,

as Collateral Agent, Custodial Agent and Securities Intermediary

**PURCHASE CONTRACT AND PLEDGE AGREEMENT**

Dated as of May [•], 2004

---

**TABLE OF CONTENTS**

**ARTICLE 1**

**DEFINITIONS AND OTHER PROVISIONS OF GENERAL APPLICATION**

[Section 1.01. Definitions](#)  
[Section 1.02. Compliance Certificates and Opinions](#)  
[Section 1.03. Form of Documents Delivered to Purchase Contract Agent](#)  
[Section 1.04. Acts of Holders; Record Dates](#)  
[Section 1.05. Notices](#)  
[Section 1.06. Notice to Holders; Waiver](#)  
[Section 1.07. Effect of Headings and Table of Contents](#)  
[Section 1.08. Successors and Assigns](#)  
[Section 1.09. Separability Clause](#)  
[Section 1.10. Benefits of Agreement](#)  
[Section 1.11. Governing Law](#)  
[Section 1.12. Legal Holidays](#)  
[Section 1.13. Counterparts](#)  
  
[Section 1.14. Inspection of Agreement](#)  
[Section 1.15. Appointment of Financial Institution as Agent for the Company](#)  
[Section 1.16. No Waiver](#)

**ARTICLE 2**

**CERTIFICATE FORMS**

[Section 2.01. Forms of Certificates Generally](#)  
[Section 2.02. Form of Purchase Contract Agent's Certificate of Authentication](#)

**ARTICLE 3**

**THE UNITS**

[Section 3.01. Amount; Form and Denominations](#)  
[Section 3.02. Rights and Obligations Evidenced by the Certificates](#)  
[Section 3.03. Execution, Authentication, Delivery and Dating](#)  
[Section 3.04. Temporary Certificates](#)  
[Section 3.05. Registration; Registration of Transfer and Exchange](#)  
[Section 3.06. Book-entry Interests](#)  
[Section 3.07. Notices to Holders](#)  
[Section 3.08. Appointment of Successor Depository](#)  
[Section 3.09. Definitive Certificates](#)  
[Section 3.10. Mutilated, Destroyed, Lost and Stolen Certificates](#)  
[Section 3.11. Persons Deemed Owners](#)  
[Section 3.12. Cancellation](#)  
[Section 3.13. Creation of Treasury Units by Substitution of Treasury Securities](#)  
[Section 3.14. Recreation of Corporate Units](#)

---

[Section 3.15. Transfer of Collateral Upon Occurrence of Termination Event](#)

[Section 3.16. No Consent to Assumption](#)  
[Section 3.17. Substitutions](#)

[ARTICLE 4](#)  
[THE SENIOR NOTES](#)

[Section 4.01. Interest Payments; Rights to Interest Payments Preserved](#)  
[Section 4.02. Payments Prior to or on Purchase Contract Settlement Date](#)  
[Section 4.03. Notice and Voting](#)  
[Section 4.04. Special Event Redemption.](#)  
[Section 4.05. Payments to Purchase Contract Agent](#)  
[Section 4.06. Payments Held in Trust](#)

[ARTICLE 5](#)  
[THE PURCHASE CONTRACTS](#)

[Section 5.01. Purchase of Shares of Common Stock](#)  
[Section 5.02. Cash Settlement; Remarketing; Payment of Purchase Price.](#)  
[Section 5.03. Issuance of Shares of Common Stock](#)  
[Section 5.04. Adjustment of each Fixed Settlement Rate](#)  
[Section 5.05. Notice of Adjustments and Certain Other Events](#)  
[Section 5.06. Termination Event; Notice.](#)  
[Section 5.07. Early Settlement](#)  
[Section 5.08. No Fractional Shares](#)  
[Section 5.09. Charges and Taxes](#)  
[Section 5.10. Contract Adjustment Payments](#)

[ARTICLE 6](#)  
[RIGHTS AND REMEDIES OF HOLDERS](#)

[Section 6.01. Unconditional Right of Holders to Receive Contract Adjustment Payments and To Purchase Shares of Common Stock](#)  
[Section 6.02. Restoration of Rights and Remedies](#)  
[Section 6.03. Rights and Remedies Cumulative](#)  
[Section 6.04. Delay or Omission Not Waiver](#)  
[Section 6.05. Undertaking for Costs](#)  
[Section 6.06. Waiver of Stay or Extension Laws](#)

[ARTICLE 7](#)  
[THE PURCHASE CONTRACT AGENT](#)

[Section 7.01. Certain Duties and Responsibilities.](#)  
[Section 7.02. Notice of Default](#)  
[Section 7.03. Certain Rights of Purchase Contract Agent.](#)  
[Section 7.04. Not Responsible for Recitals or Issuance of Units](#)  
[Section 7.05. May Hold Units](#)

ii

---

[Section 7.06. Money Held in Custody](#)  
[Section 7.07. Compensation and Reimbursement.](#)  
[Section 7.08. Corporate Purchase Contract Agent Required; Eligibility](#)  
[Section 7.09. Resignation and Removal; Appointment of Successor](#)  
[Section 7.10. Acceptance of Appointment by Successor](#)  
[Section 7.11. Merger, Conversion, Consolidation or Succession to Business](#)  
[Section 7.12. Preservation of Information; Communications to Holders](#)  
[Section 7.13. No Obligations of Purchase Contract Agent](#)  
[Section 7.14. Tax Compliance](#)

[ARTICLE 8](#)  
[SUPPLEMENTAL AGREEMENTS](#)

[Section 8.01. Supplemental Agreements without Consent of Holders](#)  
[Section 8.02. Supplemental Agreements with Consent of Holders](#)  
[Section 8.03. Execution of Supplemental Agreements](#)  
[Section 8.04. Effect of Supplemental Agreements](#)  
[Section 8.05. Reference to Supplemental Agreements](#)

[ARTICLE 9](#)  
[CONSOLIDATION, MERGER, CONVEYANCE, TRANSFER OR LEASE](#)

[Section 9.01. Covenant Not To Consolidate, Merge, Convey, Transfer or Lease Property except under Certain Conditions](#)  
[Section 9.02. Rights and Duties of Successor Corporation](#)  
[Section 9.03. Officers' Certificate and Opinion of Counsel Given to Purchase Contract Agent](#)

[ARTICLE 10](#)  
[COVENANTS](#)

[Section 10.01. Performance under Purchase Contracts](#)  
[Section 10.02. Maintenance of Office or Agency](#)  
[Section 10.03. Company To Reserve Common Stock](#)  
[Section 10.04. Covenants as to Common Stock; Listing](#)  
[Section 10.05. Statements of Officers of the Company as to Default](#)

[Section 10.06. ERISA](#)  
[Section 10.07. Tax Treatment](#)

[ARTICLE 11](#)  
[PLEDGE](#)

[Section 11.01. Pledge](#)  
[Section 11.02. Termination](#)

iii

---

[ARTICLE 12](#)  
[ADMINISTRATION OF COLLATERAL](#)

[Section 12.01. Initial Deposit of Senior Notes](#)  
[Section 12.02. Establishment of Collateral Account](#)  
[Section 12.03. Treatment as Financial Assets](#)  
[Section 12.04. Sole Control by Collateral Agent](#)  
[Section 12.05. Jurisdiction](#)  
[Section 12.06. No Other Claims](#)  
[Section 12.07. Investment and Release](#)  
[Section 12.08. Statements and Confirmations](#)  
[Section 12.09. Tax Allocations](#)  
[Section 12.10. No Other Agreements](#)  
[Section 12.11. Powers Coupled with an Interest](#)  
[Section 12.12. Waiver of Lien; Waiver of Set-off](#)

[ARTICLE 13](#)  
[RIGHTS AND REMEDIES OF THE COLLATERAL AGENT](#)

[Section 13.01. Rights and Remedies of the Collateral Agent](#)

[ARTICLE 14](#)  
[REPRESENTATIONS AND WARRANTIES TO](#)  
[COLLATERAL AGENT; HOLDER COVENANTS](#)

[Section 14.01. Representations and Warranties](#)  
[Section 14.02. Covenants](#)

[ARTICLE 15](#)  
[THE COLLATERAL AGENT, THE CUSTODIAL AGENT AND THE SECURITIES INTERMEDIARY](#)

[Section 15.01. Appointment, Powers and Immunities](#)  
[Section 15.02. Instructions of the Company](#)  
[Section 15.03. Reliance by Collateral Agent, Custodial Agent and Securities Intermediary](#)  
[Section 15.04. Certain Rights](#)  
[Section 15.05. Merger, Conversion, Consolidation or Succession to Business](#)  
[Section 15.06. Rights in Other Capacities](#)  
[Section 15.07. Non-reliance on the Collateral Agent, Custodial Agent and Securities Intermediary](#)  
[Section 15.08. Compensation and Indemnity](#)  
[Section 15.09. Failure to Act](#)  
[Section 15.10. Resignation of Collateral Agent, the Custodial Agent and the Securities Intermediary](#)  
[Section 15.11. Right to Appoint Agent or Advisor](#)  
[Section 15.12. Survival](#)  
[Section 15.13. Exculpation](#)  
[Section 15.14. Expenses, Etc](#)

iv

---

[ARTICLE 16](#)  
[MISCELLANEOUS](#)

[Section 16.01. Security Interest Absolute](#)  
[Section 16.02. Notice of Special Event, Special Event Redemption and Termination Event](#)

**EXHIBITS**

[Exhibit A – Form of Corporate Units Certificate](#)  
[Exhibit B – Form of Treasury Units Certificate](#)  
[Exhibit C – Instruction to Purchase Contract Agent From Holder to Create Treasury Units or Corporate Units](#)  
[Exhibit D – Notice from Purchase Contract Agent to Holders Upon Termination Event](#)  
[Exhibit E – Notice to Settle by Separate Cash](#)  
[Exhibit F – Reserved](#)  
[Exhibit G – Instruction from Purchase Contract Agent to Collateral Agent \(Creation of Treasury Units\)](#)  
[Exhibit H – Instruction from the Collateral Agent to the Securities Intermediary \(Creation of Treasury Units\)](#)  
[Exhibit I – Instruction from Purchase Contract Agent to Collateral Agent \(Recreation of Corporate Units\)](#)  
[Exhibit J – Instruction from Collateral Agent to Securities Intermediary \(Recreation of Corporate Units\)](#)  
[Exhibit K – Notice of Cash Settlement from Collateral Agent to Purchase Contract Agent](#)  
[Exhibit L – Instruction to Custodial Agent Regarding Remarketing](#)  
[Exhibit M – Instruction to Custodial Agent Regarding Withdrawal from Remarketing](#)

v

---

PURCHASE CONTRACT AND PLEDGE AGREEMENT, dated as of May [•], 2004, among Genworth Financial, Inc., a Delaware corporation (the “Company”), The Bank of New York, a New York banking corporation, acting as purchase contract agent for, and as attorney-in-fact of, the Holders from time to time of the Units (in such capacities, together with its successors and assigns in such capacities, the “Purchase Contract Agent”), and The Bank of New York, as collateral agent hereunder for the benefit of the Company (in such capacity, together with its successors in such capacity, the “Collateral Agent”), as custodial agent (in such capacity, together with its successors in such capacity, the “Custodial Agent”), and as securities intermediary (as defined in Section 8-102(a)(14) of the UCC) with respect to the Collateral Account (in such capacity, together with its successors in such capacity, the “Securities Intermediary”).

**RECITALS**

WHEREAS, the Company has duly authorized the execution and delivery of this Agreement and the Certificates evidencing the Units;

WHEREAS, all things necessary to make the Purchase Contracts, when the Certificates are executed by the Company and authenticated, executed on behalf of the Holders and delivered by the Purchase Contract Agent, as provided in this Agreement, the valid obligations of the Company, and to constitute these presents a valid agreement of the Company, in accordance with its terms, have been done;

WHEREAS, pursuant to the terms of this Agreement and the Purchase Contracts, the Holders of the Units have irrevocably authorized the Purchase Contract Agent, as attorney-in-fact of such Holders, among other things, to execute and deliver this Agreement on behalf of such Holders and to grant the Pledge provided herein of the Collateral to secure the Obligations.

NOW, THEREFORE, the parties hereto agree as follows:

**ARTICLE 1  
DEFINITIONS AND OTHER PROVISIONS OF GENERAL APPLICATION**

Section 1.01. *Definitions.* For all purposes of this Agreement, except as otherwise expressly provided or unless the context otherwise requires:

- (a) the terms defined in this Article have the meanings assigned to them in this Article and include the plural as well as the singular, and nouns and pronouns of the masculine gender include the feminine and neuter genders;
- (b) all accounting terms not otherwise defined herein have the meanings assigned to them in accordance with generally accepted accounting principles in the United States;
- (c) the words “herein,” “hereof” and “hereunder” and other words of similar import refer to this Agreement as a whole and not to any particular Article, Section, Exhibit or other subdivision;

1

---

(d) the following terms which are defined in the UCC shall have the meanings set forth therein: “**certificated security**,” “**control**,” “**financial asset**,” “**entitlement order**,” “**securities account**” and “**security entitlement**”; and

(e) the following terms have the meanings given to them in this Section 1.01(e):

“**Accounting Event**” has the meaning set forth in the Supplemental Indenture.

“**Act**” has the meaning, with respect to any Holder, set forth in Section 1.04.

“**Affiliate**” of any specified Person means any other Person directly or indirectly controlling or controlled by or under direct or indirect common control with such specified Person. For the purposes of this definition, “control” when used with respect to any specified Person means the power to direct the management and policies of such Person, directly or indirectly, whether through the ownership of voting securities, by contract or otherwise; and the terms “controlling” and “controlled” have meanings correlative to the foregoing.

“**Agreement**” means this instrument as originally executed or as it may from time to time be supplemented or amended by one or more agreements supplemental hereto entered into pursuant to the applicable provisions hereof.

“**Applicable Market Value**” has the meaning set forth in Section 5.01(a).

“**Applicable Ownership Interest in the Treasury Portfolio**” shall mean, with respect to a Corporate Unit and the Treasury Portfolio, (i) a 2.5% undivided beneficial ownership interest in \$1,000 face amount of U.S. treasury securities (or principal or interest strips thereof) included in such Treasury Portfolio that matures on or prior to May 15, 2007, and (ii) for each scheduled Payment Date on the Senior Notes that occurs after the Special Event Redemption Date to and including the Purchase Contract Settlement Date, a [•]% undivided beneficial ownership interest in \$1,000 face amount of U.S. treasury securities (or principal or interest strips thereof) included in such Treasury Portfolio that mature on or prior to the Business Day immediately preceding such scheduled Payment Date.

“**Applicable Ownership Interest in Senior Notes**” means, a 2.5% undivided beneficial ownership interest in \$1,000 principal amount of Senior Notes that is a component of a Corporate Unit, and “**Applicable Ownership Interests in Senior Notes**” means the aggregate of each Applicable Ownership Interest in Senior Notes that is a component of each Corporate Unit then Outstanding.

“**Applicants**” has the meaning set forth in Section 7.12(b).

“**Bankruptcy Code**” means Title 11 of the United States Code, or any other law of the United States that from time to time provides a uniform system of bankruptcy laws.

“**Beneficial Owner**” means, with respect to a Book-Entry Interest, a Person who is the beneficial owner of such Book-Entry Interest as reflected on the books of the Depository or on the books of a Person maintaining an account with such Depository

2

---

(directly as a Depository Participant or as an indirect participant, in each case in accordance with the rules of such Depository).

“**Board of Directors**” means the board of directors of the Company or a duly authorized committee of that board.

“**Board Resolution**” means one or more resolutions of the Board of Directors, a copy of which has been certified by the Secretary or an Assistant Secretary of the Company to have been duly adopted by the Board of Directors and to be in full force and effect on the date of such certification and delivered to the Purchase Contract Agent.

“**Book-Entry Interest**” means a beneficial interest in a Global Certificate, registered in the name of a Depository or a nominee thereof, ownership and transfers of which shall be maintained and made through book entries by such Depository as described in Section 3.06.

“**Business Day**” means any day other than a Saturday or Sunday or any other day on which banking institutions in New York City, New York are authorized or required by law or executive order to remain closed; provided that for purposes of the second paragraph of Section 1.12 only, the term “Business Day” shall also be deemed to exclude any day on which the Depository is closed.

“**Cash**” means any coin or currency of the United States as at the time shall be legal tender for payment of public and private debts.

“**Cash Merger**” has the meaning set forth in Section 5.04(b)(ii).

“**Cash Merger Early Settlement**” has the meaning set forth in Section 5.04(b)(ii).

“**Cash Merger Early Settlement Date**” has the meaning set forth in Section 5.04(b)(ii).

“**Cash Settlement**” has the meaning set forth in Section 5.02(a)(i).

“**Certificate**” means a Corporate Units Certificate or a Treasury Units Certificate, as the case may be.

“**Closing Price**” has the meaning set forth in Section 5.01(a).

“**Code**” means the Internal Revenue Code of 1986, as amended.

“**Collateral**” means the collective reference to:

(i) the Collateral Account and all investment property and other financial assets from time to time credited to the Collateral Account and all security entitlements with respect thereto, including, without limitation, (A) the Applicable Ownership Interests in Senior Notes and security entitlements relating thereto (and the Senior Notes and security entitlements relating thereto delivered to the Collateral Agent in respect of such Applicable Ownership Interests in Senior

3

---

Notes), (B) the Applicable Ownership Interests in the Treasury Portfolio (as specified in clause (i) of the definition of such term) and security entitlements relating thereto, (C) any Treasury Securities and security entitlements relating thereto Transferred to the Securities Intermediary from time to time in connection with the creation of Treasury Units in accordance with Section 3.13 hereof and (D) payments made by Holders pursuant to Section 5.02 hereof;

(ii) all Proceeds of any of the foregoing (whether such Proceeds arise before or after the commencement of any proceeding under any applicable bankruptcy, insolvency or other similar law, by or against the pledgor or with respect to the pledgor); and

(iii) all powers and rights now owned or hereafter acquired under or with respect to the Collateral.

“**Collateral Account**” means the securities account of The Bank of New York, as Collateral Agent, maintained on the books of the Securities Intermediary and designated “The Bank of New York, as Collateral Agent of Genworth Financial, Inc., as pledgee of The Bank of New York, as the Purchase Contract Agent on behalf of and as attorney-in-fact for the Holders”.

“**Collateral Agent**” means the Person named as “Collateral Agent” in the first paragraph of this Agreement until a successor Collateral Agent shall have become such pursuant to this Agreement, and thereafter “Collateral Agent” shall mean the Person who is then the Collateral Agent hereunder.

“**collateral event of default**” has the meaning set forth in Section 13.01(b).

“**Collateral Substitution**” means (i) with respect to the Corporate Units, (x) the substitution of the Pledged Applicable Ownership Interests in Senior Notes included in such Corporate Units with Treasury Securities in an aggregate principal amount at maturity equal to the aggregate principal amount of such Pledged Applicable Ownership Interests in Senior Notes, or (y) the substitution of the Pledged Applicable Ownership Interests in the Treasury Portfolio included in such Corporate Units with Treasury Securities in an aggregate principal amount at maturity equal to such Pledged Applicable Ownership Interests in the Treasury Portfolio, or (ii) with respect to the Treasury Units, (x) the substitution of the Pledged Treasury Securities included in such Treasury Units (if the Applicable Ownership Interests in the Treasury Portfolio have not replaced the Applicable Ownership Interests in Senior Notes as a component of the Corporate Units) with Senior Notes in an aggregate principal amount equal to the aggregate principal amount at stated maturity of the Pledged Treasury Securities, or (y) the substitution of the Pledged Treasury Securities included in such Treasury Units (if the Applicable Ownership Interests in the Treasury Portfolio have replaced the Applicable Ownership Interests in Senior Notes as a component of the Corporate Units) with the Applicable Ownership Interests in the Treasury Portfolio (as specified in clause (i) of the definition thereof).

“**Common Stock**” means the Class A common stock, \$0.001 par value, of the Company.

4

---

“**Company**” means the Person named as the “Company” in the first paragraph of this instrument until a successor shall have become such pursuant to the applicable provision of this Agreement, and thereafter “Company” shall mean such successor.

“**Constituent Person**” has the meaning set forth in Section 5.04(b)(i).

“**Contract Adjustment Payments**” means the payments payable by the Company on the Special Payment Date or the Payment Dates in respect of each Purchase Contract, at a rate per year of [\*]% of the Stated Amount per Purchase Contract.

“**Corporate Trust Office**” means the office of the Purchase Contract Agent at which, at any particular time, its corporate trust business shall be principally administered, which office at the date hereof is located at 101 Barclay Street, 8W, New York, NY 10286 Attention: [\*].

“**Corporate Unit**” means the collective rights and obligations of a Holder of a Corporate Units Certificate in respect of the Applicable Ownership Interests in Senior Notes or the Applicable Ownership Interests in the Treasury Portfolio, as the case may be, subject in each case (except that the Applicable Ownership Interests in the Treasury Portfolio as specified in clause (ii) of the definition of such term shall not be subject to the Pledge) to the Pledge thereof, and the related Purchase Contract.

“**Corporate Units Certificate**” means a certificate evidencing the rights and obligations of a Holder in respect of the number of Corporate Units specified on such certificate.

“**Coupon Rate**” has the meaning set forth in the Supplemental Indenture.

“**Current Market Price**” means, in respect of a share of Common Stock on any date of determination, the average of the daily Closing Prices for the 20 consecutive Trading Days ending the earlier of the day in question and the day before the “ex date” with respect to the issuance or distribution requiring such computation. For purposes of this definition, the term “ex date,” when used with respect to any issuance or distribution, shall mean the first date on which Common Stock trades regular way on such exchange or in such market without the right to receive such issuance or distribution.

“**Custodial Agent**” means the Person named as Custodial Agent in the first Paragraph of this Agreement until a successor Custodial Agent shall have become such pursuant to the applicable provisions of this Agreement, and thereafter “Custodial Agent” shall mean the Person who is then the Custodial Agent hereunder.

“**Depository**” means a clearing agency registered under Section 17A of the Exchange Act that is designated to act as Depository for the Units as contemplated by Sections 3.06 and 3.08.

“**Depository Participant**” means a broker, dealer, bank, other financial institution or other Person for whom from time to time the Depository effects book entry transfers and pledges of securities deposited with the Depository.

5

---

“**Distributed Property**” has the meaning set forth in Section 5.04(a)(iv).

“**Dividend Threshold Amount**” has the meaning set forth in Section 5.04(a)(v).

“**DTC**” means The Depository Trust Company.

“**Early Settlement**” has the meaning set forth in Section 5.07(a).

“**Early Settlement Amount**” has the meaning set forth in Section 5.07(b).

“**Early Settlement Date**” has the meaning set forth in Section 5.07(b).

“**ERISA**” means the Employee Retirement Income Security Act of 1974, as amended.

“**Exchange Act**” means the Securities Exchange Act of 1934 and any statute successor thereto, in each case as amended from time to time, and the rules and regulations promulgated thereunder.

“**Exchange Property**” has the meaning set forth in Section 5.04(b)(i).

“**Ex-Dividend Date**” has the meaning set forth in Section 5.04(a)(iv).

“**Expiration Date**” has the meaning set forth in Section 1.04(e).

“**Expiration Time**” has the meaning set forth in Section 5.04(a)(vi).

“**Failed Final Remarketing**” has the meaning set forth in Section 5.02(b)(v).

“**Failed Remarketing**” has the meaning set forth in Section 5.02(b)(iii).

“**Final Remarketing Date**” means the third Business Day immediately preceding the Purchase Contract Settlement Date.

“**Fixed Settlement Rate**” means each of the Minimum Settlement Rate and the Maximum Settlement Rate.

“**Global Certificate**” means a Certificate that evidences all or part of the Units and is registered in the name of the Depository or a nominee thereof.

“**Holder**” means, with respect to a Unit, the Person in whose name the Unit evidenced by a Certificate is registered in the Security Register.

“**Indenture**” means the Indenture, dated as of [May [ ]], 2004, between the Company and the Indenture Trustee (including any provisions of the TIA that are deemed incorporated therein), as amended and supplemented by the Supplemental Indenture pursuant to which the Senior Notes will be issued.

“**Indemnites**” has the meaning set forth in Section 7.07(c).

6

---

“**Indenture Trustee**” means The Bank of New York, a New York banking corporation, as trustee under the Indenture, or any successor thereto as described in the Indenture.

“**Initial Remarketing Date**” means the fifth Business Day immediately preceding the Purchase Contract Settlement Date.

“**Issuer Order**” or “**Issuer Request**” means a written order or request signed in the name of the Company by (i) either its Chief Executive Officer, its President or one of its Vice Presidents, and (ii) either its Corporate Secretary or one of its Assistant Corporate Secretaries or its Treasurer or one of its Assistant Treasurers, and delivered to the Purchase Contract Agent.

“**Losses**” has the meaning set forth in Section 15.08(b).

“**Maximum Settlement Rate**” has the meaning set forth in Section 5.01(a).

“**Minimum Settlement Rate**” has the meaning set forth in Section 5.01(a).



“**non-electing share**” has the meaning set forth in Section 5.04(b)(i).

“**NYSE**” has the meaning set forth in Section 5.01(a).

“**Obligations**” means, with respect to each Holder, all obligations and liabilities of such Holder under such Holder’s Purchase Contract and this Agreement or any other document made, delivered or given in connection herewith or therewith, in each case whether on account of principal, interest (including, without limitation, interest accruing before and after the filing of any petition in bankruptcy, or the commencement of any insolvency, reorganization or like proceeding, relating to such Holder, whether or not a claim for post-filing or post-petition interest is allowed in such proceeding), fees, indemnities, costs, expenses or otherwise (including, without limitation, all fees and disbursements of counsel to the Company or the Collateral Agent or the Securities Intermediary that are required to be paid by the Holder pursuant to the terms of any of the foregoing agreements).

“**Officers’ Certificate**” means a certificate signed by (i) either the Company’s Chief Executive Officer, its President or one of its Vice Presidents, and (ii) either the Company’s Corporate Secretary or one of its Assistant Corporate Secretaries or its Treasurer or one of its Assistant Treasurers, and delivered to the Purchase Contract Agent. Any Officers’ Certificate delivered with respect to compliance with a condition or covenant provided for in this Agreement (other than the Officers’ Certificate provided for in Section 10.05) shall include the information set forth in Section 1.02 hereof.

“**Opinion of Counsel**” means a written opinion of counsel, who may be counsel to the Company (and who may be an employee of the Company), and who shall be reasonably acceptable to the Purchase Contract Agent. An opinion of counsel may rely on certificates as to matters of fact.

7

“**Outstanding**” means, as of any date of determination, all Units evidenced by Certificates theretofore authenticated, executed and delivered under this Agreement, except:

- (i) all Units, if a Termination Event has occurred;
- (ii) Units evidenced by Certificates theretofore cancelled by the Purchase Contract Agent or delivered to the Purchase Contract Agent for cancellation or deemed cancelled pursuant to the provisions of this Agreement; and
- (iii) Units evidenced by Certificates in exchange for or in lieu of which other Certificates have been authenticated, executed on behalf of the Holder and delivered pursuant to this Agreement, other than any such Certificate in respect of which there shall have been presented to the Purchase Contract Agent proof satisfactory to it that such Certificate is held by a protected purchaser in whose hands the Units evidenced by such Certificate are valid obligations of the Company;

*provided, however*, that in determining whether the Holders of the requisite number of the Units have given any request, demand, authorization, direction, notice, consent or waiver hereunder, Units owned by the Company or any Affiliate of the Company shall be disregarded and deemed not to be Outstanding Units, except that, in determining whether the Purchase Contract Agent shall be authorized and protected in relying upon any such request, demand, authorization, direction, notice, consent or waiver, only Units that a Responsible Officer of the Purchase Contract Agent actually knows to be so owned shall be so disregarded. Units so owned that have been pledged in good faith may be regarded as Outstanding Units if the pledgee establishes to the satisfaction of the Purchase Contract Agent the pledgee’s right so to act with respect to such Units and that the pledgee is not the Company or any Affiliate of the Company.

“**Payment Date**” means each February 16, May 16, August 16 and November 16 of each year, commencing August 16, 2004.

“**Permitted Investments**” means any one of the following, in each case maturing on the Business Day following the date of acquisition:

- (1) any evidence of indebtedness with an original maturity of 365 days or less issued, or directly and fully guaranteed or insured, by the United States of America or any agency or instrumentality thereof (*provided* that the full faith and credit of the United States of America is pledged in support of the timely payment thereof or such indebtedness constitutes a general obligation of it);
- (2) deposits, certificates of deposit or acceptances with an original maturity of 365 days or less of any institution which is a member of the Federal Reserve System having combined capital and surplus and undivided profits of not less than \$500 million at the time of deposit (and which may include the Collateral Agent);

8

- (3) investments with an original maturity of 365 days or less of any Person that is fully and unconditionally guaranteed by a bank referred to in clause (2);
- (4) repurchase agreements and reverse repurchase agreements relating to marketable direct obligations issued or unconditionally guaranteed by the United States of America or issued by any agency thereof and backed as to timely payment by the full faith and credit of the United States of America;
- (5) investments in commercial paper, other than commercial paper issued by the Company or its affiliates, of any corporation incorporated under the laws of the United States or any State thereof, which commercial paper has a rating at the time of purchase at least equal to “**A-1**” by Standard & Poor’s Ratings Services (“**S&P**”) or at least equal to “**P-1**” by Moody’s Investors Service, Inc. (“**Moody’s**”); and
- (6) investments in money market funds (including, but not limited to, money market funds managed by the Collateral Agent or an affiliate of the Collateral Agent) registered under the Investment Company Act of 1940, as amended, rated in the highest applicable rating category by S&P or Moody’s.

“**Person**” means a legal person, including any individual, corporation, estate, partnership, joint venture, association, joint-stock company, limited liability company, trust, unincorporated organization or government or any agency or political subdivision thereof or any other entity of whatever nature.

“**Plan**” means an employee benefit plan that is subject to ERISA, a plan or individual retirement account that is subject to Section 4975 of the Code or any entity whose assets are considered assets of any such plan.

“**Pledge**” means the lien and security interest in the Collateral created by this Agreement.

“**Pledged Applicable Ownership Interests in Senior Notes**” means the Applicable Ownership Interests in Senior Notes and security entitlements with respect thereto from time to time credited to the Collateral Account and not then released from the Pledge.

“**Pledged Applicable Ownership Interests in the Treasury Portfolio**” means the Applicable Ownership Interests in the Treasury Portfolio (as specified in clause (i) of the definition thereof) and security entitlements with respect thereto from time to time credited to the Collateral Account and not then released from the Pledge.

“**Pledged Securities**” means the Pledged Applicable Ownership Interests in Senior Notes, the Pledged Applicable Ownership Interests in the Treasury Portfolio and the Pledged Treasury Securities, collectively.

“**Pledged Treasury Securities**” means Treasury Securities and security entitlements with respect thereto from time to time credited to the Collateral Account and not then released from the Pledge.

“**Pledge Indemnitees**” has the meaning set forth in Section 15.08(b).

“**Predecessor Certificate**” means a Predecessor Corporate Units Certificate or a Predecessor Treasury Units Certificate.

“**Predecessor Corporate Units Certificate**” of any particular Corporate Units Certificate means every previous Corporate Units Certificate evidencing all or a portion of the rights and obligations of the Company and the Holder under the Corporate Units evidenced thereby; and, for the purposes of this definition, any Corporate Units Certificate authenticated and delivered under Section 3.10 in exchange for or in lieu of a mutilated, destroyed, lost or stolen Corporate Units Certificate shall be deemed to evidence the same rights and obligations of the Company and the Holder as the mutilated, destroyed, lost or stolen Corporate Units Certificate.

“**Predecessor Treasury Units Certificate**” of any particular Treasury Units Certificate means every previous Treasury Units Certificate evidencing all or a portion of the rights and obligations of the Company and the Holder under the Treasury Units evidenced thereby; and, for the purposes of this definition, any Treasury Units Certificate authenticated and delivered under Section 3.10 in exchange for or in lieu of a mutilated, destroyed, lost or stolen Treasury Units Certificate shall be deemed to evidence the same rights and obligations of the Company and the Holder as the mutilated, destroyed, lost or stolen Treasury Units Certificate.

“**Pro Rata**” shall mean pro rata to each Holder according to the aggregate Stated Amount of the Units held by such Holder in relation to the aggregate Stated Amount of all Units outstanding.

“**Proceeds**” has the meaning ascribed thereto in the UCC and includes, without limitation, all interest, dividends, cash, instruments, securities, financial assets and other property received, receivable or otherwise distributed upon the sale (including, without limitation, any Remarketing), exchange, collection or disposition of any financial assets from time to time credited to the Collateral Account.

“**Prospectus**” means the prospectus relating to the delivery of shares or any securities in connection with an Early Settlement pursuant to Section 5.07 or a Cash Merger Early Settlement of Purchase Contracts pursuant to Section 5.04(b)(ii), in the form in which first filed, or transmitted for filing, with the Securities and Exchange Commission after the effective date of the Registration Statement pursuant to Rule 424(b) under the Securities Act, including the documents incorporated by reference therein as of the date of such Prospectus.

“**Purchase Contract**” means, with respect to any Unit, the contract forming a part of such Unit and obligating the Company to (i) sell, and the Holder of such Unit to purchase, shares of Common Stock and (ii) pay the Holder thereof Contract Adjustment

Payments, in each case on the terms and subject to the conditions set forth in Article 5 hereof.

“**Purchase Contract Agent**” means the Person named as the “Purchase Contract Agent” in the first paragraph of this Agreement until a successor Purchase Contract Agent shall have become such pursuant to the applicable provisions of this Agreement, and thereafter “Purchase Contract Agent” shall mean such Person or any subsequent successor who is appointed pursuant to this Agreement.

“**Purchase Contract Settlement Date**” means May 16, 2007.

“**Purchase Contract Settlement Fund**” has the meaning set forth in Section 5.03.

“**Purchase Price**” has the meaning set forth in Section 5.01(a).

“**Purchased Shares**” has the meaning set forth in Section 5.04(a)(vi).

“**Put Right**” has the meaning set forth in Section 8.05(a) of the Supplemental Indenture.

“**Quotation Agent**” has the meaning set forth in the Supplemental Indenture.

“**Record Date**” for any distribution and any Contract Adjustment Payment payable on any Payment Date means the first day of the calendar month in which the relevant Payment Date falls.

“**Redemption Amount**” has the meaning set forth in the Supplemental Indenture.

“**Redemption Price**” has the meaning set forth in the Supplemental Indenture.

“**Reference Price**” has the meaning set forth in Section 5.01(a).

“**Registration Statement**” means a registration statement under the Securities Act prepared by the Company covering, *inter alia*, the delivery by the Company of any securities in connection with an Early Settlement on the Early Settlement Date or a Cash Merger Early Settlement of Purchase Contracts on the Cash Merger Early Settlement Date under Section 5.04(b)(ii), including all exhibits thereto and the documents incorporated by reference in the prospectus contained in such registration statement, and any post-effective amendments thereto.

“**Remarketing**” has the meaning set forth in the Remarketing Agreement.

“**Remarketing Agent**” has the meaning set forth in Section 1.01 of the Supplemental Indenture.

“**Remarketing Agreement**” has the meaning set forth in Section 1.01 of the Supplemental Indenture.

“**Remarketing Date**” means any of the Initial Remarketing Date, the Second Remarketing Date or the Final Remarketing Date.

“**Remarketing Fee**” has the meaning set forth in the Remarketing Agreement.

“**Remarketing Price**” has the meaning set forth in Section 5.02(b)(iii).

“**Reorganization Event**” has the meaning set forth in Section 5.04(b)(i).

“**Reset Rate**” has the meaning set forth in the Remarketing Agreement.

“**Responsible Officer**” means, when used with respect to the Purchase Contract Agent, any officer of the Purchase Contract Agent within the Corporate Trust Division-Corporate Finance Unit (or any successor unit, department or division of the Purchase Contract Agent) located at the Corporate Trust Office of the Purchase Contract Agent who has direct responsibility for the administration of the Agreement and for the purposes of Section 7.03(a), also means, with respect to a particular corporate trust matter, any other officer, trust officer or person performing similar functions to whom such matter is referred because of his or her knowledge of and familiarity of the particular subject.

“**Restrictive Legend**” means a legend to the following effect:

THIS SECURITY HAS NOT BEEN REGISTERED UNDER THE SECURITIES ACT OF 1933, AS AMENDED, OR ANY STATE SECURITIES LAWS. THIS SECURITY MAY NOT BE REOFFERED, SOLD, ASSIGNED, TRANSFERRED, PLEDGED, ENCUMBERED OR OTHERWISE DISPOSED OF IN THE ABSENCE OF SUCH REGISTRATION UNLESS SUCH TRANSACTION IS EXEMPT FROM, OR NOT SUBJECT TO, SUCH REGISTRATION.

“**Rights**” has the meaning set forth in Section 5.04(a)(xi).

“**Second Remarketing Date**” means the fourth Business Day immediately preceding the Purchase Contract Settlement Date.

“**Securities Act**” means the Securities Act of 1933 and any statute successor thereto, in each case as amended from time to time, and the rules and regulations promulgated thereunder.

“**Securities Intermediary**” means the Person named as Securities Intermediary in the first Paragraph of this Agreement until a successor Securities Intermediary shall have become such pursuant to the applicable provisions of this Agreement, and thereafter “Securities Intermediary” shall mean such successor or any subsequent successor.

“**Security Register**” and “**Securities Registrar**” have the respective meanings set forth in Section 3.05.

“**Senior Indebtedness**” means indebtedness of any kind of the Company unless the instrument under which such indebtedness is incurred expressly provides that it is on a

---

12

parity in right of payment with or subordinate in right of payment to the Contract Adjustment Payments.

“**Senior Notes**” means the series of notes designated the [ ]% Senior Notes due 2009 of the Company.

“**Separate Senior Notes**” means Senior Notes that have been released from the Pledge following Collateral Substitution and therefore no longer underlie Corporate Units.

“**Settlement Rate**” has the meaning set forth in Section 5.01(a).

“**Special Event**” has the meaning set forth in the Supplemental Indenture.

“**Special Event Redemption**” has the meaning set forth in the Supplemental Indenture.

“**Special Event Redemption Date**” has the meaning set forth in the Supplemental Indenture.

“**Special Payment Date**” has the meaning set forth in Section 5.10.

“**Stated Amount**” means \$25.

“**Successful Remarketing**” has the meaning set forth in Section 5.02(b)(iv).

“**Supplemental Indenture**” means the Supplemental Indenture No. 1 dated as of the date hereof between the Company and the Indenture Trustee pursuant to which the Senior Notes are issued.

“**Tax Event**” has the meaning set forth in the Supplemental Indenture.

“**Termination Date**” means the date, if any, on which a Termination Event occurs.

“**Termination Event**” means the occurrence of any of the following events:

(i) at any time on or prior to the Purchase Contract Settlement Date, a decree or order by a court having jurisdiction in the premises shall have been entered adjudging the Company a bankrupt or insolvent, or approving as properly filed a petition seeking reorganization of the Company under the Bankruptcy Code or any other similar applicable Federal or state law and if such judgment, decree or order shall have been entered more than 60 days prior to the Purchase Contract Settlement Date, such decree or order shall have continued undischarged and unstayed for a period of 60 days;

(ii) at any time on or prior to the Purchase Contract Settlement Date, a decree or order of a court having jurisdiction in the premises for the appointment of a receiver or liquidator or trustee or assignee (or other similar official) in bankruptcy or insolvency of the Company or of all or substantially all of its property, or for the winding up or liquidation of its affairs, shall have been entered

---

13

and if such decree or order shall have been entered more than 60 days prior to the Purchase Contract Settlement Date, such judgment, decree or order shall have continued undischarged and unstayed for a period of 60 days; or

(iii) at any time on or prior to the Purchase Contract Settlement Date, the Company shall institute proceedings to be adjudicated a voluntary bankrupt, or shall consent to the filing of a bankruptcy proceeding against it, or shall file a petition or answer or consent seeking reorganization under the Bankruptcy Code or any other similar applicable Federal or state law, or shall consent to the filing of any such petition, or shall consent to the appointment of a receiver or liquidator or trustee or assignee (or other similar official) in bankruptcy or insolvency of it or of its property, or shall make an assignment for the benefit of creditors, or shall admit in writing its inability to pay its debts generally as they become due.

“**Threshold Appreciation Price**” has the meaning set forth in Section 5.01(a).

“**TIA**” means the Trust Indenture Act of 1939, as amended from time to time, or any successor legislation.

“**TRADES**” means the Treasury/Reserve Automated Debt Entry System maintained by the Federal Reserve Bank of New York pursuant to the TRADES Regulations.

“**TRADES Regulations**” means the regulations of the United States Department of the Treasury, published at 31 C.F.R. Part 357, as amended from time to time. Unless otherwise defined herein, all terms defined in the TRADES Regulations are used herein as therein defined.

“**Trading Day**” has the meaning set forth in Section 5.01(a).

“**Transfer**” means (i) in the case of certificated securities in registered form, delivery as provided in Section 8-301(a) of the UCC, indorsed to the transferee or in blank by an effective endorsement; (ii) in the case of Treasury Securities, registration of the transferee as the owner of such Treasury Securities on TRADES; and (iii) in the case of security entitlements, including, without limitation, security entitlements with respect to Treasury Securities, a securities intermediary indicating by book entry that such security entitlement has been credited to the transferee’s securities account.

“**Treasury Portfolio**” has the meaning set forth in the Supplemental Indenture.

“**Treasury Portfolio Purchase Price**” has the meaning set forth in the Supplemental Indenture.

“**Treasury Securities**” means zero-coupon U.S. treasury securities that mature on May 15, 2007 (CUSIP No. 912828AC4).

“**Treasury Unit**” means, following the substitution of Treasury Securities for Pledged Applicable Ownership Interests in Senior Notes or Pledged Applicable Ownership Interests in the Treasury Portfolio, as the case may be, as collateral to secure a Holder’s

14

---

obligations under the Purchase Contract, the collective rights and obligations of a Holder of a Treasury Units Certificate in respect of such Treasury Securities, subject to the Pledge thereof, and the related Purchase Contract.

“**Treasury Units Certificate**” means a certificate evidencing the rights and obligations of a Holder in respect of the number of Treasury Units specified on such certificate.

“**Trigger Event**” has the meaning set forth in Section 5.04(a)(iv).

“**UCC**” means the Uniform Commercial Code as in effect in the State of New York from time to time.

“**Underwriters**” means the underwriters identified in Schedule I to the Underwriting Agreement.

“**Underwriting Agreement**” means the Underwriting Agreement, dated May [•], 2004, among the Company, GE Financial Assurance Holdings, Inc. and Morgan Stanley & Co. Incorporated and Goldman, Sachs & Co., as representative of the Underwriters, relating to the sale of Corporate Units by GE Financial Assurance Holdings, Inc.

“**Unit**” means a Corporate Unit or a Treasury Unit, as the case may be.

“**Units Prospectus**” means the registration statement, as amended, filed with the Securities and Exchange Commission (File No. [ ]) and the prospectus contained therein dated May [•], 2004, describing, among other things, the terms of the Units.

“**Value**” means, with respect to any item of Collateral on any date, as to (1) Cash, the amount thereof, (2) Treasury Securities, the aggregate principal amount thereof at maturity, (3) Applicable Ownership Interests in the Treasury Portfolio (as specified in clause (i) of the definition of such term), the appropriate aggregate percentage of the aggregate principal amount at maturity of the Treasury Portfolio and (4) Applicable Ownership Interests in Senior Notes, the appropriate aggregate percentage of the aggregate principal amount at maturity of the underlying Senior Notes.

“**Vice President**” means any vice president, whether or not designated by a number or a word or words added before or after the title “vice president.”

Section 1.02. *Compliance Certificates and Opinions.* Except as otherwise expressly provided by this Agreement, upon any application or request by the Company to the Purchase Contract Agent to take any action in accordance with any provision of this Agreement, the Company shall furnish to the Purchase Contract Agent an Officers’ Certificate stating that all conditions precedent, if any, provided for in this Agreement relating to the proposed action have been complied with and, if requested by the Purchase Contract Agent, an Opinion of Counsel stating that, in the opinion of such counsel, all such conditions precedent, if any, have been complied with, except that in the case of any such application or request as to which the furnishing of such documents is specifically required

15

---

by any provision of this Agreement relating to such particular application or request, no additional certificate or opinion need be furnished.

Every certificate or opinion with respect to compliance with a condition or covenant provided for in this Agreement (other than the Officers’ Certificate provided for in Section 10.05) shall include:

- (i) a statement that each individual signing such certificate or opinion has read such covenant or condition and the definitions herein relating thereto;
- (ii) a brief statement as to the nature and scope of the examination or investigation upon which the statements or opinions contained in such certificate

or opinion are based;

(iii) a statement that, in the opinion of each such individual, he or she has made such examination or investigation as is necessary to enable such individual to express an informed opinion as to whether or not such covenant or condition has been complied with; and

(iv) a statement as to whether, in the opinion of each such individual, such condition or covenant has been complied with.

Section 1.03. *Form of Documents Delivered to Purchase Contract Agent.*

In any case where several matters are required to be certified by, or covered by an opinion of, any specified Person, it is not necessary that all such matters be certified by, or covered by the opinion of, only one such Person, or that they be so certified or covered by only one document, but one such Person may certify or give an opinion with respect to some matters and one or more other such Persons as to other matters, and any such Person may certify or give an opinion as to such matters in one or several documents. Any certificate or opinion of an officer of the Company may be based, insofar as it relates to legal matters, upon a certificate or opinion of, or representations by, counsel, unless such officer knows, or in the exercise of reasonable care should know, that the certificate or opinion or representations with respect to the matters upon which its certificate or opinion is based are erroneous. Any such certificate or Opinion of Counsel may be based, insofar as it relates to factual matters, upon a certificate or opinion of, or representations by, an officer or officers of the Company unless such counsel knows, or in the exercise of reasonable care should know, that the certificate or opinion or representations with respect to such matters are erroneous.

Where any Person is required to make, give or execute two or more applications, requests, consents, certificates, statements, opinions or other instruments under this Agreement, they may, but need not, be consolidated and form one instrument.

Section 1.04. *Acts of Holders; Record Dates.* (a) Any request, demand, authorization, direction, notice, consent, waiver or other action provided by this Agreement to be given or taken by Holders may be embodied in and evidenced by one or more instruments of substantially similar tenor signed by such Holders in person or by an agent

16

---

duly appointed in writing; and, except as herein otherwise expressly provided, such action shall become effective when such instrument or instruments are delivered to the Purchase Contract Agent and, where it is hereby expressly required, to the Company. Such instrument or instruments (and the action embodied therein and evidenced thereby) are herein sometimes referred to as the “**Act**” of the Holders signing such instrument or instruments. Proof of execution of any such instrument or of a writing appointing any such agent shall be sufficient for any purpose of this Agreement and (subject to Section 7.01) conclusive in favor of the Purchase Contract Agent and the Company, if made in the manner provided in this Section.

(b) The fact and date of the execution by any Person of any such instrument or writing may be proved in any manner that the Purchase Contract Agent deems sufficient.

(c) The ownership of Units shall be proved by the Security Register.

(d) Any request, demand, authorization, direction, notice, consent, waiver or other Act of the Holder of any Unit shall bind every future Holder of the same Unit and the Holder of every Certificate evidencing such Unit issued upon the registration of transfer thereof or in exchange therefor or in lieu thereof in respect of anything done, omitted or suffered to be done by the Purchase Contract Agent or the Company in reliance thereon, whether or not notation of such action is made upon such Certificate.

(e) The Company may set any date as a record date for the purpose of determining the Holders of Outstanding Units entitled to give, make or take any request, demand, authorization, direction, notice, consent, waiver or other action provided or permitted by this Agreement to be given, made or taken by Holders. If any record date is set pursuant to this paragraph, the Holders of the Outstanding Corporate Units and the Outstanding Treasury Units, as the case may be, on such record date, and no other Holders, shall be entitled to take the relevant action with respect to the Corporate Units or the Treasury Units, as the case may be, whether or not such Holders remain Holders after such record date; *provided* that no such action shall be effective hereunder unless taken prior to or on the applicable Expiration Date by Holders of the requisite number of Outstanding Units on such record date. Nothing contained in this paragraph shall be construed to prevent the Company from setting a new record date for any action for which a record date has previously been set pursuant to this paragraph (whereupon the record date previously set shall automatically and with no action by any Person be cancelled and be of no effect), and nothing contained in this paragraph shall be construed to render ineffective any action taken by Holders of the requisite number of Outstanding Units on the date such action is taken. Promptly after any record date is set pursuant to this paragraph, the Company, at its own expense, shall cause notice of such record date, the proposed action by Holders and the applicable Expiration Date to be given to the Purchase Contract Agent in writing and to each Holder in the manner set forth in Section 1.06.

With respect to any record date set pursuant to this Section 1.04(e), the Company may designate any date as the “**Expiration Date**” and from time to time may change the Expiration Date to any later day; *provided* that no such change shall be effective unless notice of the proposed new Expiration Date is given to the Purchase Contract Agent in writing, and to each Holder in the manner set forth in Section 1.06, prior to or on the

17

---

existing Expiration Date. If an Expiration Date is not designated with respect to any record date set pursuant to this Section, the Company shall be deemed to have initially designated the 180th day after such record date as the Expiration Date with respect thereto, subject to its right to change the Expiration Date as provided in this paragraph. Notwithstanding the foregoing, no Expiration Date shall be later than the 180th day after the applicable record date.

Section 1.05. *Notices.* All notices, requests, consents and other communications provided for herein (including, without limitation, any modifications of, or waivers or consents under, this Agreement) shall be given or made in writing (including, without limitation, by teletype) delivered to the intended recipient at the “**Address for Notices**” specified below its name on the signature pages hereof or, as to any party, at such other address as shall be designated by such party in a notice to the other parties. Except as otherwise provided in this Agreement, all such communications shall be deemed to have been duly given when transmitted by telecopier or personally delivered or, in the case of a mailed notice, upon receipt, in each case given or addressed as aforesaid.

The Purchase Contract Agent shall send to the Indenture Trustee at the following address a copy of any notices in the form of Exhibits C, D, E, G, I or K it sends or receives:

The Bank of New York  
101 Barclay Street, 8W  
New York, NY 10286  
Attention: [•]  
Fax: [•]

Section 1.06. *Notice to Holders; Waiver.* Where this Agreement provides for notice to Holders of any event, such notice shall be sufficiently given (unless otherwise herein expressly provided) if in writing and mailed, first-class postage prepaid, to each Holder affected by such event, at its address as it appears in the Security Register, not later than the latest date, and not earlier than the earliest date, prescribed for the giving of such notice. In any case where notice to Holders is given by mail,

neither the failure to mail such notice, nor any defect in any notice so mailed to any particular Holder shall affect the sufficiency of such notice with respect to other Holders. Where this Agreement provides for notice in any manner, such notice may be waived in writing by the Person entitled to receive such notice, either before or after the event, and such waiver shall be the equivalent of such notice. Waivers of notice by Holders shall be filed with the Purchase Contract Agent, but such filing shall not be a condition precedent to the validity of any action taken in reliance upon such waiver.

In case by reason of the suspension of regular mail service or by reason of any other cause it shall be impracticable to give such notice by mail, then such notification as shall be made with the approval of the Purchase Contract Agent shall constitute a sufficient notification for every purpose hereunder.

18

---

Section 1.07. *Effect of Headings and Table of Contents.* The Article and Section headings herein and the Table of Contents are for convenience only and shall not affect the construction hereof.

Section 1.08. *Successors and Assigns.* This Agreement shall be binding upon and inure to the benefit of the respective successors and assigns of the Company, the Purchase Contract Agent, the Collateral Agent, the Custodial Agent and the Securities Intermediary, and the Holders from time to time of the Units, by their acceptance of the same, shall be deemed to have agreed to be bound by the provisions hereof and to have ratified the agreements of, and the grant of the Pledge hereunder by, the Purchase Contract Agent.

Section 1.09. *Separability Clause.* In case any provision in this Agreement or in the Units shall be invalid, illegal or unenforceable, the validity, legality and enforceability of the remaining provisions hereof and thereof shall not in any way be affected or impaired thereby.

Section 1.10. *Benefits of Agreement.* Nothing contained in this Agreement or in the Units, express or implied, shall give to any Person, other than the parties hereto and their successors hereunder and, to the extent provided hereby, the Holders, any benefits or any legal or equitable right, remedy or claim under this Agreement. The Holders from time to time shall be beneficiaries of this Agreement and shall be bound by all of the terms and conditions hereof and of the Units evidenced by their Certificates by their acceptance of delivery of such Certificates.

Section 1.11. *Governing Law.* THIS AGREEMENT AND THE UNITS SHALL BE GOVERNED BY, AND CONSTRUED IN ACCORDANCE WITH, THE LAWS OF THE STATE OF NEW YORK WITHOUT GIVING EFFECT TO THE CONFLICTS OF LAW PROVISIONS THEREOF TO THE EXTENT A DIFFERENT LAW WOULD GOVERN AS A RESULT. The Company, the Collateral Agent, the Custodial Agent, the Securities Intermediary and the Holders from time to time of the Units, acting through the Purchase Contract Agent as their attorney-in-fact, hereby submit to the nonexclusive jurisdiction of the United States District Court for the Southern District of New York and of any New York state court sitting in New York City for the purposes of all legal proceedings arising out of or relating to this Agreement or the transactions contemplated hereby. The Company, the Collateral Agent, the Custodial Agent, the Securities Intermediary and the Holders from time to time of the Units, acting through the Purchase Contract Agent as their attorney-in-fact, irrevocably waive, to the fullest extent permitted by applicable law, any objection which they may now or hereafter have to the laying of the venue of any such proceeding brought in such a court and any claim that any such proceeding brought in such a court has been brought in an inconvenient forum.

Section 1.12. *Legal Holidays.* In any case where any Payment Date shall not be a Business Day (notwithstanding any other provision of this Agreement or the Units), Contract Adjustment Payments or other distributions shall not be paid on such date, but Contract Adjustment Payments or such other distributions shall be paid on the next succeeding Business Day, with the same force and effect as if made on such scheduled Payment Date; *provided* that no interest shall accrue or be payable by the Company or to any Holder in respect of such delay.

19

---

In any case where the Purchase Contract Settlement Date or any Early Settlement Date or Cash Merger Early Settlement Date shall not be a Business Day (notwithstanding any other provision of this Agreement or the Units), Purchase Contracts shall not be performed and Early Settlement and Cash Merger Early Settlement shall not be effected on such date, but Purchase Contracts shall be performed or Early Settlement or Cash Merger Early Settlement shall be effected, as applicable, on the next succeeding Business Day with the same force and effect as if made on such Purchase Contract Settlement Date, Early Settlement Date or Cash Merger Early Settlement Date, as applicable.

Section 1.13. *Counterparts.* This Agreement may be executed in any number of counterparts by the parties hereto, each of which, when so executed and delivered, shall be deemed an original, but all such counterparts shall together constitute one and the same instrument.

Section 1.14. *Inspection of Agreement.* A copy of this Agreement shall be available at all reasonable times during normal business hours at the Corporate Trust Office for inspection by any Holder or Beneficial Owner.

Section 1.15. *Appointment of Financial Institution as Agent for the Company.* The Company may appoint a financial institution (which may be the Collateral Agent) to act as its agent in performing its obligations and in accepting and enforcing performance of the obligations of the Purchase Contract Agent and the Holders, under this Agreement and the Purchase Contracts, by giving notice of such appointment in the manner provided in Section 1.05 hereof. Any such appointment shall not relieve the Company in any way from its obligations hereunder.

Section 1.16. *No Waiver.* No failure on the part of the Company, the Purchase Contract Agent, the Collateral Agent, the Custodial Agent, the Securities Intermediary or any of their respective agents to exercise, and no course of dealing with respect to, and no delay in exercising, any right, power or remedy hereunder shall operate as a waiver thereof; nor shall any single or partial exercise by the Company, the Collateral Agent, the Custodial Agent, the Securities Intermediary or any of their respective agents of any right, power or remedy hereunder preclude any other or further exercise thereof or the exercise of any other right, power or remedy. The remedies herein are cumulative and are not exclusive of any remedies provided by law.

## ARTICLE 2 CERTIFICATE FORMS

Section 2.01. *Forms of Certificates Generally.* The Certificates (including the form of Purchase Contract forming part of each Unit evidenced thereby) shall be in substantially the form set forth in Exhibit A hereto (in the case of Corporate Units Certificates) or Exhibit B hereto (in the case of Treasury Units Certificates), with such letters, numbers or other marks of identification or designation and such legends or endorsements printed, lithographed or engraved thereon as may be required by the rules of any securities exchange on which the Units are listed or any depository therefor, or as may,

20

---

consistently herewith, be determined by the officers of the Company executing such Certificates, as evidenced by their execution of the Certificates.

The definitive Certificates shall be produced in any manner as determined by the officers of the Company executing the Units evidenced by such Certificates,

consistent with the provisions of this Agreement, as evidenced by their execution thereof.

Every Global Certificate authenticated, executed on behalf of the Holders and delivered hereunder shall bear a legend substantially in the form set forth in Exhibit A and Exhibit B for a Global Certificate.

Section 2.02. *Form of Purchase Contract Agent's Certificate of Authentication.* The form of the Purchase Contract Agent's certificate of authentication of the Units shall be in substantially the form set forth on the form of the applicable Certificates.

### ARTICLE 3 THE UNITS

Section 3.01. *Amount; Form and Denominations.* The aggregate number of Units evidenced by Certificates authenticated, executed on behalf of the Holders and delivered hereunder is limited to 24,000,000, except for Certificates authenticated, executed and delivered upon registration of transfer of, in exchange for, or in lieu of, other Certificates pursuant to Section 3.04, Section 3.05, Section 3.10, Section 3.13, Section 3.14 or Section 8.05.

The Certificates shall be issuable only in registered form and only in denominations of a single Corporate Unit or Treasury Unit and any integral multiple thereof.

Section 3.02. *Rights and Obligations Evidenced by the Certificates.* Each Corporate Units Certificate shall evidence the number of Corporate Units specified therein, with each such Corporate Unit representing (1) the ownership by the Holder thereof of an Applicable Ownership Interest in Senior Notes or an Applicable Ownership Interest in the Treasury Portfolio, as the case may be, subject to the Pledge of such Applicable Ownership Interest in Senior Note or Applicable Ownership Interest in the Treasury Portfolio (as specified in clause (i) of the definition of such term), as the case may be, by such Holder pursuant to this Agreement, and (2) the rights and obligations of the Holder thereof and the Company under one Purchase Contract. The Purchase Contract Agent is hereby authorized, as attorney-in-fact for, and on behalf of, the Holder of each Corporate Unit, to pledge, pursuant to Article 11 hereof, the Applicable Ownership Interest in Senior Notes, or the Applicable Ownership Interest in the Treasury Portfolio (as specified in clause (i) of the definition of such term) forming a part of such Corporate Unit, to the Collateral Agent for the benefit of the Company, and to grant to the Collateral Agent, for the benefit of the Company, a security interest in the right, title and interest of such Holder in such Applicable Ownership Interest in Senior Notes or Applicable Ownership Interest in the Treasury Portfolio (as specified in clause (i) of the definition of such term) to secure the obligation of the Holder under each Purchase Contract to purchase shares of Common Stock. To effect such Pledge and grant such security interest, the Purchase Contract Agent

21

---

on behalf of the Holders of Corporate Units has, on the date hereof, delivered to the Collateral Agent the Senior Notes underlying the Applicable Ownership Interests in Senior Notes.

Upon the formation of a Treasury Unit pursuant to Section 3.13, each Treasury Unit Certificate shall evidence the number of Treasury Units specified therein, with each such Treasury Unit representing (1) the ownership by the Holder thereof of a 1/40 or 2.5% undivided beneficial interest in a Treasury Security with a principal amount equal to \$1,000, subject to the Pledge of such interest by such Holder pursuant to this Agreement, and (2) the rights and obligations of the Holder thereof and the Company under one Purchase Contract. The Purchase Contract Agent is hereby authorized, as attorney-in-fact for, and on behalf of, the Holder of each Treasury Unit, to pledge, pursuant to Article 11 hereof, such Holder's interest in the Treasury Security forming a part of such Treasury Unit to the Collateral Agent, for the benefit of the Company, and to grant to the Collateral Agent, for the benefit of the Company, a security interest in the right, title and interest of such Holder in such Treasury Security to secure the obligation of the Holder under each Purchase Contract to purchase shares of Common Stock.

Prior to the purchase of shares of Common Stock under each Purchase Contract, such Purchase Contracts shall not entitle the Holder of a Unit to any of the rights of a holder of shares of Common Stock, including, without limitation, the right to vote or receive any dividends or other payments or to consent or to receive notice as a shareholder in respect of the meetings of shareholders or for the election of directors of the Company or for any other matter, or any other rights whatsoever as a shareholder of the Company.

Section 3.03. *Execution, Authentication, Delivery and Dating.* Subject to the provisions of Section 3.13 and Section 3.14 hereof, upon the execution and delivery of this Agreement, and at any time and from time to time thereafter, the Company may deliver Certificates executed by the Company to the Purchase Contract Agent for authentication, execution on behalf of the Holders and delivery, together with its Issuer Order for authentication of such Certificates, and the Purchase Contract Agent in accordance with such Issuer Order shall authenticate, execute on behalf of the Holders and deliver such Certificates.

The Certificates shall be executed on behalf of the Company by its Chairman of the Board of Directors, its Chief Executive Officer, its President, its Treasurer or one of its Vice Presidents. The signature of any of these officers on the Certificates may be manual or facsimile.

Certificates bearing the manual or facsimile signatures of individuals who were at any time the proper officers of the Company shall bind the Company, notwithstanding that such individuals or any of them have ceased to hold such offices prior to the authentication and delivery of such Certificates or did not hold such offices at the date of such Certificates.

No Purchase Contract evidenced by a Certificate shall be valid until such Certificate has been executed on behalf of the Holder by the manual signature of an authorized officer of the Purchase Contract Agent, as such Holder's attorney-in-fact. Such

22

---

signature by an authorized officer of the Purchase Contract Agent shall be conclusive evidence that the Holder of such Certificate has entered into the Purchase Contracts evidenced by such Certificate.

Each Certificate shall be dated the date of its authentication.

No Certificate shall be entitled to any benefit under this Agreement or be valid or obligatory for any purpose unless there appears on such Certificate a certificate of authentication substantially in the form provided for herein executed by an authorized officer of the Purchase Contract Agent by manual signature, and such certificate of authentication upon any Certificate shall be conclusive evidence, and the only evidence, that such Certificate has been duly authenticated and delivered hereunder.

Section 3.04. *Temporary Certificates.* Pending the preparation of definitive Certificates, the Company may execute and deliver to the Purchase Contract Agent, and the Purchase Contract Agent shall authenticate, execute on behalf of the Holders, and deliver, in lieu of such definitive Certificates, temporary Certificates which are in substantially the form set forth in Exhibit A or Exhibit B hereto, as the case may be, with such letters, numbers or other marks of identification or designation and such legends or endorsements printed, lithographed or engraved thereon as may be required by the rules of any securities exchange on which the Corporate Units or Treasury Units, as the case may be, are listed, or as may, consistently herewith, be determined by the officers of the Company executing such Certificates, as evidenced by their execution of the Certificates.

If temporary Certificates are issued, the Company will cause definitive Certificates to be prepared without unreasonable delay. After the preparation of definitive Certificates, the temporary Certificates shall be exchangeable for definitive Certificates upon surrender of the temporary Certificates at the Corporate Trust Office, at the

expense of the Company and without charge to the Holder. Upon surrender for cancellation of any one or more temporary Certificates, the Company shall execute and deliver to the Purchase Contract Agent, and the Purchase Contract Agent shall authenticate, execute on behalf of the Holder, and deliver in exchange therefor, one or more definitive Certificates of like tenor and denominations and evidencing a like number of Units as the temporary Certificate or Certificates so surrendered. Until so exchanged, the temporary Certificates shall in all respects evidence the same benefits and the same obligations with respect to the Units evidenced thereby as definitive Certificates.

Section 3.05. *Registration; Registration of Transfer and Exchange.* The Purchase Contract Agent shall keep at the Corporate Trust Office a register (the “**Security Register**”) in which, subject to such reasonable regulations as it may prescribe, the Purchase Contract Agent shall provide for the registration of Certificates and of transfers of Certificates (the Purchase Contract Agent, in such capacity, the “**Security Registrar**”). The Security Registrar shall record separately the registration and transfer of the Certificates evidencing Corporate Units and Treasury Units.

Upon surrender for registration of transfer of any Certificate at the Corporate Trust Office, the Company shall execute and deliver to the Purchase Contract Agent, and the Purchase Contract Agent shall authenticate, execute on behalf of the designated transferee

23

---

or transferees, and deliver, in the name of the designated transferee or transferees, one or more new Certificates of any authorized denominations, like tenor, and evidencing a like number of Corporate Units or Treasury Units, as the case may be.

At the option of the Holder, Certificates may be exchanged for other Certificates, of any authorized denominations and evidencing a like number of Corporate Units or Treasury Units, as the case may be, upon surrender of the Certificates to be exchanged at the Corporate Trust Office. Whenever any Certificates are so surrendered for exchange, the Company shall execute and deliver to the Purchase Contract Agent, and the Purchase Contract Agent shall authenticate, execute on behalf of the Holder, and deliver the Certificates which the Holder making the exchange is entitled to receive.

All Certificates issued upon any registration of transfer or exchange of a Certificate shall evidence the ownership of the same number of Corporate Units or Treasury Units, as the case may be, and be entitled to the same benefits and subject to the same obligations under this Agreement as the Corporate Units or Treasury Units, as the case may be, evidenced by the Certificate surrendered upon such registration of transfer or exchange.

Every Certificate presented or surrendered for registration of transfer or exchange shall (if so required by the Purchase Contract Agent) be duly endorsed, or be accompanied by a written instrument of transfer in form satisfactory to the Company and the Purchase Contract Agent duly executed by the Holder thereof or its attorney duly authorized in writing.

No service charge shall be made for any registration of transfer or exchange of a Certificate, but the Company and the Purchase Contract Agent may require payment from the Holder of a sum sufficient to cover any tax or other governmental charge that may be imposed in connection with any registration of transfer or exchange of Certificates, other than any exchanges pursuant to Section 3.04, Section 3.06 and Section 8.05 not involving any transfer.

Notwithstanding the foregoing, the Company shall not be obligated to execute and deliver to the Purchase Contract Agent, and the Purchase Contract Agent shall not be obligated to authenticate, execute on behalf of the Holder and deliver any Certificate in exchange for any other Certificate presented or surrendered for registration of transfer or for exchange on or after the Business Day immediately preceding the earliest to occur of any Early Settlement Date with respect to such Certificate, any Cash Merger Early Settlement Date with respect to such Certificate, the Purchase Contract Settlement Date or the Termination Date. In lieu of delivery of a new Certificate, upon satisfaction of the applicable conditions specified above in this Section and receipt of appropriate registration or transfer instructions from such Holder, the Purchase Contract Agent shall:

(i) if the Purchase Contract Settlement Date (including upon any Cash Settlement) or an Early Settlement Date or a Cash Merger Early Settlement Date with respect to such other Certificate (or portion thereof) has occurred, deliver the shares of Common Stock issuable in respect of the Purchase Contracts forming a part of the Units evidenced by such other Certificate (or portion thereof); or

24

---

(ii) if a Termination Event, Early Settlement, or Cash Merger Early Settlement shall have occurred prior to the Purchase Contract Settlement Date, or a Cash Settlement shall have occurred, transfer the Senior Notes, the Treasury Securities, or the Applicable Ownership Interests in the Treasury Portfolio, as the case may be, underlying such Certificate, in each case subject to the applicable conditions and in accordance with the applicable provisions of Section 3.15 and Article 5 hereof.

Section 3.06. *Book-entry Interests.* The Certificates, on original issuance, will be issued in definitive certificated form and will bear the Restrictive Legend. Upon the sale of the Units to the Underwriters pursuant to the Underwriting Agreement, the Restrictive Legend will be removed and Certificates will be issued in the form of one or more fully registered Global Certificates, to be delivered to the Depository or its custodian by, or on behalf of, the Company. The Company hereby designates DTC as the initial Depository. Such Global Certificates shall initially be registered on the Security Register in the name of Cede & Co., the nominee of the Depository, and no Beneficial Owner will receive a definitive Certificate representing such Beneficial Owner’s interest in such Global Certificate, except as provided in Section 3.09. The Purchase Contract Agent shall enter into an agreement with the Depository if so requested by the Company. Following the issuance of such Global Certificates and unless and until definitive, and fully registered Certificates have been issued to Beneficial Owners pursuant to Section 3.09:

(i) the provisions of this Section 3.06 shall be in full force and effect;

(ii) the Company shall be entitled to deal with the Depository for all purposes of this Agreement (including, without limitation, making Contract Adjustment Payments and receiving approvals, votes or consents hereunder) as the Holder of the Units and the sole holder of the Global Certificates and shall have no obligation to the Beneficial Owners; *provided that* a Beneficial Owner may directly enforce against the Company, without any consent, proxy, waiver or involvement of the Depository of any kind, such Beneficial Owner’s right to receive a definitive Certificate representing the Units beneficially owned by such Beneficial Owner, as set forth in Section 3.09;

(iii) to the extent that the provisions of this Section 3.06 conflict with any other provisions of this Agreement, the provisions of this Section 3.06 shall control; and

(iv) except as set forth in the proviso of clause (ii) of this Section 3.06, the rights of the Beneficial Owners shall be exercised only through the Depository and shall be limited to those established by law and agreements between such Beneficial Owners and the Depository or the Depository Participants. The Depository will make book-entry transfers among Depository Participants and receive and transmit payments of Contract Adjustment Payments to such Depository Participants.

Transfers of securities evidenced by Global Certificates shall be made through the facilities of the Depository, and any cancellation of, or increase or decrease in the number of, such

25



---

securities (including the creation of Treasury Units and the recreation of Corporate Units pursuant to Section 3.13 and Section 3.14 respectively) shall be accomplished by making appropriate annotations on the Schedule of Increases and Decreases set forth in such Global Certificate.

Section 3.07. *Notices to Holders.* Whenever a notice or other communication to the Holders is required to be given under this Agreement, the Company or the Company's agent shall give such notices and communications to the Holders and, with respect to any Units registered in the name of the Depository or the nominee of the Depository, the Company or the Company's agent shall, except as set forth herein, have no obligations to the Beneficial Owners.

Section 3.08. *Appointment of Successor Depository.* If the Depository elects to discontinue its services as securities depository with respect to the Units, the Company may, in its sole discretion, appoint a successor Depository with respect to the Units.

Section 3.09. *Definitive Certificates.*

If:

- (i) the Depository notifies the Company that it is unwilling or unable to continue its services as securities depository with respect to the Units and no successor Depository has been appointed pursuant to Section 3.08 within 90 days after such notice;
- (ii) the Depository ceases to be a "clearing agency" registered under Section 17A of the Exchange Act when the Depository is required to be so registered to act as the Depository and so notifies the Company, and no successor Depository has been appointed pursuant to Section 3.08 within 90 days after such notice;
- (iii) to the extent permitted by the Depository, the Company determines in its discretion that the Global Certificates shall be exchangeable for definitive Certificates; or
- (iv) a Beneficial Owner requests to exchange such Beneficial Owner's interest in the Global Certificates for definitive Certificates;

then (x) definitive Certificates shall be prepared by the Company with respect to such Units and delivered to the Purchase Contract Agent and (y) upon surrender of the Global Certificates representing the Units by the Depository, accompanied by registration instructions (other than in the case of clause (iv) above), the Company shall cause definitive Certificates to be delivered to Beneficial Owners in accordance with instructions provided by the Depository. The Company and the Purchase Contract Agent shall not be liable for any delay in delivery of such instructions and may conclusively rely on and shall be authorized and protected in relying on, such instructions. Each definitive Certificate so delivered shall evidence Units of the same kind and tenor as the Global Certificate so surrendered in respect thereof.

26

---

Section 3.10. *Mutilated, Destroyed, Lost and Stolen Certificates.* If any mutilated Certificate is surrendered to the Purchase Contract Agent, the Company shall execute and deliver to the Purchase Contract Agent, and the Purchase Contract Agent shall authenticate, execute on behalf of the Holder, and deliver in exchange therefor, a new Certificate, evidencing the same number of Corporate Units or Treasury Units, as the case may be, and bearing a Certificate number not contemporaneously outstanding.

If there shall be delivered to the Company and the Purchase Contract Agent (i) evidence to their satisfaction of the destruction, loss or theft of any Certificate, and (ii) such security or indemnity as may be required by them to hold each of them and any agent of any of them harmless, then, in the absence of notice to the Company or the Purchase Contract Agent that such Certificate has been acquired by a protected purchaser, the Company shall execute and deliver to the Purchase Contract Agent, and the Purchase Contract Agent shall authenticate, execute on behalf of the Holder, and deliver to the Holder, in lieu of any such destroyed, lost or stolen Certificate, a new Certificate, evidencing the same number of Corporate Units or Treasury Units, as the case may be, and bearing a Certificate number not contemporaneously outstanding.

Notwithstanding the foregoing, the Company shall not be obligated to execute and deliver to the Purchase Contract Agent, and the Purchase Contract Agent shall not be obligated to authenticate, execute on behalf of the Holder, and deliver to the Holder, a Certificate on or after the Business Day immediately preceding the earliest of any Early Settlement Date with respect to such lost or mutilated Certificate, any Cash Merger Early Settlement Date with respect to such lost or mutilated Certificate, the Purchase Contract Settlement Date or the Termination Date. In lieu of delivery of a new Certificate, upon satisfaction of the applicable conditions specified above in this Section and receipt of appropriate registration or transfer instructions from such Holder, the Purchase Contract Agent shall:

- (i) if the Purchase Contract Settlement Date (including upon any Cash Settlement) or an Early Settlement Date or a Cash Merger Early Settlement Date with respect to such lost, stolen, destroyed or mutilated Certificate has occurred, deliver the shares of Common Stock issuable in respect of the Purchase Contracts forming a part of the Units evidenced by such Certificate; and
- (ii) if a Termination Event, Cash Merger Early Settlement or an Early Settlement with respect to such lost or mutilated Certificate shall have occurred prior to the Purchase Contract Settlement Date or a Cash Settlement shall have occurred, transfer the Senior Notes, the Treasury Securities or the Applicable Ownership Interests in the Treasury Portfolio, as the case may be, underlying such Certificate, in each case subject to the applicable conditions and in accordance with the applicable provisions of Section 3.15 and Article 5 hereof.

Upon the issuance of any new Certificate under this Section, the Company and the Purchase Contract Agent may require the payment by the Holder of a sum sufficient to cover any tax or other governmental charge that may be imposed in relation thereto and any other fees and expenses (including, without limitation, the fees and expenses of the Purchase Contract Agent) connected therewith.

27

---

Every new Certificate issued pursuant to this Section in lieu of any destroyed, lost or stolen Certificate shall constitute an original additional contractual obligation of the Company and of the Holder in respect of the Units evidenced thereby, whether or not the destroyed, lost or stolen Certificate (and the Units evidenced thereby) shall be at any time enforceable by anyone, and shall be entitled to all the benefits and be subject to all the obligations of this Agreement equally and proportionately with any and all other Certificates delivered hereunder.

The provisions of this Section are exclusive and shall preclude, to the extent lawful, all other rights and remedies with respect to the replacement or payment of mutilated, destroyed, lost or stolen Certificates.

Section 3.11. *Persons Deemed Owners.* Prior to due presentment of a Certificate for registration of transfer, the Company and the Purchase Contract Agent, and any agent of the Company or the Purchase Contract Agent, may treat the Person in whose name such Certificate is registered as the owner of the Units evidenced thereby for purposes of (subject to any applicable record date) any payment or distribution with respect to the Applicable Ownership Interests in Senior Notes, or on the Applicable Ownership Interests in the Treasury Portfolio (as specified in clause (ii) of the definition of such term), as applicable, payment of Contract Adjustment Payments and performance of the Purchase Contracts and for all other purposes whatsoever in connection with such Units, whether or not such payment, distribution, or performance shall

be overdue and notwithstanding any notice to the contrary, and neither the Company nor the Purchase Contract Agent, nor any agent of the Company or the Purchase Contract Agent, shall be affected by notice to the contrary.

Notwithstanding the foregoing, with respect to any Global Certificate, nothing contained herein shall prevent the Company, the Purchase Contract Agent or any agent of the Company or the Purchase Contract Agent, from giving effect to any written certification, proxy or other authorization furnished by the Depository (or its nominee), as a Holder, with respect to such Global Certificate, or impair, as between such Depository and the related Beneficial Owner, the operation of customary practices governing the exercise of rights of the Depository (or its nominee) as Holder of such Global Certificate. None of the Company, the Purchase Contract Agent or any agent of the Company or the Purchase Contract Agent will have any responsibility or liability for any aspect of the records relating to or payments made on account of beneficial ownership interests of a Global Certificate or maintaining, supervising or reviewing any records relating to such beneficial ownership interests.

Section 3.12. *Cancellation.* All Certificates surrendered for delivery of shares of Common Stock on or after the Purchase Contract Settlement Date or in connection with an Early Settlement or a Cash Merger Early Settlement or for delivery of the Senior Notes underlying the Applicable Ownership Interests in Senior Notes, the Applicable Ownership Interests in the Treasury Portfolio or Treasury Securities, as the case may be, after the occurrence of a Termination Event or pursuant to a Cash Settlement, an Early Settlement or a Cash Merger Early Settlement, a Collateral Substitution, or upon the registration of transfer or exchange of a Unit, shall, if surrendered to any Person other than the Purchase Contract Agent, be delivered to the Purchase Contract Agent along with appropriate

28

---

written instructions regarding the cancellation thereof and, if not already cancelled, shall be promptly cancelled by it. The Company may at any time deliver to the Purchase Contract Agent for cancellation any Certificates previously authenticated, executed and delivered hereunder that the Company may have acquired in any manner whatsoever, and all Certificates so delivered shall, upon an Issuer Order, be promptly cancelled by the Purchase Contract Agent. No Certificates shall be authenticated, executed on behalf of the Holder and delivered in lieu of or in exchange for any Certificates cancelled as provided in this Section 3.12, except as expressly permitted by this Agreement. All cancelled Certificates held by the Purchase Contract Agent shall be disposed of in accordance with its customary practices.

If the Company or any Affiliate of the Company shall acquire any Certificate, such acquisition shall not operate as a cancellation of such Certificate unless and until such Certificate is delivered to the Purchase Contract Agent cancelled or for cancellation.

Section 3.13. *Creation of Treasury Units by Substitution of Treasury Securities.* (a) Unless Applicable Ownership Interests in the Treasury Portfolio have replaced the Applicable Ownership Interests in Senior Notes as a component of the Corporate Units, and subject to the conditions set forth in this Agreement, a Holder of Corporate Units may, at any time from and after the date of this Agreement and prior to 5:00 p.m. (New York City time) on the seventh Business Day immediately preceding the Purchase Contract Settlement Date, effect a Collateral Substitution and separate the Senior Notes underlying Applicable Ownership Interests in Senior Notes in respect of such Holder's Corporate Units by substituting for such Applicable Ownership Interests in Senior Notes, Treasury Securities in an aggregate principal amount at maturity equal to the aggregate principal amount of the Senior Notes underlying the Applicable Ownership Interests in Senior Notes; *provided* that Holders may make Collateral Substitutions only in integral multiples of 40 Corporate Units. To effect such substitution, the Holder must:

- (1) Transfer to the Securities Intermediary, for credit to the Collateral Account, Treasury Securities or security entitlements with respect thereto having a Value equal to the aggregate principal amount of the Senior Notes underlying the Pledged Applicable Ownership Interests in Senior Notes for which such Collateral Substitution is made; and
- (2) Transfer the related Corporate Units to the Purchase Contract Agent accompanied by a notice to the Purchase Contract Agent, substantially in the form of Exhibit C hereto, whereupon the Purchase Contract Agent shall promptly provide an instruction to such effect to the Collateral Agent, substantially in the form of Exhibit G hereto.

Upon confirmation that the Treasury Securities described in clause (1) above or security entitlements with respect thereto have been credited to the Collateral Account and receipt of the instruction to the Collateral Agent described in clause (2) above, the Collateral Agent shall release such Pledged Applicable Ownership Interests in Senior Notes from the Pledge and instruct the Securities Intermediary by a notice, substantially in the form of Exhibit H hereto, to Transfer the Senior Notes underlying such Pledged Applicable

29

---

Ownership Interests in Senior Notes to the Purchase Contract Agent for distribution to such Holder, free and clear of the Pledge created hereby.

Upon credit to the Collateral Account of Treasury Securities or security entitlements with respect thereto delivered by a Holder of Corporate Units and receipt of the related instruction from the Collateral Agent, the Securities Intermediary shall promptly Transfer the Senior Notes underlying the appropriate Pledged Applicable Ownership Interests in Senior Notes to the Purchase Contract Agent for distribution to such Holder, free and clear of the Pledge created hereby.

Upon receipt of the Senior Notes underlying such Pledged Applicable Ownership Interests in Senior Notes, the Purchase Contract Agent shall promptly:

- (i) cancel the related Corporate Units;
- (ii) Transfer the Senior Notes to the Holder; and
- (iii) deliver Treasury Units in book-entry form, or if applicable, authenticate, execute on behalf of such Holder and deliver Treasury Units in the form of a Treasury Units Certificate executed by the Company in accordance with Section 3.03 evidencing the same number of Purchase Contracts as were evidenced by the cancelled Corporate Units.

Holders who elect to separate the Senior Notes by substituting Treasury Securities for Applicable Ownership Interest in Senior Notes shall be responsible for any fees or expenses, (including, without limitation, fees and expenses payable to the Collateral Agent), in respect of the substitution, and neither the Company nor the Purchase Contract Agent shall be responsible for any such fees or expenses.

(b) If Applicable Ownership Interests in the Treasury Portfolio have replaced Applicable Ownership Interests in Senior Notes as a component of the Corporate Units, and subject to the conditions set forth in this Agreement, a Holder of Corporate Units may, at any time from and after the date of this Agreement and prior to 5:00 p.m. (New York City time) on the seventh Business Day immediately preceding the Purchase Contract Settlement Date, substitute Treasury Securities for the Pledged Applicable Ownership Interests in the Treasury Portfolio included in such Corporate Units, but only in integral multiples of [•] Corporate Units. In such an event, the Holder shall Transfer Treasury Securities having an aggregate principal amount at maturity equal to equal to the aggregate Stated Amount of the Purchase Contracts constituting a part of the Corporate Units for which Collateral Substitution is being made to the Securities Intermediary, for credit to the Collateral Account, and the Purchase Contract Agent, Collateral Agent and Securities Intermediary shall effect a Collateral Substitution for the appropriate Pledged Applicable Ownership Interests in the Treasury Portfolio in the manner set forth in clause (a) above.

(c) In the event a Holder making a Collateral Substitution pursuant to this Section 3.13 fails to effect a book-entry transfer of the Corporate Units or fails to deliver Corporate Units Certificates to the Purchase Contract Agent after depositing Treasury Securities with the Securities Intermediary, any distributions on the Senior Notes

underlying the Applicable Ownership Interests in Senior Notes, or with respect to the Applicable Ownership Interests in the Treasury Portfolio, in each case constituting a part of such Corporate Units, shall be held in the name of the Purchase Contract Agent or its nominee in trust for the benefit of such Holder, until such Corporate Units are so transferred or the Corporate Units Certificate is so delivered, as the case may be, or such Holder provides evidence satisfactory to the Company and the Purchase Contract Agent that such Corporate Units Certificate has been destroyed, lost or stolen, together with any indemnity that may be required by the Purchase Contract Agent and the Company.

(d) Except as described in Section 5.02 or in this Section 3.13 or in connection with a Cash Settlement, an Early Settlement, a Cash Merger Early Settlement or a Termination Event, for so long as the Purchase Contract underlying a Corporate Unit remains in effect, such Corporate Units shall not be separable into its constituent parts, and the rights and obligations of the Holder in respect of the Applicable Ownership Interests in Senior Notes or Applicable Ownership Interests in the Treasury Portfolio, as the case may be, and the Purchase Contract comprising such Corporate Units may be acquired, and may be transferred and exchanged, only as a Corporate Unit.

Section 3.14. *Recreation of Corporate Units.* (a) Unless Applicable Ownership Interests in the Treasury Portfolio have replaced Applicable Ownership Interests in Senior Notes as a component of the Corporate Units, and subject to the conditions set forth in this Agreement, a Holder of Treasury Units may recreate Corporate Units at any time from and after the date of this Agreement and prior to 5:00 p.m. (New York City time) on the seventh Business Day immediately preceding the Purchase Contract Settlement Date; *provided* that Holders of Treasury Units may only recreate Corporate Units in integral multiples of 40 Treasury Units. To recreate Corporate Units, the Holder must:

- (1) Transfer to the Securities Intermediary for credit to the Collateral Account Senior Notes or security entitlements with respect thereto having an aggregate principal amount equal to the Value of the Pledged Treasury Securities to be released; and
- (2) Transfer the related Treasury Units to the Purchase Contract Agent accompanied by a notice to the Purchase Contract Agent, substantially in the form of Exhibit C hereto, whereupon the Purchase Contract Agent shall promptly provide an instruction to such effect to the Collateral Agent, substantially in the form of Exhibit I hereto.

Upon confirmation that the Senior Notes described in clause (1) above or security entitlements with respect thereto has been credited to the Collateral Account and receipt of the instruction from the Purchase Contract Agent described in clause (2) above, the Collateral Agent shall release such Pledged Treasury Securities from the Pledge and shall instruct the Securities Intermediary by a notice, substantially in the form of Exhibit J hereto, to Transfer such Pledged Treasury Securities to the Purchase Contract Agent for distribution to such Holder, free and clear of the Pledge created hereby.

Upon credit to the Collateral Account of Senior Notes or security entitlements with respect thereto delivered by a Holder of Treasury Units and receipt of the related

instruction from the Collateral Agent, the Securities Intermediary shall promptly Transfer the Pledged Treasury Securities to the Purchase Contract Agent for distribution to such Holder, free and clear of the Pledge created hereby.

Upon receipt of such Treasury Securities, the Purchase Contract Agent shall promptly:

- (i) cancel the related Treasury Units;
- (ii) Transfer the Treasury Securities to the Holder; and
- (iii) deliver Corporate Units in book-entry form or, if applicable, authenticate, execute on behalf of such Holder and deliver Corporate Units in the form of a Corporate Units Certificate executed by the Company in accordance with Section 3.03 evidencing the same number of Purchase Contracts as were evidenced by the cancelled Treasury Units.

Holders who elect to recreate Corporate Units shall be responsible for any fees or expenses, (including, without limitation, fees and expenses payable to the Collateral Agent), in respect of the recreation, and neither the Company nor the Purchase Contract Agent shall be responsible for any such fees or expenses.

(b) If Applicable Ownership Interests in the Treasury Portfolio have replaced Applicable Ownership Interests in Senior Notes as a component of the Corporate Units and subject to the conditions set forth in this Agreement, a Holder of Treasury Units may at any time from and after the date of this Agreement and prior to 5:00 p.m. (New York City time) on the seventh Business Day immediately preceding the Purchase Contract Settlement Date substitute the Pledged Applicable Ownership Interests in the Treasury Portfolio for Treasury Securities included in such Treasury Units, but only in multiples of [•] Treasury Units. In such an event, the Holder shall Transfer Applicable Ownership Interests in the Treasury Portfolio having a Value equal to the aggregate Value of the Treasury Securities for which substitution is being made to the Securities Intermediary, for credit to the Collateral Account, and the Purchase Contract Agent, Collateral Agent and Securities Intermediary shall effect a Collateral Substitution and release the Pledged Applicable Ownership Interests in the Treasury Portfolio from the Pledge in the manner set forth in clause (a) above.

(c) Except as provided in Section 5.02 or in this Section 3.14 or in connection with a Cash Settlement, an Early Settlement, a Cash Merger Early Settlement or a Termination Event, for so long as the Purchase Contract underlying a Treasury Unit remains in effect, such Treasury Unit shall not be separable into its constituent parts and the rights and obligations of the Holder of such Treasury Unit in respect of the interest in the Treasury Security and the Purchase Contract comprising such Treasury Unit may be acquired, and may be transferred and exchanged, only as a Treasury Unit.

Section 3.15. *Transfer of Collateral Upon Occurrence of Termination Event.* (a) Upon receipt by the Collateral Agent of written notice pursuant to Section 5.06 hereof from the Company or the Purchase Contract Agent that a Termination Event has occurred,

the Collateral Agent shall release all Collateral from the Pledge and shall promptly instruct the Securities Intermediary to Transfer:

- (i) any Senior Notes underlying Pledged Applicable Ownership Interests in Senior Notes or security entitlements with respect thereto or Pledged Applicable Ownership Interests in the Treasury Portfolio;
- (ii) any Pledged Treasury Securities;
- (iii) any payments by Holders (or the Permitted Investments of such payments) pursuant to Section 5.02 hereof; and

- (iv) any Proceeds and all other payments the Collateral Agent receives in respect of the foregoing,

to the Purchase Contract Agent for the benefit of the Holders for distribution to such Holders, in accordance with their respective interests, free and clear of the Pledge created hereby; *provided, however*, if any Holder or Beneficial Owner shall be entitled to receive Senior Notes in an aggregate principal amount of less than \$1,000, or greater than \$1,000 but not in an integral multiple of \$1,000, the Purchase Contract Agent shall request, on behalf of such Holder or Beneficial Owner, pursuant to Section 2.03 of the Supplemental Indenture that the Company issue Senior Notes in denominations of \$25, or integral multiples thereof, in exchange for Senior Notes in denominations of \$1,000 or integral multiples thereof; and *provided further*, if any Holder shall be entitled to receive less than \$1,000 with respect to its Pledged Applicable Ownership Interests in the Treasury Portfolio, the Purchase Contract Agent shall have the right (but not the obligation) to dispose of such interest for cash and deliver to such Holder cash in lieu of delivering the Pledged Applicable Ownership Interests in the Treasury Portfolio.

(b) Notwithstanding anything to the contrary in clause (a) of this Section 3.15, if such Termination Event shall result from the Company's becoming a debtor under the Bankruptcy Code, and if the Collateral Agent shall for any reason fail promptly to effectuate the release and Transfer of all Senior Notes underlying Pledged Applicable Ownership Interests in Senior Notes, Pledged Applicable Ownership Interests in the Treasury Portfolio, Pledged Treasury Securities and payments by Holders (or the Permitted Investments of such payments) pursuant to Section 5.02 and Proceeds and all other payments received by the Collateral Agent in respect of the foregoing, as the case may be, as provided by this Section 3.15, the Purchase Contract Agent shall use its best efforts to obtain an opinion of a nationally recognized law firm to the effect that, notwithstanding the Company's being the debtor in such a bankruptcy case, the Collateral Agent will not be prohibited from releasing or Transferring the Collateral as provided in this Section 3.15, and shall deliver or cause to be delivered such opinion to the Collateral Agent within ten days after the occurrence of such Termination Event, and if (A) the Purchase Contract Agent shall be unable to obtain such opinion within ten days after the occurrence of such Termination Event or (B) the Collateral Agent shall continue, after delivery of such opinion, to refuse to effectuate the release and Transfer of all Senior Notes underlying Pledged Applicable Ownership Interests in Senior Notes, Pledged Applicable Ownership Interests in the Treasury Portfolio, Pledged Treasury Securities and the payments by

33

Holders (or the Permitted Investments of such payments) pursuant to Section 5.02 hereof and Proceeds and all other payments received by the Collateral Agent in respect of the foregoing, as the case may be, as provided in this Section 3.15, then the Purchase Contract Agent shall within fifteen days after the occurrence of such Termination Event commence an action or proceeding in the court having jurisdiction of the Company's case under the Bankruptcy Code seeking an order requiring the Collateral Agent to effectuate the release and transfer of all Senior Notes underlying Pledged Applicable Ownership Interests in Senior Notes, Pledged Applicable Ownership Interest in the Treasury Portfolio, Pledged Treasury Securities and the payments by Holders (or the Permitted Investments of such payments) pursuant to Section 5.02 hereof and Proceeds and all other payments received by the Collateral Agent in respect of the foregoing, or as the case may be, as provided by this Section 3.15.

(c) Upon the occurrence of a Termination Event and the Transfer to the Purchase Contract Agent of the Senior Notes underlying Pledged Applicable Ownership Interests in Senior Notes, the appropriate Pledged Applicable Ownership Interests in the Treasury Portfolio or the Pledged Treasury Securities, as the case may be, pursuant to Section 3.15, the Purchase Contract Agent shall request transfer instructions with respect to such Senior Notes, Applicable Ownership Interests in the Treasury Portfolio or Pledged Treasury Securities, as the case may be, from each Holder by written request, substantially in the form of Exhibit D hereto, mailed to such Holder at its address as it appears in the Security Register.

(d) Upon book-entry transfer of the Corporate Units or the Treasury Units or delivery of a Corporate Units Certificate or Treasury Units Certificate to the Purchase Contract Agent with such transfer instructions, the Purchase Contract Agent shall transfer the Senior Notes underlying Pledged Applicable Ownership Interests in Senior Notes, the Pledged Applicable Ownership Interests in the Treasury Portfolio or Pledged Treasury Securities, as the case may be, underlying such Corporate Units or Treasury Units, as the case may be, to such Holder by book-entry transfer, or other appropriate procedures, in accordance with such instructions and, in the case of the Senior Notes underlying Pledged Applicable Ownership Interests in Senior Notes, in accordance with the terms of the Supplemental Indenture. In the event a Holder of Corporate Units or Treasury Units fails to effect such transfer or delivery, the Senior Notes underlying Pledged Applicable Ownership Interests in Senior Notes, the Pledged Applicable Ownership Interests in the Treasury Portfolio or Pledged Treasury Securities, as the case may be, underlying such Corporate Units of Treasury Units, as the case may be, and any distributions thereon, shall be held in the name of the Purchase Contract Agent or its nominee in trust for the benefit of such Holder, until the earlier to occur of:

- (i) the transfer of such Corporate Units or Treasury Units or surrender of the Corporate Units Certificate or Treasury Units Certificate or the receipt by the Company and the Purchase Contract Agent from such Holder of satisfactory evidence that such Corporate Units Certificate or Treasury Units Certificate has been destroyed, lost or stolen, together with any indemnity that may be required by the Purchase Contract Agent and the Company; and

34

- (ii) the expiration of the time period specified by the applicable law governing abandoned property in the state in which the Purchase Contract Agent holds such property.

Section 3.16. *No Consent to Assumption.* Each Holder of a Unit, by acceptance thereof, shall be deemed expressly to have withheld any consent to the assumption under Section 365 of the Bankruptcy Code or otherwise, of the Purchase Contract by the Company or its trustee, receiver, liquidator or a person or entity performing similar functions in the event that the Company becomes a debtor under the Bankruptcy Code or subject to other similar state or Federal law providing for reorganization or liquidation.

Section 3.17. *Substitutions.* Whenever a Holder has the right to substitute Treasury Securities, Senior Notes underlying Applicable Ownership Interests in Senior Notes or the Applicable Ownership Interests in the Treasury Portfolio (as defined in clause (i) of the definition of such term), as the case may be, or security entitlements for any of them for financial assets held in the Collateral Account, such substitution shall not constitute a novation of the security interest created hereby.

#### ARTICLE 4 THE SENIOR NOTES

Section 4.01. *Interest Payments; Rights to Interest Payments Preserved.* (a) The Collateral Agent (if the Senior Notes underlying Pledged Applicable Ownership Interests in Senior Notes are in the name of the Collateral Agent) shall transfer all income and distributions received by it on account of the Senior Notes underlying Pledged Applicable Ownership Interests in Senior Notes, the Pledged Applicable Ownership Interests in the Treasury Portfolio or Permitted Investments from time to time held in the Collateral Account (ABA No. [•], Global Plus A/C No. [•], Re: Genworth Financial, Inc.) to the Purchase Contract Agent for distribution to the applicable Holders as provided in this Agreement and the Purchase Contracts.

(b) Any payment on any Senior Note underlying Applicable Ownership Interests in Senior Notes or any distribution on any Applicable Ownership Interests in the Treasury Portfolio (as specified in clause (ii) of the definition of such term), as the case may be, which is paid on any Payment Date shall, subject to receipt thereof by the Purchase Contract Agent from the Company or from the Collateral Agent as provided in Section 4.01(a) above, be paid to the Person in whose name the Corporate Units Certificate (or one or more Predecessor Corporate Units Certificates) of which such Applicable Ownership Interest in Senior Notes or Applicable Ownership Interests in the Treasury Portfolio, as the case may be, forms a part is registered at the close of business on the Record Date for such Payment Date.

(c) Each Corporate Units Certificate evidencing Applicable Ownership Interests in Senior Notes or Applicable Ownership Interests in the Treasury Portfolio delivered under this Agreement upon registration of transfer of or in exchange for or in lieu of any other Corporate Units Certificate shall carry the right to accrued and unpaid interest or distributions, and to accrued interest or distributions, which were carried by Applicable

Ownership Interests in Senior Notes or Applicable Ownership Interests in the Treasury Portfolio underlying such other Corporate Units Certificate.

(d) In the case of any Corporate Unit with respect to which (1) Cash Settlement of the underlying Purchase Contract is properly effected pursuant to Section 5.02(a) hereof, (2) Early Settlement of the underlying Purchase Contract is properly effected pursuant to Section 5.07 hereof, (3) Cash Merger Early Settlement of the underlying Purchase Contract is properly effected pursuant to Section 5.04(b)(ii) hereof (4) a Collateral Substitution is properly effected pursuant to Section 3.13, in each case on a date that is after any Record Date and prior to or on the next succeeding Payment Date, interest in respect of the Senior Notes underlying Applicable Ownership Interests in Senior Notes or distributions on Applicable Ownership Interests in the Treasury Portfolio, as the case may be, underlying such Corporate Unit otherwise payable on such Payment Date shall be payable on such Payment Date notwithstanding such Cash Settlement, Early Settlement, Cash Merger Early Settlement or Collateral Substitution, and such payment or distributions shall, subject to receipt thereof by the Purchase Contract Agent, be payable to the Person in whose name the Corporate Units Certificate (or one or more Predecessor Corporate Units Certificates) was registered at the close of business on the Record Date.

(e) Except as otherwise expressly provided in Section 4.01(d) hereof, in the case of any Corporate Unit with respect to which Cash Settlement, Early Settlement or Cash Merger Early Settlement of the component Purchase Contract is properly effected, or with respect to which a Collateral Substitution has been effected, payments attributable to the Senior Notes underlying Applicable Ownership Interests in Senior Notes or distributions on Applicable Ownership Interests in the Treasury Portfolio, as the case may be, that would otherwise be payable or made after the Purchase Contract Settlement Date, Early Settlement Date, Cash Merger Early Settlement Date or the date of the Collateral Substitution, as the case may be, shall not be payable hereunder to the Holder of such Corporate Units; *provided*, however, that to the extent that such Holder continues to hold Separate Senior Notes or Applicable Ownership Interests in the Treasury Portfolio that formerly comprised a part of such Holder's Corporate Units, such Holder shall be entitled to receive interest on such Separate Senior Notes or distributions on such Applicable Ownership Interests in the Treasury Portfolio.

Section 4.02. *Payments Prior to or on Purchase Contract Settlement Date.* (a) Subject to the provisions of Section 5.02(a), Section 5.04(b)(ii) and Section 5.07, and except as provided in Section 4.02(b) below, if no Termination Event shall have occurred, all payments received by the Securities Intermediary in respect of (1) the principal amount of the Senior Notes underlying Pledged Applicable Ownership Interests in Senior Notes, (2) the Pledged Applicable Ownership Interests in the Treasury Portfolio and (3) the Pledged Treasury Securities, shall be credited to the Collateral Account, to be invested in Permitted Investments until the Purchase Contract Settlement Date, and transferred to the Company on the Purchase Contract Settlement Date as provided in Section 5.02 hereof. Any balance remaining in the Collateral Account shall be released from the Pledge and transferred to the Purchase Contract Agent for the benefit of the applicable Holders for distribution to such Holders in accordance with their respective interests, free and clear of the Pledge created hereby. The Company shall instruct the Collateral Agent in writing as to the specific Permitted Investments in which any payments made under this Section 4.02

shall be invested, *provided, however*, that if the Company fails to deliver such instructions by 10:30 a.m. (New York City time) on the day such payments are received by the Securities Intermediary, the Collateral Agent shall instruct the Securities Intermediary to invest such payments in the Permitted Investments described in clause (6) of the definition of Permitted Investments. In no event shall the Collateral Agent be liable for the selection of Permitted Investments or for investment losses incurred thereon. The Collateral Agent shall have no liability in respect of losses incurred as a result of the failure of the Company to provide timely written investment direction.

(b) All payments received by the Securities Intermediary in respect of (1) the Senior Notes, (2) the Applicable Ownership Interests in the Treasury Portfolio and (3) the Treasury Securities or security entitlements with respect thereto, that, in each case, have been released from the Pledge pursuant hereto shall be transferred to the Purchase Contract Agent for the benefit of the applicable Holders for distribution to such Holders in accordance with their respective interests.

Section 4.03. *Notice and Voting.* (a) Subject to Section 4.03(b) hereof, the Purchase Contract Agent may exercise, or refrain from exercising, any and all voting and other consensual rights pertaining to the Senior Notes underlying Pledged Applicable Ownership Interests in Senior Notes or any part thereof for any purpose not inconsistent with the terms of this Agreement; *provided* that the Purchase Contract Agent shall not exercise or shall not refrain from exercising such right, as the case may be, if, in the judgment of the Purchase Contract Agent, such action would impair or otherwise have a material adverse effect on the value of all or any of the Senior Notes underlying Pledged Applicable Ownership Interests in Senior Notes; and *provided further* that the Purchase Contract Agent shall give the Company and the Collateral Agent at least five Business Days' prior written notice of the manner in which it intends to exercise, or its reasons for refraining from exercising, any such right. Upon receipt of any notices and other communications in respect of any Senior Notes underlying Pledged Applicable Ownership Interests in Senior Notes, including either notice of any meeting at which holders of the Senior Notes are entitled to vote or the solicitation of consents, waivers or proxies of holders of the Senior Notes, the Collateral Agent shall use reasonable efforts to send promptly to the Purchase Contract Agent such notice or communication, and as soon as reasonably practicable after receipt of a written request therefor from the Purchase Contract Agent, to execute and deliver to the Purchase Contract Agent such proxies and other instruments in respect of such Senior Notes underlying Pledged Applicable Ownership Interests in Senior Notes (in form and substance satisfactory to the Collateral Agent) as are prepared by the Company and delivered to the Purchase Contract Agent with respect to the Senior Notes underlying Pledged Applicable Ownership Interests in Senior Notes.

(b) Upon receipt of notice of any meeting at which holders of Senior Notes are entitled to vote or upon any solicitation of consents, waivers or proxies of holders of Senior Notes, the Purchase Contract Agent shall, as soon as practicable thereafter, mail, first class, postage pre-paid, to the Holders of Corporate Units a notice:

- (i) containing such information as is contained in the notice or solicitation;

- (ii) stating that each Holder on the record date set by the Purchase Contract Agent therefor (which, to the extent possible, shall be the same date as the record date set by the Company for determining the holders of Senior Notes entitled to vote) shall be entitled to instruct the Purchase Contract Agent as to the exercise of the voting rights pertaining to the Senior Notes underlying the Applicable Ownership Interests in Senior Notes that are a component of their Corporate Units; and

- (iii) stating the manner in which such instructions may be given.

Upon the written request of the Holders of Corporate Units on such record date received by the Purchase Contract Agent at least six days prior to such meeting, the Purchase Contract Agent shall endeavor insofar as practicable to vote or cause to be voted, in accordance with the instructions set forth in such requests, the maximum aggregate principal amount of Senior Notes (rounded down to the nearest integral multiple of \$1,000) as to which any particular voting instructions are received. In the absence of specific instructions from the Holder of Corporate Units, the Purchase Contract Agent shall abstain from voting the Senior Notes underlying Applicable Ownership Interests in Senior Notes that are a component of such Corporate Units. The Company hereby agrees, if applicable, to solicit Holders of Corporate Units to timely instruct the Purchase Contract Agent as to the exercise of such voting rights in order to enable the Purchase Contract Agent to vote such Senior Notes.

- (c) The Holders of Corporate Units and the Holders of Treasury Units shall have no voting or other rights in respect of Common Stock.

Section 4.04. *Special Event Redemption.*

(a) If the Company elects to redeem the Senior Notes following the occurrence of a Special Event as permitted by the Indenture, it shall notify the Collateral Agent in writing that a Special Event has occurred and that it intends to redeem the Senior Notes on the Special Event Redemption Date. Upon the occurrence of such Special Event Redemption while Senior Notes are still credited to the Collateral Account, the Collateral Agent shall, and is hereby authorized to, instruct the Securities Intermediary to present the Senior Notes underlying Pledged Applicable Ownership Interests in Senior Notes for payment as may be required by their respective terms and to direct the Indenture Trustee to remit the Redemption Price to the Securities Intermediary for credit to the Collateral Account, on or prior to 12:30 p.m., New York City time, on such Special Event Redemption Date, by federal funds check or wire transfer of immediately available funds. Upon receipt of such funds by the Securities Intermediary and the credit thereof to the Collateral Account, the Senior Notes underlying Pledged Applicable Ownership Interests in Senior Notes shall be released from the Collateral Account and promptly transferred to the Company. Upon the crediting of such funds to the Collateral Account, the Collateral Agent, at the written direction of the Company, shall instruct the Securities Intermediary to (i) apply an amount equal to the Redemption Amount of such funds to purchase the Treasury Portfolio from the Quotation Agent, (ii) credit to the Collateral Account the Applicable Ownership Interests in the Treasury Portfolio and (iii) promptly remit the

38

remaining portion of such funds to the Purchase Contract Agent for payment to the Holders of Corporate Units, in accordance with their respective interests.

(b) Upon the occurrence of a Special Event Redemption, (i) the Applicable Ownership Interests in the Treasury Portfolio (as specified in clause (i) of the definition of such term) will be substituted as Collateral for the Pledged Applicable Ownership Interests in Senior Notes and will be held by the Collateral Agent in accordance with the terms hereof to secure the Obligation of each Holder of Corporate Units, (ii) the Holders of Corporate Units and the Collateral Agent shall have such rights and obligations, and the Collateral Agent shall have such security interest, with respect to such Applicable Ownership Interests in the Treasury Portfolio (as specified in clause (i) of the definition of such term) as the Holders of Corporate Units and the Collateral Agent had in respect of the Pledged Applicable Ownership Interests in Senior Notes, subject to the Pledge thereof, and (iii) any reference in this Agreement to Applicable Ownership Interests in Senior Notes shall be deemed to be a reference to such Applicable Ownership Interests in the Treasury Portfolio (as specified in clause (i) of the definition of such term). The Company may cause to be made in any Corporate Units Certificates thereafter to be issued such change in phraseology and form (but not in substance) as may be appropriate to reflect the substitution of the Applicable Ownership Interests in the Treasury Portfolio (as specified in clause (i) of the definition of such term) for Applicable Ownership Interests in Senior Notes as Collateral.

Section 4.05. *Payments to Purchase Contract Agent.* The Securities Intermediary shall use commercially reasonable efforts to deliver any payments required to be made by it to the Purchase Contract Agent hereunder to the account designated by the Purchase Contract Agent for such purpose not later than 12:00 p.m. (New York City time) on the Business Day such payment is received by the Securities Intermediary; *provided, however*, that if such payment is received on a day that is not a Business Day or after 11:00 a.m. (New York City time) on a Business Day, then the Securities Intermediary shall use commercially reasonable efforts to deliver such payment to the Purchase Contract Agent no later than 10:30 a.m. (New York City time) on the next succeeding Business Day.

Section 4.06. *Payments Held in Trust.* If the Purchase Contract Agent or any Holder shall receive any payments on account of financial assets credited to the Collateral Account (other than interest on the Senior Notes or distributions on the Applicable Ownership Interests in the Treasury Portfolio (as specified in clause (ii) of the definition thereof)) and not released therefrom in accordance with this Agreement, the Purchase Contract Agent or such Holder shall hold such payments as trustee of an express trust for the benefit of the Company and, upon receipt of an Officers' Certificate of the Company so directing, promptly deliver such payments to the Securities Intermediary for credit to the Collateral Account or to the Company for application to the Obligations of the applicable Holder or Holders, and the Purchase Contract Agent and Holders shall acquire no right, title or interest in any such payments of principal amounts so received. The Purchase Contract Agent shall have no liability under this Section 4.06 unless and until it has been notified in writing that such payment was delivered to it erroneously and shall have no liability for any action taken, suffered or omitted to be taken prior to its receipt of such notice.

39

## ARTICLE 5 THE PURCHASE CONTRACTS

Section 5.01. *Purchase of Shares of Common Stock.* (a) Each Purchase Contract shall obligate the Holder of the related Unit to purchase, and the Company to sell, on the Purchase Contract Settlement Date at a price equal to the Stated Amount (the "**Purchase Price**"), a number of newly issued shares of Common Stock (subject to Section 5.08) equal to the Settlement Rate unless an Early Settlement, a Cash Merger Early Settlement or a Termination Event with respect to the Units of which such Purchase Contract is a part shall have occurred. The "**Settlement Rate**" is equal to:

- (i) If the Applicable Market Value is greater than or equal to \$[\*] (the "**Threshold Appreciation Price**"), [\*] shares of Common Stock per Purchase Contract (the "**Minimum Settlement Rate**");
- (ii) if the Applicable Market Value is less than the Threshold Appreciation Price but greater than \$[\*] (the "**Reference Price**"), the number of shares of Common Stock per Purchase Contract having a value (based on the Applicable Market Value) equal to the Stated Amount;
- (iii) if the Applicable Market Value is less than or equal to the Reference Price, [\*] shares of Common Stock per Purchase Contract (the "**Maximum Settlement Rate**");

in each case subject to adjustment as provided in Section 5.04 (and in each case rounded upward or downward to the nearest 1/10,000th of a share).

The "**Applicable Market Value**" means the average of the Closing Price per share of Common Stock on each of the 20 consecutive Trading Days ending on the third Trading Day immediately preceding the Purchase Contract Settlement Date, subject to adjustment as set forth under Section 5.04 hereof.

The "**Closing Price**" per share of Common Stock on any date of determination means:

- (i) the closing sale price as of the close of the principal trading session (or, if no closing price is reported, the last reported sale price) per share on the New York Stock Exchange, Inc. (the "**NYSE**") on such date; or
- (ii) if the Common Stock is not listed for trading on the NYSE on any such date, the closing sale price (or, if no closing price is reported, the last reported sale price) per share as reported in the composite transactions for the principal United States securities exchange on which the Common Stock is so listed; or
- (iii) if the Common Stock is not so listed on a United States national or regional securities exchange, the closing sale price (or, if no closing price is reported, the last reported sale price) per share as reported by The Nasdaq National Market; or

40

- (iv) if the Common Stock is not so reported by the Nasdaq National Market, the last quoted bid price for the Common Stock in the over-the-counter market as reported by the National Quotation Bureau or similar organization; or

(v) if the bid price referred to in clause (iv) above is not available, the average of the mid-point of the last bid and ask prices of the Common Stock on such date from at least three nationally recognized independent investment banking firms retained by the Company for purposes of determining the Closing Price.

A “**Trading Day**” means a day on which the Common Stock (i) is not suspended from trading on any national or regional securities exchange or association or over-the-counter market at the close of business and (ii) has traded at least once on the national or regional securities exchange or association or over-the-counter market that is the primary market for the trading of the Common Stock.

(b) Each Holder of a Corporate Unit or a Treasury Unit, by its acceptance of such Unit:

(i) irrevocably authorizes the Purchase Contract Agent to enter into and perform the related Purchase Contract on its behalf as its attorney-in-fact (including, without limitation, the execution of Certificates on behalf of such Holder);

(ii) agrees to be bound by the terms and provisions of such Unit, including but not limited to the terms and provisions of the Purchase Contract;

(iii) covenants and agrees to perform its obligations under such Purchase Contract for so long as such Holder remains a Holder of a Corporate Unit or a Treasury Unit;

(iv) consents to the provisions hereof;

(v) irrevocably authorizes the Purchase Contract Agent to enter into and perform this Agreement on its behalf and in its name as its attorney-in-fact;

(vi) consents to, and agrees to be bound by, the Pledge of such Holder’s right, title and interest in and to the Collateral, including the Applicable Ownership Interests in Senior Notes and the Applicable Ownership Interests in the Treasury Portfolio (as specified in clause (i) of the definition of such term) or the Treasury Securities pursuant to this Agreement, and the delivery of the Senior Notes underlying such Applicable Ownership Interests in Senior Notes by the Purchase Contract Agent to the Collateral Agent; and

(vii) for United States federal, state and local income and franchise tax purposes, agrees to (A) treat its acquisition of the Corporate Units as an acquisition of the Applicable Ownership Interest in Senior Notes and Purchase Contract constituting the Corporate Units, (B) treat the Applicable Ownership Interest in Senior Notes as indebtedness of the Company and (C) treat itself as the owner of

41

---

the applicable interests in the Collateral, including the Senior Notes underlying the Applicable Ownership Interests in Senior Notes, the Applicable Ownership Interests in the Treasury Portfolio (as specified in clause (i) of the definition of such term) or the Treasury Securities, as applicable;

*provided* that upon a Termination Event, the rights of the Holder of such Units under the Purchase Contract may be enforced without regard to any other rights or obligations.

(c) Each Holder of a Corporate Unit or a Treasury Unit, by its acceptance thereof, further covenants and agrees that to the extent and in the manner provided in Section 5.02 hereof, but subject to the terms thereof, on the Purchase Contract Settlement Date, Proceeds of the Pledged Applicable Ownership Interests in Senior Notes, the Pledged Applicable Ownership Interests in the Treasury Portfolio or the Pledged Treasury Securities, as applicable, equal to the Purchase Price shall be paid by the Collateral Agent to the Company in satisfaction of such Holder’s obligations under such Purchase Contract and such Holder shall acquire no right, title or interest in such Proceeds.

(d) Upon registration of transfer of a Certificate, the transferee shall be bound (without the necessity of any other action on the part of such transferee) by the terms of this Agreement and the Purchase Contracts underlying such Certificate and the transferor shall be released from the obligations under this Agreement and the Purchase Contracts underlying the Certificate so transferred. The Company covenants and agrees, and each Holder of a Certificate, by its acceptance thereof, likewise covenants and agrees, to be bound by the provisions of this paragraph.

*Section 5.02. Cash Settlement; Remarketing; Payment of Purchase Price.*

(a) *Cash Settlement.* (i) Unless (1) a Termination Event has occurred, (2) a Holder effects an Early Settlement or a Cash Merger Early Settlement of the underlying Purchase Contract or (3) a Special Event Redemption has occurred prior to the seventh Business Day immediately preceding the Purchase Contract Settlement Date, each Holder of Corporate Units shall have the right to satisfy such Holder’s Obligations on the Purchase Contract Settlement Date in cash. Each Holder of Corporate Units who intends to pay in cash to satisfy such Holder’s Obligations under the Purchase Contract on the Purchase Contract Settlement Date shall notify the Purchase Contract Agent by use of a notice in substantially the form of Exhibit E hereto of his intention to pay in cash (a “**Cash Settlement**”) the Purchase Price for the Common Stock to be purchased pursuant to the related Purchase Contract. Such notice shall be given prior to 5:00 p.m. (New York City time) on the seventh Business Day immediately preceding the Purchase Contract Settlement Date. Corporate Units Holders may only effect such a Cash Settlement pursuant to this Section 5.02(a) in integral multiples of 40 Corporate Units.

(ii) A Holder of a Corporate Unit who has so notified the Purchase Contract Agent of his intention to effect a Cash Settlement in accordance with Section 5.02(a)(i) above shall pay the Purchase Price to the Securities Intermediary for deposit in the Collateral Account prior to 5:00 p.m. (New York City time) on the sixth Business Day immediately preceding the Purchase Contract Settlement Date, in lawful money of the United States by certified or cashiers check or wire

42

---

transfer in immediately available funds payable to or upon the order of the Securities Intermediary.

(iii) If a Holder of a Corporate Unit fails to notify the Purchase Contract Agent of its intention to make a Cash Settlement in accordance with Section 5.02(a)(i), or does notify the Purchase Contract Agent as provided in Section 5.02(a)(i) of its intention to pay the Purchase Price in cash, but fails to make such payment as required by Section 5.02(a)(ii), such Holder shall be deemed to have consented to the disposition of the Senior Notes underlying the Pledged Applicable Ownership Interests in Senior Notes pursuant to each Remarketing as described in Section 5.02(b) below.

(iv) Promptly after 5:00 p.m. (New York City time) on the sixth Business Day preceding the Purchase Contract Settlement Date, the Purchase Contract Agent, based on notices received by the Purchase Contract Agent pursuant to Section 5.02(a)(i) hereof and notice from the Securities Intermediary regarding cash received by it prior to such time, shall notify the Collateral Agent of the aggregate number of Senior Notes to be remarketed in each Remarketing in a notice substantially in the form of Exhibit K hereto.

(v) Upon (1) receipt by the Collateral Agent of a notice from the Purchase Contract Agent promptly after the receipt by the Purchase Contract Agent of a notice from a Holder of Corporate Units that such Holder has elected, in accordance with Section 5.02(a)(i) to effect a Cash Settlement and (2) the payment by such Holder of the Purchase Price in accordance with Section 5.02(a)(ii) above then the Collateral Agent shall:

(A) instruct the Securities Intermediary promptly to invest any such Cash in Permitted Investments consistent with the instructions of the Company as provided for below in this Section 5.02(a)(v);

(B) release from the Pledge the Senior Notes underlying the Applicable Ownership Interest in Senior Notes related to the Corporate Units as to which such Holder has effected a Cash Settlement; and

(C) instruct the Securities Intermediary to Transfer all such Senior Notes to the Purchase Contract Agent for distribution to such Holder, in each case free and clear of the Pledge created hereby, whereupon the Purchase Contract Agent shall Transfer such Senior Notes in accordance with written instructions provided by the Holder thereof or, if no such instructions are given to the Purchase Contract Agent by the Holder, the Purchase Contract Agent shall hold such Senior Notes, and any interest payment thereon, in the name of the Purchase Contract Agent or its nominee in trust for the benefit of such Holder until the expiration of the time period specified in the relevant abandoned property laws of the state where such Senior Notes and interest payments thereon, if any, are held.

43

---

The Company shall instruct the Collateral Agent in writing as to the type of Permitted Investments in which any such Cash shall be invested; *provided*, however, that if the Company fails to deliver such written instructions by 10:30 a.m. (New York City time) on the day such Cash is received by the Collateral Agent or to be reinvested by the Securities Intermediary, the Collateral Agent shall instruct the Securities Intermediary to invest such Cash in the Permitted Investments described in clause (6) of the definition of Permitted Investments. In no event shall the Collateral Agent or Securities Intermediary be liable for the selection of Permitted Investments or for investment losses incurred thereon. The Collateral Agent and Securities Intermediary shall have no liability in respect of losses incurred as a result of the failure of the Company to provide timely written investment direction.

Upon maturity of the Permitted Investments on the Purchase Contract Settlement Date, the Collateral Agent shall, and is hereby authorized to, (A) instruct the Securities Intermediary to remit to the Company on the Purchase Contract Settlement Date such portion of the proceeds of such Permitted Investments as is equal to the aggregate Purchase Price under all Purchase Contracts in respect of which Cash Settlement has been affected as provided in this Section 5.02 to the Company on the Purchase Contract Settlement Date, and (B) release any amounts in excess of such amount earned from such Permitted Investments to the Purchase Contract Agent for distribution to the Holders who have effected Cash Settlement pro-rata in proportion to the amount paid by such Holders under Section 5.02(a)(ii) above.

(b) *Remarketing.* (i) Unless a Special Event Redemption or a Termination Event has occurred prior to the Initial Remarketing Date, in order to dispose of the Senior Notes underlying Pledged Applicable Ownership Interests in Senior Notes of any Holders of Corporate Units who have not notified the Purchase Contract Agent of their intention to effect a Cash Settlement as provided in Section 5.02(a)(i) above, or who have so notified the Purchase Contract Agent but failed to make such payment as required by Section 5.02(a)(ii) above, the Company shall engage the Remarketing Agent pursuant to the Remarketing Agreement to sell such Senior Notes. The Purchase Contract Agent, based on the notices specified pursuant to Section 5.02(a)(iv), shall notify the Remarketing Agent, promptly after 5:00 p.m. (New York City time) on the sixth Business Day immediately preceding the Purchase Contract Settlement Date, of the aggregate principal amount of Senior Notes attributable to the Pledged Applicable Ownership Interests in Senior Notes that are to be remarketed. Concurrently, the Custodial Agent, based on the notices specified in clause (ii) below of this Section 5.02(b), will present for Remarketing the Separate Senior Notes to the Remarketing Agent.

(ii) Prior to 5:00 p.m. (New York City time) on the seventh Business Day immediately preceding the Purchase Contract Settlement Date, but no earlier than the Payment Date immediately preceding such date, holders of Separate Senior Notes may elect to have their Separate Senior Notes remarketed in all Remarketings under the Remarketing Agreement by delivering their Separate Senior Notes, along with a notice of such election, substantially in the form of Exhibit L attached hereto, to the Custodial Agent. After such time, such election shall become an irrevocable election to have such Separate Senior Notes remarketed in all Remarketings. The Custodial Agent shall hold the Separate

44

---

Senior Notes in an account separate from the Collateral Account in which the Senior Notes underlying the Pledged Applicable Ownership Interests in Senior Notes shall be held. Holders of Separate Senior Notes electing to have their Separate Senior Notes remarketed will also have the right to withdraw that election by written notice to the Custodial Agent, substantially in the form of Exhibit M hereto, on or prior to 5:00 p.m. (New York City time) on the seventh Business Day immediately preceding the Purchase Contract Settlement Date, and following such notice the Custodial Agent shall return such Separate Senior notes to such holder.

(iii) Upon receipt of notice from the Purchase Contract Agent as set forth in Section 5.02(b)(i) above and receipt of the Separate Senior Notes (if any) from the Custodial Agent, the Remarketing Agent shall, on the Initial Remarketing Date, use reasonable efforts to remarket such Senior Notes and such Separate Senior Notes at a price (the "**Remarketing Price**") based on the Reset Rate equal to 100% of the aggregate principal amount of such Senior Notes and such Separate Senior Notes being remarketed, as provided in the Remarketing Agreement, for settlement on the Purchase Contract Settlement Date. If, in spite of using its reasonable efforts, the Remarketing Agent cannot remarket such Senior Notes and such Separate Senior Notes at the Remarketing Price (other than to the Company) for any reason, or the remarketing has not occurred because a condition precedent to the remarketing has not been fulfilled (in each case, a "**Failed Remarketing**") on the Initial Remarketing Date, the Remarketing Agent shall, on the Second Remarketing Date, use its reasonable efforts to remarket such Senior Notes and such Separate Senior Notes at the Remarketing Price for settlement on the Purchase Contract Settlement Date. If, in spite of the Remarketing Agent's reasonable efforts, a Failed Remarketing shall have occurred on the Second Remarketing Date, the Remarketing Agent shall, on the Final Remarketing Date, use reasonable efforts to remarket such Senior Notes and such Separate Senior Notes at the Remarketing Price for settlement on the Purchase Contract Settlement Date.

(iv) If the Remarketing Agent is able to remarket such Senior Notes and such Separate Senior Notes (if any) in any Remarketing (to parties other than the Company) in accordance with the Remarketing Agreement (a "**Successful Remarketing**"), the Collateral Agent shall:

(A) on the Purchase Contract Settlement Date, instruct the Securities Intermediary to Transfer the Senior Notes underlying Pledged Applicable Ownership Interests in Senior Notes to the Remarketing Agent upon confirmation of deposit by the Remarketing Agent of the Proceeds of such Remarketing attributable to such Senior Notes in the Collateral Account; and

(B) on the Purchase Contract Settlement Date, in consultation with the Purchase Contract Agent, instruct the Securities Intermediary to remit a portion of such Proceeds equal to the aggregate principal amount of such Senior Notes to satisfy in full the Obligations of Holders of Corporate Units to pay the Purchase Price for the shares of Common Stock under the related Purchase Contracts, less the amount of any accrued and unpaid

45

---

Contract Adjustment Payments payable to such Holders, and to remit the balance of such Proceeds, if any, to the Purchase Contract Agent for distribution to Holders.

On the Purchase Contract Settlement Date, the Company shall pay the Remarketing Fee to the Remarketing Agent in accordance with the Remarketing Agreement. With respect to the remarketed Separate Senior Notes, upon a Successful Remarketing, any proceeds of the Successful Remarketing attributable to the Separate Senior Notes



will be remitted to the Custodial Agent for payment on the Purchase Contract Settlement Date to the holders of Separate Senior Notes who submitted such Separate Senior Notes for remarketing pursuant hereto.

(v) Following a Failed Remarketing on the Final Remarketing Date (a “**Failed Final Remarketing**”), as of the Purchase Contract Settlement Date, each Holder of any Pledged Applicable Ownership Interests in Senior Notes, unless such Holder has delivered the Purchase Price to the Securities Intermediary for deposit in the Collateral Account prior to 5:00 p.m. (New York City time) on the second Business Day immediately preceding the Purchase Contract Settlement Date in lawful money of the United States by certified or cashiers check or wire transfer in immediately available funds payable to or upon the order of the Securities Intermediary, shall be deemed to have exercised such Holder’s Put Right with respect to the Senior Notes underlying such Pledged Applicable Ownership Interests in Senior Notes and to have elected to have a portion of the Proceeds of the Put Right set-off against such Holder’s obligation to pay the aggregate Purchase Price for the shares of Common Stock to be issued under the related Purchase Contracts in full satisfaction of such Holders’ obligations under such Purchase Contracts. Following such set-off, each such Holder’s obligations to pay the Purchase Price for the shares of Common Stock will be deemed to be satisfied in full, and the Collateral Agent shall cause the Securities Intermediary to release the Senior Notes underlying such Pledged Applicable Interests in Senior Notes from the Collateral Account and shall promptly transfer such Senior Notes to the Company. Thereafter, the Collateral Agent shall promptly remit the remaining portion of the Proceeds of the Holder’s exercise of the Put Right in excess of the aggregate Purchase Price for the shares of Common Stock to be issued under such Purchase Contracts to the Purchase Contract Agent for payment to the Holder of the Corporate Units to which such Applicable Ownership Interests in Senior Notes relate.

(vi) Not later than 20 Business Days prior to the Initial Remarketing Date, the Company shall request the Depository or its nominee to notify the Beneficial Owners or Depository Participants holding Units and Separate Senior Notes of the procedures to be followed in each Remarketing including, in the case of a Failed Final Remarketing, the procedures that must be followed by a holder of Separate Senior Notes if such Holder wishes to exercise its Put Right or by a Holder if such Holder elects not to exercise its Put Right.

(vii) The Company agrees to use its commercially reasonable efforts to ensure that, if required by applicable law, (x) a registration statement, including a

46

---

prospectus, under the Securities Act with regard to the full amount of the Senior Notes to be remarketed in each Remarketing in each case in a form that may be used by the Remarketing Agent in connection with such Remarketing shall be effective with the Securities and Exchange Commission and (y) to make available copies of such prospectus.

(viii) The Company shall issue a press release and cause a notice of any Failed Final Remarketing to be published on its website (with a copy of such notice to be provided to the Purchase Contract Agent) before 9:00 a.m. New York City time on the Business Day immediately following such Failed Final Remarketing.

(c) In the case of a Treasury Unit or a Corporate Unit (if Applicable Ownership Interests in the Treasury Portfolio have replaced the Applicable Ownership Interests in Senior Notes as a component of such Corporate Unit), upon the maturity of the Pledged Treasury Securities or the appropriate Pledged Applicable Ownership Interests in the Treasury Portfolio held by the Securities Intermediary on or prior to the Business Day immediately preceding the Purchase Contract Settlement Date, the principal amount of the Treasury Securities or the appropriate Pledged Applicable Ownership Interests in the Treasury Portfolio received by the Securities Intermediary shall be invested promptly in Permitted Investments. On the Purchase Contract Settlement Date, an amount equal to the Purchase Price for all related Purchase Contracts shall be remitted to the Company as payment of such Holder’s Obligations under such Purchase Contracts without receiving any instructions from the Holder. In the event the sum of the Proceeds from either the related Pledged Treasury Securities or the related Pledged Applicable Ownership Interests in the Treasury Portfolio and the Proceeds from such Permitted Investments is in excess of the aggregate Purchase Price, the Collateral Agent shall cause the Securities Intermediary to distribute such excess, when received by the Securities Intermediary, to the Purchase Contract Agent for the benefit of the Holder of the related Treasury Units or Corporate Units, as applicable.

(d) The obligations of the Holders to pay the Purchase Price are non-recourse obligations and, except to the extent satisfied by Early Settlement, Cash Merger Early Settlement or Cash Settlement or terminated upon a Termination Event, are payable solely out of the proceeds of any Collateral pledged to secure the obligations of the Holders, and in no event will Holders be liable for any deficiency between the proceeds of the disposition of Collateral and the Purchase Price.

(e) The Company shall not be obligated to issue any shares of Common Stock in respect of a Purchase Contract or deliver any certificates thereof to the Holder of the related Units unless the Company shall have received payment for the Common Stock to be purchased thereunder in the manner herein set forth.

Section 5.03. *Issuance of Shares of Common Stock.* Unless a Termination Event, an Early Settlement or a Cash Merger Early Settlement shall have occurred, subject to Section 5.04(b), on the Purchase Contract Settlement Date upon receipt of the aggregate Purchase Price payable on all Outstanding Units in accordance with Section 5.02 above, the Company shall issue and deposit with the Purchase Contract Agent, for the benefit of the Holders of the Outstanding Units, one or more certificates representing newly issued

47

---

shares of Common Stock registered in the name of the Purchase Contract Agent (or its nominee) as custodian for the Holders (such certificates for shares of Common Stock, together with any dividends or distributions for which a record date and payment date for such dividend or distribution has occurred after the Purchase Contract Settlement Date, being hereinafter referred to as the “**Purchase Contract Settlement Fund**”) to which the Holders are entitled hereunder.

Subject to the foregoing, upon surrender of a Certificate to the Purchase Contract Agent on or after the Purchase Contract Settlement Date, Early Settlement Date or Cash Merger Early Settlement Date, as the case may be, together with settlement instructions thereon duly completed and executed, the Holder of such Certificate shall be entitled to receive forthwith in exchange therefor a certificate representing that number of newly issued whole shares of Common Stock which such Holder is entitled to receive pursuant to the provisions of this Article 5 (after taking into account all Units then held by such Holder), together with cash in lieu of fractional shares as provided in Section 5.08 and any dividends or distributions with respect to such shares constituting part of the Purchase Contract Settlement Fund, but without any interest thereon, and the Certificate so surrendered shall forthwith be cancelled. Such shares shall be registered in the name of the Holder or the Holder’s designee as specified in the settlement instructions provided by the Holder to the Purchase Contract Agent. If any shares of Common Stock issued in respect of a Purchase Contract are to be registered in the name of a Person other than the Person in whose name the Certificate evidencing such Purchase Contract is registered (but excluding any Depository or nominee thereof), no such registration shall be made unless and until the Person requesting such registration has paid any transfer and other taxes (including any applicable stamp taxes) required by reason of such registration in a name other than that of the registered Holder of the Certificate evidencing such Purchase Contract or has established to the satisfaction of the Company that such tax either has been paid or is not payable.

Section 5.04. *Adjustment of each Fixed Settlement Rate.* (a) Adjustments for Dividends, Distributions, Stock Splits, Etc.

(i) In case the Company shall pay or make a dividend or other distribution on Common Stock in Common Stock, each Fixed Settlement Rate in effect at the close of business on the date fixed for the determination of shareholders entitled to receive such dividend or other distribution shall be increased by multiplying each Fixed Settlement Rate by a fraction of which:

(A) the numerator shall be the sum of the number of shares of Common Stock outstanding at the close of business on the date fixed for such determination and the total number of shares constituting such dividend or other distribution; and

(B) the denominator shall be the number of shares of Common Stock outstanding at the close of business on the date fixed for such determination,

48

---

such increase in each Fixed Settlement Rate to become effective immediately at the opening of business on the Business Day following the date fixed for such determination. For the purposes of this paragraph (i), the number of shares of Common Stock at any time outstanding shall not include shares held in the treasury of the Company but shall include any shares issuable in respect of any scrip certificates issued in lieu of fractions of shares of Common Stock. The Company agrees that it shall not pay any dividend or make any distribution on shares of Common Stock held in the treasury of the Company.

(ii) In case the Company shall issue rights, warrants or options, other than pursuant to any dividend reinvestment plans or share purchase plans, to all holders of its Common Stock entitling them, for a period expiring within 45 days after the record date for the determination of shareholders entitled to receive such rights, warrants or options, to subscribe for or purchase shares of Common Stock at a price per share less than the Current Market Price per share of Common Stock on the date of announcement of such issuance, each Fixed Settlement Rate in effect at the close of business on the date of such announcement shall be increased by multiplying such Fixed Settlement Rate by a fraction of which:

(A) the numerator shall be the number of shares of Common Stock outstanding at the close of business on the date of such announcement plus the number of shares of Common Stock so offered for subscription or purchase; and

(B) the denominator shall be the number of shares of Common Stock outstanding at the close of business on the date of such announcement plus the number of shares of Common Stock that the aggregate offering price of the total number of shares of Common Stock so offered for subscription or purchase in the manner described in this Section 5.04(a)(ii) would purchase at the Current Market Price on the date of such announcement,

such increase in each Fixed Settlement Rate to become effective immediately after the opening of business on the Business Day following the date of such announcement. The Company agrees that it shall notify the Purchase Contract Agent if any issuance of such rights, warrants or options is cancelled or not completed following the announcement thereof and each Fixed Settlement Rate shall thereupon immediately be readjusted to the Fixed Settlement Rate that would then be in effect if such issuance had not been declared. For the purposes of this clause (ii), the number of shares of Common Stock at any time outstanding shall not include shares held in the treasury of the Company but shall include any shares issuable in respect of any scrip certificates issued in lieu of fractions of shares of Common Stock. The Company agrees that it shall not issue any such rights, warrants or options in respect of shares of Common Stock held in the treasury of the Company.

(iii) In case outstanding shares of Common Stock shall be subdivided or split into a greater number of shares of Common Stock, each Fixed Settlement Rate

49

---

in effect at the close of business on the day preceding the day upon which such subdivision or split becomes effective shall be proportionately increased, and, conversely, in case outstanding shares of Common Stock shall each be combined into a smaller number of shares of Common Stock, each Fixed Settlement Rate in effect at the close of business on the day preceding the day upon which such combination becomes effective shall be proportionately decreased, such increase or decrease, as the case may be, to become effective immediately at the opening of business on the Business Day following the day upon which such subdivision, split or combination becomes effective.

(iv) (w) In case the Company shall, by dividend or otherwise, distribute to all holders of its Common Stock evidences of its indebtedness or assets (including shares of capital stock, securities, cash and property but excluding any rights, warrants or options referred to in Section 5.04(a)(ii) above, any dividend or distribution paid exclusively in cash and any dividend or distribution referred to in Section 5.04(a)(i) above) (any of the foregoing hereinafter in this Section 5.02(a)(iv) called the “**Distributed Property**”), each Fixed Settlement Rate in effect at the close of business on the date fixed for the determination of shareholders entitled to receive such distribution shall be adjusted by multiplying each Fixed Settlement Rate by a fraction of which:

(A) the numerator shall be such Current Market Price per share of Common Stock; and

(B) the denominator shall be the Current Market Price per share of Common Stock on the date fixed for such determination less the then fair market value of the portion of the assets or evidences of indebtedness so distributed applicable to one share of Common Stock (as determined by the Board of Directors, whose determination shall be conclusive and the basis for which shall be described in a Board Resolution),

such adjustment to each Fixed Settlement Rate to become effective at the opening of business on the Business Day following the date fixed for the determination of shareholders entitled to receive such distribution; *provided* that if the fair market value of the Distributed Property applicable to one share of Common Stock is equal to or greater than the Current Market Price on the date fixed for the determination of stockholders entitled to receive such distribution, in lieu of the foregoing adjustment, adequate provision shall be made so that each Holder shall have the right to receive upon settlement the amount of Distributed Property such Holder would have received had such Holder settled each Purchase Contract on the date fixed for such determination as if the Purchase Contract Settlement Date were such date fixed for such determination. In any case in which this Section 5.04(a)(iv) is applicable, Section 5.04(a)(ii) shall not be applicable. In the event that such dividend or distribution is not so paid or made, each Fixed Settlement Rate shall again be adjusted to be the Fixed Settlement Rate that would then be in effect if such dividend or distribution had not been declared.

50

---

(x) Notwithstanding the foregoing, if the Distributed Property distributed by the Company to all holders of its Common Stock consist of capital stock of, or similar equity interests in, a Subsidiary or other business unit of the Company, clause (w) above shall not apply and instead each Fixed Settlement Rate shall be increased so that each Fixed Settlement Rate shall be equal to the rate determined by multiplying each such rate in effect immediately prior to the close of business on the record date with respect to such distribution by a fraction of which,

(A) the numerator shall be the sum of (A) the average of the Closing Prices of the Common Stock for the ten (10) consecutive Trading Days commencing on and including the fifth Trading Day after the date on which “ex-dividend trading” commences for such dividend or distribution on the New York Stock Exchange, the Nasdaq National Market or such other national or regional exchange or market on which such securities are then listed or quoted (the “**Ex-Dividend Date**”) plus (B) the average Closing Prices of the securities distributed in respect of each share of Common Stock for the ten (10) consecutive Trading Days commencing on and including the fifth Trading Day after the Ex-Dividend Date; and

(B) the denominator shall be the average of the Closing Prices of the Common Stock for the ten (10) consecutive Trading Days commencing on and including the fifth Trading Day after the Ex-Dividend Date,

such adjustment to each Fixed Settlement Rate to become effective immediately prior to the opening of business on the Business Day following the record date with respect to such distribution. In any case in which this paragraph (x) is applicable, Section 5.02(a)(i), Section 5.02(a)(ii) and paragraph (w) of this Section 5.02(a)(iv) shall not be applicable.

(y) Notwithstanding anything to the contrary contained in this Section 5.02(a), rights or warrants distributed by the Company to all holders of Common Stock entitling the holders thereof to subscribe for or purchase shares of the Company's capital stock (either initially or under certain circumstances), which rights, options or warrants, until the occurrence of a specified event or events ("**Trigger Event**") (i) are deemed to be transferred with such shares of Common Stock; (ii) are not exercisable; and (iii) are also issued in respect of future issuances of Common Stock, shall be deemed not to have been distributed for purposes of this Section 5.04(a) (and no adjustment to each Fixed Settlement Rate under this Section 5.04(a) will be required) until the occurrence of the earliest Trigger Event, whereupon such rights, options and warrants shall be deemed to have been distributed and an appropriate adjustment (if any is required) to each Fixed Settlement Rate shall be made under this Section 5.02(a)(iv). In addition, in the event of any distribution of rights, options or warrants, or any Trigger Event with respect thereto that was counted for purposes of calculating a distribution amount for which an adjustment to each Fixed Settlement Rate under this Section 5.04(a) was made, (1) in the case of any such rights, options or warrants that shall all have been redeemed or repurchased without exercise by any holders thereof, each Fixed

51

Settlement Rate shall be readjusted upon such final redemption or repurchase to give effect to such distribution or Trigger Event, as the case may be, as though it were a cash distribution, equal to the per share redemption or repurchase price received by a holder or holders of Common Stock with respect to such rights, options or warrants (assuming such holder had retained such rights, options or warrants), made to all holders of Common Stock as of the date of such redemption or repurchase, and (2) in the case of such rights, options or warrants that shall have expired or been terminated without exercise by any holders thereof, each Fixed Settlement Rate shall be readjusted as if such rights, options and warrants had not been issued.

(z) For purposes of this Section 5.02(a)(iv) and Section 5.02(a)(i) and Section 5.02(a)(ii), any dividend or distribution to which this Section 5.02(a)(iv) is applicable that also includes shares of Common Stock, or rights, options or warrants to subscribe for or purchase shares of Common Stock (or both), shall be deemed instead to be (1) a dividend or distribution of the evidences of indebtedness, assets or shares of capital stock other than such shares of Common Stock or rights, options or warrants (and any Settlement Rate adjustment required by this Section 5.02(a)(iv) with respect to such dividend or distribution shall then be made) immediately followed by (2) a dividend or distribution of such shares of Common Stock or such rights, options or warrants (and any further Settlement Rate adjustment required by Section 5.02(a)(i) and Section 5.02(a)(ii) with respect to such dividend or distribution shall then be made), except (A) the record date of such dividend or distribution shall be deemed to be "the date fixed for the determination of shareholders entitled to receive such dividend or other distribution", "the date fixed for the determination of shareholders entitled to receive such rights, options or warrants" and "the date fixed for such determination" within the meaning of Section 5.02(a)(i) and Section 5.02(a)(ii) and (B) any shares of Common Stock included in such dividend or distribution shall not be deemed "outstanding at the close of business on the date fixed for the determination of shareholders entitled to receive such dividend or other distribution" or "outstanding at the close of business on the date fixed for such determination" within the meaning of Section 5.02(a)(i).

(v) In case the Company shall make any dividend or distribution consisting exclusively of cash to all holders of outstanding shares of Common Stock (excluding (I) any dividend or distribution in connection with the liquidation, dissolution or termination of the Company, or (II) any cash dividend on Common Stock to the extent that the aggregate cash dividend per share of Common Stock in any fiscal quarter does not exceed \$[\*] (the "**Dividend Threshold Amount**"), then each Fixed Settlement Rate will be adjusted by multiplying each Fixed Settlement Rate in effect immediately prior to the close of business on the record date with respect to such dividend or distribution by a fraction of which,

(A) the numerator is the Current Market Price on the date fixed for the determination of stockholders entitled to receive such distribution, minus the Dividend Threshold Amount; and

52

(B) the denominator is such Current Market Price, minus the amount per share of such dividend or distribution,

such adjustment to each Fixed Settlement Rate to be effective immediately prior to the opening of business on the Business Day following the date fixed for the determination of stockholders entitled to receive such distribution; *provided* that if an adjustment is required to be made under this clause as a result of a distribution that is not a regular quarterly dividend, the Dividend Threshold Amount will be deemed to be zero; and *provided further* that if the portion of the cash so distributed applicable to one share of Common Stock is equal to or greater than the Current Market Price on the date fixed for the determination of stockholders entitled to receive such distribution, in lieu of the foregoing adjustment, adequate provision shall be made so that each Holder shall have the right to receive upon settlement the amount of cash such Holder would have received had such Holder settled each Purchase Contract on the date fixed for such determination as if the Purchase Contract Settlement Date were such date fixed for such determination. The Dividend Threshold Amount is subject to adjustment from time to time in a manner inversely proportional to any adjustment made to each Fixed Settlement Rate under this Section 5.02.

(vi) In case a tender or exchange offer made by the Company or any subsidiary of the Company for all or any portion of the Common Stock shall expire and such tender or exchange offer (as amended upon the expiration thereof) shall require the payment to stockholders of consideration per share of Common Stock having a fair market value (as determined by the Board of Directors, whose determination shall be conclusive and described in a resolution of the Board of Directors) that as of the last time at which tenders or exchanges may be made pursuant to such tender or exchange offer (as it may be amended) (the "**Expiration Time**") exceeds the Closing Price of a share of Common Stock on the Trading Day next succeeding the Expiration Time, each Fixed Settlement Rate shall be increased so that the same shall equal the rate determined by multiplying each Fixed Settlement Rate in effect immediately prior to the Expiration Time by a fraction of which,

(A) the numerator shall be equal to the sum of (1) the fair market value, as determined by the Board of Directors (as described above in this Section 5.04(a)(vi)), of the aggregate consideration payable for all shares of Common Stock that the Company or a subsidiary of the Company, as the case may be, purchased in such tender or exchange offer (the "**Purchased Shares**") and (2) the product of the number of shares of Common Stock outstanding, less any Purchased Shares, and the Closing Price of the Common Stock on the Trading Day next succeeding the Expiration Time, and

(B) the denominator shall be equal to the product of the number of shares of Common Stock outstanding, including the Purchased Shares, and the Closing Price of the Common Stock on the Trading Day next succeeding the Expiration Time,

53

such adjustment to each Fixed Settlement Rate to become effective immediately prior to the opening of business on the Business Day following the Expiration Time. If the Company is obligated to purchase shares pursuant to any such tender or exchange offer, but the Company is permanently prevented by applicable law from effecting any such purchases or all such purchases are rescinded, each Fixed Settlement Rate shall again be adjusted to be the Fixed Settlement Rate that would then be in effect if such tender or exchange offer had not been made.

(vii) The reclassification of Common Stock into securities including securities other than Common Stock (other than any reclassification upon a

Reorganization Event to which Section 5.04(b) applies) shall be deemed to involve:

(A) a distribution of such securities other than Common Stock to all holders of Common Stock (and the effective date of such reclassification shall be deemed to be “the date fixed for the determination of shareholders entitled to receive such distribution” and the “date fixed for such determination” within the meaning of paragraph (iv) of this Section); and

(B) a subdivision, split or combination, as the case may be, of the number of shares of Common Stock outstanding immediately prior to such reclassification into the number of shares of Common Stock outstanding immediately thereafter (and the effective date of such reclassification shall be deemed to be “the day upon which such subdivision or split becomes effective” or “the day upon which such combination becomes effective”, as the case may be, and “the day upon which such subdivision, split or combination becomes effective” within the meaning of this Section 5.04(a)(iii).

(viii) [Reserved.]

(ix) All adjustments to each Fixed Settlement Rate shall be calculated to the nearest 1/10,000th of a share of Common Stock (or if there is not a nearest 1/10,000th of a share, to the next lower 1/10,000th of a share). If any adjustments are made to each Fixed Settlement Rate pursuant to this Section 5.04(a), an adjustment shall also be made to the Applicable Market Value solely to determine which of clauses (i), (ii) or (iii) of the definition of Settlement Rate in Section 5.01(a) will apply on the Purchase Contract Settlement Date or any Cash Merger Early Settlement Date. Such adjustment shall be made by multiplying the Applicable Market Value by the Adjustment Factor. The “Adjustment Factor” means, initially, a fraction the numerator of which shall be the Maximum Settlement Rate immediately after the first adjustment to each Fixed Settlement Rate pursuant to this Section 5.04(a) and the denominator of which shall be the Maximum Settlement Rate immediately prior to such adjustment. Each time an adjustment is required to be made to each Fixed Settlement Rate pursuant to this Section 5.04(a), the Adjustment Factor shall be multiplied by a fraction the numerator of which shall be the Maximum Settlement Rate immediately after such adjustment to each Fixed Settlement Rate pursuant to this Section 5.04(a) and the

54

denominator of which shall be the Maximum Settlement Rate immediately prior to such adjustment. Notwithstanding the foregoing, if any adjustment to each Fixed Settlement Rate is required to be made pursuant to the occurrence of any of the events contemplated by this Section 5.04(a) during the period taken into consideration for determining the Applicable Market Value, the 20 individual Closing Prices used to determine the Applicable Market Value shall be adjusted rather than the Applicable Market Value and the Applicable Market Value shall be determined by (A) multiplying the Closing Prices for Trading Days prior to such adjustment to each Fixed Settlement Rate by the Adjustment Factor in effect prior to such adjustment, (B) multiplying the Closing Prices for Trading Days following such adjustment by the Adjustment Factor reflecting such adjustment, and (C) dividing the sum of all such adjusted Closing Prices by 20.

(x) The Company may, but shall not be required to, make such increases in each Fixed Settlement Rate, in addition to those required by this Section 5.04(a), as the Board of Directors considers to be advisable. The Company may make such a discretionary adjustment only if it makes the same proportionate adjustment to each Fixed Settlement Rate.

(xi) If the Company hereafter adopts any stockholder rights plan involving the issuance of preference share purchase rights or other similar rights (the “Rights”) to all holders of the Common Stock, a Holder shall be entitled to receive upon settlement of any Purchase Contract, in addition to the shares of Common Stock issuable upon settlement of such Purchase Contract, the related Rights for the Common Stock, unless such Rights under the future stockholder rights plan have separated from the Common Stock at the time of conversion, in which case each Fixed Settlement Rate shall be adjusted as provided in Section 5.04(a)(iv) on the date such Rights separate from the Common Stock.

(b) Adjustment for Consolidation, Merger or Other Reorganization Event.

(i) In the event of:

(A) any consolidation or merger of the Company with or into another Person (other than a merger or consolidation in which the Company is the continuing corporation and in which the shares of Common Stock outstanding immediately prior to the merger or consolidation are not exchanged for cash, securities or other property of the Company or another corporation);

(B) any sale, transfer, lease or conveyance to another Person of the property of the Company as an entirety or substantially as an entirety;

(C) any statutory share exchange of the Company with another Person (other than in connection with a merger or acquisition); or

(D) any liquidation, dissolution or termination of the Company other than as a result of or after the occurrence of a Termination Event (any

55

event described in clauses (A), (B), (C) and (D), a “Reorganization Event”),

each Holder will receive, in lieu of shares of Common Stock, on the Purchase Contract Settlement Date or any Early Settlement Date with respect to each Purchase Contract forming a part thereof, the kind and amount of securities, cash and other property receivable upon such Reorganization Event (without any interest thereon, and without any right to dividends or distribution thereon if such dividends or distributions have a record date that is prior to the Purchase Contract Settlement Date) by a Holder of one share of Common Stock (the “Exchange Property”), multiplied by the applicable Settlement Rate. The kind and amount of Exchange Property will be determined assuming such holder of one Share of Common Stock is not a Person with which the Company consolidated or into which the Company merged or which merged into the Company or to which such sale or transfer was made, as the case may be (any such Person, a “Constituent Person”), or an Affiliate of a Constituent Person to the extent such Reorganization Event provides for different treatment of Common Stock held by Affiliates of the Company and non-affiliates and such Holder failed to exercise its rights of election, if any, as to the kind or amount of securities, cash and other property receivable upon such Reorganization Event (provided that if the kind or amount of securities, cash and other property receivable upon such Reorganization Event is not the same for each share of Common Stock held immediately prior to such Reorganization Event by a Person other than a Constituent Person or an Affiliate thereof and in respect of which rights of election shall not have been exercised (“non-electing share”), then for the purpose of this Section 5.04(b)(i) the kind and amount of securities, cash and other property receivable upon such Reorganization Event shall be deemed to be the kind and amount so receivable per share by a plurality of the non-electing shares).

For purposes of determining the applicable Settlement Rate under this Section 5.04(b)(i) and Section 5.04(b)(ii), the term “Applicable Market Value” shall be deemed to refer to the “Applicable Market Value” of the Exchange Property, and such value shall be determined (A) with respect to any publicly traded securities that compose all or part of the Exchange Property, based on the Closing Price of such securities, (B) in the case of any cash that composes all or part of the Exchange Property, based on the amount of such cash and (C) in the case of any other property that composes all or part of the Exchange Property, based on the value of such property, as determined by a nationally recognized independent investment banking firm retained by the Company for this purpose; *provided* that prior to the separation of the Rights or any similar stockholder rights from the Common Stock, such Rights or similar stockholder rights shall be deemed to have no value. For the purposes of this paragraph only, the term “Closing Price” shall be deemed to refer to the closing sale price, last quoted bid price or mid-point of the last bid and ask prices, as the case may be, of any publicly traded securities that comprise all or part of the Exchange Property and the term “Trading Day” shall be deemed to refer to any publicly traded securities that comprise all or

In the event of such a Reorganization Event, the Person formed by such consolidation, merger or exchange or the Person that acquires the assets of the Company or, in the event of a liquidation, dissolution or termination of the Company, the Company or a liquidating trust created in connection therewith, shall execute and deliver to the

Purchase Contract Agent an agreement supplemental hereto providing that each Holder of an Outstanding Unit shall have the rights provided by this Section 5.04(b)(i). Such supplemental agreement shall provide for adjustments which, for events subsequent to the effective date of such supplemental agreement, shall be, in the sole judgment of the parties executing such agreement, as nearly equivalent as may be practicable to the adjustments provided for in this Section 5.04. The above provisions of this Section 5.04 shall similarly apply to successive Reorganization Events.

(ii) In the event of a consolidation or merger of the Company with or into another Person, or any merger of another Person into the Company (other than a merger that does not result in any reclassification, conversion, exchange or cancellation of outstanding shares of Common Stock), in each case in which 30% or more of the total consideration paid to the Company's shareholders consists of cash or cash equivalents (a "**Cash Merger**"), then a Holder of a Unit may settle ("**Cash Merger Early Settlement**") its Purchase Contract, upon the conditions set forth below, at the Settlement Rate in effect immediately prior to the closing of the Cash Merger; *provided* that no Cash Merger Early Settlement will be permitted pursuant to this Section 5.04(b)(ii) unless, at the time such Cash Merger Early Settlement is effected, there is an effective Registration Statement with respect to any securities to be issued and delivered in connection with such Cash Merger Early Settlement, if such a Registration Statement is required (in the view of counsel, which need not be in the form of a written opinion, for the Company) under the Securities Act. If such a Registration Statement is so required, the Company covenants and agrees to use its commercially reasonable efforts to (x) have in effect a Registration Statement covering any securities to be delivered in respect of the Purchase Contracts being settled and (y) provide a Prospectus in connection therewith, in each case in a form that may be used in connection with such Cash Merger Early Settlement. If a Holder elects a Cash Merger Early Settlement of some or all of its Purchase Contracts, such Holder shall be entitled to receive, on the Cash Merger Early Settlement Date, the aggregate amount of any accrued and unpaid Contract Adjustment Payments, with respect to such Purchase Contracts. The Company shall pay such amount as a credit against the amount otherwise payable by such Holder to effect such Cash Merger Early Settlement.

Within five Business Days of the completion of a Cash Merger, the Company shall provide written notice to Holders of such completion of a Cash Merger, which shall specify the deadline for submitting the notice to settle early in cash pursuant to this Section 5.04(b)(ii), the date on which such Cash Merger Early Settlement shall occur (which date shall be at least five days after the date of such written notice by the Company, but which shall in no event be later than the earlier of 20 days after the date of such written notice by the Company and the fifth Business Day immediately preceding the Purchase Contract Settlement Date) (the "**Cash Merger Early Settlement Date**"), the applicable Settlement Rate and the amount (per share of Common Stock) of cash, securities and other consideration receivable by the Holder, including the amount of Contract Adjustment Payments receivable, upon settlement.

Corporate Units Holders (unless Applicable Ownership Interests in the Treasury Portfolio have replaced Applicable Ownership Interests in Senior Notes as a component of the Corporate Units) and Treasury Units Holders may only effect Cash Merger Early Settlement pursuant to this Section 5.04(b)(ii) in integral multiples of 40 Corporate Units or Treasury Units, as the case may be. If Applicable Ownership Interests in the Treasury Portfolio have replaced Applicable Ownership Interests in Senior Notes as a component of the Corporate Units, Corporate Units Holders may only effect Cash Merger Early Settlement pursuant to this Section 5.04(b)(ii) in multiples of [•] Corporate Units. Other than the provisions relating to timing of notice and settlement, which shall be as set forth in the immediately preceding paragraph, the provisions of Section 5.01 shall apply with respect to a Cash Merger Early Settlement pursuant to this Section 5.04(b)(ii).

In order to exercise the right to effect Cash Merger Early Settlement with respect to any Purchase Contracts, the Holder of the Certificate evidencing Units shall deliver, no later than 5:00 p.m. (New York City time) on the third Business Day immediately preceding the Cash Merger Early Settlement Date, such Certificate to the Purchase Contract Agent at the Corporate Trust Office duly endorsed for transfer to the Company or in blank with the form of Election to Settle Early on the reverse thereof duly completed and accompanied by payment (payable to the Company in immediately available funds) in an amount equal to the result of:

(i) the product of (A) the Stated Amount times (B) the number of Purchase Contracts with respect to which the Holder has elected to effect Cash Merger Early Settlement, less

(ii) the amount of any accrued and unpaid Contract Adjustment Payments (except when the Cash Merger Early Settlement Date falls after any Record Date and prior to the next succeeding Payment Date).

Upon receipt of such Certificate and payment of such funds, the Purchase Contract Agent shall pay the Company from such funds the related Purchase Price pursuant to the terms of the related Purchase Contracts, and notify the Collateral Agent that all the conditions necessary for a Cash Merger Early Settlement by a Holder have been satisfied pursuant to which the Purchase Contract Agent has received from such Holder, and paid to the Company as confirmed in writing by the Company, the related Purchase Price.

Upon receipt by the Collateral Agent of the notice from the Purchase Contract Agent set forth in the immediately preceding paragraph, the Collateral Agent shall release from the Pledge, (1) the Senior Notes underlying the Pledged Applicable Ownership Interests in Senior Notes or the Pledged Applicable Ownership Interests in the Treasury Portfolio, in the case of a Holder of Corporate Units or (2) the Pledged Treasury Securities, in the case of a Holder of Treasury Units, in each case with a Value equal to the product of (x) the Stated Amount and (y) the number of Purchase Contracts as to which such Holder has elected to effect Cash Merger Early Settlement, and shall instruct the Securities Intermediary to Transfer all such Pledged Applicable Ownership Interests in the Treasury Portfolio

or Senior Notes underlying Pledged Applicable Ownership Interests in Senior Notes or Pledged Treasury Securities, as the case may be, to the Purchase Contract Agent for distribution to such Holder, in each case free and clear of the Pledge created hereby.

If a Holder properly effects an effective Cash Merger Early Settlement in accordance with the provisions of this Section 5.04(b)(ii), the Company will deliver (or will cause the Collateral Agent to deliver) to the Holder on the Cash Merger Early Settlement Date:

(A) the kind and amount of securities, cash and other property receivable upon such Cash Merger by a Holder of the number of shares of Common Stock issuable on account of each Purchase Contract if the Purchase Contract Settlement Date had occurred immediately prior to such Cash Merger (based on the Settlement Rate in effect at such time), assuming such Holder of Common Stock is not a Constituent Person or an Affiliate of a Constituent Person to the extent such Cash Merger provides for different treatment of Common Stock held by Affiliates of the Company and non-affiliates and such Holder failed to exercise its rights of election, if any, as to the kind or amount of securities, cash and other property receivable upon such Cash Merger (provided that if the kind or amount of securities, cash and other property receivable upon such Cash Merger is not the same for each non-electing share, then for the purpose of this Section 5.04(b)(ii), the kind and amount of securities, cash and other property receivable upon such Cash Merger by each non-electing

share shall be deemed to be the kind and amount so receivable per share by a plurality of the non-electing shares). For the avoidance of doubt, for the purposes of determining the Applicable Market Value (in connection with determining the appropriate Settlement Rate to be applied in the foregoing sentence), the date of the closing of the Cash Merger shall be deemed to be the Purchase Contract Settlement Date;

(B) the Senior Notes, the Applicable Ownership Interests in the Treasury Portfolio or Treasury Securities, as the case may be, related to the Purchase Contracts with respect to which the Holder is effecting a Cash Merger Early Settlement; and

(C) if so required under the Securities Act, a Prospectus as contemplated by this Section 5.04(b)(ii).

The Corporate Units or the Treasury Units of the Holders who do not elect Cash Merger Early Settlement in accordance with the foregoing will continue to remain outstanding and be subject to settlement on the Purchase Contract Settlement Date in accordance with the terms hereof.

(c) All calculations and determinations pursuant to this Section 5.04 shall be made by the Company or its agent and the Purchase Contract Agent shall have no responsibility with respect to this Agreement.

59

---

Section 5.05. *Notice of Adjustments and Certain Other Events.* (a) Whenever the Fixed Settlement Rates are adjusted as herein provided, the Company shall within 10 Business Days following the occurrence of an event that requires an adjustment to each Fixed Settlement Rate pursuant to Section 5.04 (or if the Company is not aware of such occurrence, as soon as practicable after becoming so aware):

(i) compute each adjusted Fixed Settlement Rate in accordance with Section 5.04 and prepare and transmit to the Purchase Contract Agent an Officers' Certificate setting forth each Fixed Settlement Rate, the method of calculation thereof in reasonable detail, and the facts requiring such adjustment and upon which such adjustment is based; and

(ii) provide a written notice to the Holders of the Units of the occurrence of such event and a statement in reasonable detail setting forth the method by which the adjustment to each Fixed Settlement Rate was determined and setting forth each adjusted Fixed Settlement Rate.

(b) The Purchase Contract Agent shall not at any time be under any duty or responsibility to any Holder to determine whether any facts exist which may require any adjustment of each Fixed Settlement Rate, or with respect to the nature or extent or calculation of any such adjustment when made, or with respect to the method employed in making the same. The Purchase Contract Agent shall be fully authorized and protected in relying on any Officers' Certificate delivered pursuant to Section 5.05(a)(i) and any adjustment contained therein and the Purchase Contract Agent shall not be deemed to have knowledge of any adjustment unless and until it has received such certificate. The Purchase Contract Agent shall not be accountable with respect to the validity or value (or the kind or amount) of any shares of Common Stock, or of any securities or property, which may at the time be issued or delivered with respect to any Purchase Contract; and the Purchase Contract Agent makes no representation with respect thereto. The Purchase Contract Agent shall not be responsible for any failure of the Company to issue, transfer or deliver any shares of Common Stock pursuant to a Purchase Contract or to comply with any of the duties, responsibilities or covenants of the Company contained in this Article 5.

Section 5.06. *Termination Event; Notice.*

The Purchase Contracts and all obligations and rights of the Company and the Holders thereunder, including, without limitation, the rights of the Holders to receive and the obligation of the Company to pay any Contract Adjustment Payments (including any accrued and unpaid Contract Adjustment Payments), and the rights and obligations of Holders to purchase Common Stock, shall immediately and automatically terminate, without the necessity of any notice or action by any Holder, the Purchase Contract Agent or the Company, if, prior to or on the Purchase Contract Settlement Date, a Termination Event shall have occurred.

Upon and after the occurrence of a Termination Event, the Units shall thereafter represent the right to receive the Senior Notes underlying the Applicable Ownership Interests in Senior Notes, the Treasury Securities or the Applicable Ownership Interests in the Treasury Portfolio, as the case may be, forming part of such Units, in accordance with

60

---

the provisions of Section 3.15 hereof. Upon the occurrence of a Termination Event, the Company shall promptly but in no event later than two Business Days thereafter give written notice to the Purchase Contract Agent, the Collateral Agent and the Holders, at their addresses as they appear in the Security Register.

Section 5.07. *Early Settlement.* (a) Subject to and upon compliance with the provisions of this Section 5.07, at the option of the Holder thereof, Purchase Contracts underlying Units may be settled early ("**Early Settlement**") at any time after [:], 2005 but prior to 5:00 p.m. (New York City time) on the seventh Business Day immediately preceding the Purchase Contract Settlement Date (in the case of Corporate Units, unless a Special Event Redemption has occurred) or the second Business Day immediately preceding the Purchase Contract Settlement Date (in the case of Treasury Units or Corporate Units after the occurrence of a Special Event Redemption); *provided* that no Early Settlement will be permitted pursuant to this Section 5.07 unless, at the time such Early Settlement is effected, there is an effective Registration Statement with respect to any securities to be issued and delivered in connection with such Early Settlement, if such a Registration Statement is required (in the view of counsel, which need not be in the form of a written opinion, for the Company) under the Securities Act. If such a Registration Statement is so required, the Company covenants and agrees to use its commercially reasonable best efforts to (i) have in effect a Registration Statement covering any securities to be delivered in respect of the Purchase Contracts being settled and (ii) provide a Prospectus in connection therewith, in each case in a form that may be used in connection with such Early Settlement (it being understood that if there is a material business transaction or development that has not yet been publicly disclosed, the Company will not be required to provide such a Prospectus, and the right to effect Early Settlement will not be available, until the Company has publicly disclosed such transaction or development, provided that the Company will use its commercially reasonable efforts to make such disclosure as soon as it is commercially reasonable to do so).

(b) In order to exercise the right to effect Early Settlement with respect to any Purchase Contracts, the Holder of the Certificate evidencing Units (in the case of Certificates in definitive certificated form) shall deliver, at any time prior to 5:00 p.m. (New York City time) on the seventh Business Day immediately preceding the Purchase Contract Settlement Date (in the case of Corporate Units, unless a Special Event Redemption has occurred) or the second Business Day immediately preceding the Purchase Contract Settlement Date (in the case of Treasury Units or Corporate Units after the occurrence of a Special Event Redemption), such Certificate to the Purchase Contract Agent at the Corporate Trust Office duly endorsed for transfer to the Company or in blank with the form of Election to Settle Early on the reverse thereof duly completed and accompanied by payment (payable to the Company in immediately available funds) in an amount (the "**Early Settlement Amount**") equal to the sum of:

(i) the product of (A) the Stated Amount and (B) the number of Purchase Contracts with respect to which the Holder has elected to effect Early Settlement, plus,

(ii) if such delivery is made with respect to any Purchase Contracts during the period from the close of business on any Record Date next preceding

61

any Payment Date to the opening of business on such Payment Date, an amount equal to the Contract Adjustment Payments payable on such Payment Date with respect to such Purchase Contracts.

In the case of Book-Entry Interests, each Beneficial Owner electing Early Settlement must deliver the Early Settlement Amount to the Purchase Contract Agent along with a facsimile of the Election to Settle Early form duly completed, make book-entry transfer of such Book-Entry Interests and comply with the applicable procedures of the Depository.

Except as provided in Section 5.10(d), no payment shall be made upon Early Settlement of any Purchase Contract on account of any Contract Adjustment Payments accrued on such Purchase Contract or on account of any dividends on the Common Stock issued upon such Early Settlement. If the foregoing requirements are first satisfied with respect to Purchase Contracts underlying any Units at or prior to 5:00 p.m. (New York City time) on a Business Day, such day shall be the “**Early Settlement Date**” with respect to such Units and if such requirements are first satisfied after 5:00 p.m. (New York City time) on a Business Day or on a day that is not a Business Day, the Early Settlement Date with respect to such Units shall be the next succeeding Business Day.

Upon the receipt of such Certificate and Early Settlement Amount from the Holder, the Purchase Contract Agent shall pay to the Company such Early Settlement Amount, the receipt of which payment the Company shall confirm in writing. The Purchase Contract Agent shall then notify the Collateral Agent that (A) such Holder has elected to effect an Early Settlement, which notice shall set forth the number of such Purchase Contracts as to which such Holder has elected to effect Early Settlement, (B) the Purchase Contract Agent has received from such Holder, and paid to the Company as confirmed in writing by the Company, the related Early Settlement Amount and (C) all conditions to such Early Settlement have been satisfied.

Upon receipt by the Collateral Agent of the notice from the Purchase Contract Agent set forth in the preceding paragraph, the Collateral Agent shall release from the Pledge, (1) in the case of a Holder of Corporate Units, the Senior Notes underlying the Pledged Applicable Ownership Interest in Senior Notes, or the Pledged Applicable Ownership Interests in the Treasury Portfolio, as the case may be, relating to the Purchase Contracts to which Early Settlement is effected, or (2) in the case of a Holder of Treasury Units, Pledged Treasury Securities, in each case with a Value equal to the product of (x) the Stated Amount times (y) the number of Purchase Contracts as to which such Holder has elected to effect Early Settlement, and shall instruct the Securities Intermediary to Transfer all such Pledged Applicable Ownership Interests in the Treasury Portfolio or Senior Notes underlying such Pledged Applicable Ownership Interests in Senior Notes or Pledged Treasury Securities, as the case may be, to the Purchase Contract Agent for distribution to such Holder, in each case free and clear of the Pledge created hereby.

Holders of Corporate Units and Treasury Units may only effect Early Settlement pursuant to this Section 5.07 in integral multiples of 40 Treasury Units. If Applicable Ownership Interests in the Treasury Portfolio have replaced Applicable Ownership Interests in Senior Notes as a component of the Corporate Units, Corporate Units Holders

62

---

may only effect Early Settlement pursuant to this Section 5.07 in integral multiples of [\*] Corporate Units.

Upon Early Settlement of the Purchase Contracts, the rights of the Holders to receive and the obligation of the Company to pay any Contract Adjustment Payments (including any accrued and unpaid Contract Adjustment Payments) with respect to such Purchase Contracts shall immediately and automatically terminate, except as provided in Section 5.10(d).

(c) Upon Early Settlement of Purchase Contracts by a Holder of the related Units, the Company shall issue, and the Holder shall be entitled to receive, a number of shares of Common Stock (or in the case of an Early Settlement following a Reorganization Event, a number of units of Exchange Property) equal to the Minimum Settlement Rate for each Purchase Contract as to which Early Settlement is effected.

(d) No later than the third Business Day after the applicable Early Settlement Date, the Company shall cause the shares of Common Stock issuable upon Early Settlement of Purchase Contracts to be issued and delivered, together with payment in lieu of any fraction of a share, as provided in Section 5.08.

(e) Upon Early Settlement of any Purchase Contracts, and subject to receipt of shares of Common Stock from the Company and the Senior Notes, the Applicable Ownership Interests in the Treasury Portfolio or Treasury Securities, as the case may be, from the Securities Intermediary, as applicable, the Purchase Contract Agent shall, in accordance with the instructions provided by the Holder thereof on the applicable form of Election to Settle Early on the reverse of the Certificate evidencing the related Units:

(i) transfer to the Holder the Senior Notes, the Applicable Ownership Interests in the Treasury Portfolio or Treasury Securities, as the case may be, related to such Units,

(ii) deliver to the Holder a certificate or certificates for the full number of shares of Common Stock issuable upon such Early Settlement, together with payment in lieu of any fraction of a share, as provided in Section 5.08, and

(iii) if so required under the Securities Act, deliver a Prospectus for the shares of Common Stock issuable upon such Early Settlement as contemplated by Section 5.07(a).

(f) In the event that Early Settlement is effected with respect to Purchase Contracts underlying less than all the Units evidenced by a Certificate, upon such Early Settlement the Company shall execute and the Purchase Contract Agent shall execute on behalf of the Holder, authenticate and deliver to the Holder thereof, at the expense of the Company, a Certificate evidencing the Units as to which Early Settlement was not effected.

Section 5.08. *No Fractional Shares.* No fractional shares or scrip representing fractional shares of Common Stock shall be issued or delivered upon settlement on the

63

---

Purchase Contract Settlement Date, or upon Early Settlement or Cash Merger Early Settlement of any Purchase Contracts. If Certificates evidencing more than one Purchase Contract shall be surrendered for settlement at one time by the same Holder, the number of full shares of Common Stock which shall be delivered upon settlement shall be computed on the basis of the aggregate number of Purchase Contracts evidenced by the Certificates so surrendered. Instead of any fractional share of Common Stock which would otherwise be deliverable upon settlement of any Purchase Contracts on the Purchase Contract Settlement Date, or upon Early Settlement or Cash Merger Early Settlement, the Company, through the Purchase Contract Agent, shall make a cash payment in respect of such fractional interest in an amount equal to the percentage of such fractional share multiplied by the Applicable Market Value calculated as if the date of such settlement were the Purchase Contract Settlement Date. The Company shall provide the Purchase Contract Agent from time to time with sufficient funds to permit the Purchase Contract Agent to make all cash payments required by this Section 5.08 in a timely manner.

Section 5.09. *Charges and Taxes.* The Company will pay all stock transfer and similar taxes attributable to the initial issuance and delivery of the shares of Common Stock pursuant to the Purchase Contracts; provided, however, that the Company shall not be required to pay any such tax or taxes which may be payable in respect

of any exchange of or substitution for a Certificate evidencing a Unit or any issuance of a share of Common Stock in a name other than that of the registered Holder of a Certificate surrendered in respect of the Units evidenced thereby, other than in the name of the Purchase Contract Agent, as custodian for such Holder, and the Company shall not be required to issue or deliver such share certificates or Certificates unless or until the Person or Persons requesting the transfer or issuance thereof shall have paid to the Company the amount of such tax or shall have established to the satisfaction of the Company that such tax has been paid.

Section 5.10. *Contract Adjustment Payments.* (a) Subject to Section 5.10(d) and Section 5.10(e) through (q), the Company shall pay, on each Payment Date, the Contract Adjustment Payments payable in respect of each Purchase Contract for the period from and including the immediately preceding Payment Date on which Contract Adjustment Payments were paid (or if none, the Special Payment Date) to but excluding such Payment Date to the Person in whose name a Certificate is registered at the close of business on the Record Date relating to such Payment Date. Contract Adjustment Payments on Global Certificates will be made by wire transfer of immediately available funds to the Depository. If the book-entry system for the Units has been terminated, the Contract Adjustment Payments will be payable at the office of the Purchase Contract Agent in the Borough of Manhattan, City of New York, New York maintained for that purpose or, at the option of the Company, by check mailed to the address of the Person entitled thereto at such Person's address as it appears on the Security Register as of the Record Date, or by wire transfer to the account designated by such Person by a prior written notice to the Purchase Contract Agent. If any Payment Date is not a Business Day, then payment of the Contract Adjustment Payments payable on such date will be made on the next succeeding day that is a Business Day (and without any interest in respect of any such delay). Contract Adjustment Payments payable for any period will be computed on the basis of a

64

360-day year of twelve 30-day months. The Contract Adjustment Payments will accrue from May [•], 2004.

In addition, the Company shall pay on May [•], 2004 (the "**Special Payment Date**"), the Contract Adjusted Payments accrued from and including May [•], 2004 to but excluding the Special Payment Date to the Person in whose name a Certificate is registered at the close of business on the Business Day immediately preceding the Special Payment Date. The Contract Adjustment Payments payable on the Special Payment Date shall be paid by wire transfer to the account designated by the Person entitled to receive such payment by prior notice to the Company and the Purchase Contract Agent.

(b) Upon the occurrence of a Termination Event, the Company's obligation to pay future Contract Adjustment Payments (including any accrued Contract Adjustment Payments) shall cease.

(c) Each Certificate delivered under this Agreement upon registration of transfer of or in exchange for or in lieu of (including as a result of a Collateral Substitution or the recreation of Corporate Units) any other Certificate shall carry the right to accrued and unpaid Contract Adjustment Payments, which right was carried by the Purchase Contracts underlying such other Certificates.

(d) In the case of any Unit with respect to which Early Settlement or Cash Merger Early Settlement of the underlying Purchase Contract is effected on a date that is after any Record Date and prior to or on the next succeeding Payment Date, Contract Adjustment Payments otherwise payable on such Payment Date shall be payable on such Payment Date notwithstanding such Early Settlement or Cash Merger Early Settlement, and such Contract Adjustment Payments shall be paid to the Person in whose name the Certificate evidencing such Unit is registered at the close of business on such Record Date. Except as otherwise expressly provided in the immediately preceding sentence, and the right to receive accrued and unpaid Contract Adjustment Payments as set forth in Section 5.04(b)(ii), in the case of any Unit with respect to which Early Settlement or Cash Merger Early Settlement of the underlying Purchase Contract is effected, Contract Adjustment Payments that would otherwise be payable after the Early Settlement or Cash Merger Early Settlement Date with respect to such Purchase Contract shall not be payable.

(e) The Company's obligations with respect to Contract Adjustment Payments will be subordinated and junior in right of payment to the Company's obligations under any Senior Indebtedness as set forth in this Section 5.10.

(f) In the event (x) of any payment by, or distribution of assets of, the Company of any kind or character, whether in cash, property or securities, to creditors upon any dissolution, winding-up, liquidation or reorganization of the Company, whether voluntary or involuntary or in bankruptcy, insolvency, receivership or other proceedings, or (y) subject to the provisions of Section 5.10(h) below, that (A) a default shall have occurred and be continuing with respect to the payment of principal, interest or any other monetary amounts due and payable on any Senior Indebtedness and such default shall have continued beyond the period of grace, if any, specified in the instrument evidencing such Senior Indebtedness (and the Purchase Contract Agent shall have received written notice

65

thereof from the Company or one or more holders of Senior Indebtedness or their representative or representatives or the trustee or trustees under any indenture pursuant to which any such Senior Indebtedness may have been issued), or (B) the maturity of any Senior Indebtedness shall have been accelerated because of a default in respect of such Senior Indebtedness (and the Purchase Contract Agent shall have received written notice thereof from the Company or one or more holders of Senior Indebtedness or their representative or representatives or the trustee or trustees under any indenture pursuant to which any such Senior Indebtedness may have been issued), then:

(i) the holders of all Senior Indebtedness shall first be entitled to receive, in the case of clause (x) above, payment of all amounts due or to become due upon all Senior Indebtedness and, in the case of subclauses (A) and (B) of clause (y) above, payment of all amounts due thereon, or provision shall be made for such payment in money or money's worth, before the Holders of any of the Units are entitled to receive any Contract Adjustment Payments on the Purchase Contracts underlying the Units;

(ii) any payment by, or distribution of assets of, the Company of any kind or character, whether in cash, property or securities, to which the Holders of any of the Units would be entitled except for the provisions of Section 5.10(e) through (q), including any such payment or distribution that may be payable or deliverable by reason of the payment of any other indebtedness of the Company being subordinated to the payment of such Contract Adjustment Payments on the Purchase Contracts underlying the Units, shall be paid or delivered by the Person making such payment or distribution, whether a trustee in bankruptcy, a receiver or liquidating trustee or otherwise, directly to the representative or representatives of the holders of Senior Indebtedness or to the trustee or trustees under any indenture under which any instruments evidencing any of such Senior Indebtedness may have been issued, ratably according to the aggregate amounts remaining unpaid on account of such Senior Indebtedness held or represented by each, to the extent necessary to make payment in full of all Senior Indebtedness remaining unpaid after giving effect to any concurrent payment or distribution (or provision therefor) to the holders of such Senior Indebtedness, before any payment or distribution is made of such Contract Adjustment Payments to the Holders of such Units; and

(iii) in the event that, notwithstanding the foregoing, any payment by, or distribution of assets of, the Company of any kind or character, whether in cash, property or securities, including any such payment or distribution that may be payable or deliverable by reason of the payment of any other indebtedness of the Company being subordinated to the payment of Contract Adjustment Payments on the Purchase Contracts underlying the Units, shall be received by the Purchase Contract Agent or the Holders of any of the Units when such payment or distribution is prohibited pursuant to Section 5.10(e) through (q), such payment or distribution shall be paid over to the representative or representatives of the holders of Senior Indebtedness or to the trustee or trustees under any indenture pursuant to which any instruments evidencing any such Senior Indebtedness may have been issued, ratably as aforesaid, for application to the payment of all Senior Indebtedness remaining unpaid until all such Senior Indebtedness shall have been

66



paid in full, after giving effect to any concurrent payment or distribution (or provision therefor) to the holders of such Senior Indebtedness.

(g) For purposes of Section 5.10(e) through (q), the words “cash, property or securities” shall not be deemed to include shares of stock of the Company as reorganized or readjusted, or securities of the Company or any other Person provided for by a plan of reorganization or readjustment, the payment of which is subordinated at least to the extent provided in Section 5.10(e) through (q) with respect to such Contract Adjustment Payments on the Units to the payment of all Senior Indebtedness which may at the time be outstanding; *provided* that (i) the Senior Indebtedness is assumed by the Person, if any, resulting from any such reorganization or readjustment, and (ii) the rights of the holders of the Senior Indebtedness are not, without the consent of each such holder adversely affected thereby, altered by such reorganization or readjustment;

(h) Any failure by the Company to make any payment on or perform any other obligation under Senior Indebtedness, other than any indebtedness incurred by the Company or assumed or guaranteed, directly or indirectly, by the Company for money borrowed (or any deferral, renewal, extension or refunding thereof) or any indebtedness or obligation as to which the provisions of Section 5.10(e) through (q) shall have been waived by the Company in the instrument or instruments by which the Company incurred, assumed, guaranteed or otherwise created such indebtedness or obligation, shall not be deemed a default or event of default if (i) the Company shall be disputing its obligation to make such payment or perform such obligation and (ii) either (A) no final judgment relating to such dispute shall have been issued against the Company which is in full force and effect and is not subject to further review, including a judgment that has become final by reason of the expiration of the time within which a party may seek further appeal or review, and (B) in the event a judgment that is subject to further review or appeal has been issued, the Company shall in good faith be prosecuting an appeal or other proceeding for review and a stay of execution shall have been obtained pending such appeal or review.

(i) Subject to the irrevocable payment in full of all Senior Indebtedness, the Holders of the Units shall be subrogated (equally and ratably with the holders of all obligations of the Company which by their express terms are subordinated to Senior Indebtedness of the Company to the same extent as payment of the Contract Adjustment Payments in respect of the Purchase Contracts underlying the Units is subordinated and which are entitled to like rights of subrogation) to the rights of the holders of Senior Indebtedness to receive payments or distributions of cash, property or securities of the Company applicable to the Senior Indebtedness until all such Contract Adjustment Payments owing on the Units shall be paid in full, and as between the Company, its creditors other than holders of such Senior Indebtedness and the Holders, no such payment or distribution made to the holders of Senior Indebtedness by virtue of Section 5.10(e) through (q) that otherwise would have been made to the Holders shall be deemed to be a payment by the Company on account of such Senior Indebtedness, it being understood that the provisions of Section 5.10(e) through (q) are and are intended solely for the purpose of defining the relative rights of the Holders, on the one hand, and the holders of Senior Indebtedness, on the other hand.

67

---

(j) Nothing contained in Section 5.10(e) through (q) or elsewhere in this Agreement or in the Units is intended to or shall impair, as among the Company, its creditors other than the holders of Senior Indebtedness and the Holders, the obligation of the Company, which is absolute and unconditional, to pay to the Holders such Contract Adjustment Payments on the Units as and when the same shall become due and payable in accordance with their terms, or is intended to or shall affect the relative rights of the Holders and creditors of the Company other than the holders of Senior Indebtedness, nor shall anything herein or therein prevent the Purchase Contract Agent or any Holder from exercising all remedies otherwise permitted by applicable law upon default under this Agreement, subject to the rights, if any, under Section 5.10(e) through (q), of the holders of Senior Indebtedness in respect of cash, property or securities of the Company received upon the exercise of any such remedy.

(k) Upon payment or distribution of assets of the Company referred to in Section 5.10(e) through (q), the Purchase Contract Agent and the Holders shall be entitled to rely upon any order or decree made by any court of competent jurisdiction in which any such dissolution, winding up, liquidation or reorganization proceeding affecting the affairs of the Company is pending or upon a certificate of the trustee in bankruptcy, receiver, assignee for the benefit of creditors, liquidating trustee or trustee or other person making any payment or distribution, delivered to the Purchase Contract Agent or to the Holders, for the purpose of ascertaining the Persons entitled to participate in such payment or distribution, the holders of Senior Indebtedness and other indebtedness of the Company, the amount thereof or payable thereon, the amount or amounts paid or distributed thereon and all other facts pertinent thereto or to these Section 5.10(e) through (q).

(l) The Purchase Contract Agent shall be entitled to rely on the delivery to it of a written notice by a Person representing himself to be a holder of Senior Indebtedness (or a trustee or representative on behalf of such holder) to establish that such notice has been given by a holder of Senior Indebtedness or a trustee or representative on behalf of any such holder or holders. In the event that the Purchase Contract Agent determines in good faith that further evidence is required with respect to the right of any Person as a holder of Senior Indebtedness to participate in any payment or distribution pursuant to Section 5.10(e) through (q), the Purchase Contract Agent may request such Person to furnish evidence to the reasonable satisfaction of the Purchase Contract Agent as to the amount of Senior Indebtedness held by such Person, the extent to which such Person is entitled to participate in such payment or distribution and any other facts pertinent to the rights of such Person under Section 5.10(e) through (q), and, if such evidence is not furnished, the Purchase Contract Agent may defer payment to such Person pending judicial determination as to the right of such Person to receive such payment.

(m) Nothing contained in Section 5.10(e) through (q) shall affect the obligations of the Company to make, or prevent the Company from making, payment of the Contract Adjustment Payments, except as otherwise provided in these Section 5.10(e) through (q).

(n) Each Holder, by its acceptance thereof, authorizes and directs the Purchase Contract Agent on its behalf to take such action as may be necessary or appropriate to effectuate the subordination provided in Section 5.10(e) through (q) and appoints the Purchase Contract Agent as its attorney-in-fact for any and all such purposes.

68

---

(o) The Company shall give prompt written notice to the Purchase Contract Agent of any fact known to the Company that would prohibit the making of any payment of moneys to or by the Purchase Contract Agent in respect of the Units pursuant to the provisions of this Section. Notwithstanding the provisions of Section 5.10(e) through (q) or any other provisions of this Agreement, the Purchase Contract Agent shall not be charged with knowledge of the existence of any facts that would prohibit the making of any payment of moneys to or by the Purchase Contract Agent, or the taking of any other action by the Purchase Contract Agent, unless and until the Purchase Contract Agent shall have received written notice thereof mailed or delivered to the Purchase Contract Agent at its Corporate Trust Office from the Company, any Holder, or the holder or representative of any Senior Indebtedness; *provided* that if at least two Business Days prior to the date upon which by the terms hereof any such moneys may become payable for any purpose, the Purchase Contract Agent shall not have received with respect to such moneys the notice provided for in this Section, then, anything herein contained to the contrary notwithstanding, the Purchase Contract Agent shall have full power and authority to receive such moneys and to apply the same to the purpose for which they were received and shall not be affected by any notice to the contrary that may be received by it within two Business Days prior to or on or after such date.

(p) The Purchase Contract Agent in its individual capacity shall be entitled to all the rights set forth in this Section 5.10 with respect to any Senior Indebtedness at the time held by it, to the same extent as any other holder of Senior Indebtedness and nothing in this Agreement shall deprive the Purchase Contract Agent of any of its rights as such holder.

(q) No right of any present or future holder of any Senior Indebtedness to enforce the subordination herein shall at any time or in any way be prejudiced or impaired by any act or failure to act on the part of the Company or by any noncompliance by the Company with the terms, provisions and covenants of this Agreement, regardless of any knowledge thereof which any such holder may have or be otherwise charged with.

(r) Nothing in this Section 5.10 shall apply to claims of, or payments to, the Purchase Contract Agent under or pursuant to Section 7.07.

(s) With respect to the holders of Senior Indebtedness, (i) the duties and obligations of the Purchase Contract Agent shall be determined solely by the express provisions of this Agreement; (ii) the Purchase Contract Agent shall not be liable to any such holders if it shall, acting in good faith, mistakenly pay over or distribute to the Holders or to the Company or any other Person cash, property or securities to which any holders of Senior Indebtedness shall be entitled by virtue of this Section 5.10 or otherwise; (iii) no implied covenants or obligations shall be read into this Agreement against the Purchase Contract Agent; and (iv) the Purchase Contract Agent shall not be deemed to be a fiduciary as to holders of such Senior Indebtedness.

---

## ARTICLE 6 RIGHTS AND REMEDIES OF HOLDERS

Section 6.01. *Unconditional Right of Holders to Receive Contract Adjustment Payments and To Purchase Shares of Common Stock.* Each Holder of a Unit shall have the right, which is absolute and unconditional, (i) subject to Article 5, to receive each Contract Adjustment Payment with respect to the Purchase Contract comprising part of such Unit on the respective Payment Date for such Unit pursuant to the terms hereof and (ii) except upon and following a Termination Event, to purchase shares of Common Stock pursuant to such Purchase Contract and, in each such case, to institute suit for the enforcement of any such right to receive Contract Adjustment Payments and the right to purchase shares of Common Stock, and such rights shall not be impaired without the consent of such Holder.

Section 6.02. *Restoration of Rights and Remedies.* If any Holder has instituted any proceeding to enforce any right or remedy under this Agreement and such proceeding has been discontinued or abandoned for any reason, or has been determined adversely to such Holder, then and in every such case, subject to any determination in such proceeding, the Company and such Holder shall be restored severally and respectively to their former positions hereunder, and thereafter all rights and remedies of such Holder shall continue as though no such proceeding had been instituted.

Section 6.03. *Rights and Remedies Cumulative.* Except as otherwise provided with respect to the replacement or payment of mutilated, destroyed, lost or stolen Certificates in the last paragraph of Section 3.10, no right or remedy herein conferred upon or reserved to the Holders is intended to be exclusive of any other right or remedy, and every right and remedy shall, to the extent permitted by law, be cumulative and in addition to every other right and remedy given hereunder or now or hereafter existing at law or in equity or otherwise. The assertion or employment of any right or remedy hereunder, or otherwise, shall not prevent the concurrent assertion or employment of any other appropriate right or remedy.

Section 6.04. *Delay or Omission Not Waiver.* No delay or omission of any Holder to exercise any right upon a default or remedy upon a default shall impair any such right or remedy or constitute a waiver of any such right. Every right and remedy given by this Article 6 or by law to the Holders may be exercised from time to time, and as often as may be deemed expedient, by such Holders.

Section 6.05. *Undertaking for Costs.* All parties to this Agreement agree, and each Holder of a Unit, by its acceptance of such Unit shall be deemed to have agreed, that any court of competent jurisdiction may in its discretion require, in any suit for the enforcement of any right or remedy under this Agreement, or in any suit against the Purchase Contract Agent for any action taken, suffered or omitted by it as Purchase Contract Agent, the filing by any party litigant in such suit of an undertaking to pay the costs of such suit, and that such court may in its discretion assess reasonable costs, including reasonable attorneys' fees and costs against any party litigant in such suit, having due regard to the merits and good faith of the claims or defenses made by such party litigant; *provided* that the provisions of this Section shall not apply to any suit instituted by the Purchase Contract Agent, to any suit instituted by any Holder, or group of Holders,

---

holding in the aggregate more than 10% of the Outstanding Units, or to any suit instituted by any Holder for the enforcement of interest on any Senior Notes owed pursuant to such Holder's Applicable Ownership Interests in Senior Notes or Contract Adjustment Payments on or after the respective Payment Date therefor in respect of any Unit held by such Holder, or for enforcement of the right to purchase shares of Common Stock under the Purchase Contracts constituting part of any Unit held by such Holder.

Section 6.06. *Waiver of Stay or Extension Laws.* The Company covenants (to the extent that it may lawfully do so) that it will not at any time insist upon, or plead, or in any manner whatsoever claim or take the benefit or advantage of, any stay or extension law wherever enacted, now or at any time hereafter in force, that may affect the covenants or the performance of this Agreement; and the Company (to the extent that it may lawfully do so) hereby expressly waives all benefit or advantage of any such law and covenants that it will not hinder, delay or impede the execution of any power herein granted to the Purchase Contract Agent or the Holders, but will suffer and permit the execution of every such power as though no such law had been enacted.

## ARTICLE 7 THE PURCHASE CONTRACT AGENT

Section 7.01. *Certain Duties and Responsibilities.*

(a) The Purchase Contract Agent:

(i) undertakes to perform, with respect to the Units, such duties and only such duties as are specifically set forth in this Agreement and the Remarketing Agreement to be performed by the Purchase Contract Agent and no implied covenants or obligations shall be read into this Agreement or the Remarketing Agreement against the Purchase Contract Agent; and

(ii) in the absence of bad faith on its part, may, with respect to the Units, conclusively rely, as to the truth of the statements and the correctness of the opinions expressed therein, upon certificates or opinions furnished to the Purchase Contract Agent and conforming to the requirements of this Agreement or the Remarketing Agreement, as applicable, but in the case of any certificates or opinions which by any provision hereof are specifically required to be furnished to the Purchase Contract Agent, the Purchase Contract Agent shall be under a duty to examine the same to determine whether or not they conform to the requirements of this Agreement or the Remarketing Agreement, as applicable (but need not confirm or investigate the accuracy of the mathematical calculations or other facts stated therein).

(b) No provision of this Agreement or the Remarketing Agreement shall be construed to relieve the Purchase Contract Agent from liability for its own grossly negligent action, its own grossly negligent failure to act, or its own willful misconduct, except that:

---

(i) this Section 7.01(b) shall not be construed to limit the effect of Section 7.01(a);

(ii) the Purchase Contract Agent shall not be liable for any error of judgment made in good faith by a Responsible Officer, unless it shall be conclusively determined by a court of competent jurisdiction that the Purchase Contract Agent was grossly negligent in ascertaining the pertinent facts; and

(iii) no provision of this Agreement or the Remarketing Agreement shall require the Purchase Contract Agent to expend or risk its own funds or otherwise incur any financial liability in the performance of any of its duties hereunder, or in the exercise of any of its rights or powers, if it shall have reasonable grounds for believing that repayment of such funds or adequate indemnity against such risk or liability is not reasonably assured to it.

(c) Whether or not therein expressly so provided, every provision of this Agreement and the Remarketing Agreement relating to the conduct or affecting the liability of or affording protection to the Purchase Contract Agent shall be subject to the provisions of this Section.

(d) The Purchase Contract Agent is authorized to execute and deliver the Remarketing Agreement in its capacity as Purchase Contract Agent.

Section 7.02. *Notice of Default.* Within 30 days after the occurrence of any default by the Company hereunder of which a Responsible Officer of the Purchase Contract Agent has actual knowledge, the Purchase Contract Agent shall transmit by mail to the Company and the Holders, as their names and addresses appear in the Security Register, notice of such default hereunder, unless such default shall have been cured or waived.

Section 7.03. *Certain Rights of Purchase Contract Agent.*

Subject to the provisions of Section 7.01:

(a) the Purchase Contract Agent may, in the absence of bad faith, conclusively rely and shall be fully protected in acting or refraining from acting upon any resolution, certificate, statement, instrument, opinion, report, notice, request, direction, consent, order, bond, debenture, note, other evidence of indebtedness or other paper or document believed by it to be genuine and to have been signed or presented by the proper party or parties;

(b) any request or direction of the Company mentioned herein shall be sufficiently evidenced by an Officers' Certificate, Issuer Order or Issuer Request, and any resolution of the Board of Directors of the Company may be sufficiently evidenced by a Board Resolution;

(c) whenever in the administration of this Agreement or the Remarketing Agreement the Purchase Contract Agent shall deem it desirable that a matter be proved or established prior to taking, suffering or omitting to take any action hereunder or thereunder, the Purchase Contract Agent (unless other evidence be herein specifically

72

---

prescribed in this Agreement) may, in the absence of bad faith on its part, conclusively rely upon an Officers' Certificate of the Company;

(d) the Purchase Contract Agent may consult with counsel of its selection and the advice of such counsel or any Opinion of Counsel shall be full and complete authorization and protection in respect of any action taken, suffered or omitted by it hereunder in good faith and in reliance thereon;

(e) the Purchase Contract Agent shall not be bound to make any investigation into the facts or matters stated in any resolution, certificate, statement, instrument, opinion, report, notice, request, direction, consent, order, bond, debenture, note, other evidence of indebtedness or other paper or document, but the Purchase Contract Agent, in its discretion, may make reasonable further inquiry or investigation into such facts or matters related to the execution, delivery and performance of the Purchase Contracts as it may see fit, and, if the Purchase Contract Agent shall determine to make such further inquiry or investigation, it shall be entitled to examine the relevant books, records and premises of the Company, personally or by agent or attorney;

(f) the Purchase Contract Agent may execute any of the powers hereunder or perform any duties hereunder either directly or by or through agents, attorneys, custodians or nominees or an Affiliate of the Purchase Contract Agent and the Purchase Contract Agent shall not be responsible for any misconduct or negligence on the part of any agent, attorney, custodian or nominee or an Affiliate appointed with due care by it hereunder;

(g) the Purchase Contract Agent shall be under no obligation to exercise any of the rights or powers vested in it by this Agreement at the request or direction of any of the Holders pursuant to this Agreement, unless such Holders shall have offered to the Purchase Contract Agent security or indemnity satisfactory to the Purchase Contract Agent against the costs, expenses and liabilities which might be incurred by it in compliance with such request or direction;

(h) the Purchase Contract Agent shall not be liable for any action taken, suffered, or omitted to be taken by it in the absence of bad faith by it and believed by it to be authorized and within the discretion or rights or powers conferred upon it by this Agreement;

(i) the Purchase Contract Agent shall not be deemed to have notice of any adjustment to each Fixed Settlement Rate, the occurrence of a Termination Event or any default hereunder unless a Responsible Officer of the Purchase Contract Agent has actual knowledge thereof or unless written notice of any event which is in fact such a default is received by a Responsible Offer at the Corporate Trust Office of the Purchase Contract Agent, and such notice references the Units or this Agreement;

(j) the Purchase Contract Agent may request that the Company deliver an Officers' Certificate setting forth the names of individuals and/or titles of officers authorized at such time to take specified actions pursuant to this Agreement, which Officers' Certificate may be signed by any person authorized to sign an Officers'

73

---

Certificate, including any person specified as so authorized in any such certificate previously delivered and not superseded;

(k) the rights, privileges, protections, immunities and benefits given to the Purchase Contract Agent, including, without limitation, its right to be indemnified, are extended to, and shall be enforceable by, the Purchase Contract Agent in each of its capacities hereunder, and to each officer, director, employee of the Purchase Contract Agent and each agent, custodian and other Person employed, in any capacity whatsoever, by the Purchase Contract Agent to act hereunder and shall survive the resignation or removal of the Purchase Contract Agent and the termination of this Agreement; and

(l) the Purchase Contract Agent shall not be required to initiate or conduct any litigation or collection proceedings hereunder and shall have no responsibilities with respect to any default hereunder except as expressly set forth herein.

Section 7.04. *Not Responsible for Recitals or Issuance of Units.* The recitals contained herein, in the Remarketing Agreement and in the Certificates shall be taken as the statements of the Company, and the Purchase Contract Agent assumes no responsibility for their accuracy or validity. The Purchase Contract Agent makes no representations as to the validity or sufficiency of either this Agreement or of the Units or the Pledge or the Collateral or the Remarketing Agreement and shall have no responsibility for perfecting or maintaining the perfection of any security interest in the Collateral. The Purchase Contract Agent shall not be accountable for the use or application by the Company of the proceeds in respect of the Purchase Contracts.

Section 7.05. *May Hold Units.* Any Security Registrar or any other agent of the Company, or the Purchase Contract Agent and its Affiliates, in their individual or any other capacity, may become the owner or pledgee of Units and may otherwise deal with the Company, the Collateral Agent or any other Person with the same rights it would have if it were not Security Registrar or such other agent, or the Purchase Contract Agent. The Company may become the owner or pledgee of Units.

Section 7.06. *Money Held in Custody.* Money held by the Purchase Contract Agent in custody hereunder need not be segregated from the Purchase Contract Agent's other funds except to the extent required by law or provided herein. The Purchase Contract Agent shall be under no obligation to invest or pay interest on any money received by it hereunder except as otherwise provided hereunder or agreed in writing with the Company.

Section 7.07. *Compensation and Reimbursement.*

The Company agrees:

(a) to pay to the Purchase Contract Agent compensation for all services rendered by it hereunder and under the Remarketing Agreement as the Company and the Purchase Contract Agent shall from time to time agree in writing;

(b) except as otherwise expressly provided for herein, to reimburse the Purchase Contract Agent upon its request for all reasonable expenses, disbursements and advances

74

---

incurred or made by the Purchase Contract Agent in accordance with any provision of this Agreement and the Remarketing Agreement (including the reasonable compensation and the expenses and disbursements of its agents and counsel) in connection with the negotiation, preparation, execution and delivery and performance of this Agreement and the Remarketing Agreement and any modification, supplement or waiver of any of the terms thereof, except any such expense, disbursement or advance as may be attributable to its gross negligence, willful misconduct or bad faith; and

(c) to indemnify the Purchase Contract Agent and any predecessor Purchase Contract Agent and each of its directors, officers, agents and employees (collectively, with the Purchase Contract Agent, the "Indemnitees") for, and to hold each Indemnitee harmless against, any loss, claim, damage, fine, penalty, liability or expense (including reasonable fees and expenses of counsel) incurred without gross negligence, willful misconduct or bad faith on its part, arising out of or in connection with the acceptance or administration of its duties hereunder and the Remarketing Agreement, including the Indemnitees' reasonable costs and expenses of defending themselves against any claim (whether asserted by the Company, a Holder or any other Person) or liability in connection with the exercise or performance of any of the Purchase Contract Agent's powers or duties hereunder or thereunder.

The provisions of this Section shall survive the resignation and removal of the Purchase Contract Agent the satisfaction or discharge of the Units and the Purchase Contracts and the termination of this Agreement.

Section 7.08. *Corporate Purchase Contract Agent Required; Eligibility.* There shall at all times be a Purchase Contract Agent hereunder which shall be a Person organized and doing business under the laws of the United States of America, any State thereof or the District of Columbia, authorized under such laws to exercise corporate trust powers, having (or being a member of a bank holding company having) a combined capital and surplus of at least \$50,000,000, subject to supervision or examination by Federal or State authority and having a corporate trust office in the Borough of Manhattan, New York City, if there be such a Person in the Borough of Manhattan, New York City, qualified and eligible under this Article and willing to act on reasonable terms. If such Person publishes or files reports of condition at least annually, pursuant to law or to the requirements of said supervising or examining authority, then for the purposes of this Section, the combined capital and surplus of such Person shall be deemed to be its combined capital and surplus as set forth in its most recent report of condition so published or filed. If at any time the Purchase Contract Agent shall cease to be eligible in accordance with the provisions of this Section, it shall resign immediately in the manner and with the effect hereinafter specified in this Article.

Section 7.09. *Resignation and Removal; Appointment of Successor.* (a) No resignation or removal of the Purchase Contract Agent and no appointment of a successor Purchase Contract Agent pursuant to this Article shall become effective until the acceptance of appointment by the successor Purchase Contract Agent in accordance with the applicable requirements of Section 7.10.

75

---

(b) The Purchase Contract Agent may resign at any time by giving written notice thereof to the Company 60 days prior to the effective date of such resignation. If the instrument of acceptance by a successor Purchase Contract Agent required by Section 7.10 shall not have been delivered to the Purchase Contract Agent within 30 days after the giving of such notice of resignation, the resigning Purchase Contract Agent may petition, at the expense of the Company, any court of competent jurisdiction for the appointment of a successor Purchase Contract Agent.

(c) The Purchase Contract Agent may be removed at any time by Act of the Holders of a majority in number of the Outstanding Units delivered to the Purchase Contract Agent and the Company. If the instrument of acceptance by a successor Purchase Contract Agent required by Section 7.10 shall not have been delivered to the Purchase Contract Agent within 30 days after such Act, the Purchase Contract Agent being removed may petition any court of competent jurisdiction for the appointment of a successor Purchase Contract Agent.

(d) If at any time:

(i) the Purchase Contract Agent fails to comply with Section 310(b) of the TIA, as if the Purchase Contract Agent were an indenture trustee under an indenture qualified under the TIA, and shall fail to resign after written request therefor by the Company or by any Holder who has been a bona fide Holder of a Unit for at least six months;

(ii) the Purchase Contract Agent shall cease to be eligible under Section 7.08 and shall fail to resign after written request therefor by the Company or by any such Holder; or

(iii) the Purchase Contract Agent shall become incapable of acting or shall be adjudged a bankrupt or insolvent or a receiver of the Purchase Contract Agent or of its property shall be appointed or any public officer shall take charge or control of the Purchase Contract Agent or of its property or affairs for the purpose of rehabilitation, conservation or liquidation,

then, in any such case, (i) the Company by a Board Resolution may remove the Purchase Contract Agent, or (ii) any Holder who has been a bona fide Holder of a Unit for at least six months may, on behalf of himself and all others similarly situated, petition any court of competent jurisdiction for the removal of the Purchase Contract Agent and the appointment of a successor Purchase Contract Agent.

(e) If the Purchase Contract Agent shall resign, be removed or become incapable of acting, or if a vacancy shall occur in the office of Purchase Contract Agent for any cause, the Company, by a Board Resolution, shall promptly appoint a successor Purchase Contract Agent and shall comply with the applicable requirements of Section 7.10. If no successor Purchase Contract Agent shall have been so appointed by the Company and accepted appointment in the manner required by Section 7.10, any Holder who has been a bona fide Holder of a Unit for at least six months, on behalf of itself and all others similarly situated, or the Purchase Contract Agent may petition, at the expense of the

76

---

Company, any court of competent jurisdiction for the appointment of a successor Purchase Contract Agent.

(f) The Company shall give, or shall cause such successor Purchase Contract Agent to give, notice of each resignation and each removal of the Purchase Contract Agent and each appointment of a successor Purchase Contract Agent by mailing written notice of such event by first-class mail, postage prepaid, to all Holders as their names and addresses appear in the applicable Security Register. Each notice shall include the name of the successor Purchase Contract Agent and the address of its Corporate Trust Office.

Section 7.10. *Acceptance of Appointment by Successor.* (a) In case of the appointment hereunder of a successor Purchase Contract Agent, every such successor Purchase Contract Agent so appointed shall execute, acknowledge and deliver to the Company and to the retiring Purchase Contract Agent an instrument accepting such appointment, and thereupon the resignation or removal of the retiring Purchase Contract Agent shall become effective and such successor Purchase Contract Agent, without any further act, deed or conveyance, shall become vested with all the rights, powers, agencies and duties of the retiring Purchase Contract Agent; but, on the request of the Company or the successor Purchase Contract Agent, such retiring Purchase Contract Agent shall, upon payment of its charges, execute and deliver an instrument transferring to such successor Purchase Contract Agent all the rights, powers and trusts of the retiring Purchase Contract Agent and duly assign, transfer and deliver to such successor Purchase Contract Agent all property and money held by such retiring Purchase Contract Agent hereunder.

(b) Upon request of any such successor Purchase Contract Agent, the Company shall execute any and all instruments for more fully and certainly vesting in and confirming to such successor Purchase Contract Agent all such rights, powers and agencies referred to in clause (a) of this Section 7.10.

(c) No successor Purchase Contract Agent shall accept its appointment unless at the time of such acceptance such successor Purchase Contract Agent shall be qualified and eligible under this Article 7.

Section 7.11. *Merger, Conversion, Consolidation or Succession to Business.* Any Person into which the Purchase Contract Agent may be merged or converted or with which it may be consolidated, or any Person resulting from any merger, conversion or consolidation to which the Purchase Contract Agent shall be a party, or any Person succeeding to all or substantially all the corporate trust business of the Purchase Contract Agent, shall be the successor of the Purchase Contract Agent hereunder, provided that such Person shall be otherwise qualified and eligible under this Article, without the execution or filing of any paper or any further act on the part of any of the parties hereto. In case any Certificates shall have been authenticated and executed on behalf of the Holders, but not delivered, by the Purchase Contract Agent then in office, any successor by merger, conversion or consolidation to such Purchase Contract Agent may adopt such authentication and execution and deliver the Certificates so authenticated and executed with the same effect as if such successor Purchase Contract Agent had itself authenticated and executed such Units.

77

---

Section 7.12. *Preservation of Information; Communications to Holders.* (a) The Purchase Contract Agent shall preserve, in as current a form as is reasonably practicable, the names and addresses of Holders received by the Purchase Contract Agent in its capacity as Security Registrar.

(b) If three or more Holders (herein referred to as “**Applicants**”) apply in writing to the Purchase Contract Agent, and furnish to the Purchase Contract Agent reasonable proof that each such Applicant has owned a Unit for a period of at least six months preceding the date of such application, and such application states that the Applicants desire to communicate with other Holders with respect to their rights under this Agreement or under the Units and is accompanied by a copy of the form of proxy or other communication which such Applicants propose to transmit, then the Purchase Contract Agent shall mail to all the Holders copies of the form of proxy or other communication which is specified in such request, with reasonable promptness after a tender to the Purchase Contract Agent of the materials to be mailed and of payment, or provision for the payment, of the reasonable expenses of such mailing.

Section 7.13. *No Obligations of Purchase Contract Agent.* Except to the extent otherwise expressly provided in this Agreement, the Purchase Contract Agent assumes no obligations and shall not be subject to any liability under this Agreement, the Remarketing Agreement or any Purchase Contract in respect of the obligations of the Holder of any Unit thereunder. The Company agrees, and each Holder of a Certificate, by its acceptance thereof, shall be deemed to have agreed, that the Purchase Contract Agent’s execution of the Certificates on behalf of the Holders shall be solely as agent and attorney-in-fact for the Holders, and that the Purchase Contract Agent shall have no obligation to perform such Purchase Contracts on behalf of the Holders, except to the extent expressly provided in Article Five hereof. Anything contained in this Agreement to the contrary notwithstanding, in no event shall the Purchase Contract Agent or its officers, directors, employees or agents be liable under this Agreement or the Remarketing Agreement for (i) indirect, incidental, special, punitive, or consequential loss or damage of any kind whatsoever, including lost profits, whether or not the likelihood of such loss or damage was known to the Purchase Contract Agent and regardless of the form of action or (ii) any failure or delay in the performance of its obligations under this Agreement arising out of or caused directly or indirectly, by acts of God; earthquake; fires; floods; wars; civil or military disturbances; terrorist acts; sabotage; epidemics; riots; interruptions, loss or malfunctions of utilities; accidents; labor disputes; or acts of civil or military authority or governmental actions; it being understood that the Purchase Contract Agent shall use reasonable efforts which are consistent with accepted practices in the banking industry to resume performance as soon as practicable under such circumstances.

Section 7.14. *Tax Compliance.* (a) The Purchase Contract Agent, on its own behalf and on behalf of the Company, will comply with all applicable certification, information reporting and withholding (including “backup” withholding) requirements imposed by applicable tax laws, regulations or administrative practice with respect to (i) any payments made with respect to the Units or (ii) the issuance, delivery, holding, transfer, redemption or exercise of rights under the Units. Such compliance shall include, without limitation, the preparation and timely filing of required returns and the timely

78

---

payment of all amounts required to be withheld to the appropriate taxing authority or its designated agent.

(b) The Purchase Contract Agent shall comply in accordance with the terms hereof with any reasonable written direction received from the Company with respect to the execution or certification of any required documentation and the application of such requirements to particular payments or Holders or in other particular circumstances, and may for purposes of this Agreement conclusively rely on any such direction in accordance with the provisions of Section 7.01(a) hereof.

(c) The Purchase Contract Agent shall maintain all appropriate records documenting compliance with such requirements, and shall make such records available, on written request, to the Company or its authorized representative within a reasonable period of time after receipt of such request.

## ARTICLE 8 SUPPLEMENTAL AGREEMENTS

Section 8.01. *Supplemental Agreements without Consent of Holders.* Without the consent of any Holders, the Company, when authorized by a Board Resolution, the Purchase Contract Agent, the Collateral Agent, the Custodial Agent and the Securities Intermediary at any time and from time to time, may enter into one or more agreements supplemental hereto, in form satisfactory to the Company and the Purchase Contract Agent, to:

(a) evidence the succession of another Person to the Company, and the assumption by any such successor of the covenants of the Company herein and in the

Certificates;

- (b) evidence and provide for the acceptance of appointment hereunder by a successor Purchase Contract Agent, Collateral Agent, Securities Intermediary or Custodial Agent;
- (c) add to the covenants of the Company for the benefit of the Holders, or surrender any right or power herein conferred upon the Company;
- (d) make provision with respect to the rights of Holders pursuant to the requirements of Section 5.04(b); or
- (e) except as provided for in Section 5.04, cure any ambiguity, to correct or supplement any provisions herein that may be inconsistent with any other provision herein, or to make such other provisions in regard to matters or questions arising under this Agreement that do not adversely affect the interests of any Holders, *provided* that any amendment made solely to conform the provisions of this Agreement to the description of the Units and the Purchase Contracts contained in the Units Prospectus will not be deemed to adversely affect the interests of the Holders.

79

---

Section 8.02. *Supplemental Agreements with Consent of Holders.* With the consent of the Holders of not less than a majority of the Outstanding Units voting together as one class, including without limitation the consent of the Holders obtained in connection with a tender or an exchange offer, by Act of said Holders delivered to the Company, the Purchase Contract Agent, the Company, the Collateral Agent, the Securities Intermediary and the Custodial Agent, as the case may be, when authorized by a Board Resolution, and the Purchase Contract Agent may enter into an agreement or agreements supplemental hereto for the purpose of modifying in any manner the terms of the Purchase Contracts, or the provisions of this Agreement or the rights of the Holders in respect of the Units; *provided, however*, that, except as contemplated herein, no such supplemental agreement shall, without the consent of the Holder of each outstanding Purchase Contract affected thereby,

- (a) change any Payment Date;
- (b) change the amount or the type of Collateral required to be Pledged to secure a Holder's obligations under the Purchase Contract (except for the rights of holders of Corporate Units to substitute Treasury Securities for the Pledged Applicable Ownership Interests in Senior Notes or the Pledged Applicable Ownership Interests in the Treasury Portfolio, as the case may be, or the rights of Holders of Treasury Units to substitute Senior Notes or the Applicable Ownership Interests in the Treasury Portfolio (as specified in clause (i) of the definition of such term), as applicable, for the Pledged Treasury Securities), impair the right of the Holder of any Purchase Contract to receive distributions on the related Collateral or otherwise adversely affect the Holder's rights in or to such Collateral;
- (c) impair the Holders' right to institute suit for the enforcement of any Purchase Contract or any Contract Adjustment Payments;
- (d) except as set forth in Section 5.04, reduce the number of shares of Common Stock or the amount of any other property to be purchased pursuant to any Purchase Contract, increase the price to purchase shares of Common Stock or any other property upon settlement of any Purchase Contract or change the Purchase Contract Settlement Date or the right to Early Settlement or Cash Merger Early Settlement or otherwise adversely affect the Holder's rights under the Purchase Contract in any material respect;
- (e) reduce any Contract Adjustment Payments or change any place where, or the coin or currency in which, any Contract Adjustment Payment is payable; or
- (f) reduce the percentage of the outstanding Purchase Contracts whose Holder's consent is required for any modification or amendment to the provisions of this Agreement or the Purchase Contracts;

*provided* that if any amendment or proposal referred to above would adversely affect only the Corporate Units or the Treasury Units, then only the affected class of Holders as of the record date for the Holders entitled to vote thereon will be entitled to vote on such amendment or proposal, and such amendment or proposal shall not be effective except with the consent of Holders of not less than a majority of such class; and *provided, further*,

80

---

that the unanimous consent of the Holders of each outstanding Purchase Contract of such class affected thereby shall be required to approve any amendment or proposal specified in clauses (a) through (f) of this Section 8.02.

It shall not be necessary for any Act of Holders under this Section to approve the particular form of any proposed supplemental agreement, but it shall be sufficient if such Act shall approve the substance thereof.

Section 8.03. *Execution of Supplemental Agreements.* In executing, or accepting the additional agencies created by any supplemental agreement permitted by this Article or the modifications thereby of the agencies created by this Agreement, the Purchase Contract Agent, the Collateral Agent, the Securities Intermediary and the Custodial Agent shall be provided, and (subject to Section 7.01 with respect to the Purchase Contract Agent) shall be fully authorized and protected in relying upon, an Officers' Certificate and an Opinion of Counsel stating that the execution of such supplemental agreement is authorized or permitted by this Agreement and that any and all conditions precedent to the execution and delivery of such supplemental agreement have been satisfied. The Purchase Contract Agent, the Collateral Agent, the Securities Intermediary and the Custodial Agent may, but shall not be obligated to, enter into any such supplemental agreement which affects their own rights, duties or immunities under this Agreement or otherwise.

Section 8.04. *Effect of Supplemental Agreements.* Upon the execution of any supplemental agreement under this Article, this Agreement shall be modified in accordance therewith, and such supplemental agreement shall form a part of this Agreement for all purposes; and every Holder of Certificates theretofore or thereafter authenticated, executed on behalf of the Holders and delivered hereunder, shall be bound thereby.

Section 8.05. *Reference to Supplemental Agreements.* Certificates authenticated, executed on behalf of the Holders and delivered after the execution of any supplemental agreement pursuant to this Article may, and shall if required by the Purchase Contract Agent, bear a notation in form approved by the Purchase Contract Agent as to any matter provided for in such supplemental agreement. If the Company shall so determine, new Certificates so modified as to conform, in the opinion of the Purchase Contract Agent and the Company, to any such supplemental agreement may be prepared and executed by the Company and authenticated, executed on behalf of the Holders and delivered by the Purchase Contract Agent in exchange for outstanding Certificates.

## ARTICLE 9 CONSOLIDATION, MERGER, CONVEYANCE, TRANSFER OR LEASE

Section 9.01. *Covenant Not To Consolidate, Merge, Convey, Transfer or Lease Property except under Certain Conditions.* The Company covenants that it will not merge or consolidate with, any other Person or sell, assign, transfer, or otherwise dispose of all or substantially all of its assets, unless:

- (a) either the Company shall be the surviving Person, or the successor (if other than the Company) shall be a corporation or limited liability company organized and

existing under the laws of the United States of America or a State thereof or the District of Columbia and such corporation or limited liability company, as the case may be, shall expressly assume all the obligations of the Company under the Purchase Contracts, this Agreement (including the Pledge provided for herein), the Indenture (including any supplement thereto) and the Remarketing Agreement by one or more supplemental agreements in form reasonably satisfactory to the Purchase Contract Agent and the Collateral Agent, executed and delivered to the Purchase Contract Agent and the Collateral Agent by such corporation or limited liability company, as the case may be; and

(b) the Company or such successor corporation or limited liability company shall not, immediately after such consolidation, conversion, merger, sale, assignment, transfer, lease or conveyance, be in default of payment obligations under the Purchase Contracts, this Agreement, the Indenture (including any supplement thereto) or the Remarketing Agreement or in material default in the performance of any other covenants under any of the foregoing agreements.

Section 9.02. *Rights and Duties of Successor Corporation.* In case of any such merger, consolidation, sale, assignment, transfer, or disposition and upon any such assumption by a successor Person in accordance with Section 9.01, such surviving Person shall succeed to and be substituted for the Company with the same effect as if it had been named herein as the Company. Such surviving Person thereupon may cause to be signed, and may issue either in its own name or in the name of Genworth Financial, Inc. any or all of the Certificates evidencing Units issuable hereunder which theretofore shall not have been signed by the Company and delivered to the Purchase Contract Agent; and, upon the order of such surviving Person, instead of the Company, and subject to all the terms, conditions and limitations in this Agreement prescribed, the Purchase Contract Agent shall authenticate and execute on behalf of the Holders and deliver any Certificates which previously shall have been signed and delivered by the officers of the Company to the Purchase Contract Agent for authentication and execution, and any Certificate evidencing Units which such surviving Person thereafter shall cause to be signed and delivered to the Purchase Contract Agent for that purpose. All the Certificates issued shall in all respects have the same legal rank and benefit under this Agreement as the Certificates theretofore or thereafter issued in accordance with the terms of this Agreement as though all of such Certificates had been issued at the date of the execution hereof.

In case of any such merger, consolidation, sale, assignment, transfer, or disposition such change in phraseology and form (but not in substance) may be made in the Certificates evidencing Units thereafter to be issued as may be appropriate.

Section 9.03. *Officers' Certificate and Opinion of Counsel Given to Purchase Contract Agent.* The Purchase Contract Agent, subject to Section 7.01 and Section 7.03, shall receive an Officers' Certificate and an Opinion of Counsel as conclusive evidence that any such merger, consolidation, sale, assignment, transfer, or disposition, and any such assumption, complies with the provisions of this Article and that all conditions precedent to the consummation of any such merger, consolidation, share exchange, sale, assignment, transfer, lease or conveyance have been met.

## ARTICLE 10 COVENANTS

Section 10.01. *Performance under Purchase Contracts.* The Company covenants and agrees for the benefit of the Holders from time to time of the Units that it will duly and punctually perform its obligations under the Purchase Contracts in accordance with the terms of the Purchase Contracts and this Agreement.

Section 10.02. *Maintenance of Office or Agency.* The Company will maintain in the Borough of Manhattan, City of New York, New York an office or agency where Certificates may be presented or surrendered for acquisition of shares of Common Stock upon settlement of the Purchase Contracts on the Purchase Contract Settlement Date or upon Early Settlement or Cash Merger Early Settlement and for transfer of Collateral upon occurrence of a Termination Event, where Certificates may be surrendered for registration of transfer or exchange, or for a Collateral Substitution and where notices and demands to or upon the Company in respect of the Units and this Agreement may be served. The Company will give prompt written notice to the Purchase Contract Agent of the location, and any change in the location, of such office or agency. The Company initially designates the Corporate Trust Office of the Purchase Contract Agent as such office of the Company. If at any time the Company shall fail to maintain any such required office or agency or shall fail to furnish the Purchase Contract Agent with the address thereof, such presentations, surrenders, notices and demands may be made or served at the Corporate Trust Office, and the Company hereby appoints the Purchase Contract Agent as its agent to receive all such presentations, surrenders, notices and demands.

The Company may also from time to time designate one or more other offices or agencies where Certificates may be presented or surrendered for any or all such purposes and may from time to time rescind such designations; *provided, however*, that no such designation or rescission shall in any manner relieve the Company of its obligation to maintain an office or agency in the Borough of Manhattan, City of New York, New York for such purposes. The Company will give prompt written notice to the Purchase Contract Agent of any such designation or rescission and of any change in the location of any such other office or agency. The Company hereby designates as the place of payment for the Units the Corporate Trust Office and appoints the Purchase Contract Agent at its Corporate Trust Office as paying agent in such city.

Section 10.03. *Company To Reserve Common Stock.* The Company shall at all times prior to the Purchase Contract Settlement Date reserve and keep available, free from preemptive rights, out of its authorized but unissued Common Stock the full number of shares of Common Stock issuable against tender of payment in respect of all Purchase Contracts constituting a part of the Units evidenced by Outstanding Certificates.

Section 10.04. *Covenants as to Common Stock; Listing.* (a) The Company covenants that all shares of Common Stock which may be issued against tender of payment in respect of any Purchase Contract constituting a part of the Outstanding Units will, upon issuance, be duly authorized, validly issued, fully paid and nonassessable.

The Company further covenants that, if at any time the Common Stock shall be listed on the NYSE or any other national securities exchange or automated quotation system, the Company will, if permitted by the rules of such exchange or automated quotation system, list and keep listed, so long as the Common Stock shall be so listed on such exchange or automated quotation system, all Common Stock issuable upon Settlement of Purchase Contracts; *provided, however*, that, if the rules of such exchange or automated quotation system permit the Company to defer the listing of such Common Stock until the date on which any Purchase Contract is first settled in accordance with the provisions of this Agreement, the Company covenants to list such Common Stock issuable upon settlement of the Purchase Contracts in accordance with the requirements of such exchange or automated quotation system no later than at such time.

Section 10.05. *Statements of Officers of the Company as to Default.* The Company will deliver to the Purchase Contract Agent, within 120 days after the end of each fiscal year of the Company (which as of the date hereof is December 31) ending after the date hereof, an Officers' Certificate, stating whether or not to the knowledge of the signers thereof the Company is in default in the performance and observance of any of the terms, provisions and conditions of this Agreement, and if the Company shall be in default, specifying all such defaults and the nature and status thereof of which they may have knowledge.

Section 10.06. *ERISA.* Each Holder from time to time of the Units that is a Plan or who used assets of a Plan to purchase Units hereby represents that either (i) no portion of the assets used by such Holder to acquire the Corporate Units constitutes assets of the Plan or (ii) the purchase or holding of the Corporate Units by such purchaser or transferee will not constitute a non-exempt prohibited transaction under Section 406 of ERISA or Section 4973 of the Code or similar violation under any applicable laws.

Section 10.07. *Tax Treatment.* The Company covenants and agrees, for United States federal, state and local income and franchise tax purposes, to (i) treat a Holder's acquisition of the Corporate Units as the acquisition of the Applicable Ownership Interests in Senior Notes and Purchase Contract constituting the Corporate Units and (ii) treat each Holder as the owner of the applicable interest in the Collateral, including the Senior Notes underlying the Applicable Ownership Interests in Senior Notes, Applicable Ownership Interests in the Treasury Portfolio or the Treasury Securities.

## ARTICLE 11 PLEDGE

Section 11.01. *Pledge.* Each Holder, acting through the Purchase Contract Agent as such Holder's attorney-in-fact, and the Purchase Contract Agent, acting solely as such attorney-in-fact, hereby pledges and grants to the Collateral Agent, as agent of and for the benefit of the Company, a continuing first priority security interest in and to, and a lien upon and right of set-off against, all of such Person's right, title and interest in and to the Collateral to secure the prompt and complete payment and performance when due (whether at stated maturity, by acceleration or otherwise) of the Obligations. The Collateral Agent shall have all of the rights, remedies and recourses with respect to the Collateral afforded a

84

---

secured party by the UCC, in addition to, and not in limitation of, the other rights, remedies and recourses afforded to the Collateral Agent by this Agreement.

Section 11.02. *Termination.* As to each Holder, the Pledge created hereby shall terminate upon the satisfaction of such Holder's Obligations. Upon such termination, the Collateral Agent shall instruct the Securities Intermediary to Transfer such portion of the Collateral attributable to such Holder to the Purchase Contract Agent for distribution to such Holder, free and clear of the Pledge created hereby.

## ARTICLE 12 ADMINISTRATION OF COLLATERAL

Section 12.01. *Initial Deposit of Senior Notes.* (a) Prior to or concurrently with the execution and delivery of this Agreement, the Purchase Contract Agent, on behalf of the initial Holders of the Corporate Units, shall Transfer to the Securities Intermediary, for credit to the Collateral Account, the Applicable Ownership Interests in Senior Notes and the Senior Notes underlying such Applicable Ownership Interests in Senior Notes or security entitlements relating thereto and the Securities Intermediary shall indicate by book-entry that a securities entitlement with respect to such Applicable Ownership Interests in Senior Notes has been credited to the Collateral Account.

(b) The Collateral Agent may, at any time or from time to time, in its sole discretion, cause any or all securities or other property underlying any financial assets credited to the Collateral Account to be registered in the name of the Securities Intermediary, the Collateral Agent or their respective nominees; *provided, however*, that unless any Event of Default (as defined in the Indenture) shall have occurred and be continuing, the Collateral Agent agrees not to cause any Senior Notes to be so re-registered.

Section 12.02. *Establishment of Collateral Account.* The Securities Intermediary hereby confirms that:

- (a) the Securities Intermediary has established the Collateral Account;
- (b) the Collateral Account is a securities account;
- (c) subject to the terms of this Agreement, the Securities Intermediary shall identify in its records the Collateral Agent as the entitlement holder entitled to exercise the rights that comprise any financial asset credited to the Collateral Account;
- (d) all property delivered to the Securities Intermediary pursuant to this Agreement, including any Applicable Ownership Interests in the Treasury Portfolio (as specified in clause (i) of the definition thereof) or Treasury Securities and the Permitted Investments, will be credited promptly to the Collateral Account; and
- (e) all securities or other property underlying any financial assets credited to the Collateral Account shall be (i) registered in the name of the Purchase Contract Agent and

85

---

indorsed to the Securities Intermediary or in blank, (ii) registered in the name of the Securities Intermediary or (iii) credited to another securities account maintained in the name of the Securities Intermediary. In no case will any financial asset credited to the Collateral Account be registered in the name of the Purchase Contract Agent (in its capacity as such) or any Holder or specially indorsed to the Purchase Contract Agent (in its capacity as such) or any Holder, unless such financial asset has been further indorsed to the Securities Intermediary or in blank.

Section 12.03. *Treatment as Financial Assets.* Each item of property (whether investment property, financial asset, security, instrument or cash) credited to the Collateral Account shall be treated as a financial asset.

Section 12.04. *Sole Control by Collateral Agent.* Except as provided in Section 15.01, at all times prior to the termination of the Pledge, the Collateral Agent shall have sole control of the Collateral Account, and the Securities Intermediary shall take instructions and directions, and comply with entitlement orders, with respect to the Collateral Account or any financial asset credited thereto solely from the Collateral Agent. If at any time the Securities Intermediary shall receive an entitlement order issued by the Collateral Agent and relating to the Collateral Account, the Securities Intermediary shall comply with such entitlement order without further consent by the Purchase Contract Agent or any Holder or any other Person. Except as otherwise permitted under this Agreement, until termination of the Pledge, the Securities Intermediary will not comply with any entitlement orders issued by the Purchase Contract Agent or any Holder.

Section 12.05. *Jurisdiction.* The Collateral Account, and the rights and obligations of the Securities Intermediary, the Collateral Agent, the Purchase Contract Agent and the Holders with respect thereto, shall be governed by the laws of the State of New York. Regardless of any provision in any other agreement, the Securities Intermediary's jurisdiction is the State of New York.

Section 12.06. *No Other Claims.* Except for the claims and interest of the Collateral Agent and of the Purchase Contract Agent and the Holders in the Collateral Account, the Securities Intermediary (without having conducted any investigation) does not know of any claim to, or interest in, the Collateral Account or in any financial asset credited thereto. If any Person asserts any lien, encumbrance or adverse claim (including any writ, garnishment, judgment, warrant of attachment, execution or similar process) against the Collateral Account or in any financial asset carried therein, the Securities Intermediary will promptly notify the Collateral Agent and the Purchase Contract Agent.

Section 12.07. *Investment and Release.* All proceeds of financial assets from time to time credited to the Collateral Account shall be invested and reinvested as provided in this Agreement. At all times prior to termination of the Pledge, no property shall be released from the Collateral Account except in accordance with this Agreement or upon written instructions of the Collateral Agent.



Section 12.08. *Statements and Confirmations.* The Securities Intermediary will promptly send copies of all statements, confirmations and other correspondence concerning the Collateral Account and any financial assets credited thereto simultaneously

to each of the Purchase Contract Agent and the Collateral Agent at their addresses for notices under this Agreement.

Section 12.09. *Tax Allocations.* The Purchase Contract Agent shall report all items of income, gain, expense and loss recognized in the Collateral Account, to the extent such reporting is required by law, to the Internal Revenue Service authorities in the manner required by law. Neither the Securities Intermediary nor the Collateral Agent shall have any tax reporting duties hereunder.

Section 12.10. *No Other Agreements.* The Securities Intermediary has not entered into, and prior to the termination of the Pledge will not enter into, any agreement with any other Person relating to the Collateral Account or any financial assets credited thereto, including, without limitation, any agreement to comply with entitlement orders of any Person other than the Collateral Agent.

Section 12.11. *Powers Coupled with an Interest.* The rights and powers granted in this Purchase Contract and Pledge Agreement to the Collateral Agent have been granted in order to perfect its security interests in the Collateral Account, are powers coupled with an interest and will be affected neither by the bankruptcy of the Purchase Contract Agent or any Holder nor by the lapse of time. The obligations of the Securities Intermediary under this Purchase Contract and Pledge Agreement shall continue in effect until the termination of the Pledge.

Section 12.12. *Waiver of Lien; Waiver of Set-off.* The Securities Intermediary waives any security interest, lien or right to make deductions or set-offs that it may now have or hereafter acquire in or with respect to the Collateral Account, any financial asset credited thereto or any security entitlement in respect thereof. Neither the financial assets credited to the Collateral Account nor the security entitlements in respect thereof will be subject to deduction, set-off, banker's lien, or any other right in favor of any person other than the Company.

#### ARTICLE 13 RIGHTS AND REMEDIES OF THE COLLATERAL AGENT

Section 13.01. *Rights and Remedies of the Collateral Agent.* (a) In addition to the rights and remedies set forth herein or otherwise available at law or in equity, after a collateral event of default (as specified in Section 13.01(b) below) hereunder, the Collateral Agent shall have all of the rights and remedies with respect to the Collateral of a secured party under the UCC (whether or not the UCC is in effect in the jurisdiction where the rights and remedies are asserted) and the TRADES Regulations and such additional rights and remedies to which a secured party is entitled under the laws in effect in any jurisdiction where any rights and remedies hereunder may be asserted. Without limiting the generality of the foregoing, such remedies may include, to the extent permitted by applicable law, (1) retention of the Senior Notes underlying Pledged Applicable Ownership Interests in Senior Notes, the Pledged Treasury Securities or the Pledged Applicable Ownership Interests in the Treasury Portfolio in full satisfaction of the Holders' obligations under the Purchase Contracts and the Purchase Contract Agreement or (2) sale

of the Senior Notes underlying Pledged Applicable Ownership Interests in Senior Notes, the Pledged Treasury Securities or the Pledged Applicable Ownership Interests in the Treasury Portfolio in one or more public or private sales.

(b) Without limiting any rights or powers otherwise granted by this Agreement to the Collateral Agent, in the event the Collateral Agent is unable to make payments to the Company on account of Proceeds of (i) the Senior Notes underlying Pledged Applicable Ownership Interests in Senior Notes (other than any interest payments thereon), (ii) Pledged Applicable Ownership Interests in the Treasury Portfolio, or (iii) the Pledged Treasury Securities as provided in this Agreement in satisfaction of the Obligations of the Holder of the Units of which such applicable Pledged Applicable Ownership Interests in the Treasury Portfolio or such Pledged Treasury Securities are a part under the related Purchase Contracts, the inability to make such payments shall constitute a "**collateral event of default**" hereunder and the Collateral Agent shall have and may exercise, with reference to such Senior Notes underlying Pledged Applicable Ownership Interests in Senior Notes, Pledged Treasury Securities or Pledged Applicable Ownership Interests in the Treasury Portfolio, as applicable, any and all of the rights and remedies available to a secured party under the UCC and the TRADES Regulations after default by a debtor, and as otherwise granted herein or under any other law.

(c) Without limiting any rights or powers otherwise granted by this Agreement to the Collateral Agent, the Collateral Agent is hereby irrevocably authorized to receive, collect and apply to the satisfaction of the Obligations all payments with respect to (i) the Senior Notes underlying Pledged Applicable Ownership Interests in Senior Notes (other than any interest payments thereon), (ii) the Pledged Treasury Securities and (iii) the Pledged Applicable Ownership Interests in the Treasury Portfolio, subject, in each case, to the provisions of this Agreement, and as otherwise provided herein.

(d) The Purchase Contract Agent and each Holder agrees that, from time to time, upon the written request of the Collateral Agent, the Purchase Contract Agent, on behalf of such Holder, shall execute and deliver such further documents and do such other acts and things as the Collateral Agent may reasonably request in order to maintain the Pledge, and the perfection and priority thereof, and to confirm the rights of the Collateral Agent hereunder. The Purchase Contract Agent shall have no liability to any Holder for executing any documents or taking any such acts requested by the Collateral Agent hereunder, except for liability for its own grossly negligent acts, its own grossly negligent failure to act or its own willful misconduct.

#### ARTICLE 14 REPRESENTATIONS AND WARRANTIES TO COLLATERAL AGENT; HOLDER COVENANTS

Section 14.01. *Representations and Warranties.* Each Holder from time to time, acting through the Purchase Contract Agent as attorney-in-fact (it being understood that the Purchase Contract Agent shall not be liable for any representation or warranty made by or on behalf of a Holder), hereby represents and warrants to the Collateral Agent (with

respect to such Holder's interest in the Collateral), which representations and warranties shall be deemed repeated on each day a Holder effects a Transfer of Collateral, that:

(a) such Holder has the power to grant a security interest in and lien on the Collateral;

(b) such Holder is the sole beneficial owner of the Collateral and, in the case of Collateral delivered in physical form, is the sole holder of such Collateral and is the sole beneficial owner of, or has the right to Transfer, the Collateral it Transfers to the Collateral Agent for credit to the Collateral Account, free and clear of any security interest, lien, encumbrance, call, liability to pay money or other restriction other than the security interest and lien granted under Article 11;

(c) upon the Transfer of the Collateral to the Securities Intermediary for credit to the Collateral Account, the Collateral Agent, for the benefit of the Company, will have a valid and perfected first priority security interest therein (assuming that any central clearing operation or any securities intermediary or other entity not within the control of the Holder involved in the Transfer of the Collateral, including the Collateral Agent and the Securities Intermediary, gives the notices and takes the action required of it hereunder and under applicable law for perfection of that interest and assuming the establishment and exercise of control pursuant to Article 12 hereof); and

(d) the execution and performance by the Holder of its obligations under this Agreement will not result in the creation of any security interest, lien or other encumbrance on the Collateral (other than the security interest and lien granted under Article 11 hereof) or violate any provision of any existing law or regulation applicable to it or of any mortgage, charge, pledge, indenture, contract or undertaking to which it is a party or which is binding on it or any of its assets.

Section 14.02. *Covenants.* The Purchase Contract Agent and the Holders from time to time, acting through the Purchase Contract Agent as their attorney-in-fact (it being understood that the Purchase Contract Agent shall not be liable for any covenant made by or on behalf of a Holder), hereby covenant to the Collateral Agent that for so long as the Collateral remains subject to the Pledge:

(a) neither the Purchase Contract Agent nor such Holders will create or purport to create or allow to subsist any mortgage, charge, lien, pledge or any other security interest whatsoever over the Collateral or any part of it other than pursuant to this Agreement; and

(b) neither the Purchase Contract Agent nor such Holders will sell or otherwise dispose (or attempt to dispose) of the Collateral or any part of it except for the beneficial interest therein, subject to the Pledge hereunder, transferred in connection with a Transfer of the Units.

---

## ARTICLE 15 THE COLLATERAL AGENT, THE CUSTODIAL AGENT AND THE SECURITIES INTERMEDIARY

It is hereby agreed as follows:

Section 15.01. *Appointment, Powers and Immunities.* The Collateral Agent, the Custodial Agent and the Securities Intermediary shall act as agent for the Company hereunder with such powers as are specifically vested in the Collateral Agent, the Custodial Agent and the Securities Intermediary, as the case may be, by the terms of this Agreement. The Collateral Agent, the Custodial Agent and Securities Intermediary shall:

(a) have no duties or responsibilities except those expressly set forth in this Agreement and no implied covenants or obligations shall be inferred from this Agreement against the Collateral Agent, the Custodial Agent or the Securities Intermediary, nor shall the Collateral Agent, the Custodial Agent or the Securities Intermediary be bound by the provisions of any agreement by any party hereto beyond the specific terms hereof;

(b) not be responsible for any recitals contained in this Agreement, or in any certificate or other document referred to or provided for in, or received by it under, this Agreement or the Units, or for the value, validity, effectiveness, genuineness, enforceability or sufficiency of this Agreement (other than as against the Collateral Agent, the Custodial Agent or the Securities Intermediary, as the case may be), the Units, any Collateral or any other document referred to or provided for herein or therein or for any failure by the Company or any other Person (except the Collateral Agent, the Custodial Agent or Securities Intermediary, as the case may be) to perform any of its obligations hereunder or thereunder or, except as expressly required hereby, for the perfection, priority or maintenance of any security interest created hereunder;

(c) not be required to initiate or conduct any litigation or collection proceedings hereunder (except pursuant to directions furnished under Section 15.02 hereof, subject to Section 15.08 hereof);

(d) not be responsible for any action taken or omitted to be taken by it hereunder or under any other document or instrument referred to or provided for herein or in connection herewith or therewith, except for its own gross negligence or willful misconduct; and

(e) not be required to advise any party as to selling or retaining, or taking or refraining from taking any action with respect to, any securities or other property deposited hereunder.

Subject to the foregoing, during the term of this Agreement, the Collateral Agent, the Custodial Agent and the Securities Intermediary shall take all reasonable action in connection with the safekeeping and preservation of the Collateral hereunder as determined by industry standards.

---

No provision of this Agreement shall require the Collateral Agent, the Custodial Agent or the Securities Intermediary to expend or risk its own funds or otherwise incur any financial liability in the performance of any of its duties hereunder. In no event shall the Collateral Agent, the Custodial Agent or the Securities Intermediary be liable for any amount in excess of the Value of the Collateral.

Section 15.02. *Instructions of the Company.* The Company shall have the right, by one or more written instruments executed and delivered to the Collateral Agent, to direct the time, method and place of conducting any proceeding for the realization of any right or remedy available to the Collateral Agent, or of exercising any power conferred on the Collateral Agent, or to direct the taking or refraining from taking of any action authorized by this Agreement; *provided, however*, that (i) such direction shall not conflict with the provisions of any law or of this Agreement or involve the Collateral Agent in personal liability and (ii) the Collateral Agent shall be indemnified to its satisfaction as provided herein. Nothing contained in this Section 15.02 shall impair the right of the Collateral Agent in its discretion to take any action or omit to take any action which it deems proper and which is not inconsistent with such direction. None of the Collateral Agent, the Custodial Agent or the Securities Intermediary has any obligation or responsibility to file UCC financing statements.

Section 15.03. *Reliance by Collateral Agent, Custodial Agent and Securities Intermediary.* Each of the Securities Intermediary, the Custodial Agent and the Collateral Agent shall be entitled to rely conclusively upon any certification, order, judgment, opinion, notice or other written communication (including, without limitation, any thereof by e-mail or similar electronic means, telecopy, telex or facsimile) believed by it in good faith to be genuine and correct and to have been signed or sent by or on behalf of the proper Person or Persons (without being required to determine the correctness of any fact stated therein) and consult with and conclusively rely upon advice, opinions and statements of legal counsel and other experts selected by the Collateral Agent, the Custodial Agent or the Securities Intermediary, as the case may be. As to any matters not expressly provided for by this Agreement, the Collateral Agent, the Custodial Agent and the Securities Intermediary shall in all cases be fully protected in acting, or in refraining from acting, hereunder in accordance with instructions given by the Company in accordance with this Agreement.

Section 15.04. *Certain Rights.* (a) Whenever in the administration of the provisions of this Agreement the Collateral Agent, the Custodial Agent or the Securities Intermediary shall deem it necessary or desirable that a matter be proved or established prior to taking or suffering any action to be taken hereunder, such matter (unless other evidence in respect thereof be herein specifically prescribed) may, in the absence of gross negligence or bad faith on the part of the Collateral Agent, the Custodial Agent or the Securities Intermediary, be deemed to be conclusively proved and established by a certificate signed by one of the Company's officers, and delivered to the Collateral Agent, the Custodial Agent or the Securities Intermediary and such certificate, in the absence of gross negligence or bad faith on the part of the Collateral Agent, the Custodial Agent or the Securities Intermediary, shall be full warrant to the Collateral Agent, the Custodial Agent or the Securities Intermediary for any action taken, suffered or omitted

(b) The Collateral Agent, the Custodial Agent or the Securities Intermediary shall not be bound to make any investigation into the facts or matters stated in any resolution, certificate, statement, instrument, opinion, report, notice, request, consent, entitlement order, approval or other paper or document.

Section 15.05. *Merger, Conversion, Consolidation or Succession to Business.* Any corporation into which the Collateral Agent, the Custodial Agent or the Securities Intermediary may be merged or converted or with which it may be consolidated, or any corporation resulting from any merger, conversion or consolidation to which the Collateral Agent, the Custodial Agent or the Securities Intermediary shall be a party, or any corporation succeeding to all or substantially all of the corporate trust business of the Collateral Agent, the Custodial Agent or the Securities Intermediary shall be the successor of the Collateral Agent, the Custodial Agent or the Securities Intermediary hereunder without the execution or filing of any paper with any party hereto or any further act on the part of any of the parties hereto except where an instrument of transfer or assignment is required by law to effect such succession, anything herein to the contrary notwithstanding.

Section 15.06. *Rights in Other Capacities.* The Collateral Agent, the Custodial Agent and the Securities Intermediary and their affiliates may (without having to account therefor to the Company) accept deposits from, lend money to, make their investments in and generally engage in any kind of banking, trust or other business with the Purchase Contract Agent, any other Person interested herein and any Holder (and any of their respective subsidiaries or affiliates) as if it were not acting as the Collateral Agent, the Custodial Agent or the Securities Intermediary, as the case may be, and the Collateral Agent, the Custodial Agent, the Securities Intermediary and their affiliates may accept fees and other consideration from the Purchase Contract Agent and any Holder without having to account for the same to the Company; *provided* that each of the Collateral Agent, the Custodial Agent and the Securities Intermediary covenants and agrees with the Company that it shall not accept, receive or permit there to be created in favor of itself and shall take no affirmative action to permit there to be created in favor of any other Person, any security interest, lien or other encumbrance of any kind in or upon the Collateral other than the lien created by the Pledge.

Section 15.07. *Non-reliance on the Collateral Agent, Custodial Agent and Securities Intermediary.* None of the Collateral Agent, the Custodial Agent and the Securities Intermediary shall be required to keep itself informed as to the performance or observance by the Purchase Contract Agent or any Holder of this Agreement, the Units or any other document referred to or provided for herein or therein or to inspect the properties or books of the Purchase Contract Agent or any Holder. None of the Collateral Agent, the Custodial Agent or the Securities Intermediary shall have any duty or responsibility to provide the Company with any credit or other information concerning the affairs, financial condition or business of the Purchase Contract Agent or any Holder (or any of their respective affiliates) that may come into the possession of the Collateral Agent, the Custodial Agent or the Securities Intermediary or any of their respective affiliates.

Section 15.08. *Compensation and Indemnity.* The Company agrees to:

(a) pay the Collateral Agent, the Custodial Agent and the Securities Intermediary from time to time such compensation as shall be agreed in writing between the Company and the Collateral Agent, the Custodial Agent or the Securities Intermediary, as the case may be, for all services rendered by them hereunder;

(b) indemnify and hold harmless the Collateral Agent, the Custodial Agent, the Securities Intermediary and each of their respective directors, officers, agents and employees (collectively, the “**Pledge Indemnitees**”), from and against any and all claims, liabilities, losses, damages, fines, penalties and expenses (including reasonable fees and expenses of counsel) (collectively, “**Losses**” and individually, a “**Loss**”) that may be imposed on, incurred by, or asserted against, the Indemnitees or any of them for following any instructions or other directions upon which any of the Collateral Agent, the Custodial Agent or the Securities Intermediary is entitled to rely pursuant to the terms of this Agreement, *provided* that the Collateral Agent, the Custodial Agent or the Securities Intermediary has not acted with gross negligence or engaged in willful misconduct or bad faith with respect to the specific Loss against which indemnification is sought; and

(c) in addition to and not in limitation of paragraph (b) of this Section 15.08, indemnify and hold the Indemnitees and each of them harmless from and against any and all Losses that may be imposed on, incurred by or asserted against, the Indemnitees or any of them in connection with or arising out of the Collateral Agent’s, the Custodial Agent’s or the Securities Intermediary’s acceptance or performance of its powers and duties under this Agreement, *provided* the Collateral Agent, the Custodial Agent or the Securities Intermediary has not acted with gross negligence or engaged in willful misconduct or bad faith with respect to the specific Loss against which indemnification is sought.

The provisions of this Section and Section 15.14 shall survive the resignation or removal of the Collateral Agent, the Custodial Agent or the Securities Intermediary and the termination of this Agreement.

Section 15.09. *Failure to Act.* In the event that, in the good faith belief of the Collateral Agent, the Custodial Agent or the Securities Intermediary, an ambiguity in the provisions of this Agreement arises or any actual dispute between or conflicting claims by or among the parties hereto or any other Person with respect to any funds or property deposited hereunder has been asserted in writing, then at its sole option, each of the Collateral Agent, the Custodial Agent and the Securities Intermediary shall be entitled, after prompt notice to the Company and the Purchase Contract Agent, to refuse to comply with any and all claims, demands or instructions with respect to such property or funds so long as such dispute or conflict shall continue, and the Collateral Agent, the Custodial Agent and the Securities Intermediary, as the case may be, shall not be or become liable in any way to any of the parties hereto for its failure or refusal to comply with such conflicting claims, demands or instructions. The Collateral Agent, the Custodial Agent and the Securities Intermediary shall be entitled to refuse to act until either:

(a) such conflicting or adverse claims or demands shall have been finally determined by a court of competent jurisdiction or settled by agreement between the conflicting parties as evidenced in a writing satisfactory to the Collateral Agent, the Custodial Agent or the Securities Intermediary; or

(b) the Collateral Agent, the Custodial Agent or the Securities Intermediary shall have received security or an indemnity satisfactory to it sufficient to hold it harmless from and against any and all loss, liability or reasonable out-of-pocket expense which it may incur by reason of its acting.

The Collateral Agent, the Custodial Agent and the Securities Intermediary may in addition elect to commence an interpleader action or seek other judicial relief or orders as the Collateral Agent, the Custodial Agent or the Securities Intermediary may deem necessary. Notwithstanding anything contained herein to the contrary, none of the Collateral Agent, the Custodial Agent or the Securities Intermediary shall be required to take any action that is in its opinion contrary to law or to the terms of this Agreement, or which would in its opinion subject it or any of its officers, employees or directors to liability.

Section 15.10. *Resignation of Collateral Agent, the Custodial Agent and the Securities Intermediary.* (a) Subject to the appointment and acceptance of a successor Collateral Agent, Custodial Agent or Securities Intermediary as provided below:

(i) the Collateral Agent, the Custodial Agent or the Securities Intermediary may resign at any time by giving notice thereof to the Company and the Purchase Contract Agent as attorney-in-fact for the Holders;

(ii) the Collateral Agent, the Custodial Agent or the Securities Intermediary may be removed at any time by the Company; and

(iii) if the Collateral Agent, the Custodial Agent or the Securities Intermediary fails to perform any of its material obligations hereunder in any material respect for a period of not less than 20 days after receiving written notice of such failure by the Purchase Contract Agent and such failure shall be continuing, the Collateral Agent, the Custodial Agent and the Securities Intermediary may be removed by the Purchase Contract Agent, acting at the direction of the Holders.

The Purchase Contract Agent shall promptly notify the Company upon the transmission of notice as contemplated by clause (iii) of Section 15.10(a) and any removal of the Collateral Agent, the Custodial Agent or the Securities Intermediary pursuant to clause (iii) of this Section 15.10(a). Upon any such resignation or removal, the Company shall have the right to appoint a successor Collateral Agent, Custodial Agent or Securities Intermediary, as the case may be, which shall not be an Affiliate of the Purchase Contract Agent. If no successor Collateral Agent, Custodial Agent or Securities Intermediary shall have been so appointed and shall have accepted such appointment within 45 days after the retiring Collateral Agent's, Custodial Agent's or Securities Intermediary's giving of notice of resignation or the Company's or the Purchase Contract Agent's giving notice of such removal, then the retiring or removed Collateral Agent, Custodial Agent or Securities Intermediary may petition any court of competent jurisdiction, at the expense of the Company, for the appointment of a successor Collateral Agent, Custodial Agent or Securities Intermediary. The Collateral Agent, the Custodial Agent and the Securities Intermediary shall each be a bank or a national banking association which has an office (or an agency office) in New York City with a combined capital and surplus of at least

94

---

\$50,000,000. Upon the acceptance of any appointment as Collateral Agent, Custodial Agent or Securities Intermediary hereunder by a successor Collateral Agent, Custodial Agent or Securities Intermediary, as the case may be, such successor Collateral Agent, Custodial Agent or Securities Intermediary, as the case may be, shall thereupon succeed to and become vested with all the rights, powers, privileges and duties of the retiring Collateral Agent, Custodial Agent or Securities Intermediary, as the case may be, and the retiring Collateral Agent, Custodial Agent or Securities Intermediary, as the case may be, shall take all appropriate action, subject to payment of any amounts then due and payable to it hereunder, to transfer any money and property held by it hereunder (including the Collateral) to such successor. The retiring Collateral Agent, Custodial Agent or Securities Intermediary shall, upon such succession, be discharged from its duties and obligations as Collateral Agent, Custodial Agent or Securities Intermediary hereunder. After any retiring Collateral Agent's, Custodial Agent's or Securities Intermediary's resignation hereunder as Collateral Agent, Custodial Agent or Securities Intermediary, the provisions of this Article 15 shall continue in effect for its benefit in respect of any actions taken or omitted to be taken by it while it was acting as the Collateral Agent, the Custodial Agent or the Securities Intermediary. Any resignation or removal of the Collateral Agent, the Custodial Agent or the Securities Intermediary hereunder, at a time when such Person is also acting as the Collateral Agent, the Custodial Agent or the Securities Intermediary, as the case may be, shall be deemed for all purposes of this Agreement as the simultaneous resignation or removal of the Collateral Agent, the Securities Intermediary or the Custodial Agent, as the case may be.

(b) Because The Bank of New York is serving as the Collateral Agent hereunder and also as the Purchase Contract Agent hereunder, if an event of default or a collateral event of default occurs hereunder The Bank of New York will resign as the Collateral Agent, Custodial Agent and the Securities Intermediary, but continue to act as the Purchase Contract Agent. A successor Collateral Agent, Custodial Agent and Securities Intermediary will be appointed in accordance with the terms of this Article 15.

Section 15.11. *Right to Appoint Agent or Advisor.* The Collateral Agent shall have the right to appoint agents or advisors in connection with any of its duties hereunder, and the Collateral Agent shall not be liable for any action taken or omitted by, or in reliance upon the advice of, such agents or advisors selected in good faith. The appointment of agents pursuant to this Section 15.11 shall be subject to prior written consent of the Company, which consent shall not be unreasonably withheld.

Section 15.12. *Survival.* The provisions of this Article 15 shall survive termination of this Agreement and the resignation or removal of the Collateral Agent, the Custodial Agent or the Securities Intermediary.

Section 15.13. *Exculpation.* Anything contained in this Agreement to the contrary notwithstanding, in no event shall the Collateral Agent, the Custodial Agent or the Securities Intermediary or their officers, directors, employees or agents be liable under this Agreement to any third party for indirect, special, punitive, or consequential loss or damage of any kind whatsoever, including, but not limited to, lost profits, whether or not the likelihood of such loss or damage was known to the Collateral Agent, the Custodial Agent or the Securities Intermediary, or any of them and regardless of the form of action.

95

---

Section 15.14. *Expenses, Etc.* The Company agrees to reimburse the Collateral Agent, the Custodial Agent and the Securities Intermediary for:

(a) all reasonable costs and expenses of the Collateral Agent, the Custodial Agent and the Securities Intermediary (including, without limitation, the reasonable fees and expenses of counsel to the Collateral Agent, the Custodial Agent and the Securities Intermediary), in connection with (i) the negotiation, preparation, execution and delivery or performance of this Agreement and (ii) any modification, supplement or waiver of any of the terms of this Agreement;

(b) all reasonable costs and expenses of the Collateral Agent, the Custodial Agent and the Securities Intermediary (including, without limitation, reasonable fees and expenses of counsel) in connection with (i) any enforcement or proceedings resulting or incurred in connection with causing any Holder to satisfy its obligations under the Purchase Contracts forming a part of the Units and (ii) the enforcement of this Section 15.14;

(c) all transfer, stamp, documentary or other similar taxes, assessments or charges levied by any governmental or revenue authority in respect of this Agreement or any other document referred to herein and all costs, expenses, taxes, assessments and other charges incurred in connection with any filing, registration, recording or perfection of any security interest contemplated hereby;

(d) all reasonable fees and expenses of any agent or advisor appointed by the Collateral Agent and consented to by the Company under Section 15.11 of this Agreement; and

(e) any other out-of-pocket costs and expenses reasonably incurred by the Collateral Agent, the Custodial Agent and the Securities Intermediary in connection with the performance of their duties hereunder.

## ARTICLE 16 MISCELLANEOUS

Section 16.01. *Security Interest Absolute.* All rights of the Collateral Agent and security interests hereunder, and all obligations of the Holders from time to time hereunder pursuant to the Pledge, shall be absolute and unconditional irrespective of:

(a) any lack of validity or enforceability of any provision of the Purchase Contracts or the Units or any other agreement or instrument relating thereto;

(b) any change in the time, manner or place of payment of, or any other term of, or any increase in the amount of, all or any of the obligations of Holders of the Units under the related Purchase Contracts, or any other amendment or waiver of any term of, or any consent to any departure from any requirement of, the Purchase Contract Agreement or any Purchase Contract or any other agreement or instrument relating thereto; or

(c) any other circumstance which might otherwise constitute a defense available to, or discharge of, a borrower, a guarantor or a pledgor.

Section 16.02. *Notice of Special Event, Special Event Redemption and Termination Event.* Upon the occurrence of a Special Event, a Special Event Redemption or a Termination Event, the Company shall deliver written notice to the Purchase Contract Agent, the Collateral Agent and the Securities Intermediary. Upon the written request of the Collateral Agent or the Securities Intermediary, the Company shall inform such party whether or not a Special Event, a Special Event Redemption or a Termination Event has occurred.

[SIGNATURES ON THE FOLLOWING PAGE]

IN WITNESS WHEREOF, the parties hereto have caused this Agreement to be duly executed as of the day and year first above written.

GENWORTH FINANCIAL, INC.

THE BANK OF NEW YORK,  
as Purchase Contract Agent and as attorney-in-fact of the Holders from time to time of  
the Units

By: \_\_\_\_\_  
Name:  
Title:

By: \_\_\_\_\_  
Name:  
Title:

Address for Notices:

Address for Notices:

Genworth Financial, Inc.  
6620 West Broad Street  
Richmond, Virginia 23230  
Telecopier No.: [•]  
Attention: [•]

The Bank of New York  
101 Barclay Street, 8W  
New York, NY 10286  
Telecopier No.: [•]  
Attention: [•]

THE BANK OF NEW YORK  
as Collateral Agent, Custodial Agent and Securities Intermediary

By: \_\_\_\_\_  
Name:  
Title:

Address for Notices:

The Bank of New York  
101 Barclay Street, 8W  
New York, NY 10286  
Telecopier No.: [•]  
Attention: [•]

EXHIBIT A

**(FORM OF FACE OF CORPORATE UNIT CERTIFICATE)**

[For inclusion in Global Certificates only - THIS CERTIFICATE IS A GLOBAL CERTIFICATE WITHIN THE MEANING OF THE PURCHASE CONTRACT AND PLEDGE AGREEMENT HEREINAFTER REFERRED TO AND IS REGISTERED IN THE NAME OF CEDE & CO., AS NOMINEE OF THE DEPOSITORY TRUST COMPANY, A NEW YORK CORPORATION (THE "DEPOSITORY"), THE DEPOSITORY OR ANOTHER NOMINEE OF THE DEPOSITORY. THIS CERTIFICATE IS EXCHANGEABLE FOR CERTIFICATES REGISTERED IN THE NAME OF A PERSON OTHER THAN THE DEPOSITORY OR ITS NOMINEE ONLY IN THE LIMITED CIRCUMSTANCES DESCRIBED IN THE PURCHASE CONTRACT AND PLEDGE AGREEMENT AND NO TRANSFER OF THIS CERTIFICATE (OTHER THAN A TRANSFER OF THIS CERTIFICATE AS A WHOLE BY THE DEPOSITORY TO A NOMINEE OF THE DEPOSITORY OR BY A NOMINEE OF THE DEPOSITORY TO THE DEPOSITORY OR ANOTHER NOMINEE OF THE DEPOSITORY) MAY BE REGISTERED EXCEPT IN LIMITED CIRCUMSTANCES.

UNLESS THIS CERTIFICATE IS PRESENTED BY AN AUTHORIZED REPRESENTATIVE OF THE DEPOSITORY FOR REGISTRATION OF TRANSFER, EXCHANGE OR PAYMENT, AND ANY CERTIFICATE ISSUED IS REGISTERED IN THE NAME OF CEDE & CO. OR SUCH OTHER NAME AS REQUESTED BY AN AUTHORIZED REPRESENTATIVE OF THE DEPOSITORY (AND ANY PAYMENT HEREON IS MADE TO CEDE & CO. OR TO SUCH OTHER ENTITY AS IS REQUESTED BY AN AUTHORIZED REPRESENTATIVE OF THE DEPOSITORY), ANY TRANSFER, PLEDGE OR OTHER USE HEREOF FOR VALUE OR OTHERWISE BY OR TO ANY PERSON IS WRONGFUL SINCE THE REGISTERED OWNER HEREOF, CEDE & CO., HAS AN INTEREST HEREIN.]

No. 1  
Number of Corporate Units: 24,000,000

CUSIP No. [•]

GENWORTH FINANCIAL, INC.  
Corporate Units

This Corporate Units Certificate certifies that \_\_\_\_\_ is the registered Holder of the number of Corporate Units set forth above [For inclusion in Global Certificates only - or such other number of Corporate Units reflected in the Schedule of Increases or Decreases in Global Certificate attached hereto, which number shall not exceed 24,000,000]. Each Corporate Unit consists of (i) either (a) an Applicable Ownership Interest in Senior Notes, subject to the Pledge thereof by such Holder pursuant to the Purchase Contract and Pledge Agreement, or (b) upon the occurrence of a Special Event Redemption prior to the Purchase Contract Settlement Date, the Applicable Ownership Interest in the Treasury Portfolio, subject to the pledge of the Applicable Ownership Interest in the Treasury Portfolio (as specified in clause (i) of the definition of

such term) by such Holder pursuant to the Purchase Contract and Pledge Agreement, and (ii) the rights and obligations of the Holder under one Purchase Contract with the Company.

A-1

All capitalized terms used herein that are defined in the Purchase Contract and Pledge Agreement (as defined on the reverse hereof) have the meaning set forth therein.

Pursuant to the Purchase Contract and Pledge Agreement, the Applicable Ownership Interest in Senior Notes or the Applicable Ownership Interest in the Treasury Portfolio (as specified in clause (i) of the definition of such term), as the case may be, constituting part of each Corporate Unit evidenced hereby have been pledged to the Collateral Agent, for the benefit of the Company, to secure the obligations of the Holder under the Purchase Contract comprising part of such Corporate Unit.

All payments of the principal amount with respect to the Senior Notes underlying the Pledged Applicable Ownership Interests in Senior Notes or all payments with respect to the Applicable Ownership Interests in the Treasury Portfolio (as specified in clause (i) of the definition of such term), as the case may be, or payments of interest on the Pledged Applicable Ownership Interests in Senior Notes or distributions with respect to the Applicable Ownership Interests in the Treasury Portfolio (as specified in clause (ii) of the definition of such term), as the case may be, constituting part of the Corporate Units shall be paid on the dates and in the manner set forth in the Purchase Contract and Pledge Agreement. Interest on the Senior Notes underlying the Applicable Ownership Interests in Senior Notes and distributions on the Applicable Ownership Interests in the Treasury Portfolio (as specified in clause (ii) of the definition of such term), as the case may be, forming part of the Corporate Units evidenced hereby, which are payable on each Payment Date, shall, subject to receipt thereof by the Purchase Contract Agent, be paid to the Person in whose name this Corporate Units Certificate (or a Predecessor Corporate Units Certificate) is registered at the close of business on the Record Date for such Payment Date.

All Contract Adjustment Payments shall be paid on the dates and in the manner set forth in the Purchase Contract and Pledge Agreement. Such Contract Adjustment Payments shall be payable to the Person in whose name this Corporate Units Certificate is registered at the close of business on the Record Date for such Payment Date.

Each Purchase Contract evidenced hereby obligates the Holder of this Corporate Units Certificate to purchase, and the Company to sell, on the Purchase Contract Settlement Date, at a Purchase Price equal to the Stated Amount, a number of newly issued shares of Common Stock of the Company, equal to the Settlement Rate, unless on or prior to the Purchase Contract Settlement Date there shall have occurred a Termination Event, an Early Settlement or a Cash Merger Early Settlement with respect to such Purchase Contract, all as provided in the Purchase Contract and Pledge Agreement. The Purchase Price for the shares of Common Stock purchased pursuant to each Purchase Contract evidenced hereby, if not paid earlier, shall be paid on the Purchase Contract Settlement Date by application of payment received in the Remarketing of the Senior Notes underlying the Pledged Applicable Ownership Interests in Senior Notes equal to the principal amount thereof or the proceeds of the Pledged Applicable Ownership Interests in the Treasury Portfolio (as specified in clause (i) of the definition of such term), as the case may be, pledged to secure the obligations under such Purchase Contract of the Holder of the Corporate Units of which such Purchase Contract is a part.

A-2

The Company shall pay, on February 16, May 16, August 16 and November 16 of each year (each, a "Payment Date"), in respect of each Purchase Contract forming part of a Corporate Unit evidenced hereby, an amount (the "Contract Adjustment Payments") equal to % per year of the Stated Amount for the period from and including the immediately preceding Payment Date on which Contract Adjustment Payments were paid (or if none, the Special Payment Date) to but excluding such Payment Date. Such Contract Adjustment Payments shall be payable to the Person in whose name this Corporate Units Certificate is registered at the close of business on the Record Date for such Payment Date. In addition, the Company shall pay on May [ ], 2004 (the "Special Payment Date"), the Contract Adjusted Payments accrued from and including May [ ], 2004 to but excluding the Special Payment Date to the Person in whose name a Certificate is registered at the close of business on the Business Day immediately preceding the Special Payment Date. The Contract Adjustment Payments payable on the Special Payment Date shall be paid by wire transfer to the account designated by the Person entitled to receive such payment by prior notice to the Company and the Purchase Contract Agent.

Distributions on the Applicable Ownership Interests in Senior Notes and distributions on the Applicable Ownership Interests in the Treasury Portfolio (as specified in clause (ii) of the definition of such term) and the Contract Adjustment Payments will be payable at the office of the Purchase Contract Agent in New York City, except that all payments with respect to Global Certificates will be made by wire transfer of immediately available funds to the Depository. If the book-entry system for the Corporate Units has been terminated, the Contract Adjustment Payments will be payable, at the option of the Company, by check mailed to the address of the Person entitled thereto at such Person's address as it appears on the Security Register, or by wire transfer to the account designated by such Person by prior written notice to the Purchase Contract Agent.

Each Purchase Contract evidenced hereby obligates the holder to agree, for United States federal, state and local income and franchise tax purposes, to (i) treat its acquisition of the Corporate Units as an acquisition of the Applicable Ownership Interest in Senior Notes and Purchase Contract constituting each Corporate Unit, (ii) treat the Applicable Ownership Interest in Senior Notes as indebtedness of the Company and (iii) treat itself as the owner of the applicable interests in the Collateral Account, including the Senior Notes underlying the Applicable Ownership Interests in the Senior Notes or the Applicable Ownership Interests in the Treasury Portfolio (as specified in clause (i) of the definition of such term).

Reference is hereby made to the further provisions set forth on the reverse hereof, which further provisions shall for all purposes have the same effect as if set forth at this place.

Unless the certificate of authentication hereon has been executed by the Purchase Contract Agent by manual signature, this Corporate Units Certificate shall not be entitled to any benefit under the Purchase Contract and Pledge Agreement or be valid or obligatory for any purpose.

A-3

IN WITNESS WHEREOF, the Company and the Holder specified above have caused this instrument to be duly executed.

GENWORTH FINANCIAL, INC.

By: \_\_\_\_\_

Name:

Title:

HOLDER SPECIFIED ABOVE (as to obligations of such Holder under the Purchase Contracts)

By: THE BANK OF NEW YORK, not individually but solely as attorney-in-fact of such Holder

By: \_\_\_\_\_  
Name:  
Title:

DATED: \_\_\_\_\_

CERTIFICATE OF AUTHENTICATION  
OF PURCHASE CONTRACT AGENT

This is one of the Corporate Units Certificates referred to in the within mentioned Purchase Contract and Pledge Agreement.

By: THE BANK OF NEW YORK,  
as Purchase Contract Agent

\_\_\_\_\_  
By: \_\_\_\_\_  
Name:  
Title:

DATED: \_\_\_\_\_

A-4

---

(REVERSE OF CORPORATE UNIT CERTIFICATE)

Each Purchase Contract evidenced hereby is governed by a Purchase Contract and Pledge Agreement, dated as of May 7, 2004 (as may be supplemented from time to time, the "**Purchase Contract and Pledge Agreement**"), between the Company and The Bank of New York, as Purchase Contract Agent (including its successors thereunder, the "**Purchase Contract Agent**") and The Bank of New York, as Collateral Agent, Custodial Agent and Securities Intermediary, to which Purchase Contract and Pledge Agreement and supplemental agreements thereto reference is hereby made for a description of the respective rights, limitations of rights, obligations, duties and immunities thereunder of the Purchase Contract Agent, the Company, and the Holders and of the terms upon which the Corporate Units Certificates are, and are to be, executed and delivered.

Each Purchase Contract evidenced hereby obligates the Holder of this Corporate Units Certificate to purchase, and the Company to sell, on the Purchase Contract Settlement Date at a price equal to the Stated Amount, a number of shares of Common Stock equal to the Settlement Rate, unless an Early Settlement, a Cash Merger Early Settlement or a Termination Event with respect to the Units of which such Purchase Contract is a part shall have occurred. The Settlement Rate is subject to adjustment as described in the Purchase Contract and Pledge Agreement.

No fractional shares of Common Stock will be issued upon settlement of Purchase Contracts, as provided in Section 5.08 of the Purchase Contract and Pledge Agreement.

Each Purchase Contract evidenced hereby that is settled through Early Settlement or Cash Merger Early Settlement shall obligate the Holder of the related Corporate Units to purchase at the Purchase Price, and the Company to sell, a number of newly issued shares of Common Stock equal to the Minimum Settlement Rate (in the case of an Early Settlement) or applicable Settlement Rate (in the case of a Cash Merger Early Settlement).

In accordance with the terms of the Purchase Contract and Pledge Agreement, unless a Termination Event shall have occurred, the Holder of this Corporate Units Certificate shall pay the Purchase Price for the shares of Common Stock purchased pursuant to each Purchase Contract evidenced hereby by effecting a Cash Settlement, an Early Settlement or, if applicable, a Cash Merger Early Settlement or from the proceeds of the Applicable Ownership Interests in the Treasury Portfolio (as specified in clause (i) of the definition of such term) or a Remarketing of the Senior Notes underlying the Pledged Applicable Ownership Interests in Senior Notes. Unless Applicable Ownership Interests in the Treasury Portfolio have replaced Applicable Ownership Interests in Senior Notes as a component of Corporate Units, a Holder of Corporate Units who (1) does not, on or prior to 5:00 p.m. (New York City time) on the sixth Business Day immediately preceding the Purchase Contract Settlement Date make an effective Cash Settlement in the manner provided in the Purchase Contract and Pledge Agreement or (2) on or prior to 5:00 p.m. (New York City time) on the seventh Business Day immediately preceding the Purchase Contract Settlement Date (in the case of Corporate Units, unless a Special Event Redemption has occurred) or the second Business Day immediately preceding the Purchase Contract Settlement Date (in the case of Corporate Units after the occurrence of a Special Event

A-5

---

Redemption), does not make an effective Early Settlement, shall pay the Purchase Price for the shares of Common Stock to be delivered under the related Purchase Contract from the proceeds of the sale of the Senior Notes underlying the Pledged Applicable Ownership Interests in Senior Notes held by the Collateral Agent in the Remarketing unless the Holder has previously made a Cash Merger Early Settlement. If the Treasury Portfolio has replaced the Senior Notes as a component of Corporate Units, a Holder of Corporate Units shall pay the Purchase Price for the shares of Common Stock to be delivered under the related Purchase Contract from the proceeds at maturity of the Applicable Ownership Interests in the Treasury Portfolio (as specified in clause (i) of the definition of such term).

As provided in the Purchase Contract and Pledge Agreement, upon the occurrence of a Failed Final Remarketing, as of the Purchase Contract Settlement Date, each Holder of any Pledged Applicable Interests in Senior Notes, unless such Holder has elected Cash Settlement and delivered cash in accordance with Section 5.02(a) of the Purchase Contract and Pledge Agreement, shall be deemed to have exercised such Holder's Put Right with respect to the Senior Notes underlying such Applicable Ownership Interests in Senior Notes and to have elected to have a portion of the Proceeds of the Put Right set-off against such Holder's obligation to pay the aggregate Purchase Price for the shares of Common Stock to be issued under the related Purchase Contracts in full satisfaction of such Holders' obligations under such Purchase Contracts, and any accrued and unpaid interest on the Senior Notes attributable to such Pledged Applicable Ownership Interests in Senior Notes will become payable by the Company to the Holder of this Corporate Units Certificate in the manner provided for in the Purchase Contract and Pledge Agreement.

The Company shall not be obligated to issue any shares of Common Stock in respect of a Purchase Contract or deliver any certificates therefor to the Holder unless it shall have received payment of the aggregate Purchase Price for the shares of Common Stock to be purchased thereunder in the manner set forth in the Purchase Contract and Pledge Agreement.

Each Purchase Contract evidenced hereby and all obligations and rights of the Company and the Holder thereunder shall terminate if a Termination Event shall occur. Upon the occurrence of a Termination Event, the Company shall give written notice to the Purchase Contract Agent and to the Holders, at their addresses as they appear in the Security Register. Upon and after the occurrence of a Termination Event, the Collateral Agent shall release the Senior Notes underlying the Pledged Applicable

Ownership Interests in Senior Notes or the Applicable Ownership Interests in the Treasury Portfolio (as specified in clause (i) of the definition of such term) forming a part of each Corporate Unit from the Pledge. A Corporate Unit shall thereafter represent the right to receive the Senior Note underlying the Applicable Ownership Interest in the Senior Notes or the Applicable Ownership Interests in the Treasury Portfolio forming a part of such Corporate Units in accordance with the terms of the Purchase Contract and Pledge Agreement.

Under the terms of the Purchase Contract and Pledge Agreement, the Purchase Contract Agent will be entitled to exercise the voting and any other consensual rights pertaining to the Senior Notes underlying the Pledged Applicable Ownership Interests in Senior Notes, but only to the extent instructed in writing by the Holders. Upon receipt of notice of any meeting at which holders of Senior Notes are entitled to vote or upon any solicitation of consents, waivers or

A-6

---

proxies of holders of Senior Notes, the Purchase Contract Agent shall, as soon as practicable thereafter, mail, first class, postage pre-paid, to the Corporate Units Holders the notice required by the Purchase Contract and Pledge Agreement.

Upon the occurrence of a Special Event Redemption, the Collateral Agent shall surrender the Senior Notes underlying the Pledged Applicable Ownership Interests in Senior Notes against delivery of an amount equal to the aggregate Redemption Price of such Senior Notes and shall deposit the funds in the Collateral Account in exchange for such Senior Notes. Thereafter, the Collateral Agent shall cause the Securities Intermediary to apply an amount equal to the aggregate Redemption Amount of such funds to purchase, on behalf of the Holders of Corporate Units, the Treasury Portfolio.

Following the occurrence of a Special Event Redemption prior to the Purchase Contract Settlement Date, the Collateral Agent shall have such security interest rights with respect to the Applicable Ownership Interests in the Treasury Portfolio (as specified in clause (i) of the definition of such term) as the Collateral Agent had in respect of Applicable Ownership Interests in Senior Notes and the underlying Senior Notes, as provided in the Purchase Contract and Pledge Agreement and any reference herein to the Senior Notes or Applicable Ownership Interests in Senior Notes shall be deemed to be a reference to the Treasury Portfolio or the Applicable Ownership Interests in the Treasury Portfolio, as the case may be.

The Corporate Units Certificates are issuable only in registered form and only in denominations of a single Corporate Unit and any integral multiple thereof. The transfer of any Corporate Units Certificate will be registered and Corporate Units Certificates may be exchanged as provided in the Purchase Contract and Pledge Agreement. A Holder who elects to substitute a Treasury Security for the Senior Note underlying the Applicable Ownership Interests in Senior Notes or Applicable Ownership Interests in the Treasury Portfolio, as the case may be, thereby creating Treasury Units, shall be responsible for any fees or expenses payable in connection therewith. Except as provided in the Purchase Contract and Pledge Agreement, such Corporate Unit shall not be separable into its constituent parts, and the rights and obligations of the Holder of such Corporate Unit in respect of the Applicable Ownership Interest in Senior Notes, or Applicable Ownership Interest in the Treasury Portfolio, as the case may be, and Purchase Contract constituting such Corporate Units may be transferred and exchanged only as a Corporate Unit.

Subject to, and in compliance with, the conditions and terms set forth in the Purchase Contract and Pledge Agreement, the Holder of Corporate Units may effect a Collateral Substitution. From and after such Collateral Substitution, each Unit for which Pledged Treasury Securities secure the Holder's obligation under the Purchase Contract shall be referred to as a "Treasury Unit". A Holder may make such Collateral Substitution only in integral multiples of 40 Corporate Units for 40 Treasury Units. If Applicable Ownership Interests in the Treasury Portfolio have replaced the Applicable Ownership Interests in Senior Notes as a component of the Corporate Units, a Holder may substitute Treasury Securities for the Applicable Ownership Interests in the Treasury Portfolio only in integral multiples of [•] Corporate Units.

Subject to and upon compliance with the provisions of the Purchase Contract and Pledge Agreement, at the option of the Holder thereof, Purchase Contracts underlying Units may be

A-7

---

settled early by effecting an Early Settlement as provided in the Purchase Contract and Pledge Agreement in integral multiples of 40 Corporate Units, or if Applicable Ownership Interests in the Treasury Portfolio have replaced the Applicable Ownership Interests in Senior Notes as a component of the Corporate Units, in integral multiples of [•] Corporate Units.

Upon Early Settlement of Purchase Contracts by a Holder of the related Units, the Senior Notes underlying the Pledged Applicable Ownership Interests in Senior Notes or the Applicable Ownership Interests in the Treasury Portfolio (as specified in clause (i) of the definition of such term) underlying such Units shall be released from the Pledge as provided in the Purchase Contract and Pledge Agreement and the Holder shall be entitled to receive a number of shares of Common Stock on account of each Purchase Contract forming part of a Corporate Unit as to which Early Settlement is effected equal to the Minimum Settlement Rate.

Upon the occurrence of a Cash Merger, a Holder of Corporate Units may effect Cash Merger Early Settlement of the Purchase Contracts underlying such Corporate Units pursuant to the terms of the Purchase Contract and Pledge Agreement in integral multiples of 40 Corporate Units, or if the Applicable Ownership Interests in the Treasury Portfolio have replaced the Applicable Ownership Interests in Senior Notes as a component of the Corporate Units, in integral multiples of [•] Corporate Units. Upon Cash Merger Early Settlement of Purchase Contracts by a Holder of the related Corporate Units, the Senior Notes underlying the Pledged Applicable Ownership Interests in Senior Notes or the Applicable Ownership Interests in the Treasury Portfolio (as specified in clause (i) of the definition of such term) underlying such Corporate Units shall be released from the Pledge as provided in the Purchase Contract and Pledge Agreement and the Holder shall be entitled to receive a number of shares of Common Stock on account of each Purchase Contract forming part of a Corporate Unit as to which Cash Merger Early Settlement is effected equal to the applicable Settlement Rate.

Upon registration of transfer of this Corporate Units Certificate, the transferee shall be bound (without the necessity of any other action on the part of such transferee, except as may be required by the Purchase Contract Agent pursuant to the Purchase Contract and Pledge Agreement), under the terms of the Purchase Contract and Pledge Agreement and the Purchase Contracts evidenced hereby and the transferor shall be released from the obligations under the Purchase Contracts evidenced by this Corporate Units Certificate. The Company covenants and agrees, and the Holder, by its acceptance hereof, likewise covenants and agrees, to be bound by the provisions of this paragraph.

The Holder of this Corporate Units Certificate, by its acceptance hereof, authorizes the Purchase Contract Agent to enter into and perform the related Purchase Contracts forming part of the Corporate Units evidenced hereby on its behalf as its attorney-in-fact, expressly withholds any consent to the assumption (i.e., affirmation) of the Purchase Contracts by the Company or its trustee in the event that the Company becomes the subject of a case under the Bankruptcy Code, agrees to be bound by the terms and provisions thereof, covenants and agrees to perform its obligations under such Purchase Contracts, consents to the provisions of the Purchase Contract and Pledge Agreement, authorizes the Purchase Contract Agent to enter into and perform the Purchase Contract and Pledge Agreement on its behalf as its attorney-in-fact, and consents to the Pledge of the Applicable Ownership Interests in Senior Notes and the underlying Senior Notes or the Applicable Ownership Interests in the Treasury Portfolio (as specified in clause (i) of the

A-8

---

definition of such term), as the case may be, underlying this Corporate Units Certificate pursuant to the Purchase Contract and Pledge Agreement. The Holder further



covenants and agrees that, to the extent and in the manner provided in the Purchase Contract and Pledge Agreement, but subject to the terms thereof, any payments with respect to the Senior Notes underlying the Pledged Applicable Ownership Interests in Senior Notes (other than interest payments thereon) or the Proceeds of the Applicable Ownership Interests in the Treasury Portfolio (as specified in clause (i) of the definition of such term), as the case may be, on the Purchase Contract Settlement Date equal to the aggregate Purchase Price for the related Purchase Contracts shall be paid by the Collateral Agent to the Company in satisfaction of such Holder's obligations under the related Purchase Contracts and such Holder shall acquire no right, title or interest in such payments.

Subject to certain exceptions, the provisions of the Purchase Contract and Pledge Agreement may be amended with the consent of the Holders of a majority of the Purchase Contracts.

The Purchase Contracts shall be governed by, and construed in accordance with, the laws of the State of New York, without giving effect to the conflicts of law provisions thereof to the extent a different law would govern as a result.

The Purchase Contracts shall not, prior to the settlement thereof, entitle the Holder to any of the rights of a holder of shares of Common Stock.

Prior to due presentment of this Certificate for registration of transfer, the Company, the Purchase Contract Agent and its Affiliates and any agent of the Company or the Purchase Contract Agent may treat the Person in whose name this Corporate Units Certificate is registered as the owner of the Corporate Units evidenced hereby for the purpose of receiving payments of interest payable on the Senior Notes underlying the Applicable Ownership Interests in Senior Notes and payments of Contract Adjustment Payments (subject to any applicable record date), performance of the Purchase Contracts and for all other purposes whatsoever, whatever or not any payments in respect thereof be overdue and notwithstanding any notice to the contrary, and neither the Company, the Purchase Contract Agent nor any such agent shall be affected by notice to the contrary.

A copy of the Purchase Contract and Pledge Agreement is available for inspection at the offices of the Purchase Contract Agent.

A-9

#### ABBREVIATIONS

The following abbreviations, when used in the inscription on the face of this instrument, shall be construed as though they were written out in full according to applicable laws or regulations:

TEN COM: as tenants in common

UNIF GIFT MIN ACT: \_\_\_\_\_ Custodian \_\_\_\_\_  
(cust) (minor)

Under Uniform Gifts to Minors Act of

TENANT: as tenants by the entirety

JT TEN: as joint tenants with right of survivorship and not as tenants in common

Additional abbreviations may also be used though not in the above list.

FOR VALUE RECEIVED, the undersigned hereby sell(s), assign(s) and transfer(s) unto

\_\_\_\_\_  
(Please insert Social Security or Taxpayer I.D. or other Identifying Number of Assignee)

\_\_\_\_\_  
(Please Print or Type Name and Address Including Postal Zip Code of Assignee)

the within Corporate Units Certificates and all rights thereunder, hereby irrevocably constituting and appointing attorney \_\_\_\_\_, to transfer said Corporate Units Certificates on the books of Genworth Financial, Inc., with full power of substitution in the premises.

Dated: \_\_\_\_\_

Signature \_\_\_\_\_

NOTICE: The signature to this assignment must correspond with the name as it appears upon the face of the within Corporate Units Certificates in every particular, without alteration or enlargement or any change whatsoever.

Signature Guarantee: \_\_\_\_\_

A-10

#### SETTLEMENT INSTRUCTIONS

The undersigned Holder directs that a certificate for shares of Common Stock deliverable upon settlement on or after the Purchase Contract Settlement Date of the Purchase Contracts underlying the number of Corporate Units evidenced by this Corporate Units Certificate be registered in the name of, and delivered, together with a check in payment for any fractional share, to the undersigned at the address indicated below unless a different name and address have been indicated below. If shares are to be registered in the name of a Person other than the undersigned, the undersigned will pay any transfer tax payable incident thereto.

Dated: \_\_\_\_\_ (if assigned to another person)

REGISTERED HOLDER

If shares are to be registered in the name of and delivered to a Person other than the Holder, please (i) print such Person's name and address and (ii) provide a guarantee of your signature:

Please print name and address of Registered Holder:

\_\_\_\_\_  
Name

\_\_\_\_\_  
Name

\_\_\_\_\_  
Address

\_\_\_\_\_  
Address

\_\_\_\_\_  
\_\_\_\_\_  
\_\_\_\_\_

Social Security or other  
Taxpayer Identification  
Number, if any

\_\_\_\_\_  
Signature

Signature Guarantee: \_\_\_\_\_

A-11

ELECTION TO SETTLE EARLY/CASH MERGER EARLY SETTLEMENT

The undersigned Holder of this Corporate Units Certificate hereby irrevocably exercises the option to effect [Early Settlement] [Cash Merger Early Settlement] in accordance with the terms of the Purchase Contract and Pledge Agreement with respect to the Purchase Contracts underlying the number of Corporate Units evidenced by this Corporate Units Certificate specified below. The option to effect [Early Settlement] [Cash Merger Early Settlement] may be exercised only with respect to Purchase Contracts underlying Corporate Units in multiples of 40 Corporate Units or an integral multiple thereof; *provided* that if Applicable Ownership Interests in the Treasury Portfolio have replaced Applicable Ownership Interests in the Senior Notes as a component of the Corporate Units, Corporate Units Holders may only effect [Early Settlement] [Cash Merger Early Settlement] in multiples of [\*] Corporate Units. The undersigned Holder directs that a certificate for shares of Common Stock or other securities deliverable upon such [Early Settlement] [Cash Merger Early Settlement] be registered in the name of, and delivered, together with a check in payment for any fractional share and any Corporate Units Certificate representing any Corporate Units evidenced hereby as to which [Early Settlement] [Cash Merger Early Settlement] of the related Purchase Contracts is not effected, to the undersigned at the address indicated below unless a different name and address have been indicated below. Senior Notes underlying Pledged Applicable Ownership Interests in Senior Notes or the Applicable Ownership Interests in the Treasury Portfolio, as the case may be, deliverable upon such [Early Settlement] [Cash Merger Early Settlement] will be transferred in accordance with the transfer instructions set forth below. If shares are to be registered in the name of a Person other than the undersigned, the undersigned will pay any transfer tax payable incident thereto.

Dated: \_\_\_\_\_

Signature \_\_\_\_\_

Signature Guarantee: \_\_\_\_\_

A-12

Number of Units evidenced hereby as to which [Early Settlement] [Cash Merger Early Settlement] of the related Purchase Contracts is being elected:

If shares of Common Stock or Corporate Units Certificates are to be registered in the name of and delivered to and Senior Notes underlying Pledged Applicable Ownership Interests in Senior Notes or the Applicable Ownership Interests in the Treasury Portfolio, as the case may be, are to be transferred to a Person other than the Holder, please print such Person's name and address:

REGISTERED HOLDER

Please print name and address of Registered Holder:

\_\_\_\_\_  
Name

\_\_\_\_\_  
Name

\_\_\_\_\_  
Address

\_\_\_\_\_  
Address

\_\_\_\_\_  
\_\_\_\_\_  
\_\_\_\_\_

Social Security or other  
Taxpayer Identification

Number, if any

A-13

Transfer Instructions for Senior Notes underlying Pledged Applicable Ownership Interests in Senior Notes or the Applicable Ownership Interests in the Treasury Portfolio, as the case may be, transferable upon [Early Settlement] [Cash Merger Early Settlement]:

A-14

[TO BE ATTACHED TO GLOBAL CERTIFICATES]

SCHEDULE OF INCREASES OR DECREASES IN GLOBAL CERTIFICATE

The initial number of Corporate Units evidenced by this Global Certificate is 24,000,000. The following increases or decreases in this Global Certificate have been made:

Date	Amount of increase in number of Corporate Units evidenced by the Global Certificate	Amount of decrease in number of Corporate Units evidenced by the Global Certificate	Number of Corporate Units evidenced by this Global Certificate following such decrease or increase	Signature of authorized signatory of Purchase Contract Agent

A-15

EXHIBIT B

(FORM OF FACE OF TREASURY UNIT CERTIFICATE)

[For inclusion in Global Certificate only - THIS CERTIFICATE IS A GLOBAL CERTIFICATE WITHIN THE MEANING OF THE PURCHASE CONTRACT AND PLEDGE AGREEMENT HEREINAFTER REFERRED TO AND IS REGISTERED IN THE NAME OF CEDE & CO., AS NOMINEE OF THE DEPOSITORY TRUST COMPANY, A NEW YORK CORPORATION (THE "DEPOSITORY"), THE DEPOSITORY OR ANOTHER NOMINEE OF THE DEPOSITORY. THIS CERTIFICATE IS EXCHANGEABLE FOR CERTIFICATES REGISTERED IN THE NAME OF A PERSON OTHER THAN THE DEPOSITORY OR ITS NOMINEE ONLY IN THE LIMITED CIRCUMSTANCES DESCRIBED IN THE PURCHASE CONTRACT AND PLEDGE AGREEMENT AND NO TRANSFER OF THIS CERTIFICATE (OTHER THAN A TRANSFER OF THIS CERTIFICATE AS A WHOLE BY THE DEPOSITORY TO A NOMINEE OF THE DEPOSITORY OR BY A NOMINEE OF THE DEPOSITORY TO THE DEPOSITORY OR ANOTHER NOMINEE OF THE DEPOSITORY) MAY BE REGISTERED EXCEPT IN LIMITED CIRCUMSTANCES.

UNLESS THIS CERTIFICATE IS PRESENTED BY AN AUTHORIZED REPRESENTATIVE OF THE DEPOSITORY FOR REGISTRATION OF TRANSFER, EXCHANGE OR PAYMENT, AND ANY CERTIFICATE ISSUED IS REGISTERED IN THE NAME OF CEDE & CO. OR SUCH OTHER NAME AS REQUESTED BY AN AUTHORIZED REPRESENTATIVE OF THE DEPOSITORY (AND ANY PAYMENT HEREON IS MADE TO CEDE & CO. OR TO SUCH OTHER ENTITY AS IS REQUESTED BY AN AUTHORIZED REPRESENTATIVE OF THE DEPOSITORY), ANY TRANSFER, PLEDGE OR OTHER USE HEREOF FOR VALUE OR OTHERWISE BY OR TO ANY PERSON IS WRONGFUL SINCE THE REGISTERED OWNER HEREOF, CEDE & CO., HAS AN INTEREST HEREIN.]

No. 1

CUSIP No. [•]

Number of Treasury Units: 0

GENWORTH FINANCIAL, INC.  
Treasury Units

This Treasury Units Certificate certifies that [ ] is the registered Holder of the number of Treasury Units set forth above [For inclusion in Global Certificates only - or such other number of Treasury Units reflected in the Schedule of Increases or Decreases in Global Certificate attached hereto, which number shall not exceed 24,000,000]. Each Treasury Unit consists of (i) a 1/40 undivided beneficial ownership interest in a Treasury Security having a principal amount at maturity equal to \$1,000, subject to the Pledge of such Treasury Security by such Holder pursuant to the Purchase Contract and Pledge Agreement, and (ii) the rights and obligations of the Holder under one Purchase Contract with the Company.

All capitalized terms used herein that are defined in the Purchase Contract and Pledge Agreement (as defined on the reverse hereof) have the meaning set forth therein.

B-1

Pursuant to the Purchase Contract and Pledge Agreement, the Treasury Securities underlying each Treasury Unit evidenced hereby have been pledged to the Collateral Agent, for the benefit of the Company, to secure the obligations of the Holder under the Purchase Contract comprising part of such Treasury Unit.

All Contract Adjustment Payments shall be paid on the dates and in the manner set forth in the Purchase Contract and Pledge Agreement. Such Contract Adjustment Payments shall be payable to the Person in whose name this Treasury Units Certificate is registered at the close of business on the Record Date for such Payment Date.

Each Purchase Contract evidenced hereby obligates the Holder of this Treasury Units Certificate to purchase, and the Company to sell, on the Purchase Contract

Settlement Date, at a Purchase Price equal to the Stated Amount, a number of newly issued shares of Common Stock of the Company, equal to the Settlement Rate, unless prior to or on the Purchase Contract Settlement Date there shall have occurred a Termination Event, an Early Settlement or a Cash Merger Early Settlement with respect to such Purchase Contract, all as provided in the Purchase Contract and Pledge Agreement. The Purchase Price for the shares of Common Stock purchased pursuant to each Purchase Contract evidenced hereby, if not paid earlier, shall be paid on the Purchase Contract Settlement Date by application of the proceeds from the Treasury Securities at maturity pledged to secure the obligations under such Purchase Contract of the Holder of the Treasury Units of which such Purchase Contract is a part.

The Company shall pay, on each Payment Date, in respect of each Purchase Contract forming part of a Corporate Unit evidenced hereby, an amount (the "Contract Adjustment Payments") equal to % per year of the Stated Amount. Such Contract Adjustment Payments shall be payable to the Person in whose name this Treasury Units Certificate is registered at the close of business on the Record Date for such Payment Date. In addition, the Company shall pay on May [ ], 2004 (the "Special Payment Date"), the Contract Adjusted Payments accrued to but excluding the Special Payment Date to the Person in whose name a Certificate is registered at the close of business on the Business Day immediately preceding the Special Payment Date. The Contract Adjustment Payments payable on the Special Payment Date shall be paid by wire transfer to the account designated by the Person entitled to receive such payment by prior notice to the Company and the Purchase Contract Agent.

Contract Adjustment Payments will be payable at the office of the Purchase Contract Agent in New York City, except that Contract Adjustment Payments with respect to Global Certificates will be made by wire transfer of immediately available funds to the Depository. If the book-entry system for the Corporate Units has been terminated, the Contract Adjustment Payments will be payable, at the option of the Company, by check mailed to the address of the Person entitled thereto at such Person's address as it appears on the Security Register, or by wire transfer to the account designated by such Person by prior written notice to the Purchase Contract Agent.

Each Purchase Contract evidenced hereby obligates the holder to agree, for United States federal, state and local income and franchise tax purposes, to (i) treat its acquisition of the Treasury Units as an acquisition of the Treasury Security and Purchase Contracts constituting the

B-2

---

Treasury Units and (ii) treat itself as the owner of the applicable interest in the Treasury Securities.

Reference is hereby made to the further provisions set forth on the reverse hereof, which further provisions shall for all purposes have the same effect as if set forth at this place.

Unless the certificate of authentication hereon has been executed by the Purchase Contract Agent by manual signature, this Treasury Units Certificate shall not be entitled to any benefit under Purchase Contract and Pledge Agreement or be valid or obligatory for any purpose.

B-3

---

IN WITNESS WHEREOF, the Company and the Holder specified above have caused this instrument to be duly executed.

GENWORTH FINANCIAL, INC.

By: \_\_\_\_\_  
Name:  
Title:

HOLDER SPECIFIED ABOVE (as to obligations of such Holder under the Purchase Contracts)

By: THE BANK OF NEW YORK, not individually but solely as attorney-in-fact or such Holder

By: \_\_\_\_\_  
Name:  
Title:

DATED: \_\_\_\_\_

CERTIFICATE OF AUTHENTICATION  
OF PURCHASE CONTRACT AGENT

This is one of the Treasury Units referred to in the within mentioned Purchase Contract and Pledge Agreement.

GENWORTH FINANCIAL, INC.

By: THE BANK OF NEW YORK,  
as Purchase Contract Agent

By: \_\_\_\_\_  
Name:  
Title:

Dated: \_\_\_\_\_

B-4

---

Each Purchase Contract evidenced hereby is governed by a Purchase Contract and Pledge Agreement, dated as of May [ ], 2004 (as may be supplemented from time to time, the “**Purchase Contract and Pledge Agreement**”) between the Company and The Bank of New York, as Purchase Contract Agent (including its successors thereunder, herein called the “**Purchase Contract Agent**”) and The Bank of New York, as Collateral Agent, Custodial Agent and Securities Intermediary, to which Purchase Contract and Pledge Agreement and supplemental agreements thereto reference is hereby made for a description of the respective rights, limitations of rights, obligations, duties and immunities thereunder of the Purchase Contract Agent, the Company and the Holders and of the terms upon which the Treasury Units Certificates are, and are to be, executed and delivered.

Each Purchase Contract evidenced hereby obligates the Holder of this Treasury Units Certificate to purchase, and the Company to sell, on the Purchase Contract Settlement Date at a price equal to the Stated Amount, a number of newly issued shares of Common Stock equal to the Settlement Rate, unless an Early Settlement, a Cash Merger Early Settlement or a Termination Event with respect to the Unit of which such Purchase Contract is a part shall have occurred. The Settlement Rate is subject to adjustment as described in the Purchase Contract and Pledge Agreement.

No fractional shares of Common Stock will be issued upon settlement of Purchase Contracts, as provided in Section 5.08 of the Purchase Contract and Pledge Agreement.

Each Purchase Contract evidenced hereby that is settled through Early Settlement or Cash Merger Early Settlement shall obligate the Holder of the related Treasury Units to purchase at the Purchase Price and the Company to sell, a number of newly issued shares of Common Stock equal to the Minimum Settlement Rate (in the case of an Early Settlement) or applicable Settlement Rate (in the case of a Cash Merger Early Settlement).

In accordance with the terms of the Purchase Contract and Pledge Agreement, the Holder of this Treasury Unit shall pay the Purchase Price for the shares of the Common Stock to be purchased pursuant to each Purchase Contract evidenced hereby either by effecting an Early Settlement or, if applicable, a Cash Merger Early Settlement of each such Purchase Contract or by applying the proceeds of the Pledged Treasury Securities underlying such Holder’s Treasury Unit equal to the Purchase Price for such Purchase Contract to the purchase of the Common Stock.

The Company shall not be obligated to issue any shares of Common Stock in respect of a Purchase Contract or deliver any certificates therefor to the Holder unless it shall have received payment of the aggregate Purchase Price for the shares of Common Stock to be purchased thereunder in the manner set forth in the Purchase Contract and Pledge Agreement.

Each Purchase Contract evidenced hereby and all obligations and rights of the Company and the Holder thereunder, shall terminate if a Termination Event shall occur. Upon the occurrence of a Termination Event, the Company shall give written notice to the Purchase Contract Agent and the Holders, at their addresses as they appear in the Security Register. Upon

B-5

---

and after the occurrence of a Termination Event, the Collateral Agent shall release the Treasury Securities underlying each Treasury Unit from the Pledge. A Treasury Unit shall thereafter represent the right to receive the Treasury Security underlying such Treasury Unit, in accordance with the terms of the Purchase Contract and Pledge Agreement.

The Treasury Units Certificates are issuable only in registered form and only in denominations of a single Treasury Unit and any integral multiple thereof. The transfer of any Treasury Units Certificate will be registered and Treasury Units Certificates may be exchanged as provided in the Purchase Contract and Pledge Agreement. A Holder who elects to substitute Senior Notes or Applicable Ownership Interests in the Treasury Portfolio, as the case may be, for Treasury Securities, thereby recreating Corporate Units, shall be responsible for any fees or expenses payable in connection therewith. Except as provided in the Purchase Contract and Pledge Agreement, such Treasury Unit shall not be separable into its constituent parts, and the rights and obligations of the Holder of such Treasury Unit in respect of the Treasury Security and the Purchase Contract constituting such Treasury Unit may be transferred and exchanged only as a Treasury Unit.

Subject to, and in compliance with, the conditions and terms set forth in the Purchase Contract and Pledge Agreement, the Holder of Treasury Units may effect a Collateral Substitution. From and after such substitution, each Unit for which Pledged Applicable Ownership Interests in Senior Notes, or Pledged Applicable Ownership Interests in the Treasury Portfolio, as the case may be, secure the Holder’s obligation under the Purchase Contract shall be referred to as a “Corporate Unit”. A Holder may make such Collateral substitution only in multiples of 40 Treasury Units for 40 Corporate Units. If Applicable Ownership Interests in the Treasury Portfolio have replaced the Applicable Ownership Interests in Senior Notes as a component of the Corporate Units, a Holder may substitute Applicable Ownership Interests in the Treasury Portfolio for Treasury Securities only in integral multiples of [•] Treasury Units.

Subject to and upon compliance with the provisions of the Purchase Contract and Pledge Agreement, at the option of the Holder thereof, Purchase Contracts underlying Units may be settled early by effecting an Early Settlement as provided in the Purchase Contract and Pledge Agreement in integral multiples of 40 Treasury Units.

Upon Early Settlement of Purchase Contracts by a Holder of the related Units, the Pledged Treasury Securities underlying such Units shall be released from the Pledge as provided in the Purchase Contract and Pledge Agreement and the Holder shall be entitled to receive a number of shares of Common Stock on account of each Purchase Contract forming part of a Treasury Unit as to which Early Settlement is effected equal to the Minimum Settlement Rate.

Upon the occurrence of a Cash Merger, a Holder of Treasury Units may effect Cash Merger Early Settlement of the Purchase Contracts underlying such Treasury Units pursuant to the terms of the Purchase Contract and Pledge Agreement in integral multiples of 40 Treasury Units. Upon Cash Merger Early Settlement of Purchase Contracts by a Holder of the related Treasury Units, the Pledged Treasury Securities underlying such Treasury Units shall be released from the Pledge as provided in the Purchase Contract and Pledge Agreement and the Holder shall be entitled to receive a number of shares of Common Stock on account of each Purchase

B-6

---

Contract forming part of a Corporate Unit as to which Cash Merger Early Settlement is effected equal to the applicable Settlement Rate..

Upon registration of transfer of this Treasury Units Certificate, the transferee shall be bound (without the necessity of any other action on the part of such transferee, except as may be required by the Purchase Contract Agent pursuant to the Purchase Contract and Pledge Agreement), under the terms of the Purchase Contract and Pledge Agreement and the Purchase Contracts evidenced hereby and the transferor shall be released from the obligations under the Purchase Contracts evidenced by this Treasury Units Certificate. The Company covenants and agrees, and the Holder, by its acceptance hereof, likewise covenants and agrees, to be bound by the provisions of this paragraph.

The Holder of this Treasury Units Certificate, by its acceptance hereof, authorizes the Purchase Contract Agent to enter into and perform the related Purchase Contracts forming part of the Treasury Units evidenced hereby on its behalf as its attorney-in-fact, expressly withholds any consent to the assumption (i.e., affirmation) of the Purchase Contracts by the Company or its trustee in the event that the Company becomes the subject of a case under the Bankruptcy Code, agrees to be bound by the terms and provisions thereof, covenants and agrees to perform its obligations under such Purchase Contracts, consents to the provisions of the Purchase Contract and Pledge Agreement, authorizes the Purchase Contract Agent to enter into and perform the Purchase Contract and Pledge Agreement on its behalf as its attorney-in-fact, and consents to the Pledge of the Treasury Securities underlying this Treasury Units Certificate pursuant to the Purchase Contract and Pledge Agreement. The Holder further covenants and

agrees, that, to the extent and in the manner provided in the Purchase Contract and Pledge Agreement, but subject to the terms thereof, payments in respect to the aggregate principal amount at maturity of the Pledged Treasury Securities on the Purchase Contract Settlement Date equal to the aggregate Purchase Price for the related Purchase Contracts shall be paid by the Collateral Agent to the Company in satisfaction of such Holder's obligations under such Purchase Contracts and such Holder shall acquire no right, title or interest in such payments.

Subject to certain exceptions, the provisions of the Purchase Contract and Pledge Agreement may be amended with the consent of the Holders of a majority of the Purchase Contracts.

The Purchase Contracts shall be governed by, and construed in accordance with, the laws of the State of New York, without giving effect to the conflicts of law provisions thereof to the extent a different law would govern as a result.

The Purchase Contracts shall not, prior to the settlement thereof, entitle the Holder to any of the rights of a holder of shares of Common Stock.

Prior to due presentment of this Certificate for registration of transfer, the Company, the Purchase Contract Agent and its Affiliates and any agent of the Company or the Purchase Contract Agent may treat the Person in whose name this Treasury Units Certificate is registered as the owner of the Treasury Units evidenced hereby for the purpose of receiving payments of Contract Adjustment Payments (subject to any applicable record date), performance of the Purchase Contracts and for all other purposes whatsoever, whatever or not any payments in

B-7

---

respect thereof be overdue and notwithstanding any notice to the contrary, and neither the Company, the Purchase Contract Agent nor any such agent shall be affected by notice to the contrary.

A copy of the Purchase Contract and Pledge Agreement is available for inspection at the offices of the Purchase Contract Agent.

B-8

---

#### ABBREVIATIONS

The following abbreviations, when used in the inscription on the face of this instrument, shall be construed as though they were written out in full according to applicable laws or regulations:

TEN COM: as tenants in common

UNIF GIFT MIN ACT: \_\_\_\_\_ Custodian \_\_\_\_\_  
(cust) (minor)

Under Uniform Gifts to Minors Act of

TENANT: as tenants by the entireties

JT TEN: as joint tenants with right of survivorship and not as tenants in common  
Additional abbreviations may also be used though not in the above list.

FOR VALUE RECEIVED, the undersigned hereby sell(s), assign(s) and transfer(s) unto

\_\_\_\_\_  
(Please insert Social Security or Taxpayer I.D. or other Identifying Number of Assignee)

\_\_\_\_\_  
(Please Print or Type Name and Address Including Postal Zip Code of Assignee)

the within Treasury Units Certificates and all rights thereunder, hereby irrevocably constituting and appointing attorney \_\_\_\_\_, to transfer said Treasury Units Certificates on the books of Genworth Financial, Inc., with full power of substitution in the premises.

Dated: \_\_\_\_\_ Signature \_\_\_\_\_

NOTICE: The signature to this assignment must correspond with the name as it appears upon the face of the within Treasury Units Certificates in every particular, without alteration or enlargement or any change whatsoever.

Signature Guarantee: \_\_\_\_\_

B-9

---

#### SETTLEMENT INSTRUCTIONS

The undersigned Holder directs that a certificate for shares of Common Stock deliverable upon settlement on or after the Purchase Contract Settlement Date of the Purchase Contracts underlying the number of Treasury Units evidenced by this Treasury Units Certificate be registered in the name of, and delivered, together with a check in payment for any fractional share, to the undersigned at the address indicated below unless a different name and address have been indicated below. If shares are to be registered in the name of a Person other than the undersigned, the undersigned will pay any transfer tax payable incident thereto.

Dated: \_\_\_\_\_ (if assigned to another person)

If shares are to be registered in the name of and delivered to a Person other than the Holder, please (i) print such Person's name and address and (ii) provide a guarantee of your signature:

REGISTERED HOLDER

Please print name and address of Registered Holder:

Name

Name

Address

Address

Social Security or other  
Taxpayer Identification

Number, if any

Signature

Signature Guarantee:

B-10

ELECTION TO SETTLE EARLY/CASH MERGER EARLY SETTLEMENT

The undersigned Holder of this Treasury Units Certificate hereby irrevocably exercises the option to effect [Early Settlement] [Cash Merger Early Settlement] in accordance with the terms of the Purchase Contract and Pledge Agreement with respect to the Purchase Contracts underlying the number of Treasury Units evidenced by this Treasury Units Certificate specified below. The option to effect [Early Settlement] [Cash Merger Early Settlement] may be exercised only with respect to Purchase Contracts underlying Treasury Units in multiples of 40 Treasury Units or an integral multiple thereof. The undersigned Holder directs that a certificate for shares of Common Stock or other securities deliverable upon such [Early Settlement] [Cash Merger Early Settlement] be registered in the name of, and delivered, together with a check in payment for any fractional share and any Treasury Units Certificate representing any Treasury Units evidenced hereby as to which [Early Settlement] [Cash Merger Early Settlement] of the related Purchase Contracts is not effected, to the undersigned at the address indicated below unless a different name and address have been indicated below. Pledged Treasury Securities deliverable upon such [Early Settlement] [Cash Merger Early Settlement] will be transferred in accordance with the transfer instructions set forth below. If shares are to be registered in the name of a Person other than the undersigned, the undersigned will pay any transfer tax payable incident thereto.

Dated: \_\_\_\_\_

Signature \_\_\_\_\_

Signature Guarantee: \_\_\_\_\_

B-11

Number of Units evidenced hereby as to which [Early Settlement] [Cash Merger Early Settlement] of the related Purchase Contracts is being elected:

Please print name and address of Registered Holder:

If shares of Common Stock or Treasury Units Certificates are to be registered in the name of and delivered to and Pledged Treasury Securities, as the case may be, are to be transferred to a Person other than the Holder, please print such Person's name and address:

Name

Name

Address

Address

Social Security or other  
Taxpayer Identification

Number, if any

REGISTERED HOLDER

B-12

[TO BE ATTACHED TO GLOBAL CERTIFICATES]

SCHEDULE OF INCREASES OR DECREASES IN GLOBAL CERTIFICATE

The initial number of Treasury Units evidenced by this Global Certificate is 0. The following increases or decreases in this Global Certificate have been made:

Date	Amount of increase in number of Corporate Units evidenced by the Global Certificate	Amount of decrease in number of Corporate Units evidenced by the Global Certificate	Number of Corporate Units evidenced by this Global Certificate following such decrease or increase	Signature of authorized signatory of Purchase Contract Agent

EXHIBIT C

INSTRUCTION TO PURCHASE CONTRACT AGENT FROM HOLDER  
(To Create Treasury Units or Corporate Units)

The Bank of New York,  
as Purchase Contract Agent  
101 Barclay Street, 8W  
New York, NY 10286

Attention: [•]

Fax: [•]

**Re:** [ Corporate Units] Treasury Units] of Genworth Financial, Inc., a Delaware corporation (the ‘**Company**’).

The undersigned Holder hereby notifies you that it has delivered to [ ], as Securities Intermediary, for credit to the Collateral Account, \$ Value of [Senior Notes] [Applicable Ownership Interests in the Treasury Portfolio] [Treasury Securities] in exchange for an equal Value of [Pledged Treasury Securities] [Senior Notes underlying Pledged Applicable Ownership Interests in Senior Notes] [Pledged Applicable Ownership Interests in the Treasury Portfolio] held in the Collateral Account, in accordance with the Purchase Contract and Pledge Agreement, dated as of May [•], 2004 (the ‘**Agreement**’; unless otherwise defined herein, terms defined in the Agreement are used herein as defined therein), among you, the Company, the Collateral Agent, the Custodial Agent and the Securities Intermediary. The undersigned Holder has paid all applicable fees and expenses relating to such exchange. The undersigned Holder hereby instructs you to instruct the Collateral Agent to release to you on behalf of the undersigned Holder the [Senior Notes underlying Pledged Applicable Ownership Interests in Senior Notes] [Pledged Applicable Ownership Interests in the Treasury Portfolio] [Pledged Treasury Securities] related to such [Corporate Units] [Treasury Units].

Date: \_\_\_\_\_

Signature \_\_\_\_\_

Signature Guarantee: \_\_\_\_\_

Please print name and address of Registered Holder:

\_\_\_\_\_  
Name

\_\_\_\_\_  
Social Security or other Taxpayer  
Identification Number, if any

\_\_\_\_\_  
Address  
\_\_\_\_\_  
\_\_\_\_\_  
\_\_\_\_\_

EXHIBIT D

NOTICE FROM PURCHASE CONTRACT AGENT  
TO HOLDERS UPON TERMINATION EVENT



[HOLDER]

Attention:  
Telecopy:

Re: [ Corporate Units] [ Treasury Units] of Genworth Financial, Inc., an Delaware corporation (the "Company")

Please refer to the Purchase Contract and Pledge Agreement, dated as of May [•], 2004 (the "Purchase Contract and Pledge Agreement"; unless otherwise defined herein, terms defined in the Purchase Contract and Pledge Agreement are used herein as defined therein), between the Company and the undersigned, as Purchase Contract Agent and as attorney-in-fact for the holders of Corporate Units and Treasury Units from time to time.

We hereby notify you that a Termination Event has occurred and that [the Senior Notes underlying the Pledged Applicable Ownership Interests in Senior Notes] [the Pledged Applicable Ownership Interests in the Treasury Portfolio] [the Treasury Securities] compromising a portion of your ownership interest in [Corporate Units] [Treasury Units] have been released and are being held by us for your account pending receipt of transfer instructions with respect to such [Senior Notes] [Pledged Applicable Ownership Interests in the Treasury Portfolio] [Pledged Treasury Securities] (the "Released Securities").

Pursuant to Section 3.15 of the Purchase Contract and Pledge Agreement, we hereby request written transfer instructions with respect to the Released Securities. Upon receipt of your instructions and upon transfer to us of your [Corporate Units] [Treasury Units] effected through book-entry or by delivery to us of your [Corporate Units Certificate] [Treasury Units Certificate], we shall transfer the Released Securities by book-entry transfer or other appropriate procedures, in accordance with your instructions. In the event you fail to effect such transfer or delivery, the Released Securities and any distributions thereon, shall be held in our name, or a nominee in trust for your benefit, until such time as such [Corporate Units] [Treasury Units] are transferred or your [Corporate Units Certificate] [Treasury Units Certificate] is surrendered or satisfactory evidence is provided that such [Corporate Units Certificate] [Treasury Units Certificate] has been destroyed, lost or stolen, together with any indemnification that we or the Company may require.

D-1

Date: \_\_\_\_\_ By: THE BANK OF NEW YORK,  
as the Purchase Contract Agent

Name: \_\_\_\_\_  
Title: Authorized Signatory

D-2

EXHIBIT E

NOTICE TO SETTLE BY SEPARATE CASH

The Bank of New York,  
as Purchase Contract Agent  
101 Barclay Street, 8W  
New York, NY 10286

Attention: [•]

Fax: [•]

Re: Corporate Units of Genworth Financial, Inc., a Delaware corporation (the "Company")

The undersigned Holder hereby irrevocably notifies you in accordance with Section 5.02 of the Purchase Contract and Pledge Agreement, dated as of May [•], 2004 (the "Purchase Contract and Pledge Agreement"; unless otherwise defined herein, terms defined in the Purchase Contract and Pledge Agreement are used herein as defined therein), between the Company and you, as Purchase Contract Agent and as attorney-in-fact for the Holders of the Corporate Units and as Collateral Agent, Custodial Agent and Securities Intermediary, that such Holder has elected to pay to the Securities Intermediary for deposit in the Collateral Account, prior to 5:00 p.m. (New York City time) on the sixth Business Day immediately preceding the Purchase Contract Settlement Date (in lawful money of the United States by certified or cashiers' check or wire transfer, in immediately available funds payable to or upon the order of the Securities Intermediary), \$ \_\_\_\_\_ as the Purchase Price for the shares of Common Stock issuable to such Holder by the Company with respect to \_\_\_\_\_ Purchase Contracts on the Purchase Contract Settlement Date. The undersigned Holder hereby instructs you to notify promptly the Collateral Agent of the undersigned Holders' election to make such Cash Settlement with respect to the Purchase Contracts related to such Holder's Corporate Units.

Date: \_\_\_\_\_

Signature \_\_\_\_\_

Signature Guarantee: \_\_\_\_\_

Please print name and address of Registered Holder:

\_\_\_\_\_  
\_\_\_\_\_

E-1

EXHIBIT F

INSTRUCTION  
FROM PURCHASE CONTRACT AGENT  
TO COLLATERAL AGENT  
(Creation of Treasury Units)

The Bank of New York,  
as Collateral Agent  
101 Barclay Street, 8W  
New York, NY 10286  
Attention: [•]  
Fax: [•]

Re: Corporate Units of Genworth Financial, Inc. (the "Company")

Please refer to the Purchase Contract and Pledge Agreement, dated as of May [•], 2004 (the "Agreement"), among the Company, you, as Collateral Agent, as Securities Intermediary and as Custodial Agent and the undersigned, as Purchase Contract Agent and as attorney-in-fact for the holders of Corporate Units from time to time. Capitalized terms used herein but not defined shall have the meaning set forth in the Agreement.

We hereby notify you in accordance with Section 3.13 of the Agreement that the holder of securities named below (the "Holder") has elected to substitute \$ Value of Treasury Securities or security entitlements with respect thereto in exchange for an equal Value of [Senior Notes underlying Pledged Applicable Ownership Interests in Senior Notes] [Pledged Applicable Ownership Interests in the Treasury Portfolio] relating to Corporate Units and has delivered to the undersigned a notice stating that the Holder has Transferred such Treasury Securities or security entitlements with respect thereto to the Securities Intermediary, for credit to the Collateral Account.

We hereby request that you instruct the Securities Intermediary, upon confirmation that such Treasury Securities or security entitlements thereto have been credited to the Collateral Account, to release to the undersigned an equal Value of [Senior Notes underlying Pledged Applicable Ownership Interests in Senior Notes] [Pledged Applicable Ownership Interests in the Treasury Portfolio] or security entitlements with respect thereto related to Corporate Units of such Holder in accordance with Section 3.13 of the Agreement.

Date: \_\_\_\_\_

THE BANK OF NEW YORK, as Purchase Contract Agent and as attorney-in-fact of the Holders from time to time of the Units

By: \_\_\_\_\_  
Name:  
Title:  
Authorized Signatory

Please print name and address of Holder electing to substitute Treasury Securities or security entitlements with respect thereto for the [Senior Notes underlying Pledged Applicable Ownership Interests in Senior Notes] [Pledged Applicable Ownership Interests in the Treasury Portfolio]:

\_\_\_\_\_  
Name: \_\_\_\_\_ Social Security or other Taxpayer Identification Number, if any  
\_\_\_\_\_  
Address  
\_\_\_\_\_  
\_\_\_\_\_

INSTRUCTION  
FROM COLLATERAL AGENT  
TO SECURITIES INTERMEDIARY  
(Creation of Treasury Units)

The Bank of New York,  
as Securities Intermediary  
101 Barclay Street, 8W  
New York, NY 10286  
Attention: [•]

Fax: [•]

Re: Corporate Units of Genworth Financial, Inc. (the "Company")

The securities account of The Bank of New York, as Collateral Agent, maintained by the Securities Intermediary and designated "The Bank of New York, as Collateral Agent of Genworth Financial, Inc., as pledgee of The Bank of New York, as the Purchase Contract Agent on behalf of and as attorney-in-fact for the Holders" (the "Collateral Account")

Please refer to the Purchase Contract and Pledge Agreement, dated as of May [•], 2004 (the "Agreement"), among the Company, you, as Collateral Agent, as Securities Intermediary and as Custodial Agent and the undersigned, as Purchase Contract Agent and as attorney-in-fact for the holders of Corporate Units from time to time. Capitalized terms used herein but not defined shall have the meaning set forth in the Agreement.

When you have confirmed that \$ Value of Treasury Securities or security entitlements with respect thereto has been credited to the Collateral Account by or for the benefit of , as Holder of Corporate Units (the "Holder"), you are hereby instructed to release from the Collateral Account an equal Value of [Senior Notes underlying Pledged Applicable Ownership Interests in Senior Notes] [Pledged Applicable Ownership Interests in the Treasury Portfolio] or security entitlements with respect thereto relating to Corporate Units of the Holder by Transfer to the Purchase Contract Agent.

H-1

Dated:

THE BANK OF NEW YORK,  
as Collateral Agent

By: \_\_\_\_\_  
Name:  
Title:  
Authorized Signatory

H-2

**EXHIBIT I**

**INSTRUCTION  
FROM PURCHASE CONTRACT AGENT  
TO COLLATERAL AGENT  
(Recreation of Corporate Units)**

The Bank of New York,  
as Collateral Agent  
101 Barclay Street, 8W  
New York, NY 10286  
Attention: [•]  
Fax: [•]

Re: Treasury Units of Genworth Financial, Inc. (the "Company")

Please refer to the Purchase Contract and Pledge Agreement dated as of May [•], 2004 (the "Agreement"), among the Company, you, as Collateral Agent, as Securities Intermediary and as Custodial Agent and the undersigned, as Purchase Contract Agent and as attorney-in-fact for the holders of Treasury Units from time to time. Capitalized terms used herein but not defined shall have the meaning set forth in the Agreement.

We hereby notify you in accordance with Section 3.14 of the Agreement that the holder of securities named below (the "Holder") has elected to substitute \$Value of [Senior Notes] [Applicable Ownership Interests in the Treasury Portfolio] or security entitlements with respect thereto in exchange for \$ Value of Pledged Treasury Securities relating to Treasury Units and has delivered to the undersigned a notice stating that the holder has Transferred such [Senior Notes] [Applicable Ownership Interests in the Treasury Portfolio] or security entitlements with respect thereto to the Securities Intermediary, for credit to the Collateral Account.

I-1

We hereby request that you instruct the Securities Intermediary, upon confirmation that such [Senior Notes] [Applicable Ownership Interests in the Treasury Portfolio] or security entitlements with respect thereto have been credited to the Collateral Account, to release to the undersigned \$ Value of Treasury Securities or security entitlements with respect thereto related to Treasury Units of such Holder in accordance with Section 3.14 of the Agreement.

THE BANK OF NEW YORK,  
as Purchase Contract Agent

Dated: \_\_\_\_\_

By: \_\_\_\_\_  
Name:  
Title:  
Authorized Signatory

I-2

\_\_\_\_\_  
Name:  
\_\_\_\_\_  
Address  
\_\_\_\_\_  
\_\_\_\_\_

\_\_\_\_\_  
Social Security or other Taxpayer  
Identification Number, if any

I-3

EXHIBIT J

**INSTRUCTION  
FROM COLLATERAL AGENT  
TO SECURITIES INTERMEDIARY**  
(Recreation of Corporate Units)

The Bank of New York,  
as Securities Intermediary  
101 Barclay Street, 8W  
New York, NY 10286  
Attention: [•]  
Fax: [•]

Re: Treasury Units of Genworth Financial, Inc. (the "**Company**")

The securities account of The Bank of New York, as Collateral Agent, maintained by the Securities Intermediary and designated "The Bank of New York, as Collateral Agent of Genworth Financial, Inc., as pledgee of The Bank of New York, as the Purchase Contract Agent on behalf of and as attorney-in-fact for the Holders" (the "**Collateral Account**")

Please refer to the Purchase Contract and Pledge Agreement dated as of May [•], 2004 (the "**Agreement**"), among the Company, you, as Securities Intermediary, Custodial Agent and Collateral Agent and The Bank of New York, as Purchase Contract Agent and as attorney-in-fact for the holders of Treasury Units from time to time. Capitalized terms used herein but not defined shall have the meaning set forth in the Agreement.

When you have confirmed that \$ \_\_\_\_\_ Value of [Senior Notes] [Applicable Ownership Interests in the Treasury Portfolio] or security entitlements with respect thereto has been credited to the Collateral Account by or for the benefit of \_\_\_\_\_, as Holder of Treasury Units (the "**Holder**"), you are hereby instructed to release from the Collateral Account \$ \_\_\_\_\_ Value of Treasury Securities or security entitlements thereto by Transfer to the Purchase Contract Agent.

J-1

THE BANK OF NEW YORK,  
as Collateral Agent

Dated: \_\_\_\_\_

By: \_\_\_\_\_  
Name:  
Title:  
Authorized Signatory

J-2

EXHIBIT K

**NOTICE OF CASH SETTLEMENT FROM COLLATERAL  
AGENT TO PURCHASE CONTRACT AGENT**  
(Cash Settlement Amounts)

The Bank of New York,  
as Purchase Contract Agent  
101 Barclay Street, 8W  
New York, NY 10286  
Attention: [•]  
Fax: [•]

Re: Corporate Units of Genworth Financial, Inc. (the "**Company**")

Please refer to the Purchase Contract and Pledge Agreement dated as of May [•], 2004 (the "**Agreement**"), by and among you, the Company, and The Bank of New York, as Collateral Agent, Custodial Agent and Securities Intermediary. Unless otherwise defined herein, terms defined in the Agreement are used herein as defined therein.

In accordance with Section 5.02(a)(iv) of the Agreement, we hereby notify you that as of 5:00 p.m. (New York City time) on the sixth Business Day immediately preceding [•], 2007 (the "**Purchase Contract Settlement Date**"), we have received (i) \$ \_\_\_\_\_ in immediately available funds paid in an aggregate amount equal to the Purchase Price due to the Company on the Purchase Contract Settlement Date with respect to \_\_\_\_\_ Corporate Units and (ii) based on the funds received set forth in clause (i) above, an aggregate principal amount of \$ \_\_\_\_\_ of Senior Notes underlying Pledged Applicable Ownership Interests in Senior Notes are to be

offered for purchase in each Remarketing.

K-1

THE BANK OF NEW YORK,  
as Collateral Agent

Dated: \_\_\_\_\_

By: \_\_\_\_\_  
Name:  
Title:  
Authorized Signatory

K-2

EXHIBIT L

**INSTRUCTION TO CUSTODIAL AGENT REGARDING REMARKETING**

The Bank of New York,  
as Custodial Agent  
101 Barclay Street, 8W  
New York, NY 10286  
Attention: [•]  
Fax: [•]

Re: Senior Notes Due 2009 of Genworth Financial, Inc. (the "Company")

The undersigned hereby notifies you in accordance with Section 5.02(b)(ii) of the Purchase Contract and Pledge Agreement, dated as of May 1, 2004 (the "Agreement"), among the Company, you, as Collateral Agent, Custodial Agent and Securities Intermediary and The Bank of New York, as the Purchase Contract Agent and as attorney-in-fact for the holders of Corporate Units and Treasury Units from time to time, that the undersigned elects to deliver \$ \_\_\_\_\_ aggregate principal amount of Separate Senior Notes for delivery to the Remarketing Agent prior to 5:00 p.m. (New York City time) on the seventh Business Day immediately preceding the Purchase Contract Settlement Date for remarketing pursuant to Section 5.02(b)(ii) of the Agreement. The undersigned will, upon request of the Remarketing Agent, execute and deliver any additional documents deemed by the Remarketing Agent or by the Company to be necessary or desirable to complete the sale, assignment and transfer of the Separate Senior Notes tendered hereby. Capitalized terms used herein but not defined shall have the meaning set forth in the Agreement.

The undersigned hereby instructs you, upon receipt of the Proceeds of a Successful Remarketing from the Remarketing Agent, to deliver such Proceeds to the undersigned in accordance with the instructions indicated herein under "A. Payment Instructions." The undersigned hereby instructs you, in the event of a Failed Final Remarketing, upon receipt of the Separate Senior Notes tendered herewith from the Remarketing Agent, to deliver such Separate Senior Notes to the person(s) and the address(es) indicated herein under "B. Delivery Instructions."

With this notice, the undersigned hereby (i) represents and warrants that the undersigned has full power and authority to tender, sell, assign and transfer the Separate Senior Notes tendered hereby and that the undersigned is the record owner of any Separate Senior Notes tendered herewith in physical form or a participant in The Depository Trust Company ("DTC") and the beneficial owner of any Separate Senior Notes tendered herewith by book-entry transfer to your account at DTC, (ii) agrees to be bound by the terms and conditions of Section 5.02(b) of the Agreement and (iii) acknowledges and agrees that after 5:00 p.m. (New York City time) on the seventh Business Day immediately preceding the Purchase Contract Settlement Date, such election shall become an irrevocable election to have such Separate Senior Notes remarketed in

L-1

each Remarketing, and that the Separate Senior Notes tendered herewith will only be returned in the event of a Failed Final Remarketing.

Date: \_\_\_\_\_

By: \_\_\_\_\_  
Name:  
Title:

Signature Guarantee: \_\_\_\_\_

\_\_\_\_\_  
Name

\_\_\_\_\_  
Social Security or other Taxpayer Identification Number, if any

\_\_\_\_\_  
Address

L-2

**A. PAYMENT INSTRUCTIONS**

Proceeds of a Successful Remarketing should be paid by check in the name of the person(s) set forth below and mailed to the address set forth below.

Name(s)

(Please Print)  
Address

(Please Print)

(Zip Code)

(Tax Identification or Social Security Number)

**B. DELIVERY INSTRUCTIONS**

In the event of a Failed Final Remarketing, Senior Notes which are in physical form should be delivered to the person(s) set forth below and mailed to the address set forth below.

Name(s)

(Please Print)

Address

(Please Print)

(Zip Code)

(Tax Identification or Social Security Number)

L-3

---

In the event of a Failed Final Remarketing, Senior Notes which are in book-entry form should be credited to the account at The Depository Trust Company set forth below.

DTC Account Number

Name of Account Party:

L-4

---

**EXHIBIT M**

**INSTRUCTION TO CUSTODIAL AGENT REGARDING  
WITHDRAWAL FROM REMARKETING**

The Bank of New York,  
as Custodial Agent  
101 Barclay Street, 8W  
New York, NY 10286  
Attention: [•]  
Fax: [•]

Re: Senior Notes Due 2009 of Genworth Financial, Inc. (the "Company")

The undersigned hereby notifies you in accordance with Section 5.02(b)(ii) of the Purchase Contract and Pledge Agreement, dated as of May 1, 2004 (the "Agreement"), among the Company and you, as Collateral Agent, Custodial Agent and Securities Intermediary, and The Bank of New York, as Purchase Contract Agent and as attorney-in-fact for the holders of Corporate Units and Treasury Units from time to time, that the undersigned elects to withdraw the \$ \_\_\_\_\_ aggregate principal amount of Separate Senior Notes delivered to you for Remarketing pursuant to Section 5.02 of the Agreement. The undersigned hereby instructs you to return such Separate Senior Notes to the undersigned in accordance with the undersigned's instructions. With this notice, the Undersigned hereby agrees to be bound by the terms and conditions of Section 5.02(b) of the Agreement. Capitalized terms used herein but not defined shall have the meaning set forth in the Agreement.

Date: \_\_\_\_\_

By: \_\_\_\_\_  
Name:  
Title:

Signature Guarantee: \_\_\_\_\_

\_\_\_\_\_  
Name

\_\_\_\_\_  
Social Security or other Taxpayer  
Identification Number, if any

---

Address

M-1

---

MASTER AGREEMENT  
AMONG  
GENERAL ELECTRIC COMPANY,  
GENERAL ELECTRIC CAPITAL CORPORATION,  
GEI, INC.,  
GE FINANCIAL ASSURANCE HOLDINGS, INC.  
AND  
GENWORTH FINANCIAL, INC.

Dated May , 2004

---

**TABLE OF CONTENTS**

<a href="#"><u>ARTICLE I</u></a>	<a href="#"><u>DEFINITIONS</u></a>
<a href="#"><u>1.1</u></a>	<a href="#"><u>Certain Definitions</u></a>
<a href="#"><u>1.2</u></a>	<a href="#"><u>Other Terms</u></a>
<a href="#"><u>ARTICLE II</u></a>	<a href="#"><u>THE SEPARATION</u></a>
<a href="#"><u>2.1</u></a>	<a href="#"><u>Transfer of Assets; Assumption of Liabilities; Consideration</u></a>
<a href="#"><u>2.2</u></a>	<a href="#"><u>Genworth Assets</u></a>
<a href="#"><u>2.3</u></a>	<a href="#"><u>Genworth Liabilities</u></a>
<a href="#"><u>2.4</u></a>	<a href="#"><u>Termination of Agreements</u></a>
<a href="#"><u>2.5</u></a>	<a href="#"><u>DISCLAIMER OF REPRESENTATIONS AND WARRANTIES</u></a>
<a href="#"><u>2.6</u></a>	<a href="#"><u>Governmental Approvals and Consents; Delayed Transfer Assets and Liabilities</u></a>
<a href="#"><u>2.7</u></a>	<a href="#"><u>Novation of Assumed Genworth Liabilities</u></a>
<a href="#"><u>2.8</u></a>	<a href="#"><u>Novation of Liabilities other than Genworth Liabilities</u></a>
<a href="#"><u>2.9</u></a>	<a href="#"><u>European Creditor Business</u></a>
<a href="#"><u>2.10</u></a>	<a href="#"><u>FACL Bonds</u></a>
<a href="#"><u>ARTICLE III</u></a>	<a href="#"><u>INTERCOMPANY TRANSACTIONS AS OF THE CLOSING DATE</u></a>
<a href="#"><u>3.1</u></a>	<a href="#"><u>Time and Place of Closing</u></a>
<a href="#"><u>3.2</u></a>	<a href="#"><u>Pre-Closing Transactions</u></a>
<a href="#"><u>3.3</u></a>	<a href="#"><u>Closing Transactions</u></a>
<a href="#"><u>3.4</u></a>	<a href="#"><u>Amended and Restated Certificate of Incorporation and Amended and Restated Bylaws</u></a>
<a href="#"><u>3.5</u></a>	<a href="#"><u>Transfers of Assets and Assumption of Liabilities</u></a>
<a href="#"><u>3.6</u></a>	<a href="#"><u>Transfer of Excluded Assets; Assumption of Excluded Liabilities</u></a>
<a href="#"><u>3.7</u></a>	<a href="#"><u>The Initial Public Offering and the Concurrent Offerings</u></a>
<a href="#"><u>3.8</u></a>	<a href="#"><u>Rescission</u></a>
<a href="#"><u>3.9</u></a>	<a href="#"><u>European Transfers</u></a>



[3.10](#) [Tax Matters](#)

[ARTICLE IV](#) [FINANCIAL AND OTHER INFORMATION](#)

[4.1](#) [Annual Financial Information](#)

i

---

**TABLE OF CONTENTS**  
**(continued)**

[4.2](#) [Quarterly Financial Information](#)

[4.3](#) [GE's Operating Reviews](#)

[4.4](#) [General Financial Statement Requirements](#)

[4.5](#) [Twenty Percent Threshold](#)

[4.6](#) [GE Public Filings](#)

[4.7](#) [GE Annual Statements](#)

[4.8](#) [Fifty Percent Threshold](#)

[4.9](#) [Accountants' Reports](#)

[4.10](#) [Agreement for Exchange of Information; Archives](#)

[4.11](#) [Ownership of Information](#)

[4.12](#) [Compensation for Providing Information](#)

[4.13](#) [Record Retention](#)

[4.14](#) [Liability](#)

[4.15](#) [Other Agreements Providing for Exchange of Information](#)

[4.16](#) [Production of Witnesses; Records; Cooperation](#)

[4.17](#) [Privilege](#)

[ARTICLE V](#) [RELEASE; INDEMNIFICATION](#)

[5.1](#) [Release of Pre-Closing Claims](#)

[5.2](#) [General Indemnification by Genworth](#)

[5.3](#) [General Indemnification by GE](#)

[5.4](#) [Registration Statement Indemnification](#)

[5.5](#) [Contribution](#)

[5.6](#) [Indemnification Obligations Net of Insurance Proceeds and Other Amounts, On an After-Tax Basis](#)

[5.7](#) [Procedures for Indemnification of Third Party Claims](#)

[5.8](#) [Additional Matters](#)

[5.9](#) [Remedies Cumulative; Limitations of Liability](#)

[5.10](#) [Survival of Indemnities](#)

[ARTICLE VI](#) [OTHER AGREEMENTS](#)

[6.1](#) [Further Assurances](#)

ii

---

**TABLE OF CONTENTS**  
**(continued)**

<a href="#">6.2</a>	<a href="#">Confidentiality</a>
<a href="#">6.3</a>	<a href="#">Insurance Matters</a>
<a href="#">6.4</a>	<a href="#">Allocation of Costs and Expenses</a>
<a href="#">6.5</a>	<a href="#">Covenants Against Taking Certain Actions Affecting GE</a>
<a href="#">6.6</a>	<a href="#">No Violations</a>
<a href="#">6.7</a>	<a href="#">Registration Statements</a>
<a href="#">6.8</a>	<a href="#">Charter Provision</a>
<a href="#">6.9</a>	<a href="#">Litigation and Settlement Cooperation</a>
<a href="#">6.10</a>	<a href="#">Continuation of Certain Arrangements</a>
<a href="#">6.11</a>	<a href="#">Future Intercompany Transactions</a>
<a href="#">6.12</a>	<a href="#">Use of Restricted Marks; Certain Commercial Arrangements</a>
<a href="#">6.13</a>	<a href="#">Committees</a>
<a href="#">6.14</a>	<a href="#">Genworth Bridge Loan</a>
<a href="#">6.15</a>	<a href="#">GE Policies</a>
<a href="#">6.16</a>	<a href="#">HomeBuyer Now Program; GE Relocation Program</a>
<a href="#">6.17</a>	<a href="#">Joint Management Committee</a>

[ARTICLE VII](#)            [DISPUTE RESOLUTION](#)

<a href="#">7.1</a>	<a href="#">General Provisions</a>
<a href="#">7.2</a>	<a href="#">Consideration by Senior Executives</a>
<a href="#">7.3</a>	<a href="#">Mediation</a>
<a href="#">7.4</a>	<a href="#">Arbitration</a>

[ARTICLE VIII](#)            [MISCELLANEOUS](#)

<a href="#">8.1</a>	<a href="#">Corporate Power; Fiduciary Duty</a>
<a href="#">8.2</a>	<a href="#">Governing Law</a>
<a href="#">8.3</a>	<a href="#">Survival of Covenants</a>
<a href="#">8.4</a>	<a href="#">Force Majeure</a>
<a href="#">8.5</a>	<a href="#">Notices</a>
<a href="#">8.6</a>	<a href="#">Severability</a>
<a href="#">8.7</a>	<a href="#">Entire Agreement</a>

**TABLE OF CONTENTS**  
**(continued)**

<a href="#">8.8</a>	<a href="#">Assignment; No Third-Party Beneficiaries</a>
<a href="#">8.9</a>	<a href="#">Public Announcements</a>
<a href="#">8.10</a>	<a href="#">Amendment</a>
<a href="#">8.11</a>	<a href="#">Rules of Construction</a>

**EXHIBITS**

A	Form of Transition Services Agreement
B	Form of Registration Rights Agreement
C	Form of Tax Matters Agreement
D	Form of Employee Matters Agreement
E	Form of Transitional Trademark License Agreement
F	Form of Intellectual Property Cross License Agreement
G	Form of Outsourcing Services Separation Agreement
H	Form of European Transition Services Agreement
I	Form of Investment Management Agreements
J	Form of Viking Agreement
K	Form of Liability and Portfolio Management Agreements
L	Form of Asset Management Services Agreement
M	Form of UK Transfer Plan
N	Form of French Transfer Plan
O	Form of Derivatives Management Services Agreement
P	Form of European Tax Matters Agreements
Q	Form of Framework Agreement
R	Form of Mortgage Services Agreement
S	Form of UFLIC ESG Services Agreement
T	French Transfer Agreement
U	Form of Capital Maintenance Agreement
V	Form of JLIC Recapture Agreement
W	Form of Long-Term Care Retrocession Agreement
X	Form of Medicare Supplement Reinsurance Agreement
Y	Form of Structured Settlement Annuity Reinsurance Agreements
Z	Form of Variable Annuity Reinsurance Agreements
AA	Form of Trust Agreements
BB	Form of Business Services Agreement
CC	Form of Genworth Contingent Note
DD	Form of Genworth Promissory Note
EE	Plan of Divestiture
FF	FACL Reinsurance Agreement
GG	Form of FACL Fall-back Stock Transfer Agreement
HH	FICL Reinsurance Agreement
II	Form of International Tax Matters Agreements
JJ	Form of French Reinsurance Agreement
KK	Joint Management Committee Letter Agreement
LL	Form of Amended and Restated Certificate of Incorporation
MM	Form of Amended and Restated Bylaws
NN	Form of Viking Stock Purchase Agreement
OO	Form of Tax Matters Agreement (GECA 338 Election)
PP	Form of Tax Matters Agreement (Genworth 338 Election)

**SCHEDULES**

Schedule 1.1	Discontinued Businesses
Schedule 1.1(a)	Supply and Vendor Contracts
Schedule 1.1(b)	GEFAHI Contracts
Schedule 1.1(e)	Genworth Contracts
Schedule 2.1(a)	Plan of Separation
Schedule 2.1(b)	Delayed Transfer Assets
Schedule 2.2(a)(i)	Genworth Assets
Schedule 2.2(a)(ii)(B)	Capital Stock GE Subsidiaries
Schedule 2.2(a)(ii)(C)	Capital Stock GE Affiliates
Schedule 2.2(b)(i)	Excluded Assets
Schedule 2.2(b)(ii)	Excluded Contracts
Schedule 2.3(a)(i)	Genworth Liabilities
Schedule 2.3(b)(iv)	Excluded Liabilities
Schedule 2.4(b)(ii)	Continuing Agreements
Schedule 2.4(b)(iii)	GE Guarantees
Schedule 2.9	European Creditor Business Entities
Schedule 3.2(d)	JLIC Surplus Notes
Schedule 3.2(f)	Dividends
Schedule 3.9(a)	Consideration Under French Transfer Agreement
Schedule 3.9(c)	Adjustments to Consideration
Schedule 4.1	Annual Corporate Reporting Data
Schedule 4.2(a)	First and Second Quarter Corporate Reporting Data
Schedule 4.2(b)	Third Quarter Corporate Reporting Data
Schedule 4.3	FP&A Reports
Schedule 4.8	Monthly Financial Information

Schedule 5.2(d)	Transaction Documents — Genworth Indemnification
Schedule 5.3(c)	Transaction Documents — GE Indemnification
Schedule 5.4	GE Indemnification
Schedule 6.3	Insurance Coverage
Schedule 6.5(b)	GE Contracts
Schedule 6.10	Continuation of Certain Arrangements
Schedule 6.12(b)(i)(B)	Business Activities
Schedule 6.15	GE Policies
Schedule 7.1	Transaction Documents — Dispute Resolution

MASTER AGREEMENT

MASTER AGREEMENT, dated May , 2004 (this “Agreement”), among General Electric Company, a New York corporation (“GE”), General Electric Capital Corporation, a Delaware corporation (“GECC”), GEI, Inc., a Delaware corporation (“GEI”), GE Financial Assurance Holdings, Inc., a Delaware corporation (“GEFAHI”, and collectively with GE, GEI and GECC, the “GE Parties”), and Genworth Financial, Inc., a Delaware corporation (“Genworth”). Certain terms used in this Agreement are defined in Section 1.1.

W I T N E S S E T H:

WHEREAS, the boards of directors of GE and GECC have determined that it is in the best interests of GE, GECC and their respective stockholders to divest the Genworth Group into a separate business, and the board of directors of GECC has adopted the Plan of Divestiture for the purpose of divesting a controlling interest in the stock of Genworth;

WHEREAS, Genworth has been incorporated solely for these purposes and has not engaged in activities except in preparation for its corporate reorganization and the sale of its stock;

WHEREAS, in furtherance of the foregoing, the boards of directors of GE, GECC and GEFAHI and the board of directors of Genworth have determined that it is appropriate and desirable to transfer the Genworth Assets to Genworth and its Subsidiaries and to cause Genworth and certain of its Subsidiaries designated by Genworth to assume the Genworth Liabilities, all as more fully described in this Agreement and the Transaction Documents;

WHEREAS, the boards of directors of GE and GEFAHI have further determined that it is appropriate and desirable to divest (i) a portion of GEFAHI’s interest in the Genworth Common Stock through the Initial Public Offering registered under the Securities Act, (ii) all of GEFAHI’s interest in the Genworth Equity Units and (iii) all of GEFAHI’s interest in the Series A Preferred Stock, concurrently with the closing of the Separation and the other transactions contemplated by this Agreement, and the board of directors of Genworth has further determined that it is appropriate and desirable to facilitate the Initial Public Offering and the Concurrent Offerings;

WHEREAS, pursuant to the Plan of Divestiture, GECC plans to dispose of additional stock of Genworth so that within two years following the Initial Public Offering GECC will own in the aggregate less than 50% of the outstanding stock of Genworth and as soon or reasonably practicable thereafter will own in the aggregate less than 20% of the outstanding stock of Genworth; and

WHEREAS, it is appropriate and desirable to set forth the principal corporate transactions required to effect the Separation and certain other agreements that will, following the consummation of the Initial Public Offering and the Concurrent

Offerings, govern certain matters relating to the Separation and the Initial Public Offering and the relationship of GE, Genworth and their respective Subsidiaries.

NOW, THEREFORE, in consideration of the premises and the representations, warranties, covenants and agreements contained herein, and for other good and valuable consideration, the receipt and sufficiency of which are hereby acknowledged, and intending to be legally bound hereby, the parties hereby agree as follows:

ARTICLE I

DEFINITIONS

1.1 Certain Definitions. For purposes of this Agreement, the following terms shall have the meanings specified in this Section 1.1:

“Action” means any demand, action, claim, dispute, suit, countersuit, arbitration, inquiry, proceeding or investigation by or before any federal, state, local, foreign or international Governmental Authority or any arbitration or mediation tribunal.

“Affiliate” (and, with a correlative meaning, “affiliated”) means, with respect to any Person, any direct or indirect subsidiary of such Person, and any other Person that directly, or through one or more intermediaries, controls or is controlled by or is under common control with such first Person; provided, however, that from and after the Closing Date, no member of the Genworth Group shall be deemed an Affiliate of any member of the GE Group for purposes of this Agreement and the Transaction Documents and no member of the GE Group shall be deemed an Affiliate of any member of the Genworth Group for purposes of this Agreement and the Transaction Documents. As used in this definition, “control” (including with correlative meanings, “controlled by” and “under common control with”) means possession, directly or indirectly, of power to direct or cause the direction of management or policies or the power to appoint and remove a majority of directors (whether through ownership of securities or partnership or other ownership interests, by contract or otherwise).

“AML” means American Mayflower Life Insurance Company of New York, a New York insurance company.

“Applicable Accounting Method” means the applicable accounting method by which GE is required, in accordance with GAAP, to account for its investment in Genworth (namely, on a consolidated basis, under the equity method or under the cost method).

“Asset Management Services Agreement” means the Asset Management Services Agreement substantially in the form attached as Exhibit L by and among Genworth, GEFAHI and GE Asset Management Incorporated and the related agreements listed in that Exhibit.

“Assets” means, with respect to any Person, the assets, properties and rights (including goodwill) of such Person, wherever located (including in the possession of vendors or other third parties or elsewhere), whether real, personal or mixed, tangible, intangible or contingent, in each case whether or not recorded or reflected or required to be recorded or reflected on the books and records or financial statements of such Person, including the following:

- (a) all accounting and other books, records and files whether in paper, microfilm, microfiche, computer tape or disc, magnetic tape or any other form;
- (b) all apparatus, computers and other electronic data processing equipment, fixtures, machinery, equipment, furniture, office equipment, automobiles, trucks, vessels, motor vehicles and other transportation equipment and other tangible personal property;
- (c) all interests in real property of whatever nature, including easements, whether as owner, mortgagee or holder of a Security Interest in real property, lessor, sublessor, lessee, sublessee or otherwise;
- (d) except for the capital stock referred to in Section 2.2(a)(ii)(B) and Section 2.2(a)(ii)(C), all interests in any capital stock or other equity interests of any Subsidiary or any other Person, all bonds, notes, debentures or other securities issued by any Subsidiary or any other Person, all loans, advances or other extensions of credit or capital contributions to any Subsidiary or any other Person and all other investments in securities of any Person;
- (e) all license agreements, leases of personal property, open purchase orders for supplies, parts or services and other contracts, agreements or commitments;
- (f) all deposits, letters of credit and performance and surety bonds;
- (g) all written technical information, data, specifications, research and development information, engineering drawings, operating and maintenance manuals, and materials and analyses prepared by consultants and other third parties;
- (h) all domestic and foreign intangible personal property, patents, copyrights, trade names, trademarks, service marks and registrations and applications for any of the foregoing, trade secrets, inventions, designs, ideas, improvements, works of authorship, recordings, other proprietary and confidential information and licenses from third Persons granting the right to use any of the foregoing;
- (i) all computer applications, programs and other software, including operating software, network software firmware, middleware, design software, design tools, systems documentation and instructions;
- (j) all cost information, sales and pricing data, customer prospect lists, supplier records, customer and supplier lists, customer and vendor data, correspondence and lists, product literature, artwork, design, formulations and specifications, quality

3

---

records and reports and other books, records, studies, surveys, reports, plans and documents;

- (k) all prepaid expenses, trade accounts and other accounts and notes receivables;
- (l) all rights under contracts or agreements, all claims or rights against any Person arising from the ownership of any Asset, all rights in connection with any bids or offers and all claims, choses in action or similar rights, whether accrued or contingent;
- (m) all rights under insurance policies and all rights in the nature of insurance, indemnification or contribution;
- (n) all licenses, permits, approvals and authorizations which have been issued by any Governmental Authority;
- (o) cash or cash equivalents, bank accounts, lock boxes and other deposit arrangements; and
- (p) interest rate, currency, commodity or other swap, collar, cap or other hedging or similar agreements or arrangements.

“Brookfield” means Brookfield Life Assurance Company Limited, a Bermuda insurance company.

“Business Day” means a day other than a Saturday, Sunday or other day on which commercial banks in New York City are authorized or required by Law to close. Any event the scheduled occurrence of which would fall on a day that is not a Business Day shall be deferred until the next succeeding Business Day.

“Business Services Agreement” means the Business Services Agreement substantially in the form attached hereto as Exhibit BB, by and between UFLIC and GNA.

“Capital Maintenance Agreement” means the Capital Maintenance Agreement in substantially the form attached as Exhibit U, between GE Capital and UFLIC.

“Class A Common Stock” means the Class A common stock, \$0.001 par value per share, of Genworth.

“Class B Common Stock” means the Class B common stock, \$0.001 par value per share, of Genworth.

“Code” means the Internal Revenue Code of 1986, as amended.

4

---

“Concurrent Offerings” means the registered public offerings by GEFAHI of Genworth Equity Units and Series A Preferred Stock, each such offering to be made concurrently with the Initial Public Offering.

“Consents” means any consent, waiver or approval from, or notification requirement to, any third parties.

“Corporate Reporting Data” means the Corporate Data Repository (CDR) submissions and data requirements, the Data Request (DR) and Web Reporting Interface (WRI) submissions and data requirements, and the Management’s Discussion and Analysis (MD&A) and Annual Report (A/R) submissions and data requirements, as set forth in detail on Schedules 4.1 and 4.2(a) and (b).

“Debt Registration Statement” means the registration statement on Form S-1 filed under the Securities Act pursuant to which the Genworth Senior Notes will be registered.

“Debt Release Agreement” means

“Delayed Transfer Assets” means any Genworth Assets that are expressly provided in this Agreement or any Transaction Document to be transferred after the Closing Date.

“Delayed Transfer Legal Entities” means Financial Assurance Company Limited, Financial Insurance Company Limited, Consolidated Insurance Group Limited, GE Financial Assurance Compañia de Seguros y Reaseguros de Vida SA and GE Financial Insurance Compañia de Seguros y Reaseguros SA.

“Delayed Transfer Liabilities” means any Genworth Liabilities that are expressly provided in this Agreement or any Transaction Document to be assumed after the Closing Date.

“Derivatives Management Services Agreement” means the Derivatives Management Services Agreement in substantially the form attached hereto as Exhibit O, to be entered into by and among GELAAC, FHL, First Colony, GECA, Genworth, GNA and GECC.

“Employee Matters Agreement” means the Employee Matters Agreement in substantially the form attached hereto as Exhibit D, to be entered into by and between GE and Genworth.

“Equity Units Registration Statement” means the registration statement on Form S-1 filed under the Securities Act (No. 333- ) pursuant to which the Genworth Equity Units issued to GEFAHI and sold by GEFAHI will be registered.

“ERISA” means the Employee Retirement Income Security Act of 1974, as amended.

5

---

“European Creditor Business” means the business of those entities set forth in Schedule 2.9 of this Agreement and the payment protection business of Vie Plus S.A.

“European Transition Services Agreement” means the Transitional Services Agreement in substantially the form attached hereto as Exhibit H, to be entered into by and between Financial Insurance Group Services Limited and GE Life Services Limited.

“Exchange Act” shall mean the Securities Exchange Act of 1934, as amended, and the rules and regulations of the SEC thereunder, all as the same shall be in effect at the time that reference is made thereto.

“Excluded Employee Liabilities” shall have the meaning set forth in the Employee Matters Agreement.

“FACL” means Financial Assurance Company Limited.

“FACL Bond Portfolio” means the products known as the guaranteed equity bonds, the guaranteed bonds, the flexible term guaranteed bonds, the investment bonds, the flexible access bonds, the individual non-creditor term assurances and structured settlements issued by FACL to certain policyholders in the United Kingdom including any and all rights, obligations and liabilities of FACL under all contracts entered into with any policyholders of FACL in respect of such products.

“FACL Bonds” means the products known as the guaranteed equity bonds, the guaranteed bonds, the flexible term guaranteed bonds, the investment bonds, the flexible access bonds, the individual non-creditor term assurances and structured settlements issued by FACL to certain policyholders in the United Kingdom that are in force as at the UK Transfer Date and including any and all rights, obligations and liabilities of FACL under all contracts entered into with any policyholders of FACL in respect of such products.

“FACL Fall-back Stock Transfer Agreement” means the Stock Transfer Agreement in substantially the form attached hereto as Exhibit GG to be entered into by and between GE Insurance Holdings Limited and GEFA UK Holdings Limited as and when contemplated by Section 3.9.

“FACL Reinsurance Agreement” means the Reinsurance Agreement, dated , 2004, by and between FACL and Viking as attached as Exhibit FF.

“FHL” means Federal Home Life Insurance Company, a Virginia insurance company.

“FICL Reinsurance Agreement” means the Reinsurance Agreement, dated , 2004, by and between Financial Insurance Company Limited and Viking as attached as Exhibit HH.

6

---

“FINCL” means Financial New Life Company Limited.

“Financial Closing Date” means, as to each fiscal quarterly or annual period of any member of the Genworth Group, the last Saturday in such fiscal period.

“Firm Public Offering Shares” means the Class A Common Stock sold in the Initial Public Offering, other than Class A Common Stock sold as a result of exercise of the Over-Allotment Option by the Underwriters, and the Series A Preferred Stock sold in a Concurrent Offering.

“First Colony” means First Colony Life Insurance Company, a Virginia insurance company.

“Force Majeure” means, with respect to a party, an event beyond the control of such party (or any Person acting on its behalf), which by its nature could not have been foreseen by such party (or such Person), or, if it could have been foreseen, was unavoidable, and includes, without limitation, acts of God, storms, floods, riots, fires, sabotage, civil commotion or civil unrest, interference by civil or military authorities, acts of war (declared or undeclared) or armed hostilities or other national or international calamity or one or more acts of terrorism or failure of energy sources.

“FP&A Reports” means the SRO data requirements, the Session I and Session II data requirements and the Op Plan data requirements, as set forth in detail on Schedule 4.3.

“Framework Agreement” means the Framework Agreement between GEFA International Holdings, Inc. and General Electric Capital Corporation, in substantially the form attached hereto as Exhibit Q.

“French Reinsurance Agreement” means the Reinsurance Agreement, dated \_\_\_\_\_, 2004, by and between Vie Plus S.A. and RD Plus S.A. as attached as Exhibit JJ.

“French Transfer Agreement” means the Business Transfer Agreement in substantially the form attached hereto as Exhibit T to be entered into by and between Vie Plus S.A. and Financial New Life Company Limited.

“French Transfer Plan” means the Agreement on Transfer of a Portfolio of Insurance Contracts in substantially the form attached as Exhibit N to be entered into by and between Vie Plus S.A. and FINCL.

“GAAP” means United States generally accepted accounting principles.

“GE Group” means GE and each Person (other than any member of the Genworth Group) that is an Affiliate of GE immediately after the Closing.

“GECA” means General Electric Capital Assurance Company, a Delaware insurance company.

7

---

“GECLANY” means GE Capital Life Assurance Company of New York, a New York insurance company.

“GEFA” means the GE Financial Assurance operating unit within GE Capital.

“GELAAC” means GE Life and Annuity Assurance Company, a Virginia insurance company.

“Genworth Balance Sheet” means Genworth’s unaudited Pro Forma Combined Statement of Financial Position as of December 31, 2003 included in the IPO Registration Statement.

“Genworth Bridge Loan” means the 180-day loan to be obtained by Genworth in the amount of \$2.4 billion, the proceeds of which will be used to repay the Genworth Promissory Note.

“Genworth Business” means the businesses of (a) the members of the Genworth Group; (b) GEFAHI; (c) the Delayed Transfer Legal Entities and (d) those terminated, divested or discontinued businesses of the members of Genworth Group, other than those listed on Schedule 1.1.

“Genworth Common Stock” means the Class A Common Stock and the Class B Common Stock.

“Genworth Contingent Note” means the \$550 million Subordinated Contingent Promissory Note payable by Genworth to GEFAHI, in substantially the form attached hereto as Exhibit CC.

“Genworth Contracts” means the following contracts and agreements to which GE or any of its Affiliates is a party or by which GE or any of its Affiliates or any of their respective Assets is bound, whether or not in writing, except for any such contract or agreement that is contemplated to be retained by GE or any member of the GE Group pursuant to any provision of this Agreement or any Transaction Document:

- (a) any supply or vendor contracts or agreements listed or described on Schedule 1.1(a) and any other supply or vendor contracts or agreements entered into after the date hereof and prior to the Closing Date that relate primarily to the Genworth Business;
- (b) any contract or agreement entered into in the name of GEFAHI that is not listed on Schedule 1.1(b);
- (c) any contract or agreement entered into in the name of, or expressly on behalf of, any division, business unit or member of the Genworth Group;
- (d) any contract or agreement, including any joint venture agreement, that relates primarily to the Genworth Business;

8

---

(e) the contracts, agreements and other documents listed or described on Schedule 1.1(e);

(f) any guarantee, indemnity, representation, warranty or other Liability of any member of the Genworth Group or the GE Group in respect of (i) any other Genworth Contract, (ii) any Genworth Liability or (iii) the Genworth Business; and

(g) any contract or agreement that is otherwise expressly contemplated pursuant to this Agreement or any of the Transaction Documents to be assigned to Genworth or any member of the Genworth Group.

“Genworth Credit Facilities” means the 364-day and five-year revolving credit facilities in the aggregate amount of \$2 billion to be obtained by Genworth.

“Genworth Equity Units” means \$600 million in aggregate amount of Equity Units to be sold by GEFAHI.

“Genworth Group” means Genworth, each Subsidiary of Genworth immediately after the Closing and each other Person that is either controlled directly or indirectly by Genworth immediately after the Closing; provided, that any Delayed Transfer Asset that is transferred to Genworth at any time following the Closing shall, to the extent applicable, be considered part of the Genworth Group for all purposes of this Agreement.

“Genworth Promissory Note” means the \$2.4 billion Promissory Note payable by Genworth to GEFAHI, in substantially the form attached hereto as Exhibit DD.

“Genworth Senior Notes” means approximately \$1.9 billion aggregate principal amount of senior notes to be issued by Genworth, the proceeds of which will be used to repay approximately \$1.9 billion of the Genworth Bridge Loan.

“GNA” means GNA Corporation.

“Governmental Approvals” means any notice, report or other filing to be made with, or any consent, registration, approval, permit or authorization to be obtained from, any Governmental Authority.

“Governmental Authority” means any entity exercising executive, legislative, judicial, regulatory or administrative functions of or pertaining to government, including any governmental authority, agency, department, board, commission or instrumentality whether federal, state, local or foreign (or any political subdivision thereof), and any tribunal, court or arbitrator(s) of competent jurisdiction.

“Group” means the GE Group or the Genworth Group, as the context requires.

9

---

“Information” means information, whether or not patentable or copyrightable, in written, oral, electronic or other tangible or intangible forms, stored in any medium, including studies, reports, records, books, contracts, instruments, surveys, discoveries, ideas, concepts, know-how, techniques, designs, specifications, drawings, blueprints, diagrams, models, prototypes, samples, flow charts, data, computer data, disks, diskettes, tapes, computer programs or other software, marketing plans, customer names, communications by or to attorneys (including attorney-client privileged communications), memoranda and other materials prepared by attorneys or under their direction (including attorney work product), and other technical, financial, employee or business information or data.

“Initial Public Offering” means the initial public offering of Genworth Common Stock.

“Insurance Policies” means the insurance policies written by insurance carriers, including those affiliated with GE and any self-insurance arrangements, pursuant to which Genworth or one or more of its Subsidiaries (or their respective officers or directors) will be insured parties after the Closing Date.

“Insurance Proceeds” means those monies: (a) received by an insured from an insurance carrier; (b) paid by an insurance carrier on behalf of the insured; or (c) received (including by way of set off) from any third party in the nature of insurance, contribution or indemnification in respect of any Liability; in any such case net of any applicable premium adjustments (including reserves and retrospectively rated premium adjustments) and net of any costs or expenses incurred in the collection thereof.

“Intellectual Property Cross License Agreement” means the Intellectual Property Cross License Agreement in substantially the form attached hereto as Exhibit F, to be entered into by and between GE and Genworth.

“International Tax Matters Agreements” means (i) the Canadian Tax Matters Agreement in substantially the form attached hereto as Exhibit II-1, to be entered into by and among GE, GECC, GECMIC Holdings Inc., GE Capital Mortgage Insurance Company (Canada) and Genworth, (ii) the European Tax Matters Agreement in substantially the form attached hereto as Exhibit II-2, to be entered into by and among GE, GECC, IGE USA Investments, Consolidated Insurance Holdings Limited, FACL, Financial Insurance Group Services Company Limited, GE Capital SAS, GEFA International Holdings Inc., UK Group Holding Company Limited, Genworth and GEFA UK Holdings, (iii) the Taxation Management Agreement in substantially the form attached hereto as Exhibit II-3, to be entered into by and among Genworth, GECC and GE and (iv) the Taxation Management (Stub Period Payments) Agreement in substantially the form attached hereto as Exhibit II-4, to be entered into by and among GE Capital Australia, GE Mortgage Insurance Company Pty Limited, Genworth, GECC and GE.

“Investment Management Agreements” means (i) the Amended and Restated Investment Management and Services Agreements in substantially the form

10

---

attached hereto as Exhibit I, to be entered into by and among GE Asset Management Incorporated and certain members of the Genworth Group, (ii) the Investment Management Agreements in substantially the form attached hereto as Exhibit I, to be entered into by and between GE Asset Management Incorporated and GNA, (iii) the Investment Management Agreement in substantially the form attached hereto as Exhibit I to be entered into by and among GE Asset Management Limited and each of Financial Assurance Company Limited, GE Mortgage Insurance Limited, RD Plus S.A., Financial Insurance Guernsey PCC Limited, GE Financial Assurance Compania de Seguros y Reaseguros de Vida SA and GE Financial Insurance Compania de Seguros y Reaseguros SA.

“IP Application” means any application for the registration, acquisition or perfection of intellectual property rights, including patent applications, copyright applications and trademark applications.

“IPO Registration Statement” means the registration statement on Form S-1 filed under the Securities Act (No. 333-112009) pursuant to which the Genworth Common Stock to be issued to GEFAHI and sold by GEFAHI in the Initial Public Offering will be registered.

“IRS” means the United States Internal Revenue Service.

“JLIC Recapture Agreement” means the Recapture Agreement in substantially the form attached as Exhibit V, to be entered into by and between Jamestown Life Insurance Company and GECA.

“Law” means any federal, state, local or foreign law (including common law), statute, code, ordinance, rule, regulation or other requirement enacted, promulgated, issued or entered by a Governmental Authority.

“Liabilities” means any debt, loss, damage, adverse claim, liability or obligation of any Person (whether direct or indirect, known or unknown, asserted or unasserted, absolute or contingent, accrued or unaccrued, liquidated or unliquidated, or due or to become due, and whether in contract, tort, strict liability or otherwise), and including all costs and expenses relating thereto.

“Liability and Portfolio Management Agreements” means the Liability and Portfolio Management Agreements in substantially the forms attached hereto as Exhibit K by and between (1) Trinity Plus Funding Company, LLC and Genworth Financial Asset Management, LLC, (2) Trinity Funding Company, LLC and Genworth Financial Asset Management, LLC and (3) FGIC Capital Market Services, Inc., Genworth Financial Asset Management, LLC and General Electric Capital Corporation.

“Licensed Marks” shall have the meaning specified in the Transition Trademark Agreement.

“Long-Term Care Retrocession Agreements” means the Retrocession Agreements in substantially the form attached hereto as Exhibit W, to be entered into by

11

---

and between UFLIC, on the one hand, and each of GECA and GECLANY, on the other hand.



“Medicare Supplement Reinsurance Agreement” means the Coinsurance Agreement in substantially the form attached hereto as Exhibit X, to be entered into by and between UFLIC and FHL.

“Mortgage Services Agreement” means the Mortgage Services Agreement substantially in the form attached hereto as Exhibit R to be entered into by and between GE Mortgage Services, LLC and GE Mortgage Holdings, LLC.

“Outsourcing Services Separation Agreement” means the Outsourcing Services Separation Agreement in substantially the form attached hereto as Exhibit G, to be entered into by and among GE, GECC, GE Capital International Services and Genworth.

“Over-Allotment Option” means the over-allotment option that may be exercised by the underwriters of the Initial Public Offering pursuant to the Underwriting Agreements relating to the Initial Public Offering and the offering of the Series A Preferred Stock.

“Person” means any individual, corporation, partnership, firm, joint venture, association, joint-stock company, trust, unincorporated organization, Governmental Authority or other entity.

“Plan of Divestiture” means the plan of divestiture adopted by the board of directors of GECC attached hereto as Exhibit EE.

“Pre-Closing Documents” means the Debt Release Agreement, the FACL Reinsurance Agreement, the FICL Reinsurance Agreement and the French Reinsurance Agreement.

“Prospectus” means the prospectus or prospectuses included in any of the Registration Statements, as amended or supplemented by any prospectus supplement and by all other amendments and supplements to any such prospectus, including post-effective amendments and all material incorporated by reference in such prospectus or prospectuses.

“Registration Rights Agreement” means the Registration Rights Agreement in substantially the form attached hereto as Exhibit B, to be entered into by and between GEFAHI and Genworth.

“Registration Statements” means the IPO Registration Statement, the Equity Units Registration Statement, the Series A Preferred Stock Registration Statement and the Debt Registration Statement, including in each case the Prospectus related thereto, amendments and supplements to any such Registration Statement, including post-effective amendments, all exhibits and all materials incorporated by reference in any such Registration Statement and Prospectus.

---

12

“Reinsurance Agreements” means the Long-Term Care Retrocession Agreements, the Structured Settlement Annuity Reinsurance Agreements, the Variable Annuity Reinsurance Agreements, and the Medicare Supplement Reinsurance Agreement.

“Restricted Marks” means the Licensed Marks and the name “General Electric.”

“SEC” means the Securities and Exchange Commission.

“Securities Act” means the Securities Act of 1933, as amended.

“Security Interest” means any mortgage, security interest, pledge, lien, charge, claim, option, right to acquire, voting or other restriction, right-of-way, covenant, condition, easement, encroachment, restriction on transfer, or other encumbrance of any nature whatsoever.

“Separation” means the transfer of the Genworth Assets to Genworth and its Subsidiaries and the assumption by Genworth and its Subsidiaries of the Genworth Liabilities, and the transfer of certain Excluded Assets to GE and its Subsidiaries and the assumption by GE and its Subsidiaries of certain Excluded Liabilities, all as more fully described in this Agreement and the Transaction Documents.

“Series A Preferred Stock” means the series A cumulative preferred stock, \$.001 par value per share, of Genworth.

“Series A Preferred Stock Registration Statement” means the registration statement on Form S-1 filed under the Securities Act (No. 333- ) pursuant to which the Series A Preferred Stock issued to GEFAHI and sold by GEFAHI will be registered.

“Structured Settlement Annuity Reinsurance Agreements” means the Coinsurance Agreements in substantially the form attached as Exhibit Y hereto, to be entered into by and between UFLIC, on the one hand, and each of First Colony, FHL, GELAAC, GECA, GECLANY and AML, on the other hand.

“Subsidiary” or “subsidiary” means, with respect to any Person, any corporation, limited liability company, joint venture or partnership of which such Person (a) beneficially owns, either directly or indirectly, more than fifty percent (50%) of (i) the total combined voting power of all classes of voting securities of such entity, (ii) the total combined equity interests, or (iii) the capital or profit interests, in the case of a partnership; or (b) otherwise has the power to vote, either directly or indirectly, sufficient securities to elect a majority of the board of directors or similar governing body.

“Tax” means all federal, state, provincial, territorial, municipal, local or foreign income, profits, franchise, gross receipts, environmental (including taxes under Code Section 59A), customs, duties, net worth, sales, use, goods and services, withholding, value added, *ad valorem*, employment, social security, disability, occupation, pension, real property, personal property (tangible and intangible), stamp,

---

13

transfer, conveyance, severance, production, excise, premium, retaliatory and other taxes, withholdings, duties, levies, imposts, guarantee fund assessments and other similar charges and assessments (including any and all fines, penalties and additions attributable to or otherwise imposed on or with respect to any such taxes, charges, fees, levies or other assessments, and interest thereon) imposed by or on behalf of any Taxing Authority, in each case whether such Tax arises by Law, contract, agreement or otherwise.

“Tax Returns” means any report, return, declaration, claim for refund, information report or return or statement required to be supplied to a Taxing Authority in connection with Taxes, including any schedule or attachment thereto or amendment thereof.

“Taxing Authority” means any Governmental Authority exercising any authority to impose, regulate, levy, assess or administer the imposition of any Tax.

“Tax Matters Agreement” means the Tax Matters Agreement, in substantially the form attached hereto as Exhibit C, to be entered into by and among GE,

GECC, GEI, GEFAHI and Genworth.

“Transactions” means, collectively, (i) the Separation, (ii) the Initial Public Offering and (iii) all other transactions contemplated by this Agreement or any Transaction Document.

“Transition Services Agreement” means the Transition Services Agreement in substantially the form attached hereto as Exhibit A, to be entered into by and among GE, GECC, GEI, GEFAHI, GNA and Genworth and GE Mortgage Holdings, LLC.

“Transitional Trademark License Agreement” means the Transitional Trademark License Agreement in substantially the form attached hereto as Exhibit E, to be entered into by and between GE and Genworth.

“Trigger Date” means the first date on which members of the GE Group cease to beneficially own (excluding for such purposes shares of Genworth Common Stock beneficially owned by GE but not for its own account, including (in such exclusion) beneficial ownership which arises by virtue of some entity that is an Affiliate of GE being a sponsor of or advisor to a mutual or similar fund that beneficially owns shares of Genworth Common Stock) more than fifty percent (50%) of the outstanding Genworth Common Stock.

“Trust Agreements” means the (i) Trust Agreements in substantially the form attached hereto as Exhibit AA, to be entered into by and among UFLIC and The Bank of New York, as trustee, on the one hand, and each of AML, First Colony, FHL, GELAAC, GECA, and GECLANY and (ii) the Trust Agreement to be entered into by and among FHL and The Bank of New York, as Trustee, and UFLIC.

14

“UFLIC” means Union Fidelity Life Insurance Company, an Illinois insurance company.

“UFLIC Agreements” means the Recapture Agreement to be entered into by and between GELAAC and UFLIC, the Recapture Agreement to be entered into by and between GECLANY and UFLIC and the Administrative Services Agreement to be entered into by and between UFLIC and First Colony.

“UFLIC ESG Services Agreement” means the Administrative Services Agreement in substantially the form attached as Exhibit S, to be entered into by and between UFLIC and GE Group Life Assurance Company.

“UK Transfer Date” means the earlier of (i) the date on which the Assets and Liabilities of FACL are transferred to FINCL pursuant to the UK Transfer Plan and (ii) the date on which all the shares of FACL are transferred into Genworth under the FACL Fall-back Stock Transfer Agreement.

“UK Transfer Plan” means the Scheme for the Transfer to Financial New Life Company Limited of the insurance business of Financial Assurance Company Limited in substantially the form attached hereto as Exhibit M.

“Underwriters” means the managing underwriters for the Initial Public Offering.

“Underwriting Agreements” means the Underwriting Agreements to be entered into by and among GEFAHI, Genworth and the Underwriters in connection with the offering of Genworth Common Stock by GEFAHI in the Initial Public Offering and the offering of Series A Preferred Stock and Equity Units by GEFAHI in the Concurrent Offerings.

“Variable Annuity Reinsurance Agreements” means the Reinsurance Agreements in substantially the form attached hereto as Exhibit Z, to be entered into by and between UFLIC, on the one hand, and each of GELAAC and GECLANY, on the other hand.

“Viking” means Viking Insurance Company, Ltd., a Bermuda corporation.

“Viking Agreement” means the Agreement Regarding Continued Reinsurance of Insurance Products in substantially the form attached hereto as Exhibit J, to be entered into between GECC and Viking.

“Viking Stock Purchase Agreement” means the Stock Purchase Agreement in substantially the form attached hereto as Exhibit NN, to be entered into between GELCO Corporation and GEFAHI.

1.2 Other Terms. For purposes of this Agreement, the following terms have the meanings set forth in the sections indicated.

15

<u>Term</u>	<u>Section</u>
After-Tax Basis	5.6(c)
Agreement	Recitals
Closing	3.1
Closing Date	3.1
CPR	7.3
CPR Arbitration Rules	7.4(a)
Dispute	7.1(a)
Excluded Assets	2.2(b)
Excluded Liabilities	2.3(b)
FACL Bond Portfolio Reinsurance	2.10(a)
GE	Recitals
GE Annual Statements	4.7
GE Auditors	4.7(a)
GE Confidential Information	6.2(b)
GE Guarantees	2.4(b)(iii)
GE Indemnified Parties	5.2
GE Parties	Recitals
GE Policies	6.15
GE Public Filings	4.6
GE Transfer Documents	3.5
GECC	Recitals

GEI	Recitals
GEFAHI	Recitals
Genworth	Recitals
Genworth Assets	2.2(a)
Genworth Auditors	4.7(a)
Genworth Confidential Information	6.2(a)
Genworth Indemnified Parties	5.3
Genworth Information	4.5(g)
Genworth Liabilities	2.3(a)
Genworth Public Documents	4.5(e)
Genworth Transfer Documents	3.6(a)(iii)
Indemnified Party	5.6(a)
Indemnifying Party	5.6(a)
Indemnity Payment	5.6(a)
Initial Notice	7.2
Privilege	4.17
Registration Indemnified Parties	5.4(a)
Reinsurance-Related Documents	3.2(a)
Representatives	6.2(a)
Response	7.2
Tax Agreements	3.10(a)
Third Party Claim	5.7(a)
Transaction Documents	3.3(b)
Transfer Documents	3.6(a)(iii)

ARTICLE II

THE SEPARATION

2.1 Transfer of Assets; Assumption of Liabilities; Consideration.

(a) Subject to Section 3.8, immediately following the execution and delivery of the Underwriting Agreements by each of the parties thereto, in accordance with the plan and structure set forth on Schedule 2.1(a):

(i) GE shall, and shall cause its applicable Subsidiaries to, contribute, assign, transfer, convey and deliver to Genworth or certain of its Subsidiaries designated by Genworth, and Genworth or such Subsidiaries shall accept from GE and its applicable Subsidiaries, all of GE's and such Subsidiaries' respective rights, titles and interests in and to all Genworth Assets, other than the Delayed Transfer Assets;

(ii) Genworth and certain of its Subsidiaries designated by Genworth, shall accept, assume and agree faithfully to perform, discharge and fulfill all the Genworth Liabilities, other than the Delayed Transfer Liabilities, in accordance with their respective terms. Genworth and such Subsidiaries shall be responsible for all Genworth Liabilities, regardless of when or where such Genworth Liabilities arose or arise, or whether the facts on which they are based occurred prior to or subsequent to the Closing Date, regardless of where or against whom such Genworth Liabilities are asserted or determined (including any Genworth Liabilities arising out of claims made by GE's or Genworth's respective directors, officers, employees, agents, Subsidiaries or Affiliates against any member of the GE Group or the Genworth Group) or whether asserted or determined prior to the date hereof, and, except as set forth in Section 2.3(b)(v), regardless of whether arising from or alleged to arise from negligence, recklessness, violation of Law, fraud or misrepresentation by any member of the GE Group or the Genworth Group, or any of their respective directors, officers, employees, agents, Subsidiaries or Affiliates; and

(iii) Genworth shall issue to GEFAHI (A) 485,000,000 shares of Class B Common Stock, (B) 2,000,000 shares of Series A Preferred Stock, (C) the Genworth Promissory Note, (D) the Genworth Contingent Note and (E) the Genworth Equity Units.

(b) Each of the parties hereto agrees that the Delayed Transfer Assets will be contributed, assigned, transferred, conveyed and delivered, and the Delayed Transfer Liabilities will be accepted and assumed, in accordance with the terms of the applicable Transaction Documents or as otherwise set forth on Schedule 2.1(b). Following such contribution, assignment, transfer, conveyance and delivery of any Delayed Transfer Asset, or the acceptance and assumption of any Delayed Transfer Liability, the applicable Delayed Transfer Asset or Delayed Transfer Liability shall be

treated for all purposes of this Agreement and the Transaction Documents as a Genworth Asset or a Genworth Liability, as the case may be.

(c) If at any time or from time to time (whether prior to or after the Closing Date), any party hereto (or any member of such party's respective Group), shall receive or otherwise possess any Asset that is allocated to any other Person pursuant to this Agreement or any Transaction Document, such party shall promptly transfer, or cause to be transferred, such Asset to the Person so entitled thereto. Prior to any such transfer, the Person receiving or possessing such Asset shall hold such Asset in trust for any such other Person.

(d) Genworth hereby waives compliance by each member of the GE Group with the requirements and provisions of the "bulk-sale" or "bulk-transfer" Laws of any jurisdiction that may otherwise be applicable with respect to the transfer or sale of any or all of the Genworth Assets to any member of the Genworth Group.

2.2 Genworth Assets.

(a) For purposes of this Agreement, "Genworth Assets" shall mean (without duplication):

(i) the Assets listed or described on Schedule 2.2(a)(i) and all other Assets that are expressly provided by this Agreement or any Transaction Document as Assets to be transferred to Genworth or any other member of the Genworth Group;

(ii) (A) all Genworth Contracts, (B) all issued and outstanding capital stock of the Subsidiaries of GE listed on Schedule 2.2(a)(ii)(B), and (C) the shares of capital stock of certain entities held by GE as listed on Schedule 2.2(a)(ii)(C);

(iii) subject to Section 6.3, any rights of any member of the Genworth Group under any of the Insurance Policies, including any rights thereunder arising after the Closing Date in respect of any Insurance Policies;

(iv) all Assets reflected as Assets of Genworth and its Subsidiaries in the Genworth Balance Sheet, subject to any dispositions of such Assets subsequent to the date of the Genworth Balance Sheet; and

(v) any and all Assets owned or held immediately prior to the Closing Date by GE or any of its Subsidiaries that are used primarily in the Genworth Business. The intention of this clause (v) is only to rectify any inadvertent omission of transfer or conveyance of any Assets that, had the parties given specific consideration to such Asset as of the date hereof, would have otherwise been classified as a Genworth Asset. No Asset shall be deemed to be a Genworth Asset solely as a result of this clause (v) if such Asset is within the category or type of Asset expressly covered by the terms of a Transaction Document unless the party claiming entitlement to such Asset can establish that the omission of the transfer or conveyance of such Asset was inadvertent. In addition, no Asset shall be deemed a Genworth Asset solely as a result of this clause (v)

18

---

unless a claim with respect thereto is made by Genworth on or prior to the later of (A) the Trigger Date and (B) the first anniversary of the Closing Date.

Notwithstanding the foregoing, the Genworth Assets shall not in any event include the Excluded Assets referred to in Section 2.2(b).

(b) For the purposes of this Agreement, "Excluded Assets" shall mean:

(i) the Assets listed or described on Schedule 2.2(b)(i);

(ii) the contracts and agreements listed or described on Schedule 2.2(b)(ii); and

(iii) any and all Assets that are expressly contemplated by this Agreement or any Transaction Document as Assets to be retained by a GE Party or any other member of the GE Group.

### 2.3 Genworth Liabilities.

(a) For the purposes of this Agreement, "Genworth Liabilities" shall mean (without duplication):

(i) the Liabilities listed or described on Schedule 2.3(a)(i) and all other Liabilities that are expressly provided by this Agreement or any Transaction Document as Liabilities to be assumed by Genworth or any other member of the Genworth Group, and all agreements, obligations and Liabilities of Genworth or any other member of the Genworth Group under this Agreement or any of the Transaction Documents;

(ii) all Liabilities, including any employee-related Liabilities (other than Excluded Employee Liabilities) relating to, arising out of or resulting from:

(A) the operation of the Genworth Business, as conducted at any time before, on or after the Closing Date (including any Liability relating to, arising out of or resulting from any act or failure to act by any director, officer, employee, agent or representative (whether or not such act or failure to act is or was within such Person's authority));

(B) the operation of any business conducted by any member of the Genworth Group at any time after the Closing Date (including any Liability relating to, arising out of or resulting from any act or failure to act by any director, officer, employee, agent or representative (whether or not such act or failure to act is or was within such Person's authority)); or

(C) any Genworth Assets (including any Genworth Contracts and any real property and leasehold interests);

19

---

in any such case whether arising before, on or after the Closing Date;

(iii) all Liabilities reflected as liabilities or obligations of Genworth or its Subsidiaries in the Genworth Balance Sheet, subject to any discharge of such Liabilities subsequent to the date of the Genworth Balance Sheet; and

(iv) all Liabilities arising out of claims made by GE's or Genworth's respective directors, officers, employees, agents, Subsidiaries or Affiliates against any member of the GE Group or the Genworth Group with respect to the Genworth Business.

(b) For the purposes of this Agreement, "Excluded Liabilities" shall mean (without duplication):

(i) any and all Liabilities that are expressly contemplated by this Agreement or any Transaction Document as Liabilities to be retained or assumed by GE or any other member of the GE Group (in each case other than Delayed Transfer Liabilities), and all agreements and obligations of any member of the GE Group under this Agreement or any of the Transaction Documents;

(ii) any and all Liabilities of a member of the GE Group relating to, arising out of or resulting from any Excluded Assets;

(iii) the Excluded Employee Liabilities;

(iv) the Liabilities listed on Schedule 2.3(b)(iv); and

(v) any and all liabilities arising from a knowing violation of Law, fraud or misrepresentation by any member of the GE Group (other than, for periods prior to the Closing Date, GEFAHI or any Delayed Transfer Legal Entity) or any of their respective directors, officers, employees or agents (other than any individual who at the time of such act was acting in his or her capacity as a director, officer, employee or agent of any member of the Genworth Group).

(c) Any Liabilities of any member of the GE Group not expressly referenced in Section 2.3(a) above are Excluded Liabilities and all Excluded Liabilities shall not be Genworth Liabilities.

### 2.4 Termination of Agreements.

(a) Except as set forth in Section 2.4(b), Genworth and each member of the Genworth Group, on the one hand, and GE and each member of the GE Group, on the other hand, hereby terminate any and all agreements, arrangements, commitments or understandings, whether or not in writing, between or among Genworth or any member of the Genworth Group, on the one hand, and GE or any member of the GE Group, on the other hand, effective as of the Closing Date. No such terminated agreement, arrangement, commitment or understanding (including any provision thereof which purports to survive termination) shall be of any further force or effect after the Closing

20

---

Date. Each party shall, at the reasonable request of any other party, take, or cause to be taken, such other actions as may be necessary to effect the foregoing.

(b) The provisions of Section 2.4(a) shall not apply to any of the following agreements, arrangements, commitments or understandings (or to any of the provisions thereof):

- (i) this Agreement and the Transaction Documents (and each other agreement or instrument expressly contemplated by this Agreement or any Transaction Document to be entered into or continued by any of the parties hereto or any of the members of their respective Groups);
- (ii) except to the extent redundant with any provision of or service provided under this Agreement or any of the Transaction Documents (including any exhibits or schedules thereto), the agreements, arrangements, commitments and understandings listed or described on Schedule 2.4(b)(ii);
- (iii) the guarantees, indemnification obligations, surety bonds and other credit support agreements, arrangements, commitments or understandings listed or described on Schedule 2.4(b)(iii) (the "GE Guarantees");
- (iv) any agreements, arrangements, commitments or understandings to which any Person other than the parties hereto and their respective Affiliates is a party (it being understood that to the extent that the rights and obligations of the parties and the members of their respective Groups under any such agreements, arrangements, commitments or understandings constitute Genworth Assets or Genworth Liabilities, they shall be assigned pursuant to Section 2.1);
- (v) any accounts payable or accounts receivable between a member of the GE Group, on the one hand, and a member of the Genworth Group, on the other hand, accrued as of the Closing Date and reflected in the books and records of the parties or otherwise documented in writing in accordance with past practices; provided, however, that all such amounts must be settled within 90 days after the Closing Date except as otherwise provided for in the Transaction Documents;
- (vi) any agreements, arrangements, commitments or understandings to which any non-wholly owned Subsidiary of GE or Genworth, as the case may be, is a party (it being understood that directors' qualifying shares or similar interests will be disregarded for purposes of determining whether a Subsidiary is wholly owned); and
- (vii) any other agreements, arrangements, commitments or understandings that this Agreement or any Transaction Document expressly contemplates will survive the Closing Date.

2.5 DISCLAIMER OF REPRESENTATIONS AND WARRANTIES. EACH OF GE (ON BEHALF OF ITSELF AND EACH MEMBER OF THE GE GROUP) AND GENWORTH (ON BEHALF OF ITSELF AND EACH MEMBER OF

21

---

THE GENWORTH GROUP UNDERSTANDS AND AGREES THAT, EXCEPT AS EXPRESSLY SET FORTH HEREIN OR IN ANY TRANSACTION DOCUMENT, NO PARTY TO THIS AGREEMENT, ANY TRANSACTION DOCUMENT OR ANY OTHER AGREEMENT OR DOCUMENT CONTEMPLATED BY THIS AGREEMENT, ANY TRANSACTION DOCUMENT OR OTHERWISE, IS REPRESENTING OR WARRANTING IN ANY WAY AS TO THE ASSETS, BUSINESSES OR LIABILITIES TRANSFERRED OR ASSUMED AS CONTEMPLATED HEREBY OR THEREBY, AS TO ANY CONSENTS OR APPROVALS REQUIRED IN CONNECTION HERewith OR THEREWITH, AS TO THE VALUE OR FREEDOM FROM ANY SECURITY INTERESTS OF, OR ANY OTHER MATTER CONCERNING, ANY ASSETS OF SUCH PARTY, OR AS TO THE ABSENCE OF ANY DEFENSES OR RIGHT OF SETOFF OR FREEDOM FROM COUNTERCLAIM WITH RESPECT TO ANY CLAIM OR OTHER ASSET, INCLUDING ANY ACCOUNTS RECEIVABLE, OF ANY PARTY, OR AS TO THE LEGAL SUFFICIENCY OF ANY ASSIGNMENT, DOCUMENT OR INSTRUMENT DELIVERED HEREUNDER TO CONVEY TITLE TO ANY ASSET OR THING OF VALUE UPON THE EXECUTION, DELIVERY AND FILING HEREOF OR THEREOF. EXCEPT AS MAY EXPRESSLY BE SET FORTH HEREIN OR IN ANY TRANSACTION DOCUMENT, ALL SUCH ASSETS ARE BEING TRANSFERRED ON AN "AS IS," "WHERE IS" BASIS (AND, IN THE CASE OF ANY REAL PROPERTY, BY MEANS OF A QUITCLAIM OR SIMILAR FORM DEED OR CONVEYANCE) AND THE RESPECTIVE TRANSFEREES SHALL BEAR THE ECONOMIC AND LEGAL RISKS THAT (I) ANY CONVEYANCE SHALL PROVE TO BE INSUFFICIENT TO VEST IN THE TRANSFEREE GOOD TITLE, FREE AND CLEAR OF ANY SECURITY INTEREST, AND (II) ANY NECESSARY CONSENTS OR GOVERNMENTAL APPROVALS ARE NOT OBTAINED OR THAT ANY REQUIREMENTS OF LAWS OR JUDGMENTS ARE NOT COMPLIED WITH.

2.6 Governmental Approvals and Consents; Delayed Transfer Assets and Liabilities

- (a) To the extent that the Separation requires any Governmental Approvals or Consents, the parties will use their commercially reasonable efforts to obtain such Governmental Approvals and Consents; provided, however, that neither GE nor Genworth shall be obligated to contribute capital in any form to any entity in order to obtain such Governmental Approvals and Consents.
- (b) If and to the extent that the valid, complete and perfected transfer or assignment to the Genworth Group of any Genworth Assets or the assumption by the Genworth Group of any Genworth Liabilities would be a violation of applicable Law or require any Consent or Governmental Approval in connection with the Separation, or the Initial Public Offering, then, unless the parties hereto mutually shall otherwise determine, the transfer or assignment to the Genworth Group of such Genworth Assets or the assumption by the Genworth Group of such Genworth Liabilities shall be automatically deemed deferred and any such purported transfer, assignment or assumption shall be null and void until such time as all legal impediments are removed or such Consents or Governmental Approvals have been obtained. Any such Liability

22

---

shall be deemed a Delayed Transfer Liability. Any such Asset shall be deemed (i) a Delayed Transfer Asset and, (ii) notwithstanding the foregoing, a Genworth Asset for purposes of determining whether any Liability is a Genworth Liability.

- (c) If any transfer or assignment of any Genworth Asset intended to be transferred or assigned hereunder or any assumption of any Genworth Liability intended to be assumed by Genworth hereunder (including without limitation all Assets and Liabilities of FACL intended to be transferred to or assumed by FINCL

pursuant to the UK Transfer Plan and all Assets and Liabilities of Vie Plus SA intended to be transferred to or assumed by members of the Genworth Group pursuant to the French Transfer Agreement or French Transfer Plan) is not consummated on the Closing Date, whether as a result of the provisions of Section 2.6(b) or for any other reason, then, insofar as reasonably possible, (i) the Person retaining such Genworth Asset shall thereafter hold such Genworth Asset for the use and benefit of the Person entitled thereto (at the expense of the Person entitled thereto) and (ii) Genworth shall, or shall cause its applicable Subsidiary to, pay or reimburse the Person retaining such Genworth Liability for all amounts paid or incurred in connection with such Genworth Liability. In addition, the Person retaining such Genworth Asset shall, insofar as reasonably possible and to the extent permitted by applicable Law, treat such Asset in the ordinary course of business in accordance with past practice and take such other actions as may be reasonably requested by the Person to whom such Genworth Asset is to be transferred in order to place such Person in the same position as if such Genworth Asset had been transferred as contemplated hereby and so that all the benefits and burdens relating to such Genworth Asset, including possession, use, risk of loss, potential for gain, and dominion, control and command over such Genworth Asset, is to inure from and after the Closing Date to the Genworth Group.

(d) If and when the Consents and Governmental Approvals, the absence of which caused the deferral of transfer of any Genworth Asset or the deferral of assumption of any Genworth Liability pursuant to Section 2.6(b), are obtained, the transfer of the applicable Genworth Asset or Genworth Liability shall be effected in accordance with the terms of this Agreement and/or the applicable Transaction Document.

(e) The Person retaining an Asset or Liability due to the deferral of the transfer of such Asset or the deferral of the assumption of such Liability shall not be obligated, in connection with the foregoing, to expend any money unless the necessary funds are advanced (or otherwise made available) by the Person entitled to the Asset or the Person intended to be subject to the Liability, other than reasonable out-of-pocket expenses, attorneys' fees and recording or similar fees, all of which shall be promptly reimbursed by the Person entitled to such Asset or the Person intended to be subject to the Liability.

#### 2.7 Novation of Assumed Genworth Liabilities.

(a) Each of GE and Genworth, at the request of the other, shall use its reasonable best efforts to obtain, or to cause to be obtained, any consent, substitution,

23

---

approval or amendment required to novate or assign all obligations under agreements, leases, licenses and other obligations or Liabilities of any nature whatsoever that constitute Genworth Liabilities, or to obtain in writing the unconditional release of all parties to such arrangements other than any member of the Genworth Group, so that, in any such case, Genworth and its Subsidiaries will be solely responsible for such Liabilities; provided, however, that neither GE nor Genworth shall be obligated to pay any consideration therefor to any third party from whom any such consent, approval, substitution or amendment is requested.

(b) If GE or Genworth is unable to obtain, or to cause to be obtained, any such required consent, approval, release, substitution or amendment, the applicable member of the GE Group shall continue to be bound by such agreement, lease, license or other obligation and, unless not permitted by Law or the terms thereof, Genworth shall, as agent or subcontractor for GE or such other Person, as the case may be, pay, perform and discharge fully all the obligations or other Liabilities of GE or such other Person that constitute Genworth Liabilities, as the case may be, thereunder from and after the Closing Date. Genworth shall indemnify each GE Indemnified Party, and hold each of them harmless against any Liabilities arising in connection therewith; provided that pursuant hereto Genworth shall have no obligation to indemnify any GE Indemnified Party that has engaged in any knowing violation of Law, fraud or misrepresentation in connection therewith. GE shall, without further consideration, pay and remit, or cause to be paid or remitted, to Genworth, promptly all money, rights and other consideration received by it or any member of its Group in respect of such performance (unless any such consideration is an Excluded Asset). If and when any such consent, approval, release, substitution or amendment shall be obtained or such agreement, lease, license or other rights or obligations shall otherwise become assignable or able to be novated, GE shall thereafter assign, or cause to be assigned, all its rights, obligations and other Liabilities thereunder or any rights or obligations of any member of its Group to Genworth without payment of further consideration and Genworth shall, without the payment of any further consideration, assume such rights and obligations.

#### 2.8 Novation of Liabilities other than Genworth Liabilities.

(a) Each of GE and Genworth, at the request of the other, shall use its reasonable best efforts to obtain, or to cause to be obtained, any consent, substitution, approval or amendment required to novate or assign all obligations under agreements, leases, licenses and other obligations or Liabilities for which a member of the GE Group and a member of the Genworth Group are jointly or severally liable and that do not constitute Genworth Liabilities, or to obtain in writing the unconditional release of all parties to such arrangements other than any member of the GE Group, so that, in any such case, the members of the GE Group will be solely responsible for such Liabilities; provided, however, that neither GE nor Genworth shall be obligated to pay any consideration therefor to any third party from whom any such consent, approval, substitution or amendment is requested.

24

---

(b) If GE or Genworth is unable to obtain, or to cause to be obtained, any such required consent, approval, release, substitution or amendment, the applicable member of the Genworth Group shall continue to be bound by such agreement, lease, license or other obligation and, unless not permitted by Law or the terms thereof, GE shall cause a member of the GE Group, as agent or subcontractor for such member of the Genworth Group, to pay, perform and discharge fully all the obligations or other Liabilities of such member of the Genworth Group thereunder from and after the Closing Date. GE shall indemnify each Genworth Indemnified Party and hold each of them harmless against any Liabilities (other than Genworth Liabilities) arising in connection therewith; provided that pursuant hereto GE shall have no obligation to indemnify any Genworth Indemnified Party that has engaged in any knowing violation of Law, fraud or misrepresentation in connection therewith. Genworth shall cause each member of the Genworth Group without further consideration, to pay and remit, or cause to be paid or remitted, to GE or to another member of the GE Group specified by GE, promptly all money, rights and other consideration received by it or any member of the Genworth Group in respect of such performance (unless any such consideration is a Genworth Asset). If and when any such consent, approval, release, substitution or amendment shall be obtained or such agreement, lease, license or other rights or obligations shall otherwise become assignable or able to be novated, Genworth shall promptly assign, or cause to be assigned, all its rights, obligations and other Liabilities thereunder or any rights or obligations of any member of the Genworth Group to GE or to another member of the GE Group specified by GE without payment of further consideration and GE, without the payment of any further consideration shall, or shall cause such other member of the GE Group to, assume such rights and obligations.

#### 2.9 European Creditor Business.

In furtherance of the transactions contemplated by this Agreement and without limiting any other provision hereof, the parties intend that the transfer of the European Creditor Business into the Genworth Group shall be effected by means of the documentation and procedures relating to:

(a) the UK Transfer Plan under which it is proposed that the Assets and Liabilities of FACL be transferred subsequent to the Closing Date to FINCL upon the effectiveness of such plan in accordance with the provisions of Part VII of the Financial Services and Markets Act 2000 and Section 2.1(b) of this Agreement;

(b) the French Transfer Plan and the French Transfer Agreement under which it is proposed that the Assets and Liabilities of the payment protection business of Vie Plus S.A. be transferred subsequent to the Closing Date to a member of the Genworth Group upon the effectiveness of the French Transfer Plan in accordance with the terms of the French Transfer Plan, the French Transfer Agreement and Section 2.1(b) of this Agreement;

- (c) the FACL Reinsurance Agreement, FICL Reinsurance Agreement and French Reinsurance Agreement; and

- (d) the transfer of the stock of the entities forming a part of the European Creditor Business listed in Part A of Schedule 2.9 of this Agreement.

2.10 FACL Bonds.

(a) In respect of the FACL Bond Portfolio which forms part of the Assets and Liabilities of FACL to be transferred to FINCL pursuant to the UK Transfer Plan (as referred to in Section 2.9(a)), the parties agree to use their commercially reasonable efforts to implement indemnity reinsurance arrangements as soon as is reasonably practicable following Closing under which all of the Liabilities relating to the FACL Bond Portfolio which remain unsatisfied or outstanding as at the inception date of such arrangements (whether such Liabilities are current or future, certain or contingent) are fully assumed by GE Life Limited (or another appropriate member of the GE Group) (the "FACL Bond Portfolio Reinsurance"). The parties further agree that the FACL Bond Portfolio Reinsurance will continue in force until the earlier of:

- (i) the completion of the transfer of the FACL Bonds to GE Life Limited (or another appropriate member of the GE Group) pursuant to Section 2.10(b); and
- (ii) the date upon which Genworth ceases to have any interest in or Liabilities in respect of the FACL Bond Portfolio.

(b) In respect of the FACL Bonds which form part of the Assets and Liabilities of FACL to be transferred to FINCL pursuant to the UK Transfer Plan (as referred to in Section 2.9(a)), the parties agree to procure that the FACL Bonds are transferred from FINCL (or from FACL itself if the UK Transfer Plan has not become effective by December 31, 2004 and FACL is transferred into Genworth under the FACL Fall-back Stock Transfer Agreement) to an appropriate member of the GE Group by way of an insurance business transfer pursuant to Part VII of the Financial Services and Markets Act 2000. Each of the parties agree to procure that its relevant Subsidiaries shall use their commercially reasonable efforts to effect the transfer of the FACL Bonds pursuant to this Section 2.10(b) as soon as is reasonably practicable following the UK Transfer Date and in any event within nine months of the UK Transfer Date (or such longer period as the parties may agree).

(c) GE will procure the provision of administration services relating to the FACL Bond Portfolio from Closing upon the terms set out in the European Transition Services Agreement until the earlier of:

- (i) the completion of the transfer of the FACL Bonds pursuant to Section 2.10(b); and
- (ii) the date upon which Genworth ceases to have any interest in or Liabilities in respect of the FACL Bond Portfolio.

ARTICLE III

INTERCOMPANY TRANSACTIONS AS OF THE CLOSING DATE

3.1 Time and Place of Closing. Subject to the terms and conditions of this Agreement, all transactions contemplated by this Agreement shall be consummated at a closing (the "Closing") to be held at the offices of Weil, Gotshal & Manges LLP, 767 Fifth Avenue, New York, New York 10153, at 10:00 A.M. EST, on the date on which (and after) the Underwriting Agreements are executed and delivered by each of the parties thereto or at such other place or at such other time or on such other date as GE and Genworth may mutually agree upon in writing (the day on which the Closing takes place being the "Closing Date").

3.2 Pre-Closing Transactions. Prior to the Closing Date, the appropriate parties hereto entered into or effected, as the case may be, and (as necessary) caused their respective Subsidiaries to enter into or effect, the agreements and transactions set forth below, in each case in the order set forth below:

(a) All of the capital stock of GE Mortgage Insurance Limited, GE Mortgage Insurance (Guernsey) Limited and the entities listed in Part A of Schedule 2.9 has been transferred to GEFAHI or a wholly owned subsidiary of GEFAHI.

(b) The appropriate parties hereto entered into, and (as necessary) caused their respective Subsidiaries to enter into, the agreements set forth below (items (ii) through (vii) below being referred to as the "Reinsurance-Related Documents"):

- (i) the Pre-Closing Documents;
- (ii) the JLIC Recapture Agreement;
- (iii) the UFLIC Agreements;
- (iv) the Reinsurance Agreements;
- (v) the Trust Agreements;
- (vi) the Capital Maintenance Agreement; and
- (vii) the Derivatives Management Services Agreement.

(c) FHL transferred by dividend all shares of capital stock of UFLIC held by FHL to its shareholders GECA and GEFAHI, GECA transferred by dividend all shares of capital stock of UFLIC then held by GECA to GNA, GNA transferred by dividend all such shares of UFLIC capital stock to GEFAHI, GEFAHI transferred by dividend all such shares of UFLIC capital stock received from GNA and FHL to GEI and General Electric Capital Services Inc. purchased all shares of capital stock of UFLIC from GEI.

- (d) JLIC paid accrued interest and principal amounts under the JLIC Surplus Notes in the amounts and to the entities outlined in Schedule 3.2(d).
- (e) GEFAHI purchased all shares of capital stock of Viking from GELCO Corporation pursuant to the Viking Stock Purchase Agreement.

(f) The dividends outlined in Schedule 3.2(f) were paid by the entities and in the amounts set forth therein.

(g) GEFAHI contributed approximately \$2.16 billion in cash and/or securities to the capital of UFLIC.

(h) GEFAHI contributed cash and/or securities to the capital of GNA in an amount equal to the tax benefit realized by GECA and other members of the Genworth Group (such other members agreed upon by GE and Genworth immediately prior to such contribution) as a result of losses incurred in the transfer of securities to members of the GE Group pursuant to the Reinsurance Agreements, which tax benefit will be recognized by GEFAHI as a result of the Separation and the Section 338(h)(10) elections to be made in respect of such members of the Genworth Group.

(i) FHL redeemed its \$250 million series A preferred stock, par value \$1,000 per share, held by GEFAHI, along with accrued dividends through date of payment.

(j) All amounts received by GEFAHI from its Subsidiaries in payment of intercompany receivables related to accounts payable owed by GEFAHI to its upstream Affiliates were used to pay such accounts payable.

3.3 Closing Transactions. In each case subject to Section 3.8, after execution and delivery of the Underwriting Agreements by all parties thereto, at the Closing:

(a) The Separation contemplated by Article II shall be effected.

(b) The appropriate parties hereto shall enter into, and (as necessary) shall cause their respective Subsidiaries to enter into, the agreements set forth below (collectively with the Reinsurance-Related Documents, the UK Transfer Plan, the French Transfer Plan, the French Transfer Agreement and the Pre-Closing Documents, the "Transaction Documents"):

(i) the Transition Services Agreement;

(ii) the Registration Rights Agreement;

(iii) the Tax Matters Agreement;

(iv) the Employee Matters Agreement;

28

---

(v) the Transitional Trademark Agreement;

(vi) the Intellectual Property Cross License Agreement;

(vii) the Outsourcing Services Separation Agreement;

(viii) the European Transition Services Agreement;

(ix) the Investment Management Agreements;

(x) the Viking Agreement;

(xi) the Liability and Portfolio Asset Management Agreements;

(xii) the Transition Matters Agreement;

(xiii) the International Tax Matters Agreements;

(xiv) the Mortgage Services Agreement;

(xv) the UFLIC ESG Services Agreement;

(xvi) the Business Services Agreement;

(xvii) the Genworth Contingent Note;

(xviii) the Genworth Promissory Note; and

(xix) the Transfer Documents.

3.4 Amended and Restated Certificate of Incorporation and Amended and Restated Bylaws. At or prior to the Closing, GE and Genworth shall each take all necessary action that may be required to provide for the adoption by Genworth of the Amended and Restated Certificate of Incorporation of Genworth in substantially the form attached hereto as Exhibit LL, and the Amended and Restated Bylaws of Genworth in substantially the form attached hereto as Exhibit MM.

3.5 Transfers of Assets and Assumption of Liabilities. In furtherance of the assignment, transfer and conveyance of Genworth Assets and the assumption of Genworth Liabilities set forth in Section 2.1(a)(i) and Section 2.1(a)(ii), on the Closing Date (i) GE shall execute and deliver, and shall cause its Subsidiaries to execute and deliver, such bills of sale, stock powers, certificates of title, assignments of contracts and other instruments of transfer, conveyance and assignment as and to the extent necessary to evidence the transfer, conveyance and assignment of all of GE's and its Subsidiaries' (other than Genworth and its Subsidiaries) right, title and interest in and to the Genworth Assets to Genworth and its Subsidiaries, and (ii) Genworth shall execute and deliver such assumptions of contracts and other instruments of assumption as and to the extent necessary to evidence the valid and effective assumption of the Genworth Liabilities by

29

---



3.6 Transfer of Excluded Assets; Assumption of Excluded Liabilities.

(a) To the extent any Excluded Asset or Excluded Liability is transferred to a member of the Genworth Group at the Closing or is owned or held by a member of the Genworth Group after the Closing, from and after the Closing:

(i) Genworth shall, and shall cause its applicable Subsidiaries to, promptly contribute, assign, transfer, convey and deliver to GE or certain of its Subsidiaries designated by GE, and GE or such Subsidiaries shall accept from Genworth and its applicable Subsidiaries, all of Genworth's and such Subsidiaries' respective rights, titles and interests in and to such Excluded Assets;

(ii) GE and certain of its Subsidiaries designated by GE, shall promptly accept, assume and agree faithfully to perform, discharge and fulfill all such Excluded Liabilities in accordance with their respective terms; and

(iii) In furtherance of the assignment, transfer and conveyance of Excluded Assets and the assumption of Excluded Liabilities set forth in Section 3.6(a)(i) and Section 3.6(a)(ii): (x) Genworth shall execute and deliver, and shall cause its Subsidiaries to execute and deliver, such bills of sale, certificates of title, assignments of contracts and other instruments of transfer, conveyance and assignment as and to the extent necessary to evidence the transfer, conveyance and assignment of all of Genworth's and its Subsidiaries' right, title and interest in and to the Excluded Assets to GE and its Subsidiaries, and (y) GE shall execute and deliver such assumptions of contracts and other instruments of assumption as and to the extent necessary to evidence the valid and effective assumption of the Excluded Liabilities by GE. All of the foregoing documents contemplated by this Section 3.6(a)(iii) shall be referred to collectively herein as the "Genworth Transfer Documents" and, together with the GE Transfer Documents, the "Transfer Documents."

(iv) To the extent that the transfer of such Excluded Assets and the assumption of such Excluded Liabilities requires any Governmental Approvals or Consents, the parties shall use their commercially reasonable efforts to obtain such Governmental Approvals and Consents; provided however that neither GE nor Genworth shall be obligated to contribute capital in any form to any entity in order to obtain such Governmental Approvals and Consents.

(v) If and to the extent that the valid, complete and perfected transfer or assignment to the GE Group of any Excluded Assets or the assumption by the GE Group of any Excluded Liabilities would be a violation of applicable Law or require any Consent or Governmental Approval, then, unless the parties hereto mutually shall otherwise determine, the transfer or assignment to the GE Group of such Excluded Assets or the assumption by the GE Group of such Excluded Liabilities shall be automatically deemed deferred and any such purported transfer, assignment or assumption shall be null

30

---

and void until such time as all legal impediments are removed or such Consents or Governmental Approvals have been obtained.

(b) If any transfer or assignment of any Excluded Asset intended to be transferred or assigned hereunder or any assumption of any Excluded Liability intended to be assumed by GE hereunder is not consummated on the Closing Date, whether as a result of the failure to obtain any required Governmental Approvals or Consents under Section 3.6(a)(iv) or for any other reason, then, insofar as reasonably possible, (i) the member of the Genworth Group retaining such Excluded Asset shall thereafter hold such Excluded Asset for the use and benefit of GE (at GE's expense) and (ii) GE shall, or shall cause its applicable Subsidiary to, pay or reimburse the member of the Genworth Group retaining such Excluded Liability for all amounts paid or incurred in connection with such Excluded Liability. In addition, the member of the Genworth Group retaining such Excluded Asset shall, insofar as reasonably possible and to the extent permitted by applicable Law, treat such Excluded Asset in the ordinary course of business in accordance with past practice and take such other actions as may be reasonably requested by GE in order to place GE in the same position as if such Excluded Asset had been transferred as contemplated hereby and so that all the benefits and burdens relating to such Excluded Asset, including possession, use, risk of loss, potential for gain, and dominion, control and command over such Excluded Asset, is to inure from and after the Closing Date to the GE Group.

(c) If and when the Consents and Governmental Approvals, the absence of which caused the deferral of transfer of any Excluded Asset or the deferral of assumption of any Excluded Liability, are obtained, the transfer of the applicable Excluded Asset or Excluded Liability shall be effected in accordance with the terms of this Agreement and/or the applicable Transaction Document.

(d) Any member of the Genworth Group retaining an Excluded Asset or Excluded Liability due to the deferral of the transfer of such Excluded Asset or the deferral of the assumption of such Excluded Liability shall not be obligated, in connection with the foregoing, to expend any money unless the necessary funds are advanced (or otherwise made available) by GE or the member of the GE Group intended to be subject to the Excluded Liability, other than reasonable out-of-pocket expenses, attorneys' fees and recording or similar fees, all of which shall be promptly reimbursed by GE or the member of the GE Group entitled to such Excluded Asset or intended to be subject to such Excluded Liability.

(e) Pursuant to and in accordance with this Section 3.6, the Excluded Assets, Excluded Contracts, and Excluded Liabilities of Financial Insurance Group Services Limited relating to the businesses or the support of the businesses of the members of the GEIH Group (as defined in the European Transition Services Agreement but for the purposes of this Section excluding any European Creditor Business Entity) (the "GEIH Business") listed on Schedules 2.2(b)(i), 2.2(b)(ii) and 2.3(b)(iv) respectively are to be transferred to GE or its designated Subsidiaries on the Closing Date.

31

---

3.7 The Initial Public Offering and the Concurrent Offerings. Genworth shall (i) consult with, and cooperate in all respects with, the GE Parties in connection with the pricing of the (x) Class A Common Stock to be offered in the Initial Public Offering and (y) Equity Units and Series A Preferred Stock to be offered in the Concurrent Offerings, (ii) at the direction of any GE Party, execute and deliver the Underwriting Agreements in such form and substance as is reasonably satisfactory to the GE Parties and (iii) at the direction of any GE Party, promptly take any and all actions necessary or desirable to consummate the Initial Public Offering and the Concurrent Offerings as contemplated by the IPO Registration Statement, the Equity Units Registration Statement, the Series A Preferred Stock Registration Statement and the Underwriting Agreements.

3.8 Rescission. Notwithstanding anything to the contrary set forth in this Agreement, if delivery of the Firm Public Offering Shares to the Underwriters against payment therefor is not complete within four (4) Business Days after the Closing Date, all transactions theretofore completed under this Agreement or any of the Transaction Documents (excluding the transactions set forth in Section 3.2(a) and any dividends described in Section 3.2) shall immediately be rescinded in all respects and this Agreement and all of the Transaction Documents shall terminate and all assets transferred pursuant to the Transaction Documents shall be returned to the entities that transferred such assets, and all assumptions of liabilities hereunder and thereunder shall be rescinded and nullified.

3.9 European Transfers.

(a) GE and Genworth shall cause their relevant respective Subsidiaries to use all commercially reasonable efforts to cause the UK Transfer Plan and the French Transfer Plan to become effective (and to consummate the transactions contemplated thereby and by the French Transfer Agreement) as promptly as practicable. The consideration for the transfers to be effected pursuant to the UK Transfer Plan is set forth in the Debt Release Agreement. The consideration for the transfers to be

effected pursuant to the French Transfer Agreement is set forth in Schedule 3.9(a).

(b) If the UK Transfer Plan has not taken effect by December 31, 2004, GE and Genworth shall cause their relevant respective Subsidiaries to enter into the FACL Fall-back Stock Transfer Agreement promptly thereafter in order to transfer to Genworth all of the outstanding shares of capital stock of FACL and the other entities listed in Part B of Schedule 2.9. The consideration for the transfers to be effected pursuant to the FACL Fall-back Stock Transfer Agreement shall be the same as the consideration set forth in the Debt Release Agreement.

(c) If the French Transfer Plan and the French Transfer Agreement have not taken effect by December 31, 2004, the consideration for the transfers contemplated by that Plan and that Agreement shall be adjusted as provided in Schedule 3.9(c).

32

---

### 3.10 Tax Matters.

(a) GE and Genworth have entered into the Tax Matters Agreement contemporaneously with the execution and delivery of this Agreement. To the extent that any representations, warranties, covenants and agreements between the parties with respect to Tax matters are set forth in the Tax Matters Agreement, the tax sharing agreements and arrangements specifically identified therein, the International Tax Matters Agreements and the tax matters agreements described in Section 3.10(b) (collectively, for purposes of this Section, the "Tax Agreements"), such Tax matters shall be governed exclusively by the Tax Agreements and not by this Agreement.

(b) As soon as reasonably practicable after a determination has been made as to the members of the Genworth Group for which elections will be made under Section 338(h)(10) of the Code, (a) Genworth shall cause GECA and each GECA Subsidiary for which a Section 338(h)(10) election has been made to enter into a tax matters agreement substantially in the form attached hereto as Exhibit OO, and (b) Genworth shall enter into, and shall cause each of its Subsidiaries (other than life insurance Subsidiaries) for which a Section 338(h)(10) election has been made to enter into, a tax matters agreement substantially in the form attached hereto as Exhibit PP.

## ARTICLE IV

### FINANCIAL AND OTHER INFORMATION

4.1 Annual Financial Information. Genworth agrees that, if members of the GE Group beneficially own, in the aggregate, (excluding for such purposes shares of Genworth Common Stock beneficially owned by GE but not for its own account, including (in such exclusion) beneficial ownership which arises by virtue of some entity that is an Affiliate of GE being a sponsor of or advisor to a mutual or similar fund that beneficially owns shares of Genworth Common Stock) on any date during a fiscal year at least five percent (5%) of the then outstanding Genworth Common Stock, Genworth shall deliver to GE the Corporate Reporting Data set forth on Schedule 4.1 for such year in respect of the Applicable Accounting Method in effect as of the first day of such fiscal year. Genworth shall deliver the financial data and schedules comprising such Corporate Reporting Data within the time periods specified by GE, which time periods shall be specified by GE in writing by no later than fifteen (15) days prior to the end of each fiscal year. All annual consolidated financial statements of Genworth and its Subsidiaries delivered to GE shall set forth in each case in comparative form the consolidated figures for the previous fiscal year prepared in accordance with Article 10 of Regulation S-X and consistent with the level of detail provided in comparable financial statements furnished by GEFA to GE prior to the Closing Date. The Corporate Reporting Data shall include all statistical information necessary for inclusion in any GE Group member's annual earnings press release, along with appropriate supporting documentation. The Corporate Reporting Data shall include (i) a discussion and analysis by management of Genworth's and its Subsidiaries' consolidated financial condition and results of operations for the requisite years, including, without limitation, an explanation of any material adverse change, all in reasonable detail and prepared in accordance with Item 303(a) of

33

---

Regulation S-K and (ii) a discussion and analysis of Genworth's and its Subsidiaries' consolidated financial condition and results of operations for the requisite years, including, without limitation, an explanation of any material adverse change, all in reasonable detail and prepared in accordance with Item 303(a) of Regulation S-K, prepared for inclusion in the annual report to stockholders of any member of the GE Group. No later than the day prior to the day Genworth publicly files its Annual Report on Form 10-K with the SEC or otherwise, Genworth shall deliver to GE the final form of its Annual Report on Form 10-K, together with all certifications required by applicable Law by each of the chief executive officer and chief financial officer of Genworth and an opinion thereon by Genworth's independent certified public accountants. Genworth shall, if requested by GE, also deliver to GE all of the information required to be delivered in Schedule 4.1 with respect to each Subsidiary of Genworth (other than GELAAC or any other Subsidiary of Genworth required to file financial statements with the SEC solely as a result of insurance products offered by such Subsidiary) which is itself required to file financial statements with the SEC or otherwise make financial statements publicly available (other than statutory financial statements filed with state insurance regulatory authorities, which are addressed in Section 4.5(c)), with such financial statements to be provided in the same manner and detail and on the same time schedule as those financial statements of Genworth required to be delivered to GE pursuant to Schedule 4.1.

4.2 Quarterly Financial Information. Genworth agrees that, if members of the GE Group beneficially own, in the aggregate, (excluding for such purposes shares of Genworth Common Stock beneficially owned by GE but not for its own account, including (in such exclusion) beneficial ownership which arises by virtue of some entity that is an Affiliate of GE being a sponsor of or advisor to a mutual or similar fund that beneficially owns shares of Genworth Common Stock) on any date during a fiscal quarter at least five percent (5%) of the then outstanding Genworth Common Stock, Genworth shall deliver to GE the Corporate Reporting Data set forth on (i) Schedule 4.2(a) for the first and second quarter of each year and (ii) Schedule 4.2(b) for the third quarter of each year, in each case, in respect of the Applicable Accounting Method in effect as of the first day of such fiscal quarter. Genworth shall deliver the financial data and schedules comprising such Corporate Reporting Data within the time periods specified by GE, which time periods shall be specified by GE in writing by no later than fifteen (15) days prior to the end of each fiscal quarter. All quarterly consolidated financial statements of Genworth and its Subsidiaries delivered to GE shall include financial statements for such quarterly periods and for the period from the beginning of the current fiscal year to the end of such quarter, setting forth in each case in comparative form for each such fiscal quarter of Genworth the consolidated figures for the corresponding quarter and periods of the previous fiscal year prepared in accordance with Article 10 of Regulation S-X and consistent with the level of detail provided in comparable financial statements furnished by GEFA to GE prior to the Closing Date. The Corporate Reporting Data shall include all statistical information necessary for inclusion in any GE Group member's quarterly earnings press release, along with appropriate supporting documentation. The Corporate Reporting Data shall include a discussion and analysis by management of Genworth's and its Subsidiaries' consolidated financial condition and results of operations for the requisite quarters, including, without

34

---

limitation, an explanation of any material adverse change, all in reasonable detail and prepared in accordance with Item 303(b) of Regulation S-K. No later than the day prior to the day Genworth publicly files a Quarterly Report on Form 10-Q with the SEC or otherwise, Genworth shall deliver to GE the final form of its Quarterly Report on Form 10-Q, together with all certifications required by applicable Law by each of the chief executive officer and chief financial officer of Genworth. Genworth shall, if requested by GE, also deliver to GE all of the information required to be delivered in Schedules 4.2(a) and (b) with respect to each Subsidiary of Genworth (other than GELAAC or any other Subsidiary of Genworth required to file financial statements with the SEC solely as a result of insurance products offered by such Subsidiary) which is itself required to file financial statements with the SEC or otherwise make financial statements publicly available (other than statutory financial statements filed with state insurance regulatory authorities, which are addressed in Section 4.5(c)), with such financial statements to be provided in the same manner and detail and on the same time schedule as those

financial statements of Genworth required to be delivered to GE pursuant to Schedules 4.2(a) and (b).

4.3 GE's Operating Reviews. Genworth agrees that, if members of the GE Group beneficially own, in the aggregate, (excluding for such purposes shares of Genworth Common Stock beneficially owned by GE but not for its own account, including (in such exclusion) beneficial ownership which arises by virtue of some entity that is an Affiliate of GE being a sponsor of or advisor to a mutual or similar fund that beneficially owns shares of Genworth Common Stock) on any date during a fiscal quarterly or annual period at least five percent (5%) of the then outstanding Genworth Common Stock, Genworth shall deliver to GE the FP&A Reports set forth on Schedule 4.3 for such quarterly or annual period in respect of the Applicable Accounting Method in effect as of the first day of such period. Genworth shall deliver the financial data and schedules comprising such FP&A Reports during each fiscal year within the time periods specified by GE in writing by no later than fifteen (15) days prior to the end of the preceding fiscal year, or within any other time periods specified by GE in writing thereafter, but in any event prior to fifteen (15) days before the date such FP&A Report is required to be delivered to GE. Genworth shall provide GE an opportunity to meet with management of Genworth to discuss such FP&A Reports upon reasonable notice during normal business hours.

4.4 General Financial Statement Requirements. All information provided by Genworth or any of its Subsidiaries to GE pursuant to this Article IV shall be consistent in terms of format and detail and otherwise with the procedures and practices in effect prior to the Closing Date with respect to the provision of such financial and other information by GEFA to GE (and where appropriate, as presently presented in financial and other reports delivered to the board of directors of GE), with such changes therein as may be reasonably requested by GE from time to time, and any changes in such procedures or practices that are required in order to comply with the rules and regulations of the SEC, as applicable.

4.5 Twenty Percent Threshold. Genworth agrees that, if members of the GE Group beneficially own, in the aggregate, (excluding for such purposes shares of

35

---

Genworth Common Stock beneficially owned by GE but not for its own account, including (in such exclusion) beneficial ownership which arises by virtue of some entity that is an Affiliate of GE being a sponsor of or advisor to a mutual or similar fund that beneficially owns shares of Genworth Common Stock) on any date during a fiscal year more than twenty percent (20%) of the then outstanding Genworth Common Stock, or, notwithstanding such percentage, if any member of the GE Group is required during any fiscal year, in accordance with GAAP, to account for its investment in Genworth on a consolidated basis or under the equity method of accounting, then in respect of such fiscal year:

(a) Maintenance of Books and Records. Genworth shall, and shall cause each of its consolidated Subsidiaries to, (i) make and keep books, records and accounts, which, in reasonable detail, accurately and fairly reflect the transactions and dispositions of the assets of Genworth and such Subsidiaries and (ii) devise and maintain a system of internal accounting controls sufficient to provide reasonable assurances that: (x) transactions are executed in accordance with management's general or specific authorization, (y) transactions are recorded as necessary (1) to permit preparation of financial statements in conformity with GAAP or any other criteria applicable to such statements and (2) to maintain accountability for assets and (z) access to assets is permitted only in accordance with management's general or specific authorization.

(b) Fiscal Year. Genworth shall, and shall cause each of its consolidated subsidiaries to, maintain a fiscal year which commences on January 1 and ends on December 31 of each calendar year; provided that, if on the Closing Date any consolidated Subsidiary of Genworth has a fiscal year which ends on a date other than December 31, Genworth shall use its commercially reasonable efforts to cause such Subsidiary to change its fiscal year to one which ends on December 31 if such change is reasonably practicable.

(c) Quarterly and Annual Reports Furnished to State Insurance Regulatory Authorities. Promptly following the filing by Genworth or any Subsidiary of Genworth of quarterly or annual reports with any and all state insurance regulatory authorities in each jurisdiction in which such reports are required to be filed, Genworth shall deliver the final forms of such reports to GE.

(d) Other Financial Information. Genworth shall provide to GE upon request such other financial information and analyses of Genworth and its Subsidiaries that may be necessary for any member of the GE Group to (1) comply with applicable financial reporting requirements or its customary financial reporting practices or (2) respond in a timely manner to any reasonable requests for information regarding Genworth and its Subsidiaries received by GE from investors or financial analysts; provided, however, that neither GE nor any member of the GE Group shall disclose any material, non-public information of Genworth except pursuant to policies and procedures mutually agreed upon by GE and Genworth for the disclosure of such information and except as required by applicable Law. In connection therewith, Genworth shall also permit GE, the GE Auditors and other Representatives of GE to

36

---

discuss the affairs, finances and accounts of any member of the Genworth Group with the officers of Genworth and the Genworth Auditors, all at such times and as often as GE may reasonably request upon reasonable notice during normal business hours.

(e) Public Information and SEC Reports. Genworth and each of its Subsidiaries that files information with the SEC shall cooperate with GE in preparing reports, notices and proxy and information statements to be sent or made available by Genworth or such Subsidiaries to their security holders, all regular, periodic and other reports filed under Sections 13, 14 and 15 of the Exchange Act by Genworth or such Subsidiaries and all registration statements and prospectuses to be filed by Genworth or such Subsidiaries with the SEC or any securities exchange pursuant to the listed company manual (or similar requirements) of such exchange (collectively, "Genworth Public Documents") and deliver to GE (to the attention of its Senior Securities Counsel), no later than the date the same are printed for distribution to its shareholders, sent to its shareholders or filed with the SEC, whichever is earliest, final copies of all Genworth Public Documents. Genworth shall file its Quarterly Reports on Form 10-Q and its Annual Reports on Form 10-K with the SEC immediately (and in no event later than one hour) following GE's filing of its quarterly and annual reports with the SEC for the corresponding period. Genworth shall cooperate with GE in preparing all press releases and other statements to be made available by Genworth or any of its Subsidiaries to the public, including, without limitation, information concerning material developments in the business, properties, results of operations, financial condition or prospects of Genworth or any of its Subsidiaries. GE shall have the right to review, reasonably in advance of public release or release to financial analysts or investors and in a manner consistent with the procedures and practices in effect prior to the Closing Date with respect to press releases issued by GEFA (1) all press releases and other statements to be made available by Genworth or any of its Subsidiaries to the public and (2) all reports and other information prepared by Genworth or any of its Subsidiaries for release to financial analysts or investors; provided, however, that neither GE nor any member of the GE Group shall disclose any material, non-public information of Genworth except pursuant to policies and procedures mutually agreed upon by GE and Genworth for the disclosure of such information and except as required by applicable Law; provided, further, that at any time when members of the GE Group beneficially own, in the aggregate, (excluding for such purposes shares of Genworth Common Stock beneficially owned by GE but not for its own account, including (in such exclusion) beneficial ownership which arises by virtue of some entity that is an Affiliate of GE being a sponsor of or advisor to a mutual or similar fund that beneficially owns shares of Genworth Common Stock) fifty percent (50%) or less of the then outstanding Genworth Common Stock, GE shall only have the right to review such press releases, public statements, reports and other information in advance if necessary for any member of the GE Group to (1) comply with applicable financial reporting requirements or its customary financial reporting practices or (2) respond to any reasonable requests for information regarding Genworth and its Subsidiaries received by GE from investors or financial analysts. No press release, report, registration, information or proxy statement, prospectus or other document which refers, or contains information with respect, to any member of the GE Group shall be filed with the SEC or otherwise made public or released to any financial analyst or investor by Genworth or any of its Subsidiaries

37

---

without the prior written consent of GE with respect to those portions of such document that contain information with respect to any member of the GE Group except as may be required by Law (in such cases Genworth shall use its reasonable best efforts to notify the relevant member of the GE Group and to obtain such member's consent before making such a filing with the SEC or otherwise making any such information public).

(f) Meetings with Financial Analysts. Genworth shall notify GE reasonably in advance of the date of all scheduled meetings and conference calls to be held between Genworth and members of the investment community (including any financial analysts), and of any conferences to be attended by management of Genworth with members of the investment community, and shall consult with GE as to the appropriate timing for all such meetings, calls and conferences. With respect to any such meeting, call or conference to be held at a time when members of the GE Group beneficially own, in the aggregate, (excluding for such purposes shares of Genworth Common Stock beneficially owned by GE but not for its own account, including (in such exclusion) beneficial ownership which arises by virtue of some entity that is an Affiliate of GE being a sponsor of or advisor to a mutual or similar fund that beneficially owns shares of Genworth Common Stock) more than fifty percent (50%) of the then outstanding Genworth Common Stock, Genworth shall not schedule such meeting or call or attend such conference on any date to which GE objects. The foregoing shall not require Genworth to notify GE of one-on-one discussions between management of Genworth and members of the investment community (including any financial analysts).

(g) Earnings Releases. GE agrees that, unless required by Law or unless Genworth shall have consented thereto, no member of the GE Group will publicly release any quarterly, annual or other financial information of Genworth or any of its Subsidiaries ("Genworth Information") delivered to GE pursuant to this Article IV prior to the time that GE publicly releases financial information of GE for the relevant period. GE will consult with Genworth on the timing of their annual and quarterly earnings releases and GE and Genworth will give each other an opportunity to review the information therein relating to Genworth and its Subsidiaries and to comment thereon; provided that GE shall have the sole right to determine the timing of all such releases if GE and Genworth disagree. Genworth shall publicly release its financial results for each annual and quarterly period immediately (and in no event later than one hour) following GE's release of its financial results for the corresponding period. If any member of the GE Group is required by Law to publicly release such Genworth Information prior to the public release of GE's financial information, GE will give Genworth notice of such release of Genworth Information as soon as practicable but no later than two days prior to such release of Genworth Information.

4.6 GE Public Filings. Genworth shall cooperate fully, and cause its accountants to cooperate fully, with GE to the extent reasonably requested by GE in the preparation of GE's press releases, public earnings releases, Quarterly Reports on Form 10-Q, Annual Reports to Shareholders, Annual Reports on Form 10-K, any Current Reports on Form 8-K and any amendments thereto and any other proxy, information and registration statements, reports, notices, prospectuses and any other filings made by GE

38

---

or any of its Subsidiaries with the SEC, any national securities exchange or otherwise made publicly available (collectively, "GE Public Filings"). Genworth agrees to provide to GE all information that GE reasonably requests in connection with any such GE Public Filings or that, in the judgment of GE's legal department, is required to be disclosed therein under any Law. Genworth agrees to use reasonable best efforts to provide such information in a timely manner to enable GE to prepare, print and release such GE Public Filings on such date as GE shall determine. If and to the extent reasonably requested by GE, Genworth shall diligently and promptly review all drafts of such GE Public Filings and prepare in a diligent and timely fashion any portion of such GE Public Filing pertaining to Genworth or its Subsidiaries. Prior to any printing or public release of any GE Public Filing, an appropriate executive officer of Genworth, shall, if requested by GE, continue the existing practice of certifying and representing that the information provided by Genworth relating to Genworth, in such GE Public Filing is accurate, true and correct in all material respects. Unless required by Law, without the prior consent of GE, Genworth shall not publicly release any financial or other information which conflicts with the information with respect to Genworth, any Affiliate of Genworth or the Genworth Group that is provided by Genworth for any GE Public Filing.

4.7 GE Annual Statements. In connection with any GE Group member's preparation of its audited annual financial statements and its Annual Reports to Shareholders (collectively the "GE Annual Statements"), during any fiscal year in which the members of the GE Group own, in the aggregate, (excluding for such purposes shares of Genworth Common Stock beneficially owned by GE but not for its own account, including (in such exclusion) beneficial ownership which arises by virtue of some entity that is an Affiliate of GE being a sponsor of or advisor to a mutual or similar fund that beneficially owns shares of Genworth Common Stock) more than twenty percent (20%) of the then outstanding Genworth Common Stock, (or such lesser percentage during any fiscal year that any member of the GE Group is required, in accordance with GAAP, to account for its investment in Genworth on a consolidated basis or under the equity method of accounting), Genworth agrees as follows:

(a) Coordination of Auditors' Opinions. Genworth will use its commercially reasonable efforts to enable its independent certified public accountants (the "Genworth Auditors") to complete their audit such that they will date their opinion on Genworth's audited annual financial statements on the same date that GE independent certified public accountants (the "GE Auditors") date their opinion on the GE Annual Statements, and to enable GE to meet its timetable for the printing, filing and public dissemination of the GE Annual Statements.

(b) Cooperation. Genworth will provide to GE on a timely basis all information that GE or any of its Subsidiaries reasonably requires to meet its schedule for the preparation, printing, filing, and public dissemination of any GE Public Filing. Without limiting the generality of the foregoing, Genworth will provide all required financial information with respect to it and its consolidated Subsidiaries to the GE Auditors and management in a sufficient and reasonable time and in sufficient detail to permit such auditors to take all steps and perform all review necessary to provide

39

---

sufficient assistance to such auditors with respect to information to be included or contained in the GE Public Filings.

(c) Access to Personnel and Working Papers. Genworth will request the Genworth Auditors to make available to the GE Auditors both the personnel who performed or are performing the annual audit of Genworth and, consistent with customary professional practice and courtesy of such auditors with respect to the furnishing of work papers, work papers related to the annual audit of Genworth, in all cases within a reasonable time after the Genworth Auditors' opinion date, so that the GE Auditors are able to perform the procedures they consider necessary to take responsibility for the work of the Genworth Auditors as it relates to the GE Auditors' report on the GE Annual Statements, all within sufficient time to enable GE to meet its timetable for the printing, filing and public dissemination of the GE Annual Statements.

4.8 Fifty Percent Threshold. Genworth agrees that if members of the GE Group beneficially own, in the aggregate (excluding for such purposes shares of Genworth Common Stock beneficially owned by GE but not for its own account, including (in such exclusion) beneficial ownership which arises by virtue of some entity that is an Affiliate of GE being a sponsor of or advisor to a mutual or similar fund that beneficially owns shares of Genworth Common Stock) on any date during a fiscal year more than fifty percent (50%) of the then outstanding Genworth Common Stock, or, notwithstanding such percentage, if any member of the GE Group is required during any fiscal year, in accordance with GAAP, to consolidate Genworth's financial statements with its financial statements, then in respect of such fiscal year:

(a) Internal Auditors. Genworth shall provide GE, the GE Auditors or other Representatives of GE reasonable access upon reasonable notice during normal business hours to Genworth's and its Subsidiaries' books and records so that GE may conduct reasonable audits relating to the financial statements provided by Genworth pursuant to this Article IV, as well as to the internal accounting controls and operations of Genworth and its Subsidiaries; provided, however, that any such audits will be conducted in the same manner and using the same procedures as conducted on the date hereof for audits of GEFA including, but not limited to, reporting audit findings to management of the business or unit subject to the audit.

(b) Accounting Estimates and Principles. Genworth will give GE reasonable notice of any proposed material change in accounting estimates or material changes in accounting principles from those in effect with respect to GEFA, its Subsidiaries and the GE Affiliates that comprise the Genworth Group immediately prior to the Closing Date, and will give GE notice immediately following adoption of any such changes that are mandated or required by the SEC, the Financial Accounting Standards Board or the Public Company Accounting Oversight Board. In connection therewith, Genworth will consult with GE and, if requested by GE, Genworth will consult with the GE Auditors with respect thereto. As to material changes in accounting principles that could affect GE, Genworth will not make any such changes without GE's prior written consent, excluding changes that are mandated or required by the SEC, the Financial Accounting Standards Board or the Public Company Accounting Oversight

40

---

Board, if such a change would be sufficiently material to be required to be disclosed in Genworth's financial statements as filed with the SEC or otherwise publicly disclosed therein. If GE so requests, Genworth will be required to obtain the concurrence of the Genworth Auditors as to such material change prior to its implementation. GE will use its reasonable best efforts to promptly respond to any request by Genworth to make a change in accounting principles and, in any event, in sufficient time to enable Genworth to comply with its obligations under Section 4.1.

(c) Management Certification. Genworth's chief executive officer and Genworth's chief financial or accounting officer shall submit quarterly representations substantially in the form furnished to GE by GEI prior to the Closing Date (with such changes thereto prescribed by GE consistent with representations furnished to GE by other Subsidiaries of GE or as otherwise required by changes to applicable Law or stock exchange requirements) attesting to the accuracy and completeness of the financial and accounting records referred to therein in all material respects.

(d) Monthly and Other Financial Information. Genworth shall furnish to GE the intercompany information in the form and detail, and within the time periods, set forth in Schedule 4.8 and furnished by GEFA to GE prior to the Closing Date. With reasonable promptness, Genworth shall deliver to GE such additional financial and other information and data with respect to Genworth and its Subsidiaries and their business, properties, financial position, results of operations and prospects as from time to time may be reasonably requested by GE.

(e) Operating Review Process. Genworth shall conduct its own strategic and operational review process on the same schedule on which GE conducts its strategic and operational review process. GE acknowledges that, as a supplement to the information furnished by Genworth to GE pursuant to Section 4.3, GE shall conduct its strategic and operational reviews of Genworth through participation in meetings or other activities of the Genworth board of directors by the members of Genworth's board of directors that are elected by GE. To facilitate GE's participation in the process in this manner, Genworth shall hold all of its regularly scheduled board meetings at which its strategic and operational reviews are discussed within a time frame consistent with GE's strategic and operational review process. GE shall make a good faith attempt to conduct all other reviews of Genworth's operations, affairs, finances or results (other than those required to comply with applicable financial reporting requirements or its customary financial reporting practices) through participation in meetings or other activities of the Genworth board of directors by the members of Genworth's board of directors that are elected by GE. In connection with strategic, operational or other reviews, relevant GE personnel other than the members of Genworth's board of directors elected by GE may participate at GE's invitation. GE will notify Genworth in advance of any such additional attendees.

4.9 Accountants' Reports. Promptly, but in no event later than five Business Days following the receipt thereof, Genworth shall deliver to GE copies of all reports submitted to Genworth or any of its Subsidiaries by their independent certified

41

---

public accountants, including, without limitation, each report submitted to Genworth or any of its subsidiaries concerning its accounting practices and systems and any comment letter submitted to management in connection with their annual audit and all responses by management to such reports and letters.

#### 4.10 Agreement for Exchange of Information; Archives.

(a) Each of GE and Genworth, on behalf of its respective Group, agrees to provide, or cause to be provided, to the other Group, at any time before or after the Closing Date, as soon as reasonably practicable after written request therefor, any Information in the possession or under the control of such respective Group which the requesting party reasonably needs (i) to comply with reporting, disclosure, filing or other requirements imposed on the requesting party (including under applicable securities or tax Laws) by a Governmental Authority having jurisdiction over the requesting party, (ii) for use in any other judicial, regulatory, administrative, tax or other proceeding or in order to satisfy audit, accounting, claims, regulatory, litigation, tax or other similar requirements, in each case other than claims or allegations that one party to this Agreement has against the other, or (iii) subject to the foregoing clause (ii), to comply with its obligations under this Agreement or any Transaction Document; provided, however, that in the event that any party determines that any such provision of Information could be commercially detrimental, violate any Law or agreement, or waive any attorney-client privilege, the parties shall take all reasonable measures to permit the compliance with such obligations in a manner that avoids any such harm or consequence.

(b) After the Closing Date, Genworth shall have access during regular business hours (as in effect from time to time) to the documents and objects of historic significance that relate to the Genworth Business that are located in archives retained or maintained by any member of the GE Group. Genworth may obtain copies (but not originals unless it is a Genworth Asset) of documents for bona fide business purposes and may obtain objects for exhibition purposes for commercially reasonable periods of time if required for bona fide business purposes, provided that Genworth shall cause any such objects to be returned promptly in the same condition in which they were delivered to Genworth and Genworth shall comply with any rules, procedures or other requirements, and shall be subject to any restrictions (including prohibitions on removal of specified objects), that are then applicable to GE. Genworth shall pay the applicable fee or rate per hour for archives research services (subject to increase from time to time to reflect rates then in effect for GE generally). Nothing herein shall be deemed to restrict the access of any member of the GE Group to any such documents or objects or to impose any liability on any member of the GE Group if any such documents or objects are not maintained or preserved by GE.

(c) After the Closing Date, GE shall have access during regular business hours (as in effect from time to time) to the documents and objects of historic significance that relate to the businesses of any member of the GE Group that are located in archives retained or maintained by any member of the Genworth Group. GE may obtain copies (but not originals unless it is not a Genworth Asset) of documents for bona fide business purposes and may obtain objects for exhibition purposes for commercially reasonable periods of time if required for

42

---

bona fide business purposes, provided that GE shall cause any such objects to be returned promptly in the same condition in which they were delivered to GE and GE shall comply with any rules, procedures or other requirements, and shall be subject to any restrictions (including prohibitions on removal of specified objects), that are then applicable to Genworth. GE shall pay the applicable fee or rate per hour for archives research services (subject to increase from time to time to reflect rates then in effect for Genworth generally). Nothing herein shall be deemed to restrict the access of any member of the Genworth Group to any such documents or objects or to impose any liability on any member of the Genworth Group if any such documents or objects are not maintained or preserved by Genworth.

4.11 Ownership of Information. Any Information owned by one Group that is provided to a requesting party pursuant to Section 4.10 shall be deemed to remain the property of the providing party. Unless specifically set forth herein, nothing contained in this Agreement shall be construed as granting or conferring rights of license or otherwise in any such Information.

4.12 Compensation for Providing Information. The party requesting Information agrees to reimburse the other party for the reasonable out-of-pocket costs, if any, of creating, gathering and copying such Information, to the extent that such costs are incurred for the benefit of the requesting party. Except as may be otherwise specifically provided elsewhere in this Agreement or in any other agreement between the parties, such costs shall be computed in accordance with the providing party's standard methodology and procedures.

4.13 Record Retention. To facilitate the possible exchange of Information pursuant to this Article IV and other provisions of this Agreement after the Closing Date, the parties agree to use their commercially reasonable efforts to retain all Information in their respective possession or control in accordance with the policies of GE as in effect on the Closing Date or such other policies as may be reasonably adopted by the appropriate party after the Closing Date. No party will destroy, or permit any of its Subsidiaries to destroy, any Information which the other party may have the right to obtain pursuant to this Agreement prior to the fifth anniversary of the date hereof without first using its reasonable efforts to notify the other party of the proposed destruction and giving the other party the opportunity to take possession of such Information prior to such destruction; provided, however, that in the case of any Information relating to Taxes or employee benefits, such period shall be extended to the expiration of the applicable statute of limitations (giving effect to any extensions thereof); provided further, however, no party will destroy, or permit any of its Subsidiaries to destroy, any Information required to be retained by applicable Law.

4.14 Liability. No party shall have any liability to any other party in the event that any Information exchanged or provided pursuant to this Agreement which is an estimate or forecast, or which is based on an estimate or forecast, is found to be inaccurate in the absence of willful misconduct by the party providing such Information.

43

---

No party shall have any liability to any other party if any Information is destroyed after commercially reasonable efforts by such party to comply with the provisions of Section 4.13.

4.15 Other Agreements Providing for Exchange of Information

(a) The rights and obligations granted under this Article IV are subject to any specific limitations, qualifications or additional provisions on the sharing, exchange, retention or confidential treatment of Information set forth in any Transaction Document.

(b) When any Information provided by one Group to the other (other than Information provided pursuant to Section 4.13) is no longer needed for the purposes contemplated by this Agreement or any other Transaction Document or is no longer required to be retained by applicable Law, the receiving party will promptly after request of the other party either return to the other party all Information in a tangible form (including all copies thereof and all notes, extracts or summaries based thereon) or certify to the other party that it has destroyed such Information (and such copies thereof and such notes, extracts or summaries based thereon).

4.16 Production of Witnesses; Records; Cooperation

(a) After the Closing Date, except in the case of an adversarial Action by one party against another party, each party hereto shall use its reasonable efforts to make available to each other party, upon written request, the former, current and future directors, officers, employees, other personnel and agents of the members of its respective Group as witnesses and any books, records or other documents within its control or which it otherwise has the ability to make available, to the extent that any such person (giving consideration to business demands of such directors, officers, employees, other personnel and agents) or books, records or other documents may reasonably be required in connection with any Action or IP Application in which the requesting party may from time to time be involved, regardless of whether such Action or IP Application is a matter with respect to which indemnification may be sought hereunder. The requesting party shall bear all costs and expenses in connection therewith.

(b) If an Indemnifying Party chooses to defend or to seek to compromise or settle any Third Party Claim, the other parties shall make available to such Indemnifying Party, upon written request, the former, current and future directors, officers, employees, other personnel and agents of the members of its respective Group as witnesses and any books, records or other documents within its control or which it otherwise has the ability to make available, to the extent that any such person (giving consideration to business demands of such directors, officers, employees, other personnel and agents) or books, records or other documents may reasonably be required in connection with such defense, settlement or compromise, or the prosecution, evaluation or pursuit thereof, as the case may be, and shall otherwise cooperate in such

44

---

defense, settlement or compromise, or such prosecution, evaluation or pursuit, as the case may be.

(c) Without limiting the foregoing, the parties shall cooperate and consult to the extent reasonably necessary with respect to any Actions.

(d) Without limiting any provision of this Section, each of the parties agrees to cooperate, and to cause each member of its respective Group to cooperate, with each other in the defense of any infringement or similar claim with respect any intellectual property and shall not claim to acknowledge, or permit any member of its respective Group to claim to acknowledge, the validity or infringing use of any intellectual property of a third Person in a manner that would hamper or undermine the defense of such infringement or similar claim except as required by Law.

(e) The obligation of the parties to provide witnesses pursuant to this Section 4.16 is intended to be interpreted in a manner so as to facilitate cooperation and shall include the obligation to provide as witnesses inventors and other officers without regard to whether the witness or the employer of the witness could assert a possible business conflict (subject to the exception set forth in the first sentence of Section 4.16(a)).

(f) In connection with any matter contemplated by this Section 4.16, the parties will enter into a mutually acceptable joint defense agreement so as to maintain to the extent practicable any applicable attorney-client privilege, work product immunity or other applicable privileges or immunities of any member of any Group.

4.17 Privilege. The provision of any information pursuant to this Article IV shall not be deemed a waiver of any privilege, including privileges arising under or related to the attorney-client privilege or any other applicable privileges (a "Privilege"). Following the Closing Date, neither Genworth or its Subsidiaries nor GE or its Subsidiaries will be required to provide any information pursuant to this Article IV if the provision of such information would serve as a waiver of any Privilege afforded such information.

ARTICLE V

RELEASE; INDEMNIFICATION

5.1 Release of Pre-Closing Claims.

(a) Except as provided in (i) Section 5.1(c), (ii) any exceptions to the indemnification provisions of Sections 5.2, 5.3 and 5.4, and (iii) any Transaction Document, effective as of the Closing Date, Genworth does hereby, for itself and each other member of the Genworth Group, their respective Affiliates, successors and assigns, and all Persons who at any time prior to the Closing Date have been directors, officers, agents or employees of any member of the Genworth Group (in each case, in their respective capacities as such), remise, release and forever discharge GE and the other members of the GE Group, their respective Affiliates, successors and assigns, and

45

---

all Persons who at any time prior to the Closing Date have been stockholders, directors, officers, agents or employees of any member of the GE Group (in each case, in their respective capacities as such), and their respective heirs, executors, administrators, successors and assigns, from any and all Liabilities whatsoever, whether at Law or in equity (including any right of contribution), whether arising under any contract or agreement, by operation of Law or otherwise, existing or arising from any acts or events occurring or failing to occur or alleged to have occurred or to have failed to occur or any conditions existing or alleged to have existed on or before the Closing Date, including in connection with the transactions and all other activities to implement the Separation, the Initial Public Offering and any of the other transactions contemplated hereunder and under the Transaction Documents.

(b) Except as provided in (i) Section 5.1(c), (ii) any exceptions to the indemnification provisions of Sections 5.2, 5.3 and 5.4, and (iii) any Transaction Document, effective as of the Closing Date, GE does hereby, for itself and each other member of the GE Group, their respective Affiliates, successors and assigns, and all Persons who at any time prior to the Closing Date have been stockholders, directors, officers, agents or employees of any member of the GE Group (in each case, in their respective capacities as such), remise, release and forever discharge Genworth, the respective members of the Genworth Group, their respective Affiliates, successors and assigns, and all Persons who at any time prior to the Closing Date have been stockholders, directors, officers, agents or employees of any member of the Genworth Group (in each case, in their respective capacities as such), and their respective heirs, executors, administrators, successors and assigns, from any and all Liabilities whatsoever, whether at Law or in equity (including any right of contribution), whether arising under any contract or agreement, by operation of Law or otherwise, existing or arising from any acts or events occurring or failing to occur or alleged to have occurred or to have failed to occur or any conditions existing or alleged to have existed on or before the Closing Date, including in connection with the transactions and all other activities to implement the Separation, the Initial Public Offering and any of the other transactions contemplated hereunder and under the Transaction Documents.

(c) Nothing contained in Section 5.1(a) or Section 5.1(b) shall impair any right of any Person to enforce this Agreement, any Transaction Document or any agreements, arrangements, commitments or understandings that are specified in Section 2.4(b) or the applicable Schedules thereto not to terminate as of the Closing Date, in each case in accordance with its terms. Nothing contained in Section 5.1(a) or Section 5.1(b) shall release any Person from:

(i) any Liability provided in or resulting from any agreement among any members of the GE Group or the Genworth Group that is specified in Section 2.4(b) or the applicable Schedules thereto not to terminate as of the Closing Date, or any other Liability specified in such Section 2.4(b) not to terminate as of the Closing Date;

(ii) any Liability, contingent or otherwise, assumed, transferred, assigned or allocated to the Group of which such Person is a member in

46

---

accordance with, or any other Liability of any member of any Group under, this Agreement or any Transaction Document;

(iii) any Liability for the sale, lease, construction or receipt of goods, property or services purchased, obtained or used in the ordinary course of business by a member of one Group from a member of the other Group prior to the Closing Date;

(iv) any Liability for unpaid amounts for products or services or refunds owing on products or services due on a value-received basis for work done by a member of one Group at the request or on behalf of a member of the other Group; or

(v) any Liability that the parties may have with respect to indemnification or contribution pursuant to this Agreement or otherwise for claims brought against the parties by third Persons, which Liability shall be governed by the provisions of this Article V and, if applicable, the appropriate provisions of the Transaction Documents.

In addition, nothing contained in Section 5.1(a) shall release GE from indemnifying any director, officer or employee of Genworth who was a director, officer or employee of GE or any of its Affiliates on or prior to the Closing Date, to the extent such director, officer or employee is or becomes a named defendant in any Action with respect to which he or she was entitled to such indemnification pursuant to then existing obligations.

(d) Genworth shall not make, and shall not permit any member of the Genworth Group to make, any claim or demand, or commence any Action asserting any claim or demand, including any claim of contribution or any indemnification, against GE or any member of the GE Group, or any other Person released pursuant to Section 5.1(a), with respect to any Liabilities released pursuant to Section 5.1(a). GE shall not, and shall not permit any member of the GE Group, to make any claim or demand, or commence any Action asserting any claim or demand, including any claim of contribution or any indemnification against Genworth or any member of the Genworth Group, or any other Person released pursuant to Section 5.1(b), with respect to any Liabilities released pursuant to Section 5.1(b).

(e) It is the intent of each of GE and Genworth, by virtue of the provisions of this Section 5.1, to provide for a full and complete release and discharge of all Liabilities existing or arising from all acts and events occurring or failing to occur or alleged to have occurred or to have failed to occur and all conditions existing or alleged to have existed on or before the Closing Date, between or among Genworth or any member of the Genworth Group, on the one hand, and GE or any member of the GE Group, on the other hand (including any contractual agreements or arrangements existing or alleged to exist between or among any such members on or before the Closing Date), except as expressly set forth in Section 5.1(c). At any time, at the request of any other party, each party shall cause each member of its respective Group to execute and deliver releases reflecting the provisions hereof.

47

---

5.2 General Indemnification by Genworth. Except as provided in Section 5.5, Genworth shall, and shall cause the other members of the Genworth Group to, indemnify defend and hold harmless on an After-Tax Basis each member of the GE Group and each of their respective directors, officers and employees, and each of the heirs, executors, successors and assigns of any of the foregoing (collectively, the "GE Indemnified Parties"), from and against any and all Liabilities of the GE Indemnified Parties relating to, arising out of or resulting from any of the following items (without duplication):

(a) the failure of Genworth or any other member of the Genworth Group or any other Person to pay, perform or otherwise promptly discharge any

Genworth Liabilities or Genworth Contract in accordance with its respective terms, whether prior to or after the Closing Date;

(b) any Genworth Liability or any Genworth Contract;

(c) the GE Guarantees and, except to the extent it relates to an Excluded Liability, any other guarantee, indemnification obligation, surety bond or other credit support agreement, arrangement, commitment or understanding by any member of the GE Group for the benefit of any member of the Genworth Group that survives the Closing;

(d) any breach by any member of the Genworth Group of this Agreement or any of the Transaction Documents (other than the Transaction Documents set forth on Schedule 5.2(d)) or any action by Genworth in contravention of its Amended and Restated Certificate of Incorporation or Amended and Restated Bylaws; and

(e) any untrue statement or alleged untrue statement of a material fact contained in any GE Public Filing or any other document filed with the SEC by any member of the GE Group pursuant to the Securities Act or the Exchange Act, or any omission or alleged omission to state therein a material fact required to be stated therein or necessary to make the statements therein, in light of the circumstances under which they were made, not misleading, in each case to the extent, but only to the extent, that those Liabilities are caused by any such untrue statement or omission or alleged untrue statement or omission based upon information that is either furnished to any of the GE Indemnified Parties by any member of the Genworth Group or incorporated by reference by any GE Indemnified Party from any filings made by any member of the Genworth Group with the SEC pursuant to the Securities Act or the Exchange Act, and then only if that statement or omission was made or occurred after the Closing Date.

5.3 General Indemnification by GE. Except as provided in Section 5.5, GE shall indemnify, defend and hold harmless on an After-Tax Basis each member of the Genworth Group and each of their respective directors, officers and employees, and each of the heirs, executors, successors and assigns of any of the foregoing (collectively, the “Genworth Indemnified Parties”), from and against any and

48

---

all Liabilities of the Genworth Indemnified Parties relating to, arising out of or resulting from any of the following items (without duplication):

(a) the failure of any member of the GE Group or any other Person to pay, perform or otherwise promptly discharge any Liabilities of the GE Group other than the Genworth Liabilities, whether prior to or after the Closing Date or the date hereof;

(b) any Excluded Liability or any Liability of a member of the GE Group other than the Genworth Liabilities;

(c) any breach by any member of the GE Group of this Agreement or any of the Transaction Documents (other than the Transaction Documents set forth on Schedule 5.3(c)); and

(d) any untrue statement or alleged untrue statement of a material fact contained in any document filed with the SEC by any member of the Genworth Group pursuant to the Securities Act or the Exchange Act other than the Registration Statements, or any omission or alleged omission to state therein a material fact required to be stated therein or necessary to make the statements therein, in light of the circumstances under which they were made, not misleading, in each case to the extent, but only to the extent, that those Liabilities are caused by any such untrue statement or omission or alleged untrue statement or omission based upon information that is either furnished to any member of the Genworth Indemnified Parties by any member of the GE Group or incorporated by reference by any Genworth Indemnified Party from any GE Public Filings or any other document filed with the SEC by any member of the GE Group pursuant to the Securities Act or the Exchange Act.

#### 5.4 Registration Statement Indemnification.

(a) Genworth agrees to indemnify and hold harmless on an After-Tax Basis the GE Indemnified Parties and each Person, if any, who controls any member of the GE Group within the meaning of Section 15 of the Securities Act or Section 20 of the Exchange Act (collectively, the “Registration Indemnified Parties”) from and against any and all Liabilities arising out of or based upon any untrue statement or alleged untrue statement of a material fact contained in any Registration Statement or Prospectus, or arising out of or based upon any omission or alleged omission to state therein a material fact required to be stated therein or necessary to make the statements therein not misleading, except insofar as such Liabilities arise out of or are based upon any untrue statement or omission or alleged untrue statement or omission which has been made therein or omitted therefrom in reliance upon and in conformity with (i) the information set forth in the IPO Registration Statement, the Equity Units Registration Statement, and the Series A Preferred Stock Registration Statement that is described on Schedule 5.4 and (ii) information relating to any underwriter furnished in writing to Genworth by or on behalf of such underwriter expressly for use in the Registration Statement or Prospectus.

49

---

(b) Each Registration Indemnified Party agrees, severally and not jointly, to indemnify and hold harmless on an After-Tax Basis Genworth and its Subsidiaries and any of their respective directors or officers who sign any Registration Statement, and any person who controls Genworth within the meaning of Section 15 of the Securities Act or Section 20 of the Exchange Act, to the same extent as the foregoing indemnity from Genworth to each Registration Indemnified Party, but only with respect to the information set forth in the IPO Registration Statement, the Equity Units Registration Statement, and the Series A Preferred Stock Registration Statement that is described on Schedule 5.4. For purposes of this Section 5.4(b), any information relating to any underwriter that is contained in a Registration Statement or Prospectus shall not be deemed to be information relating to a Registration Indemnified Party. If any Action shall be brought against Genworth or its Subsidiaries, any of their respective directors or officers, or any such controlling person based on any Registration Statement or Prospectus and in respect of which indemnity may be sought against a Registration Indemnified Party pursuant to this paragraph (b), such Registration Indemnified Party shall have the rights and duties given to Genworth by Section 5.5 hereof (except that if Genworth shall have assumed the defense thereof, such Registration Indemnified Party shall not be required to, but may, employ separate counsel therein and participate in the defense thereof, but the fees and expenses of such counsel shall be at such Registration Indemnified Party’s expense), and Genworth, its directors or officers, and any such controlling person shall have the rights and duties given to such Registration Indemnified Party by Section 5.5 hereof.

#### 5.5 Contribution.

(a) If the indemnification provided for in this Article V is unavailable to, or insufficient to hold harmless on an After-Tax Basis, an indemnified party under Section 5.2(e), Section 5.3(d) or Section 5.4 hereof in respect of any Liabilities referred to therein, then each indemnifying party shall contribute to the amount paid or payable by such indemnified party as a result of such Liabilities (or actions in respect thereof) in such proportion as is appropriate to reflect the relative fault of the indemnifying party and the indemnified party in connection with the actions which resulted in Liabilities as well as any other relevant equitable considerations. The relative fault of such indemnifying party and indemnified party shall be determined by reference to, among other things, whether the untrue or alleged untrue statement of a material fact or omission or alleged omission to state a material fact relates to information supplied by such indemnifying party or indemnified party, and the parties’ relative intent, knowledge, access to information and opportunity to correct or prevent such statement or omission. For the purposes of this Section 5.5(a), the information set forth in the IPO Registration Statement, the Equity Units Registration Statement, and the Series A Preferred Stock Registration Statement that is described on Schedule 5.4 shall be the only “information supplied by” such Registration Indemnified Parties.



(b) The parties hereto agree that it would not be just and equitable if contribution pursuant to this Section 5.5 were determined by a pro rata allocation or by any other method of allocation that does not take account of the equitable considerations referred to in paragraph (a) above. The amount paid or payable by an indemnified party

---

as a result of the Liabilities referred to in paragraph (a) above, shall be deemed to include, subject to the limitations set forth above any legal or other fees or expenses reasonably incurred by such indemnified party in connection with investigating any claim or defending any Action. Notwithstanding the provisions of this Section 5.5, a Registration Indemnified Party shall not be required to contribute any amount in excess of the amount by which the proceeds to such Registration Indemnified Party exceeds the amount of any damages which such Registration Indemnified Party has otherwise been required to pay by reason of such untrue or alleged untrue statement or omission or alleged omission. No person guilty of fraudulent misrepresentation (within the meaning of Section 11(f) of the Securities Act) shall be entitled to contribution from any person who was not guilty of such fraudulent misrepresentation.

#### 5.6 Indemnification Obligations Net of Insurance Proceeds and Other Amounts, On an After-Tax Basis

(a) Any Liability subject to indemnification or contribution pursuant to this Article V will be net of Insurance Proceeds that actually reduce the amount of the Liability and will be determined on an After-Tax Basis. Accordingly, the amount which any party (an “Indemnifying Party”) is required to pay to any Person entitled to indemnification hereunder (an “Indemnified Party”) will be reduced by any Insurance Proceeds theretofore actually recovered by or on behalf of the Indemnified Party in respect of the related Liability. If an Indemnified Party receives a payment (an “Indemnity Payment”) required by this Agreement from an Indemnifying Party in respect of any Liability and subsequently receives Insurance Proceeds, then the Indemnified Party will pay to the Indemnifying Party an amount equal to the excess of the Indemnity Payment received over the amount of the Indemnity Payment that would have been due if the Insurance Proceeds had been received, realized or recovered before the Indemnity Payment was made.

(b) An insurer who would otherwise be obligated to pay any claim shall not be relieved of the responsibility with respect thereto or, solely by virtue of the indemnification provisions hereof, have any subrogation rights with respect thereto. The Indemnified Party shall use its commercially reasonable efforts to seek to collect or recover any third-party (which shall not include any captive insurance subsidiary) Insurance Proceeds (other than Insurance Proceeds under an arrangement where future premiums are adjusted to reflect prior claims in excess of prior premiums) to which the Indemnified Party is entitled in connection with any Liability for which the Indemnified Party seeks indemnification pursuant to this Article V; provided that the Indemnified Party's inability to collect or recover any such Insurance Proceeds shall not limit the Indemnifying Party's obligations hereunder.

(c) The term “After-Tax Basis” as used in this Article V means that, in determining the amount of the payment necessary to indemnify any party against, or reimburse any party for, Liabilities, the amount of such Liabilities will be determined net of any reduction in Tax derived by the indemnified party as the result of sustaining or paying such Liabilities, and the amount of such indemnification payment will be increased (i.e., “grossed up”) by the amount necessary to satisfy any income or franchise

---

Tax liabilities incurred by the indemnified party as a result of its receipt of, or right to receive, such indemnification payment (as so increased), so that the indemnified party is put in the same net after-Tax economic position as if it had not incurred such Liabilities, in each case without taking into account any impact on the tax basis that an indemnified party has in its assets.

#### 5.7 Procedures for Indemnification of Third Party Claims

(a) If an Indemnified Party shall receive notice or otherwise learn of the assertion by a Person (including any Governmental Authority) who is not a member of the GE Group or the Genworth Group of any claim or of the commencement by any such Person of any Action (collectively, a “Third Party Claim”) with respect to which an Indemnifying Party may be obligated to provide indemnification to such Indemnified Party pursuant to Section 5.2, Section 5.3 or Section 5.4, or any other Section of this Agreement or any Transaction Document, such Indemnified Party shall give such Indemnifying Party written notice thereof within 20 days after becoming aware of such Third Party Claim. Any such notice shall describe the Third Party Claim in reasonable detail. Notwithstanding the foregoing, the failure of any Indemnified Party or other Person to give notice as provided in this Section 5.7(a) shall not relieve the Indemnifying Party of its obligations under this Article V, except to the extent that such Indemnifying Party is actually prejudiced by such failure to give notice.

(b) An Indemnifying Party may elect to defend (and to seek to settle or compromise), at such Indemnifying Party's own expense and by such Indemnifying Party's own counsel, any Third Party Claim. Within 30 days after the receipt of notice from an Indemnified Party in accordance with Section 5.7(a) (or sooner, if the nature of such Third Party Claim so requires), the Indemnifying Party shall notify the Indemnified Party of its election whether the Indemnifying Party will assume responsibility for defending such Third Party Claim, which election shall specify any reservations or exceptions. After notice from an Indemnifying Party to an Indemnified Party of its election to assume the defense of a Third Party Claim, such Indemnified Party shall have the right to employ separate counsel and to participate in (but not control) the defense, compromise, or settlement thereof, but the fees and expenses of such counsel shall be the expense of such Indemnified Party except as set forth in the next sentence. If the Indemnifying Party has elected to assume the defense of the Third Party Claim but has specified, and continues to assert, any reservations or exceptions in such notice, then, in any such case, the reasonable fees and expenses of one separate counsel for all Indemnified Parties shall be borne by the Indemnifying Party, but the Indemnifying Party shall be entitled to reimbursement by the Indemnified Party for payment of any such fees and expenses to the extent that it establishes that such reservations and exceptions were proper.

(c) If an Indemnifying Party elects not to assume responsibility for defending a Third Party Claim, or fails to notify an Indemnified Party of its election as provided in Section 5.7(b), such Indemnified Party may defend such Third Party Claim at the cost and expense of the Indemnifying Party.

---

(d) Unless the Indemnifying Party has failed to assume the defense of the Third Party Claim in accordance with the terms of this Agreement, no Indemnified Party may settle or compromise any Third Party Claim without the consent of the Indemnifying Party. No Indemnifying Party shall consent to entry of any judgment or enter into any settlement of any pending or threatened Third Party Claim in respect of which any Indemnified Party is or could have been a party and indemnity could have been sought hereunder by such Indemnified Party without the consent of the Indemnified Party if (i) the effect thereof is to permit any injunction, declaratory judgment, other order or other nonmonetary relief to be entered, directly or indirectly against such Indemnified Party and (ii) such settlement does not include an unconditional release of such Indemnified Party from all liability on claims that are the subject matter of such Third Party Claim.

(e) The provisions of this Section 5.7 shall not apply to Taxes (which are covered by the Tax Matters Agreement).

#### 5.8 Additional Matters

(a) Indemnification or contribution payments in respect of any Liabilities for which an Indemnified Party is entitled to indemnification or contribution under this Article V shall be paid by the Indemnifying Party to the Indemnified Party as such Liabilities are incurred upon demand by the Indemnified Party, including reasonably satisfactory documentation setting forth the basis for the amount of such indemnification or contribution payment, including documentation with respect to calculations made on an After-Tax Basis and consideration of any Insurance Proceeds that actually reduce the amount of such Liabilities. The indemnity and contribution agreements contained in this Article V shall remain operative and in full force and effect, regardless of (i) any investigation made by or on behalf of any Indemnified Party; (ii) the knowledge by the Indemnified Party of Liabilities for which it might be entitled to indemnification or contribution hereunder; and (iii) any termination of this Agreement.

(b) Any claim on account of a Liability which does not result from a Third Party Claim shall be asserted by written notice given by the Indemnified Party to the applicable Indemnifying Party. Such Indemnifying Party shall have a period of 30 days after the receipt of such notice within which to respond thereto. If such Indemnifying Party does not respond within such 30-day period, such Indemnifying Party shall be deemed to have refused to accept responsibility to make payment. If such Indemnifying Party does not respond within such 30-day period or rejects such claim in whole or in part, such Indemnified Party shall be free to pursue such remedies as may be available to such party as contemplated by this Agreement and the Transaction Documents without prejudice to its continuing rights to pursue indemnification or contribution hereunder.

(c) If payment is made by or on behalf of any Indemnifying Party to any Indemnified Party in connection with any Third Party Claim, such Indemnifying Party shall be subrogated to and shall stand in the place of such Indemnified Party as to

53

---

any events or circumstances in respect of which such Indemnified Party may have any right, defense or claim relating to such Third Party Claim against any claimant or plaintiff asserting such Third Party Claim or against any other Person. Such Indemnified Party shall cooperate with such Indemnifying Party in a reasonable manner, and at the cost and expense of such Indemnifying Party, in prosecuting any subrogated right, defense or claim.

(d) In an Action in which the Indemnifying Party is not a named defendant, if either the Indemnified Party or Indemnifying Party shall so request, the parties shall endeavor to substitute the Indemnifying Party for the named defendant if they conclude that substitution is desirable and practical. If such substitution or addition cannot be achieved for any reason or is not requested, the named defendant shall allow the Indemnifying Party to manage the Action as set forth in this section, and the Indemnifying Party shall fully indemnify the named defendant against all costs of defending the Action (including court costs, sanctions imposed by a court, attorneys' fees, experts fees and all other external expenses), the costs of any judgment or settlement, and the cost of any interest or penalties relating to any judgment or settlement.

(e) The provisions of this Section 5.8 shall not apply to Taxes and related matters covered under Section 16 of the Tax Matters Agreement.

5.9 Remedies Cumulative; Limitations of Liability. The rights provided in this Article V shall be cumulative and, subject to the provisions of Article VII, shall not preclude assertion by any Indemnified Party of any other rights or the seeking of any and all other remedies against any Indemnifying Party. Notwithstanding the foregoing, neither Genworth or its Affiliates, on the one hand, nor any GE Party, on the other hand, shall be liable to the other for any special, indirect, incidental, punitive, consequential, exemplary, statutorily-enhanced or similar damages in excess of compensatory damages (provided that any such liability with respect to a Third Party Claim shall be considered direct damages) of the other arising in connection with the Transactions.

5.10 Survival of Indemnities. The rights and obligations of each of GE and Genworth and their respective Indemnified Parties under this Article V shall survive the sale or other transfer by any party of any Assets or businesses or the assignment by it of any Liabilities.

## ARTICLE VI

### OTHER AGREEMENTS

#### 6.1 Further Assurances.

(a) In addition to the actions specifically provided for elsewhere in this Agreement, each of the parties hereto will cooperate with each other and use (and will cause their respective Subsidiaries and Affiliates to use) commercially reasonable

54

---

efforts, prior to, on and after the Closing Date, to take, or to cause to be taken, all actions, and to do, or to cause to be done, all things reasonably necessary on its part under applicable Law or contractual obligations to consummate and make effective the transactions contemplated by this Agreement and the Transaction Documents.

(b) Without limiting the foregoing, prior to, on and after the Closing Date, each party hereto shall cooperate with the other parties, and without any further consideration, but at the expense of the requesting party from and after the Closing Date, to execute and deliver, or use its commercially reasonable efforts to cause to be executed and delivered, all instruments, including instruments of conveyance, assignment and transfer, and to make all filings with, and to obtain all consents, approvals or authorizations of, any Governmental Authority or any other Person under any permit, license, agreement, indenture or other instrument (including any Consents or Governmental Approvals), and to take all such other actions as such party may reasonably be requested to take by any other party hereto from time to time, consistent with the terms of this Agreement and the Transaction Documents, in order to effectuate the provisions and purposes of this Agreement and the Transaction Documents and the transfers of the Genworth Assets and the assignment and assumption of the Genworth Liabilities and the other transactions contemplated hereby and thereby. Without limiting the foregoing, each party will, at the reasonable request, cost and expense of any other party, take such other actions as may be reasonably necessary to vest in such other party good and marketable title to the Assets allocated to such party under this Agreement or any of the Transaction Documents, free and clear of any Security Interest, if and to the extent it is practicable to do so.

(c) On or prior to the Closing Date, GE and Genworth in their respective capacities as direct and indirect stockholders of their respective Subsidiaries, shall each ratify any actions that are reasonably necessary or desirable to be taken by GE, Genworth or any other Subsidiary of GE or Genworth, as the case may be, to effectuate the transactions contemplated by this Agreement. On or prior to the Closing Date, GEFAHI and Genworth shall take all actions as may be necessary to approve the stock-based employee benefit plans of Genworth in order to satisfy the requirements of Rule 16b-3 under the Exchange Act and the applicable rules and regulations of The New York Stock Exchange.

#### 6.2 Confidentiality.

(a) From and after the Closing, subject to Section 6.2(c) and except as contemplated by this Agreement or any Transaction Document, the GE Parties shall not, and shall cause their respective Affiliates and their respective officers, directors, employees, and other agents and representatives, including attorneys, agents, customers, suppliers, contractors, consultants and other representatives of any Person providing financing (collectively, "Representatives"), not to, directly or indirectly, disclose, reveal, divulge or communicate to any Person other than Representatives of such party or of its Affiliates who reasonably need to know such information in providing services to any member of the GE Group or use or otherwise exploit for its own benefit or for the benefit of any third party, any Genworth Confidential Information. If any disclosures

are made in connection with providing services to any member of the GE Group under this Agreement or any Transaction Document, then the Genworth Confidential Information so disclosed shall be used only as required to perform the services. The GE Parties shall use the same degree of care to prevent and restrain the unauthorized use or disclosure of the Genworth Confidential Information by any of their Representatives as they currently use for their own confidential information of a like nature, but in no event less than a reasonable standard of care. For purposes of this Section 6.2, any Information, material or documents relating to the Genworth Business currently or formerly conducted, or proposed to be conducted, by any member of the Genworth Group furnished to or in possession of the GE Parties, irrespective of the form of communication, and all notes, analyses, compilations, forecasts, data, translations, studies, memoranda or other documents prepared by the GE Parties or their respective officers, directors and Affiliates, that contain or otherwise reflect such information, material or documents is hereinafter referred to as “Genworth Confidential Information.” “Genworth Confidential Information” does not include, and there shall be no obligation hereunder with respect to, information that (i) is or becomes generally available to the public, other than as a result of a disclosure by any of the GE Parties not otherwise permissible hereunder, (ii) such GE Party can demonstrate was or became available to such GE Party from a source other than Genworth or its Affiliates or (iii) is developed independently by such GE Party without reference to the Genworth Confidential Information; provided, however, that, in the case of clause (ii), the source of such information was not known by the GE Parties to be bound by a confidentiality agreement with, or other contractual, legal or fiduciary obligation of confidentiality to, Genworth or any member of the Genworth Group with respect to such information.

(b) From and after the Closing, subject to Section 6.2(c) and except as contemplated by this Agreement or any Transaction Document, Genworth shall not, and shall cause its Affiliates and their respective Representatives, not to, directly or indirectly, disclose, reveal, divulge or communicate to any Person other than Representatives of such party or of its Affiliates who reasonably need to know such information in providing services to Genworth or any member of the Genworth Group or use or otherwise exploit for its own benefit or for the benefit of any third party, any GE Confidential Information. If any disclosures are made in connection with providing services to any member of the Genworth Group under this Agreement or any Transaction Document, then the GE Confidential Information so disclosed shall be used only as required to perform the services. The Genworth Group shall use the same degree of care to prevent and restrain the unauthorized use or disclosure of the GE Confidential Information by any of their Representatives as they currently use for their own confidential information of a like nature, but in no event less than a reasonable standard of care. For purposes of this Section 6.2, any Information, material or documents relating to the businesses currently or formerly conducted, or proposed to be conducted, by GE or any of its Affiliates (other than any member of the Genworth Group) furnished to or in possession of any member of the Genworth Group, irrespective of the form of communication, and all notes, analyses, compilations, forecasts, data, translations, studies, memoranda or other documents prepared by Genworth, any member of the Genworth Group or their respective officers, directors and Affiliates, that contain or otherwise reflect such information, material or documents

is hereinafter referred to as “GE Confidential Information.” “GE Confidential Information” does not include, and there shall be no obligation hereunder with respect to, information that (i) is or becomes generally available to the public, other than as a result of a disclosure by any member of the Genworth Group not otherwise permissible hereunder, (ii) Genworth can demonstrate was or became available to Genworth from a source other than the GE Parties and their respective Affiliates or (iii) is developed independently by such member of the Genworth Group without reference to the GE Confidential Information; provided, however, that, in the case of clause (ii), the source of such information was not known by Genworth to be bound by a confidentiality agreement with, or other contractual, legal or fiduciary obligation of confidentiality to, any of the GE Parties or their respective Affiliates with respect to such information.

(c) If any of the GE Parties or their respective Affiliates, on the one hand, or Genworth or its Affiliates, on the other hand, are requested or required (by oral question, interrogatories, requests for information or documents, subpoena, civil investigative demand or similar process) by any Governmental Authority or pursuant to applicable Law to disclose or provide any Genworth Confidential Information or GE Confidential Information (other than with respect to any such information furnished pursuant to the provisions of Article IV of this Agreement), as applicable, the entity or person receiving such request or demand shall use all reasonable efforts to provide the other party with written notice of such request or demand as promptly as practicable under the circumstances so that such other party shall have an opportunity to seek an appropriate protective order. The party receiving such request or demand agrees to take, and cause its representatives to take, at the requesting party’s expense, all other reasonable steps necessary to obtain confidential treatment by the recipient. Subject to the foregoing, the party that received such request or demand may thereafter disclose or provide any Genworth Confidential Information or GE Confidential Information, as the case may be, to the extent required by such Law (as so advised by counsel) or by lawful process or such Governmental Authority.

### 6.3 Insurance Matters.

(a) Schedule 6.3 sets forth the Insurance Policies under which members of the Genworth Group will continue to have coverage until the Trigger Date, and the amounts payable by Genworth to GE under each such Insurance Policy from and after the Closing Date. Members of the Genworth Group will pay retrospective premium adjustments under each such Insurance Policy based on their loss experience under the Insurance Policy and in accordance with the pricing methodologies set forth on Schedule 6.3. Except as otherwise set forth on Schedule 6.3, the members of the Genworth Group will have coverage under all Insurance Policies with respect to periods prior to the Trigger Date in accordance with the terms of each such Insurance Policy. GE and Genworth agree to cooperate in good faith to provide for an orderly transition of insurance coverage from the Closing Date through the Trigger Date, and for the treatment of any Insurance Policies that will remain in effect following the Trigger Date on a mutually agreeable basis. Genworth may cancel coverage under any Insurance Policy by written notice to GE at least sixty (60) days prior to such cancellation. In no event shall GE, any other member of the GE Group or any GE Indemnified Party have

liability or obligation whatsoever to any member of the Genworth Group if any Insurance Policy or other contract or policy of insurance shall be terminated or otherwise cease to be in effect or for any reason shall be unavailable or inadequate to cover any Liability of any member of the Genworth Group for any reason whatsoever or shall not be renewed or extended beyond the current expiration date. GE shall provide notice to Genworth promptly upon its becoming aware that any Insurance Policy has been terminated or is otherwise no longer in effect or is reasonably likely to be terminated or otherwise cease to be in effect.

(b) (i) Except as otherwise provided in any Transaction Document, the parties intend by this Agreement that Genworth and each other member of the Genworth Group be successors-in-interest to all rights that any member of the Genworth Group may have as of the Closing Date as a subsidiary, affiliate, division or department of GE prior to the Closing Date under any policy of insurance issued to GE by any insurance carrier or under any agreements related to such policies executed and delivered prior to the Closing Date, including any rights such member of the Genworth Group may have, as an insured or additional named insured, subsidiary, affiliate, division or department, to avail itself of any such policy of insurance or any such agreements related to such policies as in effect prior to the Closing Date. At the request of Genworth, GE shall take all reasonable steps, including the execution and delivery of any instruments, to effect the foregoing; provided, however that GE shall not be required to pay any amounts, waive any rights or incur any Liabilities in connection therewith.

(ii) Except as otherwise contemplated by any Transaction Document, after the Closing Date, none of GE or Genworth or any member of their respective Groups shall, without the consent of the other, provide any such insurance carrier with a release, or amend, modify or waive any rights under any such policy or agreement, if such release, amendment, modification or waiver would adversely affect any rights or potential rights of any member of the other Group thereunder; provided, however that the foregoing shall not (A) preclude any member of any Group from presenting any claim or from exhausting any policy limit, (B) require any member of any Group to pay any premium or other amount or to incur any Liability, or (C) require any member of any Group to renew, extend or continue any policy in force.

Each of Genworth and GE will share such information as is reasonably necessary in order to permit the other to manage and conduct its insurance matters in an orderly fashion.

(c) This Agreement shall not be considered as an attempted assignment of any policy of insurance or as a contract of insurance and shall not be construed to waive any right or remedy of any member of the GE Group in respect of any Insurance Policy or any other contract or policy of insurance.

(d) Genworth does hereby, for itself and each other member of the Genworth Group, agree that no member of the GE Group or any GE Indemnified Party shall have any Liability whatsoever to Genworth or any other member of the Genworth Group as a result of the insurance policies and practices of GE and its Affiliates as in effect at any time prior to the Closing Date, including as a result of the level or scope of

58

---

any such insurance, the creditworthiness of any insurance carrier, the terms and conditions of any policy, the adequacy or timeliness of any notice to any insurance carrier with respect to any claim or potential claim or otherwise.

(e) Nothing in this Agreement shall be deemed to restrict any member of the Genworth Group from acquiring at its own expense any other insurance policy in respect of any Liabilities or covering any period; provided that Genworth shall give GE prompt written notice of any such insurance policy acquired prior to the Trigger Date.

6.4 Allocation of Costs and Expenses. GE shall pay (or, to the extent incurred by and paid for by any member of the Genworth Group, will promptly reimburse such party for any and all amounts so paid) for all out-of-pocket fees, costs and expenses incurred by Genworth or any member of the GE Group prior to and simultaneously with the consummation of the Initial Public Offering in connection with the Transactions, including (a) the preparation and negotiation of this Agreement, each Transaction Document (unless otherwise expressly provided therein), the Genworth Bridge Loan, the Genworth Credit Facilities, the Genworth Senior Notes and the \$1.0 billion Genworth commercial paper facility and all other documentation related to the Transactions and all related transactions, (b) the preparation and execution or filing of any and all other documents, agreements, forms, applications, contracts or consents associated with the Transactions and all related transactions, (c) the preparation and filing of Genworth's and its Subsidiaries' organizational documents, (d) the preparation, printing and filing of any Registration Statement, including all fees and expenses of complying with applicable federal, state or foreign securities Laws and domestic or foreign securities exchange rules and regulations, together with fees and expenses of counsel retained to effect such compliance, (e) the preparation, printing and distribution of each Prospectus, (f) the private letter ruling from the Internal Revenue Service sought in connection with the Transactions, (g) the initial listing of the Genworth Common Stock, the Series A Preferred Stock and the Genworth Equity Units on The New York Stock Exchange and (h) the preparation (including, but not limited to, the printing of documents) and implementation of Genworth's or its Subsidiaries' employee benefit plans, retirement plans and equity-based plans. In addition, GE shall pay (or, to the extent incurred by and paid for by any member of the Genworth Group, will promptly reimburse such party for any and all amounts so paid) for all out-of-pocket fees, costs and expenses incurred by Genworth or any member of the GE Group or Genworth Group following the consummation of the Initial Public Offering in connection with (1) the preparation, printing and filing of the Debt Registration Statement, including all fees and expenses of complying with applicable federal, state or foreign securities Laws and domestic or foreign securities exchange rules and regulations, together with fees and expenses of counsel retained to effect such compliance, (2) the preparation, printing and distribution of the Prospectus included in the Debt Registration Statement, (3) the consummation of the Genworth Credit Facilities, the Genworth Senior Notes and the \$1.0 billion Genworth commercial paper facility, (4) the consummation of the transfer of the Delayed Transfer Assets and the assumption of the Delayed Transfer Liabilities; (5) the exercise of any Over-Allotment Option and (6) the FACL Bond Portfolio Reinsurance pursuant to Section 2.10(a) and the transfer of the FACL Bonds to an appropriate member of the GE

59

---

Group pursuant to Section 2.10(b); provided, that prior to the Closing Date Genworth shall deliver to GE a good faith estimate of the out-of-pocket fees, costs and expenses expected to be incurred in connection with the foregoing clauses (1) through (4) and clause (6).

6.5 Covenants Against Taking Certain Actions Affecting GE.

(a) Genworth hereby covenants and agrees that it shall not, without the prior written consent of GE (which it may withhold in its sole and absolute discretion) take, or cause to be taken, directly or indirectly, any action, including making or failing to make any election under the Law of any state, which has the effect, directly or indirectly, of restricting or limiting the ability of GE or any of its Affiliates to freely sell, transfer, assign, pledge or otherwise dispose of shares of Genworth Common Stock. Without limiting the generality of the foregoing, Genworth shall not, without the prior written consent of GE (which it may withhold in its sole and absolute discretion), take any action, or recommend to its stockholders any action, which would among other things, limit the legal rights of, or deny any benefit to, GE as a Genworth stockholder in a manner not applicable to Genworth stockholders generally.

(b) Prior to the Trigger Date, to the extent that any member of the GE Group is a party to any contract or agreement with a third party (i) that provides that certain actions of GE's Subsidiaries may result in GE being in breach of or in default under such agreement and GE has advised Genworth, or Genworth is otherwise aware, of the existence of, such contract or agreement (or the relevant portions thereof), (ii) to which any member of the Genworth Group is a party or (iii) under which any member of the Genworth Group has performed any obligations on or before the date hereof, Genworth shall not take, and shall cause each other member of the Genworth Group not to take, any actions that reasonably could result in any member of the GE Group being in breach of or in default under any such contract or agreement; provided, that, except as set forth in any Transaction Document or otherwise agreed to in writing by any member of the Genworth Group, the foregoing shall not obligate any member of the Genworth Group to satisfy any volume assumptions or targets in any such contracts or agreements that are not specifically applicable to such member of the Genworth Group in such contracts or agreements. As of the date hereof, the contracts and agreements described in clause (i) above are set forth or generally described on Schedule 6.5(b). Genworth hereby acknowledges and agrees that GE has made available to Genworth copies of each contract or agreement (or the relevant portion thereof) described on Schedule 6.5(b). The parties acknowledge and agree that, after the date hereof, GE may in good faith (and not solely with the intention of imposing restrictions on Genworth pursuant to this covenant) amend the referenced agreements or enter into additional contracts or agreements that provide that certain actions of any member of the Genworth Group may result in GE being in breach of or in default under such agreements; provided that GE shall use reasonable efforts to notify and consult with Genworth prior to entering into any such amendments or additional contracts or agreements to the extent that compliance therewith (i) could reasonably be expected to have a material adverse effect on any member of the Genworth Group or (ii) would discriminate in an adverse way in the treatment of members of the Genworth Group as compared with GE and its

60

---

other Affiliates, and shall make available to Genworth copies of such amendments or additional contracts or agreements. In such event, Schedule 6.5(b) shall be deemed to be automatically amended to reflect the addition of any other contracts or agreements (or relevant portions thereof) of which GE advises Genworth after the date hereof in accordance with this Section 6.5(b).

(c) Genworth shall not, without GE's prior written consent, enter into any agreement or arrangement that, directly or indirectly, binds or purports to bind any member of the GE Group.

6.6 No Violations.

(a) Genworth covenants and agrees that it shall not, and shall cause its Subsidiaries not to, take any action or enter into any commitment or agreement that may reasonably be anticipated to result, with or without notice and with or without lapse of time or otherwise, in a contravention or event of default by any member of the GE Group of: (i) any provisions of applicable Law; (ii) any provision of the organizational documents of any member of the GE Group; (iii) any credit agreement or other material instrument binding upon any member of the GE Group in effect as of the Closing Date; or (iv) any judgment, order or decree of any Governmental Authority having jurisdiction over any member of the GE Group or any of its respective assets.

(b) GE covenants and agrees that it shall not, and shall cause its Subsidiaries not to take any action or enter into any commitment or agreement that may reasonably be anticipated to result, with or without notice and with or without lapse of time or otherwise, in a contravention or event of default by any member of the Genworth Group of: (i) any provisions of applicable Law; (ii) any provision of the organizational documents of Genworth; (iii) any credit agreement or other material instrument binding upon Genworth in effect as of the Closing Date; (iv) the Genworth Bridge Loan and the Genworth Senior Notes; or (v) any judgment, order or decree of any Governmental Authority having jurisdiction over Genworth or any of its Assets.

(c) Genworth and GE agree to provide to the other any information and documentation reasonably requested by the other for the purpose of evaluating and ensuring compliance with Sections 6.6(a) and Section 6.6(b) hereof.

(d) Notwithstanding Section 6.6(b), nothing in this Agreement is intended to limit or restrict in any way GE's or its Affiliates' rights as shareholders of Genworth.

6.7 Registration Statements. To the extent necessary to enable the unrestricted transfer of the applicable shares of Genworth Common Stock, upon consummation of the Initial Public Offering, Genworth shall file and cause to remain effective a registration statement with the SEC to register Genworth Common Stock that may be acquired by employees of any member of the Genworth Group as contemplated by GE's or its Subsidiaries' employee stock or option plans.

---

61

6.8 Charter Provision. Genworth shall, and shall cause each of its Subsidiaries to, take any and all actions necessary to ensure continued compliance by Genworth and its Subsidiaries with the provisions of its certificate or articles of incorporation and by-laws. Genworth shall notify GE in writing promptly after becoming aware of any act or activity taken or proposed to be taken by Genworth or any of its Subsidiaries which resulted or would result in non-compliance with any such charter provisions and so long as GE owns any shares of Class B Common Stock Genworth shall take or refrain from taking all such actions as GE shall in its sole discretion determine necessary or desirable to prevent or remedy any such non-compliance.

6.9 Litigation and Settlement Cooperation. Prior to the Trigger Date, GE will use its commercially reasonable efforts to include Genworth and its Subsidiaries in the settlement of any Third Party Claim which jointly involves a member of the GE Group and a member of the Genworth Group; provided, however, that Genworth shall be responsible for its share of any such settlement obligation and any incremental cost (as reasonably determined by GE) to GE of including Genworth in such settlement; provided, further, that Genworth shall be permitted in good faith to opt out of any settlement if Genworth agrees to be responsible for defending its share of such Third Party Claim. The parties agree to cooperate in the defense and settlement of any such Third Party Claim which primarily relates to matters, actions, events or occurrences taking place prior to the Trigger Date. In addition, both Genworth and GE will use their commercially reasonable efforts to make the necessary filings to permit each party to defend its own interests in any such Third Party Claim as of the Trigger Date, or as soon as practicable thereafter.

6.10 Continuation of Certain Arrangements. GE and Genworth will each use commercially reasonable efforts to continue or cause to be continued the arrangements described in Schedule 6.10.

6.11 Future Intercompany Transactions. All proposed intercompany transactions between Genworth and GE after the Closing Date, including any material amendments to the Transaction Documents, and any consent or approval proposed to be granted by Genworth for GE's benefit, in each case that would ordinarily be submitted for approval by the board of directors of Genworth will be subject to the approval of a majority of the independent directors (as defined under the applicable rules of any securities exchange on which shares of Genworth Common Stock are listed) of the board of directors of Genworth.

6.12 Use of Restricted Marks; Certain Commercial Arrangements.

(a) Except as otherwise set forth below, during the period commencing on the Closing Date and ending on the first to occur of (x) the fifth anniversary of the Closing Date, (y) the termination of the right to use the Licensed Marks with respect to products and services under the Transitional Trademark Agreement, and (z) solely with respect to a specific type of product or service in a particular jurisdiction (including the use of the Licensed Marks in connection with products and services offered and jurisdictions entered after the Closing Date in

---

62

accordance with the Transitional Trademark Agreement), the first date that Genworth ceases to use the Licensed Marks for a period of at least 180 days with respect to such type of product or service in such jurisdiction, GE will not, and will cause its Affiliates not to, use the Restricted Marks in connection with (i) the underwriting, marketing, endorsing, issuing, or administering (other than in connection with a reinsurance relationship) on a primary basis of life insurance, long-term care insurance, annuities (other than in conjunction with the offering of a GE or GE Affiliate-managed mutual fund investment offering underlying such annuities), and work site benefits insurance (for the avoidance of doubt, excluding employer stop loss, workers compensation, and excess workers compensation insurance underwritten or issued by any GE Affiliate on a direct basis as of the date hereof, provided that in connection therewith, the Restricted Marks are used in a substantially similar manner as used as of the date hereof) in the United States or of auto insurance products in the Republic of Mexico or (ii) the underwriting or issuing of mortgage insurance products or similar products providing credit default protection on residential mortgages anywhere in the world. In connection with clause (z) above, Genworth shall notify GE as promptly as practicable in connection with any cessation of use of the Restricted Marks as set forth above.

(b) Notwithstanding the foregoing, and without implicitly agreeing that any of the following activities would be prohibited by the restrictions set forth in paragraph (a) above, GE and its Affiliates shall not be prohibited from (i) using the Restricted Marks in any way in connection with (A) any business in which GE or any of its Affiliates (which, for purposes of this clause, shall not include Genworth and its Subsidiaries) is engaged as of the Closing or (B) the activities set forth on Schedule 6.12(b)(i)(B); (ii) using the Restricted Marks in the underwriting, marketing, endorsing, issuing, renewing, amending, and administering of any and all types of reinsurance and retrocession whether or not so used by GE or any of its Affiliates as of the Closing, including without limitation, reinsurance and retrocession of the types of business that, if underwritten or marketed on a primary basis by GE or its Affiliates using the Restricted Marks would violate the restrictions set forth in paragraph (a) above, provided that in connection with such reinsurance or retrocession, GE and its Affiliates will not use the Restricted Marks in marketing activities primarily directed to consumers; or (iii) making references to any Affiliate of GE as an Affiliate of GE or any of GE's Affiliates (including, without limitation, for the purposes of evidencing credit rating or other support); or (iv) making such disclosures as may be required by applicable Law.

(c) GE and Genworth agree that the underwriting, marketing, or issuing of payment protection products (as defined in the Framework Agreement) by GE's Consumer Finance Division in Europe shall be governed by the Framework Agreement. GE agrees that to the extent GE or any other controlled Affiliate of GE desires

to offer payment protection products in the jurisdictions covered by the Framework Agreement in conjunction with a consumer financing arrangement where GE or a GE Affiliate acts as the provider of finance, GE shall, or shall cause such controlled Affiliate, to enter into an arrangement substantially similar to, and for the period covered by, the Framework Agreement.

63

(d) GE agrees that if it or any of its controlled Affiliates decides to purchase mortgage insurance or any similar products in respect of any residential first mortgage loans or any such loans as it may purchase from third parties, it will so advise Genworth and, if the contemplated transactions would be in a market where Genworth is authorized to conduct such business, or can become so authorized within a three month period, seek a proposal for such coverage from Genworth no later than when it seeks such proposals or offers from any other sources. This obligation shall not apply in a market where GE or such controlled Affiliate has an existing relationship with a third party provider where it decides to purchase additional cover in respect of residential first mortgage loans from that provider in that market. GE and its controlled Affiliates will retain the right, in their sole discretion, to accept or reject Genworth's proposals or terms.

(e) The parties agree that it is not their intention to violate any law. The parties intend that the provisions of this Section 6.12 be enforced to the fullest extent permissible under the laws applicable in each jurisdiction in which enforcement is sought. If any provision of this Section 6.12 is found by a court or arbitrator to be unenforceable, the parties authorize the court or arbitrator to amend or modify the provision to make it enforceable in the most restrictive fashion permitted by law. For the avoidance of doubt, any Disputes relating to this Section 6.12 shall be resolved in accordance with the procedures set forth in Article VII of this Agreement except, with respect to paragraph (c), as otherwise provided in the Framework Agreement. GE acknowledges that any violation of the restrictions set forth above could result in irreparable injury to Genworth and that, in the event of a violation by GE or its Affiliates, Genworth shall be entitled to obtain injunctive relief in accordance with Article VII.

#### 6.13 Committees.

(a) Compensation Committee. Prior to the Trigger Date, the compensation committee of the board of directors of Genworth shall be comprised of three directors, one of whom shall be designated by GE and two of whom shall be independent directors as defined under the applicable rules of any securities exchange on which shares of Genworth Common Stock are listed. From and after the Trigger Date, the compensation committee shall be comprised of three directors each of whom shall be independent directors as defined under the applicable rules of any securities exchange on which shares of Genworth Common Stock are listed.

(b) Nominating Committee. Prior to the Trigger Date the nominating committee shall be comprised of five directors, one of whom shall be the chief executive officer of Genworth, one of whom shall be designated by GE and three of whom shall be independent directors as defined under the applicable rules of any securities exchange on which shares of Genworth Common Stock are listed. From and after the Trigger Date, the nominating committee shall be comprised of three directors each of whom shall be independent directors as defined under the applicable rules of any securities exchange on which shares of Genworth Common Stock are listed.

64

6.14 Genworth Bridge Loan. Genworth shall enter into the Genworth Bridge Loan prior to the consummation of the Initial Public Offering.

6.15 GE Policies. If a provision of Genworth's Amended and Restated Certificate of Incorporation or Amended and Restated Bylaws or of any Transaction Document contradicts a policy of the GE Parties (the "GE Policies") that applies to Subsidiaries of GE, such provision in Genworth's Amended and Restated Certificate of Incorporation or Amended and Restated Bylaws or Transaction Document shall control. In any other case, and except as otherwise agreed or unless superseded by any policies adopted by the board of directors of Genworth, the GE Policies that apply to Subsidiaries of GE shall apply to Genworth and its Subsidiaries until the Trigger Date. The key GE Policies applicable to Genworth and its Subsidiaries as of the Closing Date are listed on Schedule 6.15.

#### 6.16 HomeBuyer Now Program; GE Relocation Program

(a) From and after the Closing Date, the parties agree to use their commercially reasonable efforts to continue discussions relating to a proposed agreement between the parties relating to (i) the provision of the same or similar goods and services currently provided by members of the GE Group in support of the HomeBuyer Privileges and HomeBuilder Privileges programs and other marketing arrangements between the parties relating thereto and (ii) the terms and conditions of the proposed HomeBuyer Now platforms, including Emerging Markets, Telemundo and Builder programs. The parties acknowledge that an agreement, if any, between the parties relating to the foregoing shall be set forth in definitive documentation executed by the appropriate members of the GE Group and the Genworth Group.

(b) From and after the Closing Date, the parties agree that Genworth shall have the right to recommend one or more mortgage lender customers as a preferred mortgage lender provider for the GE Group's employee relocation programs and the parties shall use their commercially reasonable efforts to continue discussions for potential inclusion of such recommended lenders.

6.17 Joint Management Committee. Genworth and GE shall use their commercially reasonable efforts (i) to promptly negotiate in good faith the terms of a letter agreement addressing the matters described in Exhibit KK hereto, (ii) following negotiation of such letter agreement, to seek and obtain all regulatory approvals necessary to allow the parties to the Reinsurance Agreements to enter into such letter agreement and (iii) to cause such subsidiaries to enter into such letter agreement following receipt of all required regulatory approvals.

65

## ARTICLE VII

### DISPUTE RESOLUTION

#### 7.1 General Provisions.

(a) Any dispute, controversy or claim arising out of or relating to this Agreement or the Transaction Documents (other than the Transaction Documents set forth on Schedule 7.1), or the validity, interpretation, breach or termination thereof (a "Dispute"), shall be resolved in accordance with the procedures set forth in this Article VII, which shall be the sole and exclusive procedures for the resolution of any such Dispute unless otherwise specified below.

(b) Commencing with a request contemplated by Section 7.1(f) set forth below, all communications between the parties or their representatives in connection with the attempted resolution of any Dispute, including any mediator's evaluation referred to in Section 7.3 set forth below, shall be deemed to have been delivered in furtherance of a Dispute settlement and shall be exempt from discovery and production, and shall not be admissible in evidence for any reason (whether as an admission or otherwise), in any arbitral or other proceeding for the resolution of the Dispute.

(c) Except as provided in Section 7.1(f) in connection with any Dispute, the parties expressly waive and forego any right to (i) special, indirect,

incidental, punitive, consequential, exemplary, statutorily-enhanced or similar damages in excess of compensatory damages (provided that liability for any such damages with respect to a Third Party Claim shall be considered direct damages), and (ii) trial by jury.

(d) The specific procedures set forth below, including but not limited to the time limits referenced therein, may be modified by agreement of the parties in writing.

(e) All applicable statutes of limitations and defenses based upon the passage of time shall be tolled while the procedures specified in this Article VII are pending. The parties will take such action, if any, required to effectuate such tolling.

(f) Notwithstanding anything to the contrary contained in this Article VII, any Dispute relating to GE's rights as a stockholder of Genworth pursuant to applicable Law, Genworth's Amended and Restated Certificate of Incorporation or Genworth's Amended and Restated Bylaws, including GE's rights as the holder of the Class B Common Stock, will not be governed by or subject to the procedures set forth in this Article VII. The parties hereto hereby irrevocably submit to the exclusive jurisdiction of any state court located within the State of Delaware over any such Dispute and each party hereby irrevocably agrees that all claims in respect of any such Dispute or any suit, action proceeding related thereto may be heard and determined in such courts. The parties hereby irrevocably waive, to the fullest extent permitted by applicable Law, any objection which they may now or hereafter have to the laying of

66

---

venue of any such Dispute brought in such court or any defense of inconvenient forum for the maintenance of such dispute. Each of the parties hereto agrees that a judgment in any such Dispute may be enforced in other jurisdictions by suit on the judgment or in any other manner provided by Law.

7.2 Consideration by Senior Executives. If a Dispute is not resolved in the normal course of business at the operational level, the parties shall attempt in good faith to resolve such Dispute by negotiation between executives who hold, at a minimum, the office of President and CEO of the respective business entities involved in such Dispute. Either party may initiate the executive negotiation process by providing a written notice to the other (the "Initial Notice"). Fifteen (15) days after delivery of the Initial Notice, the receiving party shall submit to the other a written response (the "Response"). The Initial Notice and the Response shall include (i) a statement of the Dispute and of each party's position, and (ii) the name and title of the executive who will represent that party and of any other person who will accompany the executive. Such executives will meet in person or by telephone within thirty (30) days of the date of the Initial Notice to seek a resolution of the Dispute.

7.3 Mediation. If a Dispute is not resolved by negotiation as provided in Section 7.2 within forty-five (45) days from the delivery of the Initial Notice, then either party may submit the Dispute for resolution by mediation pursuant to the CPR Institute for Dispute Resolution (the "CPR") Model Mediation Procedure as then in effect. The parties will select a mediator from the CPR Panels of Distinguished Neutrals. Either party at commencement of the mediation may ask the mediator to provide an evaluation of the Dispute and the parties' relative positions.

7.4 Arbitration.

(a) If a Dispute is not resolved by mediation as provided in Section 7.3 within thirty (30) days of the selection of a mediator (unless the mediator chooses to withdraw sooner), either party may submit the Dispute to be finally resolved by arbitration pursuant to the CPR Rules for Non-Administered Arbitration as then in effect (the "CPR Arbitration Rules"). The parties consent to a single, consolidated arbitration for all known Disputes existing at the time of the arbitration and for which arbitration is permitted.

(b) The neutral organization for purposes of the CPR Arbitration Rules will be the CPR. The arbitral tribunal shall be composed of three arbitrators, of whom each party shall appoint one in accordance with the "screened" appointment procedure provided in Rule 5.4 of the CPR Arbitration Rules. The arbitration shall be conducted in New York City. Each party shall be permitted to present its case, witnesses and evidence, if any, in the presence of the other party. A written transcript of the proceedings shall be made and furnished to the parties. The arbitrators shall determine the Dispute in accordance with the law of the State of New York, without giving effect to any conflict of law rules or other rules that might render such law inapplicable or unavailable, and shall apply this Agreement and the Transaction Documents according to their respective terms; provided, however, that any Dispute in

67

---

respect of a Transaction Document which by its terms is governed by the law of a jurisdiction other than the State of New York shall be determined by the law of such other jurisdiction and; provided, further, however, that the provisions of this Agreement relating to arbitration shall in any event be governed by the Federal Arbitration Act, 9 U.S.C. §§ 1 et seq.

(c) The parties agree to be bound by any award or order resulting from any arbitration conducted in accordance with this Section 7.4 and further agree that judgment on any award or order resulting from an arbitration conducted under this Section 7.4 may be entered and enforced in any court having jurisdiction thereof.

(d) Except as expressly permitted by this Agreement, no party will commence or voluntarily participate in any court action or proceeding concerning a Dispute, except (i) for enforcement as contemplated by Section 7.4(c) above, (ii) to restrict or vacate an arbitral decision based on the grounds specified under applicable law, or (iii) for interim relief as provided in paragraph (e) below. For purposes of the foregoing, the parties hereto submit to the non-exclusive jurisdiction of the courts of the State of New York.

(e) In addition to the authority otherwise conferred on the arbitral tribunal, the tribunal shall have the authority to make such orders for interim relief, including injunctive relief, as it may deem just and equitable. Notwithstanding Section 7.4(d) above, each party acknowledges that in the event of any actual or threatened breach of the provisions of (i) Section 6.2, Section 6.12 or Section 6.13, (ii) the Employee Matters Agreement, (iii) the Cross License Agreement, (iv) the Transitional Trademark License Agreement or (v) the Registration Rights Agreement, the remedy at law would not be adequate, and therefore injunctive or other interim relief may be sought immediately to restrain such breach. If the tribunal shall not have been appointed, either party may seek interim relief from a court having jurisdiction if the award to which the applicant may be entitled may be rendered ineffectual without such interim relief. Upon appointment of the tribunal following any grant of interim relief by a court, the tribunal may affirm or disaffirm such relief, and the parties will seek modification or rescission of the court action as necessary to accord with the tribunal's decision.

(f) Each party will bear its own attorneys' fees and costs incurred in connection with the resolution of any Dispute in accordance with this Article VII.

ARTICLE VIII

8.1 Corporate Power; Fiduciary Duty.

- (a) Each of the GE Parties represents on behalf of itself, and Genworth represents on behalf of itself, as follows:

68

---

(i) each such Person has the requisite corporate or other power and authority and has taken all corporate or other action necessary in order to execute, deliver and perform each of this Agreement and each other Transaction Document to which it is a party and to consummate the transactions contemplated hereby and thereby; and

(ii) this Agreement and each Transaction Document to which it is a party has been duly executed and delivered by it and constitutes a valid and binding agreement of it enforceable in accordance with the terms thereof.

(b) Notwithstanding any provision of this Agreement or any Transaction Document, none of the GE Parties nor Genworth shall be required to take or omit to take any act that would violate its fiduciary duties to any minority stockholders of Genworth or any non-wholly owned Subsidiary of GE or Genworth, as the case may be (it being understood that directors' qualifying shares or similar interests will be disregarded for purposes of determining whether a Subsidiary is wholly owned).

8.2 Governing Law. This Agreement and, unless expressly provided therein, each other Transaction Document, shall be governed by and construed and interpreted in accordance with the Laws of the State of New York irrespective of the choice of Laws principles of the State of New York other than Section 5-1401 of the General Obligations Law of the State of New York.

8.3 Survival of Covenants. Except as expressly set forth in any Transaction Document, the covenants and other agreements contained in this Agreement and each Transaction Document, and liability for the breach of any obligations contained herein or therein, shall survive each of the Separation and the Initial Public Offering and shall remain in full force and effect; provided, however, that Genworth's obligations under Sections 4.6 and 4.9 shall terminate on the first date on which GE ceases to beneficially own, in the aggregate (excluding for such purposes shares of Genworth Common Stock beneficially owned by GE but not for its own account, including (in such exclusion) beneficial ownership which arises by virtue of some entity that is an Affiliate of GE being a sponsor of or advisor to a mutual or similar fund that beneficially owns shares of Genworth Common Stock) at least one percent (1%) of the outstanding Genworth Common Stock.

8.4 Force Majeure. No party hereto (or any Person acting on its behalf) shall have any liability or responsibility for failure to fulfill any obligation (other than a payment obligation) under this Agreement or, unless otherwise expressly provided therein, any Transaction Document, so long as and to the extent to which the fulfillment of such obligation is prevented, frustrated, hindered or delayed as a consequence of circumstances of Force Majeure. A party claiming the benefit of this provision shall, as soon as reasonably practicable after the occurrence of any such event: (i) notify the other parties of the nature and extent of any such Force Majeure condition and (ii) use due diligence to remove any such causes and resume performance under this Agreement as soon as feasible.

69

---

8.5 Notices. All notices, requests, claims, demands and other communications under this Agreement and, to the extent applicable and unless otherwise provided therein, under each of the Transaction Documents shall be in writing and shall be given or made (and shall be deemed to have been duly given or made upon receipt) by delivery in person, by overnight courier service, by facsimile with receipt confirmed (followed by delivery of an original via overnight courier service) or by registered or certified mail (postage prepaid, return receipt requested) to the respective parties at the following addresses (or at such other address for a party as shall be specified in a notice given in accordance with this Section 8.5):

If to the GE Parties, to:

[to be completed]

If to Genworth, to:

[to be completed]

8.6 Severability. If any term or other provision of this Agreement is invalid, illegal or incapable of being enforced under any Law or as a matter of public policy, all other conditions and provisions of this Agreement shall nevertheless remain in full force and effect. Upon such determination that any term or other provision is invalid, illegal or incapable of being enforced, the parties to this Agreement shall negotiate in good faith to modify this Agreement so as to effect the original intent of the parties as closely as possible in a mutually acceptable manner in order that the transactions contemplated by this Agreement be consummated as originally contemplated to the greatest extent possible.

8.7 Entire Agreement. Except as otherwise expressly provided in this Agreement, this Agreement (including the Schedules and Exhibits hereto) constitutes the entire agreement of the parties hereto with respect to the subject matter of this Agreement and supersedes all prior agreements and undertakings, both written and oral, between or on behalf of the parties hereto with respect to the subject matter of this Agreement.

8.8 Assignment; No Third-Party Beneficiaries. This Agreement shall not be assigned by any party hereto without the prior written consent of the other parties hereto. Except as provided in Article V with respect to Indemnified Parties, this Agreement is for the sole benefit of the parties to this Agreement and members of their respective Group and their permitted successors and assigns and nothing in this Agreement, express or implied, is intended to or shall confer upon any other Person or entity any legal or equitable right, benefit or remedy of any nature whatsoever under or by reason of this Agreement.

8.9 Public Announcements. GE and Genworth shall consult with each other before issuing, and give each other the opportunity to review and comment upon, any press release or other public statements with respect to the transactions contemplated by this Agreement and the Transaction Documents, and shall not issue any such press release or make any such public statement prior to such consultation,

70

---

except as may be required by applicable Law, court process or by obligations pursuant to any listing agreement with any national securities exchange or national securities quotation system.

8.10 Amendment. No provision of this Agreement may be amended or modified except by a written instrument signed by all the parties to such agreement. No waiver by any party of any provision hereof shall be effective unless explicitly set forth in writing and executed by the party so waiving. The waiver by any party hereto of a breach of any provision of this Agreement shall not operate or be construed as a waiver of any other subsequent breach.



8.11 Rules of Construction. Interpretation of this Agreement shall be governed by the following rules of construction: (a) words in the singular shall be held to include the plural and vice versa and words of one gender shall be held to include the other gender as the context requires, (b) references to the terms Article, Section, paragraph, and Schedule are references to the Articles, Sections, paragraphs, and Schedules to this Agreement unless otherwise specified, (c) the word "including" and words of similar import shall mean "including, without limitation," (d) provisions shall apply, when appropriate, to successive events and transactions, (e) the table of contents and headings contained herein are for reference purposes only and shall not affect in any way the meaning or interpretation of this Agreement and (f) this Agreement shall be construed without regard to any presumption or rule requiring construction or interpretation against the party drafting or causing any instrument to be drafted.

8.12 Counterparts. This Agreement may be executed in one or more counterparts, and by the different parties to each such agreement in separate counterparts, each of which when executed shall be deemed to be an original but all of which taken together shall constitute one and the same agreement. Delivery of an executed counterpart of a signature page to this Agreement by facsimile shall be as effective as delivery of a manually executed counterpart of any such Agreement.

[The remainder of this page is intentionally left blank]

71

---

IN WITNESS WHEREOF, the parties hereto have caused this Agreement to be executed on the date first written above by their respective duly authorized officers.

GENERAL ELECTRIC COMPANY

By: \_\_\_\_\_  
Name:  
Title:

GENERAL ELECTRIC CAPITAL CORPORATION

By: \_\_\_\_\_  
Name:  
Title:

GEI, INC.

By: \_\_\_\_\_  
Name:  
Title:

GE FINANCIAL ASSURANCE HOLDINGS, INC.

By: \_\_\_\_\_  
Name:  
Title:

GENWORTH FINANCIAL, INC.

By: \_\_\_\_\_  
Name:  
Title:

72

---

**Schedule 1.1**

**Discontinued Businesses**

GE Property and Casualty Insurance Company  
GE Casualty Insurance Company  
GE Indemnity Insurance Company  
GE Auto & Home Insurance Company  
Bayside Casualty Insurance Company

73

---

**Schedule 1.1(a)**

**Supply and Vendor Contracts**

1. Car Lease dated 22 August 2003 between GE Deutschland GmbH and GE Capital Services GmbH (trading as Avis Fleet Services)
2. Car Lease dated 19 February 2003 between GE International, Inc. and Locadif S.P.R.L./B.V.B.A. (trading as Avis Fleet Services)
3. Car Lease dated 31 July 2002 between GE International, Inc. and GE Capital Aro Lease B.V.
4. The agreements listed on Annex A (Ops & Sourcing)
5. The agreements listed on Annex B (MI Europe)
6. The agreements listed on Annex C (IT Documents)
7. The agreements listed on Annex D (GEFI Europe)

**Annex A**

**Schedule 1.1(a)  
to  
Master Agreement  
(Ops and Sourcing)**

**Section A (Complete Transfer):**

No.	Contract Name	Agreement Date	Vendor	GE Party
1.	Avis Corporation-GE Homebuyer Privileges Program Agreement - Final (Uploaded as "Avis Rent A Car Homebuyer Privileges Agmt 2002-08")	8/24/2002	Avis Corporation, The ("Avis")	GEMICO on behalf of GE
2.	Cendant Travel-GE Homebuyer Privileges Program Agreement (Uploaded as "Cendant Travel Homebuyer privileges Agreement")	7/1/2002	Cendant Travel, Inc. ("CTI")	GEMICO on behalf of GE
3.	Flooring America-GE Homebuyer Privileges Program Agreement and Web Linking Addendum (Uploaded as "Flooring America Homebuyer Privileges Agreement 2002-1")	Agreement 10/1/2002 Web Linking Addendum 1/31/2003	FA Management Enterprises, Inc. ("FA")	GEMICO on behalf of GE
4.	GE Consumer Products-GE Homebuyer Privileges Program Agreement (Uploaded as "GE Consumer Products Homebuyer Privileges Agmt 20")	4/4/2003	GE through its Consumer Products business [this interest remains with GE]	GEMICO on behalf of GE [this interest to be transferred to Genworth]
5.	GESMI-GE Homebuyer Privileges Program Agreement	5/8/2003	GE Service Management, Inc. [this interest remains with GE]	GEMICO on behalf of GE [this interest to be transferred to Genworth]

6.	Home Depot-GE Homebuyer Privileges Program Agreement (Uploaded as "Home Depot Homebuyer Privileges Agmt 2001-02-28")	2/28/2001	Home Depot U.S.A., Inc. ("Home Depot")	GEMICO on behalf of GE
7.	Attachment A to Home Depot-GEMICO Homebuyer Privileges Program Agreement (Uploaded as "Home Depot Homebuyer Privileges Agmt Attachment A")	2/28/2001	Home Depot U.S.A., Inc. ("Home Depot"); Homer TLC, Inc. ("Homer")	GEMICO on behalf of GE

No.	Contract Name	Agreement Date	Vendor	GE Party
8.	Penske Auto Centers-General Electric Company Lender Program Memorandum of Understanding (Uploaded as "Penske Auto Centers Homebuyer Privileges Agmt 200")	10/31/2000	Penske Auto Centers, LLC	GEMICO on behalf of GE
9.	Penske Truck Rental-General Electric Company Lender Program Memorandum of Understanding (Uploaded as "Penske Truck Leasing Homebuyer Privileges Agmt 20")	7/11/2000	Penske Truck Leasing Co., L.P.	GEMICO on behalf of GE
10.	Addendum to Staffing Agreement	5/8/2003	Kelly Health Care Resources	<b>General Electric (1640 Los Gatos San Rafael)—not signed</b>

### Section B: GE owns Master, split

The GE Group shall retain the following master agreements and shall retain any licenses, leases, addendums and similar arrangements thereunder pursuant to which any software, hardware, equipment or services are acquired that do not relate primarily to the Genworth Business. All licenses, leases, addendums and similar arrangements under any of the following master agreements in the name of any member of the GE Group (other than GEFAHI) that relate primarily to the Genworth Business shall be assigned to a member of the Genworth Group.

No.	Contract Name	Agreement Date	Vendor	GE Party
1.	Variation Agreement	1/2003	Experian Ltd (formerly CCN Group Ltd)	GE Capital Corp
2.	Master Professional Printing Services Agreement	3/5/2003	FCL Graphics Incorporated	GEFAHI
3.	License Agreement Amendment	8/31/2000	FinanCenter, Inc. ("FinanCenter")	GEMICO
4.	Quote and Linking Agreement	9/9/1999	FinanCenter, Inc.	GEFAHI (Substituted as contracting entity for GE Capital) & GE Center for Financial Learning
5.	Master Services Agreement	7/3/2003	Kelly Services, Inc.	General Electric Capital Corporation
6.	Noosh, Inc. Print Buyer Agreement	12/31/2003	Noosh, Inc.	GNA Corporation
7.	Master Professional Printing Services Agreement	8/30/2002	Service Envelope Corporation	GEFAHI
8.	Agreement for Purchase of Products	4/16/2001	Xerox Corporation	General Electric Company
9.	Agreement between AT&T and various subsidiaries of GE Financial Assurance	4/1/2001	AT&T Corp.	UFLIC, CPFIC, SA, CCS, GCDP & GEFAHI
10.	Master Services Agreement (including Exhibit A; General Agent/Brokerage General Agent Agreement)	5/30/2000	Insurance Answer Center, Inc.	GEFAHI

**Section C: Genworth owns Master, split**

The Genworth Group shall retain the following master agreements and shall retain any licenses, leases, addendums and similar arrangements thereunder pursuant to which any software, hardware, equipment or services are acquired that relate primarily to the Genworth Business. All licenses, leases, addendums and similar arrangements under any of the following master agreements in the name of any member of the Genworth Group that do not relate primarily to the Genworth Business shall be assigned to a member of the GE Group.

No.	Contract Name	Agreement Date	Vendor	GE Party
1.	Multipurpose Confidentiality Agreement	4/14/2003	The Wackenhut Corporation	GEFAHI
2.	Services Contract (with addenda for various locations; 5 .pdf files)	12/12/2001	The Wackenhut Corporation	GEFAHI
3.	On-Line Service Subscription Agreement	12/27/2001	OneSource Information Services, Inc.	GEFAHI

**Annex B****Schedule 1.1(a) for MI Europe****Section B: GE owns Master, split**

The GE Group shall retain the following master agreements and shall retain any licenses, leases, addendums and similar arrangements thereunder pursuant to which any software, hardware, equipment or services are acquired that do not relate primarily to the Genworth Business. All licenses, leases, addendums and similar arrangements under any of the following master agreements in the name of any member of the GE Group (other than GEFAHI) that relate primarily to the Genworth Business shall be assigned to a member of the Genworth Group.

Contract Name	Date	Vendor	GE Party
Master License Agreement	2/10/2004	Pumatech, Inc.	General Electric Co.
License Agreement for Chain Link Technologies	5/19/1997	Kintana, Inc. (formerly Chain Link Technologies)	General Electric Co.
License Agreement for Computer Software Products	6/1/1999	Trend Micro, Inc.	General Electric Co.

**Annex C**

**Schedule 1.1(a)  
to  
Master Agreement  
(IT documents)**

**Section A (Complete Transfer):**

Contract Name	Date	Vendor	GE Party
Master Software System License Agreement and Addendum	3/12/1996	Servantis Systems, Inc. ("SSI")	GE Capital Corporation Commercial Processing Services = Customer
DDV Master Agreement	4/16/2001	Digital Datavoice Corporation	UFLIC
Master Software Site License Agreement	No date provided	Principia Partners, LLC ("Principia")	GE Asset Management Incorporated ("GEAM")
2002-2003 REIS Services License Agreement	9/30/2002	REIS, Inc.	GEAM
Letter Agreement	6/23/1994	Wilshire Associates Inc.	GEAM
Agreement for Thomson Financial Services - Thomson Analytics	9/15/2003	Thomson Financial	GEAM

**Section B: GE owns Master, split**

The GE Group shall retain the following master agreements and shall retain any licenses, leases, addendums and similar arrangements thereunder pursuant to which any software, hardware, equipment or services are acquired that do not relate primarily to the Genworth Business. All licenses, leases, addendums and similar arrangements under any of the following master agreements in the name of any member of the GE Group (other than GEFAHI) that relate primarily to the Genworth Business shall be assigned to a member of the Genworth Group.

Contract Name	Date	Vendor	GE Party
Information Technology Services Agreement and Predecessor Agreements	1/1/2004	TCS	General Electric International, Inc. ("GEII")
Information Technology Services Agreement and Predecessor Agreements	Patni Computer Systems LTD	General Electric International, Inc. ("GEII")	
Master Lease/Rental Agreement	2/10/1995	Hewlett-Packard Company = Lessor	General Electric Company = Lessee
Information Technology Services Agreement and Predecessor Agreements		Satyam Computer Services	General Electric International, Inc. ("GEII")
Master Lease Agreement	Undated	Sun Microsystems Finance = Lessor	General Electric Company = Lessee
Software License Agreement	6/25/2001	Sun Microsystems, Inc. ("Sun")	General Electric Company = Licensee
Global Master Purchase/Service Agreement	7/1/2003	Avaya World Services, Inc. = Avaya	General Electric Company = Customer
Lease Agreement	2/28/1988	AT&T Credit Corp.	General Electric Co.
International Lease and Finance Agreement	10/19/1999	IBM Credit Corporation	General Electric Company
Master License Agreement	9/20/1999	Lotus Development Corporation	General Electric Company

79

Contract Name	Date	Vendor	GE Party
Master Managed Network Solutions Agreement	Undated (although amendments indicate a date of 11/5/1999)	AT&T Solutions ("AT&T")	General Electric Company ("Customer")
Master Wide Area Networking Services Agreement	Undated	AT&T Corp. ("AT&T")	General Electric Company ("Company")
AT&T Wireless Services National Accounts Agreement	7/24/1998	AT&T Wireless Services National Accounts, Inc., as agent for Carriers ("AWS"). "Carrier" means companies who operate commercial mobile radio telecommunications systems who are either under common control with AWS or have agreed to participate in AWS' National Accounts Program, each as to a licensed area. (Recitals)	General Electric Company ("Customer")
a. National Cellular Agreement b. and c. Application for Service	a. 1/24/2000 b. and c. Undated	a. Celco Partnership d/b/a Bell Atlantic Mobile ("BAM") b. and c. Verizon	General Electric Company
Purchase, License and Service Agreement	3/23/1995	FileNet Corporation ("FileNet")	General Electric Capital Corporation
Master Software License and Installation Agreement	3/21/1997	Pegasystems Inc. ("Pega")	GE Capital Corporation
Recovery Services Agreement and all schedules	7/1/1997	SunGard Recovery Services, Inc.	General Electric Company
Master License Agreement No. 131362 For Distributed Systems Software	3/30/2001	Compuware Corporation ("Compuware")	General Electric Company ("GE")
Software License and Services Agreement	Undated	Siebel Systems, Inc. ("Siebel")	GE Company
Software License and Services Agreement	Undated	Siebel Systems, Inc. ("Siebel")	GE Capital Services, Inc. = Customer
Master Wide Area Networking Agreement	Undated	Qwest Communications Corporation ("Qwest") note: name is now Visinet	General Electric Corporation ("GE")
Sprint PCS Premier Account Term Service Agreement (Version 11.99)	1/17/2000	Sprint Spectrum L.P. d/b/a Sprint PCS	General Electric Company ("GE Co.")

Master Wide Area Networking Services Agreement	10/1/2002	Sprint Communications Company, L.P. ("Sprint")	General Electric Corporation
VPNterprise Communications Services Agreement	5/1/2003	Fiberlink Communications Corporation	General Electric Corporation
Master Services Agreement (without limitation, Genworth receives the Cisco Email Messenger)		Cisco Systems, Inc. ("Cisco")	General Electric Company
Basic Ordering Agreement	1/30/1992	Cisco Systems, Inc. ("Cisco")	General Electric Co.
License Agreement for Open System Products	12/31/1998	BMC Software Distribution, Inc. ("BMC")	General Electric Company
General Electric License to Use Informatica Software	No date provided	Informatica Corporation ("Informatica")	General Electric Corporation
Perpetual License Agreement for Computer Software Products	3/27/1985	Computer Network Corporation ("CNC")	General Electric Credit Corporation [now General Electric Capital Corporation]
Settlement and Release Agreement	12/28/1998	International Business Machines Corporation ("IBM") , Group 1 Software, Inc.	General Electric Capital Corporation

80

Contract Name	Date	Vendor	GE Party
First Amended and Restated Enterprise License Agreement	7/1/2001	Computer Associates International, Inc.	General Electric Company
Trillium Software System License and Professional Services Agreement	7/19/1999	Harte Hanks Data Technologies	GE Capital Corp
Software License Agreement	6/19/2000	Business Objects Americas	GE Capital Services Inc
Software License and Services Agreement	8/1/1998	AppWorx Corporation	General Electric Corp
GE-EMC Master Global Procurement Agreement	11/16/2001	EMC Corporation	General Electric Company
Master Wide Area Networking Services Agreement	6/4/2002	Broadwing Communications Services, Inc.	General Electric Company
Master Contract Service Arrangement Agreement	9/19/2000	BellSouth Telecommunications, Inc.	General Electric Company
Software License and Services Agreement	5/31/2002	Oracle Corporation	a. General Electric Company
Microsoft/GE License Agreement	2/1/2000	MSLI, GP	General Electric Company
Enterprise License Agreement Renewal Addendum	7/27/2002	Citrix Systems Inc.	General Electric Company
Enterprise License Agreement	11/10/2000	Courion Corporation ("Courion")	General Electric Company
Software License Agreement	Undated (The license agreement is effective upon acceptance.)	Attachmate	GEFAHI
GE-Internet Security Systems, Inc. Enterprise Software License Subscription	12/28/1998	Internet Security Systems, Inc. ("ISS")	General Electric Company ("GE")
Software License Agreement between Netegrity, Inc. and General Electric Company	8/2/1999	Netegrity, Inc. ("Netegrity")	General Electric Company ("GE")
Information Technology Services Agreement and Predecessor Agreements		Birlasoft	General Electric International
Lasercycle Supply Agreement	7/28/2000	LASERCYCLE INKCYCLE	GE Capital Corporation GEMICO
Appropriation Request	7/16/2003	GXS	GE Capital Mortgage = GEMH
Advanced Server and Services Agreement		Red Hat, Inc.	General Electric Global Computer Operations
Custom International Customer Support Program Agreement	2/1/1997	SunService Division, Sun Microsystems, Inc.	General Electric Company
Technology Services Agreement		International Business Machines Corporation ("IBM")	GE Capital Corp.
Master Agreement for Call Center Quality Monitoring Systems	8/18/1999	Teknekron Infoswitch Corp	GE
U.S. Corporate End User License Agreement	1/31/2003	Network Associates, Inc.	General Electric Company

Software License Agreement	12/26/2001	GE Information Services, Inc.	General Electric Company
Addendum to Software License Agreement	12/26/2001	Global eXchange Services Canada, Inc.	GECMICAN
Electronic Commerce Services Agreement	6/28/2002	Global eXchange Services Canada, Inc.	General Electric Company

81

Contract Name	Date	Vendor	GE Party
Canon Copier Agreement	5/11/2001	Canon U.S.A., Inc.	General Electric Corporation
GE/Ricoh Corporation National Account Agreement and Amendment Number One to National Agreement by and between Ricoh Corporation and GE Company	1/1/2001	Ricoh Corporation	GE Company Corporate Initiatives Group
GE-Compaq Master Purchase and Services Agreement	5/21/2002	Compaq Computer Corporation	General Electric Company
Master License Agreement	11/00/1999	Broadvision Inc	General Electric Company
Master Agreement for Data Imaging Services		Anacomp, Inc.	GE Capital
Network Services Agreement - Yield Book	1/16/1995	Analytics Technology Corporation ("ATC")	GEAM
Software Licensing Agreement - Yield Book	1/16/1995	Salomon Brothers Inc ("Salomon")	GEAM
Standard & Poor's Master Subscription Agreement, S&P Ratings Direct Credit Wire Only.	6/1/2003	Standard & Poor's ("S&P")	GEAM
Reuters Services Contract	9/1/1998	Reuters America Inc. ("Reuters")	GEAM
Moody's KMV Subscription Agreement	2/1/2003	Moody's KMV Company ("Moody's")	General Electric Company
System License Agreement Bondedge for Windows, Enterprise Edition	6/14/1999	Capital Management Sciences ("CMS")	GEAM
Leasing Agreement	11/21/2003	Sun Microsystems Finance	GEAM
Software License Agreement		Realm Business Solutions, Inc.	GEAM
Bloomberg Agreement #145083	8/24/1995	Bloomberg L.P.	GEAM
Bloomberg Agreement #107247	8/19/1994	Bloomberg L.P.	GEAM

### Section C: Genworth owns Master, split

The Genworth Group shall retain the following master agreements and shall retain any licenses, leases, addendums and similar arrangements thereunder pursuant to which any software, hardware, equipment or services are acquired that relate primarily to the Genworth Business. All licenses, leases, addendums and similar arrangements under any of the following master agreements in the name of any member of the Genworth Group that do not relate primarily to the Genworth Business shall be assigned to a member of the GE Group.

Contract Name	Date	Vendor	GE Party
Master Lease Agreement	10/20/2000	Dell Financial Services, L.P. ("Dell")	GEFAHI
Master Lease Agreement	8/26/2003	Comsource, Inc. ("Comsource")	GEFAHI
GEFAHI Master Lease Agreement		EMC Corporation	GEFAHI
License Agreement	12/31/2001	Classic Solutions Pty Limited ("Classic")	GEFAHI
License Agreement		Mercury Interactive	GEFAHI
Software License Agreement	No date provided	Edify Corporation ("Edify")	GEFAHI ("Licensee")
Assignment Agreement	4/24/2002	Sterling Commerce / Connect Direct	GEFAHI

82

Schedule 1.1(b)

### GEFAHI Contracts

1. The agreements listed on Annex A (Ops & Sourcing) and Annex B (IT Documents)
2. The following contracts and agreements related exclusively to the disposition of the Discontinued Businesses and related transaction

documents:

- Stock Purchase Agreement, dated June 26, 2003, between GEFAHI and Lexington Insurance Company
- Amendment No. 1 to the Stock Purchase Agreement, dated August 29, 2003, between GEFAHI and Lexington Insurance Company
- Transition Services Agreement, dated August 29, 2003, among GEFAHI, Lexington Insurance Company and GE Property & Casualty Insurance Company, GE Auto & Home Assurance Company, GE Casualty Insurance Company, GE Indemnity Insurance Company and Bayside Casualty Insurance Company
- Computer Services Agreement, dated August 29, 2003, among GEFAHI, Lexington Insurance Company and GE Property & Casualty Insurance Company, GE Auto & Home Assurance Company, GE Casualty Insurance Company, GE Indemnity Insurance Company and Bayside Casualty Insurance Company
- Transitional Trademark License Agreement, dated August 29, 2003, among GEFAHI, Lexington Insurance Company and GE Property & Casualty Insurance Company, GE Auto & Home Assurance Company, GE Casualty Insurance Company, GE Indemnity Insurance Company and Bayside Casualty Insurance Company
- Intellectual Property Cross-License Agreement, dated August 29, 2003, among GEFAHI, Lexington Insurance Company and GE Property & Casualty Insurance Company, GE Auto & Home Assurance Company, GE Casualty Insurance Company, GE Indemnity Insurance Company and Bayside Casualty Insurance Company
- Letter Agreement, dated August 28, 2003, by and among GEFAHI, Lexington Insurance Company and AIG Marketing, Inc. (Re: Certain Employee Matters)
- Letter Agreement, dated August 29, 2003, by and between GEFAHI and Lexington Insurance Company (Re: Tiffany Ko Syzch)
- Letter Agreement, dated August 29, 2003, by and between GEFAHI and Lexington Insurance Company (Re: Certain Computer Equipment and Software Matters)
- Letter Agreement, dated August 29, 2003, by and between GEFAHI and Lexington Insurance Company (Re: Records Access)
- Tax Termination and Settlement Agreement, by and among GEFAHI, GE Property & Casualty Insurance Company, GE Casualty Insurance Company, GE Auto & Home Assurance Company, Bayside Casualty Insurance Company and GE Indemnity Insurance Company
- Master Termination of Intercompany Agreements, dated August 29, 2003, among General Electric Company (on behalf of itself and all of its wholly owned subsidiaries), GE Property & Casualty Insurance Company, GE Auto & Home Assurance Company, GE Casualty Insurance Company, GE Indemnity Insurance Company and Bayside Casualty Insurance Company, GE Financial Assurance Japan, Ltd., GE Edison Life Insurance Company, GE Edison Services Company, and Toho Shinyo Hosho Company

8. Transition Services Agreement, dated as of August 29, 2003, among GEFAHI, American International Reinsurance Company, Ltd., GE Financial Assurance Japan Ltd., GE Edison Life Insurance Company, GE Edison Services Company and Toho Shinyo Hosho Company
9. Intellectual Property Cross-License Agreement among GEFAHI, GE Financial Assurance Japan, Ltd., GE Edison Life Insurance Company, GE Edison Services Company, Toho Shinyo Hosho Company and American International Reinsurance Company, Ltd., dated as of August 29, 2003
10. Computer Services Agreement, dated as of August 29, 2003, among GEFAHI, American International Reinsurance Company, Ltd., GE Financial Assurance Japan Ltd., GE Edison Life Insurance Company, GE Edison Services Company and Toho Shinyo Hosho Company
11. GEFAHI Comfort Letter to the Directors of GE Pensions Limited Society in connection with the demutualization of National Mutual Life Assurance Society
12. Any and all obligations of GEFAHI under agreements relating to its commercial paper program, including, without limitation, obligations arising under any swap agreements related thereto and obligations under the following agreements: (i) U.S. Commercial Paper Private Placement Memorandum dated November 18, 2003 (replacing and superceding a U.S. Commercial Paper Private Placement Memorandum dated February 28, 2000, as supplemented on March 16, 2000), (ii) Placement Agency Agreement dated November 14, 1997, between GECC Capital Markets Group, Inc., and GEFAHI, (iii) Issuing and Paying Agent Agreement dated November 13, 1997, among GEFAHI, GECC and Deutsche Bank, as amended November 18, 2003 and (iv) Issuing and Paying Agent and Citi Treasury Manager Agreement dated November 14, 1997, among GEFAHI, GECC and Citibank, N.A., as amended November 18, 2003
13. Revolving Credit Agreement dated as of 2-28-00, between GE Capital Corporation, as lender, and GEFAHI, as borrower (as amended by Amendment No. 1 dated 10-10-00, Amendment No. 2 dated 4-23-02 and Amendment No. 3 dated 8-1-03)



14. Master Promissory Note (GE Capital Assignment Corporation, as lender, and GEFAHI, as borrower)
15. Master Promissory Note dated as of February 17, 2004, GEFAHI, as lender, and UFLIC, as borrower)
16. Master Promissory Note dated as of 12-20-99 (GEFAHI, as lender, and Signature Financial/ Marketing, Inc., as borrower)
17. Master Promissory Note (GEFAHI, as lender, and Heritage Life Insurance Company, as borrower)
18. Master Promissory Note dated 12-2-97 (GEFAHI, as lender, as Heritage Mechanical Breakdown Corporation, as borrower)

19. Guaranty by GEFAHI to USAA relating to Signature Financial/USAA Program Services Agreement
20. GEFAHI and ABN AMRO Bank ISDA Master Agreement dated 12-17-01
21. GEFAHI and Bank of America NA ISDA Master Agreement dated 6-20-02
22. GEFAHI and Banque Paribas ISDA Master Agreement dated 3-31-98
23. GEFAHI and Bear Stearns Fin Prod Inc ISDA Master Agreement dated 2-12-01
24. GEFAHI and CDC Fin Prod Inc ISDA Master Agreement dated 10-29-02
25. GEFAHI and CSFB International ISDA Master Agreement dated 1-17-02
26. GEFAHI/eHealthInsurance Agreement among GEFAHI, GE Capital Insurance Agency, Inc., and eHealthInsuranceServices, Inc., dated 12-1-00
27. Confidentiality Agreement between Signature Agency, Inc., and its parent, subsidiary and affiliate corporations and GEFAHI dated 3-11-99
28. Acknowledgement of Agreement pursuant to Master Managed Services Agreement between GE Capital Corporation and GE IT Solutions (GECITS) (f/k/a GE Capital Information Technology Solutions North America Inc.) dated as of January 11, 2002, as amended, and Scope of Work between GECITS and GEFAHI effective as of October 1, 2002, as amended.
29. Promissory Note, dated April 8, 2002, made by GECC, as borrower, and GEFAHI, as lender, in the original principal amount of GBP 90,800,000 together with the Term Loan Agreement, dated April 8, 2002 related thereto

30. Promissory Note, dated April 8, 2002, made by GECC, as borrower, and GEFAHI, as lender, in the original principal amount of GBP 29,000,000, together with the Term Loan Agreement, dated April 8, 2002 related thereto
31. Securities Purchase Agreement dated as of July 14, 2000, by and among Centerprise Advisors, Inc. and certain named Purchasers, including GEFAHI
32. Series A Warrant dated as of July 14, 2000 issued by Centerprise Advisors, Inc. to GE Financial Assurance Holdings, Inc., and any subsequent Series A Warrants issued to GEFAHI
33. Warrant Holder Agreement dated as of July 14, 2000, by and among Centerprise Advisors, Inc. and certain named Warrant Holders, including GEFAHI
34. Registration Rights Agreement dated as of July 14, 2000, by and among Centerprise Advisors, Inc. and certain named Holders, including GEFAHI

35. Voting Agreement dated as of July 14, 2000 by and among GEFAHI and BGL Capital Partners, LLC
36. GE Financial Network Wireless Agreement dated July 14, 2000, by and between AnyDevice.com and GEFAHI
37. Master Services Agreement dated as of September 28, 2000, by and between MyFamily.com and GEFAHI
38. Website Development, Co-Branding and Licensing Agreement dated as of February 15, 2000, by and between Secure Commerce Service, Inc. d/b/a Paytrust and GEFAHI
39. Website Development, Co-Branding and Licensing Agreement dated as of March 31, 2000, by and between Netstock Direct Corporation and GEFAHI
40. Consulting Services Agreement dated as of December 1, 1999, by and between X Communications and GEFAHI
41. Website Development, Co-Branding and Licensing Agreement dated as of October 12, 2000, by and between Cendant Mortgage Corporation and GEFAHI
42. GE Financial Assurance/eHealthinsurance Agreement dated as of December 1, 2000, by and between EhealthInsurance Services, Inc. and GEFAHI
43. Warrant to Purchase Shares of Preferred Stock dated as of December 1, 2000, by and between EhealthInsurance Services, Inc. and GEFAHI

44. Confidentiality Agreement dated as of August 12, 2002, by and between AMA Insurance Agency, Inc. and GEFAHI
45. Standard List Protection Agreement dated as of January 1, 2003, by and between American Legion Auxiliary National Headquarters and GEFA
46. Confidentiality Agreement dated as of July 19, 2002, by and between Ameritrade Holding Corporation and GEFAHI
47. Data Use Agreement dated as of December 31, 1998, by and between Acxiom Corporation and GEFAHI
48. Confidentiality Agreement dated as of May 30, 2001, by and between Cross Country Automotive Services, Inc. and GEFAHI
49. Mutual Confidentiality Non-Disclosure Agreement dated as of October 24, 2000, by and between Life Line Screening of America LLC and GEFAHI
50. Master Lease Agreement dated as of April 1, 2000, by and between NTFC Capital Corporation and GEFAHI

86

---

51. NonDisclosure Agreement dated as of March 25, 1999, by and between SPR, Inc. and GEFAHI
52. United Center Suite License Agreement dated as of June 20, 2001, by and between United Center Joint Venture and GEFA
53. Master Professional Services Agreement dated as of June 24, 2003, by and between Rawhide Internet Services, Inc. and GEFAHI

87

---

**Annex A**

**Schedule 1.1(b)  
to  
Master Agreement  
(Ops & Sourcing)**

**Section A (Complete Retention):**

No.	Contract Name	Agreement Date	Vendor	GE Party
11.	GE Master Professional Printing Services Agreement	8/30/2002	Rainbow Graphics Inc.	GEFAHI
12.	Indemnification and Hold Harmless Agreement	9/19/2001	Milliman USA, Inc.	GEFA
13.	Master Professional Printing Services Agreement	5/7/2003	Mail-Well Chicago	GEFAHI

14.	Master Professional Printing Services Agreement	Automated Presort, Inc.	GEFAHI
15.	Addendum to Master Professional Printing Services Agreement	Automated Presort, Inc.	GEFAHI

**Section B: GE owns Master, split**

The GE Group shall retain the following master agreements and shall retain any licenses, leases, addendums and similar arrangements thereunder pursuant to which any software, hardware, equipment or services are acquired that do not relate primarily to the Genworth Business. All licenses, leases, addendums and similar arrangements under any of the following master agreements in the name of a member of the GE Group that relate primarily to the Genworth Business shall be assigned to a member of the Genworth Group.

No.	Contract Name	Agreement Date	Vendor	GE Party
1.	Master Professional Printing Services Agreement	3/5/2003	FCL Graphics Incorporated	GEFAHI
2.	License Agreement Amendment	8/31/2000	FinanCenter, Inc. ("FinanCenter")	GEMICO
3.	Quote and Linking Agreement	9/9/1999	FinanCenter, Inc.	GEFAHI (Substituted as contracting entity for GE Capital) & GE Center for Financial Learning
4.	Master Services Agreement	7/3/2003	Kelly Services, Inc.	General Electric Capital Corporation
5.	Master Professional Printing Services Agreement	8/30/2002	Service Envelope Corporation	GEFAHI
6.	Agreement for Purchase of Products	4/16/2001	Xerox Corporation	General Electric Company
7.	Agreement between AT&T and various subsidiaries of GE Financial Assurance	4/1/2001	AT&T Corp.	UFLIC, CPFIC, SA, CCS, GCDP & GEFAHI
8.	Master Services Agreement (including Exhibit A; General Agent/Brokerage General Agent Agreement)	5/30/2000	Insurance Answer Center, Inc.	GEFAHI

**Section C: Genworth owns Master, split**

The following master agreements and any licenses, leases, addendums and similar arrangements thereunder pursuant to which any software, hardware, equipment or services are acquired that relate primarily to the Genworth Business shall be assigned to a member of the Genworth Group. All licenses, leases, addendums and similar arrangements under any of the following master agreements in the name of GEFAHI or any member of the Genworth Group that do not relate primarily to the Genworth Business shall be retained by or assigned to GEFAHI.

No.	Contract Name	Agreement Date	Vendor	GE Party
4.	Multipurpose Confidentiality Agreement	4/14/2003	The Wackenhut Corporation	GEFAHI
5.	Services Contract (with addenda for various locations; 5 .pdf files)	12/12/2001	The Wackenhut Corporation	GEFAHI
6.	On-Line Service Subscription Agreement	12/27/2001	OneSource Information Services, Inc.	GEFAHI

**Schedule 1.1(b)  
Master Agreement Schedules  
(IT documents)**

**Section A (Complete Retention):**

Contract Name	Date	Vendor	GE Party
Master Equipment Lease Agreement and all equipment	7/16/2002	Avaya	GEFAHI

Licensed Business Product Schedule to Bowstreet License Agreement	12/29/2000	Bowstreet.com, Inc. ("Bowstreet")	GEFAHI
Licensed Business Product Schedule to Bowstreet License Agreement	11/17/2001	Bowstreet.com, Inc. ("Bowstreet")	GEFAHI
Licensed Business Product Schedule to Bowstreet License Agreement	4/30/2001	Bowstreet.com, Inc. ("Bowstreet")	GEFAHI
Licensed Business Product Schedule to Bowstreet License Agreement	12/31/2001	Bowstreet.com, Inc. ("Bowstreet")	GEFAHI
Amendment to Bowstreet Master Licensing Agreement	3/27/2003	Bowstreet.com, Inc. ("Bowstreet")	GEFAHI
Master License Agreement	7/24/2000	Claritas Inc. ("Claritas")	GEFAHI
Claritas Inc. License Agreement	9/24/1998	Claritas Inc. ("Claritas")	GEFAHI

**Section B: GE owns Master, split**

The GE Group shall retain the following master agreements and shall retain any licenses, leases, addendums and similar arrangements thereunder pursuant to which any software, hardware, equipment or services are acquired that do not relate primarily to the Genworth Business. All licenses, leases, addendums and similar arrangements under any of the following master agreements in the name of a member of the GE Group that relate primarily to the Genworth Business shall be assigned to a member of the Genworth Group.

Contract Name	Date	Vendor	GE Party
Information Technology Services Agreement and Predecessor Agreements	1/1/2004	TCS	General Electric International, Inc. ("GEII")
Information Technology Services Agreement and Predecessor Agreements		Patni Computer Systems LTD	General Electric International, Inc. ("GEII")
Master Lease/Rental Agreement	2/10/1995	Hewlett-Packard Company = Lessor	General Electric Company = Lessee
Information Technology Services Agreement and Predecessor Agreements		Satyam Computer Services	General Electric International, Inc. ("GEII")
Master Lease Agreement	Undated	Sun Microsystems Finance = Lessor	General Electric Company = Lessee
Software License Agreement	6/25/2001	Sun Microsystems, Inc. ("Sun")	General Electric Company = Licensee
Global Master Purchase/Service Agreement	7/1/2003	Avaya World Services, Inc. = Avaya	General Electric Company = Customer
Lease Agreement	2/28/1988	AT&T Credit Corp.	General Electric Co.
International Lease and Finance Agreement	10/19/1999	IBM Credit Corporation	General Electric Company

Contract Name	Date	Vendor	GE Party
Master License Agreement	9/20/1999	Lotus Development Corporation	General Electric Company
Master Managed Network Solutions Agreement	Undated (although amendments indicate a date of 11/5/1999)	AT&T Solutions ("AT&T")	General Electric Company ("Customer")
Master Wide Area Networking Services Agreement	Undated	AT&T Corp. ("AT&T")	General Electric Company ("Company")
AT&T Wireless Services National Accounts Agreement	7/24/1998	AT&T Wireless Services National Accounts, Inc., as agent for Carriers ("AWS"). "Carrier" means companies who operate commercial mobile radio telecommunications systems who are either under common control with AWS or have agreed to participate in AWS' National Accounts Program, each as to a licensed area. (Recitals)	General Electric Company ("Customer")

a. National Cellular Agreement b. and c. Application for Service	a. 1/24/2000 b. and c. Undated	a. Celco Partnership d/b/a Bell Atlantic Mobile ("BAM") b. and c. Verizon	General Electric Company
---	-----------------------------------	--	--------------------------

Purchase, License and Service Agreement	3/23/1995	FileNet Corporation ("FileNet")	General Electric Capital Corporation
Master Software License and Installation Agreement	3/21/1997	Pegasystems Inc. ("Pega")	GE Capital Corporation
Recovery Services Agreement and all schedules	7/1/1997	SunGard Recovery Services, Inc.	General Electric Company
Master License Agreement No. 131362 For Distributed Systems Software	3/30/2001	Compuware Corporation ("Compuware")	General Electric Company ("GE")
Software License and Services Agreement	Undated	Siebel Systems, Inc. ("Siebel")	GE Company
Software License and Services Agreement	Undated	Siebel Systems, Inc. ("Siebel")	GE Capital Services, Inc. = Customer
Master Wide Area Networking Agreement	Undated	Qwest Communications Corporation ("Qwest")note: name is now Visinet	General Electric Corporation ("GE")
Sprint PCS Premier Account Term Service Agreement (Version 11.99)	1/17/2000	Sprint Spectrum L.P. d/b/a Sprint PCS	General Electric Company ("GE Co.")
Master Wide Area Networking Services Agreement	10/1/2002	Sprint Communications Company, L.P. ("Sprint")	General Electric Corporation
VPNterprise Communications Services Agreement	5/1/2003	Fiberlink Communications Corporation	General Electric Corporation
Master Services Agreement (without limitation, Genworth receives the Cisco Email Messenger)		Cisco Systems, Inc. ("Cisco")	General Electric Company
Basic Ordering Agreement	1/30/1992	Cisco Systems, Inc. ("Cisco")	General Electric Co.
License Agreement for Open System Products	12/31/1998	BMC Software Distribution, Inc. ("BMC")	General Electric Company
General Electric License to Use Informatica Software	No date provided	Informatica Corporation ("Informatica")	General Electric Corporation

Contract Name	Date	Vendor	GE Party
Perpetual License Agreement for Computer Software Products	3/27/1985	Computer Network Corporation ("CNC")	General Electric Credit Corporation [now General Electric Capital Corporation]
Settlement and Release Agreement	12/28/1998	International Business Machines Corporation ("IBM"), Group 1 Software, Inc.	General Electric Capital Corporation
First Amended and Restated Enterprise License Agreement	7/1/2001	Computer Associates International, Inc.	General Electric Company
Trillium Software System License and Professional Services Agreement	7/19/1999	Harte Hanks Data Technologies	GE Capital Corp
Software License Agreement	6/19/2000	Business Objects Americas	GE Capital Services Inc
Software License and Services Agreement	8/1/1998	AppWorx Corporation	General Electric Corp
GE-EMC Master Global Procurement Agreement	11/16/2001	EMC Corporation	General Electric Company
Master Wide Area Networking Services Agreement	6/4/2002	Broadwing Communications Services, Inc.	General Electric Company
Master Contract Service Arrangement Agreement	9/19/2000	BellSouth Telecommunications, Inc.	General Electric Company
Software License and Services Agreement	5/31/2002	Oracle Corporation	a. General Electric Company
Microsoft/GE License Agreement	2/1/2000	MSLI, GP	General Electric Company
Enterprise License Agreement Renewal Addendum	7/27/2002	Citrix Systems Inc.	General Electric Company
Enterprise License Agreement	11/10/2000	Courion Corporation ("Courion")	General Electric Company
Software License Agreement	Undated (The license agreement is effective upon acceptance.)	Attachmate	GEFAHI
GE-Internet Security Systems, Inc. Enterprise Software License Subscription	12/28/1998	Internet Security Systems, Inc. ("ISS")	General Electric Company ("GE")

Software License Agreement between Netegrity, Inc. and General Electric Company	8/2/1999	Netegrity, Inc. (“Netegrity”)	General Electric Company (“GE”)
Custom International Customer Support Program Agreement	2/1/1997	SunService Division, Sun Microsystems, Inc.	General Electric Company
Canon Copier Agreement	5/11/2001	Canon U.S.A., Inc.	General Electric Corporation
GE/Ricoh Corporation National Account Agreement and Amendment Number One to National Agreement by and between Ricoh Corporation and GE Company	1/1/2001	Ricoh Corporation	GE Company Corporate Initiatives Group
GE-Compaq Master Purchase and Services Agreement	5/21/2002	Compaq Computer Corporation	General Electric Company
Master License Agreement	11/00/1999	Broadvision Inc	General Electric Company
Master Agreement for Data Imaging Services		Anacomp, Inc.	GE Capital
Network Services Agreement - Yield Book	1/16/1995	Analytics Technology Corporation (“ATC”)	GEAM
Software Licensing Agreement - Yield Book	1/16/1995	Salomon Brothers Inc (“Salomon”)	GEAM

92

Contract Name	Date	Vendor	GE Party
Standard & Poor’s Master Subscription Agreement, S&P Ratings Direct Credit Wire Only.	6/1/2003	Standard & Poor’s (“S&P”)	GEAM
Reuters Services Contract	9/1/1998	Reuters America Inc. (“Reuters”)	GEAM
Moody’s KMV Subscription Agreement	2/1/2003	Moody’s KMV Company (“Moody’s”)	General Electric Company
System License Agreement Bondedge for Windows, Enterprise Edition	6/14/1999	Capital Management Sciences (“CMS”)	GEAM
Leasing Agreement	11/21/2003	Sun Microsystems Finance	GEAM
Software License Agreement		Realm Business Solutions, Inc.	GEAM
Bloomberg Agreement #145083	8/24/1995	Bloomberg L.P.	GEAM
Bloomberg Agreement #107247	8/19/1994	Bloomberg L.P.	GEAM

### Section C: Genworth owns Master, split

The following master agreements and any licenses, leases, addendums and similar arrangements thereunder pursuant to which any software, hardware, equipment or services are acquired that relate primarily to the Genworth Business shall be assigned to a member of the Genworth Group. All licenses, leases, addendums and similar arrangements under any of the following master agreements in the name of GEFAHI or any member of the Genworth Group that do not relate primarily to the Genworth Business shall be retained by or assigned to GEFAHI.

Contract Name	Date	Vendor	GE Party
Master Lease Agreement	10/20/2000	Dell Financial Services, L.P. (“Dell”)	GEFAHI
Master Lease Agreement	8/26/2003	Comsorce, Inc. (“Comsource”)	GEFAHI
GEFAHI Master Lease Agreement		EMC Corporation	GEFAHI
License Agreement	12/31/2001	Classic Solutions Pty Limited (“Classic”)	GEFAHI
License Agreement		Mercury Interactive	GEFAHI
Software License Agreement	No date provided	Edify Corporation (“Edify”)	GEFAHI (“Licensee”)
Assignment Agreement	4/24/2002	Sterling Commerce / Connect Direct	GEFAHI

93

Schedule 1.1(e)

### Genworth Contracts

1. all contracts and arrangements to which Financial Assurance Company Limited is a party, including those within the definitions of Residual Assets, Residual Liabilities, Retained Insurances, Transferring Assets, Transferring Liabilities, Transferring Contracts, Transferring Insurances, Reinsurance Contracts (as such terms are defined in the UK Transfer Plan

2. all contracts and arrangements to which Vie Plus S.A. is a party to the extent relating to its payment protection business, including the marketing, sale, and administration thereof
  
3. all contracts and arrangements to which any of Financial Insurance Company Limited, Consolidated Insurance Group Limited, GE Financial Assurance, Compania de Seguros y Reaseguros de Vida SA and GE Financial Insurance, Compania de Seguros y Reaseguros SA is a party
  
4. all contracts and arrangements to which any of the GE Capital Mortgage Insurance Corporation (Australia) Pty Ltd., GE Mortgage Insurance Pty Ltd., or GEMICO Holdings (Australia) is a party. (1)
  
5. GE Homebuyer Privileges Lender Participation Agreements as listed on Annex A attached hereto in the name of GEMICO on behalf of General Electric Company and certain of its business units.
  
6. All agreements involving a member of the GE Group whereby a member of the GE Group acquired any member of the Genworth Group from a third party, except for any rights of a member of the GE Group under such agreement relating to any member of the GE Group acquired under any such agreement.
  
7. The lessee's interest in the co-location/Sublease Agreement dated April 1, 2002 between GE Real Estate and GE Asset Management for space located at 601 S. Figueroa Street, Los Angeles, CA, USA.
  
8. The lessee's interest in the lease dated January 20, 1977, as amended March 31, 1987, August 30, 1979, March 26, 1980, January 6, 1984, June 8, 1989, November 16, 1993, December 16, 1994, December, 19, 1995, April 26, 1996, January 16, 1997, July 22, 1997, April 28, 1998, March 28, 2001 (letter of understanding) and September, 2002 between Stamford Square Associates L.P. and GE Investment Distributors, Inc. for space located at 3001 Summer Street, Stamford, CT, USA.

- 
- (1) The transfers of the contracts of these entities to a member of the Genworth Group occurred on April 2004.

9. The sublessee's interest in the sublease dated October 24, 2003 between General Electric Capital Company and FGIC Holdings, Inc. for space located at 335 Madison Avenue, New York, NY, USA.

**HomeBuyer Privileges Lender Agreements**

1. 1st Advantage Mortgage, L.L.C.
2. Abn Amro Mortgage Group, Inc.
3. Advance Mortgage Corporation
4. Access National Mortgage
5. Affordable Home Mortgage, Llc
6. Alliance Mortgage Banking Corp.
7. Alliance Mortgage Company DbA First Alliance Bank
8. Alpine Bank
9. American Federal Mortgage Corp.
10. American Heritage Mortgage Corp.
11. American Mortgage Express Financial
12. American Mortgage Service Company
13. American Residential Mortgage Corp.



14. American United Mortgage Corp
15. Amerihome Mortgage Company, Llc
16. Amerisouth Mortgage Company
17. Ameristar Mortgage Corporation
18. Arlington Capital Mortgage Corporation
19. Aspen Mortgage Services
20. Atlantic Coast Federal
21. Baltimore American Mortgage Corp.
22. Bancplus
23. Bank of Mauston
24. Bank of Utah
25. Bell America Mortgage Llc
26. Bethpage Federal Credit Union
27. Boeing Employees Credit Union
28. Bremer Bank, N.A.
29. Broadview Mortgage Company
30. C & K Enterprises, Inc. DbA Pioneer Mortgage
31. C & R Mortgage Source, Llc
32. Cape Cod Bank and Trust Company
33. Capital City Bank
34. Capital Mortgage Funding L.L.C.
35. Capitol Commerce Mortgage Co.
36. Capitol Federal Savings Bank
37. CapWest Mortgage Corporation
38. Castle Bank
39. Cendant Mortgage Corporation
40. Centurybanc Mortgage
41. Citizens Federal Savings Bank
42. Cmg Mortgage, Inc.

43. Coastal Funding Group
44. Coastal Mortgage Services, Inc.
45. Colban Funding
46. Colban Funding Inc.
47. Colonial National Mortgage Corporation
48. Columbia National, Inc.
49. Commercial Federal Bank
50. Commonfund Mortgage Corp.
51. Community Banc Mortgage Llc
52. Community First Bank
53. Comunity Lending, Inc.
54. Cornerstone Home Mortgage Corp.
55. Cuc Mortgage Corporation
56. Draper and Kramer Mortgage Corp.
57. Eastern Bank
58. Eastern Financial Florida Credit Union
59. Easthampton Savings Bank
60. E-Loan, Inc.
61. Eustis Mortgage Corporation
62. Exchange Financial Corporation
63. Extraco Mortgage
64. Fairway Independent Mortgage Company
65. Family Choice Mortgage Corporation
66. First Citizens Bank and Trust Company
67. First Commonwealth Mortgage Corp.
68. First Eastern Mortgage Corp.
69. First Federal
70. First Federal Savings Bank of America
71. First Financial Bank
72. First Financial, A Division of Ivy Mortgage
73. First Mortgage Funding, Llc
74. First National Bank of Estes Park
75. First Priority Mortgage Inc.
76. First Tennessee Bank, N. A.
77. Firstmerit Bank, N.A.
78. Firstrust Mortgage Service
79. Flick Mortgage Investors, Inc.
80. Fnb Salem Bank & Trust, N.A.
81. Fox Cities Mortgage Corporation
82. Franklin American Mortgage Company
83. Golf Savings Bank
84. Grafton Suburban Credit Union
85. Great Midwest Bank, S.S.B.
86. Greenpoint Mortgage Funding, Inc.
87. Group One Mortgage Corporation
88. Harris Trust and Savings Bank - Chicago Real

89. Harwood-Russell Mortgage, Inc.
90. Heritage Federal Credit Union
91. Hibernia National Bank
92. Home Finance of America
93. Home Financing Center, Inc.
94. Home Funding Finders, Inc.
95. Home Mortgage Assured Corporation
96. Home Security Mortgage Corp.
97. Homebanc Mortgage Corporation
98. Homebound Mortgage
99. Homestead Funding Corp.
100. Homevest Mortgage Corporation
101. Hudson River Bank and Trust Company
102. Iberia Bank
103. Integra Bank N.A.
104. Intermountain Mortgage Company, Inc.
105. Ipi Skyscraper Mortgage Corporation
106. Ivanhoe Financial
107. Jersey Mortgage Company
108. L & G Mortgagebanc, Inc.
109. Lake Mortgage Company, Inc.
110. Leader Mortgage Company
111. Lender's One
112. Lendia
113. Liberty Bank
114. Liberty Bank, FSB
115. Loancity.Com
116. Lundin and Associates, Inc.
117. Mainline Mortgage Corporation
118. Mann Financial Inc.
119. Mc Cue Mortgage Company
120. Member First Mortgage, Llc
121. Metro Resources Service Corporation
122. MFC Mortgage, Inc.
123. Midway Mortgage Company, Inc.
124. Mortgage Centre, L.C.
125. Mortgage Financial Services, Inc.
126. Mortgage Investors Group, L.P.
127. Mortgage Loan Specialists
128. Mortgage Master, Inc.
129. Mortgage Partners Financial Services
130. Myers Park Mortgage
131. National Mortgage Access, Inc.
132. Nations Home Mortgage
133. New England Federal Credit Union
134. Nvr Mortgage Finance, Inc.

135. Oceanfirst Bank
136. Old Second National Bank of Aurora
137. Pacific Republic Mortgage Corporation
138. Paramount Mortgage Company
139. Park National Bank
140. Pathfinder Bank
141. Patriot Funding
142. Phoenix Savings Bank
143. Pinnacle Mortgage Group, Inc.
144. Pirimar Home Loans
145. Prairie State Mortgage
146. Premier Mortgage Group, A Limited
147. Prime Home Mortgage, Inc.
148. PrimeTrust Bank
149. Princeton Mortgage Corporation
150. Provantage Funding Corporation
151. Pulaski Mortgage Company
152. Rbc Centura Bank
153. RBCMortgage
154. Real Estate Mortgage Corp.
155. Republic Mortgage Llc
156. Republic State Mortgage
157. Residential Mortgage Group, Inc.
158. Resource Lender
159. R-G Crown Bank, FSB
160. RMS & Associates
161. Royal Mortgage Corp.
162. Salem Five Cents Savings Bank

163. Sandy Spring National Bank of Maryland
164. Schmidt Mortgage Company
165. Some Mortgage Bankers, Inc.
166. Seattle Savings Bank and
167. Sidus Financial Corporation
168. Sierra Pacific Mortgage Co., Inc.
169. Southbank, F.S.B.
170. Southern Community Banc Mortgage
171. Sovereign Bank
172. Space Coast Credit Union
173. Sterling Savings Bank And/Or Action Mortgage Co.
174. Stockton Turner
175. Suburban Mortgage, Inc.
176. Summit Lending of Hawaii
177. Sun American Mortgage Corporation
178. Sunset Bank
179. Suntrust Bank
180. Taylor, Bean and Whitaker Mortgage Corp.

27

---

181. The First National Bank of South Mississippi
182. The Mortgage People Company
183. The Northern Ohio Investment Company
184. Town & Country Bank
185. Transland Financial Services
186. Trident Mortgage Company
187. Trustcorp Mortgage Company
188. Ulster Savings Bank
189. Unifirst Mortgage Corporation
190. Union Federal Savings Bank of Indianapolis
191. United Capital Mortgage Corp.
192. United Kingfield Bank
193. United Mortgage
194. Universal Mortgage Corp. of Wisconsin
195. Unizan Bank, National Association
196. Usa Funding Corp.
197. Vitek Mortgage Group
198. Washington Federal Savings
199. Washington Mutual Bank, FA
200. Waterfield Financial Corporation
201. Watson Mortgage
202. Weichert Financial Services
203. Westlend Mortgage Group, Llc
204. Wilson Bank and Trust

28

---

**Schedule 2.1(a)**

**Plan of Separation**

The Separation shall be effected in accordance with the plan and structure set forth in the following documents:

1. Annex A sets forth the movements of U.S. GEFA/MI entities required to effect the Separation:
2. Annex B sets forth the movements of Mortgage International entities required to effect the Separation. As indicated therein, certain movements will occur prior to the Closing Date:
3. Annex C document sets forth the movements of European business entities required to effect the Separation. As indicated therein, certain movements will occur prior to the Closing Date:
4. Annex D reflects the Genworth and GEFAHI Pro-Forma organizational charts upon consummation of the Separation.

29

---

**Transactions Involving GE Capital Insurance Agency, Inc. on the Closing Date**

**1.) Contribution by GECC to GEI of GE Capital Insurance Agency, Inc. (GECIA). 2.) GEI then contributes same to GEFAHI. 3.) GEFAHI contributes GECIA to Genworth. 4.) Genworth dividends GECIA to GEFAHI.**

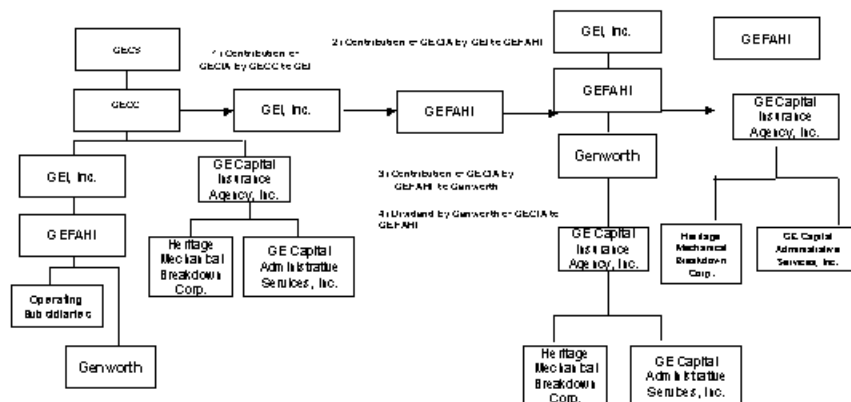

Master Agreement Schedule Item 11 Separation - GEFA

**Transactions Involving GEFA Subsidiary I, Inc. and GEFA Real Estate Holding LLC on the Closing Date**

**1.) Distribution by GNA Corporation of 100% of its membership interest in GEFA Real Estate Holding LLC to GEFAHI 2.) GEFAHI contributes 100% of its membership interest in GEFA Real Estate Holding LLC to GEFA Subsidiary I, Inc.**

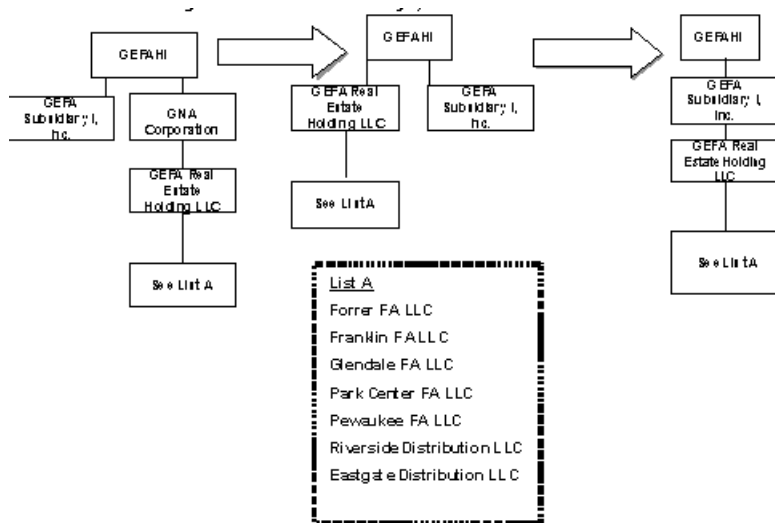

Master Agreement Schedule Item 11 Separation - GEFA

**On the Closing Date, GNA Corporation dividends Trooper Communications Corporation and Trooper Investment, Inc. to GEFAHI**

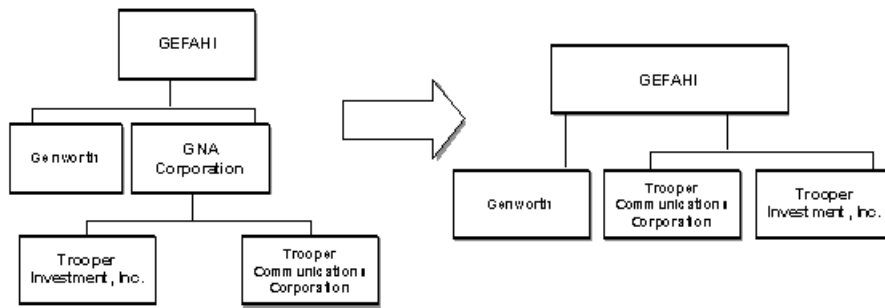

Master Agreement Schedule I Plan of Separation - GEFA

*Prior to the Closing Date the following transactions took place with respect to the ownership of Union Fidelity Life Insurance Company:*

- 1. FHL paid a stock dividend of the shares it held in UFLIC to GECA and GEFAHI, its respective shareholders,*
- 2. GECA paid a stock dividend of the UFLIC shares it received from FHL and all of its own interest in UFLIC to GNA,*
- 3. GNA paid a stock dividend of such shares to GEFAHI,*
- 4. GEFAHI paid a stock dividend of the shares it received from GNA plus the shares it received from FHL (together equal to 100% of UFLIC's outstanding common stock) to GEI, Inc. and*
- 5. GEI, Inc. sold such shares to GECS.*

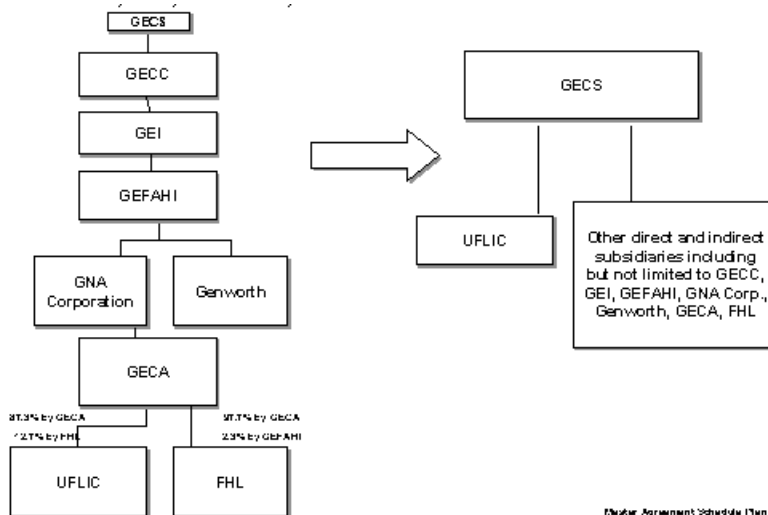

Master Agreement Schedule I Plan of Separation - GEFA

***On the Closing Date, GEFAHI contributes GNA Corp. together with its subsidiaries to Genworth***

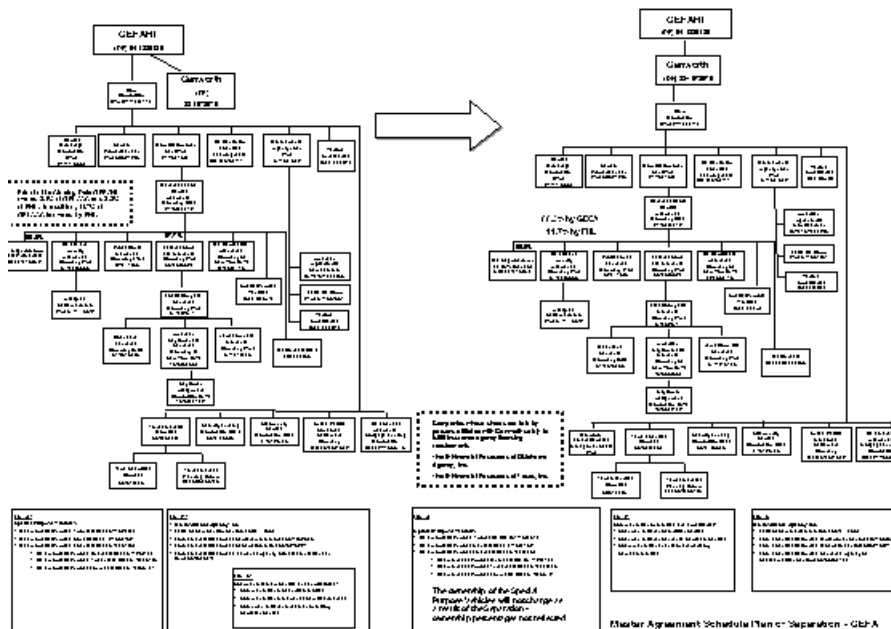

*On the Closing Date, GEFAHI contributes Brookfield Life Assurance Company to Genworth*

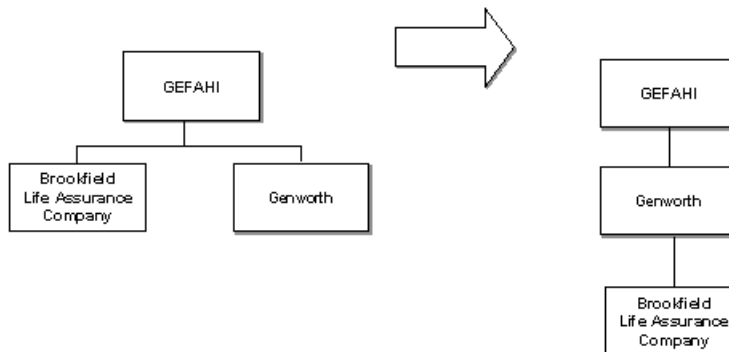

Master Agreement Schedule Plan of Separation - GEF A

**Miscellaneous GEFAHI Transfers**

*On the Closing Date, GEFAHI contributes GE Mortgage Holdings, LLC together with its subsidiaries to Genworth*

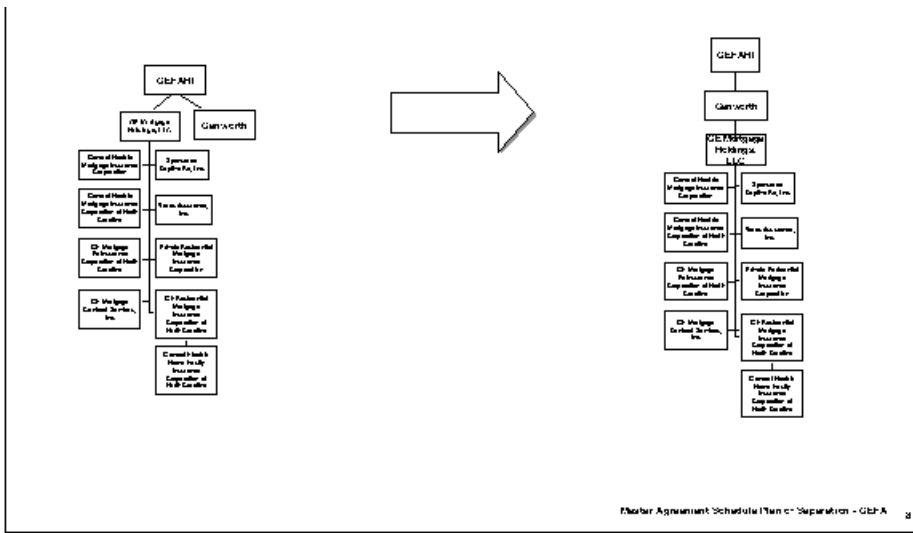

**Miscellaneous GEFAHI Transfers**

*On the Closing Date, GEFAHI contributes all stock held in the following companies to Genworth:*

- (a) *GE Group Retirement, Inc.*
- (b) *GE Group Administrators*
- (c) *Fee for Service, Inc.*
- (d) *GE Group Life Assurance Company*
- (e) *LTC, Incorporated*

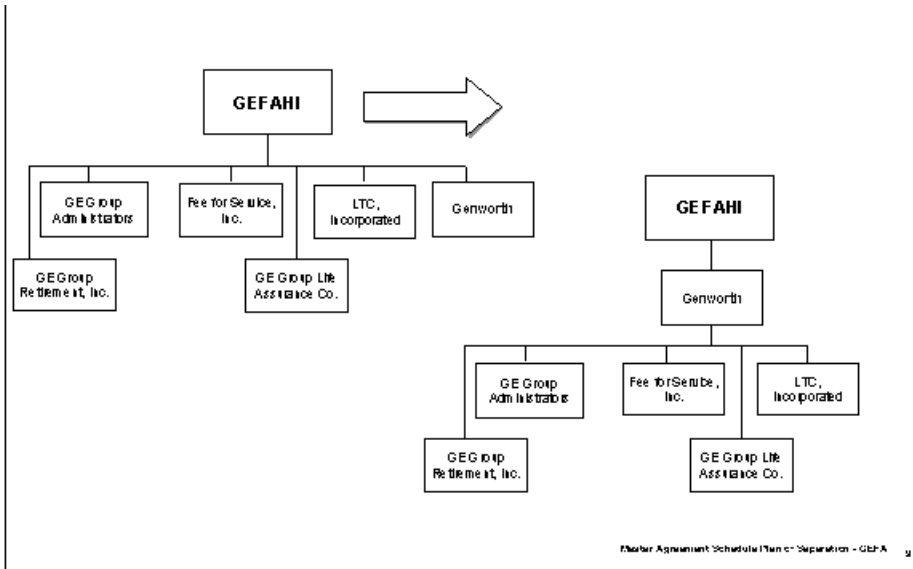

*On the Closing Date, GEFAHI contributes Viking Insurance Co., Ltd. to Genworth*

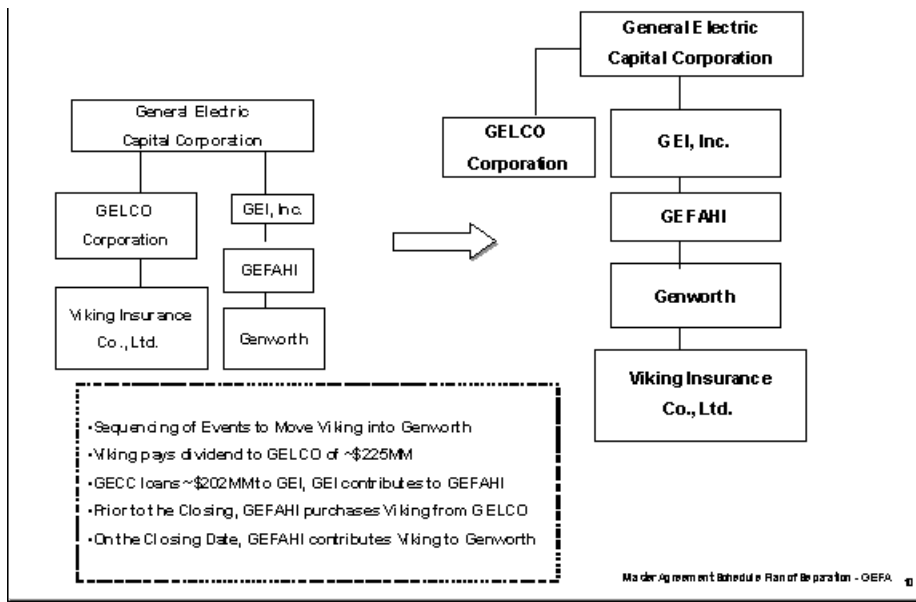

*Miscellaneous GEFAHI Transfers*

*On the Closing Date, GEFAHI contributes Dental Holdings, Inc. together with its subsidiary to Genworth*

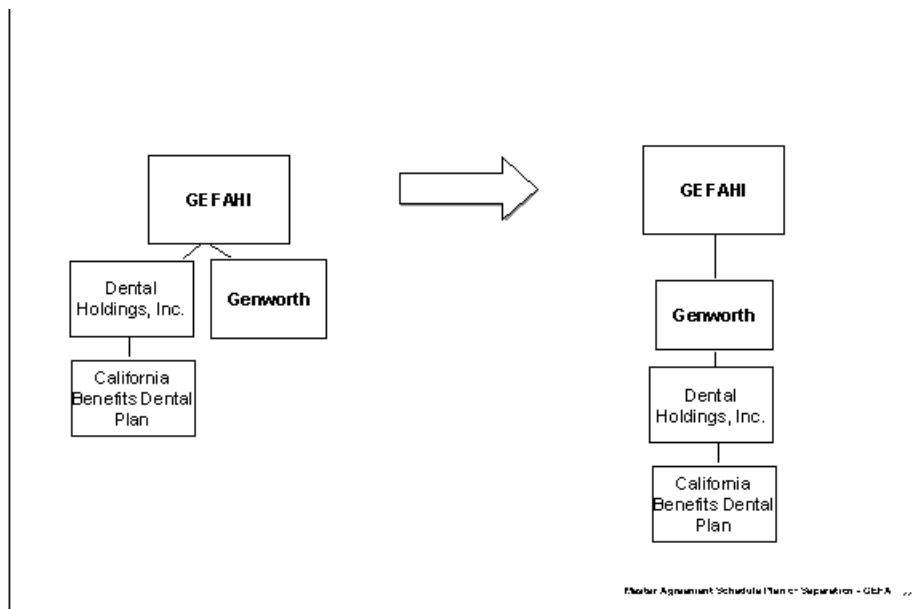

*Miscellaneous GEFAHI Transfers*

*On the Closing Date, GEFAHI contributes Centurion Capital Group, Inc. together with its subsidiaries to Genworth*



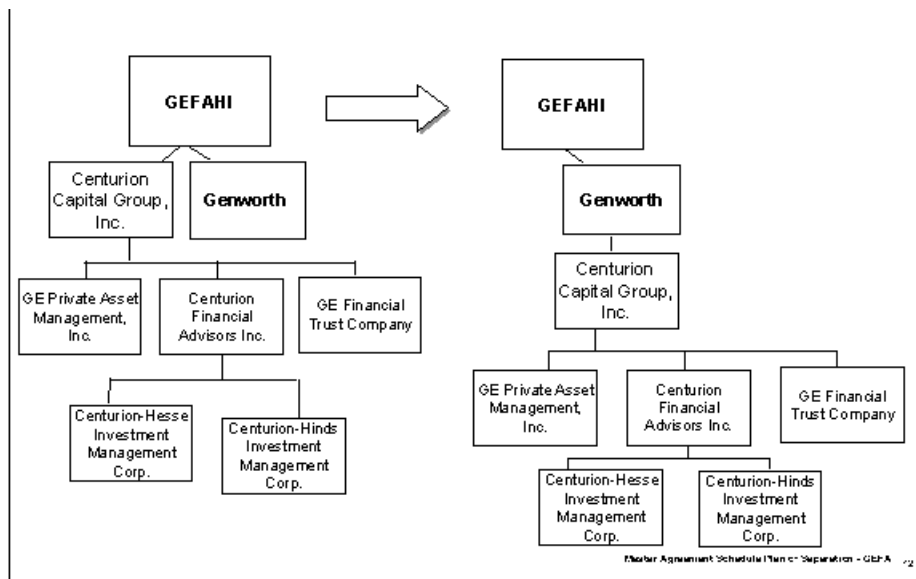

*Miscellaneous GEFAHI Transfers*

*On the Closing Date, GEFAHI contributes minority interests (3.1% and 2.3%) of GE Life and Annuity Assurance Company and Federal Home Life Insurance Company respectively to GECA through Genworth and GNA Corporation*

Transfer effected by:

- On the Closing Date, GEFAHI contributes 3.1% ownership in GELAAC to Genworth (800 shares)
- On the Closing Date, GEFAHI contributes 2.3% interest in FHL to Genworth (5,125 shares)
- Immediately subsequent thereto,

Genworth contributes such interests to GNA Corporation who in turns contributes its ownership in GELAAC and FHL to GECA and, FHL dividends its interest in GELAAC to GECA.

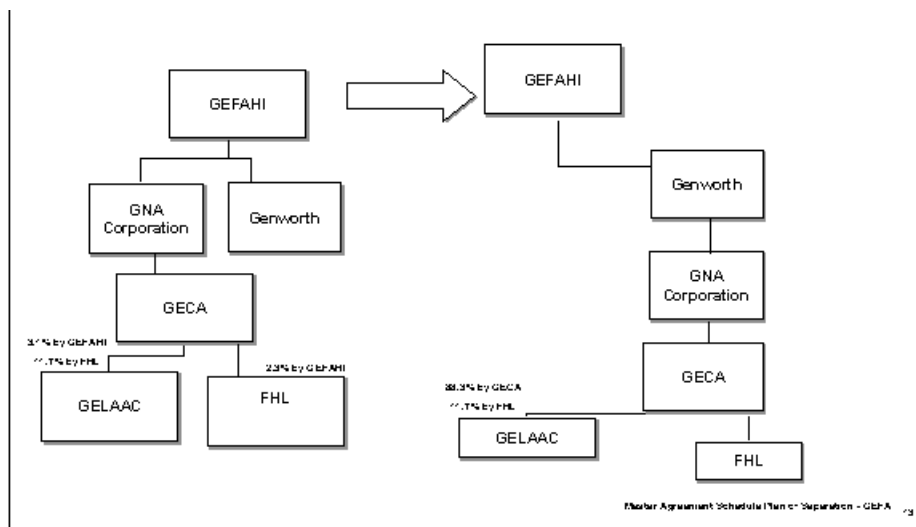

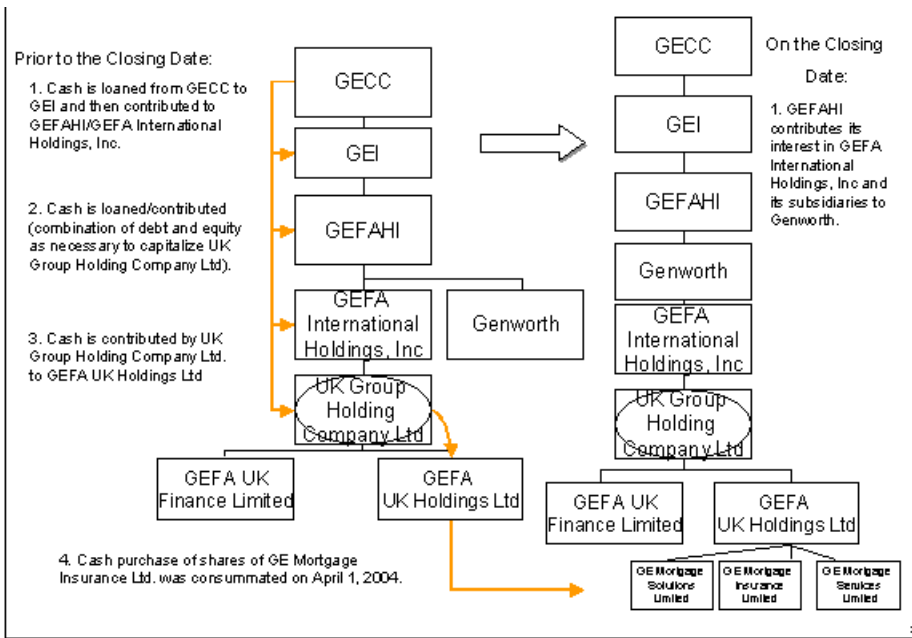

**Move Guernsey Mortgage Entity into GEFA International Holdings, Inc.**

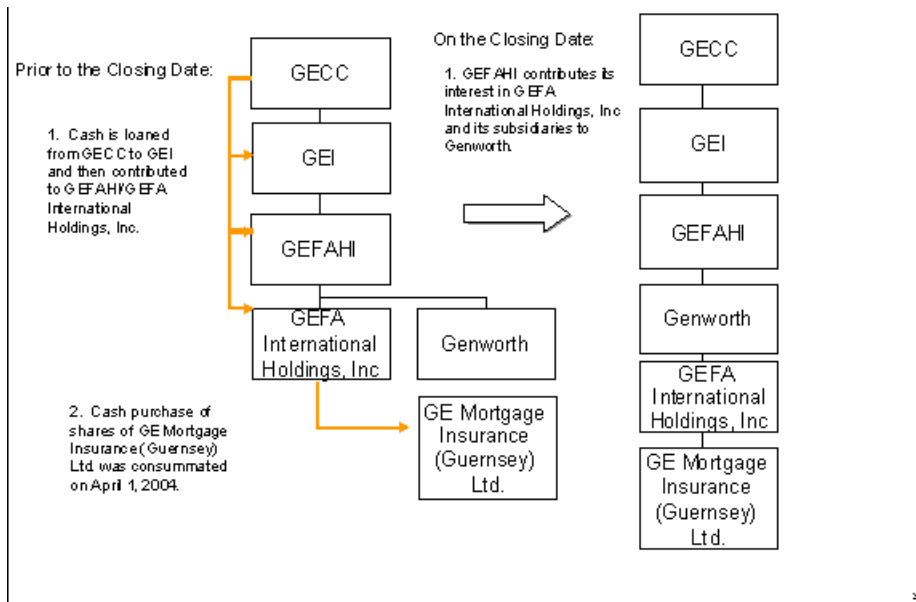

**Sale of GE Capital Mortgage Insurance Company of Canada to New GEMIC Holdings Company**

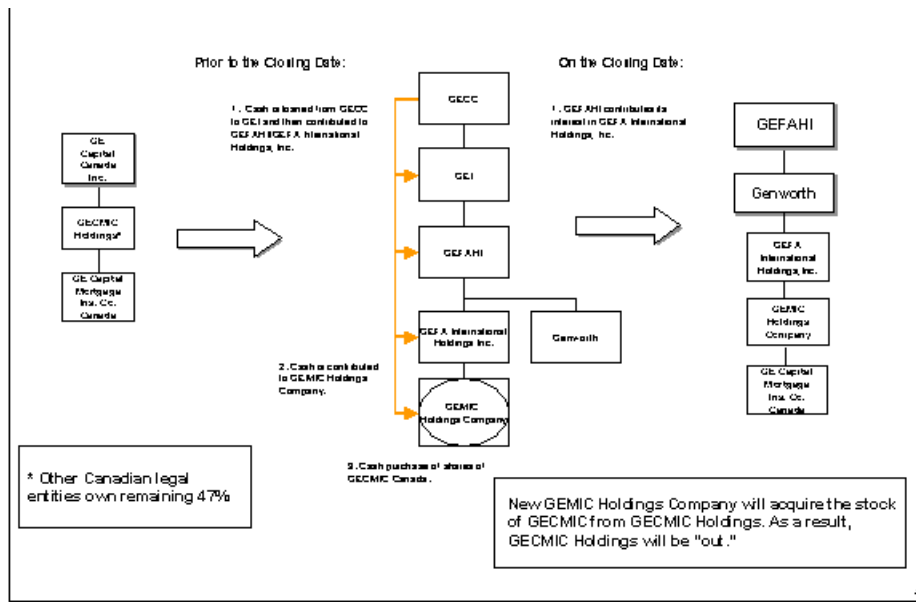

**Move Australian Mortgage Insurance Business into GEFA International Holdings, Inc. (Asset Transfer)**

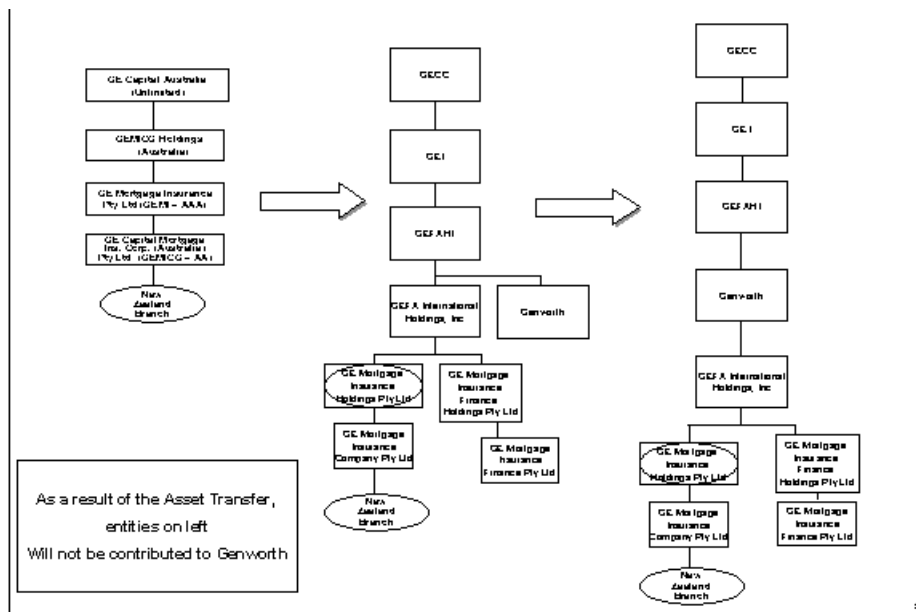

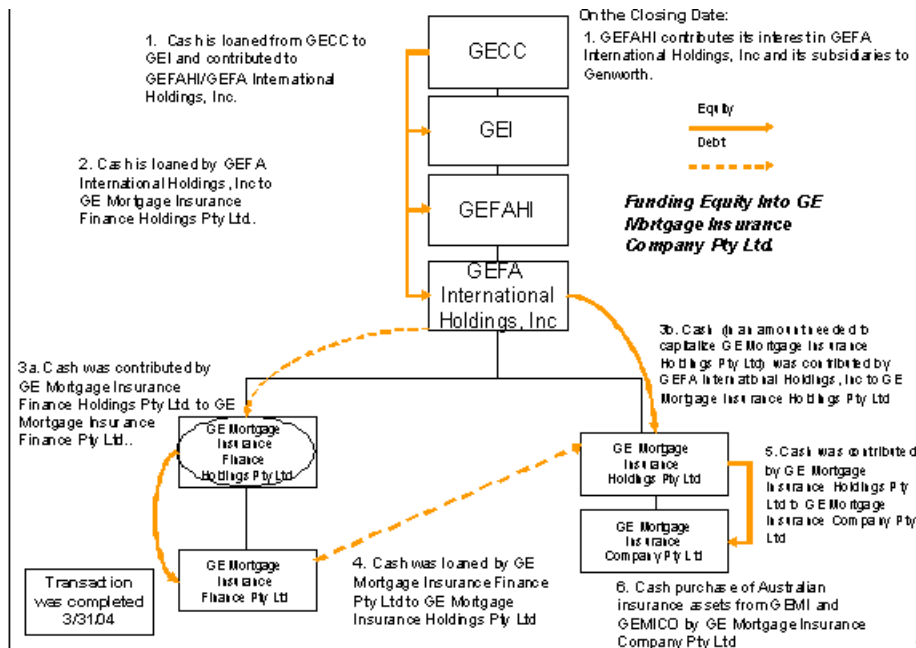

European Creditor Business Entity Moves

Funding pre Closing – Annex C

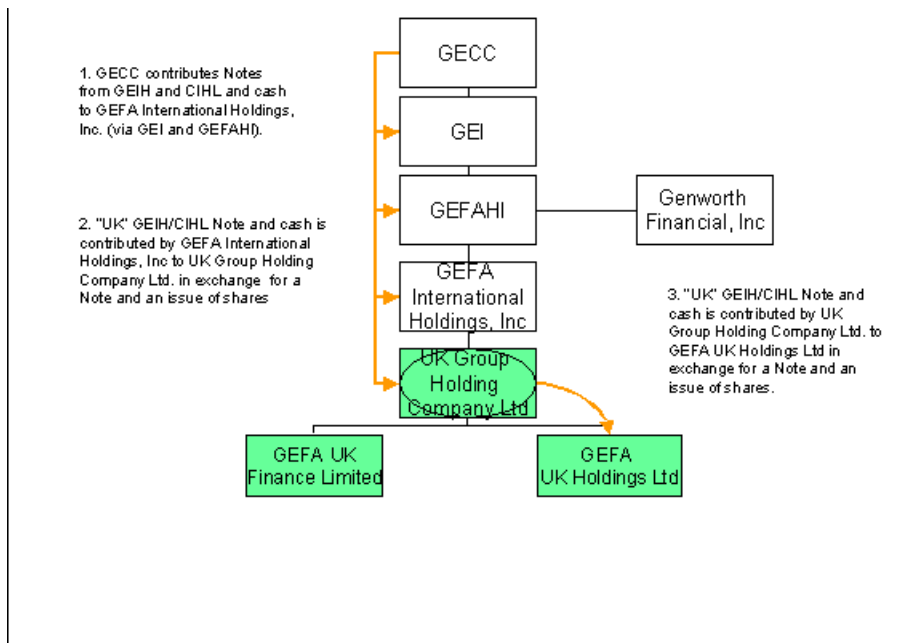

European Creditor Business Entity Moves

GEFAHI Acquisitions Pre Closing

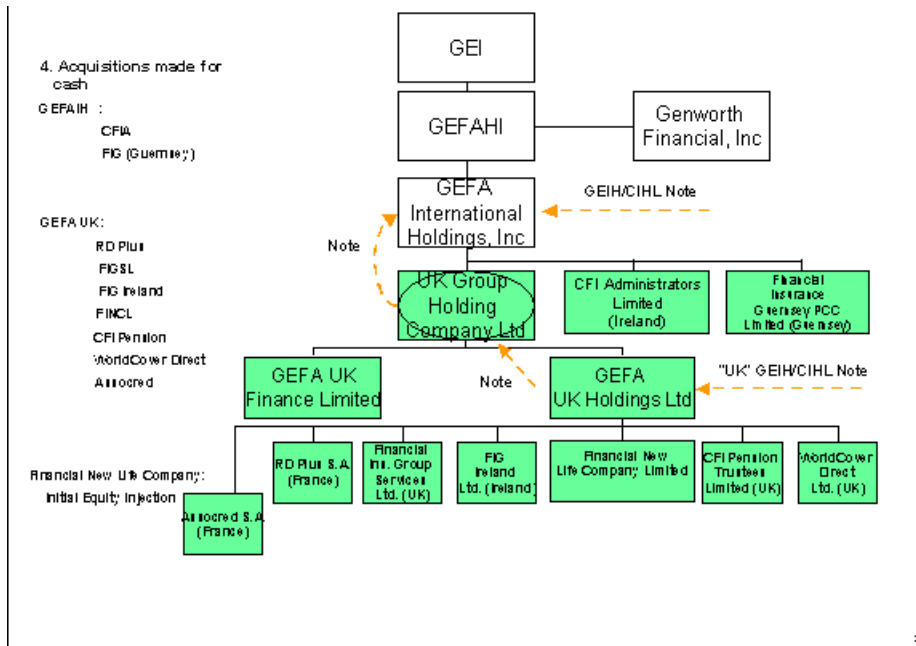

European Creditor Business Entity Moves

Genworth Acquisitions Post Closing

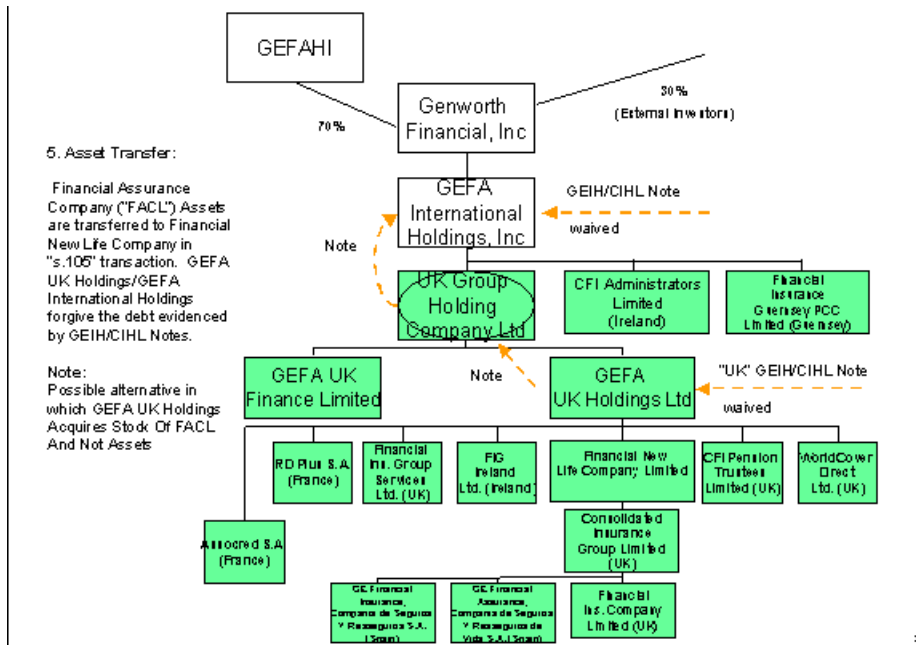





- all Assets of Financial Assurance Company Limited, including those within the definitions of Residual Assets, Residual Liabilities, Retained Insurances, Transferred Assets, Transferring Liabilities, Transferring Contracts, Transferring Insurances, Reinsurance Contracts (as such terms are defined in the UK Transfer Plan)
- all Assets of Vie Plus S.A. to the extent relating to its payment protection business, including the marketing, sale, and administration thereof
- all patents (including pending) domain names, trademarks, service marks and other intellectual property listed on Exhibit 1 hereto.
- [38,168][376,093] shares of Class B Common Stock in MERSCORP, Inc., a Delaware Corporation, held by GE Mortgage Services, LLC.

---

**Exhibit 1 to Schedule 2.2(a)(i)**
**MASTER AGREEMENT IP SCHEDULES**
**I. TRADEMARKS:**

The following trademarks and service marks, together with the goodwill of the business associated therewith, and all common law rights, registrations and applications for registration thereof, and all rights therein provided by international treaties or conventions, and all reissues, extensions and renewals of any of the foregoing:

**GE FINANCIAL ASSURANCE HOLDINGS, INC.**

TRADEMARK	COUNTRY/ STATE	REG. NO.	REG. DATE	APP. NO.	APP. DATE	STATUS	NOTES
QUICK APP PROTECTION 1	U.S.			76-347,564	12/12/2001	PENDING	
ONE AND DESIGN	U.S.			76-286,633	12/17/2001	ABANDONED	
GENIUS	U.S.	2,652,604	11/19/2002	76-248,870	05/01/2001	REGISTERED	
BIG CASE AND DESIGN	U.S.	2,512,617	11/17/2001	76-223,585	03/13/2001	REGISTERED	
BEYOND MONEY	U.S.			76-190,041	01/05/2001	PENDING	ITU Application
RETIREMENT INCOME ROADMAP	U.S.			76-160,353	11/3/2000	ABANDONED	
TOTAL ACCESS	U.S.			76-095,646	07/25/2000	PENDING	
FUND COMPANY SERVICES	U.S.			76-008,644	03/24/2000	ABANDONED	
AFFLUENT MARKET SERVICES GROUP	U.S.	2,447,241	04/24/2001	76-008,643	03/24/2000	REGISTERED	
SAVVY INVESTOR	U.S.			75-937,210	03/07/2000	ABANDONED	

---

TRADEMARK	COUNTRY/ STATE	REG. NO.	REG. DATE	APP. NO.	APP. DATE	STATUS	NOTES
CENTER FOR FINANCIAL LEARNING.COM AND DESIGN	U.S.			75-916,446	02/10/2000	ABANDONED	
REPFINDER	U.S.			75-878,548	12/22/1999	ABANDONED	
LIVING SECURITY	U.S.			75-866,505	12/07/1999	ABANDONED	



SIMPLE SECURITY	U.S.	2,643,414	10/29/2002	75-783,577	08/24/1999	REGISTERED	
THE GIFT TO REMEMBER	U.S.	2,316,514	02/08/2000	75-627,099	01/25/1999	REGISTERED	
CUSTOM CHOICE	U.S.	2,622,601	09/24/2002	75-598,255	12/02/1998	REGISTERED	
YOUR LIFETIME FINANCIAL PARTNER	U.S.	2,328,218	03/14/2000	75-529,708	07/31/1998	REGISTERED	
CUSTOM CHOICE	U.S.	2,138,213	02/24/1998	75-085,610	04/09/1996	REGISTERED	Assigned from First Colony Life Insurance 11/03/1998
LIVING SECURITY	U.S.	689,253	12/01/1959	72-070,128	03/23/1959	CANCELLED	Unclear if owned by Zurich American Insurance Co.- missing link in chain of title

**II. DOMAIN NAMES:**

Domain Name
AccountHolder.com
AddedOptions.com
Administradora-Habitat.com.mx
AdvancedAgeAlternative.com
AgentAccess.com
AmericanMayFlower.com
APP-Ease.com
arbejdsloshed.dk
arbejdsloshed.com
arbejdsloshed.dk
arbejdsloshedsforsikring.dk
argusmax.fr
betalingsbeskyttelse.com
betalingsforsikring.com
BGAInfo.com
bjg-ccm.com
BrokerageInfo.com
Buy-A-GIC.com
BuyGICS.com
Buy-GICS.com
CCentertain.com
CCMGI.com

Domain Name
CenterForFinancialLearning.com
Center-For-Learning.com
Centrust.com
Centurioncm.com
Certilink.biz
CertiLink.com
CertiLink.net
CertiLink.org
CertiLink2.com
cfi.co.uk
ChampionshipLife.com

ChampionshipLifeInsurancePlan.com  
CheckSixProductions.com  
CheckSixProductions.net  
claim-center.co.uk  
claim-centre.co.uk  
claimfortravel.co.uk  
ClaimForTravel.com  
Click-For-A-GIC.com  
ComboOnce.com  
ContingentLife.com  
Coordinated-Care.com  
debtprotect.co.uk  
DebtProtect.com

**Domain Name**

---

DistributorAccess.com  
DL10.com  
DL20.com  
DynamicLearningPlan.com  
DynamicLearningPlan.net  
eguidance.co.uk  
EPPIStaging.com  
eWorksite.com  
facl.co.uk  
facl.de  
FACL.dk  
facl.it  
facl.nl  
facl-invest.co.uk  
FederalColumn.com  
FGIACustomerService.com  
FGIACustomerService.net  
FGIAInquiries.com  
FGIAInquiries.com  
FGIAQuestions.com  
fiel.de  
FICL.dk  
fiel.it  
fiel.nl

**Domain Name**

---

figsl.co.uk  
FIGSL.com  
FinancialAssurance.com  
FinancialEarning.com  
FinancialEarning.net  
FinancialEarning.org  
FinancialLearning.biz  
FinancialLearning.com  
Financial-Learning.com  
FinancialLearning.info  
FinancialLearning.net  
Financial-Learning.net  
FinancialLearning.org  
Financial-Learning.org  
FinancialLearningCenter.com  
Financialphobia.com  
Financial-Phobia.com  
FinancialPhobias.com

FinancialPhobic.com

Financialphobics.com  
financialwisdom.co.uk  
FirstColonyLife.com  
Firstrak.com  
FundMinder.com

60

---

**Domain Name**

---

generahipotecaria.com  
generahipotecaria.com.mx  
GPX-One.com  
GuaranteedAssetProtection.com  
GuaranteedOne.com  
GuardingYourFuture.com  
HarvestLife.com  
HarvestProtector.com  
HarvestUniversalProtector.com  
HarvestWealthGuard.com  
HesseFinancial.com  
Hindsfg.com  
HomeBuyerPrivileges.com  
HomeBuyerPrivileges.info  
HomeBuyerPrivileges.net  
HomeBuyerPrivileges.org  
HomeNow.com  
HomeNow.info  
HomeNow.org  
HomePartnership.biz  
HomePartnership.com  
HomePartnership.net  
HomePartnership.org  
HomeVendorGuide.com

61

---

**Domain Name**

---

HouseSaleHelper.com  
HouseVendor.com  
IdealTerm.com  
JobCare.info  
JointLifeProtector.com  
laaneforsikring.com  
laaneforsikring.dk  
laneforsikring.com  
LendingPartnerLocator.com  
LendingPartnerLocator.info  
LendingPartnerLocator.net  
LendingPartnerLocator.org  
LifeAccidentSicknessUnemployment.com  
loanprotect.co.uk  
loanprotector.co.uk  
LTCDigitalOffice.biz  
LTCDigitalOffice.com  
LTCDigitalOffice.info  
LTCDigitalOffice.net  
LTCDigitalOffice.org  
managingmymoney.co.uk  
MICconnect.com  
Midinero.com  
Mortgage-OmniScore.com

---

**Domain Name**

---

Mortgage-Score.com  
my-claim-online.co.uk  
My-Claim-Online.com  
mycover.co.uk  
MyCover.com  
my-online-claim.co.uk  
My-Online-Claim.com  
MyRetirementIncomeRoadmap.com  
MySelectSite.com  
mytravelclaim.co.uk  
MyTravelClaim.com  
my-travel-claim.co.uk  
My-Travel-Claim.com  
NetOriginate.biz  
NetOriginate.com  
NetOriginate.net  
NetOriginate.org  
oekonomisikring.com  
oekonomisikring.dk  
økonomiforsikring.dk  
okonomisikring.com  
økonomisikring.com  
okonomisikring.dk  
økonomisikring.dk

---

**Domain Name**

---

Online-Claim.com  
online-claim.co.uk  
OwnersPack.com  
PaymentProtection.org  
paymentprotectioninsurance.co.uk  
PaymentProtectionInsurance.com  
personalloanprotection.co.uk  
PersonalLoanProtection.com  
PeterGreenberg.com  
PeterGreenburg.com  
PlusQueLargus.com  
plusquelargus.tm.fr  
ProductivityPrivileges.com  
redundancycover.co.uk  
RedundancyCover.com  
protectyourpet.co.uk  
rdplus.fr  
RetirementIncomeRoadmap.com  
SCACredit.com  
SCACredit.net  
sortme.co.uk  
SortMe.com  
SusesChoice.com  
SusesChoice.net

---

**Domain Name**

---

SusiesChoice.com  
SusiesChoice.net  
SuzeChoice.com

SuzeChoice.info  
SuzeChoice.net  
SuzesChoice.com  
SuzesChoice.net  
SuzieChoice.com  
SuzieChoice.net  
SuzysChoice.com  
SuzysChoice.net  
TerraFinacial.com  
travelcenter-claims.co.uk  
travelcentre-claims.co.uk  
TravelCentre-Claims.com  
travel-claim.co.uk  
Travel-Claim.com  
TravelDetective.org  
TravelDetectives.com  
uktravelclaim.co.uk  
UKTravelClaim.com  
VendersPack.com  
worldcover.co.uk  
WorldCover.com

65

---

Domain Name

worldcoverdirect.co.uk  
WorldCoverDirect.com  
WorldCoverOnline.com  
worldcoveronline.co.uk

66

---

**III. SOFTWARE, TOOLKITS AND OTHER MATERIALS**

A. All (i) copyrights, mask work rights, database rights and design rights, whether or not registered, published or unpublished, and registrations and applications for registration thereof, and all rights therein whether provided by international treaties or conventions or otherwise and (ii) trade secrets associated with the following:

1. MyGoals:  
Genworth Group's MyGoals H/R Software
2. Privacy/Opt-Out:  
Genworth Group's Consumer Privacy Management Software
3. Complaint Log System (CLS):  
Genworth Group's Complaint Log System Software
4. Death Claims System:  
Genworth Group's Death Claims Cross-Checking Software
5. EWD:  
Genworth Group's Enterprise-Wide Disbursement Software
6. SMART:  
Genworth Group's Sales Management and Report Tracking System Software
7. e-Learning:  
Genworth Group's developed e-Learning courseware Software
8. Change Control System Software (Europe):  
Genworth Group's web-based Change Control System Software
9. Compliance Management System (CMS):  
Genworth Group's Compliance Management System Software
10. Genworth Strategic Toolkits, including:  
P.I.E.  
HomeRun  
e-QuTOPS PMO Toolkit, including Project Place Software

11. Training:  
 “GEFA-U” Course Materials including but not limited to
- Foundations of Leadership
  - Interview & Selections
- Business Leadership Impact Symposium  
 Lean Transactions
12. Human Resources:  
 Genworth Group’s Program Materials, including
- LDP (Leadership Development Program)
  - ALDP (Actuarial Leadership Development Program)
13. Risk:  
 Genworth Group’s Risk Management Toolkit
14. Information Technology:  
 Genworth Group’s DMADOV Methodology
15. Legal/Compliance:  
 Outsourcing Toolkit including the Migration Toolkit
16. Operations:  
 Genworth Group’s Crisis Management Toolkit
17. GE Center for Financial Learning Materials, including the “Managing Your Credit” Module

B. All copyrights (whether or not registered, published or unpublished, and registrations and applications for registration thereof, and all rights therein whether provided by international treaties or conventions or otherwise) in works of authorship, content, text and materials in electronic and paper formats (including copyrights in Web pages or portions thereof, online content, and product and service descriptions and brochures) in existence on the Closing Date owned by (i) GEFAHI, (ii) Financial Assurance Company Limited, and (iii) Vie Plus S.A. to the extent relating to its payment protection business (including the marketing, sale, and administration thereof), other than such copyrights listed on Schedule 2.2(b)(i) as Excluded Assets.

#### IV. PATENTS

<u>GE Docket Number</u>	<u>H&amp;W File No.</u>
85FA-00100	52493.000118
	and
	52493.000153
85FA-00101	52493.000032
85FA-00103	52493.000126
85FA-00104	52493.000036
85FA-00105	52493.000037
85FA-00106	52493.000040
	and
	52493.000170
85FA-00107	52493.000041
	and
	52493.000169
85FA-00108	52493.000065
85FA-00109	52493.000058
	and
	52493.000175
85FA-00110	52493.000046
	and
	52493.000191

<u>GE Docket Number</u>	<u>H&amp;W File No.</u>
85FA-00111	52493.000056
85FA-00112	52493.000183

85FA-00113	52493.000060
85FA-00114	52493.000063
	and
	52493.000188
85FA-00115	52493.000061
85FA-00116	52493.000059
	and
	52493.000220
85FA-00117	52493.000057
85FA-00118	52493.000130
85FA-00119	52493.000062
85FA-00120	52493.000068
85FA-00121	52493.000054
	and
	52493.000244
85FA-00123	52493.000045
85FA-00124	52493.000048
	and
	52493.000217
85FA-00125	52493.000047
85FA-00126	52493.000053
85FA-00127	52493.000050
85FA-00128	52493.000067
85FA-00129	52493.000066
85FA-00130	52493.000075
	and
	52493.000116

<u>GE Docket Number</u>	<u>H&amp;W File No.</u>
85FA-00132	File # available
85FA-00134	52493.000124
	and
	52493.000235
85FA-00135	52493.000070
85FA-00136	52493.000072
85FA-00137	52493.000073
	and
	52493.000189
85FA-00138	52493.000076
	and
	52493.000197
85FA-00139	52493.000080
85FA-00140	52493.000084
85FA-00145	52493.000085
	and
	52493.000201
85FA-00146	52493.000086
85FA-00147	52493.000087
	and
	52493.000186
85FA-00148	52493.000091
	and
	52493.000222
85FA-00149	52493.000090
	and
	52493.000225

GE Docket Number	H&W File No.
85FA-00150	52493.000089
85FA-00151	52493.000093
	and
	52493.000212
85FA-00152	52493.000095
85FA-00153	52493.000096
85FA-00154	52493.000221
85FA-00155	52493.000099
	and
	52493.000266
85FA-00156	52493.000101
	52493.000196
85FA-00157	52493.000114
	and
	52493.000193
	and
	52493.000102
85FA-00158	52493.000100
85FA-00159	52493.000103
85FA-00160	52493.000104
	and
	52493.000215
85FA-00161	File # available
85FA-00162	52493.000105
	52493.000107
	and
85FA-00163	52493.000275

GE Docket Number	H&W File No.
85FA-00164	52493.000108
85FA-00165	52493.000109
85FA-00166	52493.000110
85FA-00167	52493.000111
85FA-00168	52493.000112
	and
	52493.000246
85FA-00169	File # available
85FA-00170	52493.000121
	and
	52493.000202
85FA-00171	52493.000123
	and
	52493.000338
85FA-00172	52493.000119
85FA-00173	52493.000129
	and
	52493.000243
85FA-00174	52493.000128
85FA-00175	52493.000127
	and
	52493.000257
85FA-00176	52493.000125
85FA-00177	52493.000139
	and
	52493.000224
85FA-00178	52493.000145
85FA-00179	52493.000135
85FA-00180	52493.000131



GE Docket Number	H&W File No.
85FA-00181	52493.000134
85FA-00182	52493.000136 and 52493.000242
85FA-00183	52493.000143
85FA-00184	52493.000138
85FA-00185	52493.000141
85FA-00186	52493.000142
85FA-00187	52493.000163 and 52493.000321
85FA-00188	File # available
85FA-00189	52493.000133 and 52493.000270
85FA-00190	52493.000152 and 52493.000256
85FA-00191	52493.000151 and 52493.000274
85FA-00192	52493.000155 and 52493.000255
85FA-00193	52493.000156 and 52493.000278 and 52493.000337

GE Docket Number	H&W File No.
85FA-00194	52493.000157 and 52493.000273
85FA-00195	52493.000164
85FA-00196	52493.000165 and 52493.000247
85FA-00197	52493.000166 and 52493.000265
85FA-00198	52493.000162
85FA-00199	52493.000233
85FA-00200	52493.000229
85FA-00201	52493.000185
85FA-00202	52493.000234
85FA-00203	52493.000237
85FA-00204	52493.000238
85FA-00205	52493.000239
85FA-00206	52493.000161
85FA-00207	52493.000168 and 52493.000282
85FA-00208	52493.000171 and 52493.000286

85FA-00209  
52493.000264  
and  
52493.000172  
and  
52493.000304  
and  
52493.000343

<u>GE Docket Number</u>	<u>H&amp;W File No.</u>
85FA-00210	File # available
85FA-00211	File # available
85FA-00212	52493.000176 and 52493.000299
85FA-00213	52493.000179
85FA-00214	52493.000187
85FA-00215	52493.000199
85FA-00216	52493.000208
85FA-00217	52493.000205
85FA-00218	52493.000204
85FA-00219	52493.000231
85FA-00220	52493.000230
85FA-00221	52493.000261
85FA-00222	52493.000251 and 52493.000328
85FA-00223	52493.000252
85FA-00224	52493.000253
85FA-00225	52493.000260
85FA-00226	52493.000262
85FA-00227	52493.000277
85FA-00228	52493.000281
85FA-00229	52493.000302
85FA-00230	52493.000301
85FA-00231	52493.000297
85FA-00232	52493.000296

<u>GE Docket Number</u>	<u>H&amp;W File No.</u>
85FA-00233	52493.000295
85FA-00234	52493.000303
85FA-00235	52493.000298
85FA-00236	52493.000300
85FA-00237	File # available
85FA-00238	52493.000328
85FA-00241	52493.000203 and 52493.000339
85FA-00243	File # available
85FA-00244 (US 85FA-00106)	52493.000170 (US .000040)
85FA-00245	52493.000308
85FA-00246	52493.000309
85FA-00247	52493.000311
85FA-00248	52493.000312
85FA-00249	52493.000160
85FA-00250 129271 RD 30958	52493.000310

85FA-00250	52493.000313
85FA-00252	52493.000258
85FA-00253	52493.000346
85FA-00254	52493.000344
Assigned to Genworth	52493.000349

**Capital Stock of GE Subsidiaries**

American Agriculturist Services, Inc.  
American Mayflower Life Insurance Company of New York  
Assigned Settlement, Inc.  
Assocred S.A. (2)  
Brookfield Life Assurance Company Limited  
California Benefits Dental Plan  
Capital Brokerage Corporation  
Centurion Capital Group Inc.  
Centurion Financial Advisers Inc.  
Centurion-Hesse Investment Management Corp.  
Centurion-Hinds Investment Management Corp.  
CFI Administrators Limited (2)  
CFI Pension Trustees Limited (2)  
Consolidated Insurance Group Limited (3)  
Dental Holdings, Inc.  
Ennington Properties Limited (2)  
Federal Home Life Insurance Company  
Fee For Service, Inc.  
FFRL of New Mexico, Inc.  
FFRL Re Corp.  
FIG Ireland Limited (2)  
Financial Insurance Company Limited (3)  
Financial Insurance Group Services Limited (2)  
Financial Insurance Guernsey PCC Limited (4)  
Financial New Life Company Limited (5)  
First Colony Life Insurance Company  
Forth Financial Resources Insurance Agency of Massachusetts, Inc.  
Forth Financial Resources of Alabama, Inc.  
Forth Financial Resources of Hawaii, Inc.  
Forth Financial Resources of Oklahoma Agency, Inc.(6)  
Forth Financial Resources of Texas, Inc.(7)  
GE Capital Life Assurance Company of New York  
GE Capital Mortgage Insurance Company (Canada) (8)  
GE Center for Financial Learning, L.L.C.  
GE Financial Assurance Mortgage Funding Corporation  
GE Financial Assurance, Compania de Seguros y Reaseguros de Vida S.A. (3)

- 
- (2) transferred to GEFAHI or one of its subsidiaries on April [ ], 2004
- (3) to be transferred to GEFAHI or one of its subsidiaries under the UK Transfer Plan or FACL Fallback Stock Transfer Agreement
- (4) transferred to GEFAHI or one of its subsidiaries on April [ ], 2004
- (5) transferred to GEFAHI or one of its subsidiaries on March 24, 2004
- (6) Stock of these corporations is owned by individuals affiliated with the Genworth Group.
- (7) Stock of these corporations is owned by individuals affiliated with the Genworth Group.
- (8) transferred to GEFAHI or one of its subsidiaries on [ ], 2004

GE Financial Insurance, Compania de Seguros y Reaseguros S.A. (3)  
GE Financial Trust Company  
GE Group Administrators, Inc.  
GE Group Life Assurance Company  
GE Group Retirement, Inc.  
GE Life and Annuity Assurance Company  
GEMIC Holdings Company  
GE Mortgage Contract Services, Inc.  
GE Mortgage Holdings, LLC  
GE Mortgage Insurance (Guernsey) Limited (9)  
GE Mortgage Insurance Co. Pty. Ltd.  
GE Mortgage Insurance Finance Holdings Pty Ltd.  
GE Mortgage Insurance Finance Pty Ltd.  
GE Mortgage Insurance Holdings Pty Ltd.  
GE Mortgage Insurance Limited (7)  
GE Mortgage Reinsurance Corporation of North Carolina  
GE Mortgage Services Limited  
GE Mortgage Solutions Limited  
GE Private Asset Management, Inc.  
GE Residential Mortgage Insurance Corporation of North Carolina  
GE Seguros del Centro, S.A. de C.V.  
GEFA International Holdings, Inc.  
GEFA Special Purpose Five, LLC  
GEFA Special Purpose Four, LLC  
GEFA Special Purpose One, LLC  
GEFA Special Purpose Six, LLC  
GEFA Special Purpose Three, LLC  
GEFA Special Purpose Two, LLC  
GEFA UK Finance Limited  
GEFA UK Holdings Limited  
General Electric Capital Assurance Company  
General Electric Home Equity Insurance Corporation of North Carolina  
General Electric Mortgage Insurance Corporation  
General Electric Mortgage Insurance Corporation of North Carolina  
Genworth Financial Asset Management, LLC  
GFCM LLC  
GNA Corporation  
GNA Distributors, Inc.  
HGI Annuity Service Corporation  
Hochman & Baker, Inc.  
Hochman & Baker Insurance Services, Inc.  
Hochman & Baker Investment Advisory Services, Inc.  
Hochman & Baker Securities, Inc.  
IFN Insurance Agency, Inc.  
Jamestown Life Insurance Company  
LTC, Incorporated  
Mayflower Assignment Corporation

---

(9) *transferred to GEFAHI or one of its subsidiaries on April 1, 2004*

Newco Properties, Inc.  
Private Residential Mortgage Insurance Corporation  
Professional Insurance Company  
RD Plus S.A.  
River Lake Insurance Company  
Security Funding Corporation  
Sponsored Captive Re, Inc.  
Terra Financial Planning Group, Ltd.  
Terra Securities Corporation

The Terra Financial Companies, Ltd.  
UK Group Holding Company Limited  
United Pacific Structured Settlement Company  
Verex Assurance, Inc.  
Viking Insurance Company, Ltd.  
WorldCover Direct Limited (10)

---

(10) transferred to GEFAHI or one of its subsidiaries on April [ ], 2004

80

---

**Schedule 2.2(a)(ii)(C)**

**Capital Stock GE Affiliates**

- 5,125 shares of Federal Home Life Insurance Company Common Stock
- 800 shares of GE Life and Annuity Assurance Company's Common Stock

81

---

**Schedule 2.2(b)(i)**

**Excluded Assets**

1. Any cash held by GEFAHI at the Closing in excess of \$135.0 million (which \$135.0 million will be transferred by GEFAHI to GNA at the Closing).
2. All Assets of Vie Plus S.A. to the extent not relating to its payment protection business, including, but not limited to the OPUS Life System
3. All Assets of Financial Insurance Group Services Limited ("FIGSL") which demonstrably and solely relate to a business or the support of a business of a member of the GEIH Group (as defined in the European Transition Services Agreement but excluding any European Creditor Business Entity) (the "GEIH Business") except for those assets which relate to the GEIH Business solely by virtue of FIGSL's obligations pursuant to the support of the GEIH Business pursuant to the European Transition Services Agreement.
4. Any financial reserves related to any interests in real properties being retained by, or transferred to, a member of the GE Group.
5. Any financial reserves established in connection with any contractual Liabilities being retained by, or transferred to, a member of the GE Group.
6. All capital stock of Centerprise Advisors, Inc., including all Series A Redeemable Preferred Stock, all Stapled Voting Preferred Stock and all Series A Warrants to purchase common stock.
7. All capital stock in the following companies:
  - AEC Signature Industries Limited
  - Champion General Agency, Inc.
  - Credit Card Sentinel, Inc.
  - GE Capital Insurance Agency, Inc. and its Subsidiaries
  - GE Dental & Vision
  - GE Administraco de Garantias e Participacoes Ltda.
  - GE Administraco de Garantias do Brasil Ltda.
  - GE Asset Management Co., Ltd.
  - GE Investment Distributors, Inc.
  - GE Motor Club of California, Inc.
  - GE Motor Club, Inc.
  - GE Retirement Services, Inc.
  - GEFA Subsidiary I, Inc.

- Genworth Financial, Inc.
- Heritage Casualty Insurance Company

- National Dental Service, Inc.
  - Ocoma Industries, Inc.
  - Scrip Plus
  - Signature Agency, Inc.
  - Signature Financial/Marketing, Inc.
  - Signature's Nationwide Auto Club of California, Inc.
  - Signature's Nationwide Auto Club, Inc.
  - Union Fidelity Life Insurance Company
  - Trooper Communications Corporation and Trooper Investment, Inc. including the partnership interest of Colonial Valley Data, Inc.
8. All members' interests in GEFA Real Estate Holdings, LLC (together with subsidiaries: Forrer FA LLC, Franklin FA LLC, Glendale FA LLC, Park Center FA LLC, PewaukeeFA LLC, Riverside Distribution LLC and Eastgate Distribution Center LLC)
  9. Any asset of GEFAHI related solely to the business of the Investment Management Marketing & Client Service business segment, including, without limitation, furniture, equipment, computer hardware, prepaid NASD fees and any other prepaid expenses, intercompany receivables and capitalized 401(k) client implementation costs.
  10. All interests held by GNA in Apollo Real Estate Investment Fund IV, G3 Strategic Investments Fund and Drawbridge Special Opportunities Fund
  11. The AMS software listed on Exhibit 1 hereto.
  12. Shares (and any proceeds from the disposition thereof prior to the Closing Date) in any of the GE mutual funds, including shares of GE Funds Premier Value Equity Fund (Classes A, B, C and Y) held by GEFAHI.
  13. All reserves and other financial statement entries or adjustments described in paragraph 2 on Schedule 2.3(b)(iv) in connection with the transactions contemplated by that certain Stock Purchase Agreement among Brookfield Life Assurance Company, Ltd., General Electric Capital Corporation, GE Capital Asia Investments, GEFAHI and American International Reinsurance Company, Ltd. dated as of June 26, 2003, as amended as of August 29, 2003
  14. Proceeds from the liquidation of GE Edison Systems.
  15. All patents (including pending) domain names, trademarks, service marks and other intellectual property listed on Exhibit 2 hereto.
  16. The tax benefits recognized by GEFAHI as a result of the Separation and the 338(h)(10) elections.

17. The following Assets of GEFAHI or GNA to be retained by GEFAHI or other members of the GE Group (the general ledger account numbers following the description of the Assets are the account numbers in which the Assets were reflected as of March 31, 2004 and are included herein for illustrative purposes only):
  - Intercompany receivables from members of the GE Group, including the following receivables from members of the GE Group: [182122 (Due from Heritage Insurance Group, Inc.), 182124 (Due from Westwood Warranty Corp.), 182214 (Due from Heritage Insurance Company), 182215 (Due from UFLIC), 182218 (Due from Heritage Indemnity), 182220 (Due from Heritage Consulting Insurance Company), 182222 (Due from WWIC), 182416(Due from GEID), 182435 (Due from Ocoma Industries.), 182442 (Due from GE Motor Club, Inc.), 182443 (Due from GE Dental & Vision), 182444 (Due from National Dental Services), 182456 (Due from Signature Nationwide Auto) 182457 (Due from Signature Agency, Inc.), 182621 (Due from Business Share), 182625 (Due from GE Capital Administrative Services), 182626 (Due from GE Capital Warranty Corp.), 182627 (Due from Heritage Mechanical Breakdown), 182628 (Due from GECCES), 182629 (Due from GE Capital Management Corp.), 182431( Due from Monogram General Agency of FL), 182224 (Due from Westwood Life Insurance Co.), 182434 (Due from Signature Financial/Marketing), 182449 (Due from Credit Card Sentinel), 182163 (Due from Cap Corp COTUSD), 182166 (Due from GEFAHI COTUSD), 182105 (Due from GELCO)
  - Series A Preferred stock of GE Asset Management, Inc. [111151]
  - Partnership Interest of Putnam Lovell Equity Partners LP [140751, 140752, 140753]
  - Shares of GE Funds Premier Value Equity Fund [111251, 111252, 111254, 111256, 111280, 111281, 111282, 111283, 111276]
  - Lexington Precision Fixed Income Securities [110351, 110352, 110355, 110383].
  - Mikron Holdings AG Fixed Income Securities [110451]

- Mikron Holdings AG Equity securities [111000, 111051, 111052, 111054, 111056, 111080, 111081, 111083, 111076].
- Preferred Stock Investments in Hawaiian Electric and Maui Electric Co. [111100, 111151, 111180, 111181, 111183]

## Exhibit 1 to Schedule 2.2(b)(i)

AMS Software

System No	Asset Account Type	Site	Legal Entity	Description	PO Number
31	171951-SW	10	101	Citrix winframe License	CSIG-100
33	171951-SW	10	101	Virusscan Xplat 3.0 Cdrom	I1027
34	171951-SW	10	101	Intranw 4.11 Cdrom	I1027
221	171951-SW	10	101	Stars System	
245	171951-SW	10	101	Stars System	
276	171951-SW	10	101	Stars System	
344	171951-SW	10	101	Stars System-Phase 2	
441	171951-SW	10	101	Siebel-AMS-PSG (WIM)	
442	171951-SW	10	101	Siebel-AMS-ISG/ASG, Mutual Funds (WIM)	
558	171951-SW	10	101	geassetmanagement.com	
559	171951-SW	10	101	geassetmanagement.com	
574	171951-SW	10	101	geassetmanagement.com	
583	171951-SW	10	101	geassetmanagement.com	
606	171951-SW	10	101	geassetmanagement.com	
607	171951-SW	10	101	geassetmanagement.com	
612	171951-SW	10	101	geassetmanagement.com	2001414128
681	171951-SW	10	101	Client Reporting Modification	2002402204
682	171951-SW	10	101	geassetmanagement.com - Retirement Plans Project	2002402201
683	171951-SW	10	101	geassetmanagement.com	2002402201
684	171951-SW	10	101	geassetmanagement.com	2002404477
687	171951-SW	10	101	geassetmanagement.com - Retirement Plans Project	
688	171951-SW	10	101	geassetmanagement.com	
720	171951-SW	10	101	Client Reporting Modification	2002404477

System No	Asset Account Type	Site	Legal Entity	Description	PO Number
725	171951-SW	10	101	Client Reporting Modification	2002406200
726	171951-SW	10	101	Client Reporting Modification	2002404477
727	171951-SW	10	101	Client Reporting Modification	2002406200
733	171951-SW	10	101	geassetmanagement.com - Retirement Plans Project	
735	171951-SW	10	101	geassetmanagement.com - Web Development Modification	
736	171951-SW	10	101	geassetmanagement.com - Web Development Modification	
758	171951-SW	10	101	Client Reporting Modification	2002404477
771	171951-SW	10	101	Client Reporting Modification	2002404498
772	171951-SW	10	101	Client Reporting Modification	2002404498
774	171951-SW	10	101	Client Reporting Modification	2002503722
775	171951-SW	10	101	Client Reporting Modification	200240477
779	171951-SW	10	101	Client Reporting Modification	2002404498
780	171951-SW	10	101	geassetmanagement.com - Retirement Plans Project	52878IN
783	171951-SW	10	101	geassetmanagement.com	52878IN
798	171952-SW	10	101	geassetmanagement.com - Retirement Plans Project	2002408147
803	171952-SW	10	101	geassetmanagement.com	2003000450
804	171952-SW	10	101	geassetmanagement.com	2002408147
805	171952-SW	10	101	Client Reporting Modification	2002404498
806	171952-SW	10	101	Client Reporting Modification	2003000400
807	171952-SW	10	101	Client Reporting Modification	2002503722
810	171952-SW	10	101	geassetmanagement.com	200312571
811	171952-SW	10	101	Client Reporting Modification	2003000400
812	171952-SW	10	101	geassetmanagement.com - Retirement Plans Project	2002408147
813	171952-SW	10	101	Client Reporting Modification	2003000400

System No	Asset Account Type	Site	Legal Entity	Description	PO Number
815	171952-SW	10	101	geassetmanagement.com	2003000450
816	171952-SW	10	101	geassetmanagement.com - Retirement Plans Project	2002408147
818	171952-SW	10	101	geassetmanagement.com	2002408147
819	171952-SW	10	101	Client Reporting Modification	2003000400
824	171952-SW	10	101	geassetmanagement.com	2003000450
828	171952-SW	10	101	Client Reporting Modification	2003000400
829	171952-SW	10	101	geassetmanagement.com	
868	171952-SW	10	101	Client Reporting Modification	2003004153
869	171952-SW	10	101	geassetmanagement.com - Retirement Plans Project	2003001923
870	171952-SW	10	101	geassetmanagement.com	2003001923
871	171952-SW	10	101	Client Reporting Modification	2003004153
872	171952-SW	10	101	geassetmanagement.com	2002401526
873	171952-SW	10	101	geassetmanagement.com	2003001923
877	171952-SW	10	101	Client Reporting Modification	2003004153
879	171952-SW	10	101	geassetmanagement.com	
880	171952-SW	10	101	geassetmanagement.com - Retirement Plans Project	2002408147
881	171952-SW	10	101	geassetmanagement.com	
883	171952-SW	10	101	geassetmanagement.com	2003000450
884	171952-SW	10	101	Client Reporting Modification	2003004153
886	171952-SW	10	101	geassetmanagement.com	2003000450
887	171952-SW	10	101	Client Reporting Modification	2003004153
888	171952-SW	10	101	STACI-CRM	2003005545
889	171952-SW	10	101	STACI-CRM	2003005666

**Exhibit 2 to Schedule 2.2(b)(i)**

**EXCLUDED INTELLECTUAL PROPERTY ASSETS**

I. All trademarks, service marks, trade names, service names, taglines, slogans, industrial designs, brand names, brand marks, trade dress rights, Internet domain names, identifying symbols, logos, emblems, signs or insignia, meta tags, Website search terms and key words containing “GE” or “General Electric” or “GEFA” either alone or in combination with other letters, symbols, words or phrases, including without limitation:

(i) The following domain name registered to GE SEGUROS: GESEGUROS.COM;

(ii) The following domain names registered to GE CAPITAL MORTGAGE INSURANCE CO. (CANADA): GEMORTGAGEINSURANCE.COM, GEMORTGAGE.COM, GE-MI.COM; and

(iii)

- ge-advisors.co.uk
- geca-emprunteur.fr
- geca.fr
- gecapital-assurances.fr
- gecapitalassurances.tm.fr
- gecas.co.uk
- ge-direct.co.uk
- geequityrelease.co.uk
- gefa.co.uk
- gefacl.co.uk
- ge-facl.co.uk
- gefi.ch
- gefi.co.uk
- gefi.es
- gefi.ie



gefi.nl  
gefi.no  
gefi.pt  
gefideutschland.de  
gefi-deutschland.de  
gefieurope.co.uk

gefi-ireland.ie  
gefiitalia.it  
gefinancialassurance.co.uk  
gefinancialeurope.co.uk  
gefinancialinsurance.ch  
gefinancialinsurance.co.uk  
gefinancialinsurance.de  
gefinancialinsurance.nl  
gefinederland.nl  
ge-i.co.uk  
geifa.co.uk  
ge-ifa.co.uk  
geih.co.uk  
ge-ih.co.uk  
geinsurance.co.uk  
geinsuranceholdings.co.uk  
geinsuranceservices.co.uk  
ge-is.co.uk  
gelife.co.uk  
ge-life.co.uk  
gelifeinvestment.co.uk  
generalelectricinsurance holdings.co.uk  
gepensions.co.uk  
ge-travel-insurance.co.uk  
ge-travelinsurance-services.co.uk  
gevakuutus.fi

II. For the avoidance of doubt, the foregoing shall not preclude Genworth and its Affiliates from using, owning and/or registering trademarks, service marks, trade names, service names, taglines, slogans, industrial designs, brand names, brand marks, trade dress rights, Internet domain names, identifying symbols, logos, emblems, signs or insignia, meta tags, Website search terms and key words from which “GE”, “General Electric” and “GEFA” have been removed and/or replaced with “Genworth” or words other than “GE”, “General Electric” or “GEFA”, provided that Genworth and its affiliates do not highlight, isolate, or emphasize the letters “GE” alone in the “Genworth” name or mark or derivatives thereof.

## Schedule 2.2(b)(ii)

### Excluded Contracts

1. Those contracts and arrangements listed in Schedule 1.1(b).
2. All contracts of Vie Plus S.A. to the extent not relating to its payment protection business, including the marketing, sale, and administration thereof.
3. All contracts of Financial Insurance Group Services Limited (“**FIGSL**”) which demonstrably and solely relate to a business or the support of a business of a member of the GEIH Group (as defined in the European Transition Services Agreement, but excluding any European Creditor Business Entity (the “**GEIH Business**”), except for those contracts which relate to the GEIH Business solely by virtue of FIGSL’s obligations pursuant to the support of the GEIH Business pursuant to the European Transition Services Agreement, including but not limited to the contracts set out below:

- Agreement between Avenance (Catering and Allied Services) and FIGSL (undated)
  - Agreement between Bull Information Systems and FIGSL (undated)
  - Maintenance Agreement between Kodak and FIGSL (undated)
  - Agreement between Easylink Services UK Limited and FIGSL (undated)
  - Agreement between The WM Company and FIGSL (undated)
  - Agreement between Capital Economics and FIGSL (undated)
  - Agreement between Thomson and FIGSL (undated)
  - Agreement between Standard & Poors and FIGSL (undated)
  - Agreement between Europrospectus.com and FIGSL (undated)
4. All real property agreements that relate to the GEIH Business including but not limited to:
- Lease of Vantage West, Great West Road Brentford dated 1 May 1995 between (1) Wimgrove Property Trading Limited (2) Financial Insurance Group Services Limited (3) Diplema 155 Limited and ancillary documents.
  - Lease of Oliver House, 19/23 Windmill Hill Enfield dated 23 March 1990 and registered in the name of Financial Insurance Group Services Limited under title number EGL267940.

- Lease of Wenlock House, Eaton Road Enfield dated 9 May 1975 and registered in the name of Financial Insurance Group Services Limited under title number NGL261810.
- Lease of Radcliffe House, Keynes House and Pease House, Priory Park, Hitchin dated 8 April 2002 between (1) GE Pensions Limited (2) Financial Insurance Group Services Limited (3) GE Insurance Holdings Limited and registered under title number HD408267.
- Lease of 25 Car Parking Spaces at Priory Park Hitchin dated 8 April 2002 between (1) GE Pensions Limited (2) Financial Insurance Group Services Limited (3) GE Insurance Holdings Limited.
- Underlease of 88 Car Parking Spaces in the Woodland Car Park at Hitchin Conference and Banqueting Centre Hitchin dated 8 April 2002 between (1) GE Pensions Limited (2) Financial Insurance Group Services Limited.
- Underlease of The Remote Computer Room at Priory Park Hitchin dated [ ] 2002 between (1) The Chartridge Conference Company Limited (2) National Mutual Life Assurance Society and assigned to Financial Insurance Group Services Limited by GE Pensions Limited by a deed dated 8 April 2002.
- Lease of Penne House, Sheen Road Richmond dated 29 September 1988 and registered in the name of Financial Insurance Group Services Limited under title number SGL 520430.
- Lease of Unit 6 Mowlem Trading Estate, Leaside Road Tottenham London N17 dated 20 June 1988 between (1) Currys Group PLC (2) Financial Insurance Group Services Limited.

- Lease of Office Suite 5.8 The Beacon, Glasgow dated 18 November 2003 between (1) Abbey Business Centres Limited and (2) Financial Insurance Group Services Limited
5. Real property agreements for space where Genworth is no longer located:
- Lease dated April 6, 2000 between AMG Realty Partners, LP and General Electric Capital Assurance Company for space located at 1600 Los Gamos Drive Suite 180, San Rafael, CA, USA.
  - Lease dated January 1, 1992, as amended September 1, 1992, between Broadway Madison Associates and GNA Corporation for space located at 115 Broadway, New York, NY, USA.
6. Real property agreements that relate to the Institutional AMF Business including but not limited to:
- Sublease dated April 10, 2003 between General Electric Capital Corporation and GNA Corporation for space located at 100 California Street, Suite 100, San Francisco, CA, USA.

- Sublease dated March 24, 2003, as amended August 6, 2003, between GE Real Estate and GNA Corporation for space located at 1000 Windward Concourse, Alpharetta, GA, USA.
  - Undocumented agreement between GE - CF and GNA Corporation for space located at 500 West Monroe Street, Chicago, IL, USA.
  - Sublease dated December 6, 2001 between GE Medical Protective and GNA Corporation for space located at 5814 Reed Road, Fort Wayne, IN, USA.
  - Sublease dated August 7, 2003 between GE Real Estate and GNA Corporation for space located at 125 Summer Street, Boston, MA, USA.
7. Lease commencing 15th July, 1999 between the Landlord, Three X Communications Limited (as tenant) and Financial Insurance Group Services Limited (as surety).
8. Agreement between Financial Insurance Group Services Limited, Namulas Pension Trustees Limited and GE Pensions Limited dated 5th April 2002.
9. The agreements listed on Annex A (Ops & Sourcing) and Annex B (IT Documents).
10. The agreements listed on Annex C (GEFI Europe)

**Section A (Complete Transfer):**

No.	Contract Name	Agreement Date	Vendor	GE Party
1.	SOW, Fort Washington, PA Site Services— Genworth retains Master Management Services Agreement	9/1/2003	Pitney Bowes Inc.	GNAC
2.	Master Services Agreement Adoption Agreement III - Heritage Life Pre-Need - Genworth retains Master Services Agreement	Undated	Transaction Applications Group, Inc.	GNAC
3.	Linking Agreement	7/30/2001	eHealth Insurance Services, Inc	GE Capital Insurance Agency, Inc.
4.	Linking Agreement	10/8/2001	Individual Commercial Administrators	GE Capital Insurance Agency, Inc.
5.	SOW, Stanford Receptionist Services-Genworth retains Master Services Agreement	11/21/2003	Pitney Bowes	GNA
6.	GE Financial Assurance eHealthInsurance Agreement	12/1/2000	eHealthInsurance Services, Inc	GE Capital Insurance Agency, Inc

**Section B: GE owns Master, split**

The GE Group shall retain the following master agreements and shall retain any licenses, leases, addendums and similar arrangements thereunder pursuant to which any software, hardware, equipment or services are acquired that do not relate primarily to the Genworth Business. All licenses, leases, addendums and similar arrangements under any of the following master agreements in the name of any member of the GE Group that relate primarily to the Genworth Business shall be assigned to a member of the Genworth Group.

No.	Contract Name	Agreement Date	Vendor	GE Party
16.	Variation Agreement	/ /2003	Experian Ltd (formerly CCN Group Ltd)	GE Capital Corp
17.	Master Professional Printing Services Agreement	3/5/2003	FCL Graphics Incorporated	GEFAHI
18.	License Agreement Amendment	8/31/2000	FinanCenter, Inc. ("FinanCenter")	GEMICO

No.	Contract Name	Agreement Date	Vendor	GE Party
19.	Quote and Linking Agreement	9/9/1999	FinanCenter, Inc.	GEFAHI (Substituted as contracting entity for GE Capital) & GE Center for Financial Learning
20.	Master Services Agreement	7/3/2003	Kelly Services, Inc.	General Electric Capital Corporation
21.	Noosh, Inc. Print Buyer Agreement	12/31/2003	Noosh, Inc.	GNA Corporation
22.	Master Professional Printing Services Agreement	8/30/2002	Service Envelope Corporation	GEFAHI
23.	Agreement for Purchase of Products	4/16/2001	Xerox Corporation	General Electric Company
24.	A. Agreement between AT&T and various subsidiaries of GE Financial Assurance	1. 4/1/2001	AT&T Corp.	UFLIC, CPFIC, SA, CCS, GCDP & GEFAHI
25.	Master Services Agreement (including Exhibit A; General Agent/Brokerage General Agent Agreement)	2. 5/30/2000	Insurance Answer Center, Inc.	GEFAHI

**Section C: Genworth owns Master, split**

The following master agreements and any licenses, leases, addendums and similar arrangements thereunder pursuant to which any software, hardware, equipment or services are acquired that relate primarily to the Genworth Business shall be assigned to a member of the Genworth Group. All licenses, leases, addendums and similar arrangements under any of the following master agreements in the name of GEFAHI or any member of the Genworth Group that do not relate primarily to the Genworth Business shall be retained by or assigned to GEFAHI.

No.	Contract Name	Agreement Date	Vendor	GE Party
7.	Multipurpose Confidentiality Agreement	4/14/2003	The Wackenhut Corporation	GEFAHI
8.	Services Contract (with addenda for various locations; 5 .pdf files)	12/12/2001	The Wackenhut Corporation	GEFAHI
9.	On-Line Service Subscription Agreement	3. 12/27/2001	OneSource Information Services, Inc.	GEFAHI

94

**Annex B**

**Schedule 2.2(b)(ii)  
Master Agreement Schedules  
(IT documents)**

**Section A (Complete Transfer):**

Contract Name	Date	Vendor	GE Party
		Brio Software	GE Capital Mortgage = GEMH

**Section B: GE owns Master, split**

The GE Group shall retain the following master agreements and shall retain any licenses, leases, addendums and similar arrangements thereunder pursuant to which any software, hardware, equipment or services are acquired that do not relate primarily to the Genworth Business. All licenses, leases, addendums and similar arrangements under any of the following master agreements in the name of any member of the GE Group that relate primarily to the Genworth Business shall be assigned to a member of the Genworth Group.

Contract Name	Date	Vendor	GE Party
Information Technology Services Agreement and Predecessor Agreements	1/1/2004	TCS	General Electric International, Inc. ("GEII")
Information Technology Services Agreement and Predecessor Agreements		Patni Computer Systems LTD	General Electric International, Inc. ("GEII")
Master Lease/Rental Agreement	2/10/1995	Hewlett-Packard Company = Lessor	General Electric Company = Lessee
Information Technology Services Agreement and Predecessor Agreements		Satyam Computer Services	General Electric International, Inc. ("GEII")
Master Lease Agreement	Undated	Sun Microsystems Finance = Lessor	General Electric Company = Lessee
Software License Agreement	6/25/2001	Sun Microsystems, Inc. ("Sun")	General Electric Company = Licensee
Global Master Purchase/Service Agreement	7/1/2003	Avaya World Services, Inc. = Avaya	General Electric Company = Customer
Lease Agreement	2/28/1988	AT&T Credit Corp.	General Electric Co.
International Lease and Finance Agreement	10/19/1999	IBM Credit Corporation	General Electric Company
Master License Agreement	9/20/1999	Lotus Development Corporation	General Electric Company
Master Managed Network Solutions Agreement	Undated (although amendments indicate a date of 11/5/1999)	AT&T Solutions ("AT&T")	General Electric Company ("Customer")
Master Wide Area Networking Services Agreement	Undated	AT&T Corp. ("AT&T")	General Electric Company ("Company")

95

Contract Name	Date	Vendor	GE Party
---------------	------	--------	----------

AT&T Wireless Services National Accounts Agreement	7/24/1998	AT&T Wireless Services National Accounts, Inc., as agent for Carriers (“AWS”). “Carrier” means companies who operate commercial mobile radio telecommunications systems who are either under common control with AWS or have agreed to participate in AWS’ National Accounts Program, each as to a licensed area. (Recitals)	General Electric Company (“Customer”)
a. National Cellular Agreement b. and c. Application for Service	a. 1/24/2000 b. and c. Undated	a. Celco Partnership d/b/a Bell Atlantic Mobile (“BAM”) b. and c. Verizon	General Electric Company
Purchase, License and Service Agreement	3/23/1995	FileNet Corporation (“FileNet”)	General Electric Capital Corporation
Master Software License and Installation Agreement	3/21/1997	Pegasystems Inc. (“Pega”)	GE Capital Corporation
Recovery Services Agreement and all schedules	7/1/1997	SunGard Recovery Services, Inc.	General Electric Company
Master License Agreement No. 131362 For Distributed Systems Software	3/30/2001	Compuware Corporation (“Compuware”)	General Electric Company (“GE”)
Software License and Services Agreement	Undated	Siebel Systems, Inc. (“Siebel”)	GE Company
Software License and Services Agreement	Undated	Siebel Systems, Inc. (“Siebel”)	GE Capital Services, Inc. = Customer
Master Wide Area Networking Agreement	Undated	Qwest Communications Corporation (“Qwest”)note: name is now Visinet	General Electric Corporation (“GE”)
Sprint PCS Premier Account Term Service Agreement (Version 11.99)	1/17/2000	Sprint Spectrum L.P. d/b/a Sprint PCS	General Electric Company (“GE Co.”)
Master Wide Area Networking Services Agreement	10/1/2002	Sprint Communications Company, L.P. (“Sprint”)	General Electric Corporation
VPNterprise Communications Services Agreement	5/1/2003	Fiberlink Communications Corporation	General Electric Corporation
Master Services Agreement (without limitation, Genworth receives the Cisco Email Messenger)		Cisco Systems, Inc. (“Cisco”)	General Electric Company
Basic Ordering Agreement	1/30/1992	Cisco Systems, Inc. (“Cisco”)	General Electric Co.
License Agreement for Open System Products	12/31/1998	BMC Software Distribution, Inc. (“BMC”)	General Electric Company
General Electric License to Use Informatica Software	No date provided	Informatica Corporation (“Informatica”)	General Electric Corporation
Perpetual License Agreement for Computer Software Products	3/27/1985	Computer Network Corporation (“CNC”)	General Electric Credit Corporation [now General Electric Capital Corporation]
Settlement and Release Agreement	12/28/1998	International Business Machines Corporation (“IBM”) , Group 1 Software, Inc.	General Electric Capital Corporation
First Amended and Restated Enterprise License Agreement	7/1/2001	Computer Associates International, Inc.	General Electric Company

Contract Name	Date	Vendor	GE Party
Trillium Software System License and Professional Services Agreement	7/19/1999	Harte Hanks Data Technologies	GE Capital Corp
Software License Agreement	6/19/2000	Business Objects Americas	GE Capital Services Inc
Software License and Services Agreement	8/1/1998	AppWorx Corporation	General Electric Corp
GE-EMC Master Global Procurement Agreement	11/16/2001	EMC Corporation	General Electric Company
Master Wide Area Networking Services Agreement	6/4/2002	Broadwing Communications Services, Inc.	General Electric Company
Master Contract Service Arrangement Agreement	9/19/2000	BellSouth Telecommunications, Inc.	General Electric Company

Software License and Services Agreement	5/31/2002	Oracle Corporation	a. General Electric Company
Microsoft/GE License Agreement	2/1/2000	MSLI, GP	General Electric Company
Enterprise License Agreement Renewal Addendum	7/27/2002	Citrix Systems Inc.	General Electric Company
Enterprise License Agreement	11/10/2000	Courion Corporation (“Courion”)	General Electric Company
Software License Agreement	Undated (The license agreement is effective upon acceptance.)	Attachmate	GEFAHI
GE-Internet Security Systems, Inc. Enterprise Software License Subscription	12/28/1998	Internet Security Systems, Inc. (“ISS”)	General Electric Company (“GE”)
Software License Agreement between Netegrity, Inc. and General Electric Company	8/2/1999	Netegrity, Inc. (“Netegrity”)	General Electric Company (“GE”)
Information Technology Services Agreement and Predecessor Agreements		B. Birlasoft	General Electric International
Lasercycle Supply Agreement	7/28/2000	LASERCYCLE INKCYCLE	GE Capital Corporation GEMICO
Appropriation Request	7/16/2003	GXS	GE Capital Mortgage = GEMH
Advanced Server and Services Agreement	Red Hat, Inc.	General Electric Global Computer Operations	
Custom International Customer Support Program Agreement	2/1/1997	SunService Division, Sun Microsystems, Inc.	General Electric Company
Technology Services Agreement		C. International Business Machines Corporation (“IBM”)	GE Capital Corp.
Master Agreement for Call Center Quality Monitoring Systems	8/18/1999	Teknekron Infoswitch Corp	GE
U.S. Corporate End User License Agreement	1/31/2003	Network Associates, Inc.	General Electric Company
Software License Agreement	12/26/2001	GE Information Services, Inc.	General Electric Company
Addendum to Software License Agreement	12/26/2001	Global eXchange Services Canada, Inc.	GECMICAN
Electronic Commerce Services Agreement	6/28/2002	Global eXchange Services Canada, Inc.	General Electric Company
Canon Copier Agreement	5/11/2001	Canon U.S.A., Inc.	General Electric Corporation

Contract Name	Date	Vendor	GE Party
GE/Ricoh Corporation National Account Agreement and Amendment Number One to National Agreement by and between Ricoh Corporation and GE Company	1/1/2001	Ricoh Corporation	GE Company Corporate Initiatives Group
GE-Compaq Master Purchase and Services Agreement	5/21/2002	Compaq Computer Corporation	General Electric Company
Master License Agreement	11/00/1999	Broadvision Inc	General Electric Company
Master Agreement for Data Imaging Services		D. Anacomp, Inc.	GE Capital
Network Services Agreement - Yield Book	1/16/1995	Analytics Technology Corporation (“ATC”)	GEAM
Software Licensing Agreement - Yield Book	1/16/1995	Salomon Brothers Inc (“Salomon”)	GEAM
Standard & Poor’s Master Subscription Agreement, S&P Ratings Direct Credit Wire Only.	6/1/2003	Standard & Poor’s (“S&P”)	GEAM
Reuters Services Contract	9/1/1998	Reuters America Inc. (“Reuters”)	GEAM
Moody’s KMV Subscription Agreement	2/1/2003	Moody’s KMV Company (“Moody’s”)	General Electric Company
System License Agreement Bondedge for Windows, Enterprise Edition	6/14/1999	Capital Management Sciences (“CMS”)	GEAM
Leasing Agreement	11/21/2003	Sun Microsystems Finance	GEAM

Bloomberg Agreement #145083	8/24/1995	Bloomberg L.P.	GEAM
Bloomberg Agreement #107247	8/19/1994	Bloomberg L.P.	GEAM

**Section C: Genworth owns Master, split**

The following master agreements and any licenses, leases, addendums and similar arrangements thereunder pursuant to which any software, hardware, equipment or services are acquired that relate primarily to the Genworth Business shall be assigned to a member of the Genworth Group. All licenses, leases, addendums and similar arrangements under any of the following master agreements in the name of GEFAHI or any member of the Genworth Group that do not relate primarily to the Genworth Business shall be retained by or assigned to GEFAHI.

Contract Name	Date	Vendor	GE Party
Master Lease Agreement	10/20/2000	Dell Financial Services, L.P. ("Dell")	GEFAHI
Master Lease Agreement	8/26/2003	Comsource, Inc. ("Comsource")	GEFAHI
GEFAHI Master Lease Agreement		EMC Corporation	GEFAHI
License Agreement	12/31/2001	Classic Solutions Pty Limited ("Classic")	GEFAHI
		Mercury Interactive	GEFAHI
Software License Agreement	No date provided	Edify Corporation ("Edify")	GEFAHI ("Licensee")
Assignment Agreement	4/24/2002	Sterling Commerce / Connect Direct	GEFAHI

**Schedule 2.3(a)(i)****Genworth Liabilities**

- All Liabilities of GEFAHI except Excluded Liabilities.
- all Liabilities of Financial Assurance Company Limited, including those within the definitions of Residual Assets, Residual Liabilities, Retained Insurances, Transferred Assets, Transferring Liabilities, Transferring Contracts, Reinsurance Contracts (as such terms are defined in the UK Transfer Plan
- all Liabilities of Vie Plus S.A. to the extent arising from or otherwise relating to its payment protection business, including the marketing, sale, and administration thereof
- all Liabilities under the Senior Unsecured Promissory Note due November 30, 2010 between GEFAHI as Maker and General Electric Capital Assurance Company as Payee
- all Liabilities of GEFAHI under its 1.6% Yen-denominated Notes due 2011 and related swaps
- All historic Liabilities relating to the parts of the Vantage West property to be leased to FIGSL by GE Life Services Limited.
- With respect to any contract or agreement to which a member of the Genworth Group was or is a signatory or third-party beneficiary, any liability arising prior to the Closing under such contract that is attributable solely to the business of such member of the Genworth Group or the Genworth Business.

**Schedule 2.3(b)(iv)****Excluded Liabilities**



1. Liabilities of GEFAHI under contracts included on Schedule 1.1(b).
2. Any liability (as well as any reserve or other financial statement (and/or books and records) entry or adjustment recorded in respect of such liability by GEFAHI, Brookfield Life Assurance Co., Ltd. or any of their respective affiliates for GAAP or other financial accounting purposes) of GEFAHI, Brookfield Life Assurance Co., General Electric Capital Corporation and GE Capital Asia Investments, Ltd. under that certain Stock Purchase Agreement among Brookfield Life Assurance Company, Ltd., General Electric Capital Corporation, GE Capital Asia Investments, GEFAHI and American International Reinsurance Company, Ltd. dated as of June 26, 2003, as amended as of August 29, 2003 (the "Agreement"), except for any breach by any member of the Genworth Group, or prior to the Closing of the Transaction GEFAHI or any subsidiary of GEFAHI that does not become a member of the Genworth Group, of any obligation of the selling companies in Article V or Article VI of the Agreement.
3. All Liabilities of Vie Plus S.A. to the extent not arising from or otherwise relating to its payment protection business, including the marketing, sale, and administration thereof.
4. The liabilities and obligations of GE Mortgage Holdings, LLC, under the Unconditional Guaranty dated August 20, 2001 in favor of GMAC Mortgage Corporation with respect to certain indemnification obligations of GE Mortgage Services, LLC in connection with the sale of assets used in providing administrative services to a residential mortgage warehouse lender, Cooper River Inc.
5. All Liabilities of Financial Insurance Group Services Limited ("FIGSL") which demonstrably and solely relate to a business or the support of a business of a member of the GEIH Group (as defined in the European Transition Services Agreement but excluding any European Creditor Business Entity) (the "GEIH Business") except for those liabilities which relate to the GEIH Business solely by virtue of FIGSL's obligations pursuant to the support of the GEIH Business pursuant to the European Transition Services Agreement.
6. Comfort Letter(s) regarding demutualization of National Mutual Life Assurance Society dated 10-15-01 (GEFAHI and GE Pensions Limited)
7. Any liability of GEFAHI as of the Closing Date related solely to the business of the Investment Management Marketing & Client Service business segment, including,

without limitation, trade payables, accrued commissions payable and accrued salaries, benefits and bonuses.

8. All historic Liabilities relating to the lease of the Vantage West property to be transferred to GE Life Services Limited as referenced in Schedule 2.2(b)(ii) except for those historic Liabilities relating to the parts of the Vantage West property to be leased to Financial Insurance Group Services Limited by GE Life Services Limited.
9. The following Liabilities of GEFAHI to be retained by GEFAHI (the general ledger account numbers following the description of the liabilities are the account numbers in which the liabilities were reflected as of March 31, 2004 and are included herein for illustrative purposes only):
  - Intercompany payables to members of the GE Group, including the following payables to members of the GE Group: [242215 (Due to UFLIC), 242218 (Due to Heritage Indemnity Co.), 242220 (Due to MWIC), 242416 (Due to GE Investment Distributors), 242443 (Due to GE Dental and Vision), 242444 (Due to National Dental), 242445 (Due to Scrip Plus), 242457 (Due to Signature Agency), 242628 (Due to GE Capital Management Corp.), 242625 (due to GE Capital Administrative Services), 242626 (Due to GE Capital Warranty Co.), 242431 (Due to Monogram General Agency), 242105 (Due to GELCO),]
  - Short-term notes payable - commercial paper [237004].
  - Discount on commercial paper - [237005]

- Short-term notes payable - GECC Intercompany Loans/GECC - Line of Credit [240101].
- Note payable to GE Capital Administrative Services [243625].
- Interest Accrued on Commercial Paper Swaps and the National Mutual Note Receivable. [230202].
- Any I/C loans and I/C balances between GEFAHI and GE recorded with respect to or incurred on behalf of any member of the GE Group [240180].
- Any I/C Travel & Living liability between GEFAHI and GE recorded with respect to or incurred on behalf of any member of the GE Group [240282].
- Any I/C Payroll Liability between GEFAHI and GE recorded with respect to or incurred on behalf of any member of the GE Group [240284].
- Any I/C IBS (Intercompany billing system) liability between GEFAHI and GE recorded with respect to or incurred on behalf of any member of the GE Group [240285].

- Interest rate swap liability on Commercial Paper [282000].
- Cross Currency Swap liability on National Mutual Note Receivable [281400].
- Any I/C Payroll Liability between GEFAHI and GE recorded with respect to or incurred on behalf of any member of the GE Group [240291].
- Any I/C Payroll Liability between GEFAHI and GE recorded with respect to or incurred on behalf of any member of the GE Group [247004].
- Any I/C liability not otherwise listed above between GEFAHI and GE recorded with respect to or incurred on behalf of any member of the GE Group [247025].
- Any I/C liability related to GECIS billing between GEFAHI and GE recorded with respect to or incurred on behalf of any member of the GE Group [247033].
- Any I/C liability related to GE Assessments billed for GE Insurance segment [247019].

10. With respect to any Genworth Contract to which a member of the GE Group (other than GEFAHI, GE Capital Mortgage Insurance Corporation (Australia) Pty. Ltd., GE Mortgage Insurance Pty Ltd., GEMICO Holdings (Australia) or any Delayed Transfer Legal Entities) was or is a signatory or third-party beneficiary, any liability arising prior to the Closing under such Genworth Contract that is attributable solely to the business of such member of the GE Group other than any Genworth Business or any business transferred to

**Continuing Agreements**

1. FACL Services Agreement
2. FICL Services Agreement
3. Framework Agreement
4. FIGSL Share Transfer Agreement
5. FINCL Share Transfer Agreement
6. CFI Administrators Share Transfer Agreement
7. FIG PCC Limited Share Transfer Agreement
8. RD Plus SA Share Transfer Agreement
9. Assocred SA Share Transfer Agreement
10. GEMI Share Transfer Agreement
11. GEMI Guernsey Share Transfer Agreement
12. CFI Pensions Trustees Limited Share Transfer Agreement
13. Worldcover Direct Limited Share Transfer Agreement
14. GE Administraco de Garantias e Participacoes LTDA Share Transfer Agreement
15. FIG Ireland Limited Share Transfer Agreement
16. Loan Facility Agreement between GEFA UK Finance and GEFA UK Holdings Limited

17. Loan Facility Agreement between GEFA International Holdings Inc. and UK Group Holding Company Limited

II. The following side letters between a member of the Genworth Group and the GE Group relating to the Transaction:

1. Side Letters between GEAM and certain members of the Genworth Group dated February 5, 2003 and February 12, 2003, addressing Trade Allocation.

2. Side Letter between GEAM and Genworth dated as of the Closing Date addressing restrictions on withdrawal of account assets.

103

---

3. Side Letter among General Electric Company, General Electric Capital Corporation, GE Capital International Services, and GENWORTH regarding the Amended and Restated Master Outsourcing Agreement.

4. Letter Agreement, dated April 15, 2004, among UFLIC, AML, FHL, FCL, GECLANY, GELAAC and GECA relating to UFLIC's requirement to provide periodic certificates and reports regarding UFLIC's risk based capital ratio.

5. Letter Agreement, dated April 15, 2004, among UFLIC, GECC, AML, FHL, FCL, GECLANY, GELAAC and GECA relating to the assignment by GECC of the Capital Maintenance Agreement.

6. Letter Agreement, dated April 15, 2004, among UFLIC, AML, FHL, FCL, GECLANY, GELAAC, GECA, JLIC, Brookfield, GEFAHI, GECC and certain of their affiliates relating to the rescission of certain agreements upon the failure of certain events to occur.

5. All reinsurance agreements, including letters of intent and side letters, between any member of the Genworth Group and any member of the GE Group that are in force as of the Closing Date, including without limitation, the agreements listed on Exhibit 1 to Schedule 2.4(b) (ii).

6. The leases set forth on Schedules C-1 and C-2 of the Transition Services Agreement

7. With respect to securitization transactions, all agreements and arrangements with Edison Asset Securitization, L.L.C., General Electric Capital Corporation, GE Life and Annuity Assurance Company, General Electric Capital Assurance Company and one of the following special purpose entities: GEFA Special Purpose One, LLC; GEFA Special Purpose Two, LLC; GEFA Special Purpose Three, LLC; GEFA Special Purpose Four, LLC; GEFA Special Purpose Five, LLC, and GEFA Special Purpose Six, LLC.

III. The following Homebuyer Privileges Supplier Agreements with GE Appliances, Penske Truck Rental, GE Residential Long Distance, GE Lighting, GE Service Protection, Storage USA:

1. F. Agreement between GEMICO and SUSA Partnership, L.P. dated August 15, 2002

G.

2. Internet Sponsor Agreement between GEMICO and Electric Insurance Company effective February 6, 2001

3. Agreement between GEMICO and GE Capital Communication Services Corporation dated March 27, 2001
4. Agreement between GEMICO and GE Capital Communication Services Corporation dated December 6, 2000

104

---

5. GE Consumer Products - GE Homebuyer Privileges Program Agreement between GEMICO acting on behalf of the General Electric Company (such interest to be assigned to Genworth pursuant to Schedule 1.1(a), above and General Electric Company through its GE Consumer Products business dated (such interest to be retained by GE pursuant to Schedule 1.1(a), above) August 12, 2003
6. GESMI-GE Homebuyer Privileges Program Agreement between GEMICO acting on behalf of the General Electric Company such interest to be assigned to Genworth pursuant to Schedule 1.1(a), above and GE Service Management, Inc. (such interest to be retained by GE pursuant to Schedule 1.1(a), above) dated May 21, 2003
7. Penske Auto Centers — General Electric Company Lender Program Memorandum of Understanding between GEMICO acting on behalf of the General Electric Company (such interest to be assigned to Genworth pursuant to Schedule 1.1(a), above) and Penske Auto Centers, LLC (such interest to be retained by GE pursuant to Schedule 1.1(a), above) dated November 13, 2000
8. Penske Truck Rental-General Electric Company Lender Program Memorandum of Understanding between GEMICO acting on behalf of the General Electric Company (such interest to be assigned to Genworth pursuant to Schedule 1.1(a), above) and Penske Truck Leasing Co., L.P. (such interest to be retained by GE pursuant to Schedule 1.1(a), above) dated October 11, 2000

IV. Investment Management/Services

9. GE Funds Financial Intermediary Agreement dated 2004, between Terra Securities, Corp. and GE Investment Distributors, Inc.
10. GE Funds Introducing Broker Agreement dated 2004, between GEAM and Capital Brokerage Corporation.
11. Investment Management and Services Agreement between GEAM and River Lake Insurance Company dated as of July 28, 2003
12. Investment Advisory Agreement between GEAM and GE Private Asset Management, Inc. dated December 12, 2002
13. Administrative Services Agreement between GELAAC and certain of its affiliates and GEAM, effective May 1, 2000.
14. Participation Agreement among GELAAC, GE Investment Funds, Inc. and GEAM dated May 1, 1998

105

---

15. Participation Agreement among GECLANY, GE Investment Funds, Inc. and GEAM dated May 1, 1998
16. Subservicing Agreement (Cardinal CDO) dated as of , 2004, by and between GEAM and Genworth Financial Asset Management, LLC
17. Master Agency, Servicing and Subordination Agreement between General Electric Capital Business Asset Funding Corporation and GECA dated October 1, 2003
18. Master Agency, Servicing and Subordination Agreement between GECC and GECA dated October 1, 2003
19. Master Agency, Servicing and Subordination Agreement among GECC, FCL (“Senior Lender”) and GECC (“Agent”) dated December 1, 2003

20. Master Agency, Servicing and Subordination Agreement among General Electric Capital Business Asset Funding Corporation, FCL (“Senior Lender”) and General Electric Capital Business Asset Funding Corporation (“Agent”) dated October 7, 2003
21. Master Agency, Servicing and Subordination Agreement between GE Capital Franchise Finance Corporation and GECA dated October 1, 2003
22. Secondment Agreement between GEAM and GNA Corporation dated February 2, 2004

V. Administrative Services

23. Administrative Services Agreement among FCL, FHL, GECA, GELAAC and GECC dated July 9, 2002
24. Amended and Restated Services and Shared Expenses Agreement among GNA Corporation, GECA, FCL, FFRL Re, FHL, Brook, GEGLAC, GELAAC, JLIC, MWIC, PIC, UFLIC, RLIC, HLIC, WLIC, Viking and Westlake dated as of January 16, 2004
25. Shared Office Facilities Agreement among GE Capital Card Services, Inc., GECA, Employers Retirement Corporation and GE Capital Commercial Finance, Inc. effective December 1, 2002
26. Reinsurance and Administrative Agreement between UFLIC and GELAAC dated January 1, 1987
27. Services Agreement between UFLIC and GELAAC dated July 19, 1989
28. Agreement between GECLANY and GE Capital Assignment Corporation dated August 13, 1995, as amended August 31, 2000

VI. Finance

29. Agreement for the Purchase and Sale of Property between GE Capital Asset Management Corporation (“GECAMC”), General Electric Mortgage Insurance Corporation, GE Residential Mortgage Insurance Corporation of North Carolina, General Electric Mortgage Insurance Corporation of North Carolina and Verex Assurance, Inc., dated October 3, 1994 and any amendments thereto, as assigned by GECAMC to GE Capital Mortgage Services, Inc. (presently known as GE Mortgage Services LLC) as of May 1, 1995 and as amended by that certain Corrective — Restated Amendment to the Purchase and Sale of Property dated as of September 11, 1998

VII. IT Services and Outsourcing

30. All agreements between Genworth Group entities and GE Capital International Services (including those agreements entered into together with GEAM) (which shall be amended following the Closing Date as contemplated by the parties)
31. All agreements between Genworth Group entities and GE Process Solutions, LLC (which shall be amended following the Closing Date as contemplated by the parties)
32. All agreements between Genworth Group entities and GE Capital International Services — Americas, Inc. (which shall be amended following the Closing Date as contemplated by the parties)
33. Acknowledgement of Agreement dated November 8, 2002 and Scope of Work dated November 8, 2002 (effective October 1, 2002) between GE IT Solutions, Inc. (f/k/a GE Capital Information Technology Solutions — North America, Inc.) and FCL (pursuant to the Master Managed Services Agreement between GECITS and General Electric Capital Services, Inc. dated January 10, 2001, as amended, (the “Master Managed Services Agreement” hereafter)
34. Acknowledgement of Agreement dated December 27, 2001 and Scope of Work (No. GEFAGECA-001) dated December 31, 2001, as amended, between GE IT Solutions, Inc. and GECA (pursuant to the Master Managed Services Agreement)

35. Acknowledgement of Agreement dated December 27, 2001 and Scope of Work (No. GEFALTC-001) effective December 31, 2001 between GE IT Solutions, Inc. and GECA
36. Acknowledgement of Agreement dated November 8, 2002 and Scope of Work effective October 1, 2002 between GE IT Solutions, Inc. and GECA
37. Acknowledgement of Agreement dated November 8, 2002 and Scope of Work effective as of October 1, 2002, as amended, between GE IT Solutions, Inc. and GEGLAC (pursuant to the Master Managed Services Agreement)

38. Acknowledgement of Agreement dated November 8, 2002 and Scope of Work dated November 8, 2002 (effective October 1, 2002) between GE IT Solutions, Inc. and GELAAC as Customer (pursuant to the Master Managed Services Agreement)
39. Consulting Agreement between GECA and GE IT Solutions, Inc. effective August 7, 2002
40. GE CAPITAL ITS MASTER LEASE AGREEMENT between GE Capital Information Technology Solutions, Inc. (“Lessor”) and GECMICAN (“Lessee”) dated November 19, 1999
41. Loss Mitigation Optimizer License Agreement between GEMICO and GE Capital Mortgage Services, Inc. dated September 25, 2000

VIII. Miscellaneous

42. H. Group Long Term Care Insurance Policy dated July 1, 1999 issued by GECLANY to GE as group policyholder (New York area)
  - I. Group Long Term Care Insurance Policy issued by GECA to GE as group policyholder (excluding New York area)
44. [Producer Credit Card Agreement between GEGLAC and GE Business Productivity Solutions, Inc. (approved by Connecticut Department of Insurance on April 12, 2002, no executed copy available)]

IX. European Affiliate Agreements (GEMI Europe)

45. Vehicles Lease, Management and Service Frame Agreement for Spain between GE Capital Largo Plazo, S.L. and GEMI dated May 1, 2002
46. Amendment to Vehicles Lease, Management and Service Frame Agreement for Spain between GE Capital Largo Plazo, S.L., GEMI and GE International, Inc. dated June 1, 2002
47. Cost Agreement Employee Stock Purchase Plan for the UK between ServiceCo and GE dated February 27, 2002
48. Cost Agreement Employee Stock Purchase Plan for Spain between GEMI and GE dated May 1, 2003
49. Cost Agreement Employee Stock Purchase Plan for the Netherlands between GEMI and GE dated June 1, 2003
50. Cost Agreement Employee Stock Purchase Plan for Belgium between GEMI and GE dated September 1, 2003

51. Cost Agreement Employee Stock Purchase Plan for Germany between GEMI and GE dated September 1, 2003
52. Cost Agreement Employee Stock Purchase Plan for Italy between GEMI and GE dated September 1, 2003

53. Master Conditional Sale Agreement between ServiceCo and GE Capital Fleet Services Limited (trading as Avis Fleet Services) dated March 31, 2000
  54. Car Lease Agreement for Italy between GEMI and GE Capital Servizi Finanziari S.P.A. dated February 21, 2002
  55. Amendment to the Car Lease Agreement for Italy between GEMI and GE Capital Servizi Finanziari S.P.A. (dated February 21, 2002) dated July 18, 2002
  56. Car Lease Agreement for Italy between GEMI and GE Capital Services Srl dated October 1, 2003
  57. Work place lease agreement (“Vereinbarung zur Uberlassung von Arbeitsplatzen”) for Germany between GE Capital mietfinanz GmbH & Co. and GEMI dated August 25, 2003
  58. Property Lease agreement (sublease) for Sweden between International General Electric AB and GEMI dated February 1, 2004
  59. Lease Agreement for parking spaces for Sweden between International General Electric AB and GEMI dated February 1, 2004
  60. Property License Agreement for the UK between GE Capital Bank Limited and GEMI dated September 22, 2001
  61. Lease/ license arrangement (oral) in France between GEMI and ERC
  62. Leasing arrangement (oral) in Belgium between a member of the GE Group and GEMI
  63. Leasing arrangement (oral) in Netherlands between GE Fleet and GEMI
- X. European Affiliate Agreements (GE Financial Insurance)
64. J. Agency Agreement dated July 23, 1997 between Pallas Industrial Finance, FICL and FACL.
  - K.
  65. Agreement dated October 3, 2003 between GE Capital Equipment Finance, Vie Plus SA and RD Plus SA and any insurance policies referred to therein.

66. Support Services Agreement dated July 2003 between GE Capital Global Process Solutions (UK) Limited and FIGSL and all statements of work entered into pursuant to this agreement
67. All agreements between a member of the Genworth Group and GE Capital Fleet Avis relating to the leasing of cars and provision of related services
68. Master Conditional Vehicle Sale Agreement between GE Capital Fleet Services Limited and FIGSL dated March 20, 1996
69. Disposal Agreement between GE Capital Fleet Services Limited and FIGSL dated March 20, 1996
70. Co-operation agreement dated 12 February 2001 between FACL, FICI, GE Frankona Reinsurance A/S and Terra Gruppen AS Life Reassurance Proportional Agreement dated 1 June 2001 between FICL, FACL and GE Frankona Reinsurance A/S Reinsurance Agreements dated 10 November 1998, 30th November 1998 and 1 January 1999 between ERC Frankona and GE Financial Assurance Compania de Seguros y Reaseguros de Vida, SA Reinsurance Agreement dated 4 October 2000 between Financial Insurance Company Limited and FRC Frankona AG
71. Equity Compensation Cost Agreement between FIGSL and GE dated July 19, 2001
72. Lease between Vie Plus and RD Plus S.A. for part of Floor 29, Tour Franklin, Terrasse Boieldieu, La Defense 8, Paris (Oral)
73. Lease between GE Capital Bank and FICL for Park Allé 295, 2605 Brøndby, Denmark dated 05/08/2002
74. Lease between GE Finland Oy and FACL for Malmin Kauppatie 18, Helsinki, Finland dated 10/08/01
75. Lease between GE General Electric Financing Holding GmbH and GE Financial Insurance Deutschland for Martin-Behaim Str. 8-10, Neu-Isenberg, Germany dated 06/05/01



76. Lease between GE Capital Woodchester Ltd and FIGSL for Woodchester House, Golden Lane, Dublin
77. Lease between Access Graphex BV, trade name GE Access and FIGSL for Dr Willem Dreesweg 6-8 1185 VB, Amstelveen, Netherlands dated February 2003

110

78. Lease between GE Capital Fleet Services and GE Financial for Karenslyst alle 2, Oslo, Norway (oral)
79. Leases between International General Electric GB and GE Financial Insurance Sweden for Nöten 3, Solna Strandväg 98, Sweden and parking space (2001)
80. Lease between GE SF Structured Finance Int. Ltd and GE Financial Insurance for Thurgauerstrasse 40, Zurich, Switzerland (pending)
81. Agreement between Financial Insurance Group Services Limited, Namulas Pension Trustees Limited and GE Pensions Limited dated 5 April 2002

XI. GE Mexico

82. L. Vehicle Rental Agreement (a/k/a Fleet Services Agreement) between GE Capital Fleet Services de Mexico S.A. and GE Seguros S.A. de C.V. (formerly Colonial Penn de Mexico Compania de Seguros S.A.) dated May 4, 1999

111

**Exhibit 1 to Schedule 2.4(b)(ii)**

See attached spreadsheet

112

**Exhibit 1 to Schedule 2.4(b)(ii)**

**Annual Insurance Holding Company Statement  
Listing of Affiliate Reinsurance Agreements as of 12/31/03 — Exhibit C**

	Ceding Registrant	Assuming Party	Type	Agreement Eff. Date	Amount in Force as of YE 03	Reserve Credit Taken	Unearned Premiums	Premiums	Paid Losses	Unpaid Losses	ModCo Res.	Business	Owner
	Employers Reinsurance Company ("ERC")												
	Employers Life Reinsurance Corporation ("ERC Life")												
	Westport Insurance Corporation ("WIC")												
	Viking Insurance Company, Ltd. ("Viking")												
	Westlake Insurance Company ("Westlake")												
	Westwood Indemnity Company ("Westwood")												
X	AML/GECA/FCL/GELAAC/GEGLAC / PIC	Everest	Life CAT XOL	12/1/2003	460,000,000,000			2,975,000				HQ	Peter Blume
	AML	ERC (should be ERAC)	YRT/i	10/14/1974	940,863	25,545		65,245				IBG	Mike Adams
	AML	ERC	DIS/i	5/1/1997	0	43,888		0				IBG	Mike Adams
	AML	ERC	CO/i	5/1/1997	827,510,300	15,474,385		893,022	32,160	243,563		IBG	Mike Adams
	AML	ERC	CO/i	7/27/1990	(amounts reported in 10/14/74 treaty line)							IBG	Mike Adams
	AML	ERC	YRT/i	10/1/1990	(amounts reported in 10/14/74 treaty line)							IBG	Mike Adams
	AML	ERC	CO/i	5/1/1997	426,899,380	6,272,994		1,502,590	19,120	155,563		IBG	Mike Adams
	AML	FCL	YRT/i	3/1/1973	486,399,416	514,058		3,335,866	0	2,170,748		IBG	Mike Adams
	AML	FCL	DIS/i	3/1/1973	0	512,194		0				IBG	Mike Adams
	AML	FCL	ADB/i	3/1/1973		16,312		0				IBG	Mike Adams
	AML	FCL	CO/i	3/1/1973	3,515,270,170	20,927,261		7,896,591	Reported in YRT 3/1/73			IBG	Mike Adams
	AML	FCL	YRT/g	3/1/1973	302,529	3,441		0				IBG	Mike Adams





GE Guarantees

1. Guaranty dated 8-9-00, made by GE Capital Corporation in favor of Bankers Trust with respect to L/C issued on behalf of Sponsored Captive Re, Inc.
2. Letter Agreement dated 10-21-02, made by GEFAHI in favor of Brookfield with respect to capital support in connection with business assumed from FCL(11)
3. Guaranty dated 11-18-03 by GECC relating to GECA's Funding Agreements
4. Guaranty dated 11-18-03 by GECC relating to GELAAC's Funding Agreements
5. Assurance Letter/Guaranty dated 1-22-04 made by GEFAHI, in favor of Financial Assurance Company Limited ("FACL") and Financial Insurance Company Limited ("FICL") in connection with FACL's acquisition of Consolidated Insurance Group, Limited. (12)
6. Assurance Letter/Guaranty dated [ ] made by GEFAHI in favor of Financial Assurance Company Limited ("FACL") and Financial Insurance Company Limited ("FICL") in connection with the reinsurance arrangements between FACL, FICL and Viking Insurance Company Limited (13)
7. Support Agreement dated as of 5-15-03, made by GEFAHI in favor of ABN AMRO, Amsterdam Funding Corporation and certain Banks (Commission Funding)(14)
8. Performance Guaranty dated as of 12-3-99, made by GE Capital Corporation in favor of GEFA Special Purpose One, Edison Asset Securitization and GE Capital Corporation (as Operating Agent and Collateral Agent), as amended and restated pursuant to an Amended and Restated Performance Guaranty dated as of 9-27-01
9. Limited Guaranty dated as of 6-21-01, made by GEFAHI in favor of Edison Asset Securitization and GE Capital Corporation (GEFA SPV 2)(15)

---

(11) To continue until assumed by Genworth.

(12) To be assumed by Genworth upon the Initial Public Offering (subject to the approval of the UK's Financial Services Authority).

(13) To be assumed by Genworth upon the Initial Public Offering (subject to the approval of the UK's Financial Services Authority).

(14) To continue until assumed by Genworth.

(15) To continue until assumed by Genworth.

10. Performance Guaranty dated as of 6-21-01, made by GE Capital Corporation in favor of GEFA Special Purpose Two, Edison Asset Securitization and GE Capital Corporation (as Operating Agent and Collateral Agent)

11. Support Agreement dated as of 6-21-01, made by GE Capital Corporation in favor of Edison Asset Securitization and GE Capital (as Operating Agent and Collateral Agent)
12. Performance Guaranty dated as of 11-14-00, made by GE Capital Corporation in favor of GEFA Special Purpose Three, Edison Asset Securitization and GE Capital Corporation (as Operating Agent and Collateral Agent), as amended and restated pursuant to an Amended and Restated Performance Guaranty dated as of 9-27-01
13. Limited Guaranty dated as of 6-11-01, made by GEFAHI in favor of Edison Asset Securitization and GE Capital Corporation (GEFA SPV 4), as amended and restated pursuant to an Amended and Restated Guaranty dated as of 9-27-01(16)
14. Performance Guaranty dated as of 6-11-01, made by GE Capital Corporation in favor of GEFA Special Purpose Four, Edison Asset Securitization and GE Capital Corporation (as Operating Agent and Collateral Agent), as amended and restated pursuant to an Amended and Restated Performance Guaranty dated as of 9-27-01
15. Support Agreement dated as of 6-11-01, made by GE Capital Corporation in favor of Edison Asset Securitization and GE Capital Corporation (as Operating Agent and Collateral Agent), as amended and restated pursuant to an Amended and Restated Support Agreement dated as of 9-27-01
16. Limited Guaranty dated as of 3-28-02, made by GEFAHI in favor of Edison Asset Securitization and GECC (Omega)(17)
17. Performance Guaranty dated as of 3-28-02 made by General Electric Company in favor of GEFA Special Purpose Six, Edison Asset Securitization and GE Capital Corporation (As Operating Agent and Collateral Agent) (Omega)
18. Support Agreement dated as of 3-28-02, made by GE Capital Corporation in favor of GEFA Special Purpose Six, Edison Asset Securitization and GE Capital Corporation (as Operating Agent and Collateral Agent) (Omega)
19. Performance Guaranty dated as of 3-28-02 made by GE Capital Corporation in favor of GEFA Special Purpose Six, Edison Asset Securitization and GE Capital Corporation (As Operating Agent and Collateral Agent) (Omega)

---

(16) To continue until assumed by Genworth.

(17) To continue until assumed by Genworth.

20. Comfort Letter dated as of 1-6-95, made by GE Capital Corporation in favor of the Canadian Superintendent of Financial Institutions relating to GEMICO(18)
21. General Electric Capital Corporation's obligations under the Grant Agreements dated 19<sup>th</sup> December, 1997 relating to the properties located at Bay numbers 133-134 of the Shannon Free Zone, Ireland.
22. General Electric Capital Corporation's obligations under the Lease Agreements dated 25<sup>th</sup> November, 1998, 1<sup>st</sup> July 2000, 14 January 2002 and 31 October 2001 relating respectively to the properties located at Bay numbers 133-134, 135, 136 and 137 of the Shannon Free Zone, Ireland.

23. General Electric Capital Services, Inc.'s obligations under the ISDA Master Agreement, relating to the Credit Derivates Transaction, entered into with Deutsche Bank AG London Branch dated as of March 13, 2002 relating to Brookfield Life Assurance Company's USD 400,000,000 Floating Rate Note Program Series 2002-A-1, including any renewals thereof

24. The obligations of GEFAHI, GECC and GE Capital Asia Investments under the Stock Purchase Agreement, dated June 26, 2003, as amended on August 29, 2003, among Brookfield Life Assurance Co., Ltd., GEFAHI, General Electric Capital Corporation, GE Capital Asia Investments (collectively, the "Seller") and American International Reinsurance Company, Ltd., except as provided on Schedule 2.3(b)(iv), item 2.

---

(18) To continue until Trigger Date.

## Schedule 2.9

### European Creditor Business Entities

#### Part A: To be transferred to Genworth pursuant to stock transfer agreement

- CFI Administrators Limited
- CFI Pension Trustees Limited
- Ennington Properties Limited(19)
- Financial Insurance Guernsey PCC Limited
- FIG Ireland Limited
- RD Plus SA
- Assocred SA
- Financial Insurance Group Services Limited
- Financial New Life Company Limited
- World Cover Direct Limited

#### Part B: To be transferred to Genworth pursuant to the UK Transfer Plan or the FACL Fall-back Stock Transfer Agreement

- Consolidated Insurance Group Limited
- Financial Insurance Company Limited
- Financial Assurance Company Limited(20)
- GE Financial Insurance, Compania de Seguros y Reaseguros S.A.
- GE Financial Assurance, Compania de Seguros y Reaseguros de vida S.A.

---

(19) The stock of this entity will transfer to Genworth by virtue of the transfer of the stock of its immediate parent company, CFI Administrators Limited

(20) The stock of this entity is only to be transferred to Genworth if the UK Transfer has not taken effect by December 31, 2004

## Surplus Note Payments

Surplus Note:	Original Principal Amount:	Principal Amount to be Paid on Closing Date:	Accrued Interest to be Paid on Closing Date:
8% surplus note due September 30, 2020 issued by JLIC to GEFAHI	\$ 260,000,000	\$ 260,000,000 (paid to GEFAHI)	\$ [73,600,000] (paid to GEFAHI)
7% surplus note due November 30, 2021 issued by JLIC to GEFAHI	\$ 58,000,000	\$ 58,000,000 (paid to GEFAHI)	\$ [9,400,000] (paid to GEFAHI)
5.16% surplus note due May 31, 2022 issued by JLIC to GEFAHI	\$ 51,000,000	\$ 51,000,000 (paid to GEFAHI)	\$ [4,100,000] (paid to GEFAHI)
7% surplus note due May 31, 2021 issued by JLIC to Brookfield	\$ 91,000,000	\$ 91,000,000 (paid to Brookfield)	\$ [2,400,000] (paid to Brookfield)

117

Schedule 3.2(f)

## Dividends

First Colony will pay to FHL a dividend of approximately \$442.7 million;

FHL will pay to GECA a dividend of approximately \$453.6 million;

FHL will pay to GEFAHI a dividend of approximately \$10.8 million;

GELAAC will pay to GECA a dividend of approximately \$367.6 million;

GELAAC will pay to FHL a dividend of approximately \$49.3 million;

GELAAC will pay to GEFAHI a dividend of approximately \$13.1 million;

GECA will pay to GNA a dividend of approximately \$856.4 million;

GNA will pay to GEFAHI a dividend of approximately \$691.4 million;

Brookfield will pay to GEFAHI a dividend of approximately \$183.1 million; and

Viking will pay to GELCO a dividend of approximately \$225.0 million.

118

Schedule 4.1

## Annual Corporate Reporting Data

### CDR Submissions/ Data requirements [Closing the Books]

Schedule Name(s)	Description (Contents)	Est. Due date	Cons	C	
				Equity/ Cost - Penske Model - (A)	Equity/ Cost - SES Model - (B)
TRSY interest allocation		12/15/03	•	•	
MF System closes		12/18/03	•	•	
MTM to Biz on Livelink		12/18/03	•	•	
TRSY interest allocation to DPL—IA on Internet		12/19/03	•	•	
Corporate freight in DPL		12/19/03	•		

CTA Available on Internet	12/22/03	•	•
APL File in DPL	12/23/03	•	•
Payroll in DPL	12/24/03	•	
IBS billing cut-off	12/25/03	•	
CBSI Payroll to DPL	12/25/03	•	
A/P to DPL	12/25/03	•	
CDR AU/MU Affiliate Rec	12/26/03	•	•
MTM Hedge entries via e-mail	12/26/03	•	•
CDR AU/MU Affiliate Rec	12/29/03	•	•
CDR AU/MU Affiliate Rec	12/30/03	•	•
Fixed Assets to DPL	12/30/03	•	
IBS in DPL	12/30/03	•	
CDR AU/MU Affiliate Rec	12/31/03	•	•
CDR AU/MU Affiliate Rec	1/1/04	•	•
ATOM Smart Filter—CMS	1/1/04	•	•
CDR AU/MU Affiliate Rec	1/2/04	•	•
CDR AU/MU Affiliate Rec	1/3/04	•	•
CDR AU/MU Affiliate Rec	1/4/04	•	•
All AU files—6:00PM	1/5/04	•	•
CDR AU/MU Affiliate Rec	1/5/04	•	•
CDR AU/MU Affiliate Rec	1/6/04	•	•
CDR AU/MU Affiliate Rec	1/7/04	•	•
Net Income to GE	1/8/04	•	•
Full Trial Balance to GE	1/9/04	•	•
TRSY Country risk sub account/current account rec due	1/9/04	•	•

(A) If Blue Ridge is similar to Penske i.e. it's own BSLA rolling up to the segment ( Penske rolls to EM), then the #'' for equity and cost would be required.

(B) If Blue Ridge is similar to SES i.e. an entry booked each month/ quarter by an operating unit (SES entry made by SFG in their own BSLA) then the #'' for equity and cost columns would **NOT** be required, however, the necessary financial information to continue to account for the equity/ cost investment would be required.

(C) After prior consultation with Genworth, not less than 60 days prior to the date on which the investment in Genworth is first reported using the equity method, GE will advise Genworth whether to follow the Penske Model or the SES Model. Thereafter and so long as the investment in Genworth is reported using the equity method, at the request of either party to be made by such party no more frequently than once every 6 months, Genworth and GE will work together in good faith to address requested modifications of the reporting under the equity method.

Schedule Name(s)	Description (Contents)	Est. Due date	Cons	Equity	Cost
FAS 133 template		1/5/04	•		
Acquisition / Disposition Information	Revenue and NI (Excel)	1/9/04	•		
Acquisition / Disposition Tracker	Acquisitions and Dispositions Closed in the Quarter (Excel)	1/9/04	•		
Acquisition / Disposition Webtool	Acquisition and Disposition Tracker (Webtool)	1/9/04	•		
WRI Geographic Summary	Confirmation of numeric data via e-mail	1/8/04	•	•	
DR4MGOP (FP&A)	Volume / Write Offs / Equity / Non-Earnings	1/8/04	•		
DR4FX (FP&A)	FX Revenue and NI	1/9/04	•		
DR140 (FP&A)	Gains DR	1/9/04	•		
Balance Sheet and P&L(Note)	Spreadsheet / Presentation Format	D		•	•
Key Drivers Analysis / Discussion (Note)		D		•	
WRI Non Earning (FP&A)	Non Earning > \$3MM	1/10/04	•		
WRI Comments (FP&A)	WRI—Gains, Other One-Offs, Other Tax	1/9/04	•		
Unusual / Non-Recurring Items > \$10MM	E-mail Submission	1/9/04	•		
DR107BL	Non Earning	1/9/04	•		
DR019AS3.2	Roll Forward—Investment Securities Assets 3.2	1/9/04	•		
CF-1 for Cash Flow		1/10/04	4		
WRI Non Earning (DR107BL)	Non Earning; WRI Non Earning (DR107BL)—Variance Commentary	1/10/04	•		
DR 106	Financing Receivables	1/10/04	•		
DR 171	Intangible Assets	1/10/04	•		
DR115REC	FAS115 Reconciliation	1/10/04	•		
WRI Non Earning (DR107BL)	Non Earning; WRI Non Earning (DR107BL)—Variance Commentary	1/11/04	•		
WRI AFL	WRI Allowance for Losses—Variance Commentary	1/11/04	•		
WRI FAS 115 Rec (DR 115 Rec)	WRI FAS 115 Gains/losses Reconciliation—Variance Commentary	1/11/04	•		



WRI Financing Receivables (DR 106)	WRI Financing Receivables (DR106) including roll forward for loans and leases—Variance Commentary	1/11/04	•
WRI Intangible Assets (DR 171)	WRI Intangible Assets (DR171)—Variance Commentary	1/11/04	•
WRI Invest Sec. RollForward (DR 109 ULA)	Roll Forward—Variance Commentary and ULA security Listing	1/11/04	•
WRI Investment Sec. Realized Gains / Losses (DR 019 AS 3.2)	WRI Realized Gains/Losses—Variance Commentary and Impairment Listing	1/11/04	•
WRI MD&A Balance Sheet Analysis	Variance Commentary for Balance Sheet	1/12/04	•
DR—GECS Revenue	EIA	1/12/04	•
DR—450 Minority Interest	Minority Interest	1/12/04	•
WRI—Minority Interest	Minority Interest	1/12/04	•
WRI Geographic Summary	Variance Commentary for all line items on a QTD basis	1/13/04	• •
WRI—GECS Revenues	EIA	1/13/04	•
DR—Other Liabilities (DR XXX)	OTL	1/15/04	•
DR019ULA	Unrealized Loss Aging	1/15/04	•
DR103	Insurance Liabilities, Reserves and Annuity Benefits—Component Details	1/15/04	•
DR180	ELTO & PP&E	1/15/04	•
DR113	Other Assets	1/15/04	• •
WRI—Accounts Payable (DR 307)	A/P	1/16/04	•
WRI—Other Liabilities	OTL	1/16/04	•
WRI Insurance Liabilities Reserve	WRI Business Details—Variance Commentary	1/16/04	•
WRI MD&A P&L Analysis	Variance Commentary for Income Statement—P&L	1/16/04	•

(D)—Under Equity Method the P&L, Balance Sheet, and Key Drivers will be due per the GE timeline as provided in the quarterly instructions.

(D)—Under Cost Method the P&L, Balance Sheet, and Key Drivers will be due per the Genworth quarterly SEC filing timelines.

Schedule Name(s)	Description (Contents)	Est. Due date	Cons	Equity	Cost
WRI—ELTO / PP&E (DR180)	PPE & ELTO (DR180)—Variance Commentary	1/16/04	•		
DR—Non-Cancelable Leases	NCL	1/16/04	•		
DR—Op & Admin	OPA	1/16/04	•		
DR—Other Receivables	OTR	1/16/04	•		
DR106CM	Financing Receivables—Contractual Maturities	1/16/04	•		
DR106FL	Financing Receivables—Financing Leases	1/16/04	•		
DR019AS3	Contractual Maturities—Investment Securities Assets 3	1/17/04	•		
DR103	Insurance Liabilities, Reserves and Annuity Benefits—:1) Average yield used in Computation of future benefits 2)Roll Forward—Unpaid claims/claim adjustment expenses 3) Financial Guarantees and credit life risk 4) Property and casualty operations	1/17/04	•		
WRI—Insurance Premiums	WRI—Insurance Premiums	1/17/04	•		
WRI—Inv. Sec. Component Detail	WRI Component details of Investment Securities Variance Commentary	1/17/04	•		
WRI—Non-Cancelable Leases	NCL	1/17/04	•		
WRI—Op & Admin	OPA	1/17/04	•		
WRI—Other Receivables	OTR	1/17/04	•		
WRI Financing Leases	WRI Financing Leases(DR106FL)—Variance Commentary	1/17/04	•		
WRI—Other Assets (DR 113)	WRI Other Assets (DR113) including roll forward for Associated Companies and Real Estate—Variance Commentary	1/17/04	•	•	•
WRI Insurance Receivables	Variance Commentary	1/17/04	•		
WRI Invest Sec business detail	WRI—Business Details—Variance Commentary	1/17/04	•		
DR030FI	Financial Instruments	1/19/04	•		
DR119RNA	Net Restricted Assets	1/19/04	•		
WRI—Component Detail—Insurance Liabilities (DR 103)	WRI—Component Detail of Insurance Liabilities, Reserves and Annuity Benefits—Variance Commentary	1/19/04	•		
WRI—Financial Guarantees and Credit Life (DR 103)	WRI—Financial Guarantees and Credit Life—Variance Commentary	1/19/04	•		
WRI—Insurance Losses	WRI—Insurance Losses—Variance Commentary	1/19/04	•		
WRI—Unpaid Claims Rollforward (DR 103)	WRI—Insurance Reserves; Unpaid Claims and Claim Adjustment Expenses—Variance Commentary	1/19/04	•		
WRI Financing Rec. Contractual Maturities (DR 106)	WRI Financing Receivables—Contractual maturities(DR106CM)—Variance Commentary	1/19/04	•		
WRI Invest. Sec Contractual Maturities (DR 019 AS 3)	WRI Contractual Maturities Debt Securities—Variance Commentary	1/19/04	•		
WRI—Financial Instruments (DR030FI)	WRI Financial Instruments (DR 030FI)—Variance Commentary	1/20/04	•		
WRI—Restricted Net Assets (DR 119RNA)	WRI—Restricted Net Assets	1/20/04	•		

**MD&A and Annual Report**

Schedule Name(s)	Description (Contents)	Est. Due date	Cons	Equity	Cost
MD&A CAP Draft to businesses for review		1/20/04	•		
MD&A Ops Draft to businesses for review		1/21/04	•		
Comments on MD&A CAP due		1/22/04	•		
MD&A SFD Draft MD&A FR&L Draft to businesses for review		1/24/04	•		
Comments on MD&A Ops due		1/24/04	•		
Comments on MD&A SFD & FR&L due		1/26/04	•		
Entire MD&A Draft To Businesses For S-O Review		1/27/04	•		
S-O Supplemental Acknowledgements Due From Businesses		1/30/04	•		
Draft A/R to Disclosure Committee		1/30/04	•		
Draft AR #1 of Genworth to GE		TBD	•	•	
Disclosure Committee Mtg. A/R Review		2/4/04	•		
Disclosure Committee Meeting A/R Review—Continued		2/5/04	•		
Draft AR #2 of Genworth to GE		TBD	•	•	
A/R To Graphics		2/6/04	•		
Graphics Prints Board Copies Of A/R		2/7/04	•		
A/R Mailed to Board		2/9/04	•		
GECS/GECC 10-K Item 1 to Op-Segments discussion to businesses for review		2/10/04	•		
JRI Annual Closing Review Meeting		2/11/04	•		
A/R Verification meetings—all day		2/12/04	•		
GE Board Meeting To Review A/R		2/13/04	•		
Last day for Non-BOD changes		2/13/04	•		
GECS/GECC 10-K Item 1 to Op-Segments discussion comments due		2/13/04	•		
1 <sup>st</sup> Set Printer Proofs		2/13/04	•		
Team To Printers		2/14/04	•		
Final AR of Genworth to GE		TBD	•	•	
Team At Printers Verifying proofs		2/15/04	•		
Incorporate Board Comments		2/16/04	•		
A/R Proofs Review		2/16/04	•		
(Last Date for BOD Changes)		2/16/04	•		
Business Descriptions		2/16/04	•		
A/R Proofs Reviewed & Approved		2/17/04	•		
A/R Printing		2/18/04	•		
A/R Printing		2/18/04	•		
Genworth Draft 1 10K to GE		TBD	•	•	
Draft 10-K To Businesses For S-O Review		2/25/04	•		
S-O Supplemental Ack. on 10-K Due From Businesses		2/26/04	•		
Draft 10-Ks to Disclosure Committee		2/26/04	•		
Genworth Draft 2 10K to GE		TBD	•	•	
Disclosure Committee Meeting Review of 10-Ks		2/27/04	•		
10-K Review With KSS/JRI		3/1/04	•		
Mail 10-K To Board		3/1/04	•		
GECS Board Telecom Meeting on 10-K		3/2/04	•		
Edgarize 10-Ks		3/2/04	•		
Genworth Final 10K to GE		TBD	•	•	
File 10-Ks (All Major Registrants)		3/4/04	•		
File DEF14A (proxy)		3/9/04	•		
Begin Mailing A/R		3/9/04	•		

## First and Second Quarter Corporate Reporting Data

### CDR Submissions/ Data requirements [Closing the Books]

Schedule Name(s)	Description (Contents)	Est. Due date - Q1	Est. Due date - Q2	Cons	C	
					Equity/ Cost - Penske Model - (A)	Equity/ Cost - SES Model - (B)
TRSY interest allocation		3/11/04	6/11/04	•	•	
MF System closes		3/14/04	6/14/04	•	•	
MTM to Biz on Livelink		3/14/04	6/14/04	•	•	
TRSY interest allocation to DPL—IA on Internet		3/15/04	6/15/04	•	•	
Corporate freight in DPL		3/15/04	6/15/04	•		
CTA Available on Internet		3/22/04	6/22/04	•	•	
APL File in DPL		3/23/04	6/23/04	•	•	
Payroll in DPL		3/23/04	6/23/04	•		
IBS billing cut-off		3/24/04	6/24/04	•		
CBSI Payroll to DPL		3/24/04	6/24/04	•		
A/P to DPL		3/24/04	6/24/04	•		
CDR AU/MU Affiliate Rec		3/25/04	6/25/04	•	•	
MTM Hedge entries via e-mail		3/25/04	6/25/04	•	•	
CDR AU/MU Affiliate Rec		3/25/04	6/25/04	•	•	
CDR AU/MU Affiliate Rec		3/26/04	6/26/04	•	•	
Fixed Assets to DPL		3/26/04	6/26/04	•		
IBS in DPL		3/26/04	6/26/04	•		
CDR AU/MU Affiliate Rec		3/27/04	6/27/04	•	•	
CDR AU/MU Affiliate Rec		3/28/04	6/28/04	•	•	
ATOM Smart Filter—CMS		3/28/04	6/28/04	•	•	
CDR AU/MU Affiliate Rec		3/30/04	6/30/04	•	•	
CDR AU/MU Affiliate Rec		3/30/04	6/30/04	•	•	
CDR AU/MU Affiliate Rec		3/30/04	6/30/04	•	•	
All AU files—11:59 p.m.		3/30/04	6/29/04	•	•	
CDR AU/MU Affiliate Rec		3/30/04	6/30/04	•	•	
CDR AU/MU Affiliate Rec		3/30/04	6/30/04	•	•	
CDR AU/MU Affiliate Rec		3/30/04	6/30/04	•	•	
Net Income to GE		4/1/04	7/1/04	•	•	
Full Trial Balance to GE		4/2/04	7/2/04	•	•	
TRSY Country rick sub account/current account rec due		4/9/04	7/9/04	•	•	

(A) If Blue Ridge is treated similar to Penske i.e it's own BSLA rolling up to the segment (Penske rolls to EM), then the \$'' for equity and cost would be required.

(B) If Blue Ridge is similar to SES i.e. an entry booked each month/ quarter by an operating unit (SES entry made by SFG in their own BSLA) then the \$'' for equity and cost columns would **NOT** be required, however, the necessary financial information to continue to account for the equity/ cost investment would be required.

(C) After prior consultation with Genworth, not less than 60 days prior to the date on which the investment in Genworth is first reported using the equity method, GE will advise Genworth whether to follow the Penske Model or the SES Model. Thereafter and so long as the investment in Genworth is reported using the equity method, at the request of either party to be made by such party no more frequently than once every 6 months, Genworth and GE will work together in good faith to address requested modifications of the reporting under the equity method.

Schedule Name(s)	Description (Contents)	Est. Due date - Q1	Est. Due date - Q2	Cons	Equity/ Cost - Penske Model - (A)		Equity/ Cost - SES Model - (B)	
FAS 133 template		3/31/04	6/30/04	•				
Acquisition / Disposition Information	Revenue and NI (Excel)	4/2/04	7/2/04	•				
Acquisition / Disposition Tracker	Acquisitions and Dispositions Closed in the Quarter (Excel)	4/2/04	7/2/04	•				
Acquisition / Disposition Webtool	Acquisition and Disposition Tracker (Webtool)	4/2/04	7/2/04	•				
DR019AS3.2	Roll Forward—Investment Securities	4/3/04	7/3/04	•				
DR107BL	Non Earning	4/3/04	7/3/04	•				
DR 106	Financing Receivables	4/3/04	7/3/04	•				
DR 171	Intangible Assets	4/3/04	7/3/04	•				
DR115REC	FAS115 Reconciliation	4/3/04	7/3/04	•				
Balance Sheet and P&L(Note)	Spreadsheet / Presentation Format	<b>D</b>	<b>D</b>		•			•
Key Drivers Analysis / Discussion (Note)		<b>D</b>	<b>D</b>		•			
DR4MGOP (FP&A)	Volume / Write Offs / Equity / Non-Earnings	4/3/04	7/3/04	•				

DR4FX (FP&A)	FX Revenue and NI	4/3/04	7/3/04	•
DR140 (FP&A)	Gains DR	4/3/04	7/3/04	•
WRI Non Earning (FP&A)	Non Earning > \$3MM	4/3/04	7/3/04	•
WRI—Comments	WRI—Gains, Other One-Offs, Other Tax	4/3/04	7/3/04	•
Unusual / Non-recurring Items >\$10MM	E-mail Submission	4/2/04	7/2/04	•
Cash flow Worksheet		4/3/04	7/3/04	•
WRI Non Earning (DR107BL)	Non Earning; WRI Non Earning (DR107BL)—Variance Commentary	4/4/04	7/4/04	•
WRI AFL	WRI Allowance for Losses—Variance Commentary	4/4/04	7/4/04	•
WRI DR019AS3.2	WRI Roll Forward—Investment Securities	4/4/04	7/4/04	•
WRI FAS 115 Rec (DR 115 Rec)	WRI FAS 115 Gains/losses Reconciliation—Variance Commentary	4/4/04	7/4/04	•
WRI Financing Receivables (DR 106)	WRI Financing Receivables (DR106) including roll forward for loans and leases—Variance Commentary	4/4/04	7/4/04	•
WRI Intangible Assets (DR 171)	WRI Intangible Assets (DR171)—Variance Commentary	4/4/04	7/4/04	•
WRI Invest Sec. RollForward (DR 109 ULA)	Roll Forward-Variance Commentary and ULA security Listing	4/4/04	7/4/04	•
DR019ULA	Unrealized Loss Aging	4/4/04	7/4/04	•
DR103	Insurance Liabilities, Reserves and Annuity Benefits—: Component details	4/4/04	7/4/04	•
DR—GECS Revenue	EIA	4/4/04	7/4/04	•
WRI Insurance Premiums	Insurance Premiums commentary	4/5/04	7/5/04	•
WRI Geographic Summary	Variance Commentary for all line items on a QTD basis	4/5/04	7/5/04	• •
WRI Insurance Receivables	Variance Commentary	4/5/04	7/5/04	•
WRI GECS Reveunes from Services	WRI—for GECS revenues from services	4/5/04	7/5/04	•
WRI—Component Detail—Insurance Liabilities (DR 103)	WRI—Component Detail of Insurance Liabilities, Reserves and Annuity Benefits—Variance Commentary	4/5/04	7/5/04	•

(D)—Under Equity Method the P&L, Balance Sheet, and Key Drivers will be due per the GE timeline as provided in the quarterly instructions.

(D)—Under Cost Method the P&L, Balance Sheet, and Key Drivers will be due per the Genworth quarterly SEC filing timelines.

124

#### MD&A and 10Q

Schedule Name(s)	Description (Contents)	Est. Due date	Est. Due date	Cons	Equity	Cost
WRI MD&A Balance Sheet Analysis	Variance Commentary for Balance Sheet	4/5/04	7/5/04	•		
DR—Cashflow (DBCFGECC/ GECS)	Cash flow DR	4/6/04	7/6/04	•		
WRI Cash Flow	Cash Flow Commentary	4/7/04	7/7/04	•		
WRI MD&A P&L Analysis	Variance Commentary for Income Statement—P&L	4/7/04	7/7/04	•		

**NOTE** Ongoing P&L and Balance Sheet and Key Drivers Comments Required Under Equity Method and Cost Method for Operational Management Oversight Purposes, In addition For Purposes of GE Bookkeeping

125

Schedule Name(s)	Description (Contents)	Est. Due date	Est. Due date	Cons	Equity	Cost
Draft 1 Circulated		4/12/04	7/12/04	•		
Comments on Draft 1		4/15/04	7/15/04	•		
Draft 2		4/15/04	7/15/04	•		
Business CEOs and CFOs SOX sign-off		4/19/04	7/19/04	•		
Comments on Draft 2		4/19/04	7/19/04	•		
Draft 3		4/19/04	7/19/04	•		
Draft 1 of Genworth 10Q to GE (If Applicable)		4/19/04	7/19/04	•	•	
Disclosure Committee 10-Q Review Meeting		4/21/04	7/21/04	•		
Comments on Draft 3		4/21/04	7/21/04	•		
Draft 4		4/21/04	7/21/04	•		
KSS Review		4/22/04	7/22/04	•		
Comments on Draft 4		4/22/04	7/22/04	•		
Draft 5		4/22/04	7/22/04	•		
Draft 2 of Genworth 10Q to GE (If Applicable)		4/23/04	7/23/04	•	•	
Audit Committee Meeting		4/24/04	7/24/04	•		
Final Genworth 10Q to GE (If Applicable)		4/29/04	7/29/04	•	•	

**NOTE** Ongoing P&L and Balance Sheet and Key Drivers Comments Required Under Equity Method and Cost Method for Operational Management Oversight Purposes, In

Schedule 4.2(b)

**Third Quarter Corporate Reporting Data**

Schedule Name(s)	Description (Contents)	Est. Due date	Cons	Equity/ Cost - Penske Model - (A)	Equity/ Cost - SES Model - (B)
TRSY interest allocation		9/10/04	•	•	
MF System closes		9/11/04	•	•	
MTM to Biz on Livelink		9/20/04	•	•	
TRSY interest allocation to DPL—IA on Internet		9/20/04	•	•	
Corporate freight in DPL		9/20/04	•		
CTA Available on Internet		9/20/04	•	•	
APL File in DPL		9/20/04	•	•	
Payroll in DPL		9/20/04	•		
IBS billing cut-off		9/20/04	•		
CBSI Payroll to DPL		9/20/04	•		
A/P to DPL		9/21/04	•		
CDR AU/MU Affiliate Rec		9/24/04	•	•	
MTM Hedge entries via e-mail		9/24/04	•	•	
CDR AU/MU Affiliate Rec		9/24/04	•	•	
CDR AU/MU Affiliate Rec		9/24/04	•	•	
Fixed Assets to DPL		9/24/04	•		
IBS in DPL		9/24/04	•		
CDR AU/MU Affiliate Rec		9/25/04	•	•	
CDR AU/MU Affiliate Rec		9/25/04	•	•	
ATOM Smart Filter—CMS		9/25/04	•	•	
CDR AU/MU Affiliate Rec		9/26/04	•	•	
CDR AU/MU Affiliate Rec		9/26/04	•	•	
CDR AU/MU Affiliate Rec		9/26/04	•	•	
All AU files—11:59 p.m.		9/28/04	•	•	
CDR AU/MU Affiliate Rec		9/28/04	•	•	
CDR AU/MU Affiliate Rec		9/28/04	•	•	
CDR AU/MU Affiliate Rec		9/28/04	•	•	
Net Income to GE		9/30/04	•	•	
Full Trial Balance to GE		10/1/04	•	•	
TRSY Country rick sub account/current account rec due		10/8/04	•	•	

(A) If Blue Ridge is similar to Penske i.e. it's own BSLA rolling up to the segment (Penske rolls to EM), then the "4" for equity and cost would be required.

(B) If Blue Ridge is similar to SES i.e. an entry booked each month/ quarter by an operating unit (SES entry made by SFG in their own BSLA) then the "4" for equity and cost columns would NOT be required, however, the necessary financial information to continue to account for the equity/ cost investment would be required.

(C) After prior consultation with Genworth, not less than 60 days prior to the date on which the investment in Genworth is first reported using the equity method, GE will advise Genworth whether to follow the Penske Model or the SES Model. Thereafter and so long as the investment in Genworth is reported using the equity method, at the request of either party to be made by such party no more frequently than once every 6 months, Genworth and GE will work together in good faith to address requested modifications of the reporting under the equity method.

Schedule Name(s)	Description (Contents)	Est. Due date	Cons	Equity	Cost
WRI Geographic Summary	Confirmation of numeric data via e-mail	10/1/04	•	•	
FAS 133 template		10/1/04	•		
Acquisition/ Disposition Information	Revenue and NI (Excel)	10/3/04	•		
Acquisition / Disposition Tracker	Acquisitions and Dispositions Closed in the Quarter (Excel)	10/3/04	•		
Acquisition / Disposition Webtool	Acquisition and Disposition Tracker (Webtool)	10/3/04	•		
DR—Cashflow (DBCFGEC/ GECS)		10/3/04	•		
Balance Sheet and P&L(Note)	Spreadsheet / Presentation Format	<b>D</b>	<b>D</b>	•	•
Key Drivers Analysis / Discussion (Note)		<b>D</b>	<b>D</b>	•	
DR4MGOP (FP&A)	Volume / Write Offs / Equity / Non-Earnings	10/3/04	•		

DR4FX (FP&A)	FX Revenue and NI (Excel)	10/3/04	•
DR140 (FP&A)	Gains DR	10/3/04	•
WRI Non Earning (FP&A)	Non Earning > \$3MM	10/3/04	•
WRI Comments	WRI—Gains, Other One-Offs, Other Tax	10/3/04	•
Unusual / Non-Recurring Items >\$10MM	E-mail Submission	10/3/04	•
DR107BL	Non Earning	10/4/04	•
WRI Cash Flow		10/4/04	•
DR 106	Financing Receivables	10/5/04	•
DR 171	Intangible Assets	10/5/04	•
WRI Non Earning (DR107BL)	Non Earning; WRI Non Earning (DR107BL)—Variance Commentary	10/5/04	•
WRI AFL	WRI Allowance for Losses—Variance Commentary	10/5/04	•
WRI FAS 115 Rec (DR 115 Rec)	WRI FAS 115 Gains/losses Reconciliation—Variance Commentary	10/5/04	•
WRI Financing Receivables (DR 106)	WRI Financing Receivables (DR106) including roll forward for loans and leases—Variance Commentary	10/5/04	•
WRI Intangible Assets (DR 171)	WRI Intangible Assets (DR171)—Variance Commentary	10/5/04	•
WRI Invest Sec. RollForward (DR 109 ULA)	Roll Forward-Variance Commentary and ULA security Listing	10/5/04	•
DR—Earned Income	EIA	10/5/04	•
WRI—Earned Income	EIA	10/5/04	•
WRI Geographic Summary	Variance Commentary for all line items on a QTD basis	10/5/04	• •
DR115REC	FAS115 Reconciliation	10/5/04	•
DR019ULA	Unrealized Loss Aging	10/5/04	•
DR103	Insurance Liabilities, Reserves and Annuity Benefits—Component Details	10/5/04	•

(D)—Under Equity Method the P&L, Balance Sheet, and Key Drivers will be due per the GE timeline as provided in the quarterly instructions.

(D)—Under Cost Method the P&L, Balance Sheet, and Key Drivers will be due per the Genworth quarterly SEC filing timelines.

Schedule Name(s)	Description (Contents)	Est. Due date	Cons	Equity	Cost
WRI MD&A Balance Sheet Analysis	Variance Commentary for Balance Sheet	10/11/04	•		
WRI MD&A P&L Analysis	Variance Commentary for Income Statement—P&L	10/12/04	•		
WRI Investment Sec. Realized Gains / Losses (DR 019 AS 3.2)	WRI Realized Gains/Losses—Variance Commentary and Impairment Listing	10/30/04	•		
WRI Insurance Liabilities Reserve	WRI Business Details—Variance Commentary	10/30/04	•		
DR106CM	Financing Receivables—Contractual Maturities	10/30/04	•		
DR106FL	Financing Receivables—Financing Leases	10/30/04	•		
WRI—Insurance Premiums	WRI—Insurance Premiums	10/30/04	•		
WRI—Inv. Sec. Component Detail	WRI Component details of Investment Securities	10/30/04	•		
WRI Financing Leases	WRI Financing Leases(DR106FL)—Variance Commentary	10/30/04	•		
WRI Insurance Receivables	Variance Commentary	10/30/04	•		
WRI Invest Sec business detail	WRI—Business Details—Variance Commentary	10/30/04	•		
WRI—Component Detail—Insurance Liabilities (DR 103)	WRI—Component Detail of Insurance Liabilities, Reserves and Annuity Benefits—Variance Commentary	10/30/04	•		
WRI—Financial Guarantees and Credit Life (DR 103)	WRI—Financial Guarantees and Credit Life—Variance Commentary	10/30/04	•		
WRI—Insurance Losses	WRI—Insurance Losses—Variance Commentary	10/30/04	•		
WRI—Unpaid Claims Rollforward (DR 103)	WRI—Insurance Reserves; Unpaid Claims and Claim Adjustment Expenses—Variance Commentary	10/30/04	•		
WRI Financing Rec. Contractual Maturities (DR 106)	WRI Financing Receivables—Contractual maturities(DR106CM)—Variance Commentary	10/30/04	•		
WRI Invest. Sec Contractual Maturities (DR 019 AS 3)	WRI Contractual Maturities Debt Securities—Variance Commentary	10/30/04	•		
DR019AS3	Contractual Maturities—Investment Securities Assets 3	10/30/04	•		
DR103	Insurance Liabilities, Reserves and Annuity Benefits —:1) Average yield used in Computation of future benefits 2)Roll Forward—Unpaid claims/claim adjustment expenses 3) Financial Guarantees and credit life risk 4) Property and casualty operations	10/30/04	•		
DR019AS3.2	Roll Forward—Investment Securities Assets 3.2	10/30/04	•		
WRI—ELTO / PP&E (DR180)	PPE & ELTO (DR180)—Variance Commentary	11/15/04	•		
DR—Accounts Payable (DR 307)	A/P	11/15/04	•		
DR—Other Liabilities (DR XXX)	OTL	11/15/04	•		
DR180	ELTO & PP&E	11/15/04	•		
WRI—Accounts Payable (DR 307)	A/P	11/15/04	•		
WRI—Other Liabilities	OTL	11/15/04	•		
DR—Non-Cancelable Leases	NCL	11/15/04	•		

DR—Op & Admin	OPA	11/15/04	•	
DR—Other Receivables	OTR	11/15/04	•	
DR113	Other Assets	11/15/04	•	•
WRI—Non-Cancelable Leases	NCL	11/15/04	•	
WRI—Op & Admin	OPA	11/15/04	•	
WRI—Other Receivables	OTR	11/15/04	•	
DR030FI	Financial Instruments	11/15/04	•	
WRI—Other Assets (DR 113)	WRI Other Assets (DR113) including roll forward for Associated Companies and Real Estate—Variance Commentary	11/15/04	•	•
WRI—Financial Instruments (DR030FI)	WRI Financial Instruments (DR 030FI)—Variance Commentary	11/15/04	•	
4				
WRI—Restricted Net Assets (DR 119RNA)	WRI—Restricted Net Assets	11/15/04	•	
DR119RNA	Net Restricted Assets	11/15/04	•	

**NOTE** Ongoing P&L and Balance Sheet and Key Drivers Comments Required Under Equity Method and Cost Method for Operational Management Oversight Purposes, In addition For Purposes of GE Bookkeeping

### MD&A and 10Q

Schedule Name(s)	Description (Contents)	Est. Due date	Cons	Equity	Cost
Draft 1 Circulated		10/12/04	•		
Comments on Draft 1		10/15/04	•		
Draft 2		10/15/04	•		
Draft 1 of Genworth 10Q to GE		10/19/04	•	•	
Business CEOs and CFOs SOX sign-off		10/19/04	•		
Comments on Draft 2		10/19/04	•		
Draft 3		10/19/04	•		
Disclosure Committee 10-Q Review Meeting		10/21/04	•		
Comments on Draft 3		10/21/04	•		
Draft 4		10/21/04	•		
KSS Review		10/22/04	•		
Comments on Draft 4		10/22/04	•		
Draft 5		10/22/04	•		
Draft 2 of Genworth 10Q to GE		10/23/04	•	•	
Audit Committee Meeting		10/24/04	•		
Final Genworth 10Q to GE		10/29/04	•	•	

### Schedule 4.3

#### FP&A Reports

Schedule Name(s)	Description (Contents)	Cons	Equity (A)	Cost - (B)
DR70PGEC—Business/Operating Level	P&L and Balance Sheet Details for the Estimate Total Assets, Gross Revenues, IBIT, Provision for Taxes, Business Share Allocation, Earnings Unconsolidated Affiliates, Extraordinary Gains/Losses, Net Income, Total Write-offs, Securitization (NI, Pre Tax Income, Assets)	•		
Estimated P&L and Balance Sheet	Replaces DR's when in Equity Method; will use estimate in order to forecast income associated with the equity investment		•	
Acquisition and Disposition Data	Revenue and NI from Acquisitions/Dispositions (Excel Template)	•		
FIN46 SPE Data	Assets and P&L Estimates relating to FIN46 (Excel Template)	•		
Variance Analysis Comments & Key Drivers and Net Income Walk Analysis	WRI / Excel	•	•	
Rooftop Spending; Rooftop Savings	Excel Template	•		

**Notes:**

Estimated Due Date: Session II is Generally Due Mid—October

(A)—Under Equity Method the P&L, Balance Sheet, and Key Drivers will be due per the GE timeline as provided in the quarterly instructions.

(B)—Under Cost Method the P&L, Balance Sheet, and Key Drivers will be due per the Genworth quarterly SEC filing timelines.

131

**Schedule 4.3 FP&A Reports (SRO)**

<u>Schedule Name(s)</u>	<u>Description (Contents)</u>	<u>Cons</u>	<u>Equity (A)</u>	<u>Cost - (B)</u>
DR95GECS	P&L and Balance Sheet Details for the Estimate	•		
	Total Assets, Gross Revenues, IBIT, Provision for Taxes,	•		
	Business Share Allocation, Earnings Unconsolidated Affiliates, Extraordinary Gains/Losses, Net Income, Total Write-offs, Securitization (Net Income, Pre Tax Income, Assets)			
Estimated P&L and Balance Sheet	Replaces DR's when in Equity Method; will use estimate in order to forecast income associated with the equity investment	•		
Acquisition and Disposition Estimate	Revenue and NI from Acquisitions/Dispositions (Excel Template)	•		
WRI Risks and Opportunities	WRI Comments of Risks and Opportunities	•		
NI Variance Analysis Comments	Consolidated: WRI Comments for NI Variance Elements; Equity Method: Spreadsheet Comments	•	•	
Key Assumptions Comments	Consolidated: WRI Comments for NI Variance Elements; Equity Method: Spreadsheet Comments	•	•	
FIN46 SPE Data	Assets and P&L Estimates relating to FIN46 (Excel Template)	•		

**Notes:**

Estimated Due Date: SRO estimates take place 5 times each year; Estimated timeframes are  
Late February, Late May, Late August, Mid October and Mid November

NI Variance Analysis and Key Assumptions Under equity method these will not be completed in WRI, but we will  
need to see the key drivers analysis to accompany the estimate

(A)—Under Equity Method the P&L, Balance Sheet, and Key Drivers will be due per the GE timeline as provided in the quarterly instructions.

(B)—Under Cost Method the P&L, Balance Sheet, and Key Drivers will be due per the Genworth quarterly SEC filing timelines.

132

**Schedule 4.3 FP&A Reports (S1)****FP&A—Data requirements for Session I**

<u>Schedule Name(s)</u>	<u>Description (Contents)</u>	<u>Cons</u>	<u>Equity (A)</u>	<u>Cost - (B)</u>
DR70LGEC—Business/Operating Level	P&L and Balance Sheet Details for the Estimate	•		
	Total Assets, Gross Revenues, IBIT, Provision for Taxes,	•		
	Business Share Allocation, Earnings Unconsolidated Affiliates, Extraordinary Gains/Losses, Net Income, Total Write-offs, Securitization (NI, Pre Tax Income, Assets)			
Estimated P&L and Balance Sheet	Replaces DR's when in Equity Method; will use estimate in order to forecast income associated with the equity investment		•	
Acquisition and Disposition Data	Revenue and NI from Acquisitions/Dispositions (Excel Template)	•		
FIN46 SPE Data	Assets and P&L Estimates relating to FIN46 (Excel Template)	•		
Variance Analysis Comments & Key Drivers and Net Income Walk Analysis	WRI / Excel	•	•	

**Notes:**

Estimated Due Date: Session 1 is Generally Due during Late 2Q/Early 3Q



(A)—Under Equity Method the P&L, Balance Sheet, and Key Drivers will be due per the GE timeline as provided in the quarterly instructions.  
 (B)—Under Cost Method the P&L, Balance Sheet, and Key Drivers will be due per the Genworth quarterly SEC filing timelines.

**Schedule 4.3 FP&A Reports (Op Plan)**

**FP&A—Data requirements for Op Plan**

Schedule Name(s)	Description (Contents)	Cons	Equity (A)	Cost - (B) (C)
DR70PGEC—Business/Operating Level	P&L and Balance Sheet Details for the Estimate	•		
	Total Assets, Gross Revenues, IBIT, Provision for Taxes,	•		
	Business Share Allocation, Earnings Unconsolidated Affiliates, Extraordinary Gains/Losses, Net Income, Total Write-offs, Securitization (NI, Pre Tax Income, Assets)			
Estimated P&L and Balance Sheet	Replaces DR's when in Equity Method; will use estimate in order to forecast income associated with the equity investment		•	•
Acquisition and Disposition Data	Revenue and NI from Acquisitions/Dispositions (Excel Template)	•		
FIN46 SPE Data	Assets and P&L Estimates relating to FIN46 (Excel Template)	•		
Variance Analysis Comments & Key Drivers and Net Income Walk Analysis	WRI / Excel	•	•	

**Notes:**

Estimated Due Date: Op Plan is Generally Due the Third Week in January

(A)—Under Equity Method the P&L, Balance Sheet, and Key Drivers will be due per the GE timeline as provided in the quarterly instructions.  
 (B)—Under Cost Method the P&L, Balance Sheet, and Key Drivers will be due per the Genworth quarterly SEC filing timelines.  
 (C)—Applicable as long as GE owns at least 5% of Genworth common stock.

**Schedule 4.8**

**Monthly Financial Information**

**GE Capital Services**

**Data Parking Lot (DPL)/Corporate Data Repository (CDR)**

**2004 Monthly/Quarterly Closing—File Submission Due Dates**

**GE Capital Services Monthly Close is the last Fiscal Saturday, Not the Last Sunday as on the GE Fiscal Calendar**

**Reminder, the dates below may be superceded by the Quarterly Closing Instructions**

Month	AU	MU	MO	MF	AL	ML	
January	N/A	Feb 5 by 11:59 PM	Feb 6 by 11:59 PM	Feb 6 by 11:59 PM	N/A	Feb 6 by 11:59 PM	
February	N/A	Mar 4 by 11:59 PM	Mar 5 by 11:59 PM	Mar 5 by 11:59 PM	N/A	Mar 5 by 11:59 PM	
March	a	Mar 30 by 11:59 PM	Mar. 28 by 11:59 PM	Apr 2 by 11:59 PM	Apr 2 by 11:59 PM	Apr 2 by 11:59 PM	N/A
	b	Mar 31 by Noon	Mar. 28 by 11:59 PM	Apr 2 by 11:59 PM	Apr 2 by 11:59 PM	Apr 2 by 11:59 PM	N/A
April	N/A	May 6 by 11:59 PM	May 7 by 11:59 PM	May 7 by 11:59 PM	N/A	May 7 by 11:59 PM	
May	N/A	Jun 3 by 11:59 PM	Jun 4 by 11:59 PM	Jun 4 by 11:59 PM	N/A	Jun 4 by 11:59 PM	
June	a	June 29 by 11:59 PM	June 27 by 11:59 PM	Jul 2 by 11:59 PM	Jul 2 by 11:59 PM	Jul 2 by 11:59 PM	N/A
	b	June 30 by Noon	June 27 by 11:59 PM	Jul 2 by 11:59 PM	Jul 2 by 11:59 PM	Jul 2 by 11:59 PM	N/A
July	N/A	Aug 5 by 11:59 PM	Aug 6 by 11:59 PM	Aug 6 by 11:59 PM	N/A	Aug 6 by 11:59 PM	
August	N/A	Sep 2 by 11:59 PM	Sep 3 by 11:59 PM	Sep 3 by 11:59 PM	N/A	Sep 3 by 11:59 PM	
September	a	Sep 28 by 11:59 PM	Sep 26 by 11:59 PM	Oct 1 by 11:59 PM	Oct 1 by 11:59 PM	Oct 1 by 11:59 PM	N/A
	b	Sept 29 by Noon	Sep 26 by 11:59 PM	Oct 1 by 11:59 PM	Oct 1 by 11:59 PM	Oct 1 by 11:59 PM	N/A

October	N/A	Nov 4 by 11:59 PM	Nov 5 by 11:59 PM	Nov 5 by 11:59 PM	N/A	Nov 5 by 11:59 PM
November	N/A	Dec 2 by 11:59 PM	Dec 3 by 11:59 PM	Dec 3 by 11:59 PM	N/A	Dec 3 by 11:59 PM
December	Jan 5 by 6:00 PM	Jan 1 by 11:59 PM	Jan 7 by 8:00 AM	Jan 7 by 8:00 AM	Jan 7 by 8:00 AM	N/A

a- Non 3 day close businesses                      b- 3 day close businesses

**Schedule 5.2(d)**

**Transaction Documents – Genworth Indemnification**

- Asset Management Services Agreement**
- Derivative Management Services Agreement**
- Mortgage Services Agreement**
- Outsourcing Services Separation Agreement**
- Registration Rights Agreement**
- Tax Matters Agreement**
- Transition Services Agreement**
- Long-Term Care Retrocession Agreements**
- Structured Settlement Reinsurance Agreements**
- Variable Annuity Reinsurance Agreements**
- Medicare Supplement Reinsurance Agreement**
- European Transition Services Agreement**
- International Tax Matters Agreements**
- French Transfer Agreement**
- Investment Management Agreements**
- Trust Agreements**
- Capital Maintenance Agreement**
- Business Services Agreement**
- UFLIC ESG Services Agreement**
- JLIC Recapture Agreement**

**Schedule 5.3(c)**

**Transaction Documents – GE Indemnification**

- Asset Management Services Agreement**
- Derivative Management Services Agreement**
- Mortgage Services Agreement**
- Outsourcing Services Separation Agreement**
- Registration Rights Agreement**
- Tax Matters Agreement**
- Transition Services Agreement**
- Long-Term Care Retrocession Agreements**
- Structured Settlement Reinsurance Agreements**
- Variable Annuity Reinsurance Agreements**
- Medicare Supplement Reinsurance Agreement**
- European Transition Services Agreement**
- International Tax Matters Agreements**
- French Transfer Agreement**
- Investment Management Agreements**
- Trust Agreements**
- Capital Maintenance Agreement**
- Business Services Agreement**
- UFLIC ESG Services Agreement**
- JLIC Recapture Agreement**

Insurance Coverage

**General Electric Company  
Global Insurance Programs  
Property / Casualty**

See worksheet attached entitled Blue Ridge 2004 Insurance Schedule

138

---

## Schedule 6.5(b)

GE Contracts

139

---

## Schedule 6.10

Continuation of Certain Arrangements

- At Genworth's request, General Electric Capital Services, Inc. shall use commercially reasonable terms to renew the Credit Derivative Transaction entered into with Deutsche Bank AG London Branch dated as of March 13, 2002 relating to Brookfield Life Assurance Company's USD 400,000,000 Floating Rate Note Program Series 2002-A-1 for a minimum of three additional five year periods on terms and conditions that are substantially similar to the expiring terms.
- GE Capital International Holdings Corporation's continuing obligations (relating to discussions with tax authorities and general document access) under the Project Talon acquisition agreement (pursuant to which Barclays Bank PLC's Guernsey captive mortgage insurer was acquired - since renamed GE Mortgage Insurance (Guernsey) Limited)
- GEMICO US Undertaking Agreement between GECC and International Business Machine Corporation dated August 3, 1999 (IBM will upon notice make available to the Superintendent of Financial Institution of Canada for inspection at the Facilities all data or information being processed or maintained by it in respect of the daily insurance operation of GE Capital Mortgage Insurance Company (Canada))

140

---

## Schedule 6.12(b)(i)(B)

Business Activities

- Acquiring any mortgage loan portfolio from a third party, extending loans to customers without regard to the ratio of the principal amount of the loan to the value of the property against which it is secured or where the loan is secured by a second or subsequent mortgage.
- Providing a guarantee (or similar arrangement) in respect of any mortgage securities or mortgage loan portfolios that are sold to a third party (i) by GE or any Affiliate of GE, or (ii) by another third party that purchased such securities or loans from GE or any Affiliate of GE.
- Private label long-term care insurance services (e.g., business of ERC Long Term Care Solutions, Inc.)
- Private label and turnkey services for primary insurers (including product development, administration and reinsurance)
- Life insurance and similar products marketed or underwritten by the PMG business (e.g., "Instant Issue Life Insurance, Juvenile Life, Whole Life), including burial policies.
- Commercial auto insurance

**Communications/IR**

Covered by Master Agreement

**EHS**

Covered by GE Integrity Policy – See below under Legal/Compliance

**Facilities**

Real Estate Services Operation (RESO) Process Documentation (Operational Processes)

**Finance/Accounting**

GEFA Travel and Living Policy

**Governance**

Covered by Master Agreement and Genworth Charter and Bylaws

**HR**

- Existing local Genworth programs, practices and policies pursuant to the Employee Matters Agreement and as amended from time to time consistent with the Employee Matters Agreement
- Employee Relations Bulletins (e.g., absence payments, emergency aid, Continuity of Service Rules, etc.)
- Travel and Living Policy
- Employment Data Protection Standards
- Contingent Worker Standards and Guidelines
- Immigration and Cross Border Mobility Practices
- GEFA Pre-hire/Sourcing Background Checking
- Employee Innovation and Propriety Information Protocol
- ADR Process (DRP or Resolve)

**IP**

Interim Identity Guidelines (until such time as Exhibit B (Standards and Guidelines) to the Transitional Trademark License Agreement is completed and attached to the Transitional Trademark License Agreement)

**Legal/Compliance**

- The policies summarized in the compliance guide entitled “Integrity: the Spirit and Letter of Our Commitment,” the full text of which are published in their entirety on the website [integrity.ge.com](http://integrity.ge.com) and any subsequent amendments or revisions thereto (Collectively “the Spirit and Letter Policies”)
- The implementing procedures for the Spirit and Letter Policies
- The compliance program requirements contained in the publication entitled “Compliance and Integrity: A Guide for Leaders”

- 
- The Security and Crisis Management Policy published at [Integrity.ge.com](http://Integrity.ge.com)
  - The Document Management Procedures published at [Integrity.ge.com](http://Integrity.ge.com)
  - Those Management Procedures published at [Integrity.ge.com](http://Integrity.ge.com) that are deemed by the GE Policy Compliance Review Board or its designee to apply to the operations of Genworth
  - The requirements for reporting significant litigation quarterly and annually and trials as required by the Senior Counsel for Litigation and Legal Policy
  - Any compliance requirements established by the GE Policy Compliance Review Board
  - Procedures for reporting potential conflicts of interest, including the requirements for periodic surveys of employees to detect potential conflicts of interest
  - Requirements for the monitoring of securities transactions by transaction restricted employees
  - Procedures governing the reporting of concerns by lawyers - in accordance with Section 307 of the Sarbanes-Oxley Act
  - Procedures for reporting concerns to the Board of Directors — in accordance with Section 301 of the Sarbanes-Oxley Act and the listing requirements of the New York Stock Exchange
  - Amended or forthcoming versions of all of these policies/procedures
  - The Genworth PAC will coordinate all solicitation and disbursement activities with the GEPAC Administrator or the Secretary of GEPAC, and ensure that it complies with aggregate disbursement limits set by Federal Election Commission rules and campaign finance statutes.
  - With respect to solicitation activities in 2004 (or any year in which an employee may have contributed to GEPAC directly or through

payroll deduction), GenworthPAC and GEPAC must ensure that payroll and check contributions do not in combination exceed individual PAC contribution limits (currently \$5,000 per year.)

- With respect to disbursements, GenworthPAC must submit contribution requests to the GEPAC Administrator to determine the remaining amount which may be contributed, and determine which entity among the affiliated PACs will make the contribution. GenworthPAC limits are subject to the full 6 year cycle of US Senate races and the 2 year cycle for House races.

### **Risk**

Policy 5.0 approval authorities for new business

Policy 6.0 for portfolio/product management processes

### **Sourcing/IT**

Corporate Security Policy

Corporate Data Privacy Policy

IT Policies related to maintaining adequate disclosure controls under the Sarbanes-Oxley Act

### **Tax**

Covered by Tax Matters Agreements and International Tax Matters Agreements

### **Treasury**

Match Funding Policy

Debt and Credit Support Obligations Policy

143

---

Cash Management Policies: Paper Remittance and Disbursements Policy; Overnight Investment/Borrowing Policy; Electronic Funds Transfers Policy; Obtaining and Maintaining Policy; Opening, Closing and Amending Bank Accounts Policy

Capital Investments Policy (covered by GE Policy Info 30.6)

Foreign Exchange Policy

Commodity Hedging policy

Anti-Money Laundering Policy

Derivatives Policy

OFAC Policy

Compliance Policies Relating to Negative Pledge Covenant and Other Covenants in Debt Documentation

144

---

## **Schedule 7.1**

### **Transaction Documents – Dispute Resolution**

Transition Matters Agreement

Derivatives Management Services Agreement

Liability and Portfolio Management Agreement

Mortgage Services Agreement

Outsourcing Services Separation Agreement

Tax Matters Agreement

Long-Term Care Retrocession Agreements

Structured Settlement Reinsurance Agreements

Variable Annuity Reinsurance Agreements

Medicare Supplement Reinsurance Agreement

Business Services Agreement

Investment Management Agreements

Transitional Trademark Licensing Agreement

FACL Reinsurance Agreement

FICL Reinsurance Agreement

International Tax Matters Agreements

European Transition Services Agreement

Form of Liability and Portfolio Asset Management Agreements

French Reinsurance Agreement

UK Transfer Plan

## TRANSITION SERVICES AGREEMENT

dated , 2004

among

GENERAL ELECTRIC COMPANY,  
GENERAL ELECTRIC CAPITAL CORPORATION,  
GEI, INC.,  
GE FINANCIAL ASSURANCE HOLDINGS, INC.,  
GNA CORPORATION,  
GE ASSET MANAGEMENT INCORPORATED,  
GENERAL ELECTRIC MORTGAGE HOLDINGS LLC  
and  
GENWORTH FINANCIAL, INC.

---

Article I DEFINITIONS

SECTION 1.01. Certain Defined Terms  
SECTION 1.02. Other Terms

Article II SERVICES AND TERMS

SECTION 2.01. Services; Scope  
SECTION 2.02. Conversion Services  
SECTION 2.03. GE Services Manager  
SECTION 2.04. Company Services Manager  
SECTION 2.05. Performance and Receipt of Services

Article III OTHER ARRANGEMENTS

SECTION 3.01. Vendor Agreements  
SECTION 3.02. Six Sigma Programs.

Article IV ADDITIONAL AGREEMENTS

SECTION 4.01. Leases  
SECTION 4.02. Computer-Based Resources  
SECTION 4.03. GRC Matters  
SECTION 4.04. Consents  
SECTION 4.05. Access  
SECTION 4.06. Management Consulting Services

Article V COSTS AND DISBURSEMENTS; PAYMENTS

SECTION 5.01. Costs and Disbursements; Payments

Article VI STANDARD FOR SERVICE; COMPLIANCE WITH LAWS

SECTION 6.01. Standard for Service  
SECTION 6.02. Compliance with Laws

Article VII INDEMNIFICATION; LIMITATION ON LIABILITY

SECTION 7.01. Limited Liability of a Provider  
SECTION 7.02. Indemnification by Each Provider  
SECTION 7.03. Indemnification by Each Recipient  
SECTION 7.04. Indemnification Procedures  
SECTION 7.05. Limitation on Liability  
SECTION 7.06. Liability for Payment Obligations  
SECTION 7.07. Exclusions

Article VIII DISPUTE RESOLUTION

SECTION 8.01. Applicable Law  
SECTION 8.02. Dispute Resolution

Article IX TERMINATION

SECTION 9.01. Termination

<a href="#">SECTION 9.02.</a>	<a href="#">Effect of Termination</a>
<a href="#">SECTION 9.03.</a>	<a href="#">Survival</a>
<a href="#">SECTION 9.04.</a>	<a href="#">Business Continuity: Force Majeure</a>

## Article X GENERAL PROVISIONS

<a href="#">SECTION 10.01.</a>	<a href="#">Independent Contractors</a>
<a href="#">SECTION 10.02.</a>	<a href="#">Subcontractors</a>
<a href="#">SECTION 10.03.</a>	<a href="#">Additional Services: Books and Records</a>
<a href="#">SECTION 10.04.</a>	<a href="#">Confidential Information</a>
<a href="#">SECTION 10.05.</a>	<a href="#">Notices</a>
<a href="#">SECTION 10.06.</a>	<a href="#">Taxes</a>
<a href="#">SECTION 10.07.</a>	<a href="#">Regulatory Approval and Compliance</a>
<a href="#">SECTION 10.08.</a>	<a href="#">Severability</a>
<a href="#">SECTION 10.09.</a>	<a href="#">Entire Agreement</a>
<a href="#">SECTION 10.10.</a>	<a href="#">Assignment: No Third-Party Beneficiaries</a>
<a href="#">SECTION 10.11.</a>	<a href="#">Amendment</a>
<a href="#">SECTION 10.12.</a>	<a href="#">Rules of Construction</a>
<a href="#">SECTION 10.13.</a>	<a href="#">Counterparts</a>
<a href="#">SECTION 10.14.</a>	<a href="#">No Right to Set-Off</a>

## SCHEDULES

<a href="#">SCHEDULE A</a>	<a href="#">GE Services</a>
<a href="#">SCHEDULE A-1</a>	<a href="#">Investment IT Services</a>
<a href="#">SCHEDULE B</a>	<a href="#">Company Services</a>
<a href="#">SCHEDULE C-1</a>	<a href="#">Leased Facilities (GE to Company)</a>
<a href="#">SCHEDULE C-2</a>	<a href="#">Leased Facilities (Company to GE)</a>
<a href="#">SCHEDULE D</a>	<a href="#">GRC Projects</a>
<a href="#">SCHEDULE E</a>	<a href="#">Management Consulting Services</a>
<a href="#">SCHEDULE F</a>	<a href="#">Business Associate Addendum</a>

This Transition Services Agreement, dated \_\_\_\_\_, 2004 (this "Agreement"), is made by and among GENERAL ELECTRIC COMPANY, a New York corporation ("General Electric"), GENERAL ELECTRIC CAPITAL CORPORATION, a Delaware corporation ("GE Capital"), GEI, INC., a Delaware corporation ("GEI"), GE FINANCIAL ASSURANCE HOLDINGS, INC., a Delaware corporation ("GEFAHI"), GNA CORPORATION, a Washington corporation ("GNA"), GE ASSET MANAGEMENT INCORPORATED, a Delaware corporation ("GEAM"), GENERAL ELECTRIC MORTGAGE HOLDINGS LLC, a North Carolina limited liability company ("GEMH"), and GENWORTH FINANCIAL, INC., a Delaware corporation ("Genworth").

## RECITALS

- A. General Electric, GE Capital, GEI, GEFAHI and Genworth entered into a Master Agreement, dated as of the date hereof (the "Master Agreement").
- B. It is contemplated by the Master Agreement that after the date hereof (i) General Electric will continue to provide, or cause to continue to be provided, certain administrative and support services and other assistance to Genworth (together with its Subsidiaries, including GNA and GEMH, collectively hereinafter referred to as the "Company") on a transitional basis and in accordance with the terms and subject to the conditions set forth herein, and (ii) the Company will continue to provide, or cause to continue to be provided, certain administrative and support services and other assistance to General Electric (together with its Subsidiaries, including GE Capital, GEFAHI, and GEAM (but excluding Genworth and its Subsidiaries), collectively hereinafter referred to as "GE") on a transitional basis and in accordance with the terms and subject to the conditions set forth herein.

NOW, THEREFORE, in consideration of the foregoing and the mutual agreements contained herein and for other good and valuable consideration, the receipt and adequacy of which are hereby acknowledged, the parties hereto hereby agree as follows:

## ARTICLE I

### DEFINITIONS

SECTION 1.01. Certain Defined Terms. Unless otherwise defined herein, all capitalized terms used herein shall have the same meaning as in the Master Agreement.

The following capitalized terms used in this Agreement shall have the meanings set forth below:

"Cross License" means the Intellectual Property Cross License, dated as of the date hereof, by and between General Electric and Genworth.

"European Transition Services Agreement" means the Transitional Services Agreement, dated as of the date hereof, between Financial Insurance Group Services Limited and GE Life Services Limited.

"GEFAHI Divested Companies" means the following companies and their associated business divested by GEFAHI on or about August 29, 2003: (i) GE Property and Casualty Insurance Company; (ii) GE Casualty Insurance Company; (iii) GE Indemnity Insurance Company; (iv) GE Auto & Home Insurance Company, (v) Bayside Casualty Insurance Company; (vi) GE Financial Assurance Japan Ltd.; (vii) GE Edison Life Insurance Company; (viii) Toho Shinyo Hosho Company; and (ix) GE Edison Services Company.

"Information Systems" means computing, telecommunications or other digital operating or processing systems or environments, including, without



limitation, computer programs, data, databases, computers, computer libraries, communications equipment, networks and systems. When referenced in connection with Services, Information Systems shall mean the Information Systems accessed and/or used in connection with the Services.

“Intellectual Property” means all of the following, whether protected, created or arising under the laws of the United States or any other foreign jurisdiction: (i) patents, patent applications (along with all patents issuing thereon), statutory invention registrations, divisions, continuations, continuations-in-part, substitute application of the foregoing and any extensions, reissues, restorations and reexaminations thereof, and all rights therein provided by international treaties or conventions, (ii) copyrights, mask work rights, database rights and design rights, whether or not registered, published or unpublished, and registrations and applications for registration thereof, and all rights therein whether provided by international treaties or conventions or otherwise, (iii) trademarks, service marks, trade dress, logos and other identifiers of source, including all goodwill associated therewith and all common law rights, registrations and applications for registration thereof, and all rights therein provided by international treaties or conventions, and all reissues, extensions and renewals of any of the foregoing, (iv) intellectual property rights arising from or in respect of domain names, domain name registrations and reservations, (v) trade secrets, (vi) intellectual property rights arising from or in respect of Technology, and (vii) all other applications and registrations related to any of the intellectual property rights set forth in the foregoing clauses (i) – (vi) above.

“Investment Management Agreements” means each of the Amended and Restated Investment Management and Services Agreements dated as of the date hereof between GEAM and one or more Subsidiaries of Genworth.

“Provider” means the party providing a Service under this Agreement.

“Recipient” means the party to whom a Service under this Agreement is being provided.

“Representative(s)” of a Person means any director, officer, employee, agent, consultant, accountant, auditor, financing source, attorney, investment banker or other representative of such Person.

“Retained Businesses” means the insurance businesses owned or managed, directly or indirectly, by General Electric or one of its Subsidiaries immediately prior to the Closing and any other businesses owned or managed, directly or indirectly, by General Electric or one of its Subsidiaries immediately prior to the Closing that received any service or support

2

substantially the same as the Company Services described in Schedule B hereto from GEFAHI or the Company at any time prior to the Closing, in each case to the extent such businesses are not transferred or contributed to the Company at the Closing.

“Software” means the object and source code versions of computer programs and any associated documentation therefore.

“Service(s)” means, individually and collectively, the GE Services, Company Services and Undertakings (but specifically excludes the Management Consulting Services).

“Service Termination Date” shall have the meaning specified in Schedule A, Schedule A-1 or Schedule B, as applicable, in respect of any Service, or such earlier date as provided hereunder.

“Technology” means, collectively, all designs, formulas, algorithms, procedures, techniques, ideas, know-how, software, programs, models, routines, confidential and proprietary information, databases, tools, inventions, invention disclosures, creations, improvements, works of authorship, and all recordings, graphs, drawings, reports, analyses, other writings, and any other embodiment of the above, in any form, whether or not specifically listed herein.

“Total Consent Cost Amount” means \$11 million, which amount represents the parties’ agreed-upon good faith estimate of the anticipated out-of-pocket costs with respect to obtaining, performing or otherwise satisfying (i) the Consents pursuant to the terms of this Agreement and (ii) the Consents (as such term is defined in the European Transition Services Agreement) pursuant to the terms of the European Transition Services Agreement.

“Total Conversion Cost Amount” means \$29.6 million, which amount represents the parties’ agreed-upon good faith estimate of the anticipated nonrecurring, out-of-pocket conversion costs with respect to the transition of (i) the GE Services pursuant to the terms of this Agreement and (ii) the GEIH Services (as such term is defined in the European Transition Services Agreement) pursuant to the terms of the European Transition Services Agreement.

“Undertakings” means, collectively, the obligations of General Electric and its Subsidiaries and Genworth and its Subsidiaries set forth in Article III.

“Virus” shall mean any computer instructions (i) that adversely affect the operation, security or integrity of a computing, telecommunications or other digital operating or processing system or environment, including without limitation, other programs, data, databases, computer libraries and computer and communications equipment, by altering, destroying, disrupting or inhibiting such operation, security or integrity; (ii) that without functional purpose, self-replicate without manual intervention; and/or (iii) that purport to perform a useful function but which actually perform either a destructive or harmful function, or perform no useful function and utilize substantial computer, telecommunications or memory resources.

SECTION 1.02. Other Terms. For purposes of this Agreement, the following terms have the meanings set forth in the sections or agreements indicated.

3

<u>Term</u>	<u>Section</u>
Affiliate	Master Agreement
Agreement	Preamble
Breaching Party	Section 9.01(a)
Business Day	Master Agreement
Business Services Agreement	Master Agreement
Closing	Master Agreement
Closing Date	Master Agreement
Company	Recitals
Company Indemnified Party	Section 3.02(b)
Company Services	Section 2.01(b)
Company Services Manager	Section 2.04
Company Substitute Service	Section 2.01(b)
Company Vendor Agreements	Section 3.01(b)
Consents	Section 4.04(a)
Controlled	Cross License
Electronic Materials	Section 2.02(a)(iii)

Force Majeure	Master Agreement
General Electric	Preamble
GE	Recitals
GE Acquired Unit	Section 10.10
GEAM	Preamble
GE Basic Substitute Service	Section 2.01(a)
GE Confidential Information	Master Agreement
GE Capital	Preamble
GE Divested Unit	Section 10.10
GEFAHI	Preamble
GEI	Preamble
GE Intellectual Property	Cross License
GEMH	Preamble
Genworth	Preamble
Genworth Acquired Unit	Section 10.10
Genworth Business	Master Agreement
Genworth Confidential Information	Master Agreement
Genworth Divested Unit	Section 10.10
Genworth Intellectual Property	Cross License
GE-Owned GRC Intellectual Property	Section 4.03(b)
GE Services	Section 2.01(a)
GE Services Manager	Section 2.03
GE Substitute Investment IT Service	Section 2.01(a)
GE Substitute Service	Section 2.01(a)
GE Vendor Agreements	Section 3.01(a)
GNA	Preamble
HIPAA	Schedule F
HIPAA Privacy Rule	Schedule F
IBS	Section 5.01(c)(i)

Term	Section
Improvement	Cross License
Investment IT Services	Section 2.01(a)
Laws	Master Agreement
Liabilities	Master Agreement
Management Consulting Services	Section 4.06(a)
Master Agreement	Recitals
Non-Breaching Party	Section 9.01(a)
Other Costs	Section 5.01(a)
Permitted Use	Section 3.02(a)
Provider Indemnified Party	Section 7.01
Recipient Indemnified Party	Section 7.02
Reinsurance Agreement(s)	Master Agreement
Service Charges	Section 5.01(a)
Six Sigma Programs	Section 3.02(a)
Standard for Services	Section 6.01
Subsidiary	Master Agreement
Taxes	Section 10.06(b)
Transactions	Master Agreement
Trigger Date	Master Agreement

## ARTICLE II

### SERVICES AND TERMS

#### SECTION 2.01. Services; Scope

(a) During the period commencing on the date hereof and ending on the relevant Service Termination Date, subject to the terms and conditions set forth in this Agreement, General Electric shall provide or cause to be provided to the Company the services listed in Schedule A (the “GE Service(s)”). The “GE Services” also shall include (1) any Services to be provided by GE to the Company as agreed pursuant to Section 10.03(a), (2) the investment-related information technology services set forth on Schedule A-1 (the “Investment IT Services”), and (3) any GE Substitute Service; provided, however, that (i) the scope of each GE Service shall be substantially the same as the scope of such service provided by GE to the Company or the Company’s predecessor, as applicable, on the last day prior to the date hereof that such service was provided by GE to the Company or the Company’s predecessor, as applicable, in the ordinary course, (ii) the use of each GE Service by the Company shall include use by the Company’s contractors in substantially the same manner as used by the contractors of the Company or the Company’s predecessor, as applicable, prior to the Closing and (iii) except as provided in Section 10.10, nothing in this Agreement shall require that any GE Service be provided other than for use in, or in connection with the Genworth Business. Nothing in the preceding sentence or elsewhere in this Agreement shall be deemed to restrict or otherwise limit the volume or quantity of any GE Service, provided that certain volume or quantity changes with respect to a GE Service may require the parties to negotiate in good faith and use their commercially reasonable efforts to agree upon a price change with respect to such GE Service

pursuant to Section 10.10. If, for any reason, GE is unable to provide any GE Service (other than an Investment IT Service) to the Company pursuant to the terms of this Agreement, GE shall provide to the Company a substantially equivalent service (a “GE Basic Substitute Service”) at or below the cost for the substituted GE Service as set forth in Schedule A and otherwise in accordance with the terms of this Agreement, including the Standard for Services. If, for any reason, GE is unable to provide any Investment IT Service to the Company pursuant to the terms of this Agreement or GE elects to provide a substitute service in lieu of such Investment IT Service, GE shall provide to the Company a substantially equivalent service (a “GE Substitute Investment IT Service”) at or below the cost for the substituted Investment IT Service as set forth in Schedule A-1 (subject to any increase in such costs provided for in the Investment Management Agreements) and otherwise in accordance with the terms of this Agreement, including the Standard for Services; provided, however, (i) GE shall provide the Recipient of such GE Substitute Investment IT Service with reasonable advance notice of the proposed commencement date of such GE Substitute Investment IT Service and (ii) upon such Recipient’s request, GE shall provide such Recipient with information

regarding GE's plans to substitute the existing Investment IT Service with the GE Substitute Investment IT Service and permit such Recipient to (A) consult with applicable GE personnel regarding the proposed GE Substitute Investment IT Service and the third party provider thereof and (B) participate in negotiations with any third party provider of such GE Substitute Investment IT Service, provided that GE shall have the exclusive right, subject to the terms of this Agreement, to ultimately select the GE Substitute Investment IT Service and the provider thereof. Together, the GE Basic Substitute Services and the GE Substitute Investment IT Services shall be the "GE Substitute Services."

(b) During the period commencing on the date hereof and ending on the relevant Service Termination Date, subject to the terms and conditions set forth in this Agreement, Genworth shall provide or cause to be provided to GE the services listed in Schedule B (the "Company Service(s)"). The "Company Services" also shall include (1) any Services to be provided by the Company to GE as agreed pursuant to Section 10.03(a) and (2) any Company Substitute Service; provided, however, that (i) the scope of each Company Service shall be substantially the same as the scope of such service provided by the Company or the Company's predecessor, as applicable, to GE on the last day prior to the date hereof that such service was provided by the Company or the Company's predecessor, as applicable, to GE in the ordinary course, (ii) the use of each Company Service by GE shall include use by GE's contractors in substantially the same manner as used by the contractors of GE prior to the Closing and (iii) except as provided in Section 10.10, nothing in this Agreement shall require that any Company Service be provided other than for use in, or in connection with (A) the Retained Businesses or (B) the GEFAHI Divested Companies. Nothing in the preceding sentence or elsewhere in this Agreement shall be deemed to restrict or otherwise limit the volume or quantity of any Company Service, provided that certain volume or quantity changes with respect to a Company Service may require the parties to negotiate in good faith and use their commercially reasonable efforts to agree upon a price change with respect to such Company Service pursuant to Section 10.10 hereof. The Company Services shall not include any services the Company provides or causes to be provided pursuant to the Business Services Agreement. If, for any reason, the Company is unable to provide any Company Service to GE pursuant to the terms of this Agreement, the Company shall provide to GE a substantially equivalent service (a "Company Substitute Service") at or below the cost for the substituted Company Service as set forth in Schedule B and otherwise in accordance with the terms of this Agreement, including the Standard for Services.

6

(c) The GE Services shall include, and the Service Charges reflect charges for, such maintenance, support, error correction, training, updates and enhancements normally and customarily provided by GE to its Subsidiaries that receive such services. If the Company requests that GE provide a custom modification in connection with any GE Service, the Company shall be responsible for the cost of such custom modification, and to the extent such custom modification constitutes Software and such Software and all Intellectual Property therein is owned by GE, GE hereby assigns such Software and all Intellectual Property therein to the Company and the Company hereby grants GE a perpetual, worldwide, fully paid up, irrevocable, transferable, royalty-free, non-exclusive license, with the right to sublicense, to use and modify such Software. The GE Services shall include all functions, responsibilities, activities and tasks, and the materials, documentation, resources, rights and licenses to be used, granted or provided by GE that are not specifically described in this Agreement as a part of the GE Services, but are incidental to, and would normally be considered an inherent part of, or necessary subpart included within, the GE Services or are otherwise necessary for GE to provide, or the Company to receive, the GE Services.

(d) The Company Services shall include, and the Service Charges reflect charges for, such maintenance, support, error correction, training, updates and enhancements normally and customarily provided by the Company to its Subsidiaries that receive such services. If GE requests that the Company provide a custom modification in connection with any Company Service, GE shall be responsible for the cost of such custom modification, and to the extent such custom modification constitutes Software and such Software and all Intellectual Property therein is owned by the Company, the Company hereby assigns such Software and all Intellectual Property therein to GE and GE hereby grants the Company a perpetual, worldwide, fully paid up, irrevocable, transferable, royalty-free, non-exclusive license, with the right to sublicense, to use and modify such Software. The Company Services shall include all functions, responsibilities, activities and tasks, and the materials, documentation, resources, rights and licenses to be used, granted or provided by the Company that are not specifically described in this Agreement as a part of the Company Services, but are incidental to, and would normally be considered an inherent part of, or necessary subpart included within, the Company Services or are otherwise necessary for the Company to provide, or GE to receive, the Company Services.

(e) This Agreement (including Section 4.03 hereof) shall not assign any rights to Technology or Intellectual Property between the parties other than as specifically set forth herein.

(f) The parties acknowledge and agree that in connection with the implementation, provision, receipt and transition of the Services, there will be certain nonrecurring, out-of-pocket conversion costs incurred by GE or the Company. With respect to each GE Service, GE shall either reimburse the Company after the Service Termination Date for all actual, out-of-pocket conversion costs incurred by the Company and related to such GE Service or, after consultation with the Company, pay such conversion costs directly on an as incurred basis, in either case regardless of whether the Company replaces the GE Service with the same application, system, vendor or other means of effecting the GE Service; provided, however, that GE's payment and reimbursement obligations under this Section 2.01(f) and Section 3.3.1 of the European Transition Services Agreement shall not exceed, in the aggregate, the Total Conversion Cost Amount. GE shall be solely responsible for paying any one-time

7

conversion and related costs with respect to the Company Services, and any such one-time conversion or related costs shall not be included in the Total Conversion Cost Amount.

(g) Prior to GE's payment of or reimbursement for actual out-of-pocket conversion costs pursuant to Section 2.01(f) above, the Company shall provide GE with an invoice accompanied by reasonably detailed data and documentation sufficient to evidence the out-of-pocket expenses for which the Company is seeking payment or reimbursement. Upon receipt of such invoice and data and documentation, GE shall, except as otherwise provided in Section 2.01(f), either pay the amount of such invoice directly in accordance with GE's general payment terms with vendors or reimburse the Company for its payment of the invoice within 30 days of the date of GE's receipt of such invoice and request for reimbursement from the Company. If GE in good faith disputes the invoiced amount, then the parties shall work together to resolve such dispute. If the parties are unable to resolve such dispute within 30 days, the dispute shall be resolved pursuant to Section 8.02. The parties acknowledge and agree that no prior approval shall be required from GE for the Company to seek any reimbursement pursuant to Section 2.01(f) and this Section 2.01(g).

(h) Throughout the term of this Agreement, the Provider and the Recipient of any Service shall cooperate with one another and use their good faith, commercially reasonable efforts to effect the efficient, timely and seamless provision and receipt of such Service.

(i) Any Software delivered by a Provider hereunder shall be delivered, at the election of the Provider, either (i) with the assistance of the Provider, through electronic transmission or downloaded by the Recipient from the GE intranet, or (ii) by installation by Provider on the relevant equipment with retention by Provider of all tangible media on which such Software resides. Provider and Recipient acknowledge and agree that no tangible medium containing such Software (including any enhancements, upgrades or updates) will be transferred to Recipient at any time for any reason under the terms of this Agreement, and that Provider will, at all times, retain possession and control of any such tangible medium used or consumed by Provider in the performance of this Agreement. Each party shall comply with all reasonable security measures implemented by the other party in connection with the delivery of Software.

## SECTION 2.02. Conversion Services.

(a) During the term of this Agreement, GE shall provide, or cause to be provided, the following support, which support shall be in addition to the GE Services described in Schedule A and Schedule A-1, at no cost except for actual out-of-pocket costs and expenses approved in advance in writing by the Company Services Manager:

(i) GE shall provide, or cause to be provided, current and reasonably available historical data related to the GE Services and predecessor services thereto as reasonably required by the Company in a manner and within a time period as mutually agreed by the parties.

(ii) GE shall make reasonably available to the Company employees and contractors of GE whose assistance, expertise or presence is necessary to assist the

8

---

Company's transition team in establishing a fully functioning stand-alone environment and the timely assumption by the Company, or by a supplier to the Company, of the GE Services.

(iii) With respect to any Software or other electronic content ("Electronic Materials") licensed to Genworth and its Affiliates under the Cross License and used to provide a GE Service, GE shall make available or deliver to the Company a copy of such Software or Electronic Materials that are in existence and current as of the Service Termination Date for such GE Service, including any upgrades, updates and other modifications made to such Software and Electronic Materials since the Closing Date. Any upgrades, updates or other modifications to Software and Electronic Materials made available or delivered to the Company pursuant to this Section 2.02(a)(iii) shall be deemed to be GE Intellectual Property under the Cross License and licensed to Genworth and its Affiliates pursuant to the terms of the Cross License, notwithstanding that such upgrades, updates or other modifications (x) were not used, held for use or contemplated to be used by the Genworth Group as of the Closing Date, (y) were not Controlled by the GE Group as of the Closing Date or (z) may constitute Improvements made after the Closing Date.

(b) During the term of this Agreement, the Company shall provide, or cause to be provided, the following support, which support shall be in addition to the Company Services described in Schedule B, at no cost except for actual out-of-pocket costs and expenses approved in advance in writing by the GE Services Manager:

(i) The Company shall provide, or cause to be provided, current and reasonably available historical data related to the Company Services and predecessor services thereto as reasonably required by GE in a manner and within a time period as mutually agreed by the parties.

(ii) The Company shall make reasonably available to GE employees and contractors of the Company whose assistance, expertise or presence is necessary to assist GE's transition team in establishing a fully functioning stand-alone environment in respect of the Retained Businesses and the timely assumption by GE, or by a supplier of GE, of the Company Services.

(iii) With respect to any Software or other Electronic Materials licensed to General Electric and its Affiliates under the Cross License and used to provide a Company Service, Company shall make available or deliver to GE a copy of such Software or Electronic Materials that are in existence and current as of the Service Termination Date for such Company Service, including any upgrades, updates and other modifications made to such Software and Electronic Materials since the Closing Date. Any upgrades, updates or other modifications to Software and Electronic Materials made available or delivered to GE pursuant to this Section 2.02(b)(iii) shall be deemed to be Genworth Intellectual Property under the Cross License and licensed to General Electric and its Affiliates pursuant to the terms of the Cross License, notwithstanding that such upgrades, updates or other modifications (x) were not used, held for use or contemplated to be used by GE Group as of the Closing Date, (y) were not Controlled by the Genworth Group as of the Closing Date or (z) may constitute Improvements made after the Closing Date.

9

---

SECTION 2.03. GE Services Manager. GE will designate a dedicated services account manager (the "GE Services Manager") who will be directly responsible for coordinating and managing the delivery of the GE Services and will have authority to act on GE's behalf with respect to the Services. The GE Services Manager will work with the Company Services Manager to address the Company's issues and the parties' relationship under this Agreement.

SECTION 2.04. Company Services Manager. The Company will designate a dedicated services account manager (the "Company Services Manager") who will be directly responsible for coordinating and managing the delivery of the Services by the Company and will have authority to act on the Company's behalf with respect to the Services. The Company Services Manager will work with the GE Services Manager to address GE's issues and the parties' relationship under this Agreement.

SECTION 2.05. Performance and Receipt of Services. The following provisions shall apply to the Services:

(a) Security. Each Provider and Recipient shall at all times comply with its own then in-force security guidelines and policies applicable to the performance, access and/or use of the Services and Information Systems.

(b) No Viruses. Each of the Company and GE shall take commercially reasonable measures to ensure that no Viruses or similar items are coded or introduced into the Services or Information Systems. If a Virus is found to have been introduced into the Services or Information Systems, the parties hereto shall use their commercially reasonable efforts to cooperate and to diligently work together to eliminate the effects of such Virus.

(c) Reasonable Care. Each Provider and Recipient shall exercise reasonable care in providing and receiving the Services to (i) prevent access to the Services or Information Systems by unauthorized Persons and (ii) not damage, disrupt or interrupt the Services or Information Systems.

### ARTICLE III

#### OTHER ARRANGEMENTS

SECTION 3.01. Vendor Agreements.

(a) During the period beginning on the date hereof and ending on the Trigger Date, GE is or may become a party to certain corporate purchasing contracts, master services agreements, vendor contracts, software and other Intellectual Property licenses or similar agreements unrelated to the GE Services (the "GE Vendor Agreements") under which (or under open work orders thereunder) the Company purchases goods or services, licenses rights to use Intellectual Property and realizes certain other benefits and rights. The parties hereby agree that the Company shall continue to retain the right to purchase goods or services and continue to realize such other benefits and rights under each GE Vendor Agreement to the extent allowed by such GE Vendor Agreement until the expiration or termination date of such rights or benefits pursuant to the terms of such GE Vendor Agreement (including, without limitation, any

10

---

voluntary termination of such GE Vendor Agreement by GE). Additionally, for so long as the purchasing or other rights remain in full force and effect under a GE Vendor Agreement and the Company continues to exercise its purchasing or other rights and benefits under such GE Vendor Agreement and for a period of six months thereafter, GE shall use its commercially reasonable efforts, upon the written request of the Company, to assist the Company in obtaining a purchasing contract, master services agreement, vendor contract or similar agreement directly with the third party provider that is a party to the GE Vendor Agreement.

(b) During the period beginning on the date hereof and ending on the Trigger Date, the Company is or may become a party to certain corporate purchasing contracts, master services agreements, vendor contracts, software and other Intellectual Property licenses or similar agreements unrelated to the Company Services (the "Company Vendor Agreements") under which (or under open work orders thereunder) GE purchases goods or services, licenses rights to use Intellectual Property and realizes certain other benefits and rights. The parties hereby agree that GE shall continue to retain the right to purchase goods or services and continue to realize such other benefits and rights under each Company Vendor Agreement to the extent allowed by such Company Vendor Agreement until the expiration or termination date of such rights or benefits pursuant to the terms of such Company Vendor Agreement (including, without limitation, any voluntary termination of such Company Vendor Agreement by the Company). Additionally, for so long as the purchasing or other rights remain in full force and effect under a Company Vendor Agreement and GE continues to exercise its purchasing or other rights and benefits under such Company Vendor Agreement and for a period of six months thereafter, the Company shall use its commercially reasonable efforts, upon the written request of GE, to assist GE in obtaining a purchasing contract, master services agreement, vendor contract or similar agreement directly with the third party provider that is a party to the Company Vendor Agreement.

SECTION 3.02. Six Sigma Programs.

(a) With regard to the materials, concepts, and methodology comprising the Six Sigma programs used by the Company and its predecessors prior to the date hereof (the "Six Sigma Programs"), GE, at no cost to Company, shall ensure that on and after the date hereof, Company may continue to use the Six Sigma Programs in the same manner as used by the Company and its predecessors prior to the date hereof ("Permitted Use").

(b) GE shall indemnify, defend and hold harmless the Company and its directors, officers, employees and each of the heirs, executors, successors and assigns of any of the foregoing (each a "Company Indemnified Party"), from and against any and all Liabilities of the Company Indemnified Parties relating to, arising out of, or resulting from, the Permitted Use, which Liabilities relate to, arise out of, or result from, claims or allegations relating to the Company's right to use the Six Sigma Programs pursuant to Section 3.02(a) hereof, and which claims or allegations are asserted by consultants, contractors, former employees, or other Persons who contributed to or provided such materials, concepts or methodologies to the Six Sigma Programs.

11

---

ARTICLE IV

ADDITIONAL AGREEMENTS

SECTION 4.01. Leases.

(a) Each lease or sublease listed on Schedule C-1, pursuant to which the Company leases or subleases real property from GE, shall remain in full force and effect pursuant to its terms unless otherwise agreed to in writing by the parties.

(b) Each lease or sublease listed on Schedule C-2, pursuant to which GE leases or subleases real property from the Company, shall remain in full force and effect pursuant to its terms unless otherwise agreed to in writing by the parties.

SECTION 4.02. Computer-Based Resources.

(a) Prior to the Trigger Date, the Company shall continue to have access to the Information Systems of GE. On and after the Trigger Date, the Company shall not have access to all or any part of the Information Systems of GE, except to the extent necessary for the Company to perform the Company Services or receive the GE Services (subject to the Company complying with all reasonable security measures implemented by GE as deemed necessary by GE to protect its Information Systems, provided that the Company has had a commercially reasonable period of time in which to comply with such security measures).

(b) Prior to the Trigger Date, GE shall continue to have access to the Information Systems of the Company. On and after the Trigger Date, GE shall not have access to all or any part of the Information Systems of the Company, except to the extent necessary for GE to perform the GE Services or receive the Company Services (subject to GE complying with all reasonable security measures implemented by the Company as deemed necessary by the Company to protect its Information Systems, provided that GE has had a commercially reasonable period of time in which to comply with such security measures).

SECTION 4.03. GRC Matters.

(a) GE's Global Research Center shall continue to provide research and development services and related consultation to the Company for the projects set forth in Schedule D in accordance with the terms of any existing written agreements between the Company and GE relating thereto, which shall continue after the date hereof in accordance with the terms of such written agreements.

(b) Unless the parties specifically agree otherwise in any such existing agreement for the projects set forth in Schedule D, as between the parties, all deliverables pursuant to such projects and the Intellectual Property therein created by or on behalf of GE or jointly by or on behalf of GE and the Company (other than any such Intellectual Property or Technology provided to GE by the Company) shall be owned by GE. All such deliverables and Intellectual Property therein (other than any such Intellectual Property or Technology owned by a third party) shall be referred to herein as the "GE-Owned GRC Intellectual Property". The GE-Owned GRC Intellectual Property shall be deemed to be GE Intellectual Property under the

12

---

Cross License and licensed to Genworth and its Affiliates pursuant to the terms of the Cross License, notwithstanding that the GE-Owned GRC Intellectual Property (x) was not used, held for use or contemplated to be used by the Genworth Group as of the Closing Date, (y) was not Controlled by the GE Group as of the Closing Date or (z) may constitute Improvements made after the Closing Date.

(c) For each project listed on Schedule D, each of the Company and GE shall be solely responsible for the costs assigned to it on Schedule D during 2004. If, following the date hereof, the Company desires to enter into arrangements with GE's Global Research Center to provide research and development services or related consultation to the Company for any additional projects, GE and the Company shall use commercially reasonable efforts to negotiate in good faith a contract for such services.

SECTION 4.04. Consents.

(a) The parties acknowledge and agree that certain software and other licenses, consents, approvals, notices, registrations, recordings, filings and other actions (collectively, "Consents") need to be obtained in connection with the Transactions. GE shall, after consultation with the Company, either directly pay the out-of-pocket costs incurred to obtain, perform or otherwise satisfy each Consent or after any such Consent is obtained, performed or otherwise satisfied, reimburse the Company for all actual, out-of-pocket costs incurred by the Company and related to such Consent; provided, however, that GE's payment and reimbursement obligations under this Section 4.04(a) and Section 4.5 of the European Transition Services Agreement shall not exceed, in the aggregate, the Total Consent Cost Amount. GE shall be solely responsible for paying any costs or fees in connection with any Consents with respect to the Company Services or with respect to any agreements to be assigned to GE pursuant to the Master Agreement, and any such costs or fees shall not be included in the Total Consent Cost Amount.

(b) Prior to receiving any reimbursement for its actual, out-of-pocket costs pursuant to Section 4.04(a) above, the Company shall provide GE with an invoice accompanied by reasonably detailed data and documentation sufficient to evidence the out-of-pocket expenses for which the Company is seeking reimbursement. Upon receipt of such invoice and data and documentation, GE shall, except as otherwise provided in Section 4.04(a), pay the amount of such invoice to the Company within 30 days of the date of receipt of such invoice. If GE in good faith disputes the invoiced amount, then the parties shall work together to resolve such dispute. If the parties are unable to resolve such dispute, the dispute shall be resolved pursuant to Section 8.02. The parties acknowledge and agree that no prior approval from GE shall be required for the Company to seek any reimbursement pursuant to Section 4.04(a) and this Section 4.04(b).

SECTION 4.05. Access.

(a) The Company will allow GE and its Representatives reasonable access to the facilities of the Company necessary for the performance of the GE Services listed on Schedule A and Schedule A-1 for GE to fulfill its obligations under this Agreement.

13

---

(b) GE will allow the Company and its Representatives reasonable access to the facilities of GE necessary for the performance of the Company Services listed on Schedule B for the Company to fulfill its obligations under this Agreement.

SECTION 4.06. Management Consulting Services.

(a) For a period of sixty (60) months from the date hereof, subject to the payment by GE of the amount specified in Section 4.06(e) below and upon the reasonable, prior written request of GE, the Company will make such appropriate members of its senior management team reasonably available to provide the services described on Schedule E (the "Management Consulting Services").

(b) GE and the Company will mutually agree on the schedule for delivery of the Management Consulting Services. The schedule will be based on (i) the GE and Company corporate calendars, (ii) the GE and Company functional calendars, (iii) GE's requests, and (iv) GE's and the Company's shared customer requests. The parties will reasonably work together to accommodate each other's specific needs regarding meeting logistics, including method, travel, time, and notice. For avoidance of doubt, schedule conflicts shall not constitute a breach of this Agreement.

(c) The Company will make reasonable efforts to accommodate GE's requests; provided however, each participating Company employee shall not be required to spend any more time than the time spent in similar activities in the calendar year immediately preceding the date hereof. Meeting and other service requests may be submitted by GE and will be considered complete and proper if (i) presented at least one week in advance of any required meeting or such shorter time period as agreed to by the parties, (ii) accompanied by an agenda or a detailed listing of services requested and/or any materials requiring preparation by the Company. If prepared materials by the Company are requested, then the Company, at its sole discretion, may request additional lead time adequate to prepare the materials.

(d) The Management Consulting Services shall be in addition to the Company's obligations pursuant to Section 2.01(h) and 2.02(b) of this Agreement. In connection with providing the Management Consulting Services and unless otherwise agreed to by the Company, the Company shall not be required to provide any service that would (i) require the disclosure to GE of Company trade secret information or other information that provides the Company a significant competitive advantage, or (ii) require the Company to violate any attorney-client privilege or otherwise lose the protection of other privileged information. In addition, the Company shall not be required to provide any Management Consulting Services whenever the Company's and GE's interests related to such Management Consulting Services are in conflict.

(e) In consideration of the availability and/or receipt of the Management Consulting Services, GE shall pay the Company the following amounts: (i) \$1 million per month during the forty-eight (48) month period beginning on the date hereof; and (ii) \$500,000 per month thereafter until the termination of the Company's obligation to provide the Management Consulting Services. Each such monthly payment shall be payable in arrears within thirty (30) days following the last day of the month to which such payment relates. GE shall also reimburse

14

---

the Company's reasonable out-of-pocket costs and expenses incurred in connection with the provision of the Management Consulting Services, including, but not limited to, travel and lodging expenses.

(f) Notwithstanding anything herein to the contrary, GE acknowledges and agrees that the Management Consulting Services are provided as-is, that GE assumes all risks and liability arising from or relating to its use of and reliance upon the Management Consulting Services and the Company makes no warranty with respect thereto. THE COMPANY HEREBY EXPRESSLY DISCLAIMS ALL WARRANTIES REGARDING THE MANAGEMENT CONSULTING SERVICES, WHETHER EXPRESS OR IMPLIED, INCLUDING, WITHOUT LIMITATION, ANY WARRANTY IN REGARD TO QUALITY, PERFORMANCE, NONINFRINGEMENT, COMMERCIAL UTILITY, MERCHANTABILITY OR FITNESS OF THE MANAGEMENT CONSULTING SERVICES FOR A PARTICULAR PURPOSE.

(g) Notwithstanding the provisions of Articles VI and VII, neither the Company nor any of its directors, officers, employees, or any of the heirs, executors, successors or assigns of any of the foregoing shall have any liability in contract, tort or otherwise to GE, its Affiliates or Representatives for or in connection with the Management Consulting Services.

(h) GE and the Company acknowledge and agree that (i) Articles VI and VII of this Agreement shall not apply to this Section 4.06 or the Management Consulting Services and (ii) notwithstanding Section 10.10 of this Agreement, under no circumstances shall the Company be obligated to provide the Management Consulting Services to a GE Divested Unit.

ARTICLE V

COSTS AND DISBURSEMENTS; PAYMENTS

SECTION 5.01. Costs and Disbursements; Payments.

(a) Schedules A, A-1 and B hereto set forth with respect to each Service to be provided a description of the charges (the "Service Charges") for such Service or the basis for the determination thereof. During the 24-month period following the date of this Agreement, notwithstanding the Service Charges set forth on Schedule B, the aggregate Service Charges payable by GE to the Company shall, subject to reduction following termination of any Company Service pursuant to Section 9.01(a)(ii) or Section 9.01(a)(iii), be equal to \$40 million, and such aggregate amount shall be paid by GE to the Company in eight equal quarterly installments payable on each March 31, June 30, September 30 and December 31 during such 24-month period. At the time of each quarterly payment, GE also shall pay the Service Charges for the Company Services provided with respect to the GEFAHI Divested Companies as identified on Schedule B in the three months ending on the date the quarterly payment is due for so long as such Company Services are rendered. Further, in connection with performance of the Services and in connection with the Undertakings, the Provider may incur certain out-of-pocket costs (the "Other Costs"), which shall, without duplication, either be paid directly by the Recipient or reimbursed to the Provider by the Recipient; provided that any Other Costs shall only be payable by the Company or GE, as the case may be, in accordance with this Section 5.01(a) if (i) such Other Costs have been

Manager (if the Company is the Recipient) or the GE Services Manager (if GE is the Recipient) prior to having been incurred by the Provider and (ii) the Recipient receives from the Provider reasonably detailed data and other documentation sufficient to support the calculation of amounts due to the Provider as a result of such Other Costs.

(b) Notwithstanding the Service Charges set forth in Schedule A with respect to the Company's use of GE's U.S. shared data center services supporting GE's U.S. businesses, GE shall reduce the Service Charges with respect to such services by \$2 million per quarter for a period of two years from the date hereof.

(c) Except with respect to Service Charges for the provision of the Company Services during the 24-month period referenced in Section 5.01(a):

(i) Prior to the Trigger Date, the Provider and Recipient shall arrange for the payment of all Service Charges and Other Costs through the GE Internal Billing System ("IBS"). The Recipient shall have the right to dispute any Service Charges and Other Costs settled through the IBS during any calendar quarter by delivering written notice of such dispute, setting forth in reasonable detail the basis therefor, to the Provider within, and no later than, 60 days after the end of such quarter. As soon as practicable after receipt of any such notice, the Provider shall provide the Recipient with reasonably detailed data and documentation sufficient to support the calculation of any Service Charges and Other Costs that are the subject of the dispute. If the Provider's furnishing of such information does not promptly resolve such dispute, the dispute shall be resolved pursuant to Section 8.02.

(ii) From and after the Trigger Date, the Provider shall deliver an invoice to the Recipient on a monthly basis (or at such other frequency as is consistent with the basis on which the Service Charges are determined and, if applicable, charged to Affiliates of the Provider) in arrears for the Service Charges and any Other Costs due to the Provider under this Agreement. The Recipient shall pay the amount of such invoice to the Provider in U.S. dollars within seventy-five (75) days of the date of such invoice, provided that, to the extent consistent with past practice with respect to Services rendered outside the United States, payments may be made in local currency. If the Recipient fails to pay such amount (excluding any amount contested in good faith) by such date, the Recipient shall be obligated to pay to the Provider, in addition to the amount due, interest on such amount at the lesser of (i) the three (3) month London Interbank Offered Rate (LIBOR) plus 100 basis points or (ii) the maximum rate of interest allowed by applicable law, from the date the payment was due through the date of payment. As soon as practicable after receipt by the Provider of any reasonable written request by the Recipient, the Provider shall provide the Recipient with reasonably detailed data and documentation sufficient to support the calculation of any amount due to the Provider under this Agreement for the purpose of verifying the accuracy of such calculation. If, after reviewing such data and documentation, the Recipient disputes the Provider's calculation of any amount due to the Provider, then the dispute shall be resolved pursuant to Section 8.02.

## ARTICLE VI

### STANDARD FOR SERVICE; COMPLIANCE WITH LAWS

SECTION 6.01. Standard for Service. Except as otherwise provided in this Agreement (including in Schedules A, A-1 and B hereto), the Provider agrees to perform the Services such that the nature, quality, standard of care and the service levels at which such Services are performed are no less than the nature, quality, standard of care and service levels at which the substantially same services were performed by or on behalf of the Provider during the most recent service period prior to the date hereof in which such services were performed by or on behalf of the Provider in the ordinary course (the "Standard for Services").

SECTION 6.02. Compliance with Laws. Each of GE and the Company shall comply with all applicable Laws when providing or receiving the Services or when performing obligations under this Agreement.

## ARTICLE VII

### INDEMNIFICATION; LIMITATION ON LIABILITY

SECTION 7.01. Limited Liability of a Provider. Notwithstanding the provisions of Section 6.01, no Provider or its Affiliates or any of their respective directors, officers or employees, or any of the heirs, executors, successors or assigns of any of the foregoing (each, a "Provider Indemnified Party"), shall have any liability in contract, tort or otherwise to the Recipient or its Affiliates or Representatives for or in connection with (i) any Services rendered or to be rendered by any Provider Indemnified Party pursuant to this Agreement, (ii) the transactions contemplated by this Agreement or (iii) any Provider Indemnified Party's actions or inactions in connection with any such Services or transactions; provided, however, that such limitation on liability shall not extend to or otherwise limit any Liabilities that have resulted directly from such Provider Indemnified Party's (A) gross negligence or willful misconduct, (B) improper use or disclosure of information of, or regarding, a customer or potential customer of a Recipient Indemnified Party (defined below) or (C) violation of applicable Law.

SECTION 7.02. Indemnification by Each Provider. Each Provider shall indemnify, defend and hold harmless each relevant Recipient and each of its Subsidiaries and each of their respective directors, officers and employees, and each of the heirs, executors, successors and assigns of any of the foregoing (each a "Recipient Indemnified Party"), from and against any and all Liabilities of the Recipient Indemnified Parties relating to, arising out of, or resulting from (i) the gross negligence or willful misconduct of a Provider Indemnified Party in connection with the transactions contemplated by this Agreement or such Provider Indemnified Party's provision of the Services, (ii) the improper use or disclosure of information of, or regarding, a customer or potential customer of a Recipient Indemnified Party in connection with the transactions contemplated by this Agreement or such Provider Indemnified Party's provision of the Services, or (iii) any violation of applicable Law by a Provider Indemnified Party in connection with the transactions contemplated by this Agreement or such Provider Indemnified Party's provision of the Services; provided, that (1) the aggregate liability of GE as a Provider

pursuant to this Article VII shall in no event exceed \$15 million and (2) the aggregate liability of the Company as a Provider pursuant to this Article VII shall in no event exceed \$10 million.

SECTION 7.03. Indemnification by Each Recipient. Each Recipient shall indemnify, defend and hold harmless each relevant Provider Indemnified Party from and against any and all Liabilities of the Provider Indemnified Parties relating to, arising out of, or resulting from the provision of the Services by any Provider or any of its Subsidiaries, except for (A) any Liabilities that result from a Provider Indemnified Party's negligence in connection with the provision of the Services, (B) any Liabilities that result from a Provider Indemnified Party's breach of this Agreement or (C) any Liabilities for which the Provider is required to indemnify a Recipient Indemnified Party pursuant to Section 7.02.

SECTION 7.04. Indemnification Procedures. The matters set forth in Sections 5.6 through 5.9 of the Master Agreement shall be deemed incorporated into, and a made a part of, this Agreement.

SECTION 7.05. Limitation on Liability. Notwithstanding any other provision contained in this Agreement, neither GE on the one hand, nor the Company, on the other hand, shall be liable to the other for any special, indirect, punitive, incidental or consequential losses, damages or expenses of the other, including, without limitation, loss of profits, arising from any claim relating to breach of this Agreement or otherwise relating to any of the Services or Undertakings provided hereunder. For clarification purposes only, the parties hereto agree that the limitation on liability contained in this Section 7.05 shall not apply to (a) damages awarded to a third party pursuant to a third party claim for which a Provider is required to indemnify, defend and hold harmless any Recipient Indemnified Party under Section 7.02 and (b) damages awarded to a third party pursuant to a third party claim for which a Recipient is required to indemnify, defend and hold harmless any Provider Indemnified Party under Section 7.03.

SECTION 7.06. Liability for Payment Obligations. Nothing in this Article VII shall be deemed to eliminate or limit, in any respect, GE or the Company's express obligation in this Agreement to pay or reimburse, as applicable, for (i) Service Charges for Services rendered in accordance with this Agreement, (ii) Other Costs, (iii) the Total Consent Cost Amount, (iv) the Total Conversion Cost Amount, (v) amounts in respect of the Management Consulting Services, (vi) amounts with respect to any custom modification provided pursuant to Sections 2.01(c) and (d) (Services; Scope), (vii) amounts in respect of conversion services provided pursuant to Section 2.02 (Conversion Services), (viii) amounts payable or reimbursable pursuant to the terms of the leases referred to in Section 4.01 (Leases), (ix) amounts payable or reimbursable pursuant to Section 4.03 (GRC Matters) and the terms of the existing written agreements referenced therein, (x) amounts payable or reimbursable pursuant to Section 10.03(b) (Books and Records), (xi) amounts payable or reimbursable pursuant to Section 10.06 (Taxes), (xii) amounts payable or reimbursable pursuant to Section 10.07 (Regulatory Approval and Compliance), and (xiii) amounts payable or reimbursable pursuant to Section 10.10 (Assignment; No Third Party Beneficiaries).

SECTION 7.07. Exclusions. This Article VII shall not apply to or limit any liability or obligation of GE under Sections 3.02(a) and (b).

18

---

## ARTICLE VIII

### DISPUTE RESOLUTION

SECTION 8.01. Applicable Law. This Agreement shall be governed by and construed and interpreted in accordance with the Laws of the State of New York irrespective of the choice of Laws principles of the State of New York other than Section 5-1401 of the General Obligations Law of the State of New York.

SECTION 8.02. Dispute Resolution. To the extent not resolved through discussions between the GE Services Manager and the Company Services Manager, any dispute, controversy or claim arising out of, or relating to this Agreement shall be resolved in accordance with Article VII of the Master Agreement.

## ARTICLE IX

### TERMINATION

SECTION 9.01. Termination.

(a) The term of this Agreement shall commence on the date hereof and expire on the first date on which neither GE nor the Company has any further obligations to provide a Service, perform an Undertaking (excluding the obligations set forth in Section 3.02) or perform or pay for the Management Consulting Services. This Agreement shall terminate with respect to each Service and Undertaking on the applicable Service Termination Date or other termination date specified in this Agreement or the Schedules hereto. In addition: (i) a Recipient may from time to time terminate any Service, in whole and not in part, upon giving at least sixty (60) days' (or such shorter period of time as is mutually agreed upon in writing by the parties) prior written notice to the Provider specifying which Service is being so terminated (such termination will not in any way affect the obligations of the party terminating this Agreement with respect to such Service to continue to receive all other Services not so terminated and to continue to provide Services as required by this Agreement); provided, however, that GE may not exercise this termination right during the 24-month period commencing on the date hereof; (ii) either party (the "Non-Breaching Party") may terminate this Agreement with respect to any Service, in whole but not in part, at any time upon prior written notice by the Non-Breaching Party to the other party (the "Breaching Party") if the Breaching Party has failed to perform any of its material obligations under this Agreement relating to such Service, and such failure shall have continued without cure for a period of sixty (60) days after receipt by the Breaching Party of a written notice of such failure from the Non-Breaching Party seeking to terminate such Service; provided, however, that no Service may be terminated pursuant to this clause (ii) until the parties have completed the dispute resolution process set forth in Section 7.2 of the Master Agreement with respect to such Service; and (iii) the parties may from time to time mutually agree to terminate any Service, in whole but not in part, provided that any such agreement to terminate a Service shall comply with Section 10.11 and include all terms and conditions applicable to termination of the Service to be terminated.

19

---

(b) In addition to and not in limitation of the rights and obligations set forth in Section 2.01(h), upon the request of the Recipient of a Service, (i) the Provider of such Service will, during the term of this Agreement during which such Provider is providing such Service to the Recipient, cooperate with the Recipient and use its good faith, commercially reasonable efforts to assist the transition of such Service to the Recipient (or Affiliate of the Recipient or such third-party vendor designated by the Recipient) by the Service Termination Date for such Service and (ii) the Provider of such Service will, for a reasonable period of time after the effective date of any termination (which shall not exceed the earlier of (1) the applicable Service Termination Date set forth on Schedule A, Schedule A-1, or Schedule B and (2) six months after the effective date of termination) of any such Service pursuant to clause (ii) of Section 9.01(a), (A) at the written request of the Recipient, continue to provide the terminated Service (subject to the timely payment, when due and payable, by the Recipient of all Service Charges related to such terminated Service) and (B) cooperate with the Recipient and use its good faith, commercially reasonable efforts to assist the transition of such Service to the Recipient (or Affiliate of the Recipient or such third-party vendor designated by the Recipient) as soon as reasonably practicable. The Service Charges for a terminated Service that is continuing to be provided pursuant to clause (ii) (A) of the preceding sentence shall be the same as were in effect prior to the termination of such Service.

SECTION 9.02. Effect of Termination. Except with respect to any Service that is continuing to be provided pursuant to clause (ii)(A) of Section 9.01(b) after the termination of such Service, upon termination or expiration of any Service or Undertaking pursuant to this Agreement, the relevant Provider will have no further obligation to provide the terminated Service or expired Undertaking, and the relevant Recipient will have no obligation to pay any future Service Charges or Other Costs relating to any such Service or Undertaking (other than for or in respect of Services or Undertakings provided in accordance with the terms of this Agreement and received by such Recipient prior to such termination). Upon termination of this Agreement in accordance with its terms, no Provider will have any further obligation to provide any Service or Undertaking, and no Recipient will have any obligation to pay any Service Charges or Other Costs relating to any Service or Undertaking or make any other payments under this Agreement (other than for or in respect of Services or Undertakings received by such Recipient prior to such termination).

SECTION 9.03. Survival. Sections 3.02(a) and (b) (Six Sigma Programs), Section 4.01 (Leases), Section 4.02 (Computer-Based Resources), Sections 4.06(c) and (d) (Management Consulting Services), Article V (Costs and Disbursements), Article VII (Indemnification; Limitation on Liability), Article VIII (Dispute Resolution), Section 9.02 (Effect of Termination), Section 9.03 (Survival), and Article X (General Provisions) shall survive the expiration or other termination of this Agreement and remain in full force and effect.

SECTION 9.04. Business Continuity; Force Majeure.

(a) Each of GE and the Company shall maintain and comply with reasonable disaster recovery, crisis management and business continuity plans and



procedures designed to help ensure that it can continue to provide the Services in accordance with this Agreement in the event of a disaster or other significant event that might otherwise impact its operations. Upon the written request of a Recipient, a Provider shall (i) disclose to the Recipient the Provider's

disaster recovery, crisis management and business continuity plans and procedures applicable to a Service and (ii) permit the Recipient to participate in testing of such disaster recovery, crisis management and business continuity plans and procedures, in each case so that the Recipient may assess such plans and procedures and develop or modify its own such plans and procedures in connection with the Service as Recipient reasonably deems necessary.

(b) No party hereto (or any Person acting on its behalf) shall have any liability or responsibility for failure to fulfill any obligation (other than a payment obligation) under this Agreement so long as and to the extent to which the fulfillment of such obligation is prevented, frustrated, hindered or delayed as a consequence of circumstances of Force Majeure; provided that such party shall have exhausted the procedures described in its disaster recovery, crisis management, and business continuity plan. A party claiming the benefit of this provision shall, as soon as reasonably practicable after the occurrence of any such event: (i) notify the other party of the nature and extent of any such Force Majeure condition and (ii) use commercially reasonable efforts to remove any such causes and resume performance under this Agreement as soon as feasible.

## ARTICLE X

### GENERAL PROVISIONS

SECTION 10.01. Independent Contractors. In providing Services hereunder, the Provider shall act solely as independent contractor and nothing in this Agreement shall constitute or be construed to be or create a partnership, joint venture, or principal/agent relationship between the Provider, on the one hand, and the Recipient, on the other. All Persons employed by the Provider in the performance of its obligations under this Agreement shall be the sole responsibility of the Provider.

SECTION 10.02. Subcontractors. Any Provider may hire or engage one or more subcontractors to perform any or all of its obligations under this Agreement; provided that such Provider shall in all cases remain responsible for all its obligations under this Agreement, including, without limitation, with respect to the scope of the Services, the Standard for Services and the content of the Services provided to the Recipient. Under no circumstances shall any Recipient be responsible for making any payments directly to any subcontractor engaged by a Provider.

SECTION 10.03. Additional Services: Books and Records.

(a) If, during the term of this Agreement, any party hereto identifies a need for additional or other transition services to be provided by or on behalf of the Company or GE, the parties hereto agree to negotiate in good faith to provide such requested services (provided that such services are of a type generally provided by the relevant Provider at such time) and the applicable service fees, payment procedures, and other rights and obligations with respect thereto. To the extent practicable, such additional or other services shall be provided on terms substantially similar to those applicable to Services of similar types and otherwise on terms consistent with those contained in this Agreement. If, during the 24-month period commencing on the date hereof, GE identifies a need for an additional transition service to be provided by or

on behalf of the Company and such service has, in the ordinary course, been provided by the Company to GE prior to the date hereof, then GE shall not be required to pay any additional consideration to the Company to receive such service, and the Company shall be deemed to be compensated for such service by means of the payment by GE to the Company of the amount set forth in the second sentence of Section 5.01(a).

(b) All books, records and data maintained by a Provider for a Recipient with respect to the provision of a Service to such Recipient shall be the exclusive property of such Recipient. The Recipient, at its sole cost and expense, shall have the right to inspect, and make copies of, any such books, records and data during regular business hours upon reasonable advance notice to the Provider. At the sole cost and expense of the Provider, upon termination of the provision of any Service, the relevant books, records and data relating to such terminated Service shall be delivered by the Provider to the Recipient in a mutually agreed upon format to the address of the Recipient set forth in Section 10.05 or any other mutually agreed upon location; provided, however, that the Provider shall be entitled to retain one copy of all such books, records and data relating to such terminated Service for archival purposes and for purposes of responding to any dispute that may arise with respect thereto.

SECTION 10.04. Confidential Information. Genworth agrees to maintain and safeguard all GE Confidential Information pursuant to Section 6.2 of the Master Agreement and GE agrees to maintain and safeguard all Genworth Confidential Information pursuant to Section 6.2 of the Master Agreement, and each party hereto agrees that Section 6.2 of the Master Agreement is hereby incorporated by reference into, and a made a part of, this Agreement. If any Provider in connection with the provision of a Service, or the Company in connection with the provision of any Management Consulting Service, constitutes a Business Associate (as defined in HIPAA and/or the HIPAA Privacy Rule) and uses Recipient's, or in the case of the Management Consulting Services, GE's, Protected Health Information (as defined in HIPAA and/or the HIPAA Privacy Rule), then the terms of Schedule F shall apply with respect to such Service or Management Consulting Service.

SECTION 10.05. Notices. All notices, requests, claims, demands and other communications under this Agreement shall be in writing and shall be given or made (and shall be deemed to have been duly given or made upon receipt) by delivery in person, by overnight courier service, by facsimile with receipt confirmed (followed by delivery of an original via overnight courier service) or by registered or certified mail (postage prepaid, return receipt requested) to the respective parties at the following addresses (or at such other address for a party as shall be specified in a notice given in accordance with this Section 10.05):

(a) if to GE:

General Electric Capital Corporation  
260 Long Ridge Road  
Stamford, CT 06927  
Attention: General Counsel

with a copy to:

Weil, Gotshal & Manges LLP  
767 Fifth Avenue  
New York, NY 10153  
Attention: Howard Chatzinoff, Esq.

if to the Company:

Genworth Financial, Inc.  
6620 West Broad Street  
Richmond, VA 23230  
Attention: General Counsel

with a copy to:

Hunton & Williams LLP  
Riverfront Plaza, East Tower  
951 E. Byrd Street  
Richmond, VA 23219-4074  
Attention: Allen C. Goolsby, Esq.

SECTION 10.06. Taxes.

(a) Each party shall be responsible for any personal property taxes on property it owns or leases, for franchise and privilege taxes on its business, and for taxes based on its net income or gross receipts.

(b) Each Recipient may report and (as appropriate) pay any sales, use, excise, value-added, services, consumption, and other taxes and duties ("Taxes") directly if the Recipient provides the applicable Provider with a direct pay or exemption certificate.

(c) A Provider shall promptly notify the applicable Recipient of, and coordinate with the Recipient the response to and settlement of, any claim for Taxes asserted by applicable taxing authorities for which the Recipient is alleged to be financially responsible hereunder. Notwithstanding the above, the Recipient's liability for such Taxes is conditioned upon the Provider providing the Recipient notification within ten (10) business days of receiving any proposed assessment of any additional Taxes, interest or penalty due by the Provider.

(d) Each Recipient shall be entitled to receive and to retain any refund of Taxes paid to a Provider pursuant to this Agreement. In the event a Provider shall be entitled to receive a refund of any Taxes paid by a Recipient to the Provider, the Provider shall promptly pay, or cause the payment of, such refund to the Recipient.

(e) Each of the parties agrees that if reasonably requested by the other party, it will cooperate with such other party to enable the accurate determination of such other party's tax liability and assist such other party in minimizing its tax liability to the extent legally permissible. The Provider's invoices shall separately state the amounts of any Taxes the Provider is proposing to collect from the Recipient.

23

---

SECTION 10.07. Regulatory Approval and Compliance. Each of GE and the Company shall be responsible for its own compliance with any and all Laws applicable to its performance under this Agreement; provided, however, that each of GE and the Company shall, subject to reimbursement of out-of-pocket expenses by the requesting party, cooperate and provide one another with all reasonably requested assistance (including, without limitation, the execution of documents and the provision of relevant information) required by the requesting party to ensure compliance with all applicable Laws in connection with any regulatory action, requirement, inquiry or examination related to this Agreement or the Services.

SECTION 10.08. Severability. If any term or other provision of this Agreement is invalid, illegal or incapable of being enforced under any Law or as a matter of public policy, all other conditions and provisions of this Agreement shall nevertheless remain in full force and effect. Upon such determination that any term or other provision is invalid, illegal or incapable of being enforced, the parties to this Agreement shall negotiate in good faith to modify this Agreement so as to effect the original intent of the parties as closely as possible in a mutually acceptable manner in order that the transactions contemplated by this Agreement be consummated as originally contemplated to the greatest extent possible.

SECTION 10.09. Entire Agreement. Except as otherwise expressly provided in this Agreement, this Agreement (including the Schedules hereto) constitutes the entire agreement of the parties hereto with respect to the subject matter of this Agreement and supersedes all prior agreements and undertakings, both written and oral, between or on behalf of the parties hereto with respect to the subject matter of this Agreement.

SECTION 10.10. Assignment; No Third-Party Beneficiaries. This Agreement shall not be assigned by any party hereto without the prior written consent of the other party; provided, however, that (i) in the event the Company sells all or part of the Genworth Business (a "Genworth Divested Unit") to a third party, GE shall remain obligated to continue to provide GE Services to such Genworth Divested Unit (but not otherwise to such third party acquirer) to the extent it was providing such GE Services immediately prior to such divestiture, pursuant to the terms of this Agreement, unless otherwise agreed upon by the parties hereto, (ii) in the event GE sells all or part of the Retained Businesses (a "GE Divested Unit") to a third party, the Company shall remain obligated to continue to provide Company Services to such GE Divested Unit (but not otherwise to such third party acquirer) to the extent it was providing such Company Services immediately prior to such divestiture, pursuant to the terms of this Agreement, unless otherwise agreed upon by the parties hereto, (iii) in the event the Company acquires a business or portion thereof by merger, stock purchase, asset purchase, reinsurance or other means (a "Genworth Acquired Unit"), then GE shall be obligated to provide the GE Services to such Genworth Acquired Unit, to the extent applicable, pursuant to the terms of this Agreement, unless otherwise agreed upon by the parties hereto; provided, however, that in the event that the acquisition of a Genworth Acquired Unit results in a change in the volume or quantity of any GE Service which thereby causes a material increase in GE's cost to provide such GE Service, then the parties hereto shall negotiate in good faith and use their commercially reasonable efforts to agree upon a mutually agreeable price adjustment for such GE Service to compensate GE for such increased costs, and (iv) in the event GE acquires a business that engages in a business of the type engaged in by the Retained Businesses (a "GE Acquired Unit"), then the Company shall be obligated to provide the Company Services to such GE Acquired

24

---

Unit, to the extent applicable, pursuant to the terms of this Agreement, unless otherwise agreed upon by the parties hereto; provided, however, that in the event that the acquisition of a GE Acquired Unit results in a change in the volume or quantity of any Company Service which thereby causes a material increase in the Company's cost to provide such Company Service, then the parties hereto shall negotiate in good faith and use their commercially reasonable efforts to agree upon a mutually agreeable price adjustment for such Company Service to compensate the Company for such increased costs. Nothing in clause (iv) of the preceding sentence shall be deemed to waive any party's rights or relieve or otherwise satisfy any party's obligations under Section 6.12 of the Master Agreement. Notwithstanding the foregoing, GE's obligation to provide Services to a Genworth Divested Unit and the Company's obligation to provide Services to a GE Divested Unit shall be subject to (A) at the sole discretion of the Provider of the Services, the implementation of new Service Charges (solely with respect to Services to be provided to such Divested Unit) proposed by the Provider of such Services that are consistent with applicable market rates for such Services; (B) the seller of such Divested Unit or the third party purchaser of such Divested Unit agreeing to pay, or cause to be paid, any incremental fees or expenses incurred by the Provider in connection with establishing or transitioning the provision of such Services to the third party; (C) obtaining any consents that are necessary to enable the Provider to provide the Services to the third party; provided, that GE and the Company shall each use commercially reasonable efforts to obtain any such consents; (D) the third party purchaser of such Divested Unit agreeing to any reasonable security measures implemented by the Provider in providing the Services as deemed necessary by the Provider to protect its Information Systems; and (E) the third party purchaser of such Divested Unit agreeing in writing to be bound by all applicable provisions of this Agreement. Except as provided in Article VII with respect to Provider Indemnified Parties and Recipient Indemnified Parties,

this Agreement is for the sole benefit of the parties to this Agreement and their permitted successors and assigns and nothing in this Agreement, express or implied, is intended to or shall confer upon any other Person any legal or equitable right, benefit or remedy of any nature whatsoever under or by reason of this Agreement.

SECTION 10.11. Amendment. No provision of this Agreement may be amended or modified except by a written instrument signed by all the parties to such agreement. No waiver by any party of any provision hereof shall be effective unless explicitly set forth in writing and executed by the party so waiving. The waiver by either party hereto of a breach of any provision of this Agreement shall not operate or be construed as a waiver of any other subsequent breach.

SECTION 10.12. Rules of Construction. Interpretation of this Agreement shall be governed by the following rules of construction: (a) words in the singular shall be held to include the plural and vice versa and words of one gender shall be held to include the other gender as the context requires, (b) references to the terms Article, Section, paragraph, and Schedule are references to the Articles, Sections, paragraphs, and Schedules to this Agreement unless otherwise specified, (c) the word "including" and words of similar import shall mean "including, without limitation," (d) provisions shall apply, when appropriate, to successive events and transactions, (e) the headings contained herein are for reference purposes only and shall not affect in any way the meaning or interpretation of this Agreement and (f) this Agreement shall be construed without regard to any presumption or rule requiring construction or interpretation against the party drafting or causing any instrument to be drafted. Unless

25

---

specifically stated in the Master Agreement that a particular provision of the Master Agreement should be given effect in lieu of a conflicting provision in this Agreement, to the extent that any provision contained in this Agreement conflicts with, or cannot logically be read in accordance with, any provision of the Master Agreement, the provision contained in this Agreement shall prevail.

SECTION 10.13. Counterparts. This Agreement may be executed in one or more counterparts, and by the different parties to each such agreement in separate counterparts, each of which when executed shall be deemed to be an original but all of which taken together shall constitute one and the same agreement. Delivery of an executed counterpart of a signature page to this Agreement by facsimile shall be as effective as delivery of a manually executed counterpart of any such Agreement.

SECTION 10.14. No Right to Set-Off. The Recipient shall pay the full amount of costs and disbursements including Other Costs incurred under this Agreement, and shall not set-off, counterclaim or otherwise withhold any other amount owed to the Provider on account of any obligation owed by the Provider to the Recipient.

[SIGNATURE PAGE FOLLOWS]

26

---

IN WITNESS WHEREOF, the parties have caused this Agreement to be executed on the date first written above by their respective duly authorized officers.

GENERAL ELECTRIC COMPANY

By: \_\_\_\_\_  
Name:  
Title:

GENERAL ELECTRIC CAPITAL CORPORATION

By: \_\_\_\_\_  
Name:  
Title:

GE FINANCIAL ASSURANCE HOLDINGS, INC.

By: \_\_\_\_\_  
Name:  
Title:

GEI, INC.

By: \_\_\_\_\_  
Name:  
Title:

GNA CORPORATION

By: \_\_\_\_\_  
Name:  
Title:

27

---

GE ASSET MANAGEMENT INCORPORATED

By: \_\_\_\_\_

Name: \_\_\_\_\_  
Title: \_\_\_\_\_

GENERAL ELECTRIC MORTGAGE HOLDINGS LLC

By: \_\_\_\_\_  
Name: \_\_\_\_\_  
Title: \_\_\_\_\_

GENWORTH FINANCIAL, INC.

By: \_\_\_\_\_  
Name: \_\_\_\_\_  
Title: \_\_\_\_\_

28

**SCHEDULE A**

**GE SERVICES**

<u>Items/Service</u>	<u>Billing Rate or Payment Methodology</u>	<u>Service Termination Date</u>
<b>Finance and Related Services</b>		
1. <u>Web Cash Banking</u> The Company will continue to have access to and use of GE's Web Cash Banking Application for data feeds, including General Ledger interface.	Actual costs via the allocation methodology developed for all GE components. Unit costs will not exceed the 2003 rates.	The earlier of the date on which GE's ownership interest in the Company drops below 30% or the completion of the Company's transition.
2. <u>Cash Banking (Europe, Canada and Australia)</u> The Company will continue to have access to and use of GE's Gateway Cash Banking Application	Actual costs via the allocation methodology developed for all GE components. Unit costs will not exceed the 2003 rates.	The earlier of the date on which GE's ownership interest in the Company drops below 30% or the completion of the Company's transition.
3. <u>Bank Account Administration (Global)</u> The Company will continue have access to and use of GE's BAAS system for the establishment of bank accounts. Country specific bank accounts established through GE arrangements will be maintained (e.g., various European countries)	Actual costs via the allocation methodology developed for all GE components. Unit costs will not exceed the 2003 rates.	The earlier of the date on which GE's ownership interest in the Company drops below 30% or the completion of the Company's transition.
4. <u>Treasury BRM (Global)</u> The Company will continue to have access to and use of GE's BRM (Weiland) system, which is managed by GE's Treasury Department.	Actual costs via the allocation methodology developed for all GE components. Unit costs will not exceed the 2003 rates.	The earlier of the date on which GE's ownership interest in the Company drops below 30% or the completion of the Company's transition.
5. <u>Tax Systems (Global)</u> The Company will continue to have access to, and receive data and technical support from, all of GE's Tax Systems, including, but not limited to, DCS, VantageTax(tm), GHOST, FIR, GTAS, STARS (and STARS Package), VFR, GOLD, DST (disclosure statement tool), PTS (partnership tracking system),	Actual costs via the allocation methodology developed for all GE components allocated to all items that are related to tax services in this Schedule A of this Agreement (item #'s 5-11). Unit costs will not exceed the 2004 rates.	The earlier of the Trigger Date +6 months or the completion of the Company's transition.

29

<u>Items/Service</u>	<u>Billing Rate or Payment Methodology</u>	<u>Service Termination Date</u>
OSCAR (state tax calendar) and other systems.		
6. <u>State Tax Compliance (US)</u> GE will continue to provide state and local income and franchise tax services including the preparation and the filing of all of the state local income and franchise tax returns consistent with past practice by GE.	Actual costs via the allocation methodology developed for all GE components allocated to all items that are related to tax services in this Schedule A of this Agreement (item #'s 5-11). Unit costs will not exceed the 2004 rates.	The earlier of the Trigger Date or the completion of the Company's transition.
7. <u>State Tax Planning (US)</u> GE will continue to provide state and local tax consulting services consistent with past practice by GE.	Actual costs via the allocation methodology developed for all GE components allocated to all items that are related to tax services in this Schedule A of this Agreement (item #'s 5-11). Unit costs will not exceed the 2004 rates.	The earlier of the Trigger Date or completion of the Company's transition.
8. <u>U.S. Tax Compliance (US)</u> GE will continue to provide federal tax services including the access to the tax return software which includes the functionality for the preparation and the filing of all U.S. federal tax returns consistent with past practice by GE.	Actual costs via the allocation methodology developed for all GE components allocated to all items that are related to tax services in this Schedule A of this Agreement (item #'s 5-11). Unit costs will not exceed the 2004 rates.	The earlier of the Trigger Date or the completion of the Company's transition.

9. <u>U.S. Tax Planning (US)</u> GE will continue to provide federal tax consulting services consistent with past practice by GE.	Actual costs via the allocation methodology developed for all GE components allocated to all items that are related to tax services in this Schedule A of this Agreement (item #'s 5-11). Unit costs will not exceed the 2004 rates.	The earlier of the Trigger Date or the completion of the Company's transition.
10. <u>Non-U.S. Tax Compliance (Global)</u> GE will continue to provide global tax services including the preparation and the filing of non-U.S. tax returns consistent with past practice by GE.	Actual costs via the allocation methodology developed for all GE components allocated to all items that are related to tax services in this Schedule A of this Agreement (item #'s 5-11). Unit costs will not exceed the 2004 rates.	The earlier of the Trigger Date or the completion of the Company's transition.
11. <u>Non-U.S. Tax Planning (Global)</u> GE will continue to provide global tax consulting	Actual costs via the allocation methodology developed for all GE components allocated to all	The earlier of the Trigger Date or the completion of the Company's transition.

30

<u>Items/Service</u>	<u>Billing Rate or Payment Methodology</u>	<u>Service Termination Date</u>
services consistent with past practice by GE.	items that are related to tax services in this Schedule A of this Agreement (item #'s 5-11). Unit costs will not exceed the 2004 rates.	
12. <u>Credit Card Administration (Global)</u> The Company's employees will continue to be able use GE Corporate Credit Cards for business-related purchases (including Amex contract in Europe).	Actual costs via the allocation methodology developed for all GE components. Unit costs will not exceed the 2003 rates.	The earlier of the Trigger Date or completion of the Company's transition to a new benefit and payroll system.
13. <u>GAAP Reference (Global)</u> The Company will continue to have access to and use of GE's GAAP Reference materials and personnel.	No Charge.	The earlier of the Trigger Date + six months or completion of the Company's transition
14. <u>Corporate Freight Processing (Global)</u> The Company will continue to utilize the Corporate Freight Payment Center for Freight Processing and Administration	Actual costs via the allocation methodology developed for all GE components.	The earlier of the Trigger Date or completion of the Company's transition.
15. <u>Corporate Audit Staff (Global)</u> The Company will continue to have access to and use of the GE Corporate Audit Staff (including for business integration purposes).	Actual costs via the allocation methodology developed for all GE components.	The later of (i) the Trigger Date, (ii) the end of the Company's second fiscal quarter of 2005 or (iii) completion of the Company's transition.
16. <u>IBS (Global)</u> Access to and use of GE's Intercompany Billing System	Actual costs via the allocation methodology developed for all GE components.	The earlier of the Trigger Date plus 6 months or completion of the Company's transition.
17. <u>Treasury Services (Global)</u> Operational and Consulting Process Changes for bank accounts and cash pooling transition	Actual costs via the allocation methodology developed for all GE components.	The earlier of the Trigger Date or completion of the Company's development of in-house capability.
18. <u>Treasury Services (Europe &amp; Australia)</u> GE will continue to provide all required treasury support functions which are performed today	Actual costs via the allocation methodology developed for all GE components.	The earlier of the Trigger Date or completion of the Company's transition.
19. <u>Financial Reporting Tools (Global)</u>	Actual costs via the allocation methodology	For as long as the Company is required to

31

<u>Items/Service</u>	<u>Billing Rate or Payment Methodology</u>	<u>Service Termination Date</u>
The Company will continue to have access to and use of GE Financial Reporting Applications including Data Parking Lot/CDR, STAR and WRI.	developed for all GE components.	provide financial information to GE pursuant to the Master Agreement
20. <u>Financial Systems (Australia)</u> GE will provide access to and use of applications and support on all shared financial systems provided by GE such as Oracle Financials, Oracle Discoverer, Oracle Financial Analyzer to the Company's Mortgage Division in Australia.	Actual costs via the allocation methodology developed for all GE components.	The earlier of one year from Trigger Date or the completion of the Company's transition.
21. <u>Financial Systems Support (Europe)</u> GE will provide existing finance systems service support and administration as per the remit of the current Finance Systems group center of excellence.	Actual costs via the allocation methodology developed for all GE components.	The earlier of one year from Trigger Date or the completion of the Company's transition.
22. <u>Shared Services (Europe)</u> The GE Shared Services Centers in Europe will continue to provide shared services support as currently provided including accounting, tax, supplier payments).	Actual costs via the allocation methodology developed for all GE components.	Trigger Date + one year

23. <u>Shared Services (Japan)</u> GE will continue to provide through its offices at Kowas 35 Building, Tokyo, Japan HR, finance (Billing), IT, Administration, and Facility support to the Company's Mortgage Insurance division.	Actual costs via the allocation methodology developed for all GE components.	The earlier of Trigger Date plus twelve months or completion of the Company's transition.
24. <u>Account Reconciliation (Europe &amp; Australia)</u> GE will continue to provide Account Reconciliation Tools and Support	Actual costs via the allocation methodology developed for all GE components.	The earlier of the Trigger Date plus six months or completion of the Company's transition.
25. <u>Account Reconciliation (US, Australia &amp; Canada)</u> GE will continue to provide the Company with access to and use of the Account Reconciliation system developed and hosted by GE's ERC division.	Actual costs via the allocation methodology developed for all GE components.	The earlier of the Trigger Date plus six months of the completion of the Company's transition.

32

<u>Items/Service</u>	<u>Billing Rate or Payment Methodology</u>	<u>Service Termination Date</u>
26. <u>Portfolio Analyzer – Derivatives (US)</u> GE will provide the Company with access to and use of its Derivative Portfolio Analyzer Systems.	No charge as long as Investment Management Agreements (IMAs) are in effect (included in fees payable by the Company under IMA); Post IMA termination – actual costs via the allocation methodology developed for all GE components.	The earliest of the Trigger Date +12 Months or Termination of the IMA + 6 months or completion of the Company's transition
27. <u>CATS (US)</u> GE will provide the Company with access to and use of its CATS Research Tracking & Reporting System	No Charge as long as Investment Management Agreements (IMA) are in effect (included in fees payable by the Company under IMA); Post IMA termination – Actual costs via the allocation methodology developed for all GE components.	The earliest of the Trigger Date + 12 months or termination of IMA + 6 months or completion of the Company's transition
28. <u>Controllership (Europe)</u> GE to provide continued access to and participation in the European Controllership Council	No charge	Trigger Date
29. <u>T&amp;L Administration (US)</u> GE will continue to provide the Company with access to and use of its Travel Management systems, services, and administration.	Combination of actual travel costs plus administrative allocation.	Trigger Date
30. <u>Derivatives Accounting (Global)</u> GE will provide the Company with access to and use of its MONSTER derivatives accounting application	No charge as long as Investment Management Agreements (IMAs) are in effect (included in fees payable by the Company under IMA); Post IMA termination – actual costs via the allocation methodology developed for all GE components	The earliest of the Trigger Date + 12 months or Termination of the IMA + 6 months or completion of the Company's transition.
31. <u>Treasury Services (Europe)</u> GE will continue to provide the Company with access to and use of GE's TRS system while it is managed by GE's treasury department.	Actual payroll costs and the expense allocation methodology developed for all GE components.	The earlier of the date on which GE's ownership interest in the Company drops below 30% or the completion of the Company's transition.

33

<u>Items/Service</u>	<u>Billing Rate or Payment Methodology</u>	<u>Service Termination Date</u>
<b>Human Resources and Related Services</b>		
32. <u>GEII/GMS (Global)</u> The Company will continue to have access to and use of GE's expatriate, ISOS emergency medical treatment and evacuation services.	Actual costs via the allocation methodology developed for all GE components.	Trigger Date (or up to six months later by mutual consent)
33. <u>Payroll Administration (Global)</u> The Company's payroll will continue to be processed and administered by GE through its facilities at CBSI, Leeds and other locations covering countries in which the Company has any employees.	Actual payroll costs and the expense allocation methodology developed for all GE components.	Trigger Date (US); Trigger Date (or up to six months later by mutual consent) (non-US)
34. <u>U.S. Benefit Plan Design &amp; Administration</u> GE will administer all US benefit plans that the Company's employees were eligible to participate in immediately prior to this Agreement and which they will continue to participate in pursuant to the Employee Matters Agreement.	Actual costs and the expense allocation methodology developed for all GE components.	Trigger Date

35. <u>Non U.S. Employee Benefits Services</u> GE will administer all non-US benefit plans that the Company's employees were eligible to participate in immediately prior to this Agreement and which they will continue to participate in pursuant to the Employee Matters Agreement wherever the Company has any employees.	Actual costs and the expense allocation methodology developed for all GE components.	Trigger Date (or up to six months later by mutual consent)
36. <u>Workers Compensation (Global)</u> The Company's employees will continue to participate in, and GE will continue to administer the Workers Compensation insurance program.	Actual costs and the expense allocation methodology developed for all GE components.	Trigger Date (or up to six months later by mutual consent)
37. <u>Leadership Courses (Global)</u> The Company's employees will continue to be able to attend courses hosted at the Jack Welch Leadership Center in Crotonville, New York. GE will permit the Company to send the same number of students to	Actual costs via the allocation methodology developed for all GE components.	Trigger Date

34

<u>Items/Service</u>	<u>Billing Rate or Payment Methodology</u>	<u>Service Termination Date</u>
Crotonville classes in 2004 as it permitted in 2003.		
38. <u>Executive Comp Administration (Global)</u> The Company's employees may continue to participate in a combination of GE Executive and Company Executive Compensation and other programs pursuant to the Employee Matters Agreement, including executive medical examinations, automobile leasing and financial counseling.	Actual costs and the expense allocation methodology developed for all GE components.	Trigger Date
39. <u>Other HR Related Applications</u> <ul style="list-style-type: none"> <li>• Mergers and Acquisitions (Global)</li> <li>• HR Practices (Global)</li> <li>• GE Opinion Survey (Global)</li> <li>• GE Survey Suite (Global)</li> <li>• eHR (Global)</li> <li>• HR Privacy (Global)</li> <li>• Employee Services Portal (Global)</li> <li>• Resolve (US)</li> <li>• Benefits Integration (US)</li> <li>• Benefits Access (US)</li> <li>• Oracle HR Data Mart (US)</li> <li>• Join GE (US)</li> <li>• eEMS (Global)</li> <li>• Compensation Planning (US)</li> <li>• Career Opportunity System (Global)</li> <li>• eSession C (Global)</li> <li>• eExit (Global)</li> <li>• eStart (Global)</li> <li>• Government HR Reporting System (EEOC, etc.) (US)</li> <li>• 360 Degree Peer Evaluation System (Global)</li> <li>• Union Awareness (Global)</li> <li>• ELearning</li> </ul>	No Charge	Trigger Date

35

<u>Items/Service</u>	<u>Billing Rate or Payment Methodology</u>	<u>Service Termination Date</u>
<ul style="list-style-type: none"> <li>• My Development</li> <li>• Employee Verification</li> </ul>		
40. <u>Oracle HR (Global)</u> Access to and use of Oracle HR application.	Actual costs and the expense allocation methodology developed for all GE components.	Trigger Date
41. <u>Hire Systems (Global)</u> Access to and use of GE's vendor-operated hiring management system.	Actual costs and the expense allocation developed for all GE components	Trigger Date
42. <u>RMLP, HRLP, FMP &amp; IMLP Administration (Global)</u> Education for GE's Management Leadership Programs.	Actual costs via the allocation methodology developed for all GE components.	Trigger Date

43. <u>EIMP Administration (Global)</u> Administrative, recruiting, education, and off-program support for GE's Experienced Information Management Program.	Actual costs via the allocation methodology developed for all GE components.	Second anniversary of the Trigger Date.
44. <u>Corporate Sourced External HR Services (Global)</u> Use of services purchased in bulk by GE Corporate HR on behalf of GE businesses, e.g., background checks, job postings, etc.	Actual cost and the expense allocation developed for all GE components.	Trigger Date.

**Legal and Related Services**

45. <u>Legal Practice Groups, Legal &amp; Compliance Meetings, and Legal &amp; Compliance Distribution Lists (Global)</u> The Company will continue to have access to and the opportunity to participate in GE's Legal Practice Groups and Legal and Compliance meetings at regional, national, and pole levels. GE shall include the Company's legal and compliance staff on all GE	No Charge other than meeting fees charged to all participants	Trigger Date.
---	---	---------------

<u>Items/Service</u>	<u>Billing Rate or Payment Methodology</u>	<u>Service Termination Date</u>
legal and compliance distribution lists.		
46. <u>eInvoicing (US)</u> The Company will continue to have access to and use of the electronic law firm billing, routing, review, and approval system.	Actual costs via the allocation methodology developed for all GE components.	Trigger Date.
47. <u>GOLDnet (Global)</u> The Company will continue to have access to and use of GE's legal entity database	Actual costs via the allocation methodology developed for all GE components.	When the Company is no longer included in GOLDnet
48. <u>GE Legal Intranet (Global)</u> The Company will have continue to have access to and use of GE's intranet set for the legal community.	Actual costs via the allocation methodology developed for all GE components.	Trigger Date
49. <u>Westlaw Database (Global)</u> The Company will have access to and use of the Westlaw database.	Actual costs billed via the allocation methodology developed for all GE components.	Trigger Date
50. <u>Pay and Benefit Legal Support (Global)</u> GE will provide legal counsel related to the Company's historic and continuing participation in GE's payroll systems and benefit plans.	No Charge	Legal counsel terminates when the Company no longer participates in the applicable benefit plan. Legal representation is provided for any claim related to a GE benefit plan regardless of when the claim arises. Legal representation is provided for any claim related to a GE payroll system consistent with past practice.
51. <u>eCommerce Related Legal Support (US)</u> The Retained Businesses will provide legal support of the Company's websites.	No Charge	90 days from the date hereof.
52. <u>Government Relations (Global)</u> GE will assist and provide the Company with: <ul style="list-style-type: none"> <li>Global lobbying efforts and cooperation in accessing Government Officials to facilitate the Company's transition</li> </ul>	No Charge	Trigger Date except access to K. Fulton for the Mortgage business (1/1/05) and coordination regarding tax and financial services issues (Trigger Date plus six months)

<u>Items/Service</u>	<u>Billing Rate or Payment Methodology</u>	<u>Service Termination Date</u>
----------------------	--	---------------------------------



<ul style="list-style-type: none"> <li>• Access to GE Washington office (K. Fulton, N. Dorn, P. Prowitt) to facilitate the Company's transition and introductions</li> <li>• Access to B. Mattox as a resource regarding the Company's tax matters</li> <li>• Coordination to ensure harmonization of tax issues and financial services issues involving GE and the Company</li> <li>• Access to K. Fulton to assist in the transitioning of the mortgage business to the Company including without limitation assistance with issues related to Fannie Mae and Freddie Mac</li> <li>• Continued equivalent access to GE State Level Resources</li> <li>• Consultation by K. Riordan and state-based GE liaison on matters relating to the Company's development of state retainers, networks and national political organizations</li> <li>• Maintaining state tax support for the Company</li> <li>• Access to state retained lobbyists for consultation and engagement by the Company</li> <li>• Access to GE Country Managers and use of GE resources during transition, specifically Corporate IL&amp;P and consultation by GE Country Managers for introduction of the Company's new international leaders including without limitation introduction of the Company's Mortgage Insurance leaders for Asia</li> <li>• GE Country Managers to provide assurances to the Canadian Government that GE's interests are aligned with maintaining the current strength and viability of the Company's Canadian Mortgage operations and meet with Canadian Government to facilitate the Company's introduction to the Canadian Government</li> </ul>		
<p>53. <u>Legal Preferred Provider Arrangements (Global)</u> The Company will be entitled to the law firm rates GE</p>	<p>No Charge.</p>	<p>Until GE ownership in the Company drops below 10%.</p>

<u>Items/Service</u>	<u>Billing Rate or Payment Methodology</u>	<u>Service Termination Date</u>
<p>negotiates with preferred providers.</p>		
<p>54. <u>Public Relations – Media Activity System (MAS) (Global)</u> The Company will continue to have access to and use of MAS.</p>	<p>Actual costs via the allocation methodology developed for all GE components.</p>	<p>Trigger Date plus 6 months</p>
<p>55. <u>GE Ombudsman (Global)</u> GE shall route all Company-related inquiries to the GE ombudsman to the Company's ombudsman.</p>	<p>No Charge</p>	<p>Until GE ownership in the Company drops below 10%</p>
<p>56. <u>Practical Law (Europe)</u> The Company will continue to have access to and use of this European monthly magazine and database.</p>	<p>Actual costs via the allocation methodology developed for all GE components. Unit costs will not exceed 2003 rates.</p>	<p>Trigger Date</p>
<p>57. <u>Transaction Control Authority (Global)</u> The Company will continue to have access to and use of GE's Transaction Control Authority and related software.</p>	<p>Actual costs via the allocation methodology developed for all GE components.</p>	<p>Trigger Date.</p>
<p>58. <u>Do Not Call List (US)</u> The Company will continue to have access to and use of GE's and/or the Retained Businesses' Do Not Call List and related software.</p>	<p>Actual costs via the allocation methodology developed for all GE components.</p>	<p>Trigger Date.</p>
<p>59. <u>Watch List (Global)</u> The Company will continue to have access to and use of GE's Watch List (OFAC, etc.) and Watch List Database Search, used for security screening</p>	<p>Actual costs via the allocation methodology developed for all GE components.</p>	<p>Trigger Date</p>
<p>60. <u>Trademark Searches, Registrations and Maintenance (Global)</u> GE will continue its maintenance services for all trademarks existing as of the date hereof and used or owned by the Company and will perform trademark searches and new registrations upon the Company's</p>	<p>Actual costs via the allocation methodology developed for all GE components.</p>	<p>Trigger Date</p>

<u>Items/Service</u>	<u>Billing Rate or Payment Methodology</u>	<u>Service Termination Date</u>
request.		
61. <u>Non-U.S. Patent Filing and Prosecution (Global)</u> Upon the Company's request, GE will file, prosecute, and pay maintenance fees for the Company's non-U.S. patent applications.	Actual costs via the allocation methodology developed for all GE components.	Trigger Date
62. <u>Domain Name Services (DNS) Registration and Maintenance (Global)</u> GE will continue its maintenance services for all URLs existing as of the date hereof and used or owned by the Company and will perform new registrations upon the Company's request.	Actual costs via the allocation methodology developed for all GE components.	Trigger Date
63. <u>GE PAGE System (Global)</u> The Company will continue to have use of and access to GE's PAGE system, a software tool and database for patent matters on the same basis as it is made available to the other GE components.	Actual costs via the allocation methodology developed for all GE components.	Trigger Date
64. <u>Holocaust Reporting (US)</u> GE's ERC division shall prepare and make all US regulatory filings related to the Holocaust on behalf of itself, the Company and any other affiliate insurance companies owned in whole or in part by GE. The Company shall provide ERC on a timely basis with all required information.	Actual costs via the allocation methodology developed for all GE components	The earlier of the first date upon which consolidated filings are no longer required by insurance regulators and the date upon which GE's ownership in the Company falls below 10%
<b>IT – Misc Application, Infrastructure &amp; Related Services</b>		
65. <u>Infrastructure Support (US)</u> GE will continue to provide Web Hosting, Local Area Network, Desktop, and Server Support to the Company's Capital Management Services team	Actual costs via the allocation methodology developed for all GE components.	First Anniversary of the Trigger Date

40

<u>Items/Service</u>	<u>Billing Rate or Payment Methodology</u>	<u>Service Termination Date</u>
(CMS) based in New York, New York.		
66. <u>e-Mail Processing (Global)</u> GE will continue to provide SMTP relay, spam filtering, and e-Mail support, including Blackberry Wireless service, to the Company.	Actual costs via the allocation methodology developed for all GE components.	Trigger Date
67. <u>eDealRoom (US)</u> Access to and use of Deal Room Work Flow application.	Actual costs via the allocation methodology developed for all GE components.	Trigger Date.
68. <u>Support Central (Global)</u> GE will continue to provide support, access to and use of Support Central.	Actual costs via the allocation methodology developed for all GE components.	Trigger Date.
69. <u>IP re Address Routing (Global)</u> GE will route the Company's GE-assigned 3.0.0.0 network and 205.173.90.0 subnets within GE.	Actual costs via the allocation methodology developed for all GE components.	Trigger Date.
70. <u>IP Address Use (Global)</u> GE will allow use of the Company's GE-assigned 3.0.0.0 subnet within the Company	Actual costs via the allocation methodology developed for all GE components.	The earlier of the first anniversary of the Trigger Date or completion of the Company's transition
71. <u>SSO (Global)</u> Access to and use of Single Sign On ("SSO") and administration support for users of the Company's external web sites.	Actual costs via the allocation methodology developed for all GE components.	The earlier of the Trigger Date or the completion of the Company's transition.
72. <u>Remote Office Application (US)</u> Access to and use of the remoteoffice.ge.com application.	Actual costs via the allocation methodology developed for all GE components.	The earlier of the Trigger Date or the completion of the Company's transition.
73. <u>Document Repository (Global)</u> Access to and use of the Internet based Quickplace application for sharing documents with employees	Actual costs via the allocation methodology developed for all GE components.	The earlier of the Trigger Date or the completion of the Company's transition.

41

<u>Items/Service</u>	<u>Billing Rate or Payment Methodology</u>	<u>Service Termination Date</u>
outside of GE and the Company.		

74. <u>Messaging System (Global)</u> Support of the Sametime Environment.	Actual costs via the allocation methodology developed for all GE components.	Trigger Date
75. <u>Integrity Website (Global)</u> GE will continue to provide access to its internal Integrity Website.	Actual costs via the allocation methodology developed for all GE components.	Trigger Date
76. <u>e-Mail address change (Global)</u> Access to and use of <employee>@ge.com.	Actual costs via the allocation methodology developed for all GE components.	Trigger Date
77. <u>Space on the GE Website (Global)</u> GE will continue to contain information about the Company's products on the GE website, from which potential customers of the Company may be transferred to the Company's Website.	Actual costs via the allocation methodology developed for all GE components.	Trigger Date.
78. <u>InsideGE System (Global)</u> GE will continue to provide the Company's employees with access to and use of GE's InsideGE intranet application and all associated web sites with the same access as provided immediately prior to the date hereof.	Actual costs via the allocation methodology developed for all GE components.	Trigger Date.
79. <u>Credit Checks (Global)</u> GE will continue to provide credit research services from its Alpharetta services.	Actual costs via the allocation methodology developed for all GE components.	The earlier of the Trigger Date or the Company's transition.
80. <u>MySixSigma (Global)</u> GE will continue to provide access to and use of the MySixSigma system.	Actual costs via the allocation methodology developed for all GE components.	The earlier of the first anniversary of the Trigger Date or the completion the Company's transition to its own system.
81. <u>Six Sigma Tracking (Global)</u> GE will continue to provide access to and use of the Six Sigma tracking system.	Actual costs via the allocation methodology developed for all GE components.	The earlier of the first anniversary of the Trigger Date or the completion the Company's transition to its own system.

42

<u>Items/Service</u>	<u>Billing Rate or Payment Methodology</u>	<u>Service Termination Date</u>
82. <u>International Contractor Metrics (Global)</u> GE will provide the Company with access to and use of the eMeasure system for International contractor reporting and tracking.	Actual costs via the allocation methodology developed for all GE components.	The earlier of the Trigger Date or the completion of the Company's transition.
83. <u>Database Marketing &amp; Analysis Support (US)</u> GE will provide the Company with access to and use of the GEFA Customer Database	Actual costs via the allocation methodology developed for all GE components.	Trigger Date.
84. <u>Database Marketing &amp; Analysis Support (US)</u> GE will provide the Company with access to and use of the Consumer Analytics Platform	Actual costs via the allocation methodology developed for all GE components.	Trigger Date + twelve months
85. <u>Database Marketing &amp; Analysis Support (US)</u> GE will provide the Company with access to and use of the Prospect Database and Infrastructure	Actual costs via the allocation methodology developed for all GE components.	Trigger Date + twelve months
86. <u>Infrastructure Support (US)</u> GE will continue to provide Local Area Network, Voice, Desktop, and Server Support to the Company's Independent Accountants Network (IAN).	Actual costs via the allocation methodology developed for all GE components.	First anniversary of the Trigger Date.
87. <u>Infrastructure Support (Europe)</u> GE will continue to provide Local Area Network, Telecommunications equipment support, Voice, Desktop, and Server Support for the Company's locations in Dublin, Germany, Copenhagen and Stockholm	Actual costs via the allocation methodology developed for all GE components.	First anniversary of the Trigger Date.
88. <u>Voice Support (Europe)</u> GE will continue to provide Voice Support for the Company's locations in Helsinki, Oslo and the Netherlands	Actual costs via the allocation methodology developed for all GE components.	First anniversary of the Trigger Date.
89. <u>Deskside Support (US)</u> GE will continue to provide Local Area Network, Voice, Desktop, and Server Support to the Company's employees in Stamford, and the Company's real estate employees in Chicago, Atlanta & Los Angeles	Actual costs via the allocation methodology developed for all GE components.	The earlier of the Trigger Date or completion of the Company's transition
90. <u>Infrastructure Support (Canada)</u>	Actual costs via the allocation methodology	First anniversary of the Trigger Date.

43

<u>Items/Service</u>	<u>Billing Rate or Payment Methodology</u>	<u>Service Termination Date</u>
GE will continue to provide access to and use of the GE Canada LAN system for Company components based in Canada.	developed for all GE components.	
91. <u>Telecommunications Services: (Global)</u> Domestic Outbound, 800 Inbound, Domestic and International Dial Comm, Dial Comm Cards, Domestic Credit Card, International Direct Dial, International Credit Card, GE Global Telecommunications Network, Videoconferencing, Worldcom conference call facilities.	Actual costs via the allocation methodology in effect during the billing period for all GE components. Unit costs, where applicable, are not to exceed 2004 rates until December 31, 2005. The Company will be notified 90 days in advance, as practicable, of any change to the annual unit cost to take effect after December 31, 2005.	First anniversary of the Trigger Date. Use of GE's telecommunication services (either in totality or individual components) can be extended in one-year increments based upon mutual agreement of both the Company and GE.
92. <u>Network Services: (Global)</u> VPN Services; Proxy Server Management, Internet Routers, DNS Management, installation and configuration management; hardware, software, and carrier service provisioning, contract maintenance; Project Management; problem and change control management, E-mail gateway, Spam filters, Nortel remote access and GNO facilitation and coordination of services for WAN, ISP, and MAN Connectivity.	Actual costs via the allocation methodology in effect during the billing period for all GE components. Unit costs, where applicable, are not to exceed 2004 rates until December 31, 2005. The Company will be notified 90 days in advance, as practicable, of any change to the annual unit cost to take effect after December 31, 2005.	First anniversary of the Trigger Date. Use of GE's network services (either in totality or individual components) can be extended in one-year increments based upon mutual agreement of both the Company and GE.
93. <u>Remote Access Services (Global)</u> The Company will continue to have access to the Fibrelink infrastructure for remote access.	Actual costs via the allocation methodology developed for all GE components.	Trigger Date
94. <u>Alpharetta Data Center (US &amp; Canada)</u> Mainframe, Midrange, Storage, Backup, and Network services currently provided by the Alpharetta Data Center.	Actual costs, based on usage, via the allocation methodology developed for all GE components. Units' costs are not to exceed 2003 rates through December 31, 2005. Unit costs for subsequent years will be established on an annual basis. The Company will be notified 90 days in advance, as practicable, of any change to the annual unit cost to take effect after December 31, 2005.	First anniversary of the Trigger Date. The Service can be extended in one-year increments based upon the mutual agreement of both the Company and GE.
95. <u>Cincinnati Data Center (Global)</u> Mainframe, Midrange, Storage, Backup, e-Mail,	Actual costs, based on usage, via the allocation methodology developed for all GE components.	First Anniversary of the Trigger Date. The Service can be extended in one-year

44

<u>Items/Service</u>	<u>Billing Rate or Payment Methodology</u>	<u>Service Termination Date</u>
Intranet, and Network services currently provided by the Cincinnati Data Center managed by GE's Global Communications Operation.	Unit costs are not to exceed 2003 rates through December 31, 2005. Unit costs for subsequent years will be established on an annual basis. The Company will be notified 90 days in advance, as practicable, of any change to the annual unit cost to take effect after December 31, 2005.	increments based upon the mutual agreement of both the Company and GE.
96. <u>Kingswood Data Center (Europe)</u> Mainframe Midrange, Storage, Backup, Security, Asset Management, and Network services currently provided by the Kingswood Data Center.	Actual costs, based on usage, via the allocation methodology developed for all GE components. Units costs are not to exceed 2003 rates through December 31, 2005. Unit costs for subsequent years will be established on an annual basis. The Company will be notified 90 days in advance, as practicable, of any change to the annual unit cost to take effect after December 31, 2005.	The earlier of the Trigger Date plus 24 months or completion of the Company's transition. The Service can be extended in one-year increments based upon the mutual agreement of both the Company and GE.
97. <u>Communications Network (Global)</u> The Company will continue to have access to GE's intranet-based Global Communications Network applications (GECN).	Actual costs, based on usage, via the allocation methodology developed for all GE components.	Trigger Date.
98. <u>IT Technical Councils (Global)</u> The Company will continue to be able to participate in IT technical councils, including, but not limited to the PMO Council, CTO Council and Security Forum & Council.	No Charge	Trigger Date
99. <u>Metadata Directory Services (Global)</u> GE will continue to provide the Company with access to its CDI application for Identify, Directory and Discovery Services.	Actual costs via the allocation methodology developed for all GE components	Trigger Date
100. <u>Helpdesk Management (US)</u> GE shall manage the day-to-day activities of the Company or its contractors providing the Helpdesk, Desktop and Server support services to the retained	Actual costs via the allocation methodology developed for all GE components.	October 22, 2004

45

<u>Items/Service</u>	<u>Billing Rate or Payment Methodology</u>	<u>Service Termination Date</u>
businesses in Lakewood, CO and Ft. Washington, PA.		
<b>Investments</b>		
101. <u>Fixed Income Analytics (Global)</u> GEAM will provide the Company with access to and use of the Fixed Income Analytics Application (Yield Book Desktop Application).	No Charge as long as Investment Management Agreements (IMA) are in effect (included in fees payable by the Company under IMA); Post IMA termination – Actual costs via the allocation methodology developed for all GE components	The earliest of the Trigger Date + 12 months or termination of the IMA + 6 months or signing of a vendor agreement by the Company
102. <u>Fixed Income Analytics and Cash Flows (Global)</u> GEAM will provide the Company with access to and use of the Fixed Income Analytics and Cash Flows Application (BondEdge).	No Charge as long as Investment Management Agreements (IMA) are in effect (included in fees payable by the Company under IMA); Post IMA termination – Actual costs via the allocation methodology developed for all GE components	The earliest of the Trigger Date + 12 months or termination of the IMA + 6 months or signing of a vendor agreement by the Company
103. <u>Bloomberg Desk Top Application (Global)</u> GEAM will provide the Company with access to and use of Bloomberg Desktop Application.	No Charge as long as Investment Management Agreements (IMA) are in effect (included in fees payable by the Company under IMA); Post IMA termination – Actual costs via the allocation methodology developed for all GE components	The earlier of the Trigger Date or termination of the IMA + 6 months or signing of a vendor agreement by the Company
104. <u>Credit Analysis (Global)</u> GEAM will provide the Company with access to and use of the Credit Analysis application (KMV Credit Tool).	No Charge as long as Investment Management Agreements (IMA) are in effect (included in fees payable by the Company under IMA); Post IMA termination – Actual costs via the allocation methodology developed for all GE components	The earlier of the Trigger Date or termination of the IMA + 6 months or signing of a vendor agreement by the Company
105. <u>Risk Monitoring/Cash Hedging (US)</u> GEAM will provide the Company access to and use of the PV01 application.	No Charge as long as Investment Management Agreements (IMA) are in effect (included in fees payable by the Company under IMA); Post IMA termination – Actual costs via the allocation methodology developed for all GE components	The earliest of the Trigger Date + 12 months or termination of the IMA + 6 months or completion of the Company's transition

46

<u>Items/Service</u>	<u>Billing Rate or Payment Methodology</u>	<u>Service Termination Date</u>
106. <u>Portfolio Optimizer (US)</u> GEAM will provide the Company with access to and use of the GRC Optimizer application.	No Charge as long as Investment Management Agreements (IMA) are in effect (included in fees payable by the Company under IMA); Post IMA termination – Actual costs via the allocation methodology developed for all GE components	The earliest of the Trigger Date + 12 months or termination of the IMA + 6 months or completion of the Company's transition
107. <u>Cash Forecasting (US)</u> GEAM will provide the Company with access to and use of the Cash Forecasting system, A2P2.	No Charge as long as Investment Management Agreements (IMA) are in effect (included in fees payable by the Company under IMA); Post IMA termination – Actual costs via the allocation methodology developed for all GE components	The earliest of the Trigger Date + 12 months or termination of the IMA + 6 months or completion of the Company's transition
108. <u>Risk Monitoring Tool (US)</u> GEAM will provide the Company with access to and use of the Risk Monitoring Tools, and REM.	No Charge as long as Investment Management Agreements (IMA) are in effect (included in fees payable by the Company under IMA); Post IMA termination – Actual costs via the allocation methodology developed for all GE components	The earliest of the Trigger Date + 12 months or termination of the IMA + 6 months or completion of the Company's transition
109. <u>Market Data, Trends, and Information (Global)</u> GEAM will provide the Company with access to and use of the market information provided by Reuters.	No Charge as long as Investment Management Agreements (IMA) are in effect (included in fees payable by the Company under IMA); Post IMA termination – Actual costs via the allocation methodology developed for all GE components	The earliest of the Trigger Date or termination of the IMA + 6 months or signing of a vendor agreement by the Company
110. <u>GEAM Bloomberg Data Feed (Global)</u>	No Charge as long as Investment Management Agreements (IMA) are in effect (included in fees payable by the Company under IMA); Post IMA termination – Actual costs via the allocation methodology developed for all GE components	The earlier of the Termination of the IMA + 6 months or signing of a vendor agreement by the Company
111. <u>GEAM KMV Data Feed (Global)</u>	No Charge as long as Investment Management Agreements (IMA) are in effect (included in fees payable by the Company under IMA); Post IMA termination – Actual costs via the allocation methodology developed for all GE components	The earlier of the Termination of the IMA + 6 months or signing of a vendor agreement by the Company

47

<u>Items/Service</u>	<u>Billing Rate or Payment Methodology</u>	<u>Service Termination Date</u>
----------------------	--	---------------------------------

112. <u>GEAM FTID Data Feed (Global)</u>	No Charge as long as Investment Management Agreements (IMA) are in effect (included in fees payable by the Company under IMA); Post IMA termination – Actual costs via the allocation methodology developed for all GE components	The earlier of the Termination of the IMA + 6 months or signing of a vendor agreement by the Company
113. <u>GEAM Moody's and S&amp;P Data Feeds (Global)</u>	No Charge as long as Investment Management Agreements (IMA) are in effect (included in fees payable by the Company under IMA); Post IMA termination – Actual costs via the allocation methodology developed for all GE components	The earlier of the Termination of the IMA + 6 months or signing of a vendor agreement by the Company
114. <u>GEAM Factset Data Feeds (Global)</u>	No Charge as long as Investment Management Agreements (IMA) are in effect (included in fees payable by the Company under IMA); Post IMA termination – Actual costs via the allocation methodology developed for all GE components	The earlier of the Termination of the IMA + 6 months or signing of a vendor agreement by the Company
115. <u>GEAM Intex Data Feeds (Global)</u>	No Charge as long as Investment Management Agreements (IMA) are in effect (included in fees payable by the Company under IMA); Post IMA termination – Actual costs via the allocation methodology developed for all GE components	The earlier of the Termination of the IMA + 6 months or signing of a vendor agreement by the Company
116. <u>GEAM Trepp Data Feeds (Global)</u>	No Charge as long as Investment Management Agreements (IMA) are in effect (included in fees payable by the Company under IMA); Post IMA termination – Actual costs via the allocation methodology developed for all GE components	The earlier of the Termination of the IMA + 6 months or signing of a vendor agreement by the Company
117. <u>GEAM Argus (US)</u>	No Charge as long as Investment Management Agreements (IMA) are in effect (included in fees payable by the Company under IMA); Post IMA termination – Actual costs via the allocation methodology developed for all GE components	The earliest of the Trigger Date + 12 months or termination of the IMA + 6 months or signing of a vendor agreement by the Company
118. <u>GEAM Cirrus (US)</u>	No Charge as long as Investment Management	The earliest of the Trigger Date + 12 months or

48

<u>Items/Service</u>	<u>Billing Rate or Payment Methodology</u>	<u>Service Termination Date</u>
	Agreements (IMA) are in effect (included in fees payable by the Company under IMA); Post IMA termination – Actual costs via the allocation methodology developed for all GE components	termination of the IMA + 6 months or signing of a vendor agreement by the Company
119. <u>Investments New Hire Application (US)</u> The Company will continue to have access to and use of GE's Investments New Hire Application.	No charge as long as Investment Management Agreements (IMA) are in effect (included in fees payable by the Company under IMA); post IMA termination – actual cost via the allocation methodology developed for all GE components.	The earlier of the Trigger Date +12 months or completion of the Company's transition
120. <u>Investments Domino Infrastructure (US)</u> The Company will continue to have access to and use of Investments Domino Infrastructure.	No charge as long as Investment Management Agreements (IMA) are in effect (included in fees payable by the Company under IMA); post IMA termination – actual cost via the allocation methodology developed for all GE components.	The earlier of the Trigger Date +12 months or completion of the Company's transition
121. <u>GEAM Compliance (US)</u> The Company will continue to have access to and use of GEAM's Compliance application.	No charge as long as Investment Management Agreements (IMA) are in effect (included in fees payable by the Company under IMA); post IMA termination – actual cost via the allocation methodology developed for all GE components.	The earlier of the Trigger Date +12 months or completion of the Company's transition
122. <u>Beast (US)</u> The Company will continue to have access to and use of Beast.	No charge as long as Investment Management Agreements (IMA) are in effect (included in fees payable by the Company under IMA); post IMA termination – actual cost via the allocation methodology developed for all GE components.	The earlier of the Trigger Date +12 months or completion of the Company's transition
123. <u>Ref Internet &amp; Intranet</u> The Company will continue to have access to and use of GEAM's Ref Internet and Intranet	No charge as long as Investment Management Agreements (IMA) are in effect (included in fees payable by the Company under IMA); post IMA termination – actual cost via the allocation methodology developed for all GE components.	The earlier of the Trigger Date or completion of the Company's transition
124. <u>Disaster Recovery</u>	No charge as long as Investment Management	The earlier of the Trigger Date + 12 months or

49

<u>Items/Service</u>	<u>Billing Rate or Payment Methodology</u>	<u>Service Termination Date</u>
GEAM will provide the Company with disaster recovery services for the investments-related software provided pursuant to this Agreement.	Agreements (IMA) are in effect (included in fees payable by the Company under IMA); post IMA termination – actual cost via the allocation methodology developed for all GE components.	completion of the Company’s transition
<b>VI Corporate Services</b>		
125. <u>Corporate Jet Services (Global)</u> Includes scheduling and use of GE Corporate Jet and services.	Actual costs via the allocation methodology developed for all GE components.	6 months after Trigger Date.
126. <u>Crotonville (Global)</u> The Company shall have the ability to host seminars, Workout sessions, and other meetings with customers at Crotonville facilities and may utilize Crotonville staff to do so.	Facilities and meeting fees normally charged to other GE components for similar programs.	Two years after Trigger Date.
<b>VII Med Supp Policies</b>		
127. <u>Med Supp Policies (US)</u> Policyholder Services and Claim Servicing Of Approximately 1300Med Supp Policies (VFW CICA, VFW UFLIC and UFLIC at Cambridge)	\$5.0K / month	December 31, 2004
<b>VIII Functions Other Than Above</b>		
128. <u>Real Estate (Global)</u> GE will provide assistance and consultations on all real estate services including legal, insurance, transactional, environmental, security, facilities, rentals, and purchasing	Actual costs via the allocation methodology developed for all GE components.	Trigger Date
129. <u>M&amp;A (Europe and Australia)</u> The Company shall have access to GE Corporate M&A teams for M&A and new market entry opportunities.	Actual costs via the allocation methodology developed for all GE components.	Trigger Date

<u>Items/Service</u>	<u>Billing Rate or Payment Methodology</u>	<u>Service Termination Date</u>
130. <u>Country NX (Europe)</u> Access to GE Country NX’s across Europe to facilitate introductions to potential customers of the Company’s Europe Mortgage unit.	Actual costs via the allocation methodology developed for all GE components.	Trigger Date
131. <u>Marketing (Europe)</u> Access to GE’s European Marketing team to support the Company’s Europe Mortgage unit’s marketing initiatives, including those linked to the ‘GE Days’.	Actual costs via the allocation methodology developed for all GE components.	Trigger Date
132. <u>Capital Markets (Europe)</u> Access to the GE Capital Markets team in London for support on product development, new business sales etc. Support to include monitoring of market developments and preparation and presentation of pitches to current and future customers.	Actual costs via the allocation methodology developed for all GE components.	Trigger Date
133. <u>Sourcing Applications (Global)</u> Access to and use of GE’s Sourcing Systems, including Oracle SSS, eRFP, E-Sourcing, Oracle Purchasing, eAuction and integrated applications.	Actual costs via the allocation methodology developed for all GE components.	The earlier of one year from the Trigger Date or the completion of the Company’s transition.
134. <u>Purchasing Card Processing (Global)</u> The Company will continue to have access to and use of GE’s Paris system for Purchasing Card Administration and Reconciliation, including Program Administration Services.	Actual costs via the allocation methodology developed for all GE components.	The earlier of the Trigger Date or completion of the Company’s transition.
135. <u>Sourcing (Australia)</u> GE will continue to provide Sourcing related services	Actual costs via the allocation methodology developed for all GE components.	The earlier of the Trigger Date or completion of the Company’s transition.
136. <u>Sourcing Data Warehouse (Global)</u> The Company will continue to have access to and use of GE’s sourcing data warehouses, which are GSTAR	Actual costs via the allocation methodology developed for all GE components.	The earlier of one year from the Trigger Date or the completion of the Company’s transition.

<u>Items/Service</u>	<u>Billing Rate or Payment Methodology</u>	<u>Service Termination Date</u>
and Proclarity.		

137. <u>Customer Balance of Trade</u> GE will continue to supply information regarding GE's buy and sell activities with top Company customers including, but not limited to GE Asset Management, GE Corporate Treasury, GE Sourcing, GE Investor Relations, GE Commercial Real Estate	No charge	Trigger Date
138. <u>Services for Real Estate Data Warehouse and Applications (Global)</u> GE will provide the Company with access to and use of its Real Estate Database (GERED) and integrated applications.	Actual costs via the allocation methodology developed for all GE components	Trigger Date
139. <u>Business Development (Europe)</u> The Company will continue to have access to Business Development resources pursuant to activities in respect of the Genworth transaction.	Actual costs via the allocation methodology developed for all GE components.	Completion of the UK Section 105 transfer process
140. <u>Geoffice.com (Europe)</u> GE shall make available to the Company hotdesk and conference room facilities at 25 Green Street, London	Actual costs via the allocation methodology developed for all GE components.	Trigger Date

52

**SCHEDULE A1**  
**GEAM SERVICES**

<u>Items/Service</u>	<u>Billing Rate or Payment Methodology</u>	<u>Service Termination Date</u>
1. <u>PCAT (US)</u> GE will provide the Company with access to and use of its PCAT Credit Deterioration System	No Charge as long as Investment Management Agreements (IMA) are in effect (included in fees payable by the Company under IMA); Post IMA termination – actual costs via the allocation methodology developed for all GE components	The earlier of termination of IMA + 6 months or completion of the Company's transition
2. <u>Trading Compliance (5.0/6.0) (US)</u> GE will provide the Company with access to and use of its Limit 5.0 and Trigger 6.0 Trading Compliance Systems	No Charge as long as Investment Management Agreements (IMA) are in effect (included in fees payable by the Company under IMA); Post IMA termination – Actual costs via the allocation methodology developed for all GE components	The earlier of termination of IMA + 6 months or completion of the Company's transition
3. <u>Investment Data Warehouse (US)</u> GE will provide the Company with access to and use of its Investment Data Warehouse	No Charge as long as Investment Management Agreements (IMA) are in effect (included in fees payable by the Company under IMA); Post IMA termination – Actual costs via the allocation methodology developed for all GE components	The earlier of termination of IMA + 6 months or completion of the Company's transition
4. <u>Trade Order Management (US)</u> GE will provide the Company with access to and use of its Trade Order Management System (TIPS and 3 <sup>rd</sup> party solution when implemented)	No Charge as long as Investment Management Agreements (IMA) are in effect (included in fees payable by the Company under IMA); Post IMA termination – Actual costs via the allocation methodology developed for all GE components	The earlier of termination of IMA + 6 months or completion of the Company's transition
5. <u>Portfolio Analyzer – Insurance (US)</u> GE will provide the Company with access to and use of its Portfolio Analyzer – Insurance System	No Charge as long as Investment Management Agreements (IMA) are in effect (included in fees payable by the Company under IMA); Post IMA termination – Actual costs via the allocation methodology developed for all GE components	The earlier of termination of IMA + 6 months or completion of the Company's transition
6. <u>Derivatives Management (US)</u> GE will provide the Company with access to and use of its Derivatives System (Infinity and Principia as replacement for	No Charge as long as Investment Management Agreements (IMA) are in effect (included in fees payable by the Company under IMA); Post IMA termination – Actual costs via the allocation	The earlier of termination of IMA + 6 months or completion of the Company's transition, including, assignment of

53

<u>Items/Service</u>	<u>Billing Rate or Payment Methodology</u>	<u>Service Termination Date</u>
Infinity when implemented).	methodology developed for all GE components	license
7. <u>Derivatives Reporting (US)</u> GE will provide the Company with access to and use of its DREAMS Derivative Reporting System	No Charge as long as Investment Management Agreements (IMA) are in effect (included in fees payable by the Company under IMA); Post IMA termination – Actual costs via the allocation methodology developed for all GE components	The earlier of termination of IMA + 6 months or completion of the Company's transition.

54

**SCHEDULE B**  
**SERVICES PROVIDED TO GE**

<u>Items/Service</u>	<u>Billing Rate or Payment Methodology</u>	<u>Service Termination Date</u>
----------------------	--	---------------------------------



---

**Finance and Related Services**

1. <u>Treasury Services (Europe)</u> The Company will provide access to and use of Operational and Consulting Process Changes for bank accounts and cash pooling transactions.	Actual costs billed via the allocation methodology applicable to the Retained Businesses immediately prior to the date hereof.	The earlier of the Trigger Date or completion of the Retained Businesses transition.
2. <u>Tax Services (Global)</u> The Company will continue to provide global tax related services to the Retained Business and to GE in a manner that is consistent with past practice and as required by such Retained Business and/or GE to satisfy its global income and other tax compliance and reporting responsibilities, including (without limitation) the provision of tax data and information to support US federal and state as well as non-US tax returns and the tax aspects or components of any financial and/or statutory statements or other similar reports or filings.	Actual costs billed via the allocation methodology applicable to the Retained Businesses immediately prior to the date hereof.	The later of two years from the date hereof or completion of the Retained Businesses transition but in no event later than three years from the date hereof.
3. <u>Financial Systems Support (US)</u> Access to and use of applications provided by the Company such as Oracle Financials, Oracle Discoverer, Oracle Financial Analyzer, Oracle AP/PO, Suspense Control, and Safari Expense.	Actual costs billed via the allocation methodology applicable to the Retained Businesses immediately prior to the date hereof.	The later of two years from the date hereof or completion of the Retained Businesses transition but in no event later than three years from the date hereof.
4. <u>Check Creation (US)</u> The Company will continue to support and provide access to and use of the EWD system for Check Creation and Payments.	Actual costs billed via the allocation methodology applicable to the Retained Businesses immediately prior to the date hereof.	The later of two years from the date hereof or completion of the Retained Businesses transition but in no event later than three years from the date hereof.
5. <u>Escheatment Services (US)</u> The Company will continue to provide escheatment services to the Retained Businesses	Actual costs billed via the allocation methodology applicable to the Retained Businesses immediately prior to the date hereof.	The later of two years from the date hereof or completion of the Retained Businesses transition but in no event later than three years from the date hereof.

55

---

<u>Items/Service</u>	<u>Billing Rate or Payment Methodology</u>	<u>Service Termination Date</u>
6. <u>AP Processing &amp; Administration (US)</u> The Company will continue to provide AP Processing and Administration to the Retained Businesses	Actual costs billed via the allocation methodology applicable to the Retained Businesses immediately prior to the date hereof.	The later of two years from the date hereof or completion of the Retained Businesses transition but in no event later than three years from the date hereof.
7. <u>Fixed Assets Processing &amp; Administration (US)</u> The Company will continue to provide Fixed Assets Accounting and Administration to the Retained Businesses	Actual costs billed via the allocation methodology applicable to the Retained Businesses immediately prior to the date hereof.	The later of two years from the date hereof or completion of the Retained Businesses transition but in no event later than three years from the date hereof.
8. <u>IBS Support and Processing (Global)</u> The Company will continue to provide inter-company billing system (IBS) accounting and reconciliation to the Retained Businesses	Actual costs billed via the allocation methodology applicable to the Retained Businesses immediately prior to the date hereof.	The later of two years from the date hereof or completion of the Retained Businesses transition but in no event later than three years from the date hereof.
9. <u>STAT/GAAP Accounting &amp; Reporting (US)</u> The Company will continue to provide STAT and GAAP accounting services & reporting to the Retained Businesses	Actual costs billed via the allocation methodology applicable to the Retained Businesses immediately prior to the date hereof.	The later of two years from the date hereof or completion of the Retained Businesses transition but in no event later than three years from the date hereof.
10. <u>Technical Accounting Support (Global)</u> The Company will continue to provide technical accounting guidance and support to the Retained Businesses on all accounting related issues.	Actual costs billed via the allocation methodology applicable to the Retained Businesses immediately prior to the date hereof.	The later of two years from the date hereof or completion of the Retained Businesses transition but in no event later than three years from the date hereof.
11. <u>Account Reconciliations (US)</u> The Company will continue to provide Account Reconciliation Tools and Support to the Retained Businesses	Actual costs billed via the allocation methodology applicable to the Retained Businesses immediately prior to the date hereof.	The later of two years from the date hereof or completion of the Retained Businesses transition but in no event later than three years from the date hereof.
12. <u>Financial System Support (US)</u> The Company will continue to provide support on all shared financial systems to the Retained Businesses	Actual costs billed via the allocation methodology applicable to the Retained Businesses immediately prior to the date hereof.	The later of two years from the date hereof or completion of the Retained Businesses transition but in no event later than three years from the date hereof.
13. <u>Sales &amp; Use and Personal Property Tax (US)</u>	Actual costs billed via the allocation	The later of two years from the date hereof

56

---

<u>Items/Service</u>	<u>Billing Rate or Payment Methodology</u>	<u>Service Termination Date</u>
The Company will continue to prepare and file certain tax returns for the Retained Businesses consistent with past practice by the Company	methodology applicable to the Retained Businesses immediately prior to the date hereof.	or completion of the Retained Businesses transition but in no event later than three years from the date hereof.

14. <u>Financial Reporting &amp; Analysis (US)</u> The Company will continue to provide financial reporting and analysis to the Retained Businesses for all GAAP, SEC and management reporting requirements	Actual costs billed via the allocation methodology applicable to the Retained Businesses immediately prior to the date hereof.	The later of two years from the date hereof or completion of the Retained Businesses transition but in no event later than three years from the date hereof.
15. <u>Financial Planning &amp; Analysis (Global)</u> The Company will continue to provide the retained businesses with FP&A support similar to the level and scope of the activities currently provided.	Actual costs billed via the allocation methodology applicable to the Retained Businesses immediately prior to the date hereof.	The later of two years from the date hereof or completion of the Retained Businesses transition but in no event later than three years from the date hereof.
16. <u>Financial Accounting (US)</u> The Company will continue to provide the retained businesses with financial accounting support similar to the level and scope of the activities currently provided	Actual costs billed via the allocation methodology applicable to the Retained Businesses immediately prior to the date hereof.	The later of two years from the date hereof or completion of the Retained Businesses transition but in no event later than three years from the date hereof.
17. <u>Travel and Living (US)</u> The Company will continue to provide travel & living processing and accounting to the Retained Businesses	Actual costs billed via the allocation methodology applicable to the Retained Businesses immediately prior to the date hereof	The later of two years from the date hereof or completion of the Retained Businesses transition but in no event later than three years from the date hereof.
18. <u>Benefit Cost Accounting and Analysis (US)</u> The Company will continue to provide benefit cost tracking and analysis for the Retained Businesses	Actual costs billed via the allocation methodology applicable to the Retained Businesses immediately prior to the date here	The later of two years from the date hereof or completion of the Retained Businesses transition but in no event later than three years from the date hereof.
19. <u>Facilities and Lease Accounting and Billing for 500 Virginia Ave (US)</u> The Company will continue to provide accounting and billing services for 500 Virginia Drive in Fort Washington, PA	Actual costs billed via the allocation methodology applicable to the Retained Businesses immediately prior to the date hereof	The later of two years from the date hereof or completion of the Retained Businesses transition but in no event later than three years from the date hereof.
20. <u>Xerox and Postage Meter Replenishment and Accounting (US)</u> The Company will continue to fund DPC postage meters and	Actual costs billed via the allocation methodology applicable to the	The later of two years from the date hereof or completion of the Retained Businesses

57

<u>Items/Service</u>	<u>Billing Rate or Payment Methodology</u>	<u>Service Termination Date</u>
perform all necessary accounting for the Retained Businesses	Retained Businesses immediately prior to the date hereof	transition but in no event later than three years from the date hereof
21. <u>Expense Reporting and Analysis (US)</u> The Company will continue to provide expense analysis and support to the Retained Businesses	Actual costs billed via the allocation methodology applicable to the Retained Businesses immediately prior to the date hereof	The later of two years from the date hereof or completion of the Retained Businesses transition but in no event later than three years from the date hereof
22. <u>Training (US)</u> The Company will continue to provide training to the Retained Businesses for all transaction processes	Actual costs billed via the allocation methodology applicable to the Retained Businesses immediately prior to the date hereof	The later of two years from the date hereof or completion of the Retained Businesses transition but in no event later than three years from the date hereof
23. <u>1099 Reporting and Processing (US)</u> The Company's Accounts Payable group will provide 1099 reporting and processing to the Retained Businesses	Actual costs billed via the allocation methodology applicable to the Retained Businesses immediately prior to the date hereof	The later of two years from the date hereof or completion of the Retained Businesses transition but in no event later than three years from the date hereof.
24. <u>Facilities Billing and Accounting (US)</u> The Company will continue to provide management oversight and perform billing and accounting for the Richmond facilities, including space used by associates servicing the Retained Businesses and product lines.	Actual costs billed via the allocation methodology applicable to the Retained Businesses immediately prior to the date hereof.	The later of two years from the date hereof or completion of the Retained Businesses transition but in no event later than three years from the date hereof.
25. <u>Payroll Reporting (US)</u> The Company will perform payroll-related financial reporting for the Retained Businesses	Actual costs billed via the allocation methodology applicable to the Retained Businesses immediately prior to the date hereof.	The later of two years from the date hereof or completion of the Retained Businesses transition but in no event later than three years from the date hereof.
<b>Human Resources and Related Services</b>		
26. <u>GMS Expat Services (Europe)</u>	Actual costs billed via the allocation methodology applicable to the Retained Businesses immediately prior to the date hereof.	Completion of GE's move to its own European Expat Service

58

<u>Items/Service</u>	<u>Billing Rate or Payment Methodology</u>	<u>Service Termination Date</u>
----------------------	--	---------------------------------

27. <u>HR Support and Related Services (Global)</u> The Company will continue to provide advice and support to the Retained Businesses, including but not limited to; compensation planning, benefits, payroll processing, organizational development and staffing, communications and other employee relations activities.	Actual costs billed via the allocation methodology applicable to the Retained Businesses immediately prior to the date hereof.	The later of two years from the date hereof or completion of the Retained Businesses transition but in no event later than three years from the date hereof.
28. <u>MyGoals (US)</u> The Company will provide Retained Businesses access to and use of the MyGoals system for mid-term performance reviews.	Actual costs billed via the allocation methodology applicable to the Retained Businesses immediately prior to the date hereof.	The later of two years from the date hereof or completion of the Retained Businesses transition but in no event later than three years from the date hereof.
29. <u>Sales Manager Acceleration Center (US)</u> Company will continue to allow GE employees access to (e.g. observation, participation, train-the-trainer) to Company's Sales Manager Acceleration Center program.	Actual costs billed via the method used for all GE components	The later of two years from the date hereof or completion of the Retained Businesses transition but in no event later than three years from the date hereof.
30. <u>Payroll Processing and Administration (Global)</u> The Company shall provide input of data to the system (time & attendance, etc.), file uploads, cutting checks, regulatory filings (W-2s, etc.), and answering payroll-related questions.	Actual costs billed via the method used for all GE components	Trigger Date (US); Trigger Date (Global) (up to six months later by mutual consent)
31. <u>GEFA Facilitation Network (US)</u> The Company will continue to train/certify employees of the Retained Businesses as members of the GEFA Facilitation Network. The Company will continue to provide access to and use of the online GFN Request service (process to request a facilitator)	Actual costs billed via the method used for all GE components	The later of two years from the date hereof or completion of the Retained Businesses transition but in no event later than three years from the date hereof.
32. <u>Facilitation and Training Delivery (US)</u> The Company will continue to provide facilitation and organizational effectiveness support to GE and Retained Businesses. The Company will continue to deliver training sessions to GE and Retained Businesses as capacity permits.	\$1,000 per day per diem.	The later of two years from the date hereof or completion of the Retained Businesses transition but in no event later than three years from the date hereof.

<u>Items/Service</u>	<u>Billing Rate or Payment Methodology</u>	<u>Service Termination Date</u>
<b>IT – Misc Application, Infrastructure &amp; Related Services</b>		
33. <u>HIPAA Infrastructure Services (US)</u> The Company will provide access to and use of the GXs Application Integrator application and servers used for HIPAA Transaction Compliance to the Retained Businesses.	Actual costs billed via the allocation methodology applicable to the Retained Businesses immediately prior to the date hereof.	The later of two years from the date hereof or completion of the Retained Businesses transition but in no event later than three years from the date hereof.
34. <u>Web Hosting (US)</u> The Company will provide access to and use of infrastructure, Servicing, Deployment of New Content, Project Management, Security, and Vendor Management support of applications resident in the Genuity Shared Services environment to the Retained Businesses.	Actual costs billed via the allocation methodology applicable to the Retained Businesses immediately prior to the date hereof.	September 17, 2004
35. <u>e-Learning (Global)</u> The Company will provide the Retained Businesses with access to and use of electronic courses available on the Company's Lotus Learning Space environment	Actual costs billed via the allocation methodology applicable to the Retained Businesses immediately prior to the date hereof.	The later of two years from the date hereof or completion of the Retained Businesses transition but in no event later than three years from the date hereof.
36. <u>GEFA University Website (Global)</u> The Company will provide the Retained Businesses with access to and use of the GEFA U website for training registration and administration purposes. Tracking reports also will be made available upon request.	Actual costs billed via the allocation methodology applicable to the Retained Businesses immediately prior to the date hereof.	The later of two years from the date hereof or completion of the Retained Businesses transition but in no event later than three years from the date hereof.
37. <u>SSO (US)</u> The Company will provide the Retained Businesses with access to and use of applications developed by the Company, such as SSO, GE Worker, authentication services, and user data stores.	Actual costs billed via the allocation methodology applicable to the Retained Businesses immediately prior to the date hereof.	The later of two years from the date hereof or completion of the Retained Businesses transition but in no event later than three years from the date hereof.
38. <u>Image Services (US)</u> The Company will provide access to and use of its FileNet image repository to the Retained Businesses.	Actual costs billed via the allocation methodology applicable to the Retained Businesses immediately prior to the date hereof.	The later of two years from the date hereof or completion of the Retained Businesses transition but in no event later than three years from the date hereof.
39. <u>Fax Services (US)</u>	Actual costs billed via the allocation	The later of two years from the date hereof

<u>Items/Service</u>	<u>Billing Rate or Payment Methodology</u>	<u>Service Termination Date</u>
The Company will provide access to and use of Biscom's Fax Servers to the Retained Businesses.	methodology applicable to the Retained Businesses immediately prior to the date hereof.	or completion of the Retained Businesses transition but in no event later than three years from the date hereof.

40. <u>Death Claims System (US)</u> The Company will continue to provide access to and use of its Death Claims cross-checking system to the Retained Businesses.	Actual costs billed via the allocation methodology applicable to the Retained Businesses immediately prior to the date hereof.	The later of two years from the date hereof or completion of the Retained Businesses transition but in no event later than three years from the date hereof.
41. <u>Alpharetta Server Processing</u> The Company will continue to support and provide access to and use of applications running on the shared UNIX server infrastructure to the Retained Businesses.	Actual costs billed via the allocation methodology applicable to the Retained Businesses immediately prior to the date hereof.	The later of two years from the date hereof or completion of the Retained Businesses transition but in no event later than three years from the date hereof.
42. <u>Password Reset Services (US)</u> The Company will provide support of the Courion Password reset and management system to the Retained Businesses.	Actual costs billed via the allocation methodology applicable to the Retained Businesses immediately prior to the date hereof.	The later of two years from the date hereof or completion of the Retained Businesses transition but in no event later than three years from the date hereof.
43. <u>Contract and Vendor Management (US)</u> The Company will continue to provide IT contract and vendor management support for the Retained Businesses.	Actual costs billed via the allocation methodology applicable to the Retained Businesses immediately prior to the date hereof.	The later of two years from the date hereof or completion of the Retained Businesses transition but in no event later than three years from the date hereof.
44. <u>IT Security Services (US)</u> The Company will continue to provide security services, including policy and firewall management, to the Retained Businesses.	Actual costs billed via the allocation methodology applicable to the Retained Businesses immediately prior to the date hereof.	The later of two years from the date hereof or completion of the Retained Businesses transition but in no event later than three years from the date hereof.
45. <u>Disaster Recovery Services (US)</u> The Company will continue to provide IT-related disaster services, including policy, contract, and testing management, to the Retained Businesses	Actual costs billed via the allocation methodology applicable to the Retained Businesses immediately prior to the date hereof.	The later of two years from the date hereof or completion of the Retained Businesses transition but in no event later than three years from the date hereof.
46. <u>VPN Hosting (US)</u> The Company will continue to provide VPN Hosting services to the	Actual costs billed via the allocation methodology applicable to the	The later of two years from the date hereof or completion of the Retained Businesses

<u>Items/Service</u>	<u>Billing Rate or Payment Methodology</u>	<u>Service Termination Date</u>
Retained Businesses.	Retained Businesses immediately prior to the date hereof.	transition but in no event later than three years from the date hereof.
47. <u>Automated e-Mail Management (US)</u> The Company will provide access to and use of its instance of Cisco e-Mail Manager to the Retained Businesses	Actual costs billed via the allocation methodology applicable to the Retained Businesses immediately prior to the date hereof.	The later of two years from the date hereof or completion of the Retained Businesses transition but in no event later than three years from the date hereof.
48. <u>1099-Tax Statement Processing (US)</u> The Company will provide access to and use of the CheckFree system to create and view policyholder-related 1099- statements on behalf of the Retained Businesses.	Actual costs billed via the allocation methodology applicable to the Retained Businesses immediately prior to the date hereof.	The later of two years from the date hereof or completion of the Retained Businesses transition but in no event later than three years from the date hereof.
49. <u>Wide Area Network Management (US)</u> The Company will continue to provide access into, and support, of the Company's existing network backbone between GE locations and the data centers in Alpharetta, Georgia; Lynchburg, Virginia; Richmond, Virginia; and Cincinnati, Ohio.	Actual costs billed via the allocation methodology applicable to the Retained Businesses immediately prior to the date hereof.	The later of two years from the date hereof or completion of the Retained Businesses transition but in no event later than three years from the date hereof.
50. <u>Desktop and Asset Management (US)</u> The Company will continue to provide existing asset management services for GE's Personal Computers and Servers. Services include but are not limited to: core load maintenance, asset tracking, and vendor management.	Actual costs billed via the allocation methodology applicable to the Retained Businesses immediately prior to the date hereof.	The later of two years from the date hereof or completion of the Retained Businesses transition but in no event later than three years from the date hereof.
51. <u>Helpdesk, Desktop and Server Support Services (US)</u> The Company will provide helpdesk, desktop and server support services to the Retained Business's employees located in Lakewood, Colorado and Ft. Washington, Pennsylvania.	Actual costs billed via the allocation methodology applicable to the Retained Businesses immediately prior to the date hereof.	October 22, 2004
52. <u>Licensing (Global)</u> The Company will continue to provide business-related licensing and related support for the Retained Businesses.	Actual costs billed via the allocation methodology applicable to the Retained Businesses immediately prior to the date hereof	The later of two years from the date hereof or completion of the Retained Businesses transition but in no event later than three years from the date hereof.
53. <u>Data Warehouse Support (US)</u> The Company will continue to provide to the Retained Businesses access and support of its Finance-related data warehouse.	Actual costs billed via the allocation methodology applicable to the Retained Businesses immediately prior	The later of two years from the date hereof or completion of the Retained Businesses transition but in no event later than three

<u>Items/Service</u>	<u>Billing Rate or Payment Methodology</u>	<u>Service Termination Date</u>
----------------------	--	---------------------------------

	to the date hereof	years from the date hereof
54. <u>Project Management Office (Global)</u> The Company will continue to provide PMO guidance, support and project management services to the Retained Businesses on existing and closed projects.	Actual costs billed via the allocation methodology applicable to the Retained Businesses immediately prior to the date hereof	The later of two years from the date hereof or completion of the Retained Businesses transition but in no event later than three years from the date hereof
55. <u>Helpdesk (US)</u> The Company will act as paying agent and provide surge resources for the IT helpdesk for GEAM employees located at 3003 Summer Street, Stamford, CT.	Actual costs billed via the allocation methodology used immediately prior to the date hereof.	The earlier of the first anniversary of the Trigger Date and the Company's termination of GE's network services.
56. <u>SAFE (US)</u> The Company shall provide the Retained Businesses access to and use of the SAFE document storage environment but only with respect to the Retained Businesses' documents.	Actual costs billed via the allocation methodology applicable to the Retained Businesses immediately prior to the date hereof.	The later of two years from the date hereof or completion of the Retained Businesses transition but in no event later than three years from the date hereof
57. <u>Servicers for Real Estate (US)</u> The Company will provide GEAM with access to and use of its RE Servicers application.	Actual costs via the allocation methodology developed for all GE components.	Trigger Date
58. <u>Domino Infrastructure (US)</u> Support and maintenance of the Domino.Docs and Domino.Work Flow applications.	Actual costs via the allocation methodology applicable to the Retained Businesses immediately prior to the date hereof.	The later of two years from the date hereof or completion of the retained businesses transition but in no event later than three years from the date hereof.
59. <u>Domino Infrastructure (Global)</u> Support and maintenance of the Domino.Docs and Lotus notes as used for the Virtual File Room (part of the Lotus Collaborative Tools).	Actual costs via the allocation methodology applicable to the Retained Businesses immediately prior to the date hereof.	The later of two years from the date hereof or completion of the retained businesses transition but in no event later than three years from the date hereof.
60. <u>Contracts Management Database (US)</u> The Company shall provide the Retained Businesses with access to and use of the Contracts Management Database.	Actual costs via the allocation methodology applicable to the Retained businesses immediately prior to the date hereof.	The later of two years from the date hereof or completion of the Retained Businesses transition but in no event later than three years from the date hereof.

<u>Items/Service</u>	<u>Billing Rate or Payment Methodology</u>	<u>Service Termination Date</u>
<b>IV Legal, Compliance, Government Relations, and Public Relations Services</b>		
61. <u>General Internal Support (Global)</u> The Company will provide legal support and coordination of litigation, human resource, intellectual property, insurance regulatory (unless otherwise specifically described below), consumer privacy, contract, and marketing and advertising matters, and provide compliance, government relations and public relations support for Retained Businesses as performed immediately prior to the Date hereof.	Actual costs billed via the allocation methodology applicable to the Retained Businesses immediately prior to the date hereof.	Six months from the Date hereof.
62. <u>Legal Information Management Systems (LIMS) (US)</u> The Company will provide access to and use of LIMS but only with respect to data related to the Retained Businesses.	Actual costs billed via the allocation methodology applicable to the Retained Businesses immediately prior to the date hereof.	The later of two years from the date hereof or completion of the Retained Businesses transition but in no event later than three years from the date hereof.
63. <u>Ombudsperson Services (US)</u> The Company will continue to perform ombudsperson activities for the Retained Businesses, including: receipt of reports related to Retained Businesses; assignment of issues to Retained Businesses for resolution; and monitoring status of assigned issues.	Actual costs billed via the allocation methodology applicable to the Retained Businesses immediately prior to the date hereof.	The later of two years from the date hereof or completion of the Retained Businesses transition but in no event later than three years from the date hereof.
64. <u>Compliance Management System (CMS)</u> The Company will continue to provide the Retained Businesses access to and use of its Compliance Management System.	Actual costs billed via the allocation methodology applicable to the Retained Businesses immediately prior to the date hereof.	The later of two years from the date hereof or completion of the Retained Businesses transition but in no event later than three years from the date hereof.
65. <u>Holding Company Act Filings (US)</u> The Company will provide Consolidated Form B for the Company and the Retained Businesses. The Retained Businesses shall provide the Company with their relevant information.	Actual costs billed via the allocation methodology applicable to the Retained Businesses immediately prior to the date hereof.	The later of two years from the date hereof or completion of the Retained Businesses transition but in no event later than three years from the date hereof.

<u>Items/Service</u>	<u>Billing Rate or Payment Methodology</u>	<u>Service Termination Date</u>
----------------------	--	---------------------------------

66. <u>Consolidated Insurance Regulatory Filings (US)</u> Any time state insurance regulators mandate that certain filings be made on a consolidated basis among affiliated insurance companies (except holocaust reporting), the Company shall prepare and make the filing on behalf of itself and the Retained Businesses (and any other affiliated insurance companies owned in whole or in part by GE consistent with practices immediately prior to the date hereof). The Retained Businesses and any other affiliated insurance companies shall provide the Company with their relevant information.	Actual costs billed via the allocation methodology applicable to the Retained Businesses immediately prior to the Date hereof.	The later of two years from the date hereof or completion of the Retained Businesses transition but in no event later than three years from the date hereof.
67. <u>Annual Statement Assistance (US)</u> Assistance from the Company's Legal Department with the preparation of the Retained Businesses' Annual Statements filed with state insurance regulators (a/k/a "blue books").	Actual costs billed via the allocation methodology applicable to the Retained Businesses immediately prior to the Date hereof.	The later of two years from the date hereof or completion of the Retained Businesses transition but in no event later than three years from the date hereof.
68. <u>Insurance Industry Trade Associations (US)</u> Where there was one membership that entitled participation by the Company and the Retained Businesses immediately prior to the Date hereof, the Company will maintain that membership to enable continued participation by the Retained Businesses.	Actual costs billed via the allocation methodology applicable to the Retained Businesses immediately prior to the Date hereof.	With respect to each association, the earlier of (a) the close of the membership year immediately following the Trigger Date and (b) the date upon which the association's own rules require separate membership.
69. <u>Privacy/Opt-Out (US)</u> The Company will continue to give the Retained Businesses access to and use of its Privacy/Opt-Out application and services.	Actual costs billed via the allocation methodology applicable to the Retained Businesses immediately prior to the date hereof.	The later of two years from the date hereof or completion of the Retained Businesses transition but in no event later than three years from the date hereof.
70. <u>Complaints System (US)</u> The Company will continue to provide the Retained Businesses access to and use of its Complaint Log system in order receive and document customer complaints.	Actual costs billed via the allocation methodology applicable to the Retained Businesses immediately prior to the date hereof.	The later of two years from the date hereof or completion of the Retained Businesses transition but in no event later than three years from the date hereof.

#### VI Services With Respect to GEFAHI Divested Companies

65

<u>Items/Service</u>	<u>Billing Rate or Payment Methodology</u>	<u>Service Termination Date</u>
71. <u>1099 Reporting and Processing (US)</u>	Cost of services as billed to purchaser of GEFAHI Divested Companies pursuant to U.S. Computer Services Agreement dated on or about August 29, 2003 as amended.	April 30, 2004
72. <u>APECS for Escheat Processing (US)</u>	Cost of services as billed to purchaser of GEFAHI Divested Companies pursuant to U.S. Computer Services Agreement dated on or about August 29, 2003 as amended.	April 30, 2004
73. <u>Broadwing (US)</u> Broadwing Xerox Circuit	Cost of services as billed to purchaser of GEFAHI Divested Companies pursuant to U.S. Computer Services Agreement dated on or about August 29, 2003 as amended.	August 29, 2005
74. <u>Billing with Respect to services provided to GEFAHI Divested Companies by GE and the Company (US)</u>	No Charge	Sixty (60) days from the date hereof.
75. <u>Management of services provided to GEFAHI Divested Companies by GE and the Company (US and Japan)</u>	No Charge	Sixty (60) days from the date hereof.
76. <u>Hewlett Packard / Blue Ash (US)</u> HP Blue Ash Circuit	No Charge	October 20, 2004

#### VII. Functions Other Than Above

77. <u>Sourcing (US)</u> The Company will continue to provide Sourcing business services and administrative support to the Retained Businesses	Actual costs billed via the allocation methodology applicable to the Retained Businesses immediately prior to the date hereof.	The later of two years from the date hereof or completion of the Retained Businesses transition but in no event later than three years from the date hereof.
78. <u>Facilities (US)</u> The Company will continue to provide Facilities and Real Estate	Actual costs billed via the allocation methodology applicable to the	The later of two years from the date hereof or completion of the Retained Businesses

66

<u>Items/Service</u>	<u>Billing Rate or Payment Methodology</u>	<u>Service Termination Date</u>
business services and administrative support to the Retained Businesses	Retained Businesses immediately prior to the date hereof.	transition but in no event later than three years from the date hereof.

79. <u>Quality Training (Global)</u> The Company will continue to provide quality training to the Retained Businesses	Actual costs billed via the allocation methodology applicable to the Retained Businesses immediately prior to the date hereof	The later of two years from the date hereof or completion of the Retained Businesses transition but in no event later than three years from the date hereof.
80. <u>Vendor Management, Strategy and Negotiations (US)</u> The Company will continue to provide the Retained Businesses with business-related assistance and guidance regarding vendor management, strategy and negotiations for business process outsourcing	Actual costs billed via the allocation methodology applicable to the Retained Businesses immediately prior to the date hereof.	The later of two years from the date hereof or completion of the Retained Businesses transition but in no event later than three years from the date hereof.
81. <u>Document Print Center (US)</u> The Company will continue to make available to the Retained Businesses use of the document print center for Xerox and production services	Actual costs billed via the allocation methodology applicable to the Retained Businesses immediately prior to the date hereof	The later of two years from the date hereof or completion of the Retained Businesses transition but in no event later than three years from the date hereof.

**Schedule C-1****LEASED FACILITIES (GE to Company)**

Line Number	Lessor	Lessee	Location	Expiration Date
1	General Electric Company	GE Group Life Assurance Company	3200 N. Central Avenue, Phoenix, AZ	9/30/2008
2	General Electric Commercial Equipment Company	GE Group Life Assurance Company	5335 S.W. Meadows Road, Lake Oswego, OR	8/31/2005
3	Union Fidelity Life Insurance Company	General Electric Capital Assurance Company	200 N. Martingale Drive, Schaumburg, IL	2/28/2006
4	Union Fidelity Life Insurance Company	The Terra Financial Companies, Ltd.	200 N. Martingale Drive, Schaumburg, IL	2/28/2011
5	Heller Financial, Inc.	GE Capital Life Assurance Company of New York & American Mayflower Life Insurance Company of New York	622 Third Avenue, New York, NY	8/31/2004
6	General Electric Company	GE Mortgage Insurance Company	320 Great Oaks Boulevard, Albany, NY	8/31/2004
7	GE Capital Real Estate	GE Mortgage Insurance Company	301 Yamoto Road, Boca Raton, FL	12/31/2004
8	GE Corporate	GE Mortgage Insurance Company	25925 Telegraph Road, Southfield, MI	Earlier of 2/28/2007 or Trigger Date
9	GE Corporate	GE Mortgage Insurance Company	640 Freedom Business Park, King of Prussia, PA	9/14/2006
10	General Electric Company	GE Mortgage Insurance Company	3200 N. Central Avenue, Phoenix, AZ	9/30/2008
11	GE Capital Bank	GE Mortgage Insurance Limited	6 Agar Street, London, UK	9/24/2010
12	GE Fleet	GE Mortgage Insurance Limited	Europalaan 6, 5232 BC's-Hertogenbosch, Neth	11/30/2004
13	GE Leadership Development Europe N.V.	GE Mortgage Insurance Limited	2-4 Rond Point Schuman, Brussels, Blgm	12/31/2004
14	GE Capital mietfinanz	GE Mortgage Insurance Limited	Sachsenring 83, Cologne, GDR	12/31/2004
15	International GE AB	GE Mortgage Insurance Limited	Solna Strandvag 98, Stockholm, SWE 17175 (Office Space)	1/31/2007
16	International GE AB	GE Mortgage Insurance Limited	Solna Strandvag 98, Stockholm, SWE 17175 (Parking Space)	10/1/2006

17	GE ERC	GE Mortgage Insurance Limited	107 Rue Saint Lazare, 75009, Paris, France	12/31/2004
18	GE Canada	GE Capital Mortgage Insurance Company (Canada)	2300 Meadowvale Blvd, Mississauga, ONT	12/31/2005
19	GE Canada	GE Capital Mortgage Insurance Company (Canada)	555 Dr. Frederick Philips Drive, St. Laurent, QBC	3/31/2008
20	GE Capital Finance Australasia Pty Ltd	GE Mortgage Insurance Co. Pty. Ltd.	143 Coronation Drive, Brisbane, Aust	Earlier of Trigger Date or 4/30/05
21	GE Capital Finance Australasia Pty Ltd	GE Mortgage Insurance Co. Pty. Ltd.	10 Pulteney Street, Adelaide, SA, Aust	Earlier of Trigger Date or 4/30/05

22	GE Capital Finance Australasia Pty Ltd	GE Mortgage Insurance Co. Pty. Ltd.	Levels 9&10 Lumley House, 7 City Road, Auckland, NZ	5/31/2006
23	GE Commercial Corporation (Australia) Pty Ltd	GE Mortgage Insurance Co. Pty. Ltd.	1/110 Erindale Road, Balcatta, Perth, WA	Earlier of Trigger Date or 4/30/05
24	General Electric Company	GE Financial Trust Company	3200 N. Central Avenue, Phoenix, AZ	9/30/2008
25	General Electric Capital Company	GNA Corporation	335 Madison Avenue, New York, NY	12/31/2004
26	GE Company	GNA Corporation	601 S. Figueroa Street, Los Angeles, CA	1/31/2006
27	GE — CF	GNA Corporation	500 West Monroe Street, Chicago, IL	12/31/2004
28	GECC/GEC	GNA Corporation	500 Virginia Drive, Fort Washington, PA	8/31/2004
29	GE Vie Plus	RD Plus S.A.	Floor 29, Tour Franklin, Terrasse Boieldieu, La Defense 8, Paris, France	2/28/2007 or earlier termination by Vie Plus only if it is obliged to do so by its Landlord
30	GE Capital Bank	Financial Insurance Company Limited	Park Alle 295, 2605 Brondby, Denmark	5/1/2007
31	GE Finland OY	Financial Assurance Company Limited	Malmin Kauppatie 18, Helsinki, FIN	Either party can terminate after 12/31/2004 with 6 months notice

69

32	GE General Electric Finance Holding GmbH	GE Financial Insurance Deutschland	Martin-Behaim Str 8-10, Neu-Isenberg, GDR	12/31/2008
33	GECW	Financial Insurance Group Services Ltd.	Golden Lane, Dublin, IRE	6/26/2004
34	Access Graphics BV, trade name GE Access	Financial Insurance Group Services Ltd.	Dr Willem Dreesweg 6-8 1185 VB, Amstelveen, Netherlands	12/31/2004 with annual renewals or 60 days notice
35	GECFS	GE Financial Insurance	Karenslyst alle 2, Oslo, NOR	12/30/2004
36	International GE AB	GE Financial Insurance Sweden	Noten 3 Solna Strandvag 98, Stockholm, SWE (Office Lease)	12/31/2010
37	International GE AB	GE Financial Insurance Sweden	Noten 3 Solna Strandvag 98, Stockholm, SWE (Parking Lease)	12/31/2006
38	GESF	GE Financial Insurance	Thurgauerstrasse 40, Zurich, Switzerland	9/30/2004
39	GE Life Services	Financial Insurance Group Services Ltd.	3 floors (Ground, 1 & 2) at Vantage West, Brentford, London, Middlesex, UK	6/20/2010 or earlier termination by GE only (a) if it is obliged to do so by its Landlord or (b) upon the termination of the lease following the exercise of a tenant break.
40	General Electric Capital Corporation	General Electric Capital Assurance Company	501 Corporate Center Drive, Franklin, TN	4/30/2007
41	GE International Mexico, S. de R. L. de C.V.	GE Seguros del Centro, S.A. de C.V.	Ave. Calzada del Valle No. 205, Monterrey, Nuevo Leon, Mexico	9/1/2007
42	General Electric Company	GE Group Life Assurance Company	12101 Woodcrest Executive Drive, St. Louis, MO	1/31/2005
43	GE Supply	GE Mortgage Insurance Company	5605 Granger Road, Independence, OH	12/31/2005
44	GE Corporate	General Electric Capital Assurance Company	1299 Pennsylvania Avenue, Washington, DC	06/30/2004

70

**Schedule C-2**

**LEASED FACILITIES (Company to GE)**



Line Number	Lessor	Lessee	Location	Expiration Date
1	GE Group Life Assurance Company	GE Healthcare Financial Services, a division of General Electric Capital Corporation	100 Bright Meadow Boulevard, Enfield, CT	4/30/2005
2	GE Life and Annuity Assurance Company	General Electric Company	4415 Pheasant Ridge Road, Roanoke, VA	4/30/2004
3	General Electric Mortgage Insurance Corp.	Industrial Risk Insurers — Division of GE-ERC	2600 Michelson Drive, Irvine, CA	10/31/2004
4	General Electric Mortgage Insurance Corporation	GE Commercial Finance	Two Northpoint Drive, Houston, Texas	11/30/2006
5	GE Seguros del Centro, S.A. de C.V.	GE Equipo de Control y Distribucion S. de RL de CV	Av. Tecnológico Sur No. 100, Queretero, QRO, Mexico	9/2/2004
6	GE Seguros del Centro, S.A. de C.V.	GE Capital Fleet Services de Mexico SA de CV	Rubén Dario 1109 5º piso, Guadalajara, JAL, Mexico	9/1/2004

71

**SCHEDULE D**  
**GRC PROJECTS**

Project	Description	2004 Funding
1. <u>PROFITS</u>	Tools & Methods To Analyze Credit, Equity, and Interest Rate Risk Then Create Optimized Investment Strategies	\$1.7 Million – Company \$1.4 Million - GE
2. <u>LEO</u>	Decision Engine For LTC Claims	\$600,000 - GE
3. <u>Decision Engine Closed Loop Processes</u>	Completion Of Decision Engine Work Related To GENIUS and RUBICON Including Monitoring, QA, & Updating & RUBICON Tier 3	\$1.25 Million - GE

72

**Schedule E**

**MANAGEMENT CONSULTING SERVICES**

The Management Consulting Services are broadly defined as activities performed by Company associates that benefit other GE businesses but that do not directly benefit Company. The Management Consulting Services typically include activities such as (i) attending meetings, (ii) delivering training, (iii) providing historical and industry perspectives, (iv) participating in meetings with rating agencies and regulators, (v) participating in government relations activities, (vi) sharing Company best practices, and (vii) making joint sales calls.

The Management Consulting Services are more fully defined below in the Services By Function section.

**Services By Function**

**Executive Office:**

Provide to the CEO of GE and the CEO of GE Insurance general support, advice, and strategy with respect to GE's Retained Businesses and GE's reinsurance business. Consult on various GE initiatives, including strategic implementations, operational reviews, capital planning and other regulatory matters. The parties acknowledge such support will be limited by any Company obligations deemed necessary by the Company's CEO.

**Finance:**

Meet with the Retained Businesses' or GE associates to provide reasonable assistance with issue resolution directly related to historical management participation or emerging issues, meet with the Retained Businesses' management to plan for and provide assistance with rating agency relations, accompany management to ratings agency meetings, meet with the Retained Businesses' management, auditors, regulators to provide historical perspectives. Attend councils at GE including Finance, Tax, Controllers and others as appropriate including presentations of best practices as applicable.

**Legal/Compliance:**

Accompany the Retained Businesses' management to meet with regulators, meet with Retained Businesses' and GE associates to provide reasonable assistance with issue resolution directly related to historical management participation, participate in GE Legal Councils, share applicable legal and compliance best practices and emerging issues as applicable.

**Government Relations/Public Relations:**

Consult and provide support and advice with regard to Government Relations planning and practice with respect to Retained Businesses, and GE's reinsurance businesses. Accompany the Retained Businesses' management to meet with regulators, work with the Retained Businesses' management on government relations activities including without limitation incorporating the Retained Businesses' government relations agendas into the Company's agendas and jointly participating in events, meet with the Retained Businesses' management, auditors, regulators to provide historical perspectives, meet with the Retained Businesses' management to plan for and provide assistance with rating agency relations, accompany Retained Businesses' management to

ratings agency meetings. Participate in GE Government Relations planning and present best practices as applicable.

**Risk:**

Provide general risk support, advice, and strategy with respect to the Retained Businesses and GE's reinsurance business. Meet with the Retained Businesses' and GE associates to provide reasonable assistance with issue resolution directly related to historical management participation, participate in GE risk forums, share applicable risk

best practices.

Information Technology:

Meet with the Retained Businesses' management and GE, auditors, regulators to provide historical perspectives and strategy or consultation on emerging issues, participate in GE information technology councils, share applicable emerging technology practices related to strategy, standards selection and cost reduction initiatives.

Marketing & Product Management:

Participate in joint sales calls for mutual GE/Company customers, meet with the Retained Businesses' management and other GE management to provide perspectives with respect to the insurance industry, and share applicable marketing best practices.

Operations & Six Sigma:

Meet with the Retained Businesses' or GE associates to provide reasonable assistance with issue resolution directly related to historical management participation and emerging issues, make available training in insurance specific classes developed and delivered by Company subject to availability, providing training classes and materials on LEAN and Company- created LEAN tools for financial services operations subject to availability (GE to pay its own travel and living expenses), participate in the Engineering Leadership Council, meet with the Retained Businesses' management to provide perspectives with respect to the insurance industry, share applicable operations best practices.

Actuarial:

Provide general support, advice, and strategy with respect to GE's Retained Businesses and reinsurance business. Meet with the Retained Businesses' management to plan for and provide assistance with rating agency relations, accompany the Retained Businesses' management to ratings agency meetings, assist the actuarial department of GE's reinsurance business, meet with the Retained Businesses' associates to provide reasonable assistance with issue resolution directly related to historical management participation, meet with the Retained Businesses' management, auditors, regulators to provide historical perspectives, share applicable actuarial best practices.

Human Resources:

Participate in GE HR councils and share applicable HR best practices, and make available to GE the Company leadership training classes subject to availability (GE to pay its own travel and living expenses). In addition the Company will make such appropriate subject matter experts reasonably available to provide consultation and assistance to GE with respect any employment-related lawsuit(s) related to Financial Guaranty Insurance Company for which GE is financially

2

---

responsible and that are pending as of January 1, 2004, until such lawsuit(s) are settled or otherwise finally adjudicated with no further right of appeal.

3

---

**Schedule F**

**BUSINESS ASSOCIATE ADDENDUM**

I. Purpose.

In order to disclose certain information to Provider under this Addendum, some of which may constitute Protected Health Information ("PHI") (defined below), Recipient and Provider mutually agree to comply with the terms of this Addendum for the purpose of satisfying the requirements of the Health Insurance Portability and Accountability Act of 1996 ("HIPAA") and its implementing privacy regulations at 45 C.F.R. Parts 160-164 ("HIPAA Privacy Rule"). These provisions shall apply to Provider to the extent that Provider is considered a "Business Associate" under the HIPAA Privacy Rule and all references in this section to Business Associates shall refer to Provider. Capitalized terms not otherwise defined herein shall have the meaning assigned in the Agreement. Notwithstanding anything else to the contrary in the Agreement, in the event of a conflict between this Addendum and the Agreement, the terms of this Addendum shall prevail.

II. Permitted Uses and Disclosures.

A. Business Associate agrees to use or disclose Protected Health Information ("PHI") that it creates for or receives from Recipient or its Subsidiaries only as follows. The capitalized term "Protected Health Information or PHI" has the meaning set forth in 45 Code of Federal Regulations Section 164.501, as amended from time to time. Generally, this term means individually identifiable health information including, without limitation, all information, data and materials, including without limitation, demographic, medical and financial information, that relates to the past, present, or future physical or mental health or condition of an individual; the provision of health care to an individual; or the past present, or future payment for the provision of health care to an individual; and that identifies the individual or with respect to which there is a reasonable basis to believe the information can be used to identify the individual. This definition shall include any demographic information concerning members and participants in, and applicants for, Recipient's or its Subsidiaries' health benefit plans. All other terms used in this Addendum shall have the meanings set forth in the applicable definitions under the HIPAA Privacy Rule.

B. Functions and Activities on Company's Behalf. Business Associate is permitted to use and disclose PHI it creates for or receives from Recipient or its Subsidiaries only for the purposes described in this Addendum or the Agreement that are not inconsistent with the provisions of this Addendum, or as required by law, or following receipt of prior written approval from whichever of the Recipient or its Subsidiary for which the relevant PHI was created or from which the relevant PHI was received. In addition to these specific requirements below, Business Associate may use or disclose PHI only in a manner that would not violate the HIPAA Privacy Rule if done by the Recipient or its Subsidiaries.

C. Business Associate's Operations. Business Associate is permitted by this Agreement to use PHI it creates for or receives from Recipient or its Subsidiaries:

(i) if such

---

use is reasonably necessary for Business Associate's proper management and administration; and (ii) as reasonably necessary to carry out Business Associate's legal responsibilities. Business Associate is permitted to disclose PHI it creates for or receives from Recipient or its Subsidiaries for the purposes identified in this Section only if the following conditions are met:

(1) The disclosure is required by law; or

(2) The disclosure is reasonably necessary to Business Associate's proper management and administration, and Business Associate obtains reasonable assurances in writing from any person or organization to which Business Associate will disclose such PHI that the person or organization will:

a. Hold such PHI as confidential and use or further disclose it only for the purpose for which Business Associate disclosed it to the person or organization or as required by law; and

b. Notify Business Associate (who will in turn promptly notify whichever of the Recipient or its Subsidiary for which the relevant PHI was created or from which the relevant PHI was received) of any instance of which the person or organization becomes aware in which the confidentiality of such PHI was breached.

D. Minimum Necessary Standard. In performing the functions and activities on Recipient's or its Subsidiaries' behalf pursuant to the Agreement, Business Associate agrees to use, disclose or request only the minimum necessary PHI to accomplish the purpose of the use, disclosure or request. Business Associate must have in place policies and procedures that limit the PHI disclosed to meet this minimum necessary standard.

E. Prohibition on Unauthorized Use or Disclosure. Business Associate will neither use nor disclose PHI it creates or receives for or from Recipient, its Subsidiaries, or from another business associate of Recipient or its Subsidiaries, except as permitted or required by this Addendum or the Agreement that are not inconsistent with the provisions of this Addendum, or as required by law, or following receipt of prior written approval from whichever of the Recipient or its Subsidiary for which the relevant PHI was created or from which the relevant PHI was received.

F. De-identification of Information. Business Associate agrees neither to de-identify PHI it creates for or receives from Recipient or its Subsidiaries or from another business associate of Recipient or its Subsidiaries, nor use or disclose such de-identified PHI, unless such de-identification is expressly permitted under the terms and conditions of this Addendum or the Agreement and related to Recipient's or its Subsidiaries' activities for purposes of "treatment", "payment" or "health care operations", as those terms are defined under the HIPAA Privacy Rule. De-identification of PHI, other than as expressly permitted under the terms and conditions of the Addendum for Business Associate to perform services for Recipient or its Subsidiaries, is not a permitted use of PHI under this Addendum. Business Associate further agrees that it will not create a "Limited Data Set" as defined by the HIPAA Privacy Rule using PHI it creates or receives, or receives from another business

2

---

associate of Recipient or its Subsidiaries, nor use or disclose such Limited Data Set unless: (i) such creation, use or disclosure is expressly permitted under the terms and conditions of this Addendum or the Agreement that are not inconsistent with the provisions of this Addendum; and such creation, use or disclosure is for services provided by Business Associate that relate to Recipient's or its Subsidiaries' activities for purposes of "treatment", "payment" or "health care operations", as those terms are defined under the HIPAA Privacy Rule.

G. Information Safeguards. Business Associate will develop, document, implement, maintain and use appropriate administrative, technical and physical safeguards to preserve the integrity and confidentiality of and to prevent non-permitted use or disclosure of PHI created for or received from Recipient or its Subsidiaries. These safeguards must be appropriate to the size and complexity of Business Associate's operations and the nature and scope of its activities. Business Associate agrees that these safeguards will meet any applicable requirements set forth by the U.S. Department of Health and Human Services, including (as of the effective date or as of the compliance date, whichever is applicable) any requirements set forth in the final HIPAA security regulations. Business Associate agrees to mitigate, to the extent practicable, any harmful effect that is known to Business Associate resulting from a use or disclosure of PHI by Business Associate in violation of the requirements of this Addendum.

III. Conducting Standard Transactions. In the course of performing services for Recipient or its Subsidiaries, to the extent that Business Associate will conduct Standard Transactions for or on behalf of Recipient or its Subsidiaries, Business Associate will comply, and will require any subcontractor or agent involved with the conduct of such Standard Transactions to comply, with each applicable requirement of 45 C.F.R. Part 162. "Standard Transaction(s)" shall mean a transaction that complies with the standards set forth at 45 C.F.R. parts 160 and 162. Further, Business Associate will not enter into, or permit its subcontractors or agents to enter into, any trading partner agreement in connection with the conduct of Standard Transactions for or on behalf of the Recipient or its Subsidiaries that:

- a. Changes the definition, data condition, or use of a data element or segment in a Standard Transaction;
- b. Adds any data element or segment to the maximum defined data set;
- c. Uses any code or data element that is marked "not used" in the Standard Transaction's implementation specification or is not in the Standard Transaction's implementation specification; or
- d. Changes the meaning or intent of the Standard Transaction's implementation specification.

IV. Sub-Contractors, Agents or Other Representatives. Business Associate will require any of its subcontractors, agents or other representatives to which Business Associate is permitted by this Addendum or the Agreement (or is otherwise given Recipient's or the relevant Subsidiary's prior written approval) to disclose any of the PHI Business Associate creates or receives for or

3

---

from Recipient or its Subsidiaries, to provide reasonable assurances in writing that subcontractor or agent will comply with the same restrictions and conditions that apply to the Business Associate under the terms and conditions of this Addendum with respect to such PHI.

V. Protected Health Information Access, Amendment and Disclosure Accounting.

A. Access. Business Associate will promptly upon Recipient's or its Subsidiary's request make available to Recipient, its Subsidiary, or, at Recipient's or such Subsidiary's direction, to the individual (or the individual's personal representative) for inspection and obtaining copies any PHI about the individual which Business Associate created for or received from Recipient or its Subsidiary and that is in Business Associate's custody or control, so that Recipient or its Subsidiary may meet its access obligations under 45 Code of Federal Regulations § 164.524.

B. Amendment. Upon Recipient's or its Subsidiary's request Business Associate will promptly amend or permit Recipient or its Subsidiary access to amend any portion of the PHI which Business Associate created for or received from Recipient or its Subsidiary, and incorporate any amendments to such PHI, so that Recipient or its Subsidiary may meet its amendment obligations under 45 Code of Federal Regulations § 164.526.

C. Disclosure Accounting. So that Recipient or its Subsidiaries may meet their disclosure accounting obligations under 45 Code of Federal Regulations § 164.528:

1. Disclosure Tracking. Business Associate will record for each disclosure, not excepted from disclosure accounting under Section V.C.2 below, that Business Associate makes to Recipient or its Subsidiaries of PHI that Business Associate creates for or receives from Recipient or its Subsidiaries, (i) the disclosure date, (ii) the name and member or other policy identification number of the person about whom the disclosure is made, (iii) the name and (if known) address of the person or entity to whom Business Associate made the disclosure, (iv) a brief description of the PHI disclosed, and (v) a brief statement of the purpose of the disclosure (items i-v, collectively, the "disclosure information"). For repetitive disclosures Business Associate makes to the same person or entity (including Recipient or its Subsidiaries) for a single purpose, Business Associate may provide a) the disclosure information for the first of these repetitive disclosures, (b) the frequency, periodicity or number of these repetitive disclosures and (c) the date of the last of these repetitive disclosures. Business Associate will make this disclosure information available to Recipient

or its Subsidiaries promptly upon Recipient's or its Subsidiaries' request.

2. Exceptions from Disclosure Tracking. Business Associate need not record disclosure information or otherwise account for disclosures of PHI that this Addendum or Recipient or the relevant Subsidiary in writing permits or requires (i) for the purpose of Recipient's or its Subsidiaries' treatment activities, payment activities, or health care operations, (ii) to the individual who is the subject of the PHI disclosed or to that individual's personal representative; (iii) to persons involved in that individual's health care or payment for health care; (iv) for notification for disaster relief purposes, (v) for national security or intelligence purposes, (vi) to law enforcement officials or correctional

4

---

institutions regarding inmates; or (vii) pursuant to an authorization; (viii) for disclosures of certain PHI made as part of a Limited Data Set; (ix) for certain incidental disclosures that may occur where reasonable safeguards have been implemented; and (x) for disclosures prior to April 14, 2003.

3. Disclosure Tracking Time Periods. Business Associate must have available for Recipient and its Subsidiaries the disclosure information required by this section for the 6 years preceding Recipient's or its Subsidiaries' request for the disclosure information (except Business Associate need have no disclosure information for disclosures occurring before April 14, 2003).

VI. Additional Business Associate Provisions.

A. Reporting of Breach of Privacy Obligations. Business Associate will provide written notice to whichever of the Recipient or its Subsidiary for which the relevant PHI was created or from which the relevant PHI was received of any use or disclosure of PHI that is neither permitted by this Addendum nor given prior written approval by Recipient or the relevant Subsidiary promptly after Business Associate learns of such non-permitted use or disclosure. Business Associate's report will at least:

- (i) Identify the nature of the non-permitted use or disclosure;
- (ii) Identify the PHI used or disclosed;
- (iii) Identify who made the non-permitted use or received the non-permitted disclosure;
- (iv) Identify what corrective action Business Associate took or will take to prevent further non-permitted uses or disclosures;
- (v) Identify what Business Associate did or will do to mitigate any deleterious effect of the non-permitted use or disclosure; and
- (vi) Provide such other information, including a written report, as Recipient or the relevant Subsidiary may reasonably request.

B. Amendment. Upon the effective date of any final regulation or amendment to final regulations promulgated by the U.S. Department of Health and Human Services with respect to PHI, including, but not limited to the HIPAA privacy and security regulations, this Addendum and the Agreement will automatically be amended so that the obligations they impose on Business Associate remain in compliance with these regulations.

In addition, to the extent that new state or federal law requires changes to Business Associate's obligations under this Addendum, this Addendum shall automatically be amended to include such additional obligations, upon notice by Recipient or its Subsidiaries to Business Associate of such obligations. Business Associate's continued performance of services under the Agreement shall be deemed acceptance of these additional obligations.

5

---

C. Audit and Review of Policies and Procedures. Business Associate agrees to provide, upon Recipient request, access to and copies of any policies and procedures developed or utilized by Business Associate regarding the protection of PHI. Business Associate agrees to provide, upon Recipient's request, access to Business Associate's internal practices, books, and records, as they relate to Business Associate's services, duties and obligations set forth in this Addendum and the Agreement(s) under which Business Associate provides services and / or products to or on behalf of Recipient or its Subsidiaries, for purposes of Recipient's or its Subsidiaries' review of such internal practices, books, and records.

6

---

This LIABILITY AND PORTFOLIO MANAGEMENT AGREEMENT, dated as of January 1, 2004 (this "Agreement"), between TRINITY FUNDING COMPANY, LLC, a New York limited liability company (the "Company") and GENWORTH FINANCIAL ASSET MANAGEMENT, LLC, a Virginia limited liability company (the "Manager" and together with the Company, the "Parties").

WITNESSETH:

WHEREAS, FGIC MRCA Corp. ("MRCA Corp.") and the Company entered into that certain Investment Administration Agreement, dated as of April 4, 1995 (as subsequently amended, the "Investment Administration Agreement"); and

WHEREAS, the Manager is an investment adviser registered with the United States Securities and Exchange Commission that will be engaged by the Company to provide the services described herein; and

WHEREAS, MRCA Corp. has provided the Company a written notice of resignation pursuant to Section 3.05 of the Investment Administration Agreement and the Company, by executing this Agreement, accepts such resignation and waives the requirement for sixty (60) days' notice thereof; and

WHEREAS, the Investment Administration Agreement will be terminated and replaced by this Agreement; and

WHEREAS, the Manager and the Company wish to establish and define certain obligations set forth in Exhibit C and Exhibit D (the "Listed Obligations") that the Manager is required to undertake in connection with the services it will provide to the Company under this Agreement;

NOW, THEREFORE, in consideration of the mutual promises made herein and upon the terms and subject to the conditions set forth herein, the Parties hereby agree as follows:

ARTICLE I

Definitions

SECTION 1.01. Terms Defined in the Security Agreement. Capitalized terms used in this Agreement that are not defined herein shall have the respective meanings specified in the Collateral Trust and Security Agreement, dated as of April 4, 1995, among the Company, General Electric Capital Corporation ("GE Capital"), as LOC Agent, and Bankers Trust Company (predecessor-in-interest to Deutsche Bank Trust Company Americas), as Security Trustee (as amended, the "Security Agreement").

SECTION 1.02. Terms Defined in this Agreement. As used in this Agreement, the following capitalized terms have the following meanings:

"Accounts" shall have the meaning specified in Section 2.01.

"Agreement" means this Liability and Portfolio Management Agreement, including all provisions of the Security Agreement incorporated by reference herein, which shall have the same effect as if those provisions were set forth in full herein.

"Company" shall have the meaning specified in the preamble of this Agreement.

"Cure Period" means (i) with respect to the Listed Obligations set forth in Exhibit C, the respective cure periods set forth therein, and (ii) with respect to Listed Obligations in Exhibit D or other obligations set forth in this Agreement that do not appear in Exhibit C, one hundred twenty (120) days during the initial term of this Agreement and sixty (60) days thereafter; in each case such Cure Period to commence upon receipt of notice by the Manager from any party to a Contract entitled to give notice of default GE Capital or the Company.

"Designee" shall have the meaning specified in Section 4.05(b).

"Dispute Resolution" shall have the meaning specified in Section 4.05(b).

"Failure Notice Recipients" shall have the meaning specified in Section 4.05(b) or such other recipients as are designated from time to time.

"Final Cure Period" shall have the meaning specified in Section 4.05(b).

"GE Capital" shall have the meaning specified in Section 1.01.

"Impossibility" shall have the meaning specified in Section 4.05(b).

"Indemnified Party" shall have the meaning specified in Section 2.12.

"Investment Administration Agreement" shall have the meaning specified in the first recital of this Agreement.

"Listed Obligations" shall have the meaning specified in the fifth recital of this Agreement.

"Management Fee" shall have the meaning specified in Section 2.06.

"Manager" shall have the meaning specified in the preamble to this Agreement.

"Maximum Permitted Program Size" shall have the meaning specified in Section 2.06.

"MRCA Corp." shall have the meaning specified in the first recital of this Agreement.

"Notice of Failure" shall have the meaning specified in Section 4.05(b).

"Operating Costs" shall have the meaning specified in Section 2.07(b).

“Operations, Procedures and Controls Manual” means the Operations, Procedures and Controls Manual of the Company dated as of July 2, 2003, as the same may be amended from time to time. The Rating Agencies shall receive notice and a copy of any amendments or modifications to the Operations, Procedures and Controls Manual on a biennial basis.

“Parties” shall have the meaning specified in the preamble to this Agreement.

“Permitted Investments Amendment” means an amendment to the Security Agreement which allows the Company to purchase debt issued by GE Capital without limit, subject to (i) the provision by GE Capital of a full and irrevocable guarantee of the Company’s payment obligations under the Contracts and Hedge Contracts, (ii) GE Capital’s being rated at least “AAA”/“Aaa” by the Rating Agencies, and (iii) the retirement in full of the outstanding Preferred Securities issued by the Company.

“Policy 5.0” means the policy which sets forth certain risk management guidelines that the Company is required to observe, as the same may be amended from time to time by the Company with the approval of GE Capital. The Rating Agencies shall receive notice and copy of any amendments or modifications to Policy 5.0 on a quarterly basis.

“Policy 6.0” means the policy which sets forth certain risk management parameters that the Company is required to observe, as the same may be amended from time to time by the Company with the approval of GE Capital. The Rating Agencies shall receive notice and copy of any amendments or modifications to Policy 6.0 on a quarterly basis.

“Portfolio” shall have the meaning specified in Section 2.01.

“Remediation Plan” shall have the meaning specified in Section 4.05(b).

“Security Agreement” shall have the meaning specified in Section 1.01.

“Senior Management” shall have the meaning specified in Section 4.05(b).

“Submission” shall have the meaning specified in Section 4.05(b).

3

---

SECTION 1.03. Other Definitional Provisions. Section 1.02 of the Security Agreement is incorporated herein by reference.

## ARTICLE II

### Engagement; Powers and Duties

SECTION 2.01. Engagement of Manager.

(a) The Company hereby retains the Manager:

(i) to advise the Company as to the investment of its Assets, including recommending specific Permitted Investments (and if applicable, Qualified Investments) and Hedge Contracts to the Company;

(ii) to administer the Company’s Assets maintained in the Facility Account, the Collateral Accounts, if any, and the LOC Reimbursement Account and such other accounts as the Company may maintain from time to time (the “Accounts”), which are identified (to the extent established by the effective date hereof) by account number in Exhibit A, as the same may be amended from time to time, with such deposits thereto and withdrawals therefrom as are from time to time permitted under the Security Agreement;

(iii) for as long as the revocable power of attorney granted pursuant to Section 2.02 is in effect, to arrange the purchase and sale through registered broker-dealers of bonds, pass-through certificates, stocks, and other securities relating to the Accounts;

(iv) for as long as the revocable power of attorney granted pursuant to Section 2.02 is in effect, to arrange the purchase and sale and otherwise to effect transactions in Hedge Contracts relating to the Accounts;

(v) to advise the Company in the issuance of and to assist the Company in the preparation of (and, for so long as the revocable power of attorney granted pursuant to Section 2.02 is in effect, to execute and to deliver on behalf of the Company) Investment Orders and Disposition Orders, as may be required from time to time pursuant to the terms of Sections 2.04 and 2.05 of the Security Agreement;

(vi) to prepare reports and to perform valuation tests as specified in Section 2.06 of the Security Agreement;

(vii) to take such action as is necessary and proper on behalf of the Company for the preservation of Company Collateral pursuant to Section 2.07 of the Security Agreement;

(viii) to assist the Company in the preparation and filing of financing statements or amendments of financing statements, as may be required in connection with

4

---

any change in the Company’s name or location as contemplated by Section 2.08 of the Security Agreement;

(ix) to advise the Company in the granting or effecting of and to assist the Company in the preparation of (and, for so long as the revocable power of attorney granted pursuant to Section 2.02 is in effect, to execute and to deliver on behalf of the Company) any consents, waivers, extensions, or modifications in respect of any item of Company Collateral as contemplated by Section 2.10 of the Security Agreement;

(x) to advise the Company in the delivery of and to assist the Company in the preparation of (and, for so long as the revocable power of attorney granted pursuant to Section 2.02 is in effect, to execute and to deliver on behalf of the Company) any instrument of transfer or release in respect of any item of Company Collateral as contemplated by Section 2.11 of the Security Agreement;

(xi) to notify the Security Trustee and other specified parties as may be required from time to time, pursuant to the terms of the Security Agreement, of a Credit Event or a Program Event of Default;

(xii) to advise the Company as to the allocation of Company Collateral to particular Contracts pursuant to Article V of the Security Agreement and the terms of the relevant Contract;

(xiii) to notify the Security Trustee as may be required from time to time, pursuant to the terms of the Security Agreement, of an LOC Draw Event;

(xiv) to designate persons who are registered representatives of a registered broker-dealer which is a member of the National Association of Securities Dealers to execute and deliver Contracts on behalf of the Company in their capacity as such pursuant to a power of attorney granted by the Company from time to time to registered representatives designated and notified to the Company by the Manager from time to time;

(xv) to engage a registered broker-dealer which is a member of the National Association of Securities Dealers to assist the Company in connection with the offering, issuance and sale of Contracts and, in connection therewith, to make such other arrangements with such broker-dealer as may be necessary or advisable to ensure that such broker-dealer supervises its registered representatives who will effect such transactions and takes responsibility for such offering, issuance and sale; and

(xvi) to take any other action deemed necessary or advisable to write Contracts on behalf of the Company, subject to the limitations set forth in the Security Agreement.

The Manager shall administer all of the Company's Assets in the Accounts (all of such Assets together, the "Portfolio") in accordance with the terms and conditions and shall

5

---

otherwise observe in all material respects the requirements of the Security Agreement and other Program Documents, the Operations, Procedures and Controls Manual, Policy 5.0 and Policy 6.0, this Agreement and all other documents, policies, laws and regulations applicable to the Company from time to time. The Company shall provide copies of the Security Agreement, the Operations, Procedures and Controls Manual, Policy 5.0 and Policy 6.0 to the Manager no later than the time that this Agreement is entered into and shall provide copies of all amendments, supplements and revisions to such documents as soon as they are available to the Company.

(b) Performance. The Parties hereby agree that the Manager shall perform the specific Listed Obligations set forth in Exhibit C and Exhibit D during the term of this Agreement and, subject to Section 2.10, such other functions as are set forth in this Agreement or as are generally required to operate the business of the Company in accordance with applicable laws, regulations, documents and Company policy. The Manager acknowledges that it will take all reasonable steps to continue to conduct the business of the Company in a manner substantially similar to that in which it had been conducted prior to the Parties' entry into this Agreement and in a manner reasonably satisfactory to the Company. The Manager shall perform its duties pursuant to this Agreement (i) exercising the same diligence and care applied to manage its own property; (ii) consistent with the practices used by it (and its Affiliates) to manage portfolios of similar assets for other customers and (iii) consistent with the diligence and care applied by other professional managers of similar stature. Notwithstanding the foregoing, if the Company does not consent, affirmatively or otherwise, to any proposed action by the Manager pursuant to this Section 2.01(b), the Manager's failure to take such proposed action shall not be deemed a breach of its standard of care hereunder.

SECTION 2.02. Power of Attorney. The Company hereby provides the Manager with a revocable power of attorney with full power and authority:

(i) to evaluate and appraise the Portfolio;

(ii) to arrange the purchase and sale through registered broker-dealers of bonds, pass-through certificates, stocks, and other securities in connection with making Investments for the Portfolio;

(iii) to arrange the purchase and sale and otherwise to effect transactions in Hedge Contracts in connection with making Investments for the Portfolio through registered broker-dealers;

(iv) to execute and to deliver on behalf of the Company any Investment Orders and Disposition Orders, as may be required from time to time pursuant to the terms of Section 2.04 and 2.05 of the Security Agreement;

(v) to execute and to deliver on behalf of the Company any consents, waivers, extensions, or modifications in respect of any item of Company Collateral as contemplated by Section 2.10 of the Security Agreement;

6

---

(vi) to execute and to deliver on behalf of the Company any instrument of transfer or release in respect of any item of Company Collateral;

(vii) to engage a broker-dealer acceptable to the Company to assist the Company in the origination, issuance and sale of Contracts in accordance with all applicable securities laws and regulations; and

(viii) subject to the limitations set forth in the Operations, Procedures and Controls Manual, Policy 5.0 and Policy 6.0, to take any other action, including executing agreements and any other documents on behalf of the Company that the Manager deems necessary or advisable to purchase, sell, or otherwise effect investment transactions relating to the Portfolio.

All Investments made, and transactions entered into, by the Manager on behalf of the Company shall be entered into in the name of the Company. All actions contemplated above shall be performed in accordance with applicable laws, regulations, documents and applicable Company policy. The Manager shall not be under an obligation to keep the Portfolio fully invested if, in its sole discretion, it shall determine that market and/or economic conditions make it imprudent or disadvantageous to do so at any time or funds should be made available for distributions and other payments pursuant to the Security Agreement. The Company represents that it has the authority to make the appointment set forth in this paragraph. In the event the Manager fails to perform a Listed Obligation and this Agreement is terminated pursuant to Section 4.05(a) or (b), or if this Agreement is terminated pursuant to Sections 4.05(c) or (d), this power of attorney may be revoked by the Company by written notice to the Manager.

SECTION 2.03. Valuation. The Manager shall value the Portfolio from time to time as required by Section 2.06 of the Security Agreement in order to prepare the reports required thereunder, using the portfolio valuation methods set forth in the Market Valuation Addendum attached as Schedule 1.01 to the Security Agreement, in order to determine whether a Coverage Shortfall, a Program Shortfall or a Net Worth Deficit has occurred and is continuing and whether the Market Sensitivity Limit has been exceeded. The Manager shall also value Qualified Investments on deposit in Allocated Collateral Accounts as required under the terms of each such Allocated Collateral Contract.

SECTION 2.04. Reports. As more particularly specified in the applicable Program Documents and in Exhibit C and Exhibit D, the Manager shall:

(a) prepare the Company's annual financial statements and, unless otherwise specified by the Company, arrange to have such statements audited by a firm of independent accountants acceptable to the Company and GE Capital;

(b) timely prepare and provide to the Security Trustee, the Company and the Rating Agencies such reports as are required to be provided to each of such Persons pursuant to Section 2.06 of the Security Agreement and in accordance with Exhibit 2.06 of the Security Agreement;

7

(c) give prompt written notice to the Company, the Security Trustee, the Broker-Dealers and the Rating Agencies of (i) the existence of a Coverage Shortfall, Program Shortfall, or Net Worth Deficit or (ii) the exceeding of a Market Sensitivity Limit; and

(d) notify the Company and GE Capital immediately upon learning of any Credit Event, Program Event of Default or other material default or breach of the Listed Obligations set forth in Exhibit C.

SECTION 2.05. Confidential Relationships. All information and recommendations furnished by the Manager to the Company shall be treated by the Company as confidential. The Manager shall, in turn, treat as confidential all information concerning the affairs of the Company. Nothing in this Section 2.05 shall be deemed to preclude any such information or recommendations from being disclosed by either Party to such Party's Affiliates or to the directors, officers, employees, representatives, agents, or advisers of such Affiliates, or pursuant to applicable law, regulation or court order; provided, that any such recipients are advised of the confidential nature of such information or recommendations.

SECTION 2.06. Fees. The Company hereby agrees to pay to the Manager a fee (the "Management Fee") at an annual rate of sixteen and one-half (16.5) basis points (0.165%) of the Maximum Permitted Program Size of the Company as of the date hereof, payable quarterly in arrears; provided, however, that the Management Fee shall be pro rated to the date of termination in the event the Agreement is terminated pursuant to Article IV. For the purposes hereof, "Maximum Permitted Program Size" means six billion dollars (\$6,000,000,000) or such larger amount as shall be approved in writing by GE Capital. In no event shall the Management Fee that is payable to the Manager be an amount less than nine million, nine hundred sixty thousand dollars (\$9,960,000) per annum, pro rated to reflect the period of time during which this Agreement was in effect during each year.

SECTION 2.07. Expenses Reimbursed.

(a) The Company shall reimburse the Manager for all out-of-pocket expenses incurred and approved pursuant to Section 2.09(e) in connection with the performance of its duties hereunder, except for any expenses arising out of the Manager's willful misfeasance, bad faith, gross negligence in the performance of or reckless disregard of its obligations and duties hereunder.

(b) The Company shall reimburse the Manager for all appropriate Operating Costs of the Company. Such reimbursement shall be made, upon receipt by the Company from the Manager of a schedule detailing Operating Costs (substantially in the form of Exhibit B hereof), within thirty (30) days following the end of each quarter. For the purposes hereof, "Operating Costs" means all costs incurred by the Manager in connection with the performance of its obligations under this Agreement that have been submitted and approved in writing as part of the annual budget approval process

8

described in Section 2.09(e). For the avoidance of doubt, it is hereby agreed that certain expenses will not be paid by the Manager and do not constitute reimbursable Operating Costs. Such expenses, which are directly attributable to the Company, include fees payable to: (i) each rating agency that assigns a rating to the Company, (ii) external auditors of the Company, (iii) external legal counsel engaged by the Company for services rendered thereto and not in connection with duties of the Manager which are unrelated to the management services it renders to the Company, (iv) certain third-party providers of accounting services to the Company, (v) providers of credit research services required by the Company and (vi) any provider of goods or services for costs incurred in connection with requirements imposed by regulatory authorities, the applicable rating agencies, or any applicable law, rule, regulation, administrative interpretation, ordinance, code issued by a Governmental Authority or regulatory body, or any order, writ, injunction, directive, judgment or decree of a court of competent jurisdiction; each such expense shall be paid by the Company.

SECTION 2.08. Execution of Securities Transactions.

(a) In connection with the offering and sale of Contracts, the Manager shall engage a registered broker-dealer approved by the Company that provides services with respect to the origination, issuance and sale of Contracts that the Manager believes to be of value. The Company shall pay all costs associated with the retention of such broker-dealer.

(b) Except as otherwise specifically directed by the Company, the Manager shall have complete discretion to select any registered broker-dealer in all securities transactions affecting the Portfolio not described in Section 2.08(a). The Manager is expressly authorized to select such brokers-dealers who provide brokerage and research services that the Manager believes to be of value. The Manager is expressly authorized to pay from the Assets in the Portfolio commissions on such transactions in amounts that the Manager determines in good faith to be reasonable in relation to the value of such brokerage and research services, viewed in terms either of the particular transaction or the overall responsibilities of the Manager with respect to the Portfolio.

SECTION 2.09. Administrative Responsibilities. The Manager shall have the following administrative responsibilities:

(a) The Manager shall submit the budget for reimbursable Operating Costs to the Company and GE Capital by no later than January 31 of each year and such budget shall be approved by the Manager of Finance of Corporate Treasury and Global Funding Operations (or such other representative as shall be designated from time to time in a notice to the Manager executed by the Company and GE Capital) by February 15 of such year. Operating Costs incurred in excess of the aggregate amounts approved in the annual budget must be separately approved by the Company and GE Capital in order to be considered for reimbursement.

9

(b) Custody of the Assets comprising the Portfolio will be maintained by the Security Trustee as specified in Article II of the Security Agreement. The Manager shall not have custody of any of the Assets in the Portfolio.

(c) The Manager shall keep such books and records relating to all transactions that it effects pursuant to this Agreement, including without limitation all books and records necessary (in addition to books and records available from the Security Trustee pursuant to Section 2.09(c) or otherwise) for preparing the reports required by Section 2.04.

(d) The Manager on behalf of the Company shall instruct the Security Trustee: (i) to send copies of all statements relating to the Accounts to the Manager; (ii) to permit the Manager, on behalf of the Company, to inspect the Company Collateral in the possession or otherwise under the control of the Security Trustee and the books and records maintained by the Security Trustee relating thereto (and to allow the Manager to make extracts and copies thereof) as the Manager may reasonably request pursuant to Section 2.03(b) of the Security Agreement; and (iii) to report to the Manager, concurrently with reporting to the Company pursuant to Section 2.03(a) of the Security Agreement, any failure on the part of the Security Trustee to hold the Company Collateral as provided in Section 2.03(a) of the Security Agreement.



- (e) For the avoidance of doubt, the Manager shall provide no services to the Company in respect of tax planning or tax compliance of any kind.
- (f) The Manager shall submit presentations relating to the offering of Contracts to the Company and GE Capital for approval prior to external use.
- (g) The Manager shall maintain its status as an “investment adviser” under the Investment Advisers Act of 1940, as amended, and shall follow all applicable laws and regulations relating to its status as such and to its performance hereunder, including all applicable laws and regulations relating to bidding for Contracts.

SECTION 2.10. Other Duties as Reasonably Requested. The Manager shall also perform such other duties or shall modify existing duties as the Company may reasonably request or that the Manager shall recommend to the Company from time to time relating to the management of a business involved in the issuance of guaranteed investment contracts and similar debt obligations issued by providers rated “AAA”/“Aaa” and the management of the proceeds of the issuance of such contracts and obligations. If any additional or modified duties are required of Manager under this Agreement, Manager shall have the reasonable time and opportunity to procure such additional resources as may, in Manager’s good faith judgment, be required to perform such duties. Manager also agrees that it will cease to perform the requirements of certain obligations specified hereunder if the Company so directs in writing. Any such changes or additions shall be deemed for all purposes to be amendments or supplements to this Agreement. The Company shall pay such costs as have been mutually agreed to by the Parties and as may from time to time be required to enable the Manager to perform any additional or

10

---

changed Listed Obligations contemplated herein and other obligations not listed in this Agreement for which additional resources are required or additional costs are reasonably incurred by the Manager.

SECTION 2.11. Limitation of Liability. Neither the Manager nor any of its Affiliates nor any of their respective directors, officers, or employees shall be liable to the Company for any error of judgment or mistake of law or for any loss arising out of any Investment, Hedge Contract, or any other commitment of funds on behalf of the Company or for any act or omission in the administration of the Portfolio except for willful misfeasance, bad faith, gross negligence in the performance of or reckless disregard of its obligations and duties hereunder, other than as may be provided under applicable law.

SECTION 2.12. Indemnification. (a) The Company shall (i) indemnify and hold harmless the Manager and any Affiliate of the Manager and each of their respective directors, officers, employees and agents (each, an “Indemnified Party”) from and against all losses, claims, damages, expenses or liabilities to which such Indemnified Party may become subject (except in respect of the broker-dealer engaged by the Manager in respect of placement of Contracts, which shall be the sole liability of the Manager), insofar as such losses, claims, damages, expenses or liabilities (or actions, suits or proceedings including any inquiry or investigation or claims in respect thereof) arise out of, in any way relate to, or result from the transactions contemplated by, this Agreement, and (ii) reimburse each of the Indemnified Parties upon its demand for any reasonable legal or other expenses incurred in connection with investigating, preparing to defend or defending any such loss, claim, damage, liability, action or claim, in each case only to the extent that funds are available therefor in accordance with the Security Agreement; provided, however, that none of the Indemnified Parties shall have the right to be so indemnified hereunder for losses, claims, damages, expenses or liabilities to the extent resulting from its own negligence or willful misconduct or for losses, claims, damages, expenses or liabilities that it is required to pay to any broker-dealer that it has engaged in connection with the Contracts or other liabilities. If any action is brought against an Indemnified Party indemnified or intended to be indemnified pursuant to this Section 2.12, the Company shall, if requested by such Indemnified Party, resist and defend such action, suit or proceeding or cause the same to be resisted and defended by counsel reasonably satisfactory to such Indemnified Party, but shall not be empowered to compromise or settle such action, suit or proceeding unless such Indemnified Party has been fully indemnified for any loss, claim, damage, expense or liability it thereby suffers. Each Indemnified Party shall, unless the Indemnified Party has made the request described in the preceding sentence and such request has been complied with, have the right to employ its own counsel to investigate and control the defense of any matter covered by such indemnity and the reasonable fees and expenses of such counsel shall be at the expense of the Company. Any obligations of the Company pursuant to this Section 2.12 are Deferred Expenses and the Manager shall have recourse solely to the LOC Reimbursement Account for such obligations of the Company (and not to any other assets of the Company) and shall be paid in the priority specified in the applicable

11

---

sections of Article VII of the Security Agreement. The Manager hereby expressly consents to such limited recourse to the LOC Reimbursement Account and to such priorities of distributions set forth in Article VII of the Security Agreement.

### ARTICLE III

#### Representations and Warranties

SECTION 3.01. Valid Existence; Authorization; Enforceability. Each of the Parties represents and warrant to the other as follows:

- (a) such Party is a limited liability company duly organized, validly existing and in good standing under the laws of the jurisdiction of its organization and has all requisite power, legal right and authority to execute and deliver this Agreement and all other documents to be executed and delivered by such Party in connection herewith and to perform its obligations hereunder and thereunder; and
- (b) this Agreement and all the documents to be executed and delivered by such Party in connection herewith and therewith has been duly authorized by all necessary actions on the part of such Party.

### ARTICLE IV

#### Miscellaneous Provisions

SECTION 4.01. No Assignment Without Consent. This Agreement, and the obligations and rights arising under this Agreement, may not be assigned or otherwise transferred by either Party (including any assignment or transfer in connection with any Person succeeding to any part of the business of either Party) without the prior written consent of the other Party and without obtaining Rating Agency Confirmation.

SECTION 4.02. Counterparts. This Agreement may be executed in one or more counterparts and, as so executed, shall constitute one agreement binding upon the Parties.

SECTION 4.03. No Third Party Beneficiaries. Nothing expressed or implied in this Agreement is intended or shall be construed to confer upon any person (other than the Parties and their permitted assigns), any right, remedy or claim by reason of this Agreement or any term hereof, and all terms contained herein shall be for the sole and exclusive benefit of the Parties and their successors and permitted assigns.

SECTION 4.04. Interpretation. The headings of the Articles and Sections hereof are for convenience of reference only and shall not affect the meaning or construction of any provision hereof.

SECTION 4.05. Term; Termination.

(a) The Manager's appointment hereunder shall continue in effect for an initial term commencing on the date hereof and ending on December 31, 2006, with extensions for additional one (1) year periods commencing automatically upon each anniversary thereof, unless either Party notifies the other Party in writing at least ninety (90) days before such anniversary that such extension shall not be effective.

(b) If the Manager fails to perform any of its obligations set forth in this Agreement, Exhibit C or Exhibit D, the Manager (or if the failure is first discovered by the Company, then the Company) shall give prompt written notice (such notice, a "Notice of Failure") to the persons identified in Exhibit E (the "Failure Notice Recipients") specifying the nature of the failure; provided that in the event the Manager fails to perform any of its obligations set forth in Exhibit C, the Company shall give prompt written notice of such failure to the Rating Agencies in addition to the Failure Notice Recipients. In the event such Notice of Failure is given, then either the Manager or the Company may elect to submit the matter for review (a "Submission") and resolution ("Dispute Resolution"), which may include the establishment of a plan of remediation (a "Remediation Plan"), to (i) with respect to the Manager, the Business Leader of the Retirement Income and Investment Segment of Genworth Financial, Inc. (or such person or persons as such Business Leader may designate) and (ii) with respect to the Company, the Senior Vice President – Corporate Treasury and Global Funding Operation of GE Capital (or such person or persons as such Senior Vice President may designate) ((i) and (ii) together, "Senior Management"). The Manager and the Company agree (x) to cooperate in good faith and in a reasonable manner to reach an agreement with respect to any Remediation Plan; (y) to be bound by the results of any such Dispute Resolution agreed to by Senior Management including any Remediation Plan (the timing and content of which shall be at the sole discretion of Senior Management) and (z) that the Manager will implement any such Remediation Plan within the period mandated by Senior Management (the "Final Cure Period"). The result of any such Dispute Resolution shall be in writing signed by Senior Management, shall be deemed part of this Agreement and, with the respect to the failure involved, shall supersede any conflicting or different terms of this Agreement. The Chief Operating Officer of Manager's Capital Markets Group responsible for management of the Company or a person designated by such officer (a "Designee") shall provide to the Rating Agencies notice and a copy of any Remediation Plan resulting from a Dispute Resolution that is deemed by such officer or Designee to have a potential adverse effect on the ratings of the Company. The Manager shall identify such officer or Designee in the appropriate periodic risk reports submitted to the Rating Agencies.

If Senior Management fails to reach an agreement with respect to a Dispute Resolution and the Cure Period has not expired, the matter in dispute shall be resolved solely and exclusively in accordance with the arbitration procedures set forth in Exhibit E.

If (i) Senior Management or an arbitral tribunal described in Exhibit F fails to reach agreement with respect to a Dispute Resolution and the Cure Period has expired or (ii) the Manager fails to correct the failure by the end of the applicable Final Cure Period, then this Agreement may, subject to Section 4.05(c), be terminated by the Company upon two (2) Business Days' prior written notice to the Manager and each Failure Notice Recipient specifying the basis for and the effective date of the termination.

Notwithstanding the foregoing, the payment obligations of the Company during the initial term of this Agreement shall not be terminated if any such failure and the continuation thereof are caused by Impossibility. For the purposes hereof "Impossibility" means loss or malfunction of electric power, transportation or communication services; general inability to obtain or retain labor, material, equipment or transportation, or a delay in mails or services; the Company's, GE Capital's or their Affiliates' (i) failure to take an action on which the Manager's performance of an obligation or any Listed Obligation depends or (ii) taking an action which renders the Manager's performance of an obligation or any Listed Obligation impossible; governmental or exchange action, statute, ordinance, ruling, regulation, administrative interpretation or directive; acts of terror, vandalism, explosions, tornados, acts of God or public enemy, acts of any civil or military authority, revolutions, insurrections, strike, emergency, riots or civil commotions, freezes, fires, floods, embargoes, wars, sabotage, explosions or other unforeseen or unexpected occurrences, which unforeseen or unexpected occurrences render the performance of any obligations by the Manager impossible. In the event of any such occurrence, the Manager shall use all reasonable efforts to remediate the disruption and resume its performance of the obligations.

(c) The Company shall have the right, by giving the Manager thirty (30) Business Days' prior written notice, to terminate this Agreement at an earlier time than that specified in Section 4.05(a) in the event of continuing non-performance by the Manager due to Impossibility of any obligation hereunder beyond the applicable Cure Period or Final Cure Period, or if the Company liquidates all or substantially all of the Assets of the Company held in the Facility Account and substitutes therefor the debt of GE Capital pursuant to the terms of the Permitted Investments Amendment. Upon termination of this Agreement pursuant to this Section 4.05(c), the Manager shall be paid a termination fee by the Company equal to the product of (i) sixteen and one-half (16.5) basis points (0.165%), multiplied by (ii) the Maximum Permitted Program Size, multiplied by (iii) the percentage derived by dividing the number of days remaining in the initial term by 365. In addition, the termination fee shall include any actual cost incurred and agreed upon and reasonably associated with terminating the operations set forth in this Agreement, including but not limited to employment severance costs as determined by the standard practices of the Manager.

(d) The Manager may resign upon not less than ninety (90) days' prior written notice to the Company.

(e) Notwithstanding any provision to the contrary, including the expiration of any term of this Agreement, so long as the Portfolio is still outstanding, this

Agreement shall remain in full force and effect and no termination or resignation of the Manager shall be effective until the Company has entered into an agreement with a successor manager. Upon receiving a notice of resignation from the Manager, the Company shall use its best efforts to enter into such an agreement unless it elects to terminate this Agreement as provided in Section 4.05(c) above. Except as set forth in Exhibit F, nothing in this Agreement shall be deemed a waiver of any Party's rights to pursue remedies at law or in equity, which shall be available in accordance with applicable law in addition to any remedies provided for in this Agreement.

SECTION 4.06. Independent Contractor. The Manager is being engaged pursuant to this Agreement as an independent contractor and the Parties expressly disclaim any intention to enter into a joint venture, partnership, or any other form of association pursuant to this Agreement.

SECTION 4.07. GOVERNING LAW. THIS AGREEMENT SHALL BE GOVERNED BY, AND CONSTRUED IN ACCORDANCE WITH, THE INTERNAL LAWS OF THE STATE OF NEW YORK, WITHOUT REGARD TO THE RULES OF CONFLICTS OF LAWS OF THE STATE OF NEW YORK OR ANY OTHER JURISDICTION.

SECTION 4.08. Notices. All notices, instructions, and advice with respect to any transactions or other matters contemplated by this Agreement shall be deemed duly given only when actually received at such Party's principal place of business as set forth below. Return receipt or courier record of delivery shall be deemed conclusive evidence of receipt. Notices may be made by fax or other electronic means shall be deemed given upon electronic evidence of receipt at applicable recipient's fax or computer station. A copy of all notices given shall be provided to GE Capital.

If to the Manager:

Genworth Financial Asset Management, LLC  
6620 West Broad Street  
Richmond, Virginia 23230  
Attention: Pamela Schutz  
Phone: (804) 291-6533  
Fax: (804) 281-6165  
E-mail: pamela.schutz@ge.com

with a copy to:

335 Madison Avenue, Mezz4  
New York, New York 10017  
Attention: Shailesh Shah  
Phone: (212) 389-2575  
Fax: (212) 389-2591  
E-mail: shailesh.shah@ge.com

15

---

If to the Company:

Trinity Funding Company, LLC  
335 Madison Avenue  
Mezz4  
New York, New York 10017  
Attention: Shailesh Shah  
Phone: (212) 389-2575  
Fax: (212) 389-2591  
E-mail: shailesh.shah@ge.com

If to General Electric Capital Corporation:

General Electric Capital Corporation  
260 Long Ridge Road  
Stamford, Connecticut 06927  
Attention: Senior Vice President – Corporate  
Treasury and Global Funding Corporation  
Phone: (203) 961-5077  
Fax: (203) 357-3490  
E-mail: alan.green1@ge.com

SECTION 4.09. Entire Agreement; All Amendments in Writing (a) This Agreement embodies the entire understanding of the Parties concerning the subject matter hereof and supersedes any and all other previous agreements, written or oral, concerning the same subject matter.

(b) The Parties may at any time and from time to time agree to any amendment or modification of any provision of this Agreement to cure any mistake, ambiguity, defect or inconsistency or to correct any manifest error or to correct any error of formal, minor or technical nature. The Rating Agencies shall be given written notice of any amendment under this Section 4.09(b) not less than fifteen (15) days prior to the effective date thereof.

(c) The Parties may at any time and from time to time agree to any amendment or modification of any provision of this Agreement other than any amendment or modification provided for in Section 4.09(b); provided that, in each case, a Rating Agency Confirmation shall be obtained prior to the effectiveness of such amendment or modification.

(d) Any amendment to any provision of the Security Agreement that is incorporated by reference in this Agreement (including, without limitation, any amendment to any of the capitalized terms incorporated by reference herein), so long as such amendment is made as permitted under the terms of the Security Agreement, shall constitute an amendment to this Agreement unless the Parties agree in writing that such amendment shall not be effective under this Agreement.

16

---

SECTION 4.10. Waiver. No waiver of any provision of this Agreement nor consent to any departure therefrom shall in any event be effective unless the same shall be in writing and signed by the Party from whom such waiver or consent is sought, and then such waiver or consent shall be effective only in the specific instance and for the specific purpose for which given. The Party seeking such waiver or consent shall promptly deliver a copy thereof to the Rating Agencies.

SECTION 4.11. Further Assurances. Each Party hereby agrees to execute and deliver such additional documents, instruments or agreements as may be reasonably necessary and appropriate to effectuate the purposes of this Agreement.

SECTION 4.12. Successors and Assigns. This Agreement shall be binding upon the Parties and their respective successors and assigns.

SECTION 4.13. Severability. Any term or provision of this Agreement which is invalid or unenforceable in any jurisdiction shall, as to that jurisdiction, be ineffective to the extent of such invalidity or unenforceability without rendering invalid or unenforceable the remaining terms and provisions of this Agreement or affecting the validity or enforceability of any of the terms or provisions of this Agreement in any other jurisdiction. If any provision of this Agreement is so broad as to be unenforceable, the provision shall be interpreted to be only so broad as is enforceable.

SECTION 4.14. Limited Recourse. The obligations of the Company under this Agreement are solely the obligations of the Company. No recourse shall be had for any obligation or claim arising out of or based upon this Agreement against any Member, manager, officer organizer, agent or employee of the Company or any shareholder, officer, director, employee, agent or incorporator of any Member. Any accrued obligations owing by the Company shall be payable by the Company solely to the extent that funds are available therefor from time to time in accordance with the provisions of Article VII of the Security Agreement (and such accrued obligations shall not be extinguished until paid in full.)

SECTION 4.15. Termination of the Investment Administration Agreement; Release. Effective as of the date hereof, the Company does hereby, for itself and its successors and assigns, waive the sixty (60) days' notice requirement of Section 3.05 of the Investment Administration Agreement and accepts the resignation of MRCA Corp. as the Portfolio Adviser thereunder and fully and unconditionally release and forever discharge MRCA Corp. (and any officer, director, employee or agent of

MRCA Corp.) from any and all present and future (i) obligations and liabilities under the Investment Administration Agreement and (ii) causes of action, suits, claims, demands, liabilities and obligations whatsoever, whether at law or in equity, arising from or related to the Investment Administration Agreement, arising from and after the date hereof.

[Signature Page Follows]

IN WITNESS WHEREOF, the Parties have executed this Agreement as of the date first above written.

TRINITY FUNDING COMPANY, LLC,  
a New York limited liability company

By: IC FUNDING CORP.,  
a Delaware corporation,  
as its Controlling Common Member

By: \_\_\_\_\_  
Name:  
Title:

GENWORTH FINANCIAL ASSET MANAGEMENT, LLC

By: \_\_\_\_\_  
Name:  
Title:

ACKNOWLEDGED AND CONSENTED TO BY:

FGIC MRCA CORP.

By: \_\_\_\_\_  
Name:  
Title:

AGREED AND ACCEPTED BY:

GENERAL ELECTRIC CAPITAL CORPORATION

By: \_\_\_\_\_  
Name:  
Title:

[LIABILITY AND PORTFOLIO MANAGEMENT  
AGREEMENT (TRINITY)]

**Exhibit A**

**Accounts Comprising the Portfolio**

<u>Account</u>	<u>Custodian Bank</u>	<u>Account Number</u>
Facility Account	Deutsche Bank Trust Company Americas, New York, NY	091778
LOC Reimbursement Account	Deutsche Bank Trust Company Americas, New York, NY	14486
Account	Deutsche Bank Trust Company Americas, New York, NY	

**Exhibit B**

**Form of Schedule of Operating Costs**

Operating Costs for the first calendar year, commencing on January 1, 2004, shall be \$[ ] and thereafter shall be equal to [ ]% of the Operating Costs of the Manager, subject to the Company's approval, as provided in Section 2.07(b) and shall consist of the following (allocated [ ]% with respect to the Company):

CMS	2004				2004
	1Q	2Q	3Q	4Q	TY
<b>Comp &amp; Benefits:</b>					
Salaries	\$	\$	\$	\$	\$
Savings Plan 401k					
Bonuses					
Employee Insurance					
Payroll Taxes					
<b>Total Comp &amp; Benefits</b>					
<b>Purchase Base:</b>					
Travel & Living Expenses					
Business Meetings					
Education					
Employment Fees					
Tuition Reimbursement					
Relocation Maintenance					
Dues & Associations					
Consulting Fees					
Outside Services					
Rent/ Utilities					
Legal Fees					
Audit Fees					
Recreation					
Telephone/Cellular					
Printing & Office Supplies					
Postage/Courier Service					
Subscriptions					
Information Services					
Advertising / Marketing					
Temporary Help					
Equipment Maintenance					
Hardware Expense					
Software Expense					
Fiscal Agent Fees					
Investment Fees					
Organizational Misc					
<b>Total Purchase Base</b>					
<b>Total Controllable</b>					

B-1

CMS	2004				2004
	1Q	2Q	3Q	4Q	TY
<b>Other:</b>					
Property Insurance					
Corporate Assessments					
<b>Total Other</b>					
<b>SG&amp;A Expenses</b>					
Rating Agency Fee					
Loss On Other Assets					
Insurance And Licensing					
State And Local Taxes					
Goodwill Amortization					
Change in DAC					
Ceding Commission					
<b>Non-SG&amp;A Expenses</b>					
<b>Op &amp; Admin Expense</b>					
Depreciation					
<b>Total Direct Expenses</b>					
Broker Fees Amortization					
<b>Total Expenses</b>					
<b>(including Broker Fees)</b>	\$	\$	\$	\$	\$

B-2

Exhibit C

Priority Manager Functions

Listed Obligation	Cure Period
Payments	

Manager shall cause payments to be made as required under any Contracts, Hedge Contracts or other agreement to which the Company is a party.

Five (5) Business Days from the date a notice of nonpayment received by Manager under the applicable Contract, Hedge Contract or agreement (or such shorter period as exists prior to such nonpayment being an actionable default thereunder); provided, however, that if the Manager or the Company gives notice to the other party requesting Dispute Resolution within one (1) Business Day of notice, the cure period hereunder shall be extended by three (3) Business Days from the date the notice of nonpayment is received (it being understood that in no event shall this section supersede the contractual payment obligations in the respective Contracts or Hedge Contracts).

#### Risk Matters

Manager shall comply with all requirements of GE Capital's Policy 5.0 and 6.0 relating to the Company and related "strike zones," as such policies and strike zones are amended from time to time, and all requirements relating to Permitted Investments and the portfolio in the Security Agreement; provided, that in the event that a trigger has been tripped under Policy 6.0 by virtue of a change in the market or pursuant to the action of a rating agency, GE Capital shall provide direction on remediation on a case-by-case basis if not otherwise provided for in Policy 6.0 and, if the Manager takes the appropriate corrective action (whether as prescribed by the Policy or as directed by GE Capital), no failure to perform an obligation under this Agreement shall be deemed to have occurred.

Five (5) Business Days.

#### Rating Agency Requirements

Manager shall prepare all reports on the dates specified by each rating agency currently rating obligations of the Company and shall meet all requirements specified by any such agency for continuation or reinstatement of their highest long-term and short-term ratings.

Thirty (30) days or such shorter or longer period as is specified for compliance by the rating agencies.

C-1

#### Listed Obligation

#### Cure Period

#### Financial Reporting

Manager shall comply with Section 2.04 hereof and the Listed Obligations and shall prepare all reports relating to the Company as are necessary or desirable for compliance with the Sarbanes-Oxley Act of 2002 and any other financial reporting requirements of the Company under applicable law and external regulation.

Thirty (30) days or such shorter or longer period as is specified by the applicable accounting firm or regulatory body to allow for compliance with the applicable regulatory or disclosure requirement.

#### Legal Compliance

Manager shall prepare disclosure documentation annually or more frequently as is necessary or desirable in connection with its offering of Contracts and Preferred Securities and shall otherwise comply with the requirements of contracts to which it is a party, and all applicable laws and regulations.

Thirty (30) days or such other period as is specified in the applicable agreement or regulation or as is directed by the applicable regulatory body.

C-2

### Exhibit D

#### **Listed Obligations**

#### Business

- Manager will use its best efforts to maintain an Average Program Size of thirteen billion dollars (\$13,000,000,000) or such other amount reasonably specified by the Company from time to time for the combined portfolios of the Company and Trinity Funding Company, LLC. For the purposes hereof, the term "Average" means a rolling 3-month average of end-of-day balances, computed daily.
- Manager will review the Portfolio Quality Review with GE Capital on a monthly basis on such dates as Manager and GE Capital shall agree to in advance.

#### Compliance/Legal

- Manager will maintain the corporate and limited liability company minutebooks and records of the Company and its non-controlling common members and any successors thereto, and take all actions required to maintain their valid existence and good standing in the jurisdictions in which they are organized or qualified.
- Manager will comply with applicable law in respect of the Company's issuance of Contracts and Preferred Securities, including with respect to rules promulgated under federal securities laws that restrict certain forms of advertising and solicitation.
- Manager will prepare updated versions of the Confidential Information Memorandum of the Company (i) on an annual basis to reflect then-current audited financial information of the Company or (ii) at such other times as may be required by the Company.
- Manager will, as required from time to time, prepare updated versions of the Private Placement Memorandum of the Company relating to the Company's issuance of Preferred Securities.
- Manager will use its best efforts to take all actions required in connection with obtaining the appropriate authority with respect to the extension of the Liquidity Commitment and/or the Letter of Credit commitment and any required increase of the Liquidity Commitment and/or the Letter of Credit commitment (it being

understood that no failure to perform a Listed Obligation shall be deemed to have occurred if either such commitment is not extended or increased after a request has been submitted).

- Manager will consult with and obtain approval from the Company in connection with proposed material modifications to the terms or the form of Contracts.

D-1

---

- Manager will maintain its status as an “investment adviser” under the Investment Advisers Act of 1940, as amended, and will take all reasonable steps to comply with all applicable laws and regulations relating to its status as such.
- Manager will cause its legal staff to draft and prepare all Contracts, Hedge Contracts and other contracts entered into by the Company. The in-house counsel of Manager may, to the extent required, engage outside counsel in connection with the preparation of such contracts if such engagement is approved verbally or in writing by the General Counsel – Treasury Operation of GE Capital and otherwise approved under Section 2.09. Nothing in this Agreement will preclude Manager from engaging its own outside counsel for any purpose it deems necessary or advisable, and Manager need not obtain any separate approval therefor.
- Manager will comply with all applicable laws and all applicable policies and procedures as the same may be provided to Manager by the Company, including but not limited to the USA Patriot Act and Anti-Money Laundering policies and laws.
- Manager will take all reasonable actions required to assist the Company or GE Capital in connection with changes to the corporate structure of the Company and its common members.
- Manager will take all reasonable steps to provide prompt responses to GE Capital in connection with requests from regulatory or other governmental authorities for documentation or data relating to the operation of the Company.
- Manager will comply with all applicable laws, regulations, policies, management procedures and other requirements of the Company, GE Capital and Genworth, including but not limited to the GE Capital Information Security Procedure and, to the extent applicable, the policies contained in “Integrity: The Spirit and the Letter of Our Commitment.”

#### Liability/Contract Bidding Process

- Manager shall ensure that transactions in Contracts are effected in accordance with the following general procedure: (i) a registered representative of a broker-dealer (each, a “GIC Salesperson”) shall receive bid specifications (“Bid Specs”) provided by prospective Contract customers or their agents (“Customers”); (ii) the GIC Salesperson shall analyze the Bid Specs and respond to Customers, indicating to such Customers, where appropriate, the requirements to maintain the Company’s exemption from registration under the Investment Company Act of 1940, as amended; (iii) the GIC Salesperson shall submit all Bid Specs for review and comment to the designated member of the Manager’s legal staff and will note on any bid acceptance form that is delivered to the Customer all appropriate

D-2

---

comments received from the legal staff; (iv) the GIC Salesperson shall price transactions in which the Company has an interest in bidding and communicate such pricing to the applicable Customer; and (v) the Manager’s legal staff shall provide counsel to the GIC Salesperson in connection with the preparation, negotiation and closing of all Contracts for transactions that the Company wins.

#### Financial Controls

- Manager will perform its accounting responsibilities in compliance with GE Capital’s internal accounting policies and U.S. GAAP.
- Manager will maintain accounting policies currently in place and all changes to accounting policies must be approved in advance by GE Capital. For new accounting standards, GE Capital will provide Manager with the accounting policy to be adopted by the Company.
- Manager will perform accounting in accordance with FAS 133 and obtain approval from GE Capital for the following FAS 133 activities:
  - Changes to existing hedge documentation
  - Changes in existing methodology used to assess and measure hedge effectiveness
  - Application of “fair value” hedging as defined in FAS 133
  - Economic hedges that do not qualify for FAS 133 hedge treatment
- Manager will provide a monthly variance analysis of:
  - Changes in the fair market value of derivatives
  - Hedge ineffectiveness
  - Amounts excluded from the measure of effectiveness
- Manager will reconcile all general ledger accounts in accordance with GE Capital’s account reconciliation criteria. Manager will provide a quarterly dashboard of account reconciliations and open items (in an agreed upon format) on dates to be provided to Manager.
- Manager is responsible for establishing and maintaining a system of internal controls adequate to ensure that Assets are appropriately safeguarded and that the financial statements and related disclosures and schedules fairly present the financial condition of the Company.
- Manager and GE Capital will agree upon and execute a plan to minimize profit and loss volatility associated with FAS 133.

D-3

---

- Manager will deliver monthly unaudited financial results including any adjustments to the monthly financials to be included in the next month’s accounting period.

These financials should include an explanation of significant items of variance to the Operating Plan. Such financial statements will be delivered within fifteen (15) days of the close as defined by GE Capital.

- Manager will deliver quarterly unaudited financial reports and schedules in accordance with GE Capital's closing instructions. Such financial statement will include variance and profitability analysis suitable for the closing of the books. Closing instruction to be provided by the 15th of the month of the quarterly close.
- Manager will provide the Company with financial projections in accordance with GE Capital's SI, SII and OP process. GE Capital will provide the Manager with SI, SII and OP timing and assumptions where needed to make such forecasts.
- Manager will deliver annual audited financial statements (balance sheet and income statement) upon completion of the annual audit by GE Capital's external auditors.
- Manager will conduct annual reviews in compliance with applicable provisions of the Sarbanes-Oxley Act of 2002, in a manner acceptable to GE Capital.
- Manager will report detailed profit and loss results and details of expenses within fifteen (15) days following the end of each quarterly period, including comparisons of actual versus plan, in a format reasonably agreeable to both parties. Profit and loss reports will be included in the monthly Portfolio Quality Review, substantially in the format attached as Schedule I to this Exhibit D.

#### Risk

- Manager will comply with the Permitted Investments guidelines provided in Schedule 4.01(g) of the Security Agreement.
- Manager will value the Portfolio from time to time, as required by Section 2.06 of the Security Agreement in order to prepare the reports required by such Section of the Security Agreement, using the portfolio valuation methods set forth in the Market Valuation Addendum attached as Schedule 1.01 to the Security Agreement, in order to determine whether a Coverage Shortfall, a Program Shortfall or a Net Worth Deficit has occurred and is continuing and whether the Market Sensitivity Limit has been exceeded. The Manager shall also value Permitted Collateral investments on deposit in Collateral Accounts as required under the terms of each Collateralized Contract.
- Manager will comply with all applicable terms set forth in Policy 5.0 and Policy 6.0 and all "strike zones" defined by GE Capital with respect to assets, liabilities

D-4

---

and derivatives (as each may be amended from time to time by GE Capital). Manager will deliver the following reports on a monthly basis for monitoring such compliance:

- Portfolio Quality Review
  - Credit Limit Watch
  - Credit Risk Rating
  - Stop Loss
  - Month End Credit
  - Counterparty Exposure
- Except as otherwise specified in this Exhibit D, Manager will deliver risk reports to GE Capital on a monthly basis and will include, at a minimum, the following:
    - Portfolio Quality Review
    - Supplemental Program Shortfall
    - Liquidity Report (provided on a daily basis)
    - Summary Hedge Analysis Report (provided on a daily basis)
    - REM (electronic submission)
  - Manager will provide other available reports required from time to time by GE Capital as they are requested.
  - Manager will participate, on a monthly and quarterly basis, in in-force reviews with Genworth senior management and GE Capital senior management.
  - Manager will from time to time provide GE Capital with data feeds relating to the Portfolio, the content, format and timing of the delivery of which feeds will be agreed upon by Manager and GE Capital.
  - Manager will (i) comply with applicable requirements as to hedge counterparty ratings, as set forth in the Security Agreement and as provided in the applicable policies of GE Capital, (ii) comply with the applicable requirements to provide information to GE Capital with respect to hedge counterparty exposure, (iii) deliver a Counterparty Exposure report for monitoring such compliance and (iv) comply with such restrictions as to hedge counterparty that may from time to time be imposed by GE Capital.
  - Manager will from time to time provide GE Capital with such available additional risk analyses as GE Capital may request, including but not limited to, stress tests and value at risk analyses. In each case, the content, format and timing of the delivery of such analyses will be agreed upon, prior to delivery, by GE Capital and Manager.

D-5

---

- Manager will comply with all applicable requirements relating to the Company's maintenance of the "AAA"/"Aaa" ratings assigned thereto by the applicable rating agencies.

#### Customer

- Manager will ensure delivery by mail or e-mail, or will make available on the Company's website, to the Company's customers in accordance with such customers' respective Contracts, Customer Statements in respect of customers' investments with the Company.



- Manager will ensure the timely remittance of payments required under each Contract or other agreement of the Company.
- When requested by the Company and GE Capital, Manager will deliver to the Company and GE Capital customer service metrics (e.g., call volume by customer complaint type by date) and deal closing customer survey results (if and to the extent the same is provided by customers).

#### Information Technology

- Manager will maintain the current systems environment to fully support the business requirements and the services to be performed under this Agreement for the Company.

#### Continuous Service (Disaster Recovery)

A disaster recovery site shall be maintained as follows:

- Backup copies of critical servers shall be maintained at an off-premises Disaster Recovery Site (locations to be determined from time to time by the Parties hereto). The critical servers are as follows: Principia PAS server, Oracle Data Warehouse Server, File Server, Oracle GL Server, and FileNET CM Server. In the event of a major disaster where access to production servers and 335 Madison Avenue's assets (or those of a successor location from which the Company's business is operated) is lost, service will be restored on the following schedule: PAS and Oracle Data warehouse systems will be within twenty-four (24) hours. GL and FileNET server will be available within forty-eight (48) hours. The Parties will work with GE Capital Treasury on a best effort basis to establish and implement an adequate Disaster Recovery plan.

D-6

---

- Software refreshes to synchronize the DR systems with the production systems shall be done within twenty-four (24) hours of the update of the production system to coincide with production system updates.
- Backups of the production PAS database shall be copied to the DR PAS server nightly.

#### Data Management (Backups and Retention)

- Full data backups are performed daily on all production and Quality Assurance systems.
- Full data backups of all Network files are performed daily.
- Backup tapes shall be stored offsite at Iron Mountain. Tapes are picked up by 10:30 a.m. daily.
- An authorized list of personnel may recall tapes from Iron Mountain (an agreement exists to deliver backup tapes to any location, including the home of IT personnel).
- Tapes shall be cycled on a rolling eight (8) week rotation. All Financial close and Month End tapes shall be marked permanent and retained indefinitely.

#### Change Management: Notification and Approval Process on Changes to IT Infrastructure and Application Software

- GE Capital Treasury shall have the right to approve the Company's Change Management Process.
- All change requests shall be reported to GE Capital Treasury on a weekly basis.
- Emergency changes to the IT Environment shall be reported to GE Capital Treasury as they occur.
- In the event of a major System Failure GE Capital Treasury shall be notified and required to approve required changes.

#### Performance and Capacity Planning Reporting and Reviews

- In general, monthly business reports shall be available by 9:00 a.m. the last Business Day of the month. The IT team will communicate all exceptions by

D-7

---

8:30 a.m. on the day such exceptions occur. The communication will include the anticipated delivery time. The following performance tracking processes exist:

- Monthly report of nightly batch completion times.
- Monthly report of nightly batch completion times.
- Monthly report of exceptions and violations of the 9:00 a.m. report delivery times and cures employed.
- Monthly report on system loading and projected performance bottlenecks and issues and resolutions.
- Monthly report of license denials.
- GE Capital Treasury shall perform a quarterly review of systems and access rights to those systems. IT shall prepare the report to be reviewed, deliver a copy to GE Capital Treasury and will remediate issues discovered. An updated access matrix will be added to the "CMS Operational Procedures and Controls" document quarterly.

#### Personnel

- Manager will maintain a staff of qualified employees sufficient to support the business requirements of the Company and to perform the services required under this Agreement.

#### Other Obligations

- Manager will comply in all material respects with all other obligations provided under this Agreement.

D-8

**Schedule I**

**Format of P&L Included with  
Monthly Portfolio Quality Review**

<b>CMS P&amp;L (\$millions)</b>	<b>Actual</b>	<b>Operating Plan</b>	<b>Variance from Operating Plan</b>
<b>Net Revenue:</b>			
Trinity Gross Spread Income	\$	\$	\$
Trinity Broker Fees Amortization			
Trinity Hedge Ineffectiveness			
<b>Trinity Net Interest Margin</b>			
Trinity Realized Gains (Losses)			
<b>Subtotal Trinity Net Revenue</b>			
GE Book			
<b>Total CMS Net Revenue</b>			
<b>Operating Expenses:</b>			
CMSI	\$	\$	\$
Trinity			
MRCA			
<b>Total Operating Expenses</b>			
<b>Total CMS Pre-tax Income</b>			
<b>Tax (Benefit)</b>			
<b>Net Income</b>	<b>\$</b>	<b>\$</b>	<b>\$</b>
Trinity Average Liability Balance			
Core Spread (including Broker Fees)			
Net Spread (Including Hedge Ineffectiveness)			
<b>Memo: Net Income Sharing</b>			
Genworth (Management Fee + GE Book)			
GEI Other			

D-9

**Exhibit E**

**Failure Notice Recipients**

<b>Recipient</b>	<b>Address</b>	<b>Telephone</b>	<b>Facsimile</b>
<b>Manager</b>			
Pamela Schutz	6610 West Broad Street Richmond, Virginia 23230	(804) 281-6533	(804) 281-6165
Kelly Groh	6610 West Broad Street Richmond, Virginia 23230	(804) 281-6321	(804) 281-6310
Toni Ness	6610 West Broad Street Richmond, Virginia 23230	(804) 289-3594	(804) 281-6005
Shailesh Shah	335 Madison Avenue Mezz4 New York, New York 10017	(212) 389-2575	(212) 839-2591
Grant Lineberry	335 Madison Avenue Mezz4 New York, New York 10017	(212) 389-2570	(212) 389-2591
Colin Burrell	335 Madison Avenue Mezz4 New York, New York 10017	(212) 389-2640	(212) 389-2590
<b>Company</b>			
Kathy Cassidy	201 High Ridge Road Stamford, Connecticut 06927	(203) 357-6199	(203) 585-1191

Brian Wenzel	201 High Ridge Road Stamford, Connecticut 06927	(203) 357-6774	(203) 316-7601
Alan Green	201 High Ridge Road Stamford, Connecticut 06927	(203) 961-5077	(203) 357-3490
Johan Fogelberg	201 High Ridge Road Stamford, Connecticut 06927	(203) 357-6072	(203) 357-4975
Robert Ceske	201 High Ridge Road Stamford, Connecticut 06927	(203) 602-8337	(203) 585-1361

E-1

General Electric Capital Corporation

Kathy Cassidy	201 High Ridge Road Stamford, Connecticut 06927	(203) 357-6199	(203) 585-1191
Brian Wenzel	201 High Ridge Road Stamford, Connecticut 06927	(203) 357-6774	(203) 316-7601
Alan Green	201 High Ridge Road Stamford, Connecticut 06927	(203) 961-5077	(203) 357-3490
Johan Fogelberg	201 High Ridge Road Stamford, Connecticut 06927	(203) 357-6072	(203) 357-4975
Robert Ceske	201 High Ridge Road Stamford, Connecticut 06927	(203) 602-8337	(203) 585-1361

E-2

**Exhibit F**

**Arbitration Procedures**

If Senior Management fails to reach agreement with respect to a Dispute Resolution within forty-five (45) days of a Submission and the Cure Period has not expired, either Party may submit the matter to be finally resolved by arbitration pursuant to the CPR Institute for Dispute Resolution (the “CPR”) Rules for Non-Administered Arbitration as then in effect (the “CPR Arbitration Rules”). The Parties consent to a single, consolidated arbitration for all known matters under dispute existing at the time of the arbitration and for which arbitration is permitted.

The neutral organization for purposes of the CPR Arbitration Rules will be the CPR. The arbitral tribunal shall be composed of three arbitrators, of whom each Party shall appoint one in accordance with the “screened” appointment procedure provided in Rule 5.4 of the CPR Arbitration Rules. The arbitration shall be conducted in New York City. Each Party shall be permitted to present its case, witnesses and evidence, if any, in the presence of the other Party. A written transcript of the proceedings shall be made and furnished to the Parties. The arbitrators shall determine the matter in dispute in accordance with the law of the State of New York, without giving effect to any conflict of law rules or other rules that might render such law inapplicable or unavailable, and shall apply this Agreement according to its terms, provided that the provisions relating to arbitration shall be governed by the Federal Arbitration Act, 9 U.S.C. §§ 1 et seq.

The Parties agree to be bound by any award or order resulting from any arbitration conducted in accordance with this provision and further agree that judgment on any award or order resulting from an arbitration conducted under this provision may be entered and enforced in any court having jurisdiction thereof.

Except as expressly permitted by this Agreement, no Party will commence or voluntarily participate in any court action or proceeding concerning a matter in dispute, except (i) for enforcement, (ii) to restrict or vacate an arbitral decision based on the grounds specified under applicable law, or (iii) for interim relief as provided in paragraph (e) below. For purposes of the foregoing, the parties hereto submit to the non-exclusive jurisdiction of the courts of the State of New York.

In addition to the authority otherwise conferred on the arbitral tribunal, the tribunal shall have the authority to make such orders for interim relief, including injunctive relief, as it may deem just and equitable.

Each Party will bear its own attorneys’ fees and costs incurred in connection with the resolution of any matter in dispute in accordance with this provision.

F-1

This LIABILITY AND PORTFOLIO MANAGEMENT AGREEMENT, dated as of January 1, 2004 (this "Agreement"), among FGIC CAPITAL MARKET SERVICES, INC., a Delaware corporation (the "Company"), GENWORTH FINANCIAL ASSET MANAGEMENT, LLC, a Virginia limited liability company (the "Manager") and GENERAL ELECTRIC CAPITAL CORPORATION, a Delaware corporation ("GE Capital," and together with the Company and the Manager, the "Parties").

WITNESSETH:

WHEREAS, the Manager is an investment adviser registered with the United States Securities and Exchange Commission that will be engaged by the Company to provide the services described herein; and

WHEREAS, the Manager and the Company wish to establish and define certain obligations set forth in Exhibit C and Exhibit D (the "Listed Obligations") that the Manager is required to undertake in connection with the services it will provide to the Company under this Agreement;

NOW, THEREFORE, in consideration of the mutual promises made herein and upon the terms and subject to the conditions set forth herein, the Parties hereby agree as follows:

ARTICLE I

Definitions

SECTION 1.01. Terms Defined in this Agreement. As used in this Agreement, the following capitalized terms have the following meanings:

"Accounts" shall have the meaning specified in Section 2.01(a).

"Affiliate" of a Person means a Person who, directly or indirectly through one or more intermediaries, controls or is controlled by, or is under common control with, such Person.

"Agreement" means this Liability and Portfolio Management Agreement.

"Assets" shall have the meaning specified in Section 2.01(a).

"Business Day" means a day other than Saturday, Sunday or a day on which banks in New York, New York are not open for the conduct of regular banking activities.

"Company" shall have the meaning specified in the preamble of this Agreement.

"Contract Value" shall have the meaning specified in Section 2.06.

"Contracts" means the investment agreements and similar contracts issued by the Company to trustees, municipalities and to other parties engaged in municipal finance transactions and other transactions.

"Cure Period" means (i) with respect to the Listed Obligations set forth in Exhibit C, the respective cure periods set forth therein, and (ii) with respect to Listed Obligations in Exhibit D or other obligations set forth in this Agreement that do not appear in Exhibit C, one hundred twenty (120) days during the initial term of this Agreement and sixty (60) days thereafter; in each case such Cure Period to commence upon receipt of notice by the Manager from any party to a Contract entitled to give notice of default, GE Capital or the Company.

"Dispute Resolution" shall have the meaning specified in Section 4.05(b).

"Failure Notice Recipients" shall have the meaning specified in Section 4.05(b) or such other recipients as are designated from time to time.

"Final Cure Period" shall have the meaning specified in Section 4.05(b).

"GE Capital" shall have the meaning specified in the preamble to this Agreement.

"Governmental Authority" means any court, tribunal, arbitrator, authority, agency, commission, official or other instrumentality of the United States or any federal, national, state, municipal, county, city or other political subdivision.

"Holdings" means FGIC Holdings, Inc., an indirect wholly-owned subsidiary of GE Capital.

"Impossibility" shall have the meaning specified in Section 4.05(b).

"Indemnified Party" shall have the meaning specified in Section 2.12.

"Listed Obligations" shall have the meaning specified in the second recital of this Agreement.

"Management Fee" shall have the meaning specified in Section 2.06.

"Manager" shall have the meaning specified in the preamble to this Agreement.

"Notice of Failure" shall have the meaning specified in Section 4.05(b).

"Operating Costs" shall have the meaning specified in Section 2.07(b).

"Operations, Procedures and Controls Manual" means the Operations, Procedures and Controls Manual of the Company dated as of July 2, 2003, as the same may be amended from time to time.

“Parties” shall have the meaning specified in the preamble to this Agreement.

“Person” means an individual, corporation, partnership, limited liability company, association, trust or any other entity or organization, including governmental or political subdivision or an agency or instrumentality thereof.

“Policy 5.0” means the policy which sets forth certain risk management guidelines that the Company is required to observe, as the same may be amended from time to time by the Company with the approval of GE Capital.

“Policy 6.0” means the policy which sets forth certain risk management parameters that the Company is required to observe, as the same may be amended from time to time by the Company with the approval of GE Capital.

“Portfolio” shall have the meaning specified in Section 2.01(a).

“Prior Transfer Pricing Amounts” shall have the meaning specified in Section 2.06.

“Remediation Plan” shall have the meaning specified in Section 4.05(b).

“Senior Management” shall have the meaning specified in Section 4.05(b).

“Submission” shall have the meaning specified in Section 4.05(b).

## ARTICLE II

### Engagement; Powers and Duties

#### SECTION 2.01. Engagement of Manager.

(a) The Company hereby retains the Manager:

(i) to advise the Company as to the investment of the proceeds of its issuance of Contracts which proceeds have been on-lent to Holdings (the “Assets”), including recommending specific investment and hedging thereof to the Company;

(ii) to administer the Assets maintained in an account or accounts established in the name of Holdings (the “Accounts”), each of which is identified (to the extent established by the effective date hereof) in Exhibit A, as the same may be amended from time to time, with such deposits thereto and withdrawals therefrom as are from time to time permitted by the Company;

(iii) for as long as the revocable power of attorney granted pursuant to Section 2.02 is in effect, to arrange the purchase and sale through registered broker-dealers of bonds, pass-through certificates, stocks, and other securities for deposit in the Accounts;

3

---

(iv) for as long as the revocable power of attorney granted pursuant to Section 2.02 is in effect, to arrange the purchase and sale and otherwise to effect transactions in hedge contracts relating to the Assets;

(v) to prepare reports and to perform valuation tests as specified in Exhibit D or as are required from time to time by the Company;

(vi) to advise the Company in the issuance of and to assist the Company in the preparation of (and, for so long as the revocable power of attorney granted pursuant to Section 2.02 is in effect, to execute and to deliver on behalf of the Company) investment orders and disposition orders in connection with the management of the Assets;

(vii) to take such action as is necessary and proper on behalf of the Company for the preservation of the Assets;

(viii) to advise the Company in the granting or effecting of and to assist the Company in the preparation of (and, for so long as the revocable power of attorney granted pursuant to Section 2.02 is in effect, to execute and to deliver on behalf of the Company) any consents, waivers, extensions or modifications in respect of any item of the Assets;

(ix) to designate persons who are registered representatives of a registered broker-dealer which is a member of the National Association of Securities Dealers to execute and deliver Contracts on behalf of the Company in their capacity as such pursuant to a power of attorney granted by the Company from time to time to registered representatives designated and notified to the Company by the Manager from time to time;

(x) to advise the Company in the delivery of and to assist the Company in the preparation of (and, for so long as the revocable power of attorney granted pursuant to Section 2.02 is in effect, to execute and to deliver on behalf of the Company) any instrument of transfer or release in respect of any item of the Assets;

(xi) to engage a registered broker-dealer which is a member of the National Association of Securities Dealers to assist the Company in connection with the offering, issuance and sale of Contracts and, in connection therewith, to make such other arrangements with such broker-dealer as may be necessary or advisable to ensure that such broker-dealer supervises its registered representatives who will effect such transactions and takes responsibility for such offering, issuance and sale; and

(xii) to take any other action deemed necessary or advisable to execute and deliver Contracts on behalf of the Company.

The Manager shall administer the Assets in the Accounts (all of such Assets together, the “Portfolio”) in accordance with the terms and conditions hereof and shall otherwise observe in all material respects the requirements of the Operations, Procedures and Controls Manual, Policy 5.0 and Policy 6.0, this Agreement and all other documents,

4

---

policies, laws and regulations applicable to the Company from time to time. The Company shall provide copies of the Operations, Procedures and Controls Manual, Policy 5.0 and Policy 6.0, to the Manager no later than the time that this Agreement is entered into and shall provide copies of all amendments, supplements and revisions to such documents as soon as they are available to the Company.

(b) Performance. The Parties hereby agree that the Manager shall perform the specific Listed Obligations during the term of this Agreement and, subject to Section 2.10, such other functions as are set forth in this Agreement or as are generally required to operate the business of the Company in accordance with applicable laws,

regulations, documents and Company policy. The Manager acknowledges that it will take all reasonable steps to continue to conduct the business of the Company in a manner substantially similar to that in which it had been conducted prior to the Parties' entry into this Agreement and in a manner reasonably satisfactory to the Company.

SECTION 2.02. Power of Attorney. The Company hereby provides the Manager with a revocable power of attorney with full power and authority:

- (i) to evaluate and appraise the Portfolio;
- (ii) to arrange the purchase and sale through registered broker-dealers of bonds, pass-through certificates, stocks, and other securities in connection with making investments for the Portfolio;
- (iii) to arrange the purchase and sale of and otherwise to effect transactions in hedge contracts, as directed by GE Capital, in connection with making investments for the Portfolio through registered broker-dealers;
- (iv) to execute and to deliver on behalf of the Company any investment orders and disposition orders as may be required from time to time in connection with the management of the Portfolio;
- (v) to execute and to deliver on behalf of the Company any consents, waivers, extensions, or modifications in respect of any item of the Assets;
- (vi) to execute and to deliver on behalf of the Company any instrument of transfer or release in respect of any item of the Assets;
- (vii) to engage a broker-dealer acceptable to the Company to assist the Company in the origination, issuance and sale of Contracts in accordance with all applicable securities laws and regulations; and
- (viii) subject to the limitations set forth in the Operations, Procedures and Controls Manual, Policy 5.0 and Policy 6.0, to take any other action, including executing agreements and any other documents on behalf of the Company that the Manager deems necessary or advisable to purchase, sell or otherwise effect investment transactions relating to the Portfolio.

5

---

All investments made and transactions entered into by the Manager on behalf of the Company shall be entered into in the name of the Company. All actions contemplated above shall be performed in accordance with applicable laws, regulations, documents and applicable Company policy. The Manager shall not be under an obligation to keep the Portfolio fully invested if, in its sole discretion, it shall determine that market and/or economic conditions make it imprudent or disadvantageous to do so at any time or that funds should be made available for distributions and other payments pursuant to the terms of a Contract. The Company represents that it has the authority to make the appointment set forth in this paragraph. In the event the Manager fails to perform a Listed Obligation and this Agreement is terminated pursuant to Section 4.05(a) or (b), or if this Agreement is terminated pursuant to Sections 4.05(c) or (d), this power of attorney may be revoked by the Company by written notice to the Manager.

SECTION 2.03. Valuation. The Manager shall value the Portfolio from time to time in order to prepare such reports relating to the Assets as may reasonably be requested by the Company.

SECTION 2.04. Reports. As more particularly specified in Exhibit C and Exhibit D, the Manager shall:

- (a) prepare entries for accounts in, together with applicable schedules and exhibits for, financial statements that relate to the origination, issuance and sale of Contracts by the Company;
- (b) timely prepare and provide to the Company and GE Capital underlying data for accounting entries, schedules, exhibits and reports as the Company or GE Capital reasonably requests or is required to obtain by applicable laws, regulations or accounting rules;
- (c) prepare such other reports as GE Capital and the Company may reasonably agree upon from time to time; and
- (d) notify the Company and GE Capital immediately upon learning of any material default or breach of the Listed Obligations.

SECTION 2.05. Confidential Relationships. All information and recommendations furnished by the Manager to the Company shall be treated by the Company as confidential. The Manager shall, in turn, treat as confidential all information concerning the affairs of the Company. Nothing in this Section 2.05 shall be deemed to preclude any such information or recommendations from being disclosed by any Party to such Party's Affiliates or to the directors, officers, employees, representatives, agents or advisers of such Affiliates, or pursuant to applicable law, regulation or court order; provided, that any such recipients are advised of the confidential nature of such information or recommendations.

SECTION 2.06. Fees. GE Capital, on behalf of the Company, hereby agrees to pay to the Manager quarterly in arrears a fee (the Management Fee) at an annual rate of ten (10) basis points (0.10%) multiplied by the book value of Contracts

6

---

issued by the Company after January 1, 2003 (the "Contract Value"). For the avoidance of doubt, the Management Fee shall not reduce or otherwise alter GE Capital's obligation to make certain payments to the Manager, calculated in accordance with the formula set forth on Exhibit G, with respect to transfer pricing to be paid in respect of Contracts issued prior to January 1, 2003 ("Prior Transfer Pricing Amounts"), which obligation shall remain in full force and effect in respect of such Contracts. The Manager shall, on a date prior to that on which a Prior Transfer Pricing Amount is due and payable to the Manager, provide the Company and GE Capital with a list of all Contracts to which the Prior Transfer Pricing Amounts apply, a form of which list is attached as Exhibit G. As of the effective date of this Agreement, all Prior Transfer Pricing Amounts shall be paid to the Manager quarterly in arrears.

SECTION 2.07. Expenses Reimbursed.

(a) GE Capital, on behalf of the Company, shall reimburse the Manager for all out-of-pocket expenses incurred and approved pursuant to Section 2.09(e) in connection with the performance of its duties hereunder, except for any expenses arising out of the Manager's willful misfeasance, bad faith, gross negligence in the performance of or reckless disregard of its obligations and duties hereunder.

(b) GE Capital, on behalf of the Company, shall reimburse the Manager for all appropriate Operating Costs of the Company. Such reimbursement shall be made, upon receipt by the Company from the Manager of a schedule detailing Operating Costs (substantially in the form of Exhibit B hereof), within thirty (30) days following the end of each quarter. For the purposes hereof, "Operating Costs" means all costs incurred by the Manager in connection with the performance of its obligations under this Agreement that have been submitted and approved in writing as part of the annual budget approval process described in Section 2.09(e). For the avoidance of doubt, it is hereby agreed that certain expenses will not be paid by the Manager and do not constitute reimbursable Operating Costs. Such expenses, which are directly attributable to the Company, include fees payable to: (i) external legal counsel engaged by the Company for services rendered thereto and not in connection with duties of the

Manager, which are unrelated to the management services it renders to the Company, (ii) certain third-party providers of accounting services to the Company, (iii) providers of credit research services required by the Company and (iv) any provider of goods or services for costs incurred in connection with requirements imposed by regulatory authorities, rating agencies, or any applicable law, rule, regulation, administrative interpretation, ordinance, code issued by a Governmental Authority or regulatory body, or any order, writ, injunction, directive, judgment or decree of a court of competent jurisdiction; each such expense shall be paid by the Company.

SECTION 2.08. Execution of Securities Transactions.

(a) In connection with the offering and sale of Contracts, the Manager shall engage a registered broker-dealer approved by the Company that provides services with respect to the origination, issuance and sale of Contracts that the Manager believes

7

---

to be of value. The Company shall pay all costs associated with the retention of such broker-dealer.

(b) Except as otherwise specifically directed by the Company, the Manager shall have complete discretion to select any registered broker-dealer in all securities transactions affecting the Portfolio not described in Section 2.08(a). The Manager is expressly authorized to select such brokers-dealers who provide brokerage and research services that the Manager believes to be of value. The Manager is expressly authorized to pay from the Assets in the Portfolio commissions on such transactions in amounts that the Manager determines in good faith to be reasonable in relation to the value of such brokerage and research services, viewed in terms either of the particular transaction or the overall responsibilities of the Manager with respect to the Portfolio.

SECTION 2.09. Administrative Responsibilities. The Manager shall have the following administrative responsibilities:

(a) The Manager shall submit the budget for reimbursable Operating Costs to the Company and GE Capital by no later than January 31 of each year and such budget shall be approved by the Manager of Finance of Corporate Treasury and Global Funding Operations (or such other representative as shall be designated from time to time in a notice to the Manager executed by the Company and GE Capital) by February 15 of such year. Operating Costs incurred in excess of the aggregate amounts approved in the annual budget must be separately approved by the Company and GE Capital in order to be considered for reimbursement.

(b) Custody of the Assets comprising the Portfolio will be maintained in the Accounts. The Manager shall not have custody of any of the Assets in the Portfolio.

(c) The Manager shall keep such books and records relating to all transactions that it effects pursuant to this Agreement, including without limitation all books and records necessary for preparing the reports required by Section 2.04.

(d) For the avoidance of doubt, the Manager shall provide no services to the Company in respect of tax planning or tax compliance of any kind.

(e) The Manager shall submit presentations relating to the offering of Contracts to the Company and GE Capital for approval prior to external use.

(f) The Manager shall maintain its status as an "investment adviser" under the Investment Advisers Act of 1940, as amended, and shall follow all applicable laws and regulations relating to its status as such and to its performance hereunder, including all applicable laws and regulations relating to bidding for Contracts.

SECTION 2.10. Other Duties as Reasonably Requested. The Manager shall also perform such other duties or shall modify existing duties as the Company may reasonably request or that the Manager shall recommend to the Company from time to time relating to the management of a business involved in the issuance of guaranteed

8

---

investment contracts and similar debt obligations issued by providers rated "AAA"/"Aaa" and the management of the proceeds of the issuance of such contracts and obligations. If any additional or modified duties are required of Manager under this Agreement, Manager shall have the reasonable time and opportunity to procure such additional resources as may, in Manager's good faith judgment, be required to perform such duties. Manager also agrees that it will cease to perform the requirements of certain obligations specified hereunder if the Company so directs in writing. Any such changes or additions shall be deemed for all purposes to be amendments or supplements to this Agreement. The Company shall pay such costs as have been mutually agreed to by the Parties and as may from time to time be required to enable the Manager to perform any additional or changed Listed Obligations contemplated herein and other obligations not listed in this Agreement for which additional resources are required or additional costs are reasonably incurred by the Manager.

SECTION 2.11. Limitation of Liability. Neither the Manager nor any of its Affiliates nor any of their respective directors, officers, or employees shall be liable to the Company for any error of judgment or mistake of law or for any loss arising out of any investment or any other commitment of funds on behalf of the Company or Holdings or for any act or omission in the administration of the Portfolio except for willful misfeasance, bad faith, gross negligence in the performance of or reckless disregard of its obligations and duties hereunder, other than as may be provided under applicable law.

SECTION 2.12. Indemnification. (a) The Company shall (i) indemnify and hold harmless the Manager and any Affiliate of the Manager and each of their respective directors, officers, employees and agents (each, an "Indemnified Party") from and against all losses, claims, damages, expenses or liabilities to which such Indemnified Party may become subject (except in respect of the broker-dealer engaged by the Manager in respect of the placement of Contracts, which shall be the sole liability of the Manager), insofar as such losses, claims, damages, expenses or liabilities (or actions, suits or proceedings including any inquiry or investigation or claims in respect thereof) arise out of, in any way relate to, or result from the transactions contemplated by, this Agreement, and (ii) reimburse each of the Indemnified Parties upon its demand for any reasonable legal or other expenses incurred in connection with investigating, preparing to defend or defending any such loss, claim, damage, liability, action or claim; provided, however, that none of the Indemnified Parties shall have the right to be so indemnified hereunder for losses, claims, damages, expenses or liabilities to the extent resulting from its own negligence or willful misconduct or for losses, claims, damages, expenses or liabilities that it is required to pay to any broker-dealer that it has engaged in connection with the Contracts or other liabilities. If any action is brought against an Indemnified Party indemnified or intended to be indemnified pursuant to this Section 2.12, the Company shall, if requested by such Indemnified Party, resist and defend such action, suit or proceeding or cause the same to be resisted and defended by counsel reasonably satisfactory to such Indemnified Party, but shall not be empowered to compromise or settle such action, suit or proceeding unless such Indemnified Party has been fully indemnified for any loss, claim, damage, expense or liability it thereby suffers. Each Indemnified Party shall, unless the Indemnified Party has made the request described in the preceding sentence and such request has been complied with, have the right to

9

---

employ its own counsel to investigate and control the defense of any matter covered by such indemnity and the reasonable fees and expenses of such counsel shall be at the expense of the Company.

## Representations and Warranties

SECTION 3.01. Valid Existence; Authorization; Enforceability. Each of the Parties represents and warrant to the other as follows:

(a) such Party is a company duly organized, validly existing and in good standing under the laws of the jurisdiction of its organization and has all requisite power, legal right and authority to execute and deliver this Agreement and all other documents to be executed and delivered by such Party in connection herewith and to perform its obligations hereunder and thereunder; and

(b) this Agreement and all the documents to be executed and delivered by such Party in connection herewith and therewith has been duly authorized by all necessary actions on the part of such Party.

## ARTICLE IV

### Miscellaneous Provisions

SECTION 4.01. No Assignment Without Consent. This Agreement, and the obligations and rights arising under this Agreement, may not be assigned or otherwise transferred by any Party (including any assignment or transfer in connection with any Person succeeding to any part of the business of any Party) without the prior written consent of the other Parties.

SECTION 4.02. Counterparts. This Agreement may be executed in one or more counterparts and, as so executed, shall constitute one agreement binding upon the Parties.

SECTION 4.03. No Third Party Beneficiaries. Nothing expressed or implied in this Agreement is intended or shall be construed to confer upon any person (other than the Parties and their permitted assigns), any right, remedy or claim by reason of this Agreement or any term hereof, and all terms contained herein shall be for the sole and exclusive benefit of the Parties and their successors and permitted assigns.

SECTION 4.04. Interpretation. The headings of the Articles and Sections hereof are for convenience of reference only and shall not affect the meaning or construction of any provision hereof.

10

---

SECTION 4.05. Term; Termination.

(a) The Manager's appointment hereunder shall continue in effect for an initial term commencing on the date hereof and ending on December 31, 2006, with extensions for additional one (1) year periods commencing automatically upon each anniversary thereof, unless the Manager notifies the Company and GE Capital, or the Company and GE Capital notify the Manager in writing at least ninety (90) days before such anniversary that such extension shall not be effective.

(b) If the Manager fails to perform any of its obligations set forth in this Agreement, Exhibit C or Exhibit D, the Manager (or if the failure is first discovered by the Company, then the Company) shall give prompt written notice (such notice, a "Notice of Failure") to the persons identified in Exhibit E (the "Failure Notice Recipients") specifying the nature of the failure. In the event such Notice of Failure is given, then either the Manager or the Company may elect to submit the matter for review (a "Submission") and resolution ("Dispute Resolution"), which may include the establishment of a plan of remediation (a "Remediation Plan") to (i) with respect to the Manager, the Business Leader of the Retirement Income and Investment Segment of Genworth Financial Inc. (or such person or persons as such Business Leader may designate) and (ii) with respect to the Company, the Senior Vice President — Corporate Treasury and Global Funding Operation of GE Capital (or such person or persons as such Senior Vice President may designate) ((i) and (ii) together, "Senior Management"). The Manager and the Company agree (x) to cooperate in good faith and in a reasonable manner to reach an agreement with respect to any Remediation Plan; (y) to be bound by the results of any such Dispute Resolution agreed to by Senior Management including any Remediation Plan (the timing and content of which shall be at the sole discretion of Senior Management) and (z) that the Manager will implement any such Remediation Plan within the period mandated by Senior Management (the "Final Cure Period"). The result of any such Dispute Resolution shall be in writing signed by Senior Management, shall be deemed part of this Agreement and, with respect to the failure involved, shall supersede any conflicting or different terms of this Agreement.

If Senior Management fails to reach an agreement with respect to a Dispute Resolution and the Cure Period has not expired, the matter in dispute shall be resolved solely and exclusively in accordance with the arbitration procedures set forth in Exhibit E.

If (i) Senior Management or an arbitral tribunal described in Exhibit F fails to reach agreement with respect to a Dispute Resolution and the Cure Period has expired or (ii) the Manager fails to correct the failure by the end of the applicable Final Cure Period, then this Agreement may, subject to Section 4.05(e), be terminated by the Company upon two (2) Business Days' prior written notice to the Manager and each Failure Notice Recipient specifying the basis for and the effective date of the termination.

Notwithstanding the foregoing, the payment obligations of the Company during the initial term of this Agreement shall not be terminated if any such failure and the continuation thereof are caused by Impossibility. For the purposes hereof,

11

---

"Impossibility" means loss or malfunction of electric power, transportation or communication services; general inability to obtain or retain labor, material, equipment or transportation, or a delay in mails or services; the Company's, GE Capital's or any of their Affiliates' (i) failure to take an action on which the Manager's performance of an obligation or any Listed Obligation depends or (ii) taking an action which renders the Manager's performance of an obligation or any Listed Obligation impossible; governmental or exchange action, statute, ordinance, ruling, regulation, administrative interpretation or directive; acts of terror, vandalism, explosions, tornados, acts of God or public enemy, acts of any civil or military authority, revolutions, insurrections, strike, emergency, riots or civil commotions, freezes, fires, floods, embargoes, wars, sabotage, explosions or other unforeseen or unexpected occurrences, which unforeseen or unexpected occurrences render the performance of any obligations by the Manager impossible. In the event of any such occurrence, the Manager shall use all reasonable efforts to remediate the disruption and resume its performance of the obligations.

(c) The Company shall have the right to terminate this Agreement at an earlier time than that specified in Section 4.05(a) in the event of continuing non-performance due to Impossibility of any obligation hereunder beyond the applicable Cure Period or Final Cure Period upon thirty (30) Business Days' prior written notice to the Manager.

(d) The Manager may resign upon not less than ninety (90) days' prior written notice to the Company.

(e) Notwithstanding any provision to the contrary, including the expiration of any term of this Agreement, so long as the Portfolio is still outstanding, this Agreement shall remain in full force and effect and no termination or resignation of the Manager shall be effective until the Company has entered into an agreement with a successor manager. Upon receiving a notice of resignation from the Manager, the Company shall use its best efforts to enter into such an agreement unless it elects to terminate this Agreement as provided in Section 4.05(c) above. Except as set forth in Exhibit F, nothing in this Agreement shall be deemed a waiver of any Party's rights to pursue remedies at law or in equity, which shall be available in accordance with applicable law in addition to any remedies provided for in this Agreement.



SECTION 4.06. Independent Contractor. The Manager is being engaged pursuant to this Agreement as an independent contractor and the Parties expressly disclaim any intention to enter into a joint venture, partnership, or any other form of association pursuant to this Agreement.

SECTION 4.07. GOVERNING LAW. THIS AGREEMENT SHALL BE GOVERNED BY, AND CONSTRUED IN ACCORDANCE WITH, THE INTERNAL LAWS OF THE STATE OF NEW YORK, WITHOUT REGARD TO THE RULES OF CONFLICTS OF LAWS OF THE STATE OF NEW YORK OR ANY OTHER JURISDICTION.

12

---

SECTION 4.08. Notices. All notices, instructions, and advice with respect to any transactions or other matters contemplated by this Agreement shall be deemed duly given only when actually received at such Party's principal place of business as set forth below. Return receipt or courier record of delivery shall be deemed conclusive evidence of receipt. Notices may be made by fax or other electronic means shall be deemed given upon electronic evidence of receipt at applicable recipient's fax or computer station. A copy of all notices given shall be provided to GE Capital.

If to the Manager:

Genworth Financial Asset Management, LLC  
6620 West Broad Street  
Richmond, Virginia 23230  
Attention: Pamela Schutz  
Phone: (804) 291-6533  
Fax: (804) 281-6165  
E-mail: pamela.schutz@ge.com

with a copy to:

335 Madison Avenue  
Mezz4  
New York, New York 10017  
Attention: Shailesh Shah  
Phone: (212) 389-2575  
Fax: (212) 389-2591  
E-mail: shailesh.shah@ge.com

If to the Company:

FGIC Capital Market Services, Inc.  
335 Madison Avenue  
Mezz4  
New York, New York 10017  
Attention: Shailesh Shah  
Phone: (212) 389-2575  
Fax: (212) 389-2591  
E-mail: shailesh.shah@ge.com

If to General Electric Capital Corporation:

General Electric Capital Corporation  
260 Long Ridge Road  
Stamford, Connecticut 06927  
Attention: Senior Vice President — Corporate  
Treasury and Global Funding Corporation  
Phone: (203) 961-5077

13

---

Fax: (203) 357-3490  
E-mail: alan.green1@ge.com

SECTION 4.09. Entire Agreement; All Amendments in Writing. This Agreement embodies the entire understanding of the Parties concerning the subject matter hereof and supersedes any and all other previous agreements, written or oral, concerning the same subject matter. This Agreement cannot be amended except by written agreement of the Parties.

SECTION 4.10. Waiver. No waiver of any provision of this Agreement nor consent to any departure therefrom shall in any event be effective unless the same shall be in writing and signed by the Party from whom such waiver or consent is sought, and then such waiver or consent shall be effective only in the specific instance and for the specific purpose for which given.

SECTION 4.11. Further Assurances. Each Party hereby agrees to execute and deliver such additional documents, instruments or agreements as may be reasonably necessary and appropriate to effectuate the purposes of this Agreement.

SECTION 4.12. Successors and Assigns. This Agreement shall be binding upon the Parties and their respective successors and assigns.

SECTION 4.13. Severability. Any term or provision of this Agreement which is invalid or unenforceable in any jurisdiction shall, as to that jurisdiction, be ineffective to the extent of such invalidity or unenforceability without rendering invalid or unenforceable the remaining terms and provisions of this Agreement or affecting the validity or enforceability of any of the terms or provisions of this Agreement in any other jurisdiction. If any provision of this Agreement is so broad as to be unenforceable, the provision shall be interpreted to be only so broad as is enforceable.

SECTION 4.14. Limited Recourse. The obligations of the Company under this Agreement are solely the obligations of the Company. No recourse shall be had for any obligation or claim arising out of or based upon this Agreement against any, manager, officer, organizer, agent or employee of the Company.

IN WITNESS WHEREOF, the Parties have executed this Agreement as of the date first above written.

FGIC CAPITAL MARKET SERVICES, INC.

By: \_\_\_\_\_  
 Name: \_\_\_\_\_  
 Title: \_\_\_\_\_

GENWORTH FINANCIAL ASSET  
 MANAGEMENT, LLC

By: \_\_\_\_\_  
 Name: \_\_\_\_\_  
 Title: \_\_\_\_\_

GENERAL ELECTRIC CAPITAL  
 CORPORATION

By: \_\_\_\_\_  
 Name: \_\_\_\_\_  
 Title: \_\_\_\_\_

[LIABILITY AND PORTFOLIO MANAGEMENT  
 AGREEMENT (FGIC)]

**Exhibit A**

**Accounts Comprising the Portfolio**

Account	Custodian Bank	Account Number
DDA Account	Deutsche Bank Trust Company Americas, New York, NY	50208678
Custody Account	Deutsche Bank Trust Company Americas, New York, NY	097722

A-1

**Exhibit B**

**Form of Schedule of Operating Costs**

Operating Costs for the first calendar year, commencing on January 1, 2004, shall be \$[ ] and thereafter shall be equal to [ ]% of the Operating Costs of the Manager, subject to the Company's approval, as provided in Section 2.07(b) and shall consist of the following (allocated [ ]% with respect to the Company):

CMS	2004				2004
	1Q	2Q	3Q	4Q	TY
<b>Comp &amp; Benefits:</b>					
Salaries	\$	\$	\$	\$	\$
Savings Plan 401k					
Bonuses					
Employee Insurance					
Payroll Taxes					
<b>Total Comp &amp; Benefits</b>					

**Purchase Base:**

Travel & Living Expenses
Business Meetings
Education
Employment Fees
Tuition Reimbursement
Relocation Maintenance
Dues & Associations

Consulting Fees					
Outside Services					
Rent/ Utilities					
Legal Fees					
Audit Fees					
Recreation					
Telephone/Cellular					
Printing & Office Supplies					
Postage\Courier Service					
Subscriptions					
Information Services					
Advertising / Marketing					
Temporary Help					
Equipment Maintenance					
Hardware Expense					
Software Expense					
Fiscal Agent Fees					
Investment Fees					
Organizational Misc					
<b>Total Purchase Base</b>					
<b>Total Controllable</b>					

B-1

CMS	2004				2004
	1Q	2Q	3Q	4Q	TY
<b>Other:</b>					
Property Insurance					
Corporate Assessments					
<b>Total Other</b>					
<b>SG&amp;A Expenses</b>					
Rating Agency Fee					
Loss On Other Assets					
Insurance And Licensing					
State And Local Taxes					
Goodwill Amortization					
Change in DAC					
Ceding Commission					
<b>Non-SG&amp;A Expenses</b>					
<b>Op &amp; Admin Expense</b>					
Depreciation					
<b>Total Direct Expenses</b>					
Broker Fees Amortization					
<b>Total Expenses (including Broker Fees)</b>	<b>\$</b>	<b>\$</b>	<b>\$</b>	<b>\$</b>	<b>\$</b>

B-2

**Exhibit C**

**Priority Manager Functions**

Listed Obligation	Cure Period
<p><u>Payments</u></p> <p>Manager shall cause payments to be made as required under any Contracts or other agreements to which the Company is a party.</p>	<p>Five (5) Business Days from the date a notice of nonpayment received by Manager under the applicable Contract or agreement (or such shorter period as exists prior to such nonpayment being an actionable default thereunder); <u>provided, however</u>, that if the Manager or the Company gives notice to the other party requesting Dispute Resolution within one (1) Business Day of the notice, the cure period hereunder shall be extended to three (3) Business Days from the date the notice of nonpayment is received (it being understood that in no event shall this provision supersede the contractual payment obligations in the respective Contract or agreement).</p>

Risk Matters

Manager shall comply with all requirements of GE Capital's Policy 5.0 and 6.0 relating to the Company and related "strike zones," as such policies and strike zones are amended from time to time; provided, that in the event that a trigger has been tripped under Policy 6.0 by virtue of a change in the market or pursuant to the action of a rating agency, GE Capital shall provide direction on remediation on a case-by-case basis if not otherwise provided for in Policy 6.0 and, if the Manager takes the appropriate corrective action (whether as prescribed by Policy 6.0 or as directed by GE Capital), no failure to perform an obligation under this Agreement shall be deemed to have occurred.

Five (5) Business Days.

#### Financial Reporting

Manager shall comply with Section 2.04 hereof and the Listed Obligations and shall prepare all reports relating to the Company as are necessary or desirable for compliance with the Sarbanes-Oxley Act of 2002 and any other financial reporting requirements of the Company under applicable law and external regulation.

Thirty (30) days or such shorter or longer period as is specified by the applicable accounting firm or regulatory body to allow for compliance with the applicable regulatory or disclosure requirement.

C-1

#### Listed Obligation

#### Cure Period

#### Legal Compliance

Manager shall comply with the requirements of contracts to which it is a party, and all applicable laws and regulations.

Thirty (30) days or such other period as is specified in the applicable agreement or regulation or as is directed by the applicable regulatory body.

C-2

### Exhibit D

#### **Listed Obligations**

#### Compliance/Legal

- Manager will maintain the corporate and limited liability company minutebooks and records of the Company, and take all actions required to maintain the Company's valid existence and good standing in the jurisdictions in which it is organized or qualified.
- Manager will comply with applicable law in respect of the Company's issuance of Contracts, including with respect to rules promulgated under federal securities laws that restrict certain forms of advertising and solicitation.
- Manager will consult with and obtain approval from the Company in connection with proposed material modifications to the terms or the form of Contracts.
- Manager will maintain its status as an "investment adviser" under the Investment Advisers Act of 1940, as amended, and will take all reasonable steps to comply with all applicable laws and regulations relating to its status as such.
- Manager will cause its legal staff to draft and prepare all Contracts and other contracts entered into by the Company. The in-house counsel of Manager may, to the extent required, engage outside counsel in connection with the preparation of such contracts if such engagement is approved verbally or in writing by the General Counsel — Treasury Operation of GE Capital and otherwise approved under Section 2.09. Nothing in this Agreement will preclude Manager from engaging its own outside counsel for any purpose it deems necessary or advisable, and Manager need not obtain any separate approval therefore.
- Manager will comply with all applicable laws and all applicable policies and procedures as the same may be provided to Manager by the Company, including but not limited to the USA PATRIOT Act of 2001 and anti-money laundering policies and laws.
- Manager will take all reasonable actions required to assist the Company or GE Capital in connection with changes to the corporate structure of the Company.
- Manager will take all reasonable steps to provide prompt responses to GE Capital in connection with requests from regulatory or other governmental authorities for documentation or data relating to the operation of the Company.
- Manager will comply with all applicable laws, regulations, policies, management procedures and other requirements of the Company, GE Capital and the Manager's Affiliates, including but not limited to the GE Capital Information

D-1

Security Procedure and, to the extent applicable, the policies contained in "Integrity: The Spirit & the Letter of Our Commitment."

#### Liability/Contract Bidding Process

- Manager shall ensure that transactions in Contracts are effected in accordance with the following general procedure: (i) a registered representative of a broker-dealer (each, a "GIC Salesperson") shall receive bid specifications ("Bid Specs") provided by prospective Contract customers or their agents ("Customers"); (ii) the GIC Salesperson shall analyze the Bid Specs and respond to Customers, indicating to such Customers, where appropriate, the requirements to maintain the Company's

exemption from registration under the Investment Company Act of 1940, as amended; (iii) the GIC Salesperson shall submit all Bid Specs for review and comment to the designated member of the Manager's legal staff and will note on any bid acceptance form that is delivered to the Customer all appropriate comments received from the legal staff; (iv) the GIC Salesperson shall price transactions in which the Company has an interest in bidding and communicate such pricing to the applicable Customer; and (v) the Manager's legal staff shall provide counsel to the GIC Salesperson in connection with the preparation, negotiation and closing of all Contracts for transactions that the Company wins.

#### Financial Controls

- Manager will periodically deliver the following financial reports:  
Monthly:
  - Transfer Pricing
  - Income Sheet
  - Book Value
  - Accrued InterestQuarterly:
  - Debt Roll-Forward (3 days following the GE fiscal close period)
  - Cash Reconciliation (3 days following the GE fiscal close period)
- Manager will e-mail net withdrawals and deposits to GE Treasury Cash Desk by 10:00 a.m. on each Business Day.
- Manager will e-mail projected settlements on newly issued Contracts to GE Treasury Cash Desk by 4:00 p.m. one (1) Business Day prior to closing.

D-2

---

- Manager will perform its accounting responsibilities in compliance with GE's internal accounting policies and U.S. GAAP.
- Manager will maintain accounting policies currently in place and all changes to accounting policies must be approved in advance by GE Capital. For new accounting standards, GE Capital will provide Manager with the accounting policy to be adopted by the Company.
- Manager will reconcile all general ledger accounts in accordance with GE's account reconciliation criteria. Manager will provide a quarterly dashboard of account reconciliations and open items (in an agreed-upon format) on dates to be provided to Manager.
- Manager is responsible for establishing and maintaining a system of internal controls adequate to ensure that the financial statements and related disclosures and schedules fairly present the financial condition of the Company.
- Manager will provide the Company with financial projections in accordance with GE Capital's SI, SII and OP process. GE Capital will provide the Manager with SI, SII and OP timing and assumptions where needed to make such forecasts.
- Manager will conduct annual reviews in compliance with applicable provisions of the Sarbanes-Oxley Act of 2002, in a manner acceptable to GE Capital.

#### Risk

- Manager will comply with all applicable terms set forth in Policy 5.0 and Policy 6.0 and all "strike zones" defined by GE Capital with respect to assets and liabilities (as each may be amended from time to time by GE Capital).
- Manager will provide other available reports required from time to time by GE Capital as they are requested.
- Manager will participate, on a monthly and quarterly basis, in in-force reviews with Genworth senior management and GE Capital senior management.
- Manager will from time to time provide GE Capital with data feeds relating to the Portfolio, the content, format and timing of the delivery of which feeds will be agreed upon by Manager and GE Capital.
- Manager will from time to time provide GE Capital with such available additional risk analyses as GE Capital may request, including but not limited to, stress tests and value at risk analyses. In each case, the content, format and timing of the delivery of such analyses will be agreed upon, prior to delivery, by GE Capital and Manager.

D-3

---

- Manager will comply with all applicable requirements relating to the Company's maintenance of the "AAA"/"Aaa" ratings assigned thereto by the applicable rating agencies.

#### Customer

- Manager will ensure delivery by mail or e-mail, or will make available on the Company's website, to the Company's customers in accordance with such customers' respective Contracts, Customer Statements in respect of customers' investments with the Company.
- Manager will ensure the timely remittance of payments required under each Contract or other agreement of the Company.
- When requested by the Company and GE Capital, Manager will deliver to the Company and GE Capital customer service metrics (e.g., call volume by customer complaint type by date) and deal closing customer survey results (if and to the extent the same is provided by customers).

### Information Technology

- Manager will maintain the current systems environment to fully support the business requirements and the services to be performed under this Agreement for the Company.

### Continuous Service (Disaster Recovery)

A disaster recovery site shall be maintained as follows:

- Backup copies of critical servers shall be maintained at an off-premises Disaster Recovery Site (locations to be determined from time to time by the Parties hereto). The critical servers are as follows: Principia PAS server, Oracle Data Warehouse Server, File Server, Oracle GL Server, and FileNET CM Server. In the event of a major disaster where access to production servers and 335 Madison Avenue's assets (or those of a successor location from which the Company's business is operated) is lost, service will be restored on the following schedule: PAS and Oracle Data warehouse systems will be within twenty-four (24) hours. GL and FileNET server will be available within forty-eight (48) hours. The Parties will work with GE Capital Treasury on a best effort basis to establish and implement an adequate Disaster Recovery plan.

D-4

---

- Software refreshes to synchronize the DR systems with the production systems shall be done within twenty-four (24) hours of the update of the production system to coincide with production system updates.
- Backups of the production PAS database shall be copied to the DR PAS server nightly.

### Data Management (Backups and Retention)

- Full data backups are performed daily on all production and Quality Assurance systems.
- Full data backups of all Network files are performed daily.
- Backup tapes shall be stored offsite at Iron Mountain. Tapes are picked up by 10:30 a.m. daily.
- An authorized list of personnel may recall tapes from Iron Mountain (an agreement exists to deliver backup tapes to any location, including the home of IT personnel).
- Tapes shall be cycled on a rolling eight (8) week rotation. All Financial close and Month End tapes shall be marked permanent and retained indefinitely.

### Change Management: Notification and Approval Process on Changes to IT Infrastructure and Application Software

- GE Capital Treasury shall have the right to approve the Company's Change Management Process.
- All change requests shall be reported to GE Capital Treasury on a weekly basis.
- Emergency changes to the IT Environment shall be reported to GE Capital Treasury as they occur.
- In the event of a major System Failure GE Capital Treasury shall be notified and required to approve required changes.

D-5

---

### Performance and Capacity Planning Reporting and Reviews

- In general, monthly business reports shall be available by 9:00 a.m. the last Business Day of the month. The IT team will communicate all exceptions by 8:30 a.m. on the day such exceptions occur. The communication will include the anticipated delivery time. The following performance tracking processes exist:
  - Monthly report of nightly batch completion times.
  - Monthly report of nightly batch completion times.
  - Monthly report of exceptions and violations of the 9:00 a.m. report delivery times and cures employed.
  - Monthly report on system loading and projected performance bottlenecks and issues and resolutions.
  - Monthly report of license denials.

### Personnel

- Manager will maintain a staff of qualified employees sufficient to support the business requirements of the Company and to perform the services required under this Agreement.

### Other Obligations

- Manager will comply in all material respects with all other obligations provided under this Agreement.

D-6

---

<u>Recipient</u>	<u>Address</u>	<u>Telephone</u>	<u>Facsimile</u>
<u>Manager</u>			
Pamela Schutz	6610 West Broad Street Richmond, Virginia 23230	(804) 281-6533	(804) 281-6165
Kelly Groh	6610 West Broad Street Richmond, Virginia 23230	(804) 281-6321	(804) 281-6310
Toni Ness	6610 West Broad Street Richmond, Virginia 23230	(804) 289-3594	(804) 281-6005
Shailesh Shah	335 Madison Avenue Mezz4 New York, New York 10017	(212) 389-2575	(212) 839-2591
Grant Lineberry	335 Madison Avenue Mezz4 New York, New York 10017	(212) 389-2570	(212) 389-2591
Colin Burrell	335 Madison Avenue Mezz4 New York, New York 10017	(212) 389-2640	(212) 389-2590

<u>Company</u>			
Kathy Cassidy	201 High Ridge Road Stamford, Connecticut 06927	(203) 357-6199	(203) 585-1191
Brian Wenzel	201 High Ridge Road Stamford, Connecticut 06927	(203) 357-6774	(203) 316-7601
Alan Green	201 High Ridge Road Stamford, Connecticut 06927	(203) 961-5077	(203) 357-3490
Johan Fogelberg	201 High Ridge Road Stamford, Connecticut 06927	(203) 357-6072	(203) 357-4975
Robert Ceske	201 High Ridge Road Stamford, Connecticut 06927	(203) 602-8337	(203) 585-1361

E-1

<u>General Electric Capital Corporation</u>			
Kathy Cassidy	201 High Ridge Road Stamford, Connecticut 06927	(203) 357-6199	(203) 585-1191
Brian Wenzel	201 High Ridge Road Stamford, Connecticut 06927	(203) 357-6774	(203) 316-7601
Alan Green	201 High Ridge Road Stamford, Connecticut 06927	(203) 961-5077	(203) 357-3490
Johan Fogelberg	201 High Ridge Road Stamford, Connecticut 06927	(203) 357-6072	(203) 357-4975
Robert Ceske	201 High Ridge Road Stamford, Connecticut 06927	(203) 602-8337	(203) 585-1361

E-2

**Exhibit F**

**Arbitration Procedures**

If Senior Management fails to reach agreement with respect to a Dispute Resolution within forty-five (45) days of a Submission and the Cure Period has not expired, either Party may submit the matter to be finally resolved by arbitration pursuant to the CPR Institute for Dispute Resolution (the “CPR”) Rules for Non-Administered Arbitration as then in effect (the “CPR Arbitration Rules”). The Parties consent to a single, consolidated arbitration for all known matters under dispute existing at the time of the arbitration and for which arbitration is permitted.

The neutral organization for purposes of the CPR Arbitration Rules will be the CPR. The arbitral tribunal shall be composed of three arbitrators, of whom each Party shall appoint one in accordance with the “screened” appointment procedure provided in Rule 5.4 of the CPR Arbitration Rules. The arbitration shall be conducted in New York City. Each Party shall be permitted to present its case, witnesses and evidence, if any, in the presence of the other Party. A written transcript of the proceedings shall be made and furnished to the Parties. The arbitrators shall determine the matter in dispute in accordance with the law of the State of New York, without giving effect to any conflict of law rules or other rules that might render such law inapplicable or unavailable, and shall apply this Agreement according to its terms, provided that the provisions relating to arbitration shall be governed by the Federal Arbitration Act, 9 U.S.C. §§ 1 et seq.

The Parties agree to be bound by any award or order resulting from any arbitration conducted in accordance with this provision and further agree that judgment on any award or order resulting from an arbitration conducted under this provision may be entered and enforced in any court having jurisdiction thereof.

Except as expressly permitted by this Agreement, no Party will commence or voluntarily participate in any court action or proceeding concerning a matter in dispute, except (i) for enforcement, (ii) to restrict or vacate an arbitral decision based on the grounds specified under applicable law, or (iii) for interim relief as provided in paragraph (e) below. For purposes of the foregoing, the parties hereto submit to the non-exclusive jurisdiction of the courts of the State of New York.

In addition to the authority otherwise conferred on the arbitral tribunal, the tribunal shall have the authority to make such orders for interim relief, including injunctive relief, as it may deem just and equitable.

Each Party will bear its own attorneys' fees and costs incurred in connection with the resolution of any matter in dispute in accordance with this provision.

F-1

**Exhibit G**

**Prior Transfer Pricing Formula**

Prior Transfer Pricing Amounts equal to the sum of the Spread Amount and the Transfer Amount, each of which is defined as follows:

**1. Spread Amount**

$[\text{Intercompany Rate} - 3\text{rd Party Rate}] * [\text{Avg Principal Outstanding}] * [\text{Daycount}]$

Where the "Intercompany Rate" is the rate of GE Capital Treasury pays to the Company based upon the GE Cost of Funds Spread at the time of origination and the "3rd Party Rate" is the contractual rate paid to the applicable Contractholder.

**2. Transfer Amount**

$[\text{Transfer Rate}] * [\text{Avg Principal Outstanding}] * [\text{Daycount}]$

Where the "Transfer Rate" is determined for each deal based upon the weighted average life that corresponds to the basis points in the following table:

WAL	Basis Points P.A.
0 - 9 mo	3.5
9 mo+ - 1 yr	9.5
1+ - 3 yr	23.0
3+ - 5 yr	27.0
5+ - 10 yr	37.0
10+ yr	47.0

**List of Transactions  
Accorded Prior Transfer Pricing Amount Treatment**

Report Currency: USD

Account	Deal	Current Period Book Value	Maturity Date	Trade Date	Settlement Date
FGIC CMSI	GE7	7,040,000.00	3-Jul-23	11/30/1993	12/15/1993
FGIC CMSI	GE95	45,000,000.00	1-Jul-16	12/7/1993	1/4/1994
FGIC CMSI	GE18-2	268,464.61	20-Apr-20	1/25/1994	1/31/1994
FGIC CMSI	GE19	17,531,746.87	1-Dec-04	1/25/1994	2/4/1994
FGIC CMSI	GE21	1,949,000.00	1-May-09	1/27/1994	2/2/1994
FGIC CMSI	GE24-2	891,652.50	31-Jul-12	2/3/1994	2/17/1994
FGIC CMSI	GE24-3	24,378,491.93	31-Jul-12	2/3/1994	2/17/1994
FGIC CMSI	GE24-1	0.00	31-Jul-12	2/17/1994	2/17/1994
FGIC CMSI	GE28-3	1,634,000.00	3-Jul-23	2/23/1994	3/10/1994
FGIC CMSI	GE31	1,779,892.40	1-Apr-13	3/7/1994	3/24/1994
FGIC CMSI	GE32-4	1,176,525.00	1-Jul-24	3/8/1994	3/24/1994
FGIC CMSI	GE33	0.00	1-Jun-26	3/10/1994	3/15/1994
FGIC CMSI	GE331	0.00	23-Sep-03	3/10/1994	3/15/1994
FGIC CMSI	GE35-3	143,284.25	31-Aug-26	3/10/1994	4/21/1994

G-1

Account	Deal	Current Period Book Value	Maturity Date	Trade Date	Settlement Date
FGIC CMSI	GE35-2	4,115,576.08	31-Aug-26	3/10/1994	4/21/1994
FGIC CMSI	GE36-2	170,000.00	1-Oct-26	3/11/1994	3/24/1994
FGIC CMSI	GE36-3	574,632.58	1-Oct-26	3/11/1994	3/24/1994
FGIC CMSI	GE40-2	1,171,750.00	1-Sep-10	3/24/1994	4/7/1994
FGIC CMSI	GE38-3	1,542,762.50	15-Dec-06	3/24/1994	4/6/1994
FGIC CMSI	GE39-2	4,905,482.19	2-Jan-12	3/24/1994	4/27/1994
FGIC CMSI	GE40-1	12,000,000.00	1-Sep-10	3/24/1994	4/7/1994
FGIC CMSI		0.00		4/11/1994	5/2/1994
	GE43-2		1-Jul-25		
FGIC CMSI	GE43-1	1,245,568.43	1-Jul-25	4/11/1994	5/2/1994
FGIC CMSI	GE48-3	741,476.08	1-Jun-26	5/4/1994	5/26/1994
FGIC CMSI	GE48-2	1,140,588.71	1-Jun-26	5/4/1994	5/26/1994
FGIC CMSI	GE68	23,473,000.00	1-Jun-04	5/5/1994	12/1/1994
FGIC CMSI	GE67	9,180,000.00	1-Jun-04	5/20/1994	6/1/1994
FGIC CMSI	GE65	10,000,000.00	1-Jun-04	5/20/1994	6/1/1994
FGIC CMSI	GE66	18,000,000.00	1-Jun-04	5/20/1994	6/1/1994



FGIC CMSI	GE54-2	183,556.93	10-Aug-34	5/25/1994	7/1/1994
FGIC CMSI	GE55	12,421,929.53	31-Jan-25	5/26/1994	7/8/1994
FGIC CMSI	GE58-2	0.00	1-Mar-16	6/6/1994	6/9/1994
FGIC CMSI	GE62-2	2,001,935.16	1-Jan-27	6/14/1994	7/19/1994
FGIC CMSI	GE75-3	1,305,618.05	29-Dec-28	6/16/1994	7/8/1994
FGIC CMSI	GE75-2	24,438,174.01	30-Jun-28	6/16/1994	7/8/1994
FGIC CMSI	GE76-2	13,000.00	2-Dec-24	6/22/1994	7/15/1994
FGIC CMSI	GE77-2	245,435.87	3-Nov-14	6/22/1994	7/14/1994
FGIC CMSI	GE77-3	1,750,000.00	3-Nov-14	6/22/1994	7/14/1994
FGIC CMSI	GE13-2	358,940.27	1-Dec-26	7/1/1994	7/1/1994
FGIC CMSI	GE85-2	894,150.00	1-Jul-26	7/20/1994	8/9/1994
FGIC CMSI	GE85-1	1,270,400.66	1-Jul-26	7/20/1994	8/9/1994
FGIC CMSI	GE86-1	3,276,967.24	2-Mar-26	7/21/1994	8/25/1994
FGIC CMSI	GE86-2	6,325,936.94	2-Mar-26	7/21/1994	8/25/1994
FGIC CMSI	GE894-3	0.00	30-Jun-03	8/5/1994	8/25/1994
FGIC CMSI	GE89-2	1,612,638.75	30-Jul-27	8/5/1994	8/25/1994
FGIC CMSI	GE89-1	3,930,495.49	30-Jul-27	8/5/1994	8/25/1994
FGIC CMSI	GE93-2	0.00	3-Jul-28	8/17/1994	8/30/1994
FGIC CMSI	GE93-3	1,000,000.00	3-Jul-28	8/17/1994	8/30/1994
FGIC CMSI	GE93-1	29,250,810.30	3-Jul-28	8/17/1994	8/30/1994
FGIC CMSI	GE94-3	528,000.00	1-Jul-25	8/18/1994	9/15/1994
FGIC CMSI	GE94-2	2,084,458.07	1-Jul-25	8/18/1994	9/15/1994
FGIC CMSI	GE96-3	267,750.00	31-Mar-27	8/30/1994	9/28/1994
FGIC CMSI	GE96-2	1,597,557.68	31-Mar-27	8/30/1994	9/28/1994
FGIC CMSI	GE99-1	108,000.00	1-Jul-27	9/8/1994	10/27/1994
FGIC CMSI	GE100-2	631,050.00	1-Aug-25	9/8/1994	9/21/1994
FGIC CMSI	GE98-3	984,850.37	1-Jul-25	9/8/1994	10/5/1994
FGIC CMSI	GE100-1	25,241,161.89	3-Aug-26	9/8/1994	10/20/1994
FGIC CMSI	GE10-3	0.00	11-Dec-03	9/13/1994	9/30/1994
FGIC CMSI	GE102-2	1,743,352.09	30-Sep-26	9/13/1994	9/30/1994
FGIC CMSI	GE105-2	3,836,392.50	30-Nov-04	9/14/1994	9/29/1994
FGIC CMSI	GE109-2	7,148,094.75	3-Aug-26	10/6/1994	11/3/1994
FGIC CMSI	GE111	1,684,944.00	2-Feb-04	10/14/1994	11/4/1994

G-2

Account	Deal	Current Period Book Value	Maturity Date	Trade Date	Settlement Date
FGIC CMSI	GE111-2	2,729,492.85	2-Feb-04	10/14/1994	11/4/1994
FGIC CMSI	GE1123-1	0.00	1-Aug-03	10/18/1994	11/3/1994
FGIC CMSI	GE1123-2	0.00	1-Aug-03	10/18/1994	11/3/1994
FGIC CMSI	GE113	4,070,370.00	2-Aug-04	10/18/1994	11/9/1994
FGIC CMSI	GE112-2	13,700,000.00	2-Nov-04	10/18/1994	11/3/1994
FGIC CMSI	GE112-1	54,000,000.00	2-Nov-04	10/18/1994	11/3/1994
FGIC CMSI	GE115-3	208,500.00	31-Mar-27	10/19/1994	11/22/1994
FGIC CMSI	GE115-2	1,240,250.27	31-Mar-27	10/19/1994	11/22/1994
FGIC CMSI	GE119	1,060,000.00	3-Aug-26	10/27/1994	11/3/1994
FGIC CMSI	GE120-4	738,900.00	1-Aug-28	10/31/1994	11/16/1994
FGIC CMSI	GE133-5	2,287.03	28-Nov-31	11/1/1994	11/18/1994
FGIC CMSI	GE133-4	642,232.69	30-Nov-20	11/1/1994	11/18/1994
FGIC CMSI	GE133-3	964,875.74	30-Nov-23	11/1/1994	11/18/1994
FGIC CMSI	GE133-2	3,824,070.97	28-Nov-25	11/1/1994	11/18/1994
FGIC CMSI	GE124-2	2,664,928.80	2-Sep-26	11/9/1994	12/15/1994
FGIC CMSI	GE124-3	3,235,597.65	2-Sep-26	11/9/1994	12/15/1994
FGIC CMSI	GE125-2	5,335,000.00	31-Oct-31	11/10/1994	12/15/1994
FGIC CMSI	GE125-1	13,439,068.53	31-Oct-31	11/10/1994	12/15/1994
FGIC CMSI	GE127-2	2,650,828.47	30-Jun-26	11/14/1994	12/30/1994
FGIC CMSI	GE1359	0.00	15-Oct-03	11/15/1994	12/2/1994
FGIC CMSI	GE136-3	6,250.00	2-Jun-25	11/15/1994	12/22/1994
FGIC CMSI	GE135	12,385.37	2-Dec-24	11/15/1994	12/2/1994
FGIC CMSI	GE136-2	39,159.54	2-Jun-25	11/15/1994	12/22/1994
FGIC CMSI	GE129-4	201,057.43	1-Dec-27	11/16/1994	11/30/1994
FGIC CMSI	GE130-2	438,569.95	30-Sep-26	11/16/1994	12/1/1994
FGIC CMSI	GE128	651,690.31	1-Dec-25	11/16/1994	12/7/1994
FGIC CMSI	GE131-3	311,903.31	1-Feb-34	11/17/1994	11/22/1994
FGIC CMSI	GE132-2	453,420.99	1-Jun-27	11/17/1994	12/14/1994
FGIC CMSI	GE131-2	790,785.00	1-Feb-34	11/17/1994	11/22/1994
FGIC CMSI	GE134-2	799,206.50	29-Oct-27	11/18/1994	11/30/1994
FGIC CMSI	GE138-2	1,582,500.06	1-Jan-27	11/30/1994	12/29/1994
FGIC CMSI	GE141-2	212,020.90	2-Dec-24	12/1/1994	12/12/1994
FGIC CMSI	GE144	289,969.00	30-Apr-10	12/6/1994	12/20/1994
FGIC CMSI	GE145	349,214.00	30-Oct-09	12/6/1994	12/21/1994
FGIC CMSI	GE150-2	0.00	30-Nov-26	12/15/1994	12/23/1994
FGIC CMSI	GE149-2	385,510.28	3-Jul-06	12/15/1994	12/29/1994
FGIC CMSI	GE133-1	2,429,192.21	30-Nov-26	12/20/1994	12/20/1994
FGIC CMSI	GE1552	0.00	1-Oct-03	12/21/1994	12/29/1994
FGIC CMSI	GE153-1	129,524.46	1-Jan-35	12/21/1994	1/5/1995
FGIC CMSI	GE155-2	209,031.48	1-Jun-18	12/21/1994	12/29/1994
FGIC CMSI	GE153-2	357,000.00	1-Jan-35	12/21/1994	1/5/1995
FGIC CMSI	GE155-1	727,000.00	1-Jun-18	12/21/1994	12/29/1994
FGIC CMSI	GE13-3	214,529.88	1-Dec-26	1/2/1995	1/3/1995
FGIC CMSI	GE90-2	27,110.60	1-Nov-24	1/3/1995	1/3/1995
FGIC CMSI	GE1603-1	0.00	30-Oct-03	1/10/1995	2/9/1995

FGIC CMSI	GE1603-2	0.00	30-Oct-03	1/10/1995	2/9/1995
FGIC CMSI	GE160-3	65,500.00	1-Jan-27	1/10/1995	2/9/1995
FGIC CMSI	GE160-2	407,378.31	1-Jan-27	1/10/1995	2/9/1995

G-3

Account	Deal	Current Period Book Value	Maturity Date	Trade Date	Settlement Date
FGIC CMSI	GE1598-1	0.00	30-Oct-03	1/11/1995	1/24/1995
FGIC CMSI	GE1598-2	0.00	30-Oct-03	1/11/1995	1/24/1995
FGIC CMSI	GE159-3	95,128.05	2-Feb-26	1/11/1995	1/24/1995
FGIC CMSI	GE148	212,514.18	31-Jan-25	1/11/1995	1/11/1995
FGIC CMSI	GE159-2	3,105,875.49	2-Feb-26	1/11/1995	1/24/1995
FGIC CMSI	GE162-2	3,141,027.25	30-Jun-26	1/19/1995	2/8/1995
FGIC CMSI	GE129-3	1,694,801.67	1-Dec-27	1/24/1995	1/24/1995
FGIC CMSI	GE1645-1	0.00	1-Aug-03	1/26/1995	2/9/1995
FGIC CMSI	GE1655-1	0.00	1-Dec-03	1/26/1995	2/9/1995
FGIC CMSI	GE166-3	575,000.00	1-Feb-35	1/26/1995	2/9/1995
FGIC CMSI	GE166-2	586,389.75	1-Feb-35	1/26/1995	2/9/1995
FGIC CMSI	GE164-2	811,210.41	1-Feb-35	1/26/1995	2/9/1995
FGIC CMSI	GE164-3	830,000.00	1-Feb-35	1/26/1995	2/9/1995
FGIC CMSI	GE165-3	920,000.00	1-Feb-35	1/26/1995	2/9/1995
FGIC CMSI	GE165-2	976,630.47	1-Feb-35	1/26/1995	2/9/1995
FGIC CMSI	GE168-3	5,889,726.25	14-Nov-25	1/27/1995	2/22/1995
FGIC CMSI	GE169-2	21,627.04	22-Jun-20	2/1/1995	2/16/1995
FGIC CMSI	GE172-2	1,136,221.54	31-Jan-28	2/7/1995	2/22/1995
FGIC CMSI	GE1742-1	0.00	1-Jul-03	2/8/1995	2/28/1995
FGIC CMSI	GE174-3	417,150.00	1-Jul-24	2/8/1995	2/28/1995
FGIC CMSI	GE174-2	712,043.37	1-Jul-24	2/8/1995	2/28/1995
FGIC CMSI	GE175-3	4,617,976.12	1-Mar-35	2/10/1995	3/28/1995
FGIC CMSI	GE175-2	23,946,065.25	1-Mar-35	2/10/1995	3/28/1995
FGIC CMSI	GE176-3	105,500.00	2-Jun-25	2/13/1995	3/9/1995
FGIC CMSI	GE176-2	1,835,129.64	2-Jun-25	2/13/1995	3/9/1995
FGIC CMSI	GE177-2	286,560.46	1-Jul-26	2/14/1995	3/8/1995
FGIC CMSI	GE1793	0.00	1-Jul-03	2/15/1995	3/2/1995
FGIC CMSI	GE179-2	1,994,856.81	1-Mar-28	2/15/1995	3/2/1995
FGIC CMSI	GE178-2	5,454,771.57	2-Mar-26	2/15/1995	2/28/1995
FGIC CMSI	GE180	2,466,532.37	2-Feb-04	2/17/1995	2/23/1995
FGIC CMSI	GE182-2	1,451,292.00	1-Jul-27	2/22/1995	3/15/1995
FGIC CMSI	GE114-2	28,163.23	1-May-25	3/1/1995	3/1/1995
FGIC CMSI	GE186-3	147,250.00	30-Jun-26	3/1/1995	4/6/1995
FGIC CMSI	GE184-1	243,298.31	1-Dec-27	3/1/1995	4/19/1995
FGIC CMSI	GE184-2	679,197.98	1-Dec-27	3/1/1995	4/19/1995
FGIC CMSI	GE186-2	860,884.36	30-Jun-26	3/1/1995	4/6/1995
FGIC CMSI	GE188-3	190,250.00	1-Apr-27	3/9/1995	3/30/1995
FGIC CMSI	GE188-2	966,356.91	1-Apr-27	3/9/1995	3/30/1995
FGIC CMSI	GE189-2	14,122.84	1-Oct-25	3/13/1995	4/12/1995
FGIC CMSI	GE190-3	1,462,451.08	3-Mar-25	3/14/1995	3/21/1995
FGIC CMSI	GE194	1,546,225.88	1-Mar-28	3/15/1995	4/4/1995
FGIC CMSI	GE193-2	3,818,564.43	30-Jun-27	3/15/1995	5/2/1995
FGIC CMSI	GE192-2	5,706,032.23	3-Jul-28	3/15/1995	4/6/1995
FGIC CMSI	GE195-2	3,141,967.73	30-Sep-25	3/21/1995	3/31/1995
FGIC CMSI	GE197-2	736,974.48	1-Jul-26	3/23/1995	4/12/1995
FGIC CMSI	GE199-2	754,812.52	2-Nov-26	3/30/1995	4/26/1995
FGIC CMSI	GE209-2	296,500.00	1-Apr-27	4/4/1995	4/27/1995
FGIC CMSI	GE209-3	1,100,348.83	1-Apr-27	4/4/1995	4/27/1995

G-4

Account	Deal	Current Period Book Value	Maturity Date	Trade Date	Settlement Date
FGIC CMSI	GE200-2	273,766.27	1-Oct-36	4/5/1995	5/2/1995
FGIC CMSI	GE200-3	748,500.00	1-Oct-36	4/5/1995	5/2/1995
FGIC CMSI	GE201-2	550,000.00	30-Mar-29	4/11/1995	4/26/1995
FGIC CMSI	GE202-2	574,929.51	20-Jan-21	4/11/1995	4/20/1995
FGIC CMSI	GE201-3	15,180,604.19	2-Apr-29	4/11/1995	4/26/1995
FGIC CMSI	GE203-2	1,065,090.20	3-Apr-28	4/17/1995	4/25/1995
FGIC CMSI	GE206-2	251,000.00	1-Oct-26	4/18/1995	5/12/1995
FGIC CMSI	GE204-2	718,932.44	30-Nov-26	4/18/1995	4/25/1995
FGIC CMSI	GE205-2	1,332,592.20	30-Nov-26	4/18/1995	4/25/1995
FGIC CMSI	GE208-2	254,761.73	2-Jul-29	4/19/1995	5/1/1995
FGIC CMSI	GE207-3	2,348,511.04	1-Jul-26	4/19/1995	5/4/1995
FGIC CMSI	GE210-2	72,582.02	22-Jun-20	5/1/1995	5/10/1995
FGIC CMSI	GE212-1	230,438.92	1-Dec-26	5/3/1995	5/11/1995
FGIC CMSI	GE213-1	347,500.00	14-Dec-05	5/3/1995	5/12/1995
FGIC CMSI	GE212-2	450,100.00	1-Dec-26	5/3/1995	5/11/1995
FGIC CMSI	GE214-2	327,000.00	1-Apr-27	5/5/1995	6/7/1995
FGIC CMSI	GE214-3	2,009,445.26	1-Apr-27	5/5/1995	6/7/1995
FGIC CMSI	GE215-3	4,212,011.40	2-Mar-35	5/5/1995	6/6/1995
FGIC CMSI	GE215-2	24,217,438.69	2-Mar-35	5/5/1995	6/6/1995
FGIC CMSI	GE118-2	263,578.65	1-Jan-26	5/11/1995	5/11/1995
FGIC CMSI	GE219-2	0.00	20-Jun-35	5/19/1995	5/25/1995

FGIC CMSI	GE218-2	284,458.22	1-Jul-26	5/19/1995	6/7/1995
FGIC CMSI	GE221	1,138,430.61	29-Jun-28	5/26/1995	6/14/1995
FGIC CMSI	GE224-2	96,377.59	1-Dec-27	5/30/1995	6/1/1995
FGIC CMSI	GE227	426,841.73	2-Apr-29	6/5/1995	7/6/1995
FGIC CMSI	GE228-2	153,750.00	1-Jan-27	6/8/1995	7/6/1995
FGIC CMSI	GE231-3	1,563,287.50	15-Jun-15	6/15/1995	6/29/1995
FGIC CMSI	GE231-2	2,057,433.86	15-Jun-15	6/15/1995	6/29/1995
FGIC CMSI	GE236-2	303,233.55	20-Jan-37	6/22/1995	6/29/1995
FGIC CMSI	GE237-2	1,188,832.96	1-Jun-29	6/22/1995	6/29/1995
FGIC CMSI	GE239-2	828,000.00	1-Sep-09	6/26/1995	6/28/1995
FGIC CMSI	GE107-2	142,160.16	1-Oct-15	6/27/1995	6/27/1995
FGIC CMSI	GE245-1	68,809.88	8-Dec-25	6/28/1995	7/13/1995
FGIC CMSI	GE245-2	368,419.90	8-Dec-25	6/28/1995	7/13/1995
FGIC CMSI	GE244-1	21,191,940.00	30-Jun-05	6/28/1995	7/10/1995
FGIC CMSI	GE248-2	58,015.96	2-Nov-26	7/11/1995	7/25/1995
FGIC CMSI	GE253	11,153,137.50	15-Mar-28	7/18/1995	8/2/1995
FGIC CMSI	GE252-2	70,038.93	1-Jan-27	7/21/1995	7/31/1995
FGIC CMSI	GE256-2	552,360.40	1-Jul-26	7/26/1995	8/15/1995
FGIC CMSI	GE259-2	101,088.07	1-Dec-25	8/9/1995	8/22/1995
FGIC CMSI	GE261-11	17,174,000.00	13-May-05	8/9/1995	8/21/1995
FGIC CMSI	GE262-1	541,470.19	30-Sep-14	8/10/1995	10/4/1995
FGIC CMSI	GE265-2	293,356.37	1-Aug-35	8/16/1995	8/30/1995
FGIC CMSI	GE267-1	2,525,000.00	1-Feb-13	8/23/1995	9/14/1995
FGIC CMSI	GE270-2	185,000.00	30-Jun-27	8/30/1995	9/28/1995
FGIC CMSI	GE271-2	2,130,600.00	2-May-16	9/6/1995	9/21/1995
FGIC CMSI	GE274-1	18,132.57	1-May-26	9/7/1995	9/13/1995
FGIC CMSI	GE274-2	439,652.61	1-May-26	9/7/1995	9/13/1995

G-5

Account	Deal	Current Period Book Value	Maturity Date	Trade Date	Settlement Date
FGIC CMSI	GE273-1	771,030.00	3-Sep-12	9/8/1995	9/27/1995
FGIC CMSI	GE277-2	9,055.24	18-Oct-30	9/19/1995	9/28/1995
FGIC CMSI	GE278-3	14,500.00	30-Jul-10	9/19/1995	10/5/1995
FGIC CMSI	GE278-2	146,393.94	30-Jul-10	9/19/1995	10/5/1995
FGIC CMSI	GE291-3	442,530.00	1-Dec-26	9/19/1995	11/17/1995
FGIC CMSI	GE279-2	996,906.25	30-Jun-27	9/20/1995	10/3/1995
FGIC CMSI	GE280-2	305,184.03	1-Dec-26	9/21/1995	10/11/1995
FGIC CMSI	GE284-3	212,467.80	1-Apr-27	9/27/1995	10/3/1995
FGIC CMSI	GE283-2	7,845.09	30-Mar-29	9/28/1995	10/25/1995
FGIC CMSI	GE288-2	2,621,287.50	14-Aug-26	10/11/1995	10/19/1995
FGIC CMSI	GE291-2	193,973.52	1-Dec-36	10/19/1995	11/17/1995
FGIC CMSI	GE270-3	97,915.75	30-Jun-27	10/20/1995	10/20/1995
FGIC CMSI	GE294	142,020.65	18-Dec-20	10/28/1995	11/1/1995
FGIC CMSI	GE295-3	801,445.48	23-Feb-04	10/31/1995	11/8/1995
FGIC CMSI	GE296-3	930,950.00	21-Feb-20	10/31/1995	11/8/1995
FGIC CMSI	GE298-1	76,298.17	14-Jun-10	11/3/1995	11/13/1995
FGIC CMSI	GE299-2	136,000.00	30-Jun-23	11/3/1995	11/13/1995
FGIC CMSI	GE298-2	334,000.00	14-Jun-10	11/3/1995	11/13/1995
FGIC CMSI	GE299-1	778,647.94	30-Jun-23	11/3/1995	11/13/1995
FGIC CMSI	GE305-2	1,402,147.45	1-Jul-27	11/8/1995	11/21/1995
FGIC CMSI	GE30-2	0.00	25-Nov-03	11/14/1995	11/21/1995
FGIC CMSI	GE302	118,270.35	29-Sep-28	11/14/1995	11/21/1995
FGIC CMSI	GE353-2	6,700,000.00	2-Dec-30	11/15/1995	11/15/1995
FGIC CMSI	GE353-1	143,747,861.31	2-Dec-30	11/15/1995	11/15/1995
FGIC CMSI	GE304-2	3,338,537.00	13-Nov-15	11/17/1995	12/12/1995
FGIC CMSI	GE304-1	3,616,925.00	15-Nov-22	11/17/1995	12/12/1995
FGIC CMSI	GE306-2	133,865.83	20-Nov-35	11/30/1995	12/14/1995
FGIC CMSI	GE308-2	79,769.82	3-Dec-35	12/1/1995	12/19/1995
FGIC CMSI	GE308-3	421,070.89	3-Dec-35	12/1/1995	12/19/1995
FGIC CMSI	GE312-2	2,890,245.33	31-May-27	12/7/1995	12/19/1995
FGIC CMSI	GE319-2	448,561.73	1-Nov-28	12/13/1995	12/19/1995
FGIC CMSI	GE319-3	819,422.00	31-Jan-35	12/13/1995	12/19/1995
FGIC CMSI	GE315-2	228,989.61	19-May-26	12/14/1995	1/17/1996
FGIC CMSI	GE322-3	1,524,915.00	29-Apr-13	12/20/1995	1/4/1996
FGIC CMSI	GE323	740,000.00	31-Jan-06	1/19/1996	2/1/1996
FGIC CMSI	GE328	1,117,932.07	30-Jun-27	2/14/1996	3/20/1996
FGIC CMSI	GE303-2	135,984.44	20-Oct-37	2/23/1996	2/23/1996
FGIC CMSI	GE358	1,919,218.07	1-Jun-28	2/29/1996	2/29/1996
FGIC CMSI	GE334-2	762,934.11	26-Feb-27	3/13/1996	4/3/1996
FGIC CMSI	GE335-2	766,372.84	26-Feb-27	3/13/1996	4/10/1996
FGIC CMSI	GE355-3	255,852.25	1-Oct-35	3/29/1996	3/29/1996
FGIC CMSI	GE355-2	263,015.98	1-Oct-35	3/29/1996	3/29/1996
FGIC CMSI	GE396-1	336,004.80	2-Oct-28	3/29/1996	3/29/1996
FGIC CMSI	GE345-2	2,876,400.00	15-May-06	4/17/1996	4/24/1996
FGIC CMSI	GE344	594,301.25	31-May-29	4/18/1996	4/30/1996
FGIC CMSI	GE347-2	(0.01)	30-Nov-22	4/24/1996	5/2/1996
FGIC CMSI	GE347-3	0.00	30-Nov-22	4/24/1996	5/2/1996
FGIC CMSI	GE347-1	10,000.00	30-Nov-22	4/24/1996	5/2/1996

G-6

Account	Deal	Current Period Book Value	Maturity Date	Trade Date	Settlement Date
FGIC CMSI	GE348-2	930,322.55	30-Jun-27	4/24/1996	5/29/1996
FGIC CMSI	GE349-2	7,545.73	19-Jun-31	4/25/1996	4/30/1996
FGIC CMSI	GE351-2	38,369.69	19-Jun-31	4/25/1996	4/30/1996
FGIC CMSI	GE350-2	39,705.24	19-Jun-31	4/25/1996	4/30/1996
FGIC CMSI	GE354-2	215,931.81	1-Nov-35	4/30/1996	4/30/1996
FGIC CMSI	GE354-3	425,740.00	1-Nov-35	4/30/1996	4/30/1996
FGIC CMSI	GE357	507,332.00	1-May-28	4/30/1996	4/30/1996
FGIC CMSI	GE352-2	332,000.00	3-Apr-28	5/1/1996	5/30/1996
FGIC CMSI	GE352-1	1,533,116.30	31-Mar-28	5/1/1996	5/30/1996
FGIC CMSI	GE361-1	0.00	31-Jul-24	5/21/1996	6/6/1996
FGIC CMSI	GE361-2	0.00	31-Jul-24	5/21/1996	6/6/1996
FGIC CMSI	GE292-2	470,969.25	1-Nov-28	5/24/1996	5/24/1996
FGIC CMSI	GE362	1,182,669.90	30-Jul-27	5/24/1996	6/21/1996
FGIC CMSI	GE363-4	167,584.78	3-Jun-13	5/29/1996	6/6/1996
FGIC CMSI	GE363-3	1,942,066.11	3-Jun-13	5/29/1996	6/6/1996
FGIC CMSI	GE364-2	165,000.00	1-Aug-13	5/30/1996	6/18/1996
FGIC CMSI	GE364-1	187,899.64	1-Aug-13	5/30/1996	6/18/1996
FGIC CMSI	GE365-2	78,900.22	2-Nov-26	6/4/1996	6/27/1996
FGIC CMSI	GE366	548,744.03	3-Jan-28	6/4/1996	6/13/1996
FGIC CMSI	GE371-1	298,963.50	3-Jul-28	6/7/1996	7/11/1996
FGIC CMSI	GE370	364,793.81	31-Mar-28	6/7/1996	6/19/1996
FGIC CMSI	GE371-2	1,073,823.59	3-Jul-28	6/7/1996	7/11/1996
FGIC CMSI	GE373-2	597,475.81	3-Jan-28	6/13/1996	7/11/1996
FGIC CMSI	GE378-3	1,170.85	1-Jan-26	6/17/1996	6/25/1996
FGIC CMSI	GE378-2	1,368.25	1-Jan-26	6/17/1996	6/25/1996
FGIC CMSI	GE378-1	255,615.00	1-Jan-26	6/17/1996	6/25/1996
FGIC CMSI	GE379-2	27,812.50	1-Oct-25	6/18/1996	6/21/1996
FGIC CMSI	GE382-2	557,096.78	26-Feb-27	6/19/1996	7/1/1996
FGIC CMSI	GE383	1,552,531.70	31-Mar-28	6/19/1996	7/10/1996
FGIC CMSI	GE382-1	1,957,767.47	1-Sep-27	6/19/1996	7/1/1996
FGIC CMSI	GE381-2	5,347,642.13	30-Jun-27	6/19/1996	6/27/1996
FGIC CMSI	GE388-1	210,226.29	1-Sep-20	6/21/1996	6/28/1996
FGIC CMSI	GE388-2	304,750.00	1-Sep-20	6/21/1996	6/28/1996
FGIC CMSI	GE392-2	40,480.06	31-Dec-31	6/26/1996	7/22/1996
FGIC CMSI	GE374-4	983,764.16	1-May-28	6/27/1996	6/27/1996
FGIC CMSI	GE394	225,000.00	1-May-08	7/1/1996	7/3/1996
FGIC CMSI	GE395	882,500.00	15-Aug-07	7/3/1996	7/15/1996
FGIC CMSI	GE399-3	295,000.00	1-Jul-36	7/11/1996	7/23/1996
FGIC CMSI	GE399-2	523,668.21	1-Jul-36	7/11/1996	7/23/1996
FGIC CMSI	GE397-3	648,310.38	3-Sep-12	7/11/1996	7/30/1996
FGIC CMSI	GE401	5,325,187.50	15-Aug-16	7/15/1996	7/23/1996
FGIC CMSI	GE402-2	368,002.38	20-Aug-31	7/16/1996	7/31/1996
FGIC CMSI	GE403-1	5,470,450.00	30-Jun-21	7/16/1996	7/31/1996
FGIC CMSI	GE405-2	229,897.98	19-Sep-31	8/1/1996	8/28/1996
FGIC CMSI	GE412-2	412,250.03	17-Jul-37	8/14/1996	9/6/1996
FGIC CMSI	GE416-3	295,835.85	1-Sep-17	9/18/1996	9/19/1996
FGIC CMSI	GE420-2	944,592.91	1-Sep-31	9/19/1996	9/20/1996
FGIC CMSI	GE422-2	897,800.00	1-Sep-26	9/20/1996	9/23/1996

G-7

Account	Deal	Current Period Book Value	Maturity Date	Trade Date	Settlement Date
FGIC CMSI	GE427	425,000.00	31-Mar-28	9/24/1996	9/25/1996
FGIC CMSI	GE424-2	400,247.56	1-Sep-36	9/25/1996	9/26/1996
FGIC CMSI	GE424-3	419,385.00	1-Sep-36	9/25/1996	9/26/1996
FGIC CMSI	GE4-3	0.00	26-Sep-03	9/27/1996	9/30/1996
FGIC CMSI	GE429-2	218,336.00	22-Sep-25	9/27/1996	9/30/1996
FGIC CMSI	GE428-2	673,600.00	20-Sep-11	9/27/1996	9/30/1996
FGIC CMSI	GE433-3	454,149.71	1-Apr-24	9/30/1996	10/1/1996
FGIC CMSI	GE433-2	1,170,000.00	1-Apr-24	9/30/1996	10/1/1996
FGIC CMSI	GE107-3	27,309.63	30-Sep-15	10/1/1996	10/1/1996
FGIC CMSI	GE440-2	81,878.96	1-Jun-29	10/23/1996	10/23/1996
FGIC CMSI	GE441-2	147,373.16	1-Apr-38	10/23/1996	10/24/1996
FGIC CMSI	GE453-3	610,239.17	3-Dec-29	11/5/1996	11/6/1996
FGIC CMSI	GE454-3	70,249.93	1-Nov-28	11/13/1996	11/14/1996
FGIC CMSI	GE454-2	532,062.68	1-Nov-28	11/13/1996	11/14/1996
FGIC CMSI	GE455-3	1,410,907.37	3-May-27	11/13/1996	11/14/1996
FGIC CMSI	GE445	27,234,702.69	1-Oct-29	11/13/1996	11/14/1996
FGIC CMSI	GE459-1	134,606.68	1-Sep-11	11/19/1996	11/20/1996
FGIC CMSI	GE460-1	238,290.04	1-Sep-11	11/19/1996	11/20/1996
FGIC CMSI	GE459-2	263,000.00	1-Sep-11	11/19/1996	11/20/1996
FGIC CMSI	GE460-2	415,000.00	1-Sep-11	11/19/1996	11/20/1996
FGIC CMSI	GE462-2	90,739.83	1-May-30	11/22/1996	11/22/1996
FGIC CMSI	GE458	81,456.07	30-Nov-06	11/25/1996	11/26/1996
FGIC CMSI	GE475	658,021.25	1-Aug-11	12/3/1996	12/3/1996
FGIC CMSI	GE463-2	253,771.78	31-Dec-27	12/4/1996	12/5/1996
FGIC CMSI	GE479	593,506.00	15-Dec-28	12/4/1996	12/5/1996
FGIC CMSI	GE473-1	45,018.46	15-Jul-24	12/5/1996	12/5/1996
FGIC CMSI	GE473-3	63,025.84	15-Jul-26	12/5/1996	12/5/1996

FGIC CMSI	GE473-2	289,966.39	15-Jul-24	12/5/1996	12/5/1996
FGIC CMSI	GE473-4	342,140.97	15-Jul-26	12/5/1996	12/5/1996
FGIC CMSI	GE484-1	271,334.28	1-Aug-07	12/16/1996	12/17/1996
FGIC CMSI	GE484-2	562,397.07	1-Aug-07	12/16/1996	12/17/1996
FGIC CMSI	GE485-2	106,355.02	22-Dec-31	12/18/1996	12/19/1996
FGIC CMSI	GE489-2	278,950.45	1-Aug-29	12/19/1996	12/20/1996
FGIC CMSI	GE488-2	336,799.17	2-Nov-26	12/19/1996	12/20/1996
FGIC CMSI	GE482	500,337.50	30-Aug-19	12/19/1996	12/19/1996
FGIC CMSI	GE490-2	364,195.52	31-Jan-36	12/30/1996	12/30/1996
FGIC CMSI	GE490-3	692,164.00	31-Jan-36	12/30/1996	12/30/1996
FGIC CMSI	GE497-2	17,941.15	1-Jul-38	1/13/1997	1/14/1997
FGIC CMSI	GE497-3	255,103.75	1-Jul-38	1/13/1997	1/14/1997
FGIC CMSI	GE496-2	227,544.67	3-Jan-39	1/22/1997	1/23/1997
FGIC CMSI	GE499-3	5,101,417.71	1-Feb-19	1/28/1997	1/28/1997
FGIC CMSI	GE505-2	18,309.24	18-Jan-36	2/6/1997	2/7/1997
FGIC CMSI	GE453-2	1,949,289.46	3-Dec-29	2/26/1997	2/26/1997
FGIC CMSI	GE507-2	207,069.48	19-Mar-27	3/5/1997	3/10/1997
FGIC CMSI	GE508-2	159,568.29	20-Oct-31	3/12/1997	3/12/1997
FGIC CMSI	GE491-2	190,843.48	1-Sep-38	3/12/1997	3/13/1997
FGIC CMSI	GE509	423,250.00	30-Mar-29	3/18/1997	3/19/1997
FGIC CMSI	GE511-2	139,067.81	30-Apr-32	3/25/1997	3/26/1997

G-8

Account	Deal	Current Period Book Value	Maturity Date	Trade Date	Settlement Date
FGIC CMSI	GE512-2	20,360.94	20-Jun-33	3/26/1997	3/27/1997
FGIC CMSI	GE517-2	636,755.82	30-Jun-28	3/26/1997	4/24/1997
FGIC CMSI	GE528-2	966,552.92	1-Nov-29	3/31/1997	12/23/1997
FGIC CMSI	GE526	1,777,444.97	1-Apr-30	3/31/1997	5/9/1997
FGIC CMSI	GE527-4	3,026,000.00	1-Jun-16	3/31/1997	5/22/1997
FGIC CMSI	GE527-3	8,661,306.49	1-Jun-16	3/31/1997	11/5/1997
FGIC CMSI	GE519-1	222,487.56	1-Jul-38	4/1/1997	4/24/1997
FGIC CMSI	GE519-2	333,515.00	1-Jul-38	4/1/1997	4/24/1997
FGIC CMSI	GE520-3	396,375.00	1-Sep-27	4/9/1997	4/9/1997
FGIC CMSI	GE531-3	51,435.14	15-Jun-15	4/15/1997	4/22/1997
FGIC CMSI	GE521	136,886.55	3-Sep-19	4/15/1997	4/15/1997
FGIC CMSI	GE535	22,291,921.27	1-Jul-21	4/15/1997	5/8/1997
FGIC CMSI	GE529-2	19,022.24	1-Apr-32	4/17/1997	4/18/1997
FGIC CMSI	GE533	2,120,215.03	1-Nov-30	4/18/1997	4/29/1997
FGIC CMSI	GE536-2	31,980.46	19-May-32	4/28/1997	5/21/1997
FGIC CMSI	GE538-3	553,011.57	1-Sep-27	4/29/1997	5/14/1997
FGIC CMSI	GE539-3	635,302.57	3-Sep-18	4/29/1997	5/8/1997
FGIC CMSI	GE538-4	859,091.69	1-Sep-27	4/29/1997	5/14/1997
FGIC CMSI	GE540-1	0.00	1-Jul-27	5/6/1997	5/21/1997
FGIC CMSI	GE540-2	895.59	1-Jul-27	5/6/1997	5/23/1997
FGIC CMSI	GE541-1	14,514.56	1-Aug-29	5/7/1997	6/5/1997
FGIC CMSI	GE541-2	1,467,388.33	1-Aug-17	5/7/1997	6/5/1997
FGIC CMSI	GE542-2	153,472.09	20-Aug-38	5/8/1997	5/13/1997
FGIC CMSI	GE544-2	65,101.92	1-Dec-38	5/19/1997	6/11/1997
FGIC CMSI	GE543-2	4,214,231.95	1-Jul-22	5/19/1997	6/3/1997
FGIC CMSI	GE546-2	947,779.50	30-Jun-28	5/21/1997	6/18/1997
FGIC CMSI	GE545-2	7,381,044.00	29-Nov-29	5/21/1997	6/2/1997
FGIC CMSI	GE550-2	63,492.72	1-May-30	5/23/1997	12/18/1997
FGIC CMSI	GE551-2	1,500,000.00	15-May-19	5/27/1997	6/3/1997
FGIC CMSI	GE552	5,416,796.64	2-Jul-29	5/28/1997	6/25/1997
FGIC CMSI	GE553-2	1,051,720.00	2-Jul-07	5/30/1997	6/13/1997
FGIC CMSI	GE555-2	5,472,882.85	29-Dec-28	6/10/1997	6/26/1997
FGIC CMSI	GE556-2	943,640.00	1-Mar-07	6/11/1997	6/18/1997
FGIC CMSI	GE557	25,522,352.67	2-Apr-29	6/12/1997	6/18/1997
FGIC CMSI	GE561-3	215,000.00	3-Jul-28	6/17/1997	7/1/1997
FGIC CMSI	GE561-2	672,776.74	3-Jul-28	6/17/1997	7/1/1997
FGIC CMSI	GE559	18,484,375.00	2-Jul-07	6/17/1997	7/1/1997
FGIC CMSI	GE564-2	29,373.59	1-Jun-37	6/26/1997	6/26/1997
FGIC CMSI	GE566	550,000.00	3-May-27	7/5/1997	7/16/1997
FGIC CMSI	GE567-2	213,625.02	1-Jan-30	7/9/1997	7/17/1997
FGIC CMSI	GE569-3	573,650.00	21-Jun-27	7/16/1997	7/24/1997
FGIC CMSI	GE571-1	171,123.24	21-Mar-39	7/24/1997	7/25/1997
FGIC CMSI	GE572	2,423,978.00	2-Jan-06	7/24/1997	8/7/1997
FGIC CMSI	GE573-2	34,379.20	19-Jul-38	7/25/1997	8/19/1997
FGIC CMSI	GE576	480,264.30	28-Dec-29	8/6/1997	9/3/1997
FGIC CMSI	GE577-3	1,770,860.22	27-May-13	8/7/1997	8/21/1997
FGIC CMSI	GE578-2	1,032,544.34	1-Sep-28	8/11/1997	8/15/1997
FGIC CMSI	GE581-2	103,695.28	1-Sep-37	8/13/1997	9/30/1997

G-9

Account	Deal	Current Period Book Value	Maturity Date	Trade Date	Settlement Date
FGIC CMSI	GE581-3	345,000.00	1-Sep-37	8/13/1997	9/30/1997
FGIC CMSI	GE585-2	334,819.67	1-Dec-28	8/20/1997	8/28/1997
FGIC CMSI	GE584-2	1,507,624.65	28-Feb-29	8/20/1997	9/15/1997

FGIC CMSI	GE586-2	639,255.56	1-Aug-31	8/21/1997	8/28/1997
FGIC CMSI	GE59	0.00	28-Nov-03	8/25/1997	9/11/1997
FGIC CMSI	GE589-2	353,321.00	1-Aug-29	8/25/1997	9/30/1997
FGIC CMSI	GE589-3	545,000.00	1-Aug-29	8/25/1997	9/11/1997
FGIC CMSI	GE591-2	309,750.00	3-Apr-17	8/26/1997	9/10/1997
FGIC CMSI	GE590-2	2,103,897.99	2-Oct-28	8/26/1997	9/16/1997
FGIC CMSI	GE456-2	252,865.99	1-Nov-28	9/2/1997	9/2/1997
FGIC CMSI	GE593-2	807,914.00	2-Jul-07	9/3/1997	9/11/1997
FGIC CMSI	GE596-1	2,471,716.40	2-Oct-28	9/10/1997	9/23/1997
FGIC CMSI	GE596-2	2,749,978.43	2-Oct-28	9/10/1997	9/23/1997
FGIC CMSI	GE597-2	177,507.29	1-Nov-39	9/16/1997	9/24/1997
FGIC CMSI	GE598-2	457,300.00	1-Oct-27	9/16/1997	10/1/1997
FGIC CMSI	GE597-3	470,000.00	1-Nov-39	9/16/1997	9/24/1997
FGIC CMSI	GE592-2	3,749,462.68	1-Sep-17	9/30/1997	9/30/1997
FGIC CMSI	GE606-2	910,000.00	2-Jul-29	10/1/1997	10/14/1997
FGIC CMSI	GE607	2,161,860.00	1-Oct-15	10/8/1997	10/20/1997
FGIC CMSI	GE613-2	0.00	24-Jul-03	10/15/1997	10/30/1997
FGIC CMSI	GE613-3	0.00	24-Jul-03	10/15/1997	10/30/1997
FGIC CMSI	GE610	618,000.00	1-Nov-28	10/15/1997	10/30/1997
FGIC CMSI	GE615-2	25,300.60	31-Oct-29	10/23/1997	11/6/1997
FGIC CMSI	GE619-2	167,970.18	3-Jan-28	10/31/1997	6/11/1998
FGIC CMSI	GE621	5,000,000.00	1-Dec-05	11/10/1997	12/1/1997
FGIC CMSI	GE624	699,767.01	1-Dec-39	11/13/1997	11/19/1997
FGIC CMSI	GE631-3	213,786.41	3-Dec-29	12/2/1997	12/10/1997
FGIC CMSI	GE633-4	956,588.76	1-Jun-22	12/3/1997	1/20/1998
FGIC CMSI	GE632-2	1,629,282.53	1-Nov-29	12/3/1997	12/18/1997
FGIC CMSI	GE633-3	1,913,177.50	1-Jun-22	12/3/1997	12/18/1997
FGIC CMSI	GE635	619,500.00	30-Nov-16	12/4/1997	12/18/1997
FGIC CMSI	GE637-2	1,784,640.00	1-Dec-27	12/5/1997	12/10/1997
FGIC CMSI	GE639-2	103.16	30-Nov-29	12/8/1997	12/17/1997
FGIC CMSI	GE640-2	0.00	1-Dec-27	12/11/1997	12/30/1997
FGIC CMSI	GE642	5,215,274.88	2-Mar-20	12/16/1997	1/7/1998
FGIC CMSI	GE644-2	1,642,857.50	15-Dec-22	12/17/1997	12/30/1997
FGIC CMSI	GE646-1	1,506,412.52	1-Jul-27	12/18/1997	1/6/1998
FGIC CMSI	GE646-2	3,565,868.76	1-Jul-27	12/18/1997	1/6/1998
FGIC CMSI	GE651-3	850,000.00	3-Jul-28	1/13/1998	2/19/1998
FGIC CMSI	GE650-3	1,882,021.00	15-Dec-22	1/13/1998	1/23/1998
FGIC CMSI	GE651-2	2,429,381.07	3-Jul-28	1/13/1998	2/19/1998
FGIC CMSI	GE652-2	1,640,000.00	1-Aug-29	1/14/1998	1/29/1998
FGIC CMSI	GE653-2	514,854.68	1-Apr-27	1/16/1998	2/4/1998
FGIC CMSI	GE654-2	708,812.50	3-Sep-18	1/20/1998	1/26/1998
FGIC CMSI	GE657	96,991.35	15-Nov-07	1/26/1998	2/3/1998
FGIC CMSI	GE665-2	2,257,195.75	1-Apr-31	2/17/1998	3/10/1998
FGIC CMSI	GE672-2	916,176.48	1-Dec-16	2/19/1998	3/19/1998
FGIC CMSI	GE672-1	2,079,000.00	1-Dec-16	2/19/1998	3/19/1998

G-10

Account	Deal	Current Period Book Value	Maturity Date	Trade Date	Settlement Date
FGIC CMSI	GE668-2	3,920,825.99	29-Jun-29	2/19/1998	3/25/1998
FGIC CMSI	GE674	829,250.00	1-Aug-25	2/25/1998	3/4/1998
FGIC CMSI	GE684-3	1,320,000.00	1-Oct-27	3/1/1998	3/31/1998
FGIC CMSI	GE690-2	593,936.87	1-Mar-33	3/2/1998	4/1/1998
FGIC CMSI	GE683-2	906,308.78	31-May-29	3/18/1998	4/23/1998
FGIC CMSI	GE684-2	1,419,000.00	1-Oct-27	3/18/1998	3/31/1998
FGIC CMSI	GE687-2	104.74	30-Aug-30	3/26/1998	4/9/1998
FGIC CMSI	GE690-3	690,000.00	1-Mar-33	3/27/1998	4/1/1998
FGIC CMSI	GE696-2	1,818,823.28	15-Nov-30	4/4/1998	4/23/1998
FGIC CMSI	GE695-2	1,022,243.34	1-Oct-31	4/7/1998	4/21/1998
FGIC CMSI	GE697-2	577,595.83	1-Jul-39	4/8/1998	4/20/1998
FGIC CMSI	GE698-2	1,044,533.42	1-Oct-30	4/8/1998	4/20/1998
FGIC CMSI	GE700	2,219,235.00	3-Jul-28	4/8/1998	4/21/1998
FGIC CMSI	GE704-2	1,048,805.00	2-Oct-28	4/16/1998	4/23/1998
FGIC CMSI	GE707-2	43,050.48	18-May-33	4/17/1998	4/27/1998
FGIC CMSI	GE712-2	1,250,000.00	29-Mar-28	4/22/1998	4/28/1998
FGIC CMSI	GE712-1	2,676,973.18	29-Mar-28	4/22/1998	4/28/1998
FGIC CMSI	GE712-3	6,589,613.56	29-Mar-28	4/22/1998	4/28/1998
FGIC CMSI	GE713-4	193,378.83	31-May-38	4/29/1998	5/13/1998
FGIC CMSI	GE713-3	337,269.74	31-May-38	4/29/1998	5/13/1998
FGIC CMSI	GE713-5	575,000.00	31-May-38	4/29/1998	5/13/1998
FGIC CMSI	GE720-2	234,084.00	29-May-08	5/1/1998	5/29/1998
FGIC CMSI	GE718-3	2,532,225.00	1-Apr-32	5/8/1998	5/20/1998
FGIC CMSI	GE726-2	2,454,774.34	3-Sep-29	5/19/1998	6/11/1998
FGIC CMSI	GE728-2	48,229.29	29-Jun-40	5/20/1998	6/9/1998
FGIC CMSI	GE730-2	1,309,607.71	29-Dec-28	5/20/1998	5/28/1998
FGIC CMSI	GE731-2	1,413,669.71	1-Oct-30	5/26/1998	6/4/1998
FGIC CMSI	GE732-2	1,097,550.00	29-Sep-28	5/28/1998	6/5/1998
FGIC CMSI	GE735-4	2,400,000.00	1-Jun-17	5/29/1998	6/11/1998
FGIC CMSI	GE735-2	2,557,263.67	1-Jun-17	5/29/1998	6/11/1998
FGIC CMSI	GE735-3	5,262,167.81	1-Jun-17	5/29/1998	6/11/1998
FGIC CMSI	GE737	520,041.64	1-Jun-40	6/3/1998	6/16/1998
FGIC CMSI	GE746-3	906,029.49	1-Jul-30	6/10/1998	7/1/1998

FGIC CMSI	GE747-2	1,248,816.00	1-May-23	6/10/1998	6/17/1998
FGIC CMSI	GE745-4	1,452,106.79	30-Mar-29	6/10/1998	6/26/1998
FGIC CMSI	GE747-1	1,702,434.00	1-May-29	6/10/1998	6/17/1998
FGIC CMSI	GE749-3	172,987.07	3-Dec-29	6/11/1998	6/24/1998
FGIC CMSI	GE750-4	194,990.86	15-May-23	6/11/1998	6/18/1998
FGIC CMSI	GE750-2	2,987,893.04	15-May-23	6/11/1998	6/18/1998
FGIC CMSI	GE752	1,171,744.32	3-Oct-11	6/12/1998	6/19/1998
FGIC CMSI	GE754-2	74,460.02	2-Dec-30	6/15/1998	6/29/1998
FGIC CMSI	GE758-2	2,012,595.00	1-Jun-18	6/18/1998	7/8/1998
FGIC CMSI	GE761-2	0.00	2-Jun-31	6/23/1998	7/1/1998
FGIC CMSI	GE761-3	898,062.00	2-Jun-31	6/23/1998	7/1/1998
FGIC CMSI	GE763-2	149,934.99	1-Jul-38	6/24/1998	7/2/1998
FGIC CMSI	GE763-3	298,426.18	1-Jul-38	6/24/1998	7/2/1998
FGIC CMSI	GE762-1	336,607.46	1-Jul-38	6/24/1998	7/2/1998
FGIC CMSI	GE762-2	637,884.25	1-Jul-38	6/24/1998	7/2/1998

G-11

Account	Deal	Current Period Book Value	Maturity Date	Trade Date	Settlement Date
FGIC CMSI	GE763-4	1,192,902.75	1-Jul-38	6/24/1998	7/2/1998
FGIC CMSI	GE764-2	410,377.87	2-Jan-40	6/25/1998	7/17/1998
FGIC CMSI	GE765-2	1,083,175.07	3-Dec-29	6/30/1998	7/15/1998
FGIC CMSI	GE767-2	391,001.61	28-Feb-31	7/1/1998	7/8/1998
FGIC CMSI	GE770-2	0.00	21-Oct-03	7/9/1998	7/16/1998
FGIC CMSI	GE769-4	173,373.25	1-Jul-38	7/9/1998	7/16/1998
FGIC CMSI	GE769-1	353,754.66	1-Jul-38	7/9/1998	7/16/1998
FGIC CMSI	GE769-2	1,228,865.00	1-Jul-38	7/9/1998	7/16/1998
FGIC CMSI	GE771-2	58,352.32	1-Jun-37	7/15/1998	9/1/1998
FGIC CMSI	GE771-3	390,000.00	1-Jun-37	7/15/1998	8/31/1998
FGIC CMSI	GE774-4	428,117.95	15-Jan-20	7/17/1998	9/2/1998
FGIC CMSI	GE774-3	632,094.19	15-Jan-20	7/17/1998	9/2/1998
FGIC CMSI	GE776-2	277,139.53	2-Dec-30	7/21/1998	7/30/1998
FGIC CMSI	GE785	0.00	15-Jul-03	7/29/1998	5/10/2000
FGIC CMSI	GE780-3	1,644,957.21	15-May-20	7/29/1998	5/10/2000
FGIC CMSI	GE779	1,677,012.50	28-Nov-16	7/29/1998	8/5/1998
FGIC CMSI	GE789-2	730,000.00	3-Oct-33	8/18/1998	8/21/1998
FGIC CMSI	GE789-1	297,562.79	3-Oct-33	8/21/1998	8/21/1998
FGIC CMSI	GE795-2	296,453.05	20-Aug-38	8/24/1998	9/3/1998
FGIC CMSI	GE796-2	76,944.76	19-Aug-39	8/25/1998	8/28/1998
FGIC CMSI	GE803-2	207,553.12	30-Sep-38	9/10/1998	9/18/1998
FGIC CMSI	GE803-3	300,000.00	30-Sep-38	9/10/1998	9/18/1998
FGIC CMSI	GE806-4	3,200.00	29-Aug-08	9/16/1998	9/22/1998
FGIC CMSI	GE823-2	0.00	1-Oct-03	10/1/1998	10/30/1998
FGIC CMSI	GE825	0.00	28-Aug-03	10/1/1998	10/30/1998
FGIC CMSI	GE817-2	467,597.56	2-Jan-40	10/1/1998	10/30/1998
FGIC CMSI	GE587-2	192,720.37	2-Sep-30	10/21/1998	10/21/1998
FGIC CMSI	GE826	306,000.00	1-Sep-05	10/30/1998	11/10/1998
FGIC CMSI	GE831-2	0.00	5-Sep-03	10/31/1998	11/19/1998
FGIC CMSI	GE828-2	794,691.32	31-Dec-30	10/31/1998	11/19/1998
FGIC CMSI	GE827-2	79,991.46	2-Dec-30	11/3/1998	11/12/1998
FGIC CMSI	GE835-2		28-Jun-41		
		169,636.60		12/1/1998	12/17/1998
FGIC CMSI	GE847-1	0.00	1-Aug-03	12/2/1998	12/11/1998
FGIC CMSI	GE838-2	125,842.77	30-Sep-31	12/2/1998	12/11/1998
FGIC CMSI	GE839-2	181,704.94	30-Sep-31	12/2/1998	12/11/1998
FGIC CMSI	GE837-1	1,605,000.00	1-Sep-28	12/2/1998	12/21/1998
FGIC CMSI	GE631-2	195,711.51	3-Dec-29	12/9/1998	12/9/1998
FGIC CMSI	GE848-2	482,288.30	1-Nov-32	12/17/1998	12/29/1998
FGIC CMSI	GE850-3	1,836,645.00	30-Jun-04	12/17/1998	1/7/1999
FGIC CMSI	GE850-4	3,113,614.00	30-Jun-04	12/17/1998	1/7/1999
FGIC CMSI	GE852-4	1,028,650.00	1-Dec-08	12/21/1998	1/11/1999
FGIC CMSI	GE854-2	647,338.00	2-Jan-09	12/29/1998	1/11/1999
FGIC CMSI	GE440-3	400,000.00	1-Dec-05	3/1/1999	3/1/1999
FGIC CMSI	GE868-2	349,647.00	2-Jul-29	4/3/1999	4/27/1999
FGIC CMSI	GE867-2	401,665.55	2-May-39	4/7/1999	4/15/1999
FGIC CMSI	GE867-3	453,000.00	2-May-39	4/7/1999	4/15/1999
FGIC CMSI	GE872-2	380,000.00	1-Aug-36	4/23/1999	5/6/1999
FGIC CMSI	GE873-2	2,432,975.00	1-May-09	4/23/1999	5/13/1999

G-12

Account	Deal	Current Period Book Value	Maturity Date	Trade Date	Settlement Date
FGIC CMSI	GE877-2	158,763.63	1-Apr-32	5/11/1999	5/18/1999
FGIC CMSI	GE877-3	250,000.00	1-Apr-32	5/11/1999	5/19/1999
FGIC CMSI	GE874-2	227,187.04	31-Dec-19	5/13/1999	5/13/1999
FGIC CMSI	GE879-2	148,246.37	19-Jan-35	5/26/1999	6/7/1999
FGIC CMSI	GE881-2	30.19	2-Feb-32	6/3/1999	6/9/1999
FGIC CMSI	GE880-2	109,051.65	20-Jul-40	6/3/1999	6/30/1999
FGIC CMSI	GE882-2	121,101.05	2-Jun-31	6/10/1999	6/17/1999
FGIC CMSI	GE882-3	348,787.50	2-Jun-31	6/10/1999	6/17/1999
FGIC CMSI	GE712-4	647,737.79	29-Mar-28	7/9/1999	7/9/1999

FGIC CMSI	GE899	929,078.00	31-Jul-09	7/28/1999	8/12/1999
FGIC CMSI	GE902-2	133,649.49	3-Nov-31	8/10/1999	8/18/1999
FGIC CMSI	GE903-2	133,501.79	19-Jul-41	8/12/1999	9/15/1999
FGIC CMSI	GE906	586,651.00	1-Apr-22	8/20/1999	9/9/1999
FGIC CMSI	GE908-2	152,323.55	20-Aug-41	8/23/1999	8/31/1999
FGIC CMSI	GE91-2	0.00	3-Dec-03	8/25/1999	10/4/1999
FGIC CMSI	GE915-3	185,896.55	19-Aug-39	8/25/1999	9/9/1999
FGIC CMSI	GE914	314,500.00	1-Sep-15	8/25/1999	9/3/1999
FGIC CMSI	GE912	622,773.32	1-Jul-24	8/25/1999	10/4/1999
FGIC CMSI	GE911-3	865,580.71	2-Aug-32	8/25/1999	9/28/1999
FGIC CMSI	GE916	8,939.47	20-Dec-38	9/3/1999	9/10/1999
FGIC CMSI	GE918-3	197,512.48	1-Sep-32	9/9/1999	9/14/1999
FGIC CMSI	GE918-2	572,032.50	1-Sep-32	9/9/1999	9/14/1999
FGIC CMSI	GE919-2	94,200.00	2-Jul-40	9/29/1999	9/30/1999
FGIC CMSI	GE919-3	140,393.51	2-Jul-40	9/29/1999	9/30/1999
FGIC CMSI	GE921-2	200,000.00	2-Jul-40	9/29/1999	9/30/1999
FGIC CMSI	GE921-3	290,342.34	2-Jul-40	9/29/1999	9/30/1999
FGIC CMSI	GE925	437,812.00	15-Mar-23	10/6/1999	10/14/1999
FGIC CMSI	GE926-5	716,670.00	1-Oct-25	10/6/1999	10/14/1999
FGIC CMSI	GE930-2	166,460.00	2-Jul-29	10/13/1999	10/28/1999
FGIC CMSI	GE930-1	464,130.00	2-Jul-29	10/13/1999	10/28/1999
FGIC CMSI	GE933-2	78,205.82	20-Feb-41	10/22/1999	11/5/1999
FGIC CMSI	GE934-2	119,732.99	19-Apr-30	10/28/1999	11/3/1999
FGIC CMSI	GE956-3	824.95	3-Dec-29	11/15/1999	11/24/1999
FGIC CMSI	GE978	5,469,000.00	1-Sep-09	11/23/1999	12/6/1999
FGIC CMSI	GE988	1,256,309.00	3-Sep-29	12/3/1999	12/10/1999
FGIC CMSI	GE1001-2	73,360.05	1-Dec-36	12/9/1999	12/20/1999
FGIC CMSI	GE1003-2	202,467.21	1-Dec-36	12/9/1999	12/20/1999
FGIC CMSI	GE1000-1	449,056.68	19-Dec-36	12/9/1999	12/20/1999
FGIC CMSI	GE1005-3	147,374.94	20-Sep-11	12/13/1999	12/17/1999
FGIC CMSI	GE1005-2	215,627.20	19-Apr-41	12/13/1999	12/17/1999
FGIC CMSI	GE1036	0.00	31-Jul-03	1/4/2000	3/21/2000
FGIC CMSI	GE1031-2	559,500.00	1-Jan-42	1/4/2000	3/21/2000
FGIC CMSI	GE1041-2	350,888.38	20-Feb-42	1/20/2000	2/4/2000
FGIC CMSI	GE1042-3	158,590.50	1-Jan-30	1/24/2000	1/31/2000
FGIC CMSI	GE1050	18,752,014.10	1-Sep-31	2/9/2000	2/24/2000
FGIC CMSI	GE1052-2	714,900.00	2-Apr-07	2/10/2000	2/17/2000
FGIC CMSI	GE1055-4	1,388,112.48	15-Oct-21	2/18/2000	2/22/2000
FGIC CMSI	GE999-2	484,425.00	1-Sep-21	3/1/2000	3/7/2000

G-13

Account	Deal	Current Period Book Value	Maturity Date	Trade Date	Settlement Date
FGIC CMSI	GE1064	19,287,179.24	1-Oct-32	3/2/2000	3/21/2000
FGIC CMSI	GE1055-2	16,369,339.00	15-Oct-21	3/6/2000	3/6/2000
FGIC CMSI	GE999-1	475,566.91	1-Sep-21	3/16/2000	3/16/2000
FGIC CMSI	GE1062-2	279,742.50	2-Jul-40	3/20/2000	3/24/2000
FGIC CMSI	GE1068-2	78,598.98	1-Dec-32	3/24/2000	4/4/2000
FGIC CMSI	GE1066-1	38,000.00	1-Feb-27	4/5/2000	4/20/2000
FGIC CMSI	GE1066	345,402.00	1-Feb-27	4/5/2000	4/20/2000
FGIC CMSI	GE1082	271,737.50	3-Feb-31	4/12/2000	5/4/2000
FGIC CMSI	GE1075-2	157,826.94	19-Jul-41	4/19/2000	4/19/2000
FGIC CMSI	GE1062-3	148,246.38	2-Jul-40	4/28/2000	4/28/2000
FGIC CMSI	GE1081-1	0.00	1-Apr-30	5/1/2000	5/5/2000
FGIC CMSI	GE1085	0.00	14-May-30	5/1/2000	5/5/2000
FGIC CMSI	GE1081-2	13,209.55	1-Apr-30	5/1/2000	5/5/2000
FGIC CMSI	GE1080-2	2,999,685.00	15-Nov-29	5/1/2000	5/3/2000
FGIC CMSI	GE1084-2	60,411.20	3-Jan-33	5/4/2000	5/10/2000
FGIC CMSI	GE1091-2	1,301,618.00	2-Feb-15	5/10/2000	5/19/2000
FGIC CMSI	GE1333	575,000.00	1-Dec-28	5/11/2000	5/25/2000
FGIC CMSI	GE1093-2	44,190.12	20-Jun-35	5/15/2000	5/23/2000
FGIC CMSI	GE1092-5	28,572.97	1-Jun-40	5/25/2000	6/1/2000
FGIC CMSI	GE1092-2	37,749.56	1-Dec-42	5/26/2000	6/2/2000
FGIC CMSI	GE1088-2	0.00	17-Nov-03	5/31/2000	5/31/2000
FGIC CMSI	GE1086-2	28,280.84	20-Jun-35	5/31/2000	5/31/2000
FGIC CMSI	GE1089-2	41,959.00	20-Jun-35	5/31/2000	5/31/2000
FGIC CMSI	GE1103	14,932,901.63	2-Sep-05	6/13/2000	6/22/2000
FGIC CMSI	GE1117	15,973,535.28	1-Nov-06	6/13/2000	7/19/2000
FGIC CMSI	GE1109	111,795.13	2-Aug-27	6/22/2000	6/29/2000
FGIC CMSI	GE1109-1	177,000.00	2-Aug-27	6/22/2000	7/13/2000
FGIC CMSI	GE1108-2	480,968.76	16-Jun-25	6/22/2000	6/29/2000
FGIC CMSI	GE1113	7,745,000.00	25-Jun-04	6/23/2000	6/28/2000
FGIC CMSI	GE1116-2	208,782.00	1-Dec-10	6/29/2000	7/13/2000
FGIC CMSI	GE1312-2	96,764.46	20-Sep-35	7/13/2000	7/28/2000
FGIC CMSI	GE1120-2	313,720.55	1-Mar-33	7/14/2000	7/21/2000
FGIC CMSI	GE1118-2	459,201.14	19-Jul-41	7/17/2000	7/19/2000
FGIC CMSI	GE1315	0.00	1-Aug-03	7/19/2000	8/1/2000
FGIC CMSI	GE1314	1,350,000.00	3-Nov-08	7/19/2000	8/1/2000
FGIC CMSI	GE1201-2	0.00	22-Oct-35	7/24/2000	8/24/2000
FGIC CMSI	GE1200-2	34,122.62	22-Oct-35	7/24/2000	8/24/2000
FGIC CMSI	GE1317-2	77,744.43	20-Nov-41	7/26/2000	8/3/2000
FGIC CMSI	GE1320	3,855,941.69	8-Aug-12	7/27/2000	8/8/2000



FGIC CMSI	GE1015-3	0.00	1-Dec-03	8/3/2000	8/23/2000
FGIC CMSI	GE10-2	0.00	11-Dec-03	8/3/2000	8/23/2000
FGIC CMSI	GE1015-2	100,950.00	25-Nov-30	8/3/2000	8/23/2000
FGIC CMSI	GE1013-2	305,000.00	24-Sep-30	8/3/2000	8/23/2000
FGIC CMSI	GE1012	563,575.00	2-Sep-30	8/10/2000	8/23/2000
FGIC CMSI	GE1135-2	1,800,000.00	15-Nov-32	8/15/2000	8/18/2000
FGIC CMSI	GE1135-1	1,835,000.00	15-Nov-32	8/15/2000	8/18/2000
FGIC CMSI	GE1205-2	147,958.87	20-Jan-42	8/24/2000	8/29/2000
FGIC CMSI	GE1457-2	482,832.00	2-Sep-30	8/24/2000	9/7/2000

G-14

Account	Deal	Current Period Book Value	Maturity Date	Trade Date	Settlement Date
FGIC CMSI	GE1470-2	268,152.65	20-Jan-37	8/31/2000	10/19/2000
FGIC CMSI	GE1136-2	0.00	1-Jul-30	9/5/2000	9/5/2000
FGIC CMSI	GE1055-3	2,485,512.18	15-Oct-21	9/5/2000	9/5/2000
FGIC CMSI	GE1500-2	99,463.99	20-Feb-42	9/11/2000	9/19/2000
FGIC CMSI	GE1467	412,657.50	28-Feb-25	9/13/2000	9/27/2000
FGIC CMSI	GE1476-2	96,266.58	2-Jul-35	9/20/2000	10/17/2000
FGIC CMSI	GE1460-3	367,468.75	1-Dec-25	9/20/2000	9/27/2000
FGIC CMSI	GE1461-1	6,454,955.10	27-Sep-12	9/20/2000	9/27/2000
FGIC CMSI	GE1466-4	0.00	1-Oct-30	9/21/2000	9/28/2000
FGIC CMSI	GE1462	166,744.05	19-Oct-35	9/25/2000	10/2/2000
FGIC CMSI	GE1480-2	19,217.73	30-Jun-33	9/27/2000	10/4/2000
FGIC CMSI	GE1483	227,362.46	30-Apr-12	9/27/2000	10/11/2000
FGIC CMSI	GE1466-3	0.00	15-Dec-03	9/28/2000	10/5/2000
FGIC CMSI	GE1465-2	6,497,014.97	22-Oct-35	9/28/2000	10/5/2000
FGIC CMSI	GE1591-2	238,069.49	2-Jan-34	10/5/2000	10/16/2000
FGIC CMSI	GE1600-3	53,277.96	2-Dec-41	10/19/2000	10/27/2000
FGIC CMSI	GE1600-6	81,198.00	2-Dec-41	10/19/2000	10/24/2000
FGIC CMSI	GE1600-5	81,500.00	2-Dec-41	10/19/2000	10/27/2000
FGIC CMSI	GE1600-2	87,000.00	2-Dec-41	10/19/2000	10/24/2000
FGIC CMSI	GE1601-2	263,580.24	19-Oct-40	10/19/2000	10/31/2000
FGIC CMSI	GE1606-1	0.00	3-Nov-03	10/24/2000	10/31/2000
FGIC CMSI	GE1603-3	376,892.16	1-Oct-30	10/24/2000	10/31/2000
FGIC CMSI	GE1609-1	0.00	14-Nov-03	10/25/2000	11/9/2000
FGIC CMSI	GE1608-2	292,957.65	1-Nov-40	10/25/2000	11/9/2000
FGIC CMSI	GE1608-3	595,000.00	31-Oct-40	10/25/2000	11/9/2000
FGIC CMSI	GE1608-1	0.00	31-Oct-03	10/26/2000	12/18/2000
FGIC CMSI	GE1607	235,669.87	1-Nov-10	10/26/2000	12/18/2000
FGIC CMSI	GE1620-2	257,741.86	20-Dec-32	11/1/2000	11/16/2000
FGIC CMSI	GE1609-2	178,440.75	19-Oct-40	11/2/2000	11/13/2000
FGIC CMSI	GE1606-2	463,403.00	1-Nov-40	11/3/2000	11/9/2000
FGIC CMSI	GE1619-1	0.00	1-Dec-03	11/7/2000	11/16/2000
FGIC CMSI	GE1618-2	245,937.66	1-Feb-34	11/7/2000	11/16/2000
FGIC CMSI	GE1615-2	239,380.49	3-Dec-40	11/9/2000	11/16/2000
FGIC CMSI	GE1615-3	310,400.00	3-Dec-40	11/9/2000	11/16/2000
FGIC CMSI	GE1619-2	578,415.23	1-Oct-10	11/10/2000	11/30/2000
FGIC CMSI	GE1617-2	942,280.00	28-May-31	11/13/2000	11/17/2000
FGIC CMSI	GE1671-1	0.00	20-Jun-03	11/14/2000	12/20/2000
FGIC CMSI	GE1623-2	79,244.74	1-Jan-41	11/14/2000	11/21/2000
FGIC CMSI	GE1669-2	136,324.38	20-Mar-42	11/14/2000	12/20/2000
FGIC CMSI	GE1623-3	502,000.00	1-Jan-41	11/14/2000	11/21/2000
FGIC CMSI	GE1621-3	1,600,000.00	1-Nov-10	11/20/2000	11/28/2000
FGIC CMSI	GE163-2	0.00	1-Dec-03	11/21/2000	12/7/2000
FGIC CMSI	GE163-3	0.00	1-Dec-03	11/21/2000	12/7/2000
FGIC CMSI	GE1633-1	0.00	1-Dec-03	11/21/2000	12/7/2000
FGIC CMSI	GE1633-2	0.00	1-Dec-03	11/21/2000	12/7/2000
FGIC CMSI	GE1626-2	40,300.86	1-Jun-34	11/21/2000	12/1/2000
FGIC CMSI	GE1628-2	130,694.00	3-Dec-40	11/21/2000	11/30/2000
FGIC CMSI	GE1632	548,158.76	1-Aug-30	11/21/2000	12/7/2000

G-15

Account	Deal	Current Period Book Value	Maturity Date	Trade Date	Settlement Date
FGIC CMSI	GE1628-3	736,271.00	3-Dec-40	11/21/2000	11/30/2000
FGIC CMSI	GE1626-1	14,010,616.31	1-Mar-04	11/21/2000	12/1/2000
FGIC CMSI	GE1629-3	0.00	1-Jul-21	11/28/2000	12/5/2000
FGIC CMSI	GE1642-4	420,000.00	1-Oct-04	11/28/2000	1/19/2001
FGIC CMSI	GE1642-5	615,112.50	1-Oct-04	11/28/2000	1/19/2001
FGIC CMSI	GE1642-3	2,835,600.00	1-Oct-30	11/28/2000	1/19/2001
FGIC CMSI	GE1630-2	199,638.44	20-Jan-42	11/29/2000	12/12/2000
FGIC CMSI	GE1651-2	312,267.65	20-Feb-32	11/29/2000	12/19/2000
FGIC CMSI	GE1658-2	600,000.00	1-Feb-41	11/29/2000	12/1/2000
FGIC CMSI	GE1658-3	615,691.03	1-Aug-41	11/29/2000	12/12/2000
FGIC CMSI	GE1645-2	741,937.29	15-Aug-28	11/29/2000	12/13/2000
FGIC CMSI	GE1637-2	0.00	1-Aug-33	12/1/2000	12/15/2000
FGIC CMSI	GE1646-2	109,342.51	20-Mar-42	12/1/2000	12/14/2000
FGIC CMSI	GE1640-2	323,332.33	1-Feb-41	12/1/2000	12/14/2000
FGIC CMSI	GE1640-3	400,000.00	1-Feb-41	12/1/2000	12/14/2000

FGIC CMSI	GE1634-1	0.00	1-Jul-04	12/4/2000	12/8/2000
FGIC CMSI	GE1634-2	0.00	31-Jul-34	12/4/2000	12/8/2000
FGIC CMSI	GE1652-1	4,542.30	14-Dec-35	12/8/2000	12/21/2000
FGIC CMSI	GE1652-2	448,051.83	14-Dec-35	12/8/2000	12/21/2000
FGIC CMSI	GE1653	1,937,562.99	3-Sep-18	12/8/2000	12/20/2000
FGIC CMSI	GE1655-2	296,751.67	31-Dec-42	12/12/2000	12/21/2000
FGIC CMSI	GE1656-2	1,060,000.00	3-Jun-30	12/12/2000	12/21/2000
FGIC CMSI	GE1694-3	0.00	3-Nov-03	12/13/2000	12/28/2000
FGIC CMSI	GE1694-4	466,605.00	1-Nov-30	12/13/2000	12/28/2000
FGIC CMSI	GE1694-2	1,760,343.00	1-Nov-30	12/13/2000	12/28/2000
FGIC CMSI	GE1659-2	152,187.09	20-May-42	12/14/2000	12/22/2000
FGIC CMSI	GE1665	14,810.00	12-Dec-12	12/15/2000	12/28/2000
FGIC CMSI	GE1689-2	22,494.05	20-Dec-40	12/18/2000	1/11/2001
FGIC CMSI	GE1667-2	349,938.38	1-Mar-22	12/18/2000	12/28/2000
FGIC CMSI	GE1664-2	182,063.89	1-Jan-41	12/19/2000	12/28/2000
FGIC CMSI	GE1664-3	279,000.00	1-Jan-41	12/19/2000	12/28/2000
FGIC CMSI	GE1666	1,240,457.04	3-May-10	12/19/2000	1/4/2001
FGIC CMSI	GE1694-1	0.00	3-Nov-03	12/20/2000	1/4/2001
FGIC CMSI	GE1692-2	17,308.95	1-Nov-33	12/20/2000	1/4/2001
FGIC CMSI	GE1692-3	37,295.65	1-Dec-33	12/20/2000	1/4/2001
FGIC CMSI	GE1671-2	33,697.32	20-Dec-30	12/21/2000	1/3/2001
FGIC CMSI	GE1668-2	95,497.30	1-Jan-41	12/21/2000	12/29/2000
FGIC CMSI	GE1668-3	510,000.00	1-Jan-41	12/21/2000	12/29/2000
FGIC CMSI	GE1665-1	1,920,500.00	1-Dec-27	12/28/2000	12/29/2000
FGIC CMSI	GE1042-2	139,145.92	1-Jan-30	1/3/2001	1/3/2001
FGIC CMSI	GE1688	0.00	1-Dec-03	1/5/2001	1/18/2001
FGIC CMSI	GE1689-1	0.00	19-Dec-03	1/5/2001	1/18/2001
FGIC CMSI	GE1687-2	90,964.45	1-Jun-43	1/5/2001	1/18/2001
FGIC CMSI	GE1687-1	345,500.00	1-Jun-43	1/5/2001	1/18/2001
FGIC CMSI	GE1682-2	857,373.21	1-Aug-31	1/10/2001	1/25/2001
FGIC CMSI	GE1677	3,037,945.24	1-Feb-16	1/15/2001	2/2/2001
FGIC CMSI	GE1681	0.00	1-Dec-03	1/16/2001	1/25/2001
FGIC CMSI	GE1679-2	73,859.32	20-Dec-40	1/16/2001	1/25/2001

G-16

Account	Deal	Current Period Book Value	Maturity Date	Trade Date	Settlement Date
FGIC CMSI	GE1700-2	166,744.63	20-Oct-42	1/18/2001	2/28/2001
FGIC CMSI	GE1686	0.00	1-Dec-03	1/19/2001	2/1/2001
FGIC CMSI	GE1685	17,567,424.13	30-Jan-04	1/19/2001	2/1/2001
FGIC CMSI	GE1636-1	202,287.43	1-Aug-33	1/30/2001	1/30/2001
FGIC CMSI	GE1708	0.00	10-Sep-03	1/31/2001	3/1/2001
FGIC CMSI	GE1706	441,847.50	1-Feb-19	1/31/2001	3/1/2001
FGIC CMSI	GE1695-2	0.80	1-Jul-42	2/1/2001	2/9/2001
FGIC CMSI	GE1696-2	89,096.01	20-Apr-10	2/1/2001	2/14/2001
FGIC CMSI	GE1698-2	333,587.85	20-Jan-11	2/5/2001	2/14/2001
FGIC CMSI	GE1700-1	0.00	31-Oct-03	2/12/2001	2/16/2001
FGIC CMSI	GE1699-3	52,697.22	2-Jan-04	2/12/2001	2/16/2001
FGIC CMSI	GE1699-1	145,675.62	2-Jan-04	2/12/2001	2/16/2001
FGIC CMSI	GE1699-4	221,500.00	1-Jan-21	2/12/2001	2/16/2001
FGIC CMSI	GE1699-2	556,000.00	1-Jan-21	2/12/2001	2/16/2001
FGIC CMSI	GE1698	207,423.99	20-Mar-36	2/15/2001	2/27/2001
FGIC CMSI	GE1703-2	52,673.42	30-Nov-33	2/21/2001	3/5/2001
FGIC CMSI	GE1705-2	0.00	31-Aug-05	2/22/2001	3/1/2001
FGIC CMSI	GE1705-1	10,000,000.00	31-Aug-05	2/22/2001	3/1/2001
FGIC CMSI	GE1713-2	77,763.14	19-Apr-41	2/27/2001	3/14/2001
FGIC CMSI	GE1712-2	136,848.78	19-Apr-41	2/27/2001	3/14/2001
FGIC CMSI	GE1709-2	398,578.61	19-Sep-42	2/27/2001	3/23/2001
FGIC CMSI	GE1715-2	0.00	3-Dec-03	3/5/2001	3/19/2001
FGIC CMSI	GE1716	0.00	1-Jul-03	3/5/2001	3/19/2001
FGIC CMSI	GE1715-1	11,429,878.91	1-Mar-04	3/5/2001	3/19/2001
FGIC CMSI	GE1710-3	250,422.91	15-Apr-22	3/9/2001	3/15/2001
FGIC CMSI	GE1717	369,658.80	26-Mar-15	3/13/2001	3/26/2001
FGIC CMSI	GE1719-2	375,654.09	20-Mar-41	3/14/2001	3/29/2001
FGIC CMSI	GE1720	88,587.06	1-May-31	3/27/2001	4/4/2001
FGIC CMSI	GE1725-2	0.00	1-Dec-03	3/28/2001	4/10/2001
FGIC CMSI	GE1097-2	55,022.24	20-Mar-37	3/28/2001	3/28/2001
FGIC CMSI	GE1723-2	637,101.92	20-Feb-41	3/28/2001	4/10/2001
FGIC CMSI	GE762-4	134,404.06	1-Jul-38	3/30/2001	3/30/2001
FGIC CMSI	GE1710-4	312,042.34	15-Apr-22	4/5/2001	4/5/2001
FGIC CMSI	GE1725-3	36,005.37	30-Dec-33	4/10/2001	4/20/2001
FGIC CMSI	GE1727-2	1,129,212.00	2-Mar-15	4/11/2001	4/25/2001
FGIC CMSI	GE1727-1	0.00	15-Sep-03	4/18/2001	4/24/2001
FGIC CMSI	GE1726-1	138,016.80	1-Apr-32	4/18/2001	4/24/2001
FGIC CMSI	GE1726-2	490,000.00	1-Apr-32	4/18/2001	4/24/2001
FGIC CMSI	GE1800	3,291,902.95	15-Sep-09	4/18/2001	11/7/2001
FGIC CMSI	GE1613	1,646,681.97	13-Nov-20	4/20/2001	4/20/2001
FGIC CMSI	GE1733-2	190,909.02	18-Apr-36	4/26/2001	5/3/2001
FGIC CMSI	GE1739-2	97,958.50	1-Jun-34	4/30/2001	5/11/2001
FGIC CMSI	GE1735-2	0.00	1-Jul-03	5/2/2001	5/10/2001
FGIC CMSI	GE1734-2	45,642.46	20-Nov-36	5/2/2001	5/10/2001
FGIC CMSI	GE1746	211,092.23	1-Feb-34	5/2/2001	5/17/2001

FGIC CMSI	GE1735-3	286,385.00	3-Jan-05	5/2/2001	5/9/2001
FGIC CMSI	GE1735-5	424,684.12	1-Jan-31	5/2/2001	5/9/2001
FGIC CMSI	GE1745	452,527.50	14-May-36	5/2/2001	5/17/2001

G-17

Account	Deal	Current Period Book Value	Maturity Date	Trade Date	Settlement Date
FGIC CMSI	GE1735-4	1,563,663.50	1-Jan-31	5/2/2001	5/9/2001
FGIC CMSI	GE1748-1	0.00	1-Oct-04	5/3/2001	5/17/2001
FGIC CMSI	GE1748-2	0.00	1-Oct-04	5/3/2001	5/17/2001
FGIC CMSI	GE1736-1	562,055.30	2-Aug-04	5/3/2001	5/10/2001
FGIC CMSI	GE1737-1	3,970,597.40	2-Aug-04	5/3/2001	5/10/2001
FGIC CMSI	GE1736-2	4,211,967.40	2-Aug-04	5/3/2001	5/10/2001
FGIC CMSI	GE1737-2	7,500,000.00	2-Aug-04	5/3/2001	5/10/2001
FGIC CMSI	GE1742-2	247,949.94	20-Aug-42	5/7/2001	5/16/2001
FGIC CMSI	GE1740-2	0.00	30-Dec-33	5/8/2001	5/15/2001
FGIC CMSI	GE1741	0.00	15-Jul-03	5/8/2001	5/15/2001
FGIC CMSI	GE1738-1	97,718.63	3-May-04	5/8/2001	5/10/2001
FGIC CMSI	GE1738-2	1,000,000.00	3-May-04	5/8/2001	5/10/2001
FGIC CMSI	GE1738-3	4,947,200.00	3-May-04	5/8/2001	5/10/2001
FGIC CMSI	GE1743-2	246,286.02	20-Aug-42	5/9/2001	5/17/2001
FGIC CMSI	GE1744-2	32,646.69	19-Jun-36	5/10/2001	5/21/2001
FGIC CMSI	GE1751	0.00	21-May-04	5/14/2001	5/23/2001
FGIC CMSI	GE1750	3,191.89	14-May-04	5/14/2001	5/23/2001
FGIC CMSI	GE1758-1	0.00	2-Sep-03	5/15/2001	5/30/2001
FGIC CMSI	GE1756-2	132,698.03	31-May-41	5/15/2001	5/30/2001
FGIC CMSI	GE1756-1	416,000.00	31-May-41	5/15/2001	5/30/2001
FGIC CMSI	GE1752-2	406,750.50	20-May-42	5/16/2001	5/24/2001
FGIC CMSI	GE1713	1,100,213.38	2-May-11	5/16/2001	5/16/2001
FGIC CMSI	GE1755	35,764.65	1-Jan-32	5/18/2001	6/6/2001
FGIC CMSI	GE1758-2	140,883.35	1-Dec-33	5/22/2001	5/31/2001
FGIC CMSI	GE1754-2	153,003.84	1-Feb-33	5/23/2001	5/30/2001
FGIC CMSI	GE1759	642,701.84	3-Aug-26	5/24/2001	5/31/2001
FGIC CMSI	GE1771-3	24,895.17	1-Jul-41	5/31/2001	6/14/2001
FGIC CMSI	GE1771-2	376,030.00	1-Jul-41	5/31/2001	6/14/2001
FGIC CMSI	GE1775	5,424,843.15	1-Apr-11	5/31/2001	6/19/2001
FGIC CMSI	GE1765	8,158,129.71	3-Oct-05	5/31/2001	6/7/2001
FGIC CMSI	GE1770	0.00	1-Jul-03	6/4/2001	6/14/2001
FGIC CMSI	GE1768-2	35,283.59	20-Apr-43	6/4/2001	6/14/2001
FGIC CMSI	GE1768	7,052,999.99	15-Jun-04	6/4/2001	6/14/2001
FGIC CMSI	GE1783-2	740,666.67	1-Sep-04	6/8/2001	7/2/2001
FGIC CMSI	GE1783-3	4,000,000.00	26-Feb-21	6/8/2001	7/2/2001
FGIC CMSI	GE1783-1	22,674,039.93	17-Jan-05	6/8/2001	7/2/2001
FGIC CMSI	GE1786-1	0.00	1-Jul-03	6/13/2001	6/28/2001
FGIC CMSI	GE1785-2	2,591,700.00	27-Jun-08	6/13/2001	6/28/2001
FGIC CMSI	GE1784-2	795,025.00	1-Jun-26	6/15/2001	6/27/2001
FGIC CMSI	GE1788-1	0.00	30-Dec-03	6/19/2001	6/28/2001
FGIC CMSI	GE1786-3	289,738.51	1-Jul-41	6/19/2001	6/28/2001
FGIC CMSI	GE1786-2	349,262.50	1-Jul-41	6/19/2001	6/28/2001
FGIC CMSI	GE1788-2	3,358,222.00	1-May-31	6/19/2001	6/29/2001
FGIC CMSI	GE1791-3	1,162,021.94	30-Sep-33	6/20/2001	7/6/2001
FGIC CMSI	GE1783-4	2,333,696.09	1-Mar-21	8/31/2001	8/31/2001
FGIC CMSI	GE1710-5	470,358.16	15-Apr-22	4/4/2002	4/4/2002
FGIC CMSI	GE1802-1	2,155,862.76	25-Aug-32	5/14/2002	5/21/2002
FGIC CMSI	GE1802-2	40,983,388.32	25-Aug-32	5/14/2002	5/21/2002

G-18

Account	Deal	Current Period Book Value	Maturity Date	Trade Date	Settlement Date
FGIC CMSI	GE1810	62,776,159.39	14-Dec-07	5/15/2002	6/28/2002
FGIC CMSI	GE1805-2	5,370,000.00	1-Jun-37	5/28/2002	6/6/2002
FGIC CMSI	GE1805-3	9,175,000.00	1-Jun-37	5/28/2002	6/6/2002
FGIC CMSI	GE1806-1	50,000.00	3-Jun-05	6/19/2002	6/21/2002
FGIC CMSI	GE1806	200,000,000.00	3-Jun-05	6/19/2002	6/21/2002
FGIC CMSI	GE1809	7,053,731.25	15-Aug-14	6/20/2002	6/25/2002
FGIC CMSI	GE1808	67,000,000.00	15-Aug-14	6/20/2002	6/25/2002
FGIC CMSI	G23161	67,000,000.00	15-Jan-08	7/2/2002	7/16/2002
FGIC CMSI	G002532A	10,630,003.44	4-Jan-08	8/7/2002	8/15/2002
FGIC CMSI	G015971A	(0.03)	15-Nov-07	11/13/2002	11/20/2002
FGIC CMSI	G004627A	(0.01)	15-Nov-07	11/13/2002	11/20/2002
		<b>2,007,576,970.36</b>			

G-19

---

**TAX MATTERS AGREEMENT**

by and among

**GENERAL ELECTRIC COMPANY,  
GENERAL ELECTRIC CAPITAL CORPORATION,  
GE FINANCIAL ASSURANCE HOLDINGS, INC.,  
GEI, INC.,**

and

**GENWORTH FINANCIAL, INC.**

Dated as of

, , 2004

---

**TABLE OF CONTENTS**

<a href="#">SECTION 1.</a>	<a href="#">Definitions</a>
<a href="#">SECTION 2.</a>	<a href="#">Filing of Tax Returns</a>
<a href="#">SECTION 3.</a>	<a href="#">Indemnification by GE</a>
<a href="#">SECTION 4.</a>	<a href="#">Indemnification by Genworth</a>
<a href="#">SECTION 5.</a>	<a href="#">Tax Sharing Payments</a>
<a href="#">SECTION 6.</a>	<a href="#">Control</a>
<a href="#">SECTION 7.</a>	<a href="#">Refunds</a>
<a href="#">SECTION 8.</a>	<a href="#">Section 338 Elections</a>
<a href="#">SECTION 9.</a>	<a href="#">Tax Benefit Payments</a>
<a href="#">SECTION 10.</a>	<a href="#">Subordination</a>
<a href="#">SECTION 11.</a>	<a href="#">Other Tax Sharing Agreements</a>
<a href="#">SECTION 12.</a>	<a href="#">Interest</a>
<a href="#">SECTION 13.</a>	<a href="#">Adjustments</a>
<a href="#">SECTION 14.</a>	<a href="#">No Duplicative Payments</a>
<a href="#">SECTION 15.</a>	<a href="#">Tax Cooperation</a>
<a href="#">SECTION 16.</a>	<a href="#">Resolution of Disputes</a>
<a href="#">SECTION 17.</a>	<a href="#">Survival</a>
<a href="#">SECTION 18.</a>	<a href="#">Amendment</a>
<a href="#">SECTION 19.</a>	<a href="#">Transfer and Similar Taxes</a>
<a href="#">SECTION 20.</a>	<a href="#">Additional Provisions</a>

i

---

**TAX MATTERS AGREEMENT**

This Agreement is made this            day of            , 2004 among the General Electric Company, a New York corporation (“GE”), General Electric Capital Corporation, a Delaware corporation (“GECC”), GEI, Inc., a Delaware corporation (“GEI”), GE Financial Assurance Holdings, Inc., a Delaware corporation (“GEFAHI”, and collectively with GE, GEI, and GECC, the “GE Parties”), and Genworth Financial, Inc., a Delaware corporation (“Genworth”).

**A.** Pursuant to the Master Agreement dated as of            , 2004 among the GE Parties and Genworth (the “Master Agreement”), Genworth has agreed, on the terms and subject to the conditions set forth in the Master Agreement, to acquire (the “Acquisition”), directly or indirectly, all the outstanding shares of stock of GNA Corporation, Inc., a Washington corporation (“GNA”), and certain other Subsidiaries of GE (GNA and such other Subsidiaries, together with Genworth, the “Genworth Companies”) in a transaction that will constitute (as to certain of such Genworth Companies) a qualified stock purchase within the meaning of Section 338(d)(3) of the Code.

**B.** GE and certain of the Genworth Companies have been members of an affiliated group of corporations of which GE is the common parent (the “GE Affiliated Group”) within the meaning of Section 1504(a) of the Code, and the members of the GE Affiliated Group have heretofore filed United States federal income tax returns on a consolidated basis (the “GE Consolidated Returns”) pursuant to Section 1501 of the Code.

**C.** Certain of GE and its Affiliates have heretofore joined in the filing of certain combined, consolidated, or other similar United States state, local, or other governmental or foreign

ii

---

income or franchise tax returns (the “GE Combined Returns”), and each group filing such a return that includes any Genworth Company and at least one of GE or a non-Genworth Affiliate of GE is designated a “Combined Group.”

**D.** GEFAHI and certain of its Subsidiaries have entered into a Tax Allocation Agreement effective November 5, 1997 and supplemented and modified effective December 4, 2001 (the “GEFAHI Tax Allocation Agreement”).

**E.** General Electric Capital Assurance Corporation, a Delaware corporation (“GECA”), which is a wholly owned indirect subsidiary of GEFAHI, and the Subsidiaries of GECA that are domestic life insurance companies, including Union Fidelity Life Insurance Company, an Illinois corporation (“UFLIC”), have been treated as

members of an affiliated group of life insurance companies of which GECA is the common parent (the "GECA Affiliated Group") pursuant to Section 1504(c)(1) of the Code, and the members of the GECA Affiliated Group have heretofore filed United States federal income tax returns on a consolidated basis pursuant to Section 1501 of the Code.

F. GECA, UFLIC, and the other Subsidiaries of GECA that are domestic life insurance companies have entered into a Tax Allocation Agreement effective December 31, 1995 and amended as of December 31, 2001 (the "GECA Tax Allocation Agreement").

G. GECC and certain of the Subsidiaries of GECC have entered into a Federal Income Tax Allocation Agreement effective June 1, 2001 (the "GECC Tax Allocation Agreement").

---

2

H. As a consequence of the Acquisition and the Initial Public Offering, the Genworth Companies that have been members of the GE Affiliated Group will no longer be members of the GE Affiliated Group, one or more of the Genworth Companies may no longer be members of a Combined Group, and UFLIC will no longer be a member of the GECA Affiliated Group.

I. The GE Affiliated Group has received a private letter ruling (the "Ruling") from the IRS dated October 6, 2003, based on submissions dated August 7, 2003, August 29, 2003, and September 24, 2003 (the "Submissions") with respect to the Acquisition.

J. The parties to this Agreement desire to make certain covenants with respect to tax matters and to allocate the liability for certain United States and foreign federal, state, local, and other taxes that may be owed to or asserted by United States or foreign federal, state, local, or other governmental taxing authorities, and to provide for the allocation of any Tax benefits which may arise as a result of any Section 338 Election.

NOW, THEREFORE, in consideration of the foregoing and of the mutual promises, covenants, and conditions contained in this Agreement, the parties to this Agreement agree as follows:

---

3

**SECTION 1. Definitions.** (a) The term "Acceleration Event" means (1) as to Genworth, that any Person or group of Persons acting in concert (other than GE and its Affiliates) acquires Effective Control of Genworth, and (2) as to any Subsidiary of Genworth, that (i) any Person or group of Persons acting in concert (other than Genworth and its Affiliates) acquires Effective Control of such Subsidiary of Genworth, or (ii) Genworth and its Affiliates otherwise cease to have Effective Control of such Subsidiary of Genworth; provided, however, that in no event shall a sale of stock of Genworth by GE or its Affiliates be treated as constituting an Acceleration Event.

(b) The term "Acceleration Fraction" has the meaning specified in Section 9(d)(2).

(c) The term "Acquisition" has the meaning specified in Recital A of this Agreement.

(d) The term "Adjustment Payment" has the meaning specified in Section 13 of this Agreement.

(e) The term "Affiliate" has the meaning specified in Section 1.1 of the Master Agreement.

(f) The term "After-Tax Basis" means that, in determining the amount of the payment necessary to indemnify any party against, or reimburse any party for, Liabilities, the amount of such Liabilities will be determined net of any reduction in Tax derived by the indemnified party as the result of sustaining or paying such Liabilities, and the amount of such indemnification payment will be increased (i.e., "grossed up") by the amount necessary to satisfy any

---

4

income or franchise Tax liabilities incurred by the indemnified party as a result of its receipt of, or right to receive, such indemnification payment (as so increased), so that the indemnified party is put in the same net after-Tax economic position (taking into account all amounts payable under Section 9 and all other relevant facts and circumstances) as if it had not incurred such Liabilities, in each case without taking into account any impact on the tax basis that an indemnified party has in its assets.

(g) The term "Agreement" means this Tax Matters Agreement.

(h) The term "Brookfield" means Brookfield Life Insurance Co., Ltd., a Bermuda corporation.

(i) The term "Brookfield Stock Purchase Agreement" means the Stock Purchase Agreement, dated as of June 26, 2003, made among Brookfield, GECC, GE Capital Asia Investments, a Delaware corporation, GEFAHI, and American International Reinsurance Company, Ltd., a Bermuda company.

(j) The term "Brookfield Taxes" means the excess (if any) of (1) the actual Tax liability of Brookfield for the Taxable Year ending December 31, 2003, over (2) the sum of (i) the amount of such Tax liability determined without regard to the sale of the GEFA-Japan Shares pursuant to the Brookfield Stock Purchase Agreement, and (ii) \$200 million.

(k) The term "Closing" has the meaning specified in Section 3.1 of the Master Agreement.

---

5

(l) The term "Closing Date" has the meaning specified in Section 3.1 of the Master Agreement.

(m) The term "Code" means the Internal Revenue Code of 1986, as amended.

(n) The term "Combined Group" has the meaning specified in Recital C of this Agreement.

(o) The term "Delayed Transfer Assets" has the meaning specified in Section 1.1 of the Master Agreement.

(p) The term "Delayed Transfer Liabilities" has the meaning specified in Section 1.1 of the Master Agreement.

(q) The term "Effective Control" means the possession, directly or indirectly, of the power to direct or cause the direction of the management and policies

of a business enterprise, whether through the ownership of voting stock, the use of a voting trust, contractual arrangements, or otherwise.

- (r) The term “Election Statement” has the meaning specified in Section 8(c) (2) of this Agreement.
- (s) The term “Final Allocation Schedule” has the meaning specified in Section 8(b) of this Agreement.
- (t) The term “Final Date” means the last date on which Genworth may be required to make a Tax Benefit Payment pursuant to Section 9(a).

6

---

(u) The term “Final Determination” means a final “determination” as defined in Section 1313(a) of the Code or any other event (including the execution of a Form 870-AD) which finally and conclusively establishes the amount of any liability for Tax.

- (v) The term “GE” has the meaning specified in the Preamble of this Agreement.
- (w) The term “GE Affiliated Group” has the meaning specified in Recital B of this Agreement.
- (x) The term “GE Combined Returns” has the meaning specified in Recital C of this Agreement.
- (y) The term “GE Combined Taxes” has the meaning specified in Section 2 (a)(1) of this Agreement.
- (z) The term “GE Consolidated Returns” has the meaning specified in Recital B of this Agreement.
- (aa) The term “GE Consolidated Taxes” has the meaning specified in Section 2(a)(1) of this Agreement.
- (bb) The term “GE Parties” has the meaning specified in the Preamble of this Agreement.
- (cc) The term “GE Tax Services” has the meaning specified in Section 15(b) of this Agreement.
- (dd) The term “GECA” has the meaning specified in Recital E of this Agreement.

7

---

- (ee) The term “GECA Affiliated Group” has the meaning specified in Recital E of this Agreement.
- (ff) The term “GECA Tax Allocation Agreement” has the meaning specified in Recital F of this Agreement.
- (gg) The term “GECC” has the meaning specified in the Preamble of this Agreement.
- (hh) The term “GECC Tax Allocation Agreement” has the meaning specified in Recital G of this Agreement.
- (ii) The term “GEFA-Japan Shares” has the meaning specified in the Preliminary Statements of the Brookfield Stock Purchase Agreement.
- (jj) The term “GEFAHI” has the meaning specified in the Preamble of this Agreement.
- (kk) The term “GEFAHI Tax Allocation Agreement” has the meaning specified in Recital D of this Agreement.
- (ll) The term “GEI” has the meaning specified in the Preamble of this Agreement.
- (mm) The term “Genworth” has the meaning specified in the Preamble of this Agreement.

8

---

- (nn) The term “Genworth Asset” has the meaning specified in Section 2.2(a) of the Master Agreement.
- (oo) The term “Genworth Business” has the meaning specified in Section 1.1 of the Master Agreement.
- (pp) The term “Genworth Companies” has the meaning specified in Recital A of this Agreement.
- (qq) The term “Genworth Tax Services” has the meaning specified in Section 15(b) of this Agreement.
- (rr) The term “GNA” has the meaning specified in Recital A of this Agreement.
- (ss) The term “Initial Public Offering” has the meaning specified in Section 1.1 of the Master Agreement.
- (tt) The term “IRS” has the meaning specified in Section 1.1 of the Master Agreement.
- (uu) The term “IPO Date” means the date of closing of the Initial Public Offering.
- (vv) The term “Life/Non-Life Election” has the meaning specified in Section 2(a)(4).
- (ww) The term “Liabilities” has the meaning specified in Section 1.1 of the Master Agreement.

9

---

- (xx) The term “Master Agreement” has the meaning specified in Recital A of this Agreement.

(yy) The term “Outstanding Obligations” has the meaning specified in Section 10 of this Agreement.

(zz) The term “Person” has the meaning specified in Section 1.1 of the Master Agreement.

(aaa) The term “Reinsurance Agreements” has the meaning specified in Section 1.1 of the Master Agreement.

(bbb) The term “Reinsurance Transaction” means any reinsurance transaction pursuant to the Reinsurance Agreements, which, for the avoidance of doubt, does not include any deemed reinsurance transaction resulting from any Section 338 Election.

(ccc) The term “Ruling” has the meaning specified in Recital I of this Agreement.

(ddd) The term “Section 12 Rate” means the rate specified in Section 12, compounded on a daily basis.

(eee) The term “Schedule B Date” means April 15, June 15, September 15, and December 15.

(fff) Unless otherwise specified, the term “Section” means a section of this Agreement.

10

---

(ggg) The term “Section 338 Election” means any election under Section 338(g) or (h)(10) of the Code (or any successor provision) or any comparable provision of state, local, or other governmental income or franchise tax law made pursuant to Section 8 of this Agreement.

(hhh) The term “Section 338 Sale Return” means each Tax Return with respect to a Taxable Year that includes a deemed asset sale pursuant to a Section 338 Election, including any such Tax Return that is a consolidated return pursuant to Treas. Reg. § 1.338-10(a)(1).

(iii) The term “Separation” has the meaning specified in Section 1.1 of the Master Agreement.

(jjj) The term “Submissions” has the meaning specified in Recital I of this Agreement.

(kkk) The term “Subsidiary” has the meaning specified in Section 1.1 of the Master Agreement.

(lll) The term “Tax” has the meaning specified in Section 1.1 of the Master Agreement.

(mmm) The term “Tax Attribute” means any net operating loss, net capital loss, investment tax credit, foreign tax credit, alternative minimum tax credit, or other item (or carryforward or carryback thereof) which could reduce any Tax.

(nnn) The term “Tax Benefit Payment” has the meaning specified in Section 9(a)(2).

11

---

(ooo) The term “Tax Return” has the meaning specified in Section 1.1 of the Master Agreement.

(ppp) The term “Taxable Year” means a taxable year as defined in Section 441(b) of the Code (and thus may include a period of less than 12 months for which a return is made).

(qqq) The term “Taxing Authority” has the meaning specified in Section 1.1 of the Master Agreement.

(rrr) The term “Transaction” means (1) the Separation; (2) any transfer of assets or assumption of liabilities pursuant to Section 3.2(c), (e), or (i) of the Master Agreement; (3) any other transfer of assets or assumption of liabilities pursuant to the Transaction Documents (including any deemed transfer of assets or assumption of liabilities as the result of any Section 338 Election) that is (i) completed on or before the Closing Date, and (ii) made other than in the ordinary course of business; and (4) any transfer of Delayed Transfer Assets or assumption of Delayed Transfer Liabilities, provided, however, that the term “Transaction” will in no event include any Reinsurance Transaction (but will include any dividend paid in connection with a Reinsurance Transaction).

(sss) The term “Transaction Documents” has the meaning specified in Section 3.2 of the Master Agreement.

(ttt) The term “Transaction Taxes” means for any Taxable Year the amount of Taxes incurred by the Genworth Companies that (1) result from the Transactions that occur in such Taxable Year, and (2) are payable with respect to such Taxable Year.

12

---

(uuu) The term “Transfer Documents” has the meaning specified in Section 3.4 of the Master Agreement.

(vvv) The term “Transition Services Agreement” has the meaning specified in Section 1.1 of the Master Agreement.

(www) The term “UFLIC” has the meaning specified in Recital E of this Agreement.

(xxx) Unless the context otherwise requires, references in this Agreement to any Person include the successors and assigns of such Person, and any references in this Agreement to the “GECC Tax Allocation Agreement” will include any successor or supplemental agreement reasonably acceptable to GE entered into in connection with any election made pursuant to Section 2(a)(4).

13

---

**SECTION 2. Filing of Tax Returns.** (a) (1) GE will prepare (or cause to be prepared) and file (or cause to be filed) all necessary GE Consolidated Returns for all Taxable Years (whether ending before, on, or after the Closing Date), all necessary GE Combined Returns for all Taxable Years (whether ending before, on, or after the Closing Date), and each Section 338 Sale Return. GE will pay (i) any Taxes (“GE Consolidated Taxes”) with respect to such GE Consolidated Returns, (ii) any Taxes (“GE Combined Taxes”) with respect to such GE Combined Returns, and (iii) any Transaction Taxes. Genworth will pay all Taxes (other than Transaction Taxes) with respect to each Section 338 Sale Return (other than a GE Consolidated Return or GE Combined Return).

(2) As promptly as reasonably practicable (and, in any event, no later than March 31, 2005), Genworth will provide GE with the necessary information relating to the Genworth Companies for GE to prepare such Tax Returns and to pay such GE Consolidated Taxes, GE Combined Taxes, and Transaction Taxes. Subject to Section 2(a)(4), such information will be prepared by Genworth in a manner consistent with past practice, and will be subject to review, adjustment, and approval by GE, which approval may not be unreasonably withheld.

(3) Subject to Section 2(a)(1), Genworth will have the right to be kept informed of, to consult with GE regarding, and to participate in, preparing and filing any Tax Returns described in Section 2(a)(1) to the extent that they may affect Genworth. Except for any gain, loss, or other item resulting directly from a Transaction, each item on each Section 338 Sale Return (other than a GE Consolidated Return or a GE Combined Return) will be subject to review, adjustment, and approval by Genworth, which approval may not be unreasonably withheld. If Genworth proposes an adjustment to any Genworth item (other than any gain, loss, or other

14

---

such item resulting directly from a Transaction) on a GE Consolidated Return or a GE Combined Return, and GE unreasonably declines to accept such proposal, then each amount payable pursuant to this Agreement (including Section 5), the GEFAHI Tax Allocation Agreement, the GECC Tax Allocation Agreement, and the GECA Tax Allocation Agreement will be determined as if such proposal had been accepted. For purposes of this Section 2 and Section 6, a failure to accept or to approve is unreasonable only if the proposal is reasonably expected (i) to result in lower aggregate Taxes of GE and Genworth and their Affiliates on a present value basis, and(ii) to have no adverse effect on GE and Genworth and their Affiliates (as determined on a combined basis) under generally accepted accounting principles.

(4) At GE's request, Genworth will cooperate fully, and will cause the Genworth Companies to cooperate fully, in the making of an election under Section 1504(c)(2) of the Code and Treasury Regulation Section 1.1502-47 (a "Life/Non-Life Election") with respect to a Taxable Year ending after December 31, 2003, in a timely and valid manner. GE will determine the time and manner for preparing and filing all documents required in connection with any such election, and Genworth will cooperate fully, and will cause Genworth Companies to cooperate fully, in preparing, executing and filing all such documents. Genworth will use its best efforts to obtain any regulatory approvals necessary in connection with such election as soon as practicable after the date hereof.

(b) (1) Except as provided in Section 2(a), Genworth will prepare (or cause to be prepared) and file (or cause to be filed) all necessary United States federal, state, local, and other governmental and foreign Tax Returns with respect to the Genworth Companies for all

15

---

Taxable Years (whether ending before, on, or after the Closing Date). Genworth will pay (or cause to be paid) any Taxes due with respect to such Tax Returns.

(2) Promptly, but no later than 180 days after the Closing Date (and, in any event, no later than 30 days prior to the due date (without extensions) of the relevant Tax Return), GE will provide Genworth with the necessary information relating to UFLIC for Genworth to prepare such Tax Returns and to pay such Taxes. Such information will be prepared in a manner consistent with past practice, and will be subject to review, adjustment, and approval by Genworth, which approval may not be unreasonably withheld.

16

---

**SECTION 3. Indemnification by GE.** (a) (1) Subject to receipt of, and except for, the tax sharing payments required to be made to GE under Section 5, GE will indemnify and hold harmless on an After-Tax Basis the Genworth Companies, and each other Affiliate of Genworth, from and against, and reimburse each such Person for, any Liabilities with respect to (i) GE Consolidated Taxes for all Taxable Years (whether ending before, on, or after the Closing Date), including any such Liabilities with respect to any liability for such GE Consolidated Taxes pursuant to Treas. Reg. § 1.1502-6, (ii) GE Combined Taxes for all Taxable Years (whether ending before, on, or after the Closing Date), including any such Liabilities with respect to any liability for GE Combined Taxes pursuant to any provision comparable to Treas. Reg. § 1.1502-6, (iii) Transaction Taxes, (iv) any interest or Tax penalties incurred by a Genworth Company as a result of, or in connection with, taking a Tax position that such Genworth Company is required to take pursuant to this Agreement (but any such interest will be indemnified under this Section 3 only to the extent that it does not duplicate interest otherwise paid by GE to Genworth under other provisions hereof), and (v) any Brookfield Taxes.

(2) (i) For purposes of the definition of Transaction Taxes in Section 1(ttt), the amount of Taxes incurred by any Genworth Company that result from the Transactions that occur in any Taxable Year will be equal to (A) the actual Tax liability of such Genworth Company for such Taxable Year, reduced by(B) the Tax liability of such Genworth Company for such Taxable Year determined as if none of such Transactions had occurred.

(ii) For purposes of Section 3(a)(2)(i), (A) in the case of any Tax governed by Section 5 of this Agreement, the GECA Tax Allocation Agreement, the GEFAHI Tax Allocation Agreement, or the GECC Tax Allocation Agreement, the Tax liability of any Genworth Company

17

---

that is a member of the GECA Affiliated Group (except as provided in Section 3(a)(2)(ii)(C)) will be deemed to be equal to the liability allocated to such Genworth Company pursuant to the GECA Tax Allocation Agreement, the Tax liability of any Genworth Company that is a party to the GEFAHI Tax Allocation Agreement will be deemed to be equal to the liability allocated to such Genworth Company pursuant to the GEFAHI Tax Allocation Agreement, the Tax liability of any Genworth Company that is a party to the GECC Tax Allocation Agreement will be deemed to be equal to the liability allocated to such Genworth Company pursuant to the GECC Tax Allocation Agreement, and the Tax liability of any other Genworth Company that is a member of the GE Consolidated Group will be deemed to be equal to the liability allocated to such Genworth Company pursuant to Section 5 of this Agreement; (B) in the case of each such Genworth Company, the amount determined under Section 3(a)(2)(i) in respect of Taxes to which Section 3(a)(2)(ii)(A) applies will (as the result of the proviso in Section 5(a) and the second proviso in Section 11) be equal to zero;(C) the federal income Tax liability of GECA for any Taxable Year (other than a Taxable Year for which a Life/Non-Life Election is in effect) will be equal to the excess (if any) of (1) the consolidated federal income Tax liability of the GECA Affiliated Group, over (2) the aggregate amount of such liability allocated to other members of the GECA Affiliated Group pursuant to the GECA Tax Allocation Agreement; and (D) in respect of Florida or Illinois income Tax Returns of Genworth Companies that are insurance companies, the income Tax liability will be decreased in an amount equal to any reduction in Florida or Illinois premium, retaliatory, or similar Tax liability that the Genworth Company obtains or would obtain as a result of the income Tax liability, in each case, the calculation to be made with and without taking into account the Transactions and the Section 338 Elections.

18

---

(b) GE will indemnify and hold harmless on an After-Tax Basis the Genworth Companies and each other Affiliate of Genworth from and against, and reimburse each such Person for, any Liabilities that such Person may at any time suffer or incur, or become subject to, as a result of or in connection with any failure by GE or any Affiliate of GE to perform any of its covenants or agreements under this Agreement.



(c) Genworth will notify GE in writing within 30 days after receipt of any written communication to or by the Genworth Companies or any other Affiliate of Genworth from or with any Taxing Authority concerning Taxes for which indemnification may be claimed from GE pursuant to the provisions of this Section 3. In addition, Genworth will notify GE in writing at least 15 days prior to the date on which Genworth, or any Affiliate of Genworth, intends to make a payment of any Taxes that are indemnifiable by GE pursuant to the provisions of this Section 3. GE will notify Genworth in writing within 30 days after receipt of any written communication to or by GE or any Affiliate of GE from or with any Taxing Authority concerning Taxes owed by any Genworth Company or any Taxes for which indemnification may be claimed from Genworth pursuant to the provisions of Section 4. In addition, GE will notify Genworth in writing at least 15 days prior to the date on which GE, or any Affiliate of GE, intends to make a payment of any Taxes that are indemnifiable by Genworth pursuant to the provisions of Section 4. The failure by a party to notify another pursuant to this Section 3(c) or pursuant to any other provision of this Agreement will not constitute a waiver of any claim to indemnification under this Agreement in the absence of and except to the extent of material prejudice to the indemnifying party.

19

---

(d) Indemnification payments under this Section 3 will be made in immediately available funds within 30 days after receipt by GE of a written request therefor.

20

---

**SECTION 4. Indemnification by Genworth.** (a) Subject to receipt of, and except for, tax sharing payments from (or on behalf of) UFLIC pursuant to the GECA Tax Allocation Agreement (insofar as such GECA Tax Allocation Agreement remains in effect as to UFLIC pursuant to Section 11), Genworth will indemnify and hold harmless on an After-Tax Basis GE and each Affiliate of GE from and against, and reimburse each such Person for, any Liabilities (except for any Transaction Taxes, determined, for purposes of this parenthetical exception, without regard to Section 3(a)(2)(ii)(A) and (B), and except for any Liabilities described in Section 3(a)(1)(i), (ii), (iv), or (v)) with respect to (i) United States federal income Taxes of the GECA Affiliated Group for all Taxable Years (whether ending before, on, or after the Closing Date), including any such Liabilities with respect to any liability for such Taxes pursuant to Treas. Reg. § 1.1502-6, and (ii) United States federal, state, local, or other governmental or foreign income or franchise Taxes imposed on any Genworth Company for any Taxable Year (whether beginning before, on, or after the Closing Date).

(b) Genworth will indemnify and hold harmless on an After-Tax Basis GE and each Affiliate of GE from and against, and reimburse each such Person for, any Liabilities that any such Person may at any time suffer or incur, or become subject to, as a result of or in connection with the failure by Genworth or any Affiliate of Genworth to perform any of its covenants or agreements under this Agreement.

(c) Indemnification payments under this Section 4 will be made in immediately available funds within 30 days after receipt by Genworth of a written request therefor.

21

---

**SECTION 5. Tax Sharing Payments.** (a) If any Genworth Company (other than any Genworth Company that is a party to the GEFAHI Tax Allocation Agreement or the GECC Tax Allocation Agreement for such Taxable Year) is included in the GE Consolidated Return for any Taxable Year ending on or after December 31, 2003, then Genworth will make a tax sharing payment to GE (or, notwithstanding Section 7(a), GE will make a tax sharing payment to Genworth) for such Taxable Year determined in a manner consistent with tax sharing practices existing as of the date of this Agreement (as determined in the reasonable discretion of GE); provided, however, that any amount payable pursuant to such existing tax sharing practices will be determined for all purposes of this Section 5 without taking into account any Transaction Taxes (determined for purposes of this proviso without regard to Section 3(a)(2)(ii)(A) and (B)).

(b) Notwithstanding Section 7(a), if any Genworth Company (other than any Genworth Company that was a party to the GEFAHI Tax Allocation Agreement or the GECC Tax Allocation Agreement for such Taxable Year) is included in the GE Consolidated Return for any Taxable Year (whether ending before, on, or after the Closing Date), and if any adjustment is made, as the result of any amended return, audit, or otherwise, to any income, deduction, or other item of such Genworth Company for such Taxable Year, then Genworth will make a payment to GE (or GE will make a payment to Genworth) in accordance with existing tax sharing practices as of the date of this Agreement (as determined in the reasonable discretion of GE). Such payment will be made in immediately available funds within 30 days after such adjustment becomes final together with interest at the rate applicable to underpayments or overpayments of Tax, as the case may be, from (but not including) the due date (without extensions) of the GE Consolidated Return for such Taxable Year to (and including) the date such payment is actually made;

22

---

provided, however, that in the case of any such adjustment for any Taxable Year that results from the carryback of any net operating loss or other Tax Attribute from any subsequent Taxable Year, such payment will be made together with interest at the rate applicable to underpayments or overpayments of Tax, as the case may be, from (but not including) the date on which the relevant Tax Return is filed for such subsequent Taxable Year to (and including) the date such payment is actually made.

(c) Genworth will make estimated payments with respect to all amounts due pursuant to Section 5(a) in a manner consistent with the principles of Section 6655 of the Code. At least three business days prior to the date on which GE intends to file the GE Consolidated Return for such Taxable Year (but in no event prior to the fifth day after Genworth receives notice of such intention), Genworth will pay to GE any excess of (1) the amount due under Section 5(a) in respect of such Genworth Company for such Taxable Year, over (2) the amount of such estimated payments for such Taxable Year, or GE will pay to Genworth an amount equal to any excess of the amount described in subparagraph (2) over the amount described in subparagraph (1). Any such payment will be made in immediately available funds together with interest at the Section 12 Rate from (but not including) the due date (without extensions) of the GE Consolidated Return for such Taxable Year to (and including) the date on which such payment is actually made.

(d) Nothing in this Section 5 will require Genworth to make any payment to GE (or GE to make any payment to Genworth) that would duplicate any amount previously paid in accordance with existing tax sharing practices.

23

---

(e) The provisions of Section 5(a), (b), (c), and (d) will apply mutatis mutandis, with respect to any Genworth Company included in any GE Combined Return.

24

---

**SECTION 6. Control.** (a) Except as provided in Section 6(b), GE will have the exclusive right to file any amended Tax Returns and to control any audit or other administrative or judicial proceeding with respect to GE Consolidated Taxes, GE Combined Taxes, Transaction Taxes and/or the allocation shown on the Final Allocation Schedule, and the portion of any other audit or other administrative or judicial proceeding regarding any other matter that may result in any Tax liability with respect to which GE provides indemnification under this Agreement; provided, however, that (1) GE will not settle any such proceeding in a manner that would materially adversely affect Genworth without the consent of Genworth, which consent may not be unreasonably withheld, and (2) if GE unreasonably fails to accept a proposal by Genworth to file an amended Tax Return, then each amount payable pursuant to this Agreement will be determined as if such proposal had been accepted.

(b) Genworth will have the exclusive right to file any amended Tax Returns and to control any audit or other administrative or judicial proceeding with respect to any Tax liability of Brookfield; provided, however, that (1) Genworth will not settle any such proceeding in a manner that would materially adversely affect GE without the consent of GE, which consent may not be unreasonably withheld, and (2) if Genworth unreasonably fails to accept a proposal by GE to file an amended Tax Return, then each amount payable pursuant to this Agreement will be determined as if such proposal had been accepted.

(c) Subject to Section 6(a), GE will keep Genworth informed of, consult with Genworth regarding, and permit Genworth to participate in, any such filing, audit, or other judicial or administrative proceeding that may affect Genworth or any Affiliate of Genworth.

25

---

(d) Except as otherwise provided in Section 6(a) and (b), Genworth will have the exclusive right to control any audit or other administrative or judicial proceeding with respect to the Tax liability of the Genworth Companies.

(e) Subject to Section 6(d), Genworth will keep GE informed of, consult with GE regarding, and permit GE to participate in, any such filing, audit, or other judicial or administrative proceeding that may affect GE or any Affiliate of GE.

26

---

**SECTION 7. Refunds.** (a) (1) GE will be entitled to any refunds (including interest paid therewith) in respect of any GE Consolidated Taxes for any Taxable Year (whether ending before, on, or after the Closing Date), any GE Combined Taxes for any Taxable Year (whether ending before, on, or after the Closing Date), any Transaction Taxes, and any other Tax liability with respect to which GE provides indemnification under this Agreement.

(2) UFLIC will be entitled to any amount payable to UFLIC in respect of any refunds, carrybacks, adjustments, or other items (including interest paid therewith) pursuant to the GECA Tax Allocation Agreement for any Taxable Year.

(b) Except as provided in Section 7(a), Genworth will be entitled to any refunds (including interest paid therewith) in respect of any United States federal, state, local, or other governmental or foreign Tax liability of the Genworth Companies.

27

---

**SECTION 8. Section 338 Elections.** (a) If GE determines in its sole and absolute discretion that an election will be made under Section 338(g) of the Code, Section 338(h)(10) of the Code, and/or any of the Treasury Regulations under Section 338 with respect to any of the Genworth Companies for which such election may properly be made, and/or that an election will be made under any comparable provision of state, local, or other governmental income or franchise tax law, then GE and Genworth will join in making, or Genworth will make, such election in a timely and valid manner, including by filing any necessary Forms 8023 and 8883 and any necessary attachments and comparable state forms. Subject to Section 8(b), GE will determine the time and manner for preparing and filing all forms and documents required in connection with any such election, and Genworth will cooperate fully in preparing and filing all such forms and documents.

(b) The parties agree that the “aggregate deemed sale price” and “adjusted grossed-up basis” (as such terms are defined in the regulations under Section 338 of the Code) with respect to each Section 338 Election will be determined by GE consistent with the principles of Section 338. Such aggregate deemed sale price and adjusted grossed-up basis will initially be allocated as indicated on the pro forma schedule attached hereto as Schedule A. Schedule A also includes projections of the Tax Benefit Payments to be made on each Schedule B Date under this Agreement (determined without regard to any items shown on Schedule D attached hereto). As soon as practicable after the Closing, but in no event later than ten days prior to the last date on which the first Section 338 Election must be filed, GE will prepare a final tax allocation schedule (the “Final Allocation Schedule”) in a manner consistent with the principles applied and methodologies used in preparing Schedule A (and thus without regard to any items

28

---

shown on Schedule D attached hereto), but taking into account (1) any difference between the actual fair market value as determined by GE of the Genworth common stock and any other consideration transferred at Closing and the estimated fair market value of such stock and other consideration used in preparing Schedule A, and (2) any difference between the value of any Genworth Asset as finally determined and the estimated value of such Genworth Asset used in preparing Schedule A. GE will consult with Genworth in the preparation of the Final Allocation Schedule, but GE will have the exclusive right, subject to the principles of this paragraph and to Section 16, to make all determinations relating thereto. The Final Allocation Schedule will be attached hereto as Schedule B, and Schedule B will also include projections as of each relevant Schedule B Date of the Tax Benefit Payments to be made under this Agreement (which projections will be prepared in a manner consistent with the principles applied and methodologies used in preparing the projections of such Tax Benefit Payments included in Schedule A). Schedule B will thereafter be adjusted to reflect any inaccuracy of any of the assumptions contained therein, whether as a result of any change in fact or law, audit, amended return, or otherwise; provided, however, that Schedule B will not be adjusted to reflect any inaccuracy or change (i) relating to the assumed adequacy of the amount and character of Genworth’s taxable income, (ii) relating to the projected tax rate, (iii) to the extent attributable to Genworth’s breach of any covenant hereunder, (iv) relating to any item shown on Schedule D attached hereto, (v) in the tax basis of any asset of any Genworth Company (or any interest deduction) resulting from any payment made pursuant to Section 9(b)(2) or (3) in any Taxable Year, or (vi) in the tax basis of any asset of any Genworth Company resulting from any compensation paid as described in Section 9(a)(1)(ii) in any Taxable Year. If Genworth or any of its Affiliates receives notice that the allocations on Schedule B may be examined, reviewed, or disputed by any Taxing Authority, Genworth will

29

---

promptly notify GE in writing to that effect. If GE or any of its Affiliates receives notice that the allocations on Schedule B may be examined, reviewed, or disputed by any Taxing Authority, GE will promptly notify Genworth in writing to that effect. The total projected Tax Benefit Payments by Genworth on Schedule B (as originally attached hereto or as adjusted under this Section 8(b)) will not exceed \$640 million.

(c) (1) GE and Genworth agree to treat the deemed transfer of insurance contracts pursuant to each such Section 338 Election as a deemed assumption

reinsurance transaction for United States federal income tax purposes in accordance with proposed Treas. Reg. § 1.338-11 (or any successor proposed or final regulations).

(2) If the combined federal income tax liability of GE and its Affiliates and Genworth and its Affiliates is likely (in the reasonable judgment of GE) to be reduced as the result of any election under Treas. Reg. § 1.848-2(g) with respect to any Reinsurance Transaction (including any novation pursuant thereto) or any deemed assumption reinsurance transaction described in Section 8(c), then GE and Genworth will make (or cause to be made) any such election. Any such election will be made by executing (or causing to be executed) an Election Statement substantially in the form attached hereto as Annex A (in the case of any Reinsurance Transaction) or Annex B (in the case of any deemed assumption reinsurance transaction) prior to the earliest due date of any federal income tax return to which a schedule must be attached pursuant to Treas. Reg. § 1.848-2(g)(8)(ii) in respect of such election (or on such earlier date as may be requested by GE or Genworth). The parties will treat any such Election Statements as addenda to the relevant reinsurance agreements (in the case of any Reinsurance Transactions) or to this

30

---

Agreement (in the case of any deemed reinsurance transactions). No such election will be revoked without the express prior written consent of both GE and Genworth.

(3) Genworth will prepare (or cause to be prepared), subject to review, adjustment, and approval by GE, a schedule as described in Treas. Reg. § 1.848-2(g)(8)(ii) in respect of each such election, and each of Genworth (as to the Genworth Companies) and GE (as to itself and its Affiliates) will attach (or cause to be attached) such schedule in duly executed form to the applicable United States federal income Tax Return for the first Taxable Year ending after the applicable election becomes effective.

(d) From and after the time that Genworth is no longer 100%-owned by GE (or its Affiliates), Genworth will, and will cause each of the Subsidiaries of Genworth to, comply with each of the representations made in the Submissions or stated in the Ruling, extend the statute of limitations to the extent requested as described in the caveat in the Ruling, and otherwise comply with and conform to all applicable conditions of the Ruling; provided that this Section 8(d) will not make Genworth responsible for any action or omission of any Person other than Genworth or a Subsidiary of Genworth.

**SECTION 9. Tax Benefit Payments.** (a) (1) Not later than 30 days after the due date (with extensions) for the filing by any Genworth Company of any United States federal, Florida, or Illinois income Tax Return (other than an estimated return), or any consolidated, combined, or other similar federal, Florida, or Illinois income Tax Return (other than an estimated return) that includes any Genworth Company, for any Taxable Year ending after the Closing Date and on or before the twenty-fifth anniversary of the Closing Date, Genworth will determine

31

---

(subject to review, adjustment, and approval by GE, which approval may not be unreasonably withheld) the hypothetical Tax liability that would have been shown on such return if each of the assumptions set forth below is made (solely for purposes of such hypothetical determination).

(i) None of the elections contemplated by Section 8 is made.

(ii) No deduction is allowed for compensation (including without limitation any deduction for amounts treated as compensation under Treas. Reg. § 1.83-7) payable by GE or any Affiliate of GE (other than a Genworth Company) to any employee of any Genworth Company in cash, stock or other property.

(iii) In respect of Florida or Illinois income Tax Returns of any Genworth Company that is an insurance company, the hypothetical income Tax liability for any Taxable Year will be decreased in an amount equal to any reduction in Florida or Illinois premium, retaliatory, or similar Tax liability that such Genworth Company would have obtained at any time as a result of such hypothetical income Tax liability for such Taxable Year.

(iv) In respect of any Florida or Illinois income Tax Returns of Genworth Companies that are not insurance companies, the hypothetical income Tax liability will be deemed to be equal to zero.

(2) (i) For each Taxable Year described in Section 9(a)(1), Genworth will make one or more payments (payments made by Genworth under this Section 9(a), Section 9(d), or Section 9(e) being hereinafter referred to as "Tax Benefit Payments") to GEFAHI in an aggregate amount equal to 80 percent of the excess (if any) of (A) the hypothetical Tax liability (as

32

---

determined under Section 9(a)(1)) that would have been shown on each Tax Return to which Section 9(a)(1) applies, over (B) the actual Tax liability shown on such Tax Return; provided, however, that if the amount determined under clause (B) exceeds the amount determined under clause (A), then GEFAHI will make a payment equal to 80 percent of the amount of such excess to Genworth, and any such payments to Genworth, together with any payments to Genworth under Section 9(d) or Section 9(e), will be treated as negative Tax Benefit Payments. Notwithstanding anything in this Agreement to the contrary, the total amount of all Tax Benefit Payments (less negative Tax Benefit Payments) pursuant to this Agreement (determined without regard to any payment made in respect of an increase or decrease in Schedule B pursuant to Section 9(c)(1) or (2)) will not at any time exceed \$640 million. The amount of any Tax Benefit Payments not made by reason of the preceding sentence (together with interest thereon at the Section 12 Rate) will be offset against and reduce (but not below zero) the amount of any subsequent negative Tax Benefit Payments that otherwise would be required to be made pursuant to this Agreement.

(ii) For purposes of this Agreement, any right to receive a refund of Tax or tax sharing payment will be treated as a negative Tax liability, the excess of a positive Tax liability over a negative Tax liability will be equal to the sum of the absolute values of such Tax liabilities, and the excess of a negative Tax liability having a smaller absolute value over a negative Tax liability having a larger absolute value will be equal to the difference in the absolute values of such Tax liabilities.

33

---

(iii) Any Tax Benefit Payments pursuant to Section 9(a)(2)(i) will be made by Genworth to GEFAHI (or any negative Tax Benefit Payments pursuant to Section 9(a)(2)(i) will be made by GEFAHI to Genworth) in accordance with clauses (A) through (F) set forth below.

(A) Except for any payment deferred under Section 9(a)(2)(iii)(C), Tax Benefit Payments will be made by Genworth on each Schedule B Date during the first Taxable Year ending after the Closing Date and the first Taxable Year ending after the IPO Date as shown in Schedule C.

(B) Except for any payment deferred under Section 9(a)(2)(iii)(C), for each Taxable Year (other than any Taxable Year described in Section 9(a)(2)(iii)(A)) beginning prior to the Final Date, a positive or negative Tax Benefit Payment will be made on each Schedule B Date during such then-current Taxable Year equal to 25% of the Tax Benefit Payment determined under Section 9(a)(2)(i) for the prior Taxable Year, multiplied in the case of a positive Tax Benefit Payment by a fraction whose numerator is equal to (1) the total of the amounts shown on Schedule B with respect to such then-current Taxable Year, and whose denominator is equal to (2) the total of the amounts shown on Schedule B with respect to such prior Taxable Year; provided, however, that if such prior Taxable Year includes fewer than twelve full calendar months,

the denominator of such fraction will be multiplied by twelve, and the numerator will be multiplied by the number of complete months in such prior Taxable Year.

(C) If Genworth is otherwise required to make any Tax Benefit Payment on any Schedule B Date during any Taxable Year to GEFAHI pursuant to Section 9(a)(2)(iii), then Genworth may (in its sole and absolute discretion) elect to defer such payment. If Genworth elects to

34

---

defer any Tax Benefit Payment pursuant to this Section 9(a)(2)(iii)(C), then (1) such Tax Benefit Payment will be made on or before the due date (without extensions) for such Taxable Year together with interest at the rate specified in Section 12, compounded on a daily basis, from (but not including) such Schedule B Date to (and including) the date of payment, and (2) such Tax Benefit Payment will be deemed (for all other purposes of this Section 9) to have been made on such Schedule B Date.

(D) If (1) any amount payable by Genworth to GEFAHI under Section 9(a)(2)(i) for any Taxable Year exceeds (2) the aggregate amount of the Tax Benefit Payments made by Genworth to GEFAHI for such Taxable Year under Section 9(a)(2)(iii)(A), (B), or (C) (less the aggregate amount of the negative Tax Benefit Payments made by GEFAHI to Genworth for such Taxable Year under Section 9(a)(2)(iii)(B)), then Genworth will make a Tax Benefit Payment equal to the amount of such excess to GEFAHI; provided, however, that if the amount determined under subclause (2) exceeds the amount determined under subclause (1), then GEFAHI will make a payment equal to the amount of such excess to Genworth, and such payment to Genworth will be treated as a negative Tax Benefit Payment.

(E) If (1) any amount payable by GEFAHI to Genworth under Section 9(a)(2)(i) for any Taxable Year, exceeds (2) the aggregate amount of the negative Tax Benefit Payments made by GEFAHI to Genworth for such Taxable Year under Section 9(a)(2)(iii)(B) (less the aggregate amount of the Tax Benefit Payments made by Genworth to GEFAHI for such Taxable Year under Section 9(a)(2)(iii)(A), (B), or (C)), then GEFAHI will make a negative Tax Benefit Payment equal to the amount of such excess to Genworth; provided, however, that if the amount

35

---

determined under subclause (2) exceeds the amount determined under subclause (1), then Genworth will make a Tax Benefit Payment equal to the amount of such excess to GEFAHI.

(F) Any positive or negative Tax Benefit Payment pursuant to Section 9(a)(2)(iii)(D) or (E) will be made in immediately available funds within 30 days after the due date (with extensions) for the Genworth federal income Tax Return for the relevant Taxable Year together with interest from the date that is midway between the first and final Schedule B Dates of such Taxable Year to the date of payment.

(3) For purposes of Section 9(a)(2)(i), actual Tax liability will be determined by taking into account all relevant facts and circumstances including, for avoidance of doubt, any payments made pursuant to this Section 9 or any other provision of this Agreement; provided, however, that (i) any net Tax benefit for such Taxable Year resulting from the items shown in Schedule D attached hereto will not be taken into account; (ii) any change in the tax basis of any asset of any Genworth Company (or any interest deduction) resulting from any payments made under Section 9(b)(2) or (3) for any Taxable Year will not be taken into account; (iii) any change in the tax basis of any asset of any Genworth Company resulting from any compensation paid as described in Section 9(a)(1)(ii) in any Taxable Year will not be taken into account; and (iv) in respect of Florida or Illinois income Tax Returns of any Genworth Company that is an insurance company, the actual income Tax liability for any Taxable Year will be decreased in an amount equal to any actual reduction in Florida or Illinois premium, retaliatory, or similar Tax liability that such Genworth Company obtains at any time as a result of its actual income Tax liability for such Taxable Year, and (v) in respect of any Florida or Illinois income Tax Returns

36

---

of Genworth Companies that are not insurance companies, the actual income Tax liability will be deemed to be equal to zero.

(4) If (i) the cumulative amount of the projected Tax Benefit Payments shown on Schedule B (without taking into account any increase or decrease pursuant to Section 9(c)) to and including any Schedule B Date, exceeds (ii) the cumulative amount of the actual Tax Benefit Payments made by Genworth (less the cumulative amount of any actual negative Tax Benefit Payments made by GEFAHI) as of such date (determined without regard to any payment made pursuant to this Section 9(a)(4) on such date), then Genworth may, in its sole and absolute discretion, make additional Tax Benefit Payments equal to all or any portion of such excess on such date.

(b) (1) For purposes of Section 9(a)(3), the net Tax benefit for any Taxable Year resulting from the items shown on Schedule D will be equal to the excess (if any) of (i) the Tax liability that would have been shown on each Tax Return for such Taxable Year determined without regard to any item shown in Schedule D (and without regard to any hypothetical assumption described in Section 9(a)(1)(i)), over (ii) the sum of (x) the actual Tax liability shown on such Tax Return (determined as provided in Section 9(a)(3) without regard to subdivision (i) thereof), and (y) the costs reasonably incurred by Genworth in realizing such net Tax benefit.

(2) If, for any Taxable Year ending on or prior to the Final Date, the amount determined under Section 9(b)(1)(i) exceeds the amount determined under Section 9(b)(1)(ii), then Genworth will pay an amount equal to 50 percent of such excess to GEFAHI.

37

---

(3) If, for any Taxable Year ending on or prior to the Final Date, the amount determined under Section 9(b)(1)(ii) exceeds the amount determined under Section 9(b)(1)(i), then GEFAHI will pay an amount equal to 50 percent of such excess to Genworth.

(4) Any payment made pursuant to this Section 9(b) will not be considered a "Tax Benefit Payment" or a "negative Tax Benefit Payment" for any purpose of this Agreement. Any such payment will be made in immediately available funds within 30 days after such Tax Return is filed and will be treated as an adjustment to the consideration paid for the Genworth Assets pursuant to Section 2 of the Master Agreement; provided, however, that a portion of any such payment equal to the excess of (i) the amount of such payment, over (ii) the present value of such payment (determined as of the Closing Date by using the Section 12 Rate as the discount rate), or such larger portion as may be required by Section 483, Section 1274, or any other provision of the Code, will be treated as interest.

(c) (1) If (i) the cumulative amount of the projected Tax Benefit Payments shown on Schedule B (taking into account any increase or decrease pursuant to this Section 9(c)) to and including any Schedule B Date exceeds (ii) the sum of (A) the cumulative amount of the actual Tax Benefit Payments made by Genworth pursuant to Section 9(a) and Section 9(d) (less the cumulative amount of any actual negative Tax Benefit Payments made by GEFAHI pursuant to Section 9(a)) as of such date, plus (B) the amount of any additional Tax Benefit Payments made by Genworth pursuant to Section 9(a)(4) on or before such date, then the amount shown on Schedule B for the next Schedule B Date will be increased by an amount equal to interest on such excess at the rate specified in Section 12, compounded on a daily basis, from (but not including) the Schedule B Date for which such excess has been determined to (and including) the

38

---

next subsequent Schedule B Date. Any such increase in the amount shown in Schedule B will not be taken into account for purposes of the last sentence of Section 8(b).

(2) If (i) the amount specified in Section 9(c)(1)(ii) as of any Schedule B Date exceeds (ii) the amount specified in Section 9(c)(1)(i) for such date, then the amount shown on Schedule B for the next Schedule B Date will be decreased by an amount equal to interest on such excess at the rate specified in Section 12, compounded on a daily basis from (but not including) the Schedule B Date for which such excess has been determined to and including the next subsequent Schedule B Date. Any such decrease in the amount shown in Schedule B will not be taken into account for purposes of the last sentence of Section 8(b).

(3) (i) Genworth will maintain (subject to review, adjustment, and approval by GE, which approval will not be unreasonably withheld) a running balance of the aggregate net increase or decrease in the amount shown on Schedule B pursuant to this Section 9(c).

(ii) If there is an aggregate net increase in the amount shown on Schedule B pursuant to this Section 9(c) as of any Schedule B Date (determined without regard to any payment made by Genworth to GEFAHI on such Schedule B Date pursuant to this Section 9(c)(3)(ii)), then Genworth may, in its sole and absolute discretion, make an additional payment to GEFAHI on such Schedule B Date in an amount equal to all or any portion of such aggregate net increase, and the amount shown on Schedule B for such Schedule B Date will be decreased by the amount of such payment. Any such decrease in the amount shown on Schedule B will not be taken into account for purposes of the last sentence of Section 8(b).

39

---

(iii) Genworth will pay to GEFAHI an amount equal to any aggregate net increase in the amount shown on Schedule B pursuant to this Section 9(c) as of the Final Date, or GEFAHI will pay Genworth an amount equal to any aggregate net decrease in the amount shown on Schedule B pursuant to this Section 9(c) as of the Final Date. Any such payment will be made in immediately available funds within 30 days after such Final Date and will be made together with interest at the Section 12 Rate from (but not including) the Final Date to (and including) the date on which such payment is made.

(iv) If Section 9(d)(1) applies in respect of an Acceleration Event, then Genworth will make a payment to GEFAHI equal to any aggregate net increase in the amount shown on Schedule B pursuant to Section 9(c) as of the last Schedule B Date on or prior to the date of the Acceleration Event, or GEFAHI will make a payment to Genworth equal to any aggregate net decrease in the amount shown on Schedule B pursuant to Section 9(c) as of such date. Any such payment will be made by Genworth to GEFAHI (or by GEFAHI to Genworth) in immediately available funds on or before the first Schedule B Date subsequent to the Acceleration Event.

(v) If Section 9(d)(2) or (3) applies in respect of an Acceleration Event, then Genworth will make a payment to GEFAHI equal to the Acceleration Fraction multiplied by any aggregate net increase in the amount shown on Schedule B pursuant to Section 9(c) as of the last Schedule B Date on or prior to the date of the Acceleration Event, or GEFAHI will make a payment to Genworth equal to the Acceleration Fraction multiplied by any aggregate net decrease in the amount shown on Schedule B pursuant to Section 9(c) as of such date. Any such payment will be made by Genworth to GEFAHI (or by GEFAHI to Genworth) in immediately available funds on or before the first Schedule B Date subsequent to the Acceleration Event, and the

40

---

amount shown on Schedule B for such Schedule B Date will be decreased by the amount of such payment. Any such decrease in the amount shown on Schedule B will not be taken into account for purposes of the last sentence of Section 8(b).

(vi) Any payment made pursuant to this Section 9(c)(3) will not be considered a "Tax Benefit Payment" for any purpose of this Agreement. Any such payment will be treated as a payment with respect to the debt instrument described in Section 9(f).

(d) (1) Subject to Section 9(d)(5), if there is an Acceleration Event of Genworth, then Genworth will make a Tax Benefit Payment to GEFAHI equal to the total present value of all amounts shown on Schedule B (determined without regard to any increase or decrease pursuant to Section 9(c)) for each Schedule B Date subsequent to the date of the Acceleration Event.

(2) Subject to Section 9(d)(5), if there is an Acceleration Event of any Genworth Company other than Genworth, then (except as provided in Section 9(d)(3)) Genworth will make a Tax Benefit Payment to GEFAHI equal to the product of (i) the amount determined pursuant to Section 9(d)(1), and (ii) a fraction (the "Acceleration Fraction") whose numerator is equal the present value of all amounts shown on Schedule B (determined without regard to any increase or decrease pursuant to Section 9(c)) attributable to such Genworth Company for each Schedule B Date subsequent to the date of the Acceleration Event, and whose denominator is equal to the total present value of all amounts shown on Schedule B (determined without regard to any increase or decrease pursuant to Section 9(c)) for all such subsequent Schedule B Dates.

41

---

(3) If there is an Acceleration Event of any Genworth Company other than Genworth, then Section 9(d)(2) will not apply if all of the following conditions are satisfied prior to the first Schedule B Date subsequent to such Acceleration Event: (i) Genworth notifies GE in writing that it has irrevocably elected to have this Section 9(d)(3) apply; (ii) such Genworth Company (or any Person that has acquired Control of such Genworth Company) agrees in writing to become obligated to pay the Acceleration Fraction of all amounts shown on Schedule B (determined without regard to any increase or decrease under Section 9(c)) for each Schedule B Date subsequent to the Acceleration Date; (iii) such agreement is in form and substance reasonably satisfactory to GE; and (iv) no credit rating of such Genworth Company (or other Person becoming obligated pursuant to Section 9(d)(3)(ii)) is less than the corresponding credit rating of Genworth at the time of such Acceleration Event, or the credit standing of such Genworth Company (or other Person) is otherwise acceptable to GE.

(4) If there has been an Acceleration Event of any Genworth Company, then (for all purposes of this Agreement) the Taxable Year of such Genworth Company will be deemed to end on the date of such Acceleration Event, and, if the payment described in Section 9(d)(1) or 9(d)(2) is made or the conditions of Section 9(d)(3) are satisfied, Section 9(a)(1) will not apply to any Tax Return filed by such Genworth Company for any Taxable Year beginning after the date of such Acceleration Event. For purposes of this Section 9(d), present value will be determined as of the date of the Acceleration Event by using the interest rate specified in Section 12, compounded on a daily basis, as the discount rate. Any Tax Benefit Payment (or negative Tax Benefit Payment) pursuant to this Section 9(d) will be made by Genworth to GEFAHI

42

---

(or by GEFAHI to Genworth) in immediately available funds on or before the first Schedule B Date subsequent to such Acceleration Event.

(5) The payments described in Sections 9(d)(1) and 9(d)(2) shall not be made without approval of the domiciliary state insurance regulatory authorities of each of the U.S. insurance subsidiaries of Genworth, which approvals shall be within the sole discretion of such regulatory authorities. Genworth shall use its reasonable best efforts to obtain such regulatory approvals.

(e) If as of the Final Date (1) the cumulative amount of all projected Tax Benefit Payments shown on Schedule B (without taking into account any increase or decrease pursuant to Section 9(c)) exceeds (2) the cumulative amount of the actual Tax Benefit Payments made by Genworth pursuant to Section 9(a) and (d) (less the cumulative amount of the actual negative Tax Benefit Payments made by GEFAHI pursuant to Section 9(a) and (d)), then Genworth will make a Tax Benefit Payment equal to the amount of such excess to GEFAHI; provided, however, that if the amount determined under clause (2) of this Section 9(e) exceeds the amount determined under clause (1) of this Section 9(e), then GEFAHI will make a negative Tax Benefit Payment equal to the amount of such excess to Genworth. Any such Tax Benefit Payment will be made by Genworth to GEFAHI (or by GEFAHI to Genworth) in immediately available funds within 30 days after such Final Date and will be made together with interest at the Section 12 Rate from (but not including) the last Schedule B Date to (and including) the date on which such Tax Benefit Payment is made.

43

---

(f) The Tax Benefit Payments to be made pursuant to this Section 9, together with any other payments to be made by Genworth pursuant to Section 9(c), will be treated for income tax purposes, including on Schedule A and Schedule B (without duplication), as a debt instrument described in Treas. Reg. § 1.1272-1(c)(2) issued to GEFAHI as part of the consideration paid for the Genworth Assets pursuant to Section 2 of the Master Agreement. Such debt instrument will be treated as bearing interest at the Section 12 Rate, or at such greater rate as may be required by Section 1274 or any other provision of the Code.

(g) For each Taxable Year beginning after the Closing Date and prior to the Final Date, the Chief Financial Officer of Genworth will provide to GEFAHI a certification to the effect that all computations made pursuant to this Agreement have been made without regard to any transaction a significant purpose of which is to reduce or defer any amount payable by Genworth pursuant to this Section 9. If the Chief Financial Officer of Genworth determines that it is necessary to adjust any computations made pursuant to this Agreement in order to provide the certification required by the preceding sentence, then such Chief Financial Officer will be permitted to make such adjustments in a manner reasonably acceptable to GE.

44

---

**SECTION 10. Subordination.** Notwithstanding any other provision of this Agreement to the contrary, any Tax Benefit Payment (together with any interest thereon or other Schedule B amount due) required to be made by Genworth to GEFAHI pursuant to Section 9 of this Agreement will rank subordinate and junior in right of payment to any principal, interest, or other amounts due and payable in respect of any debt or other liabilities of Genworth (collectively, the "Outstanding Obligations"). Accordingly, in the event that Genworth has insufficient funds on the date any Tax Benefit Payment (together with any interest thereon or other Schedule B amount due) is required to be made hereunder to pay in full both (a) the Outstanding Obligations due and payable on such date and (b) the Tax Benefit Payment due and payable on such date (together with any interest thereon or other Schedule B amount due), Genworth may forego payment of such Tax Benefit Payment (together with any interest thereon or other Schedule B amount due) on such date, but only to the extent necessary to pay in full the Outstanding Obligations due and payable on such date; provided, however, that the amount of any Tax Benefit Payment (together with any interest thereon or other Schedule B amount due) foregone pursuant to this sentence will carry over and be payable by Genworth to GEFAHI (together with any interest thereon) at such time as, and to the extent that, Genworth's available funds exceed the amount necessary to pay in full its Outstanding Obligations due and payable at such time.

45

---

**SECTION 11. Other Tax Sharing Agreements.** All rights and obligations of GE and its Affiliates (with respect to the Genworth Companies) and of the Genworth Companies (with respect to GE and its Affiliates) to make or receive any Tax sharing payments (other than pursuant to this Agreement) will terminate immediately prior to Closing; provided, however, that notwithstanding Section 7(a)(1), (a) the GECA Tax Allocation Agreement will remain in effect as to UFLIC pursuant to Section 5 of such Agreement for each Taxable Year in which UFLIC was included in the GECA Affiliated Group, (b) the GEFAHI Tax Allocation Agreement will remain in effect as to each Genworth Company that was a party thereto pursuant to Section 5 of such Agreement for each Taxable Year in which such Genworth Company was included in the GE Affiliated Group, (c) the GECC Tax Allocation Agreement will remain in effect as to each Genworth Company that was a party thereto pursuant to Section VII of such Agreement for each Taxable Year in which such Genworth Company was included in the GE Affiliated Group; and provided, further, that the amount payable by or to any Genworth Company pursuant to the GECA Tax Allocation Agreement, the GEFAHI Tax Allocation Agreement, or the GECC Tax Allocation Agreement will be determined without taking into account any Transaction Taxes (determined for purposes of this proviso without regard to Section 3(a)(2)(ii)(A) and (B)).

46

---

**SECTION 12. Interest.** In the event that any payment required to be made under this Agreement is made after the date on which such payment is due, interest will accrue on the amount of such payment from (but not including) the due date of such payment to (and including) the date such payment is actually made at [specify rate equal to Genworth's cost funds at Closing determined with reference to compounding on a daily basis], compounded on a daily basis; provided, however, that no interest will accrue pursuant to this Section 12 to the extent that such interest would be duplicative of interest payable under Section 9(b).

47

---

**SECTION 13. Adjustments.** (a) If any adjustment (other than any adjustment to which Section 5(b) applies) is made to any income, deduction, gain, loss, credit, or other item, as the result of any amended return, audit, or otherwise, and the amount of any payment required under this Agreement would have been different if such adjustment had been made at the time the amount of such payment was determined, then GE or GEFAHI will make a payment to Genworth equal to the amount of any such difference that was detrimental to Genworth or its Affiliates (or Genworth will pay GE or GEFAHI the amount of any such difference that was detrimental to GE or GEFAHI or its Affiliates). Any such payment (an "Adjustment Payment") will be made within 30 days after such adjustment becomes final together with interest at the Section 12 Rate from (but not including) the date of the original payment to (and including) the date such payment is actually made; provided, however, that in the case of any such adjustment for any Taxable Year that results from the carryback of any net operating loss or other Tax Attribute from any subsequent Taxable Year, such Adjustment Payment will be made together with interest at the Section 12 Rate from (but not including) the date on which the relevant Tax Return is filed for such subsequent Taxable Year to (and including) the date such payment is actually made. Any Adjustment Payment (exclusive of interest) which represents an adjustment to a prior Tax Benefit Payment or negative Tax Benefit Payment will be treated as a Tax Benefit Payment or negative Tax Benefit Payment, as the case may be.

(b) If GE makes a Life/Non-Life Election for any Taxable Year beginning on or prior to January 1, 2004, then GEFAHI will pay to Genworth an amount equal to (1) the excess (if any) of the actual net aggregate Tax liability incurred by the Genworth Companies for such Taxable Year and each subsequent Taxable Year ending on or before the Final Date, over (2) the

48

---

amount of such aggregate net Tax liability incurred by the Genworth Companies determined as if such Life/Non-Life Election had not been made; provided, however, that if the amount determined under subparagraph (2) exceeds the amount determined under subparagraph (1), then Genworth will make a payment equal to the amount of such excess to GEFAHI. Any amount payable under this Section 13(b) in respect of any Taxable Year will be made in immediately available funds within 30 days after the date on which the Genworth federal income tax return is filed for such Taxable Year.

(c) If (1) the amount determined with respect to any Genworth Company under Section 3(a)(2)(i)(B) exceeds (2) the amount determined with respect to such Genworth Company under Section 3(a)(2)(i)(A), then Genworth will pay an amount equal to such excess to GE. Any amount payable under this Section 13(c) will be made in immediately available funds within 30 days after the date on which the Genworth federal income tax is filed for the Taxable Year in which the Closing occurs.

(d) If (1) the amount determined under Section 1(j)(2), exceeds (2) the amount determined under Section 1(j)(1), then Genworth will pay an amount equal to such excess to GE. Any amount payable under this Section 13(d) will be made in immediately available funds within 30 days after the date on which the Brookfield federal income Tax return is filed for the Taxable Year ending December 31, 2003.

(e) If (1) any Genworth Company recognizes any loss on a Transaction, and (2) the loss is deferred under Section 267(f) of the Code (other than any such loss to which GE or any Affiliate of GE (other than any Genworth Company) succeeds under Section 381 of the

49

---

Code), then Genworth will pay an amount equal to 35% of such loss to GE. Any amount payable under this Section 13(e) will be made in immediately available funds within 30 days after the date on which the Genworth federal income Tax return is filed for the Taxable Year in which such Transaction occurs. For the avoidance of doubt, this Section 13(e) will not apply to any loss recognized pursuant to a Reinsurance Transaction.

(f) Any amount paid pursuant to Section 13(b), (c), (d), or (e) will be treated as an adjustment to the consideration paid for the Genworth Assets pursuant to Section 2 of the Master Agreement; provided, however, that a portion of any such payment equal to the excess of (1) the amount of such payment, over (2) the present value of such payment (determined as of the Closing Date by using the Section 12 Rate as the discount rate), or such larger portion as may be required by Section 483, Section 1274, or any other provision of the Code, will be treated as interest.

50

---

**SECTION 14. No Duplicative Payments.** No duplicative payment of interest or any other amount will be required under this Agreement.

51

---

**SECTION 15. Tax Cooperation.** (a) Under this Agreement and the Transition Services Agreement, GE and Genworth will furnish or cause to be furnished to each other, upon request, as promptly as practicable, such information and assistance relating to the Genworth Companies and the Genworth Business (including access to books and records) as is reasonably necessary for the filing of all Tax Returns, the making of any election related to Taxes, the preparation for any audit by any Taxing Authority, and the prosecution or defense of any claim, suit or proceeding relating to any Taxes or Tax Return. GE and Genworth will cooperate with each other in the conduct of any audit or other proceeding related to Taxes and all other Tax matters relating to the Genworth Companies and the Genworth Business, and each will execute and deliver such powers of attorney and other documents as are necessary to carry out the intent of this Agreement. The party requesting cooperation under this Section 15 will reimburse the other party for any actual out-of-pocket expenses incurred in furnishing such cooperation, except that the amount of reimbursement for any services governed by the Transition Services Agreement for the time period specified therein shall be determined by that agreement. All Tax records relating to the Genworth Business will be retained for at least seven (7) years after such records are created.

(b) Pursuant to the Transition Services Agreement, for the time period specified therein, the GE Parties will provide to Genworth and GNA certain tax consulting, tax compliance, tax related-software, and other tax-related services (the "GE Tax Services") as set forth in Schedule A of the Transition Services Agreement. Further, for the time period specified in the Transition Services Agreement and as set forth in Schedule B of the Transition Services Agreement, Genworth and GNA will provide to the GE Parties certain tax-related services (the "Genworth

52

---

Tax Services"). This Agreement incorporates the provisions of the Transition Services Agreement relating to the GE Tax Services and the Genworth Tax Services. Any dispute relating to the performance of the GE Tax Services and the Genworth Tax Services or the fees payable for such services will be governed by the provisions of the Transition Services Agreement.

(c) Unless there has previously been a Final Determination to the contrary, neither Genworth nor any of its Affiliates will take any position with respect to Taxes (including on any Tax Return or in connection with any Tax controversy) for any Taxable Year that is inconsistent with (1) any allocation shown on the Final Allocation Schedule, (2) any election made pursuant to Section 8, or (3) the treatment of any payment made pursuant to Section 9 as provided in this Agreement; provided, however, that Genworth will not be required to take any position if (A) Genworth obtains, at its sole cost and expense, an opinion of nationally recognized tax counsel mutually acceptable to Genworth and GE, to the effect that there is no "substantial authority," within the meaning of Section 6662 of the Code, for such position, and (B) such opinion is reasonably satisfactory in form and substance to GE.

(d) GE and Genworth will promptly provide to the other a copy of any written communication from or with the IRS or any other Taxing Authority that relates in any respect to the treatment of the Acquisition or any related transaction (including any communication that relates to the allocation shown on the Final Allocation Schedule).

53

---

**SECTION 16. Resolution of Disputes.** If any dispute arises between the parties hereto with respect to this Agreement, then, except as provided in Section 15(b), such dispute will be finally resolved by arbitration in which the sole arbitrator will be a person or firm chosen mutually by GE and Genworth. If GE and Genworth are unable to agree on such a person or firm, then each will designate one person and the two persons so designated will choose a third person or firm that will be the sole arbitrator. The parties expressly waive and forego any right to (a) punitive, exemplary, statutorily-enhanced, or similar damages in excess of compensatory damages, and (b) trial by jury. The parties agree to use commercially reasonable efforts to resolve any arbitration within 30 days of the initiation of arbitration. Any arbitration proceeding will take place in New York, New York unless the parties mutually agree to another location. The parties agree that no appeal will lie from the arbitration award, that they will not challenge the award for any reason in any court, and that the arbitration award will have the force and effect of a judgment as if a court having jurisdiction thereof has entered judgment on the award. The arbitration will be governed by the Federal Arbitration Act, 9 U.S.C. §§ 1-16. The parties expressly agree that this dispute

resolution procedure governs disputes arising under this Agreement and that it supersedes dispute resolution provisions contained in any other Transaction Documents, including the Master Agreement.

54

**SECTION 17. Survival.** Except to the extent inconsistent with applicable law, the indemnity and payment obligations set forth in this Agreement will survive until the date which is six months after the date of expiration of the applicable statute of limitations (including any extensions thereof). The right to indemnification with respect to claims of which notice was given prior to the expiration of the applicable survival period will survive such expiration until such claim is finally resolved and any obligations with respect thereto are fully satisfied.

55

**SECTION 18. Amendment.** No provision of this Agreement may be waived, amended or modified except by a written instrument signed by the GE Parties and Genworth.

56

**SECTION 19. Transfer and Similar Taxes.** All stock transfer, real estate transfer, documentary, stamp, recording, ad valorem, and other similar Taxes arising out of, in connection with or attributable to the Transactions and incurred by any of the parties thereto will be borne and paid by GE. Genworth will use its reasonable best efforts to secure, and to cause its Affiliates to secure, any available exemptions from any such Taxes and to cooperate with GE in providing any information and documentation that may be necessary to obtain such exemptions.

57

**SECTION 20. Additional Provisions.** Provisions of the Master Agreement that apply (*mutatis mutandis*) to this Agreement include only Sections 8.1 (Corporate Power; Fiduciary Duty); 8.2 (Governing Law); 8.3 (Survival of Covenants); 8.5 (Notices); 8.6 (Severability); 8.7 (Entire Agreement); 8.8 (Assignment; No Third-Party Beneficiaries); 8.9 (Public Announcements); 8.10 (Amendment); 8.11 (Rules of Construction); and 8.12 (Counterparts).

58

IN WITNESS WHEREOF, this Agreement has been duly executed on the day and year first above written.

GENERAL ELECTRIC COMPANY

GENERAL ELECTRIC CAPITAL CORPORATION

By: \_\_\_\_\_  
Name:  
Title:

By: \_\_\_\_\_  
Name:  
Title:

GEI, INC.

GE FINANCIAL ASSURANCE HOLDINGS, INC.

By: \_\_\_\_\_  
Name:  
Title:

By: \_\_\_\_\_  
Name:  
Title:

GENWORTH FINANCIAL, INC.

By: \_\_\_\_\_  
Name:  
Title:

Annex A

**ELECTION STATEMENT**

This Election Statement is made this day of , 2003, among , a corporation (the "Ceding Company"), and , a corporation ("Reinsurer").

Unless otherwise indicated, all capitalized terms used herein shall have the same meaning as in the [Assumption/Indemnity] Reinsurance Agreement by and between the Ceding Company and Reinsurer dated as of , 2003 (the "Reinsurance Agreement").

1. The Ceding Company and Reinsurer hereby make a joint election under Treasury Regulation § 1.848-2(g)(8) (the "Joint Election") with respect to the Reinsurance Agreement.
2. The Ceding Company and Reinsurer hereby agree to include this Election Statement as an Addendum to the Reinsurance Agreement.
3. The Ceding Company and Reinsurer hereby agree that the party with net positive consideration for the Reinsurance Agreement for each Taxable Year



will capitalize specified policy acquisition expenses with respect to the Reinsurance Agreement without regard to the general deductions limitation of Section 848(c)(1) of the Code.

4. The Ceding Company and Reinsurer hereby agree to exchange all necessary information pertaining to the amount of net consideration under the Reinsurance Agreement each year to ensure consistency.

5. The Ceding Company will submit a schedule to Reinsurer by [ ] of each year, of its calculation of the net consideration for the preceding calendar year. This schedule of calculations will be accompanied by a statement signed by one of the Ceding Company's officers stating that such net consideration will be reported on any United States federal income Tax Return filed with respect to the Ceding Company for the preceding calendar year.

6. Reinsurer may contest such calculation by providing an alternative calculation to the Ceding Company by [ ]. If Reinsurer does not so notify the Ceding Company the net consideration as determined by the Ceding Company will be reported on any United States federal income Tax Returns filed with respect to the Ceding Company or Reinsurer for the preceding calendar year.

7. If Reinsurer contests the Ceding Company's calculation of the net consideration, the parties will act in good faith to reach an agreement as to the correct amount by [date]. If the Ceding Company and Reinsurer reach agreement on an amount of the net consideration, such amount shall be reported on any United States federal income Tax Returns filed with respect to the Ceding Company or Reinsurer for the previous calendar year.

8. The Ceding Company and Reinsurer hereby agree that the first Taxable Year for which the Joint Election is effective is the Taxable Year ending [December 31, 2004].

9. Reinsurer represents and warrants that it is subject to United States taxation within the meaning of Treasury Regulation Section 1.848-2(h).

A-2

IN WITNESS WHEREOF, this Election Statement has been duly executed on the day and year first above written.

[CEDING COMPANY]

By: \_\_\_\_\_  
Name:  
Title:

[REINSURER]

By: \_\_\_\_\_  
Name:  
Title:

A-3

**Annex B**

**ELECTION STATEMENT**

This Election Statement is made this day of , 2004 between GE Financial Assurance Holdings, Inc., a Delaware corporation ("GEFAHI"), and , a corporation (the "Company").

WHEREAS, pursuant to the Master Agreement dated as of , 2003 among the General Electric Company, a New York corporation ("GE"), General Electric Capital Corporation, a Delaware corporation ("GECC"), GEI, Inc., a Delaware corporation ("GEI"), GE Financial Assurance Holdings, Inc., a Delaware corporation ("GEFAHI", and collectively with GE, GEI, and GECC, the "GE Parties"), and Genworth Financial, Inc., a Delaware corporation ("Genworth") (the "Master Agreement"), Genworth has agreed, on the terms and subject to the conditions set forth in the Master Agreement, to acquire (the "Acquisition"), directly or indirectly, all the outstanding shares of stock of certain subsidiaries of GE (such subsidiaries, together with Genworth, the "Genworth Companies") in a transaction that will constitute (as to certain of such Genworth Companies) a qualified stock purchase within the meaning of Section 338(d)(3) of the Code.

WHEREAS, pursuant to the Tax Matters Agreement dated as of among the GE Parties and Genworth (the "GE-Genworth TMA"), GE and Genworth have

agreed to make a Section 338(h)(10) election with respect to the Company in connection with the Acquisition (the "Section 338 Election").

WHEREAS, in accordance with the Section 338 Election, the Company as of the Closing Date ("Old Company") was treated as if it transferred all of its assets and liabilities, including its insurance contracts, to a new Company and then liquidated.

WHEREAS, pursuant to the GE-Genworth TMA, GE and Genworth have agreed to treat the deemed transfer of insurance contracts pursuant to the Section 338 Election as a deemed assumption reinsurance transaction (the "Deemed Reinsurance Transaction") for federal income tax purposes in accordance with proposed Treas. Reg. § 1.338-11.

WHEREAS, GEFAHI, on behalf of Old Company, and Company wish to make an election under Treas. Reg. § 1.848-2(g) requiring the Company to capitalize specified policy acquisition expenses with respect to the Deemed Reinsurance Transaction without regard to the general deductions limitation (the "Section 848 Election").

WHEREAS, there is no actual reinsurance agreement in which the Section 848 Election may be made with respect to the Deemed Reinsurance Transaction,

and the parties to this Election Statement intend that, with respect to the Deemed Reinsurance Transaction, this Election Statement be included as an addendum to the transaction documents in accordance with Treas. Reg. § 1.848-2(g)(8)(ii).

B-2

---

NOW THEREFORE, in consideration of the foregoing and of the mutual promises, covenants, and conditions contained in the Election Statement, the parties to this Election Statement agree as follows:

1. Unless otherwise indicated, all capitalized terms used herein shall have the same meaning as in the GE-Genworth TMA.
2. GEFAHI, as successor in interest to Old Company, and the Company hereby make a joint election under Treasury Regulation § 1.848-2(g)(8) (the "Joint Election") with respect to the Deemed Reinsurance Agreement.
3. GEFAHI and the Company hereby agree that the Company will capitalize specified policy acquisition expenses with respect to the Deemed Reinsurance Transaction without regard to the general deductions limitation of Section 848(c)(1) of the Code.
4. GEFAHI and the Company hereby agree to exchange all necessary information pertaining to the amount of net consideration with respect to the Deemed Reinsurance Transaction to ensure consistency.
5. GEFAHI and the Company hereby agree that the first Taxable Year for which the Joint Election is effective is the Taxable Year ending on the Closing Date.
6. The Company represents and warrants that it is subject to United States taxation within the meaning of Treas. Reg. § 1.848-2(h).

B-3

---

IN WITNESS WHEREOF, this Election Statement has been duly executed on the day and year first above written.

GE FINANCIAL ASSURANCE HOLDINGS, INC.

By: \_\_\_\_\_  
Name:  
Title:

[THE COMPANY]

By: \_\_\_\_\_  
Name:  
Title:

B-4

---

## EMPLOYEE MATTERS AGREEMENT

THIS EMPLOYEE MATTERS AGREEMENT (this "Agreement") is executed effective as of \_\_\_\_\_, 2004, by and among GENERAL ELECTRIC COMPANY, a New York corporation ("GE"), GENERAL ELECTRIC CAPITAL CORPORATION, a Delaware corporation ("GECC"), GEI, Inc., a Delaware corporation ("GEI"), GE FINANCIAL ASSURANCE HOLDINGS, INC., a Delaware corporation ("GEFAHI"), and GENWORTH FINANCIAL, INC., a Delaware corporation ("Genworth").

### Statement of Background Information

WHEREAS, GE, GECC, GEI, GEFAHI and Genworth have entered into a Master Agreement, dated \_\_\_\_\_, 2004 (the "Master Agreement"); and

WHEREAS, it is contemplated by the parties that, for a period of time described herein, commencing on the Closing Date and ending on the Trigger Date, GE will continue to cover or cause to be covered as set forth herein the applicable employees of the Genworth Group in the benefit plans and programs and payroll procedures maintained by the GE Group; and

WHEREAS, it is contemplated by the parties that, for a period of time described herein, Genworth shall, or shall cause one of its Affiliates to, provide compensation and employee benefits to the employees of the Genworth Group as set forth herein; and

WHEREAS, the parties desire to set forth in writing the terms and conditions pursuant to which this Agreement will operate and thereby supplement the provisions of the Master Agreement.

### Agreement

NOW, THEREFORE, in consideration of the promises and mutual covenants set forth in the Master Agreement and herein, and other good and valuable consideration, and contingent upon the Closing, the parties hereby agree as follows:

## ARTICLE I

### DEFINITIONS

For the purposes of this Agreement, unless otherwise noted, capitalized terms shall have the respective meanings specified below:

"Affiliate" shall have the meaning ascribed to such term in the Master Agreement.

"Agreement" shall have the meaning ascribed to such term in the preamble hereto, as amended or supplemented from time to time in accordance with the terms hereof.

"Closing" shall have the meaning ascribed to such term in the Master Agreement.

"Closing Date" shall have the meaning ascribed to such term in the Master Agreement.

"COBRA" shall mean the continuation coverage requirements under Section 4980B of the Code and Part 6 of Subtitle B of Title I of ERISA.

"Code" shall mean the Internal Revenue Code of 1986, as amended from time to time, any successor statute thereto and all applicable regulations promulgated thereunder.

"Company" shall mean (i) prior to and on the Closing, each Subsidiary of GE listed on Schedule 2.2(a)(ii)(B) of the Master Agreement and each entity held by GE listed on Schedule 2.2(a)(ii)(C) of the Master Agreement and (ii) immediately after the Closing, each member of the Genworth Group.

"Company Employees" shall have the meaning ascribed to such term in Section 3.01 hereof.

"Company Plan Services" shall have the meaning ascribed to such term in Section 6.02 hereof.

"Company Plans" shall mean all "employee benefit plans" as defined in Section 3(3) of ERISA and all other benefit or compensation plans, programs, policies, and arrangements sponsored by the Company and covering the Employees, and shall include, on and following the Closing Date, the Genworth Equity and Long-Term Performance Award Plan described in Section 5.01 hereof.

"Conversion Ratio" shall have the meaning ascribed to such term in Section 5.02(b) hereof.

"Employees" shall have the meaning ascribed to such term in Section 3.01 hereof.

"ERISA" shall mean the Employee Retirement Income Security Act of 1974, as amended from time to time, any successor statute thereto and all applicable regulations thereunder.

"European Creditor Business Entity" shall mean the entities set forth on Schedule 2.9 of the Master Agreement.

"European Transition Services Agreement" shall have the meaning ascribed to such term in the Master Agreement.

"Excluded Employee Liabilities" shall have the meaning ascribed to such term in Article II hereof.

"FIGSL" shall mean Financial Insurance Group Service Limited.

"GE" shall have the meaning ascribed to such term in the preamble hereto.

"GE Group" shall have the meaning ascribed to such term in the Master Agreement.

“GE Payroll and Plan Services” shall have the meaning ascribed to such term in Section 6.01 hereof.

“GE Plans” shall mean all “employee benefit plans” as defined in Section 3(3) of ERISA and all other benefit or compensation plans, programs, policies, and arrangements, including workers’ compensation, sponsored by GE or its Affiliate (other than a Company) and of which the Company is a participating employer, but shall not include any Company Plan.

“GE Retirement Plans” shall mean the GE Pension Plan, GES&SP, GE Excess Benefits Plan and GE Supplementary Pension Plan.

“GECC” shall have the meaning ascribed to such term in the preamble hereto.

“GEFAHI” shall have the meaning ascribed to such term in the preamble hereto.

“GEI” shall have the meaning ascribed to such term in the preamble hereto.

“GEIH Business” shall have the meaning ascribed to such term in Section 3.02 hereof.

“GEIH Business Employees” shall have the meaning ascribed to such term in Section 3.02 hereof.

“Genworth” shall have the meaning ascribed to such term in the preamble hereto.

“Genworth Business” shall have the meaning ascribed to such term in the Master Agreement.

“Genworth Equity and Long-Term Performance Award Plan” shall have the meaning ascribed to such term in Section 5.01 hereof.

“Genworth 401(k) Plan” shall have the meaning ascribed to such term in Section 7.03(e) hereof.

“Genworth Group” shall have the meaning ascribed to such term in the Master Agreement.

“Genworth Plan” shall have the meaning ascribed to such term in Section 7.03(a) hereof.

“Genworth Plan Services” shall have the meaning ascribed to such term in Section 7.04(d)(ii) hereof.

“GES&SP” shall mean the GE Savings and Security Program.

“International Benefit Transition Date” shall mean, with respect to the International Employees, the Trigger Date, unless another date has been mutually agreed to in writing by GE and Genworth, but shall in no event be later than the date that is six (6) months after the Trigger Date.

3

---

“International Employees” shall mean Employees who are assigned to operations outside of the United States.

“International Plan” shall have the meaning ascribed to such term in Section 7.04(b) hereof.

“Law” shall have the meaning ascribed to such term in the Master Agreement.

“Liabilities” shall have the meaning ascribed to such term in the Master Agreement.

“Master Agreement” shall have the meaning set forth in the preamble hereto.

“Mortgage Services Agreement” shall have the meaning ascribed to such term in the Master Agreement.

“Person” shall have the meaning ascribed to such term in the Master Agreement.

“Pricing Date” shall mean the date on which the Underwriting Agreements (as defined in the Master Agreement) are executed and delivered by each of the parties thereto.

“Restricted Employees” shall have the meaning ascribed to such term in Section 9.04 hereof.

“Subsidiary” shall have the meaning ascribed to such term in the Master Agreement.

“Term” shall mean the period commencing on the Closing Date and ending on (i) the Trigger Date or (ii) in the case of the International Employees, the International Benefit Transition Date.

“Transferred Employees” shall have the meaning ascribed to such term in Section 3.01 hereof.

“Transition Services Agreement” shall have the meaning ascribed to such term in the Master Agreement.

“Trigger Date” shall have the meaning ascribed to such term in the Master Agreement.

“U.S. Employees” shall mean Employees assigned to operations in the United States.

## ARTICLE II

### ASSUMPTION OF CERTAIN OBLIGATIONS AND LIABILITIES

Effective as of the Closing Date, Genworth shall, or shall cause one of its Affiliates to, assume or retain, as the case may be, any and all Liabilities (contingent or otherwise) relating to, arising out of or resulting from the employment or services, or termination of employment or services, of any Person with respect to the Genworth Business, whenever arising, including, but not limited to, any Liabilities relating to, arising out of or resulting from (i) the Company Plans and (ii) each of the individual employment, termination, retention, severance or other similar

4

---

contracts or agreements that relates to an Employee (whether or not such Employee is located in the United States); except that, Genworth or, if applicable, its Affiliate (1) shall not assume or retain the Liabilities related to the GE Plans, except to the extent such assumptions, retentions or the obligation to make periodic payments under such plans is described elsewhere in this Agreement, (2) shall not assume or retain the Liabilities solely attributable to the acts or omissions of the GE Group pertaining to payroll administration and/or payroll systems services provided by or on behalf of the GE Group prior to the Trigger Date (excluding attorney fees and costs respecting pending litigation, unless such fees and costs are attributable solely to payroll administration and/or payroll systems services provided by or on behalf of the GE Group prior to the Trigger Date), and (3) shall not assume or retain the Liabilities related to the current and former GEIH Business Employees, other than any Liabilities arising prior to the Closing Date which would be allocated to Genworth or one of its Affiliates consistent with past practices and procedures or which are solely attributable to the acts or omissions of Genworth or any of its Affiliates independent of GE and any of its Affiliates. Such exceptions in (1), (2) and (3) are collectively referred to as “Excluded Employee Liabilities”. For purposes of this Article II, any legal entity whose assets and liabilities are to be transferred to the Genworth Group on the Closing Date shall be deemed excluded from the GE Group.

## ARTICLE III

### EMPLOYMENT

**Section 3.01. Employees.** As of the Closing Date (or as soon as possible thereafter as permitted by the Laws of any country other than the United States), (i) Genworth shall, or shall cause its applicable Affiliates to, continue to employ as a successor employer all of the employees (including statutory employees) of the Companies (other than the GEIH Business Employees described below), including all such employees who have rights of employment on return from any leave or other absence (all such employees hereinafter referred to as “Company Employees”), and (ii) GE shall, or shall cause its applicable Affiliates (other than the Companies) to, transfer all employees not employed by the Companies but assigned to the Genworth Business, including all such employees who have rights of employment on return from any leave or other absence (all such employees hereinafter referred to as “Transferred Employees”) and Genworth shall, or shall cause its applicable Affiliates to, employ as a successor employer the Transferred Employees. For purposes of this Agreement, (i) all Company Employees, (ii) all Transferred Employees, and (iii) those individuals hired after the Closing Date by the Genworth Business shall collectively be referred to as “Employees.” Any Liabilities relating to Transferred Employees shall be deemed to be Liabilities of Genworth for all purposes with effect from the Closing Date notwithstanding the fact that certain Transferred Employees shall only be transferred following the Closing Date as permitted by the Laws of any country other than the United States. As of the Closing Date (or as soon as possible thereafter as permitted by the Laws of any country other than the United States), Genworth also agrees, or shall cause its applicable Affiliates, to assume the obligations of any works council agreement covering the Employees employed by the Companies outside of the United States. Notwithstanding the foregoing, any employee who is employed by GEI and assigned to the Genworth Business on or after the Closing Date shall become an Employee on the Trigger Date.

5

**Section 3.02. GEIH Business Employees.** The parties note that pursuant to Section 3.6 of the Master Agreement, Genworth shall cause FIGSL to transfer the Excluded Assets, Excluded Contracts and Excluded Liabilities relating to the businesses or the support of the businesses of the members of the GEIH Group (as defined in the European Transition Services Agreement but for the purposes of this Section excluding any European Creditor Business Entity) (the “GEIH Business”) as of the Closing Date. Accordingly, by operation of Law, the contracts of employment of all employees of FIGSL who work primarily for or primarily in support of the GEIH Business, except for those employees who provide support to the GEIH Business solely by virtue of FIGSL’s obligations pursuant to the European Transition Services Agreement, including all such employees who have rights of employment on return from any leave or other absence (all such employees hereinafter referred to as “GEIH Business Employees”), shall be transferred to the GE Affiliates assuming the relevant Excluded Assets, Excluded Contracts and Excluded Liabilities (in each case as defined in the Master Agreement) relating to the GEIH Business with effect from the Closing Date. To the extent that any contract of employment of the GEIH Business Employees is not transferred by operation of Law, GE shall cause the appropriate GE Affiliate to issue formal offers of employment to any such GEIH Business Employees. Any such offer of employment to a GEIH Business Employee shall be made on terms and conditions identical to such employee’s previous terms and conditions of employment with FIGSL, and such employee’s period of continuous employment with FIGSL shall count as part of such employee’s period of continuous employment with the relevant GE Affiliate. The effective date of any new contracts of employment resulting from any such offers and issued pursuant to this Section 3.02 shall be the Closing Date.

## ARTICLE IV

### PAYROLL; BENEFITS

**Section 4.01. Payroll.** During the Term, for those Employees who are paid through GE’s or one of its Affiliate’s payroll system immediately prior to the Closing Date, such Employees shall continue to be paid through GE’s or one of its Affiliate’s payroll system. Those applicable Employees who are hired after the Closing Date by the Genworth Business shall also be paid through GE’s or one of its Affiliate’s payroll system during the Term. For those Employees with payroll withholding elections (such as those related to income taxes, qualified retirement plans, group health and welfare plans, etc.) in effect immediately prior to the Closing Date, such Employees’ elections shall remain the same during the Term as such elections were as of the Closing Date, except to the extent an Employee elects (in a manner permitted to employees and plan participants generally) to change any such election.

**Section 4.02. GE Plans.** During the Term, for those Employees who are eligible to participate in the GE Plans immediately prior to the Closing Date (or who would become eligible upon meeting certain eligibility requirements or upon satisfaction of any waiting periods under such plans), such Employees shall continue to be eligible to participate in such GE Plans, including the General Electric International Employee Stock Purchase Plan and any comparable arrangements (but excluding any GE Plan providing for cash or other bonus awards, stock options, stock awards, restricted stock, other equity-related awards or long-term performance awards other than the GE Incentive Compensation Plan as described in Article V hereof). Those applicable Employees who are hired after the Closing Date by the Genworth Business shall also

6

be eligible to participate in the applicable GE Plans during the Term upon meeting certain eligibility requirements or upon satisfaction of any waiting periods under such plans. GE or its Affiliate, as the case may be, shall continue to be responsible for operating and administering the provisions of the GE Plans.

**Section 4.03. Company Plans.** During the Term, for those Employees who are eligible to participate in the Company Plans immediately prior to the Closing Date (or who would become eligible upon meeting certain eligibility requirements or upon satisfaction of any waiting periods under such plans), such Employees shall continue to be eligible to participate in such Company Plans. Those applicable Employees who are hired after the Closing Date by the Genworth Business shall also be eligible to participate in the applicable Company Plans during the Term upon meeting certain eligibility requirements or upon satisfaction of any waiting periods under such plans. The applicable Company shall continue to be responsible for operating and administering the provisions of the applicable Company Plans with support from GE consistent with past practice.

## ARTICLE V

### INCENTIVE COMPENSATION

**Section 5.01. Establishment of Genworth Equity and Long-Term Performance Award Plan.** Effective as of the Closing Date, Genworth shall, or shall cause one of its Affiliates to, establish, adopt and maintain a plan or plans for the benefit of selected Employees providing for cash or other bonus awards, stock options, stock

awards, restricted stock, other equity-related awards and long-term performance awards (collectively, the “Genworth Equity and Long-Term Performance Award Plan”); provided, however, that such Employees shall continue to participate in the GE Incentive Compensation Plan, and Genworth’s plan providing for annual cash or other bonus awards shall not be effective, until the Trigger Date. During the Term, GE will cooperate with Genworth to support its operation and administration of the Genworth Equity and Long-Term Performance Award Plan.

**Section 5.02. Existing Arrangements.**

(a) Annual Incentive Compensation. GE will pay a pro rata bonus attributable to the portion of the calendar year occurring prior to the Trigger Date to eligible Employees who immediately prior to the Trigger Date have participated in the GE Incentive Compensation Plan subject to the terms and practices of such plan. Genworth shall reimburse GE promptly for any payments of such foregoing amounts upon the receipt of billing(s) for such amounts.

(b) GE Stock Options, Stock Appreciation Rights and Restricted Stock Units. Except as provided in Schedule I hereof, all GE stock options that are vested and held by Employees as of the Pricing Date will be exercisable in accordance with their terms and the GE 1990 Long-Term Incentive Plan. All GE stock options that are unvested and held by Employees as of the Pricing Date and all GE stock appreciation rights (whether or not vested) held by Employees as of the Pricing Date will be cancelled and converted on the Pricing Date to a like award of (or denominated in) Genworth common stock based on a ratio equal to the initial offering price of Genworth common stock divided by the weighted-average stock price of GE

7

---

common stock for the trading day immediately prior to the Pricing Date (the “Conversion Ratio”), subject to the effectiveness of a registration statement on Form S-8 relating to the registration of shares of Class A common stock to be offered by Genworth pursuant to the Genworth Equity and Long-Term Performance Award Plan. All GE restricted stock units held by Employees as of the Pricing Date will be cancelled and converted on the Pricing Date to Genworth restricted stock units based on the Conversion Ratio, subject to the effectiveness of a registration statement on Form S-8 relating to the registration of shares of Class A common stock to be offered by Genworth pursuant to the Genworth Equity and Long-Term Performance Award Plan. In all other respects, the converted awards held by Employees will be subject to the same terms and conditions as set forth respectively in the original award grants and, if applicable, the GE 1990 Long-Term Incentive Plan; provided, however, that no such awards shall vest solely as a result of the Trigger Date. The foregoing cancellation and conversion of GE stock options, GE stock appreciation rights, and GE restricted stock units shall immediately be rescinded in all respects in the event that delivery of the Firm Public Offering Shares (as defined in the Master Agreement) to the Underwriters (as defined in the Master Agreement) against payment therefor is not complete within four (4) Business Days (as defined in the Master Agreement) after the Closing Date.

(c) Long-Term Contingent Performance Incentive Awards. For purposes of determining eligibility for long-term contingent performance incentive awards granted to Employees in March 2003 under the GE Long-Term Incentive Plan for the 2003 through 2005 period, employment with the Company shall be treated as employment with GE (or an applicable GE Affiliate). GE will pay a prorated award, for the 2003 through 2005 period, equal to one-third ( $\frac{1}{3}$ ) of the payment that otherwise would be paid in the absence of such proration, in 2006, provided the terms and conditions for the payment of such award as set forth in the original grant and the GE 1990 Long-Term Incentive Plan are satisfied.

**ARTICLE VI**

**PAYMENTS**

**Section 6.01. GE Payroll and Plan Services.** During the Term, in consideration for the payment of the Employees through GE’s or one of its Affiliate’s payroll system, the participation of the Employees in the GE Plans, and the operation and administration of the GE Plans by GE and its Affiliates for the benefit of current and former Employees pursuant to this Agreement (the “GE Payroll and Plan Services”), Genworth shall pay GE, and reimburse it for, the costs incurred by the GE Group, plus reasonable expenses, associated with such GE Payroll and Plan Services. All such foregoing amounts under this Section 6.01 will be calculated, billed and paid consistent with the practices and procedures established and uniformly applied to GE businesses; provided, however, (i) GE shall not bill Genworth to the extent any such costs or expenses were previously paid by Genworth (as an Affiliate of GE) prior to the Closing Date and (ii) in no event will Genworth be billed more for the services relating to (A) the participation of the U.S. Employees in the GE Plans and (B) the operation and administration of the GE Plans by GE and its Affiliates for the benefit of current and former U.S. Employees pursuant to this Agreement, than the cost it would have incurred if it had established mirror plans for the U.S. Employees during the Term.

8

---

**Section 6.02. Company Plan Services.** During the Term, in consideration for GE’s cooperation in the operation and administration of any Company Plan, including the Genworth Equity and Long-Term Performance Award Plan established pursuant to Section 5.01 hereof, by Genworth and its Affiliates for the benefit of current and former Employees pursuant to this Agreement (the “Company Plan Services”), Genworth shall pay GE, and reimburse it for, the reasonable costs incurred by the GE Group that are associated with such Company Plan Services. All such foregoing amounts under this Section 6.02 will be calculated, billed and paid consistent with the practices and procedures established for such Company Plans in effect immediately prior to the Closing Date or, in the event of a new service, on a cost liquidation basis; provided, however, GE shall not bill Genworth to the extent any such costs or expenses were previously paid by Genworth (as an Affiliate of GE) prior to the Closing Date.

**Section 6.03. Other Genworth Obligations.** The amounts described in Sections 6.01 and 6.02 above shall be in addition to Genworth’s reimbursement and other obligations under this Agreement, including but not limited to Article VII hereof.

**ARTICLE VII**

**ADDITIONAL GENWORTH COVENANTS**

**Section 7.01. Termination of Participation in GE Plans**

(a) In General. (i) Except as otherwise specifically provided in this Agreement, effective as of the Trigger Date, all Employees and their dependents will cease any participation in, and any benefit accrual under, each of the GE Plans; provided, that any Employee who as of the Trigger Date has rights of employment on return from any leave or other absence will terminate participation in the GE Plans effective as of the close of business on the day before such Employee returns to active employment with the Company and no further benefits shall accrue under such GE Plans with respect to such Employee or any beneficiary thereof effective as of such return date.

(ii) Except as otherwise specifically provided in this Agreement, neither Genworth nor any other member of the Genworth Group shall assume any obligations under or Liabilities with respect to, and shall not receive any right or interest in, any of the GE Plans.

(b) U.S. Retirement Plans. As of the Trigger Date, Employees shall cease to accrue benefits, if any, under the GE Retirement Plans. Effective as of the Trigger Date, GE shall take all necessary action, if any, to (i) effect such cessation of participation, and (ii) cause the Employees to be fully vested in any GE Retirement Plan (to the extent not then fully vested), except that with respect to the GE Supplementary Pension Plan, GE shall only be required to vest such Employee if the Employee has had ten (10) years of pension qualified service. No assets or liabilities with respect to the GE Retirement Plans shall be transferred to Genworth as a result of this Agreement. GE shall pay, or cause to be paid, directly to the Employees (including their surviving spouses and beneficiaries) any vested retirement benefits to which they are

(c) U.S. Post-Retirement Welfare Benefits. GE and its applicable Affiliates shall retain any obligations they may have to provide post-retirement welfare benefits in accordance with the terms of the GE Life, Disability and Medical Plan, as in effect from time to time, to all former Employees of the Genworth Business and their eligible dependents who are currently receiving such benefits as of the Trigger Date. In addition, GE and its applicable Affiliates shall remain obligated to provide such coverage, consistent with the terms of such plan as in effect from time to time, to all Employees and their eligible dependents who, as of the Trigger Date, are participants in the plan and either (i) have completed twenty-five (25) years of continuous service or pension qualified service with the Company, its Affiliates and their respective predecessors or (ii) have attained at least sixty (60) years of age and have completed at least ten (10) years of continuous service, in either case upon such Employees' election to participate in the GE Life, Disability and Medical Plan. Such participation shall be under circumstances and at the applicable contribution levels entitling them to receive such benefits pursuant to the terms of the GE Life, Disability and Medical Plan as in effect from time to time. Genworth shall reimburse GE promptly for any payments of post-retirement welfare benefits made by GE or its applicable Affiliates to the eligible Employees and their eligible dependents pursuant to such coverage upon the receipt of periodic billings for such amounts.

(d) U.S. Other Welfare Benefits. Except as otherwise expressly provided in this Agreement, GE or one of its Affiliates shall retain responsibility under the GE Plans that are welfare benefit plans in which the Employees participate with respect to all amounts that are payable by reason of, or in connection with, any and all welfare benefit claims made by the Employees and their eligible dependents but only to the extent such claims were incurred prior to the Trigger Date. However, Genworth shall reimburse GE promptly for (i) (A) any payments of welfare benefits made by GE or one of its Affiliates on or after the Trigger Date to eligible Employees and their eligible dependents pursuant to any self-insured GE Plans with respect to claims incurred prior to the Trigger Date or (B) any payments of welfare benefits made by GE or one of its Affiliates on or after the Trigger Date to eligible Employees who are inactive as of the Trigger Date and their eligible dependents pursuant to any self-insured GE Plans with respect to claims incurred the day before such Employees' return to active employment with the Company, and (ii) any payments of premiums made by GE or one of its Affiliates on behalf of eligible Employees who are inactive as of the Trigger Date and their eligible dependents pursuant to any insured GE Plans with respect to coverage ending the day before such Employees' return to active employment with the Company, in each case upon the receipt of periodic billings for such amounts. Genworth and its Affiliates shall be otherwise responsible for welfare benefit claims made by the Employees and their eligible dependents to the extent such claims were incurred on or after the Trigger Date.

**Section 7.02. Compensation.** For a period from the Closing Date until at least one year following the Trigger Date (or for such longer period as required by the Laws of any country other than the United States), each Employee shall be entitled to receive while in the employ of the Company at least the same (on an aggregate basis) salary, wages, bonus opportunities and, in the case of an International Employee, other compensation as were provided by the Company, or were otherwise applicable, to such Employee immediately prior to the Closing Date.

**Section 7.03. U.S. Benefits.**

(a) Genworth Plans. Effective as of the Trigger Date, Genworth shall, or shall cause one of its Affiliates to, establish, adopt and maintain for a period of at least one year following the Trigger Date such employee benefits pursuant to plans, programs, policies and arrangements for the U.S. Employees that provide benefits to such U.S. Employees that are at least substantially comparable in the aggregate to the value of those benefits provided to them pursuant to the GE Plans in effect immediately prior to the Trigger Date (each such plan, program, policy and arrangement, a "Genworth Plan"). For avoidance of any doubt, no plan of the types described in Section 5.01 hereof shall be taken into account in determining whether the Genworth Plans are substantially comparable in the aggregate. Notwithstanding any of the foregoing to the contrary, Genworth shall, or shall cause one of its Affiliates to, provide severance benefits to any U.S. Employee who is laid off during the one-year period following the Trigger Date in an amount that is at least equal to the severance benefits that would have been paid to such employee pursuant to the terms of the applicable GE or GECC severance plan as in effect immediately prior to the Trigger Date, to be calculated, however, on the basis of the U.S. Employee's compensation and continuous service at the time of the layoff.

(b) Past Service Credit. All U.S. Employees shall be credited for service with the Company, GE, their respective Affiliates and their respective predecessors on and prior to the Trigger Date under all Genworth Plans and practices in which they become participants for all purposes, but excluding benefits accrual under any defined benefit plan, to the extent such service was credited under the corresponding GE Plan and practices.

(c) Group Health Plans. Genworth shall, or shall cause one of its Affiliates to, cause the Genworth Plans to waive any pre-existing conditions limitation and recognize expenses incurred by a U.S. Employee prior to the Trigger Date for purposes of out-of-pocket maximums and deductibles with respect to the calendar year in which the Trigger Date occurs.

(d) Vacation. Genworth shall, or shall cause one of its Affiliates to, recognize any unused vacation entitlement of the U.S. Employees as of the Trigger Date, and provide all U.S. Employees such unused vacation entitlement.

(e) 401(k) Plan. Effective as of the Trigger Date, Genworth shall have in effect a qualified defined contribution plan (the "Genworth 401(k) Plan") that includes a qualified cash or deferred arrangement within the meaning of Section 401(k) of the Code designed to provide benefits as of the Trigger Date to the U.S. Employees participating in the GES&SP immediately prior to the Trigger Date. Effective as of the Trigger Date, each U.S. Employee who was a participant in the GES&SP shall be entitled to a distribution of his or her respective account balance in accordance with the terms of the GES&SP. The Genworth 401(k) Plan shall provide for the receipt of such individual rollovers of benefits so distributed from the GES&SP.

(f) COBRA. Following the Trigger Date, Genworth shall, or shall cause one of its Affiliates to, provide continuation health care coverage to all U.S. Employees and their qualified beneficiaries who incur or incurred a qualifying event in accordance with COBRA at any time with respect to claims incurred on or after the Trigger Date.

**Section 7.04. International Benefits.**

(a) International Employees. In the case of the International Employees, Genworth shall, and shall cause its Affiliates to, comply with any applicable foreign Law governing the terms and conditions of their employment, employment practices or severance of employment.

(b) Continuation of International Plans. If an employee benefit plan, program, policy or arrangement is subject to the Laws of a country other than the United States (an "International Plan") and covers only International Employees, Genworth shall, or shall cause one of its Affiliates to, assume or continue, as the case may be, sponsorship over and assumption of all obligations with respect to such International Plan. Such International Plan shall be continued on the same terms for such International Employees for a period of at least one year following the Trigger Date or such longer period as may be required under applicable foreign Law or practice.

(c) Transfer of National Mutual Retirement Benefits Fund. As of the Closing Date, Genworth shall cause FIGSL to transfer sponsorship of the National Mutual Retirement Benefits Fund, and GE shall, or shall cause one of its Affiliates to, assume sponsorship over and assumption of all obligations and assets with respect to such Fund.

(d) Establishment of International Plans. (i) If an International Plan sponsored by GE or its Affiliate (other than a Company) covers employees of the GE Group in addition to International Employees, effective as of the International Benefit Transition Date, Genworth shall, or shall cause one of its Affiliates to, establish or maintain for the benefit of such International Employees (and not former International Employees) benefit plans for a period from the International Benefit Transition Date until at least one year following the Trigger Date or such longer period as may be required under applicable foreign Law or practice that, together with the International Plans described in Section 7.04(b) above, provide benefits to such International Employees that are at least substantially comparable in the aggregate to the value of those benefits provided to them pursuant to the corresponding International Plans in effect immediately prior to the International Benefit Transition Date. In addition, the benefits or employment practices provided by Genworth or its Affiliates pursuant to this Section 7.04(d)(i) shall be at such level and design so that no severance or similar payment to such International Employees shall be triggered, and shall comply with applicable foreign Law. In the event that any such severance or similar payment is triggered under a GE Plan, Genworth shall reimburse GE promptly for any payments of such foregoing amounts upon the receipt of billing(s) for such amounts. All obligations attributable to such International Employees under such International Plans shall be assumed by Genworth and its Affiliates under such Genworth benefit plans as of the International Benefit Transition Date.

(ii) If an International Plan sponsored by Genworth or its Affiliate (other than a member of the GE Group) covers employees of the GE Group in addition to International Employees, effective as of the International Benefit Transition Date, GE shall, or shall cause one of its Affiliates to, establish or maintain benefit plans for the benefit of such current (and not former) employees of the GE Group. All obligations attributable to such current employees of the GE Group under such International Plans shall be assumed by GE and its

12

---

Affiliates under such GE benefit plans as of the International Benefit Transition Date. During the Term, in consideration for participation of the employees of the GE Group in any International Plan sponsored by Genworth or its Affiliate and the operation and administration of such International Plans by Genworth and its Affiliates for the benefit of current and former employees of the GE Group pursuant to this Agreement (the "Genworth Plan Services"), GE shall pay Genworth, and reimburse it for, the costs incurred by the Genworth Group, plus reasonable expenses, associated with such Genworth Plan Services. All such foregoing amounts under this Section 7.04(d)(ii) will be calculated, billed and paid consistent with the practices and procedures established for such International Plans in effect immediately prior to the Closing Date; provided, however, Genworth shall not bill GE to the extent any such costs or expenses were previously paid by GE (or an Affiliate of GE) prior to the Closing Date.

(e) Funded International Plan. To the extent that any International Plan described in Section 7.04(d) above is a funded defined benefit or defined contribution pension plan with assets residing in a trust, GE and Genworth, respectively, shall determine a proportionate amount of the trust assets corresponding to, and not to exceed the liabilities under, such plan that is attributable to the International Employees and current employees of the GE Group, respectively. Such amount shall be transferred from such trust to the corresponding trust for the pension plan referred to in Section 7.04(d) above as soon as practicable after the International Benefit Transition Date unless contrary to applicable foreign Law. The amount to be transferred shall be determined by the plan sponsor subject to mutual agreement by GE and Genworth and, in the case of defined benefit pension plans, shall be based upon generally accepted country- and plan-specific actuarial assumptions and the accrued (but not projected) benefit obligation method. Notwithstanding the foregoing provisions of this Section 7.04(e), no part of the trust assets of the Canadian General Electric Pension Plan shall be transferred from such plan's trust fund to the corresponding trust for the Genworth pension plan referred to in Section 7.04(d) above, and GE shall retain all obligations attributable to the International Employees under the Canadian General Electric Pension Plan accrued as of the International Benefit Transition Date applicable to such employees.

(f) Past Service Credit. In addition to the other requirements of this Section 7.04, the International Employees shall be credited with service consistent with the principles set forth in Section 7.03(b) above and applicable Law.

**Section 7.05.** No Guarantee of Continued Employment. Neither Genworth nor any of its Affiliates shall be obligated to continue to employ any Employee for any specific period of time, subject to applicable Law.

**Section 7.06.** Claims Assistance. Genworth shall, and shall cause each other Company to, permit Employees to provide such assistance to GE as may be required in respect of claims arising from the employment relationship against GE or its Affiliates, whether asserted or threatened, to the extent that, in GE's opinion, (a) an Employee has knowledge of relevant facts or issues, or (b) an Employee's assistance is reasonably necessary in respect of any such claim.

13

---

## ARTICLE VIII

### PERFORMANCE AND COOPERATION

**Section 8.01.** Level of Performance. In performing its obligations under this Agreement, each of GE and Genworth agrees that it and its respective Affiliates, as applicable, shall in good faith exercise the same standard of care as each has used to perform such services for its own account and for its other employees, except as mutually agreed to in writing by GE and Genworth.

**Section 8.02.** Delivery of Information; Cooperation Between the Parties GE and Genworth shall, and shall cause their respective Affiliates to, provide each other with all such information and materials reasonably necessary to effect GE's and Genworth's prompt and complete performance of their duties and obligations under this Agreement and the GE Plans. The parties agree that they shall cooperate with each other and shall act in such a manner as to promote the prompt and efficient completion of the obligations hereunder.

## ARTICLE IX

### NON-HIRE; NON-SOLICITATION

**Section 9.01.** Non-Hire.

(a) From the date of this Agreement until the Trigger Date, no member of the Genworth Group will, without the prior written consent of GE, either directly or indirectly, on its own behalf or in the service of or on behalf of others, hire, or attempt to hire, any person employed by any member of the GE Group.

(b) From the date of this Agreement until the Trigger Date, no member of the GE Group will, without the prior written consent of Genworth, either directly or indirectly, on its own behalf or in the service of or on behalf of others, hire, or attempt to hire, any person employed by the Genworth Group.

**Section 9.02.** Non-Solicitation by Genworth Group.

(a) For a period of one year following the Trigger Date, no member of the Genworth Group will, directly or indirectly, induce or attempt to induce to



leave the employ of any member of the GE Group any person who at the time occupies a position: (i) assigned to the Senior Executive Band, (ii) assigned to the Executive Band and employed in the GE businesses known as Asset Management, GE Capital International Services, Inc., Consumer Finance, or Employers Reinsurance Corporation, or (iii) involved in risk modeling at GE's Global Research and Development Center, whether or not such employee is a full-time or a temporary employee of the GE Group, and whether or not such employment is pursuant to written agreement.

(b) For a period of two years following the Trigger Date, no member of the Genworth Group will, directly or indirectly, induce or attempt to induce to leave the employ of any member of the GE Group any person who at the time is serving as an Officer of GE.

14

---

**Section 9.03. Non-Solicitation by GE Group.**

(a) For a period of one year following the Trigger Date, no member of the GE Group will, directly or indirectly, induce or attempt to induce to leave the employ of any member of the Genworth Group any person who occupies a position: (i) assigned to the Senior Executive Band, (ii) assigned to the Executive Band, (iii) assigned to the Senior Professional Band and working in the functional areas of sales and marketing, risk management, actuarial services, finance, capital markets – management, product development – management, information technology or the Genworth Leadership Development Program, or (iv) involved in risk modeling, whether or not such employee is a full-time or a temporary employee of the Genworth Group, and whether or not such employment is pursuant to written agreement.

(b) For two years following the Trigger Date, no member of the GE Group will, directly or indirectly, induce or attempt to induce to leave the employ of any member of the Genworth Group any person who, on the day before the Trigger Date, occupied a GE Officer position.

**Section 9.04. Exceptions.** Notwithstanding the limitations in Sections 9.02 and 9.03 hereof applicable to particular categories of GE and Genworth employees (collectively, the “Restricted Employees”), such limitations will not: (i) prohibit members of the GE Group or the Genworth Group from attempting to hire or hiring any Restricted Employee after the termination of such employee's employment by a member of the GE Group or the Genworth Group or (ii) prohibit members of the GE Group or Genworth Group from placing public advertisements or conducting any other form of general solicitation that is not specifically targeted towards the Restricted Employees, including, but not limited to, the use of an independent employment agency or search firm whose efforts are not specifically directed at Restricted Employees.

**ARTICLE X**

**MISCELLANEOUS**

**Section 10.01. Headings.** The headings contained herein are for reference purposes only and shall not affect in any way the meaning or interpretation of this Agreement.

**Section 10.02. Counterparts.** This Agreement may be executed in one or more counterparts, and by the different parties to each such agreement in separate counterparts, each of which when executed shall be deemed to be an original but all of which taken together shall constitute one and the same agreement. Delivery of an executed counterpart of a signature page to this Agreement by facsimile shall be as effective as delivery of a manually executed counterpart of any such Agreement.

**Section 10.03. Assignment; No Third-Party Beneficiaries.** This Agreement shall not be assigned by any party hereto without the prior written consent of the other parties hereto. This Agreement is for the sole benefit of the parties to this Agreement and their permitted successors and assigns and nothing in this Agreement, express or implied, is intended to or shall confer upon any other Person or entity any legal or equitable right, benefit or remedy of any nature whatsoever under or by reason of this Agreement.

15

---

**Section 10.04. Amendment.** No provision of this Agreement may be amended or modified except by a written instrument signed by all the parties to such agreement. No waiver by any party of any provision hereof shall be effective unless explicitly set forth in writing and executed by the party so waiving. The waiver by either party hereto of a breach of any provision of this Agreement shall not operate or be construed as a waiver of any other subsequent breach.

**Section 10.05. Severability.** If any term or other provision of this Agreement is invalid, illegal or incapable of being enforced under any Law or as a matter of public policy, all other conditions and provisions of this Agreement shall nevertheless remain in full force and effect. Upon such determination that any term or other provision is invalid, illegal or incapable of being enforced, the parties to this Agreement shall negotiate in good faith to modify this Agreement so as to effect the original intent of the parties as closely as possible in a mutually acceptable manner in order that the transactions contemplated by this Agreement be consummated as originally contemplated to the greatest extent possible.

**Section 10.06. Entire Agreement.**

(a) Except as otherwise expressly provided in this Agreement, this Agreement constitutes the entire agreement of the parties hereto with respect to the subject matter of this Agreement and supersedes all prior agreements and undertakings, both written and oral, between or on behalf of the parties hereto with respect to the subject matter of this Agreement.

(b) In addition to the responsibilities and obligations set forth herein, (i) the parties to the Transition Services Agreement shall have certain other employment-related responsibilities and obligations as set forth therein, (ii) the parties to the European Transition Services Agreement shall have certain other employment-related responsibilities and obligations as set forth in Clauses 4.8 and 13.4 thereof, and (iii) the parties to the Mortgage Services Agreement shall have certain other employment-related responsibilities and obligations as set forth therein, including Section 4.02 thereof.

**Section 10.07. Coordination with Master Agreement.** The following articles and sections from the Master Agreement are hereby incorporated by reference as if fully set forth herein: Section 6.2 (Confidentiality); Section 6.5 (Allocation of Costs and Expenses); Article IX (Dispute Resolution); 10.2 (Governing Law); Section 10.4 (Force Majeure); and Section 10.6 (Notices).

16

---

IN WITNESS WHEREOF, each of the parties hereto has caused this Agreement to be signed as of the date first above written.

GENERAL ELECTRIC COMPANY

By: \_\_\_\_\_

Name: \_\_\_\_\_

Title:

GENERAL ELECTRIC CAPITAL CORPORATION

By: \_\_\_\_\_  
Name: \_\_\_\_\_  
Title: \_\_\_\_\_

GEI, INC.

By: \_\_\_\_\_  
Name: \_\_\_\_\_  
Title: \_\_\_\_\_

GE FINANCIAL ASSURANCE HOLDINGS, INC.

By: \_\_\_\_\_  
Name: \_\_\_\_\_  
Title: \_\_\_\_\_

GENWORTH FINANCIAL, INC.

By: \_\_\_\_\_  
Name: \_\_\_\_\_  
Title: \_\_\_\_\_

17

---

Schedule I

**SPECIAL EQUITY COMPENSATION ARRANGEMENTS**

1. Michael Fraizer's vested GE stock options will be cancelled and converted on the same basis as unvested GE stock options are cancelled and converted under this Agreement.

18

---

## TRANSITIONAL TRADEMARK LICENSE AGREEMENT

This Transitional Trademark License Agreement (this "Agreement"), dated as of \_\_\_\_\_, 2004, is made and entered into by and between GE Capital Registry, Inc., a New York corporation ("LICENSOR"), and Genworth Financial, Inc., a Delaware corporation ("LICENSEE").

WHEREAS, LICENSOR has the right to license the GE MARKS (as hereinafter defined) and registrations thereof in certain countries throughout the world for various goods and services;

WHEREAS, General Electric Company, General Electric Capital Corporation, GE Financial Assurance Holdings, Inc., GEL, Inc., and LICENSEE entered into a Master Agreement, dated \_\_\_\_\_, 2004 (the "Master Agreement");

WHEREAS, the Master Agreement requires the execution and delivery of this Agreement by LICENSOR and LICENSEE at the CLOSING; and

WHEREAS, in connection with the transactions contemplated by the Master Agreement, LICENSOR desires to grant to LICENSEE and the PERMITTED SUBLICENSEES a license to use the GE MARKS in accordance with the terms, and subject to the conditions, set forth herein.

NOW THEREFORE, in consideration of the mutual covenants contained herein and for other good and valuable consideration, the receipt and adequacy of which are hereby acknowledged, LICENSOR and LICENSEE agree as follows:

## I. DEFINITIONS

Unless otherwise defined herein, all capitalized terms used herein have the meanings ascribed to such terms in the Master Agreement. The following terms as used in this Agreement have the meanings set forth in this Article I:

**A.** "AUTHORIZED DISTRIBUTORS" means third parties that LICENSEE or a PERMITTED SUBLICENSEE authorizes to sell PRODUCTS (as hereinafter defined) and SERVICES (as hereinafter defined) during the term of this Agreement.

**B.** "EFFECTIVE DATE" means the date of this Agreement.

**C.** "LICENSED MARKS" means and is limited to the Marks shown in Exhibit A attached hereto alone and in combination with other words and phrases.

**D.** "MARKS" means trademarks, service marks, trade names, service names, taglines, slogans, industrial designs, brand names, brand marks, trade dress rights, Internet domain names, identifying symbols, logos, emblems, signs or insignia, meta tags, Website search terms and key words, including, without limitation, all goodwill associated with the foregoing.

---

**E.** "PERMITTED SUBLICENSEES" means LICENSEE'S direct and indirect SUBSIDIARIES.

**F.** "PRODUCTS" and "SERVICES" means, respectively, and is limited to (i) products sold and services rendered as of the EFFECTIVE DATE by LICENSEE and the PERMITTED SUBLICENSEES in the conduct of the GENWORTH BUSINESS as conducted as of the EFFECTIVE DATE and (ii) products sold and services rendered after the EFFECTIVE DATE by LICENSEE and the PERMITTED SUBLICENSEES that are the same as or similar to the products and services set forth under clause (i) above.

**G.** "STANDARDS OF QUALITY" means:

1. at least (i) the same standards of quality, appearance, service and other standards that are observed as of the EFFECTIVE DATE by LICENSOR and its AFFILIATES (including, without limitation, LICENSEE and its SUBSIDIARIES) in the development, marketing and sale of any PRODUCTS sold and SERVICES rendered prior to or as of the EFFECTIVE DATE and (ii) substantially the same standards of quality, appearance, service and other standards that are observed as of the EFFECTIVE DATE by LICENSOR and its AFFILIATES (including, without limitation, LICENSEE and its SUBSIDIARIES) in the development, marketing, sale or performance of any products and services similar to the PRODUCTS sold or SERVICES rendered after the EFFECTIVE DATE, provided that the standards set forth in the foregoing (i) and (ii) shall be at least substantially the same as the standards that LICENSEE and the PERMITTED SUBLICENSEES observe in their development, marketing and sale of any products and performance of any services similar to the PRODUCTS and SERVICES; and

2. additional standards, if any, which LICENSOR may otherwise reasonably specify or approve in writing from time to time; and such additional standards shall supersede the standards referred to in Paragraph I.G.1 to the extent of any conflict therewith.

## II. LICENSE GRANT

**A.** Subject to the terms and conditions of this Agreement, LICENSOR hereby grants to LICENSEE a limited, non-exclusive (except as specified in Exhibit A), non-transferable, royalty-free license, with no right to sublicense (other than to PERMITTED SUBLICENSEES as expressly provided herein), to use the LICENSED MARKS throughout the world and in any current or later-developed medium or form of communication (including, without limitation, in PRODUCT and SERVICE names and domain names) only (i) in connection with PRODUCTS designed, distributed, sold or otherwise commercialized, and SERVICES performed, offered, distributed, sold or otherwise commercialized by LICENSEE and the PERMITTED SUBLICENSEES, and (ii) in the general promotion of LICENSEE'S or any PERMITTED SUBLICENSEE'S business unrelated to any particular product or service, in each case in strict accordance with the STANDARDS OF QUALITY.

**B.** Notwithstanding anything in this Agreement to the contrary, LICENSEE, the PERMITTED SUBLICENSEES and AUTHORIZED DISTRIBUTORS shall not use any of the LICENSED MARKS (i) in connection with the underwriting or marketing on a primary basis of life insurance in the United Kingdom, provided, however, that LICENSEE, the PERMITTED SUBLICENSEES and AUTHORIZED DISTRIBUTORS are permitted to use LICENSED

---

MARKS in legal names, trade names, and otherwise in connection with credit life insurance businesses, products, or services in the United Kingdom, or (ii) in the name of any asset management service or product (other than any such service or product sold on behalf of LICENSOR or its AFFILIATES), provided, however, that LICENSEE, the PERMITTED SUBLICENSEES and AUTHORIZED DISTRIBUTORS are permitted to use LICENSED MARKS in legal names, trade names, and otherwise in connection with asset management services or products that are being marketed or offered by LICENSEE, the PERMITTED SUBLICENSEES and AUTHORIZED DISTRIBUTORS as of the EFFECTIVE DATE.

**C.** Any rights not granted to LICENSEE and the PERMITTED SUBLICENSEES in this Agreement are specifically reserved by and for LICENSOR.

LICENSEE and the PERMITTED SUBLICENSEES hereby accept this grant of license, subject to the terms and conditions set forth in this Agreement. The license granted in this Article is subject to, and limited by, any and all licenses, rights, limitations and restrictions with respect to such LICENSED MARKS previously granted to, or otherwise agreed to with, any third party that are in effect as of the EFFECTIVE DATE.

**D.** Notwithstanding anything in this Agreement to the contrary, if LICENSEE or any PERMITTED SUBLICENSEE desires to use the LICENSED MARKS with any product or service not constituting a PRODUCT or SERVICE, LICENSEE or such PERMITTED SUBLICENSEE shall make a request for permission to make such use in writing to LICENSOR. LICENSOR, at its sole discretion, shall determine whether it will allow such use, and shall notify LICENSEE of such decision in writing within a reasonable time. If LICENSOR decides to allow such use, the parties shall negotiate a separate, royalty-bearing license which shall require that LICENSEE or such PERMITTED SUBLICENSEE, as applicable, pay reasonable expenses for any additional trademark or service mark registrations required if the LICENSED MARKS are not registered for use in the appropriate class of goods or services relating to such product or service in any country in which LICENSEE or such PERMITTED SUBLICENSEE intends to use such LICENSED MARKS.

**E.** AUTHORIZED DISTRIBUTORS.

1. LICENSOR agrees that, during the term of this Agreement, AUTHORIZED DISTRIBUTORS may use the LICENSED MARKS in accordance with the terms and conditions set forth herein (including, without limitation, the standards and guidelines set forth in Paragraph IV.B) in order to identify themselves as authorized representatives of LICENSEE or a PERMITTED SUBLICENSEE or otherwise in connection with the promotion, distribution and sale of PRODUCTS and SERVICES.

2. LICENSEE and the PERMITTED SUBLICENSEES will provide the AUTHORIZED DISTRIBUTORS a copy of the standards and guidelines set forth in Paragraph IV.B (which copy may be provided by placing such standards and guidelines on a Website accessible by the AUTHORIZED DISTRIBUTORS and providing the AUTHORIZED DISTRIBUTORS notice that they must comply with such standards and guidelines). LICENSEE and the PERMITTED SUBLICENSEES will instruct the AUTHORIZED DISTRIBUTORS that they must furnish samples of all proposed forms and uses of the

3

---

LICENSED MARKS to LICENSEE and the PERMITTED SUBLICENSEES for written approval prior to any use thereof.

3. LICENSEE shall reasonably monitor AUTHORIZED DISTRIBUTORS' use of the LICENSED MARKS. To the extent that LICENSEE has any reason to believe that an AUTHORIZED DISTRIBUTOR may be using the LICENSED MARKS in a manner that violates or conflicts with the terms and conditions of this Agreement, LICENSEE shall promptly investigate such potential non-compliance. If LICENSEE determines that such violation or conflict has occurred or is occurring or if LICENSOR otherwise notifies LICENSEE that such violation or conflict has occurred or is occurring, LICENSEE shall promptly notify such AUTHORIZED DISTRIBUTOR and LICENSOR (unless LICENSOR notified LICENSEE thereof in accordance with the foregoing) of such non-compliance, and use reasonable efforts to cause such AUTHORIZED DISTRIBUTOR to comply with the terms and conditions of this Agreement. If such AUTHORIZED DISTRIBUTOR fails to comply with such terms and conditions within twenty (20) days of such notice, LICENSEE shall immediately terminate such AUTHORIZED DISTRIBUTOR'S rights to use the LICENSED MARKS, and instruct such AUTHORIZED DISTRIBUTOR that it has no further right to use any LICENSED MARK. LICENSEE and the PERMITTED SUBLICENSEES agree to take any and all further actions reasonably requested by LICENSOR to prevent and stop such non-compliance and any other unauthorized uses of the LICENSED MARKS by the AUTHORIZED DISTRIBUTORS.

**F.** PERMITTED SUBLICENSEES.

1. LICENSEE may sublicense its rights under Paragraph II.A to PERMITTED SUBLICENSEES. In the event that LICENSEE creates or acquires any direct or indirect SUBSIDIARIES after the EFFECTIVE DATE, LICENSEE may sublicense its rights under Paragraph II.A to such direct or indirect SUBSIDIARIES and such SUBSIDIARIES shall become and shall be PERMITTED SUBLICENSEES. Up to two (2) times per calendar year during the TERM of this Agreement, LICENSOR shall have the right to request that LICENSEE provide an organization chart or other document that identifies LICENSEE'S then-current direct and indirect SUBSIDIARIES. In the event that LICENSOR sends LICENSEE such a written request, LICENSEE shall provide LICENSOR with an organization chart or other document that identifies LICENSEE'S then-current direct and indirect SUBSIDIARIES within a commercially reasonable time after receipt of the written request. Additionally, in the event that LICENSOR sends LICENSEE a written request as to whether a particular entity is a direct or indirect SUBSIDIARY of LICENSEE, LICENSEE shall provide LICENSOR with a written response as to as to whether such entity is a direct or indirect SUBSIDIARY of LICENSEE within a commercially reasonable time after receipt of the written request.

2. LICENSEE shall cause the PERMITTED SUBLICENSEES to comply with the terms and conditions of this Agreement, and hereby grants LICENSOR the right to enforce this Agreement directly against a PERMITTED SUBLICENSEE to the extent that that PERMITTED SUBLICENSEE breaches the terms and conditions of this Agreement. Any such enforcement by LICENSOR against a PERMITTED SUBLICENSEE shall be upon the same terms and conditions as are applicable to enforcement by LICENSOR against LICENSEE.

4

---

**III. EXAMINATION OF PRODUCTS AND SERVICES**

**A.** In order to promote adherence to the STANDARDS OF QUALITY and for the purpose of protecting and maintaining the goodwill associated with the LICENSED MARKS and the reputation of LICENSOR, LICENSOR shall have the right to obtain from LICENSEE reasonable information as to the nature and quality of the PRODUCTS and SERVICES and the manner in which the LICENSED MARKS are used in connection with the PRODUCTS and SERVICES.

**B.** The PRODUCTS and SERVICES shall comply with all applicable Laws. For the purpose of protecting and maintaining the goodwill associated with the LICENSED MARKS and the reputation of LICENSOR, LICENSOR or its authorized representative shall have the right at any reasonable time or times during regular business hours on reasonable notice, and up to two (2) times per calendar year (and otherwise if LICENSOR notifies LICENSEE in writing that it believes the PRODUCTS and SERVICES are not conforming to the STANDARDS OF QUALITY or other requirements of this Agreement, which notice shall provide a description of the nonconformity that is reasonable under the circumstances and, if appropriate and available to LICENSOR, include samples of any nonconforming PRODUCTS and copies of any documentation relating to such nonconformity), to visit the offices and facilities of LICENSEE and the PERMITTED SUBLICENSEES where PRODUCTS are developed, designed, packaged, marketed, promoted, sold or serviced and SERVICES are developed, marketed, promoted or rendered. LICENSOR may conduct a reasonable inspection and examination of such offices and facilities, PRODUCTS, and SERVICES. LICENSEE agrees to furnish LICENSOR, from time to time as reasonably requested by LICENSOR, representative samples of representative PRODUCTS (and any other particular PRODUCTS requested by LICENSOR) to which the LICENSED MARKS are affixed and representative samples showing representative other uses of the LICENSED MARKS by LICENSEE, the PERMITTED SUBLICENSEES and AUTHORIZED DISTRIBUTORS selected by LICENSOR (and any other particular uses requested by LICENSOR). Upon LICENSOR'S reasonable request, LICENSEE and the PERMITTED SUBLICENSEES shall permit LICENSOR to promptly examine and audit documents, books and records pertaining specifically to the development, design, packaging, marketing, promoting, sale, servicing, quality, performance, and other characteristics of PRODUCTS and SERVICES as LICENSOR may reasonably require to verify that PRODUCTS sold and SERVICES rendered by LICENSEE and the PERMITTED SUBLICENSEES meet the STANDARDS OF QUALITY and that LICENSEE'S and the PERMITTED SUBLICENSEES' use of the LICENSED MARKS complies with LICENSEE'S obligations under this Agreement. In conducting any such inspection or audit, LICENSOR shall take all steps reasonably required by LICENSEE to minimize disruption to LICENSEE'S business and to avoid disclosure of LICENSEE'S confidential and proprietary information and materials, including, but not limited to, executing nondisclosure agreements, provided that such steps

and agreements shall not prevent LICENSOR from pursuing any claims that it may have in connection with this Agreement.

C. If, at any time, the PRODUCTS sold or SERVICES rendered fail, in the reasonable judgment of LICENSOR, to conform to the STANDARDS OF QUALITY, LICENSOR shall notify LICENSEE of such failure in writing (which notice shall provide a description of the nonconformity that is reasonable under the circumstances and, if appropriate and available to LICENSOR, include samples of any nonconforming PRODUCTS and copies of any documentation relating to such nonconformity). LICENSEE and the applicable

5

---

PERMITTED SUBLICENSEES shall take all necessary steps to bring such PRODUCTS or SERVICES into conformity with the STANDARDS OF QUALITY. If LICENSEE or any PERMITTED SUBLICENSEE fails to bring such PRODUCTS or SERVICES into conformity within twenty (20) days (or such other time period mutually agreed upon by the parties) after LICENSEE'S receipt of written notice of nonconformity, then LICENSEE, such PERMITTED SUBLICENSEE and their AUTHORIZED DISTRIBUTORS shall immediately cease the development, marketing, promotion and sale of such PRODUCTS or SERVICES under the LICENSED MARKS until such nonconformity is cured. Notwithstanding the foregoing, in the event that LICENSOR and LICENSEE or a PERMITTED SUBLICENSEE do not agree as to (i) whether a nonconformity exists, (ii) a remedy for a nonconformity, or (iii) the date by which a nonconformity will be corrected, LICENSOR and LICENSEE or the PERMITTED SUBLICENSEE shall resolve their disagreements in accordance with the dispute resolution process set forth in Article VII of the Master Agreement. LICENSEE or the PERMITTED SUBLICENSEE shall then implement the remedy, if any, that results from the dispute resolution process according to the requirements specified, or agreements reached, during the dispute resolution process. During the pendency of the dispute resolution process, LICENSEE or the PERMITTED SUBLICENSEE may take whatever action with respect to the PRODUCTS or SERVICES at issue as it deems reasonable to address the purported nonconformity (provided that LICENSEE and the PERMITTED SUBLICENSEE have the right pursuant to this Agreement to use the LICENSED MARKS in connection with such PRODUCTS and SERVICES as modified by such action), which may include, if applicable, implementing some or all of its proposed remedy. In the event that the nonconforming PRODUCTS or SERVICES cannot be brought into conformity during the time frame that is agreed to or that results from the dispute resolution process due to delays not within the reasonable control of LICENSEE or the PERMITTED SUBLICENSEES in obtaining any necessary approvals from GOVERNMENTAL AUTHORITIES, LICENSEE, the PERMITTED SUBLICENSEES, and the AUTHORIZED DISTRIBUTORS shall not be required to cease the development, marketing or sale of such PRODUCTS or SERVICES under the LICENSED MARKS, provided that LICENSEE or the applicable PERMITTED SUBLICENSEE is working diligently to obtain such approvals and keeps LICENSOR reasonably informed of its efforts to do so.

D. If, at any time, a GOVERNMENTAL AUTHORITY raises an issue with LICENSEE or a PERMITTED SUBLICENSEE as to whether PRODUCTS sold or SERVICES rendered comply with applicable Laws, LICENSEE or the PERMITTED SUBLICENSEE shall respond to the GOVERNMENTAL AUTHORITY adequately, including by modifying or discontinuing particular PRODUCTS or SERVICES if so directed by the GOVERNMENTAL AUTHORITY according to the time frames, if any, set forth by the GOVERNMENTAL AUTHORITY. Notwithstanding the foregoing, if, at any time, the PRODUCTS sold or SERVICES rendered fail, in the reasonable judgment of LICENSOR, to comply with all applicable Laws, LICENSOR shall notify LICENSEE of such failure in writing (which notice shall provide a description of the noncompliance that is reasonable under the circumstances and, if appropriate and available to LICENSOR, include samples of any noncompliant PRODUCTS and copies of any documentation relating to such noncompliance). LICENSEE and the applicable PERMITTED SUBLICENSEES shall take all necessary steps to bring such PRODUCTS or SERVICES into compliance with all applicable Laws. If LICENSEE or any PERMITTED SUBLICENSEE fails to bring such PRODUCTS or SERVICES into compliance within twenty (20) days (or such other time period mutually agreed upon by the parties) after

6

---

LICENSEE'S receipt of written notice of noncompliance, then LICENSEE, such PERMITTED SUBLICENSEE and their AUTHORIZED DISTRIBUTORS shall immediately cease the development, marketing, promotion and sale of such PRODUCTS or SERVICES under the LICENSED MARKS until such noncompliance is cured. Notwithstanding the foregoing but subject to any and all requirements of GOVERNMENTAL AUTHORITIES, in the event that LICENSOR and LICENSEE or a PERMITTED SUBLICENSEE do not agree as to (i) whether a noncompliance with applicable Laws exists, (ii) an appropriate remedy for such purported noncompliance, or (iii) the date by which such purported noncompliance will be corrected, LICENSOR and LICENSEE or the PERMITTED SUBLICENSEE shall resolve their disagreements in accordance with the dispute resolution process set forth in Article VII of the Master Agreement. Subject to any requirements of GOVERNMENTAL AUTHORITIES, LICENSEE or the PERMITTED SUBLICENSEE shall then implement the remedy, if any, that results from the dispute resolution process according to the requirements specified, or agreements reached, during the dispute resolution process. During the pendency of any such dispute resolution process and subject to any and all requirements of GOVERNMENTAL AUTHORITIES, LICENSEE, the PERMITTED SUBLICENSEES, and the AUTHORIZED DISTRIBUTORS may continue to promote, offer, and sell the PRODUCTS and SERVICES at issue, and LICENSEE or the PERMITTED SUBLICENSEE may take whatever action with respect to such PRODUCTS and SERVICES as it deems reasonable to address the purported noncompliance (provided that LICENSEE and the PERMITTED SUBLICENSEE have the right pursuant to this Agreement to use the LICENSED MARKS in connection with such PRODUCTS and SERVICES as modified by such action), which may include, if applicable, implementing some or all of its proposed remedy.

E. Rights granted to LICENSOR under this Article III to inspect, examine, request samples, and audit; to request that PRODUCTS and SERVICES be brought into conformity and compliance; and to direct cessation of certain activities with respect to PRODUCTS and SERVICES shall extend to the AUTHORIZED DISTRIBUTORS and PRODUCTS and SERVICES offered by the AUTHORIZED DISTRIBUTORS; provided however, that in the event LICENSOR desires to engage in any inspection, examination or audit with respect to, or to request changes to or cessation of, any PRODUCTS or SERVICES offered by an AUTHORIZED DISTRIBUTOR, LICENSOR shall do so solely through LICENSEE. LICENSOR shall not itself contact any AUTHORIZED DISTRIBUTOR with respect to the foregoing, except with the prior written consent of LICENSEE. Notwithstanding anything in this Agreement to the contrary, if LICENSEE fails to comply with its obligations with respect to any AUTHORIZED DISTRIBUTOR in accordance with this Agreement (including, without limitation, (i) failing to address any use of the LICENSED MARKS by any AUTHORIZED DISTRIBUTOR in a manner that conflicts with the terms and conditions of this Agreement applicable to the AUTHORIZED DISTRIBUTORS and (ii) instructing the AUTHORIZED DISTRIBUTORS to use the LICENSED MARKS in a manner consistent with the terms and conditions of this Agreement applicable to the AUTHORIZED DISTRIBUTORS) within twenty (20) days of notice from LICENSOR of such failure, LICENSOR shall have the right to contact such AUTHORIZED DISTRIBUTOR.

#### IV. USE OF GE MARKS

A. Under the license and rights granted herein, LICENSEE, the PERMITTED SUBLICENSEES and the AUTHORIZED DISTRIBUTORS are authorized to use the GE

7

---

MARKS only as provided in Articles II and VI in any current or later-developed medium or form of communication, including, without limitation, use in packaging, labeling, brochures, press releases, websites, domain names, signage, point-of-purchase materials, general publicity, advertising, instruction books and other literature relating to the PRODUCTS and SERVICES. LICENSEE, the PERMITTED SUBLICENSEES and the AUTHORIZED DISTRIBUTORS shall not use the GE MARKS in a manner that could reasonably be expected to damage the reputation or goodwill associated with LICENSOR, its AFFILIATES or the GE MARKS.

B. LICENSEE and the PERMITTED SUBLICENSEES shall comply with the standards and guidelines with respect to the appearance and manner of use of the GE MARKS set forth on Exhibit B, which LICENSOR may revise from time to time at LICENSOR'S sole discretion, provided that any potential revisions to the standards

and guidelines shall be subject to the process set forth in Paragraph IV.C. LICENSEE, the PERMITTED SUBLICENSEES and AUTHORIZED DISTRIBUTORS shall not use their MARKS in a manner that causes confusion as to the ownership of the GE MARKS. Subject to Paragraph II.D, any appearance or manner of use of the GE MARKS not provided for by such standards and guidelines (including, without limitation, any uses not contemplated by such standards and guidelines, any uses in contravention of such standards and guidelines and any clarifications of such standards and guidelines) shall be adopted by LICENSEE, the PERMITTED SUBLICENSEES and AUTHORIZED DISTRIBUTORS only upon prior written approval by LICENSOR of each first instance of such appearance or manner of use, which shall not unreasonably be withheld. LICENSEE shall make a written request referencing this Paragraph IV.B to LICENSOR for such appearance or manner of use, and LICENSOR shall provide a written response to LICENSEE within fifteen (15) days after its receipt of LICENSEE'S request, provided that such response may state that a written response cannot be provided within fifteen (15) days but will be provided within thirty (30) days after LICENSOR'S receipt of the request. In the event that LICENSOR has not provided a final written response to LICENSEE'S request for approval within thirty (30) days after LICENSOR'S receipt of the request, such request shall be deemed approved.

C. (i) In the event that LICENSOR proposes to change the standards and guidelines set forth in Paragraph IV.B, it shall notify LICENSEE of the proposed changes, and consult with LICENSEE regarding such changes. LICENSEE, the PERMITTED SUBLICENSEES, and the AUTHORIZED DISTRIBUTORS shall be allowed a commercially reasonable amount of time to implement any such changes made after the EFFECTIVE DATE, which amount of time shall be, if applicable, no less than the amount of time LICENSOR'S AFFILIATES are given to adopt the same changes. (ii) In the event that LICENSOR proposes to add to or otherwise change the STANDARDS OF QUALITY in accordance with Paragraph I.G.2, it shall notify LICENSEE of the proposed additions or changes, and consult with LICENSEE regarding such additions or changes. In the event that LICENSOR and LICENSEE cannot reach agreement as to any such proposed additions or changes to the STANDARDS OF QUALITY, LICENSOR'S and LICENSEE'S disagreement shall be resolved in accordance with the dispute resolution provisions set forth in Article VII of the Master Agreement. During the pendency of any such dispute resolution process, LICENSEE, the PERMITTED SUBLICENSEES, and the AUTHORIZED DISTRIBUTORS may continue to promote, offer, and sell the PRODUCTS or SERVICES at issue in accordance with the STANDARDS OF QUALITY in effect prior to such disagreement (not including such proposed addition or change). LICENSEE, the PERMITTED SUBLICENSEES, and the AUTHORIZED DISTRIBUTORS shall be allowed a commercially

8

---

reasonable amount of time to implement any such additions or other changes made after the EFFECTIVE DATE, which amount of time shall be, if applicable, no less than the amount of time LICENSOR'S AFFILIATES are given to adopt the same additions or changes and no less than the amount of time to obtain any regulatory approvals necessary to adopt such additions or changes, provided that LICENSEE and the PERMITTED SUBLICENSEES are working diligently to obtain such approvals and keep LICENSOR reasonably informed of their efforts to do so.

D. LICENSEE shall also obtain LICENSOR'S prior written approval (which shall be at the sole discretion of LICENSOR) for (i) each first instance of a general promotion in accordance with Paragraph II.A.ii that is not specifically provided for in the standards and guidelines set forth in Paragraph IV.B and (ii) any television or radio advertisements that use the GE MARKS. LICENSEE shall make a written request referencing this Paragraph IV.D to LICENSOR for approval of such general promotion or television or radio advertisement, and LICENSOR shall provide a written response to LICENSEE within fifteen (15) days after its receipt of LICENSEE'S request, provided that such response may state that a written response cannot be provided within fifteen (15) days but will be provided within thirty (30) days after LICENSOR'S receipt of the request. In the event that LICENSOR has not provided a final written response to LICENSEE'S request for approval within thirty (30) days after LICENSOR'S receipt of the request, such request shall be deemed approved.

E. LICENSEE, the PERMITTED SUBLICENSEES and AUTHORIZED DISTRIBUTORS shall comply with all applicable Laws pertaining to the GE MARKS, including, without limitation, those pertaining to the proper use and designation of MARKS and pertaining to the development, distribution, promotion and sale of PRODUCTS and the offering, rendering and promotion of SERVICES, and strictly comply with the STANDARDS OF QUALITY.

F. LICENSEE, the PERMITTED SUBLICENSEES and AUTHORIZED DISTRIBUTORS shall, within a commercially reasonable period of time, cease use of the GE MARKS upon notice from LICENSOR to LICENSEE that, in the good faith opinion of LICENSOR, such use of the GE MARKS might result in any potential trademark liability to a third party on the part of LICENSOR, LICENSEE, the PERMITTED SUBLICENSEES and/or the AUTHORIZED DISTRIBUTORS. LICENSEE, the PERMITTED SUBLICENSEES and the AUTHORIZED DISTRIBUTORS shall comply fully within a commercially reasonable period of time following LICENSEE'S receipt of written notice thereof with all guidelines adopted from time to time by LICENSOR for the purpose of addressing any potential trademark liability with respect to such third party.

G. If, in the sole discretion of LICENSOR, it is required or advisable for the purpose of making this Agreement enforceable, or for the purpose of maintaining, enhancing or protecting LICENSOR'S rights in the GE MARKS in some countries, to record this Agreement or to enter LICENSEE (and/or the PERMITTED SUBLICENSEES and the AUTHORIZED DISTRIBUTORS) as registered or authorized users of the GE MARKS, LICENSOR will attend (at LICENSOR'S expense) to such recording or entry. LICENSEE (or the appropriate PERMITTED SUBLICENSEE or AUTHORIZED DISTRIBUTOR) shall promptly and at no cost to LICENSOR execute and deliver to LICENSOR such additional instruments or

9

---

documentation as LICENSOR may reasonably request, including without limitation execution and delivery of substitute or short-form license agreements, with terms consistent with this Agreement, for recordation or registration in specified countries in the event that this Agreement shall be deemed by LICENSOR to be unsuitable for recordation or entry in such countries. The terms and conditions of this Agreement (and not the terms and conditions of such substitute or short-form license agreements entered into for recording or entry purposes) shall be binding between LICENSOR and LICENSEE (or the appropriate PERMITTED SUBLICENSEE or AUTHORIZED DISTRIBUTOR) throughout the world and shall govern and control any controversy that may arise with respect to each party's rights and obligations hereunder; provided, however, that if specific terms and conditions of any such substitute or short-form license agreement differ from the comparable terms and conditions of this Agreement and enforcement of the comparable terms and conditions of this Agreement pursuant to this provision either would be uncertain or improper under the Laws of the applicable country or would adversely affect LICENSOR'S rights in and to the GE MARKS in such country, then the specific terms and conditions of the substitute or short-form license agreement shall be controlling in such country.

H. LICENSEE and the PERMITTED SUBLICENSEES shall supply LICENSOR with such information (including, without limitation, any such information of the AUTHORIZED DISTRIBUTORS) concerning sales and other dispositions of PRODUCTS and SERVICES as LICENSOR may reasonably request to aid LICENSOR in the acquisition, maintenance and renewal of registrations of the GE MARKS, to record this Agreement, to enter LICENSEE, the PERMITTED SUBLICENSEES or AUTHORIZED DISTRIBUTORS as registered or authorized users of the GE MARKS or for any purpose reasonably related to LICENSOR'S maintenance and protection of the GE MARKS. LICENSEE (and the PERMITTED SUBLICENSEES) shall fully cooperate with LICENSOR'S reasonable requests in the execution, filing, and prosecution of any registration of a MARK or copyright relating to GE MARKS that LICENSOR may desire to obtain. For that purpose LICENSEE (and the PERMITTED SUBLICENSEES) shall supply to LICENSOR such samples, containers, labels, letterheads and other similar materials bearing the GE MARKS as may be required by LICENSOR.

I. Notwithstanding Paragraph II.A, LICENSEE, the PERMITTED SUBLICENSEES and the AUTHORIZED DISTRIBUTORS will not use the GE MARKS, nor may any particular PRODUCT or SERVICE be marketed, distributed or offered for sale or sold, (i) in any jurisdiction where the GE MARKS have not been registered, until an appropriate MARK search has been conducted (at LICENSEE'S expense) and an application to register the particular GE MARK in the relevant MARK class(es) for PRODUCTS and SERVICES has been filed in that jurisdiction (at LICENSOR'S expense), or LICENSOR determines in good faith on advice of its trademark counsel that it would be preferable not to seek to register such GE MARK in that country but that there is no material impediment to the use of such GE MARK therein and (ii) in a country where entry of LICENSEE as a registered or authorized user is required, prior to the execution of an appropriate registered user agreement or similar agreement and the filing thereof with the appropriate governmental agency (except where failure to do so prior to use will not have a material adverse effect on such GE MARK). Not in limitation of

---

registered in the appropriate MARK class(es) for PRODUCTS and SERVICES, LICENSOR at its sole discretion shall have the option to require such registration at LICENSOR'S expense.

**J.** LICENSEE and the PERMITTED SUBLICENSEES shall not, and shall instruct the AUTHORIZED DISTRIBUTORS to not, enter into any agreements relating to the placement of listings in response to Website search terms and key words that consist of the terms included in Exhibit C. Upon expiration or termination of this Agreement, LICENSEE and the PERMITTED SUBLICENSEES shall, and shall instruct the AUTHORIZED DISTRIBUTORS to, assign any agreements relating to the placement of listings in response to Website search terms and key words that include the GE MARKS to LICENSOR, unless such agreements by their own terms are non-assignable (in which case LICENSEE and the PERMITTED SUBLICENSEES shall, and shall instruct the AUTHORIZED DISTRIBUTORS to, terminate such agreements).

#### V. OWNERSHIP AND VALIDITY OF GE MARKS

**A.** LICENSEE and the PERMITTED SUBLICENSEES admit the validity, and LICENSOR'S ownership, of the GE MARKS and agree that any and all goodwill, rights or interests that might be acquired by the use of the GE MARKS by LICENSEE, the PERMITTED SUBLICENSEES and/or AUTHORIZED DISTRIBUTORS shall inure to the sole benefit of LICENSOR. If LICENSEE, the PERMITTED SUBLICENSEES or AUTHORIZED DISTRIBUTORS obtain rights or interests in the GE MARKS, LICENSEE or the PERMITTED SUBLICENSEES shall transfer, or shall instruct such AUTHORIZED DISTRIBUTOR to transfer, those rights or interests to LICENSOR upon request by LICENSOR. LICENSEE and the PERMITTED SUBLICENSEES admit and agree that, as between the parties, LICENSEE, the PERMITTED SUBLICENSEES and AUTHORIZED DISTRIBUTORS have been extended only a mere permissive right to use the GE MARKS as provided in this Agreement which is not coupled with any ownership interest.

**B.** LICENSEE and the PERMITTED SUBLICENSEES further agree not to, and to instruct the AUTHORIZED DISTRIBUTORS not to: (i) use or register in any country any MARKS (including, without limitation, any slogan) confusingly similar to, or consisting in whole or in part of, the GE MARKS or (ii) register the GE MARKS in any country, without in each case the express prior written consent of LICENSOR. Whenever LICENSEE or a PERMITTED SUBLICENSEE becomes aware of any consumer confusion or risk thereof between a MARK used by LICENSEE, a PERMITTED SUBLICENSEE or AUTHORIZED DISTRIBUTOR, and a GE MARK, LICENSEE or such PERMITTED SUBLICENSEE shall take appropriate steps to promptly remedy or avoid such confusion or risk of confusion.

**C.** LICENSEE may request in writing that LICENSOR, at LICENSEE'S expense, file an application for registration of any GE MARK for use in connection with the PRODUCTS and SERVICES in any country in which such GE MARK is not registered in the appropriate classes of goods or services for such PRODUCTS and SERVICES as of the EFFECTIVE DATE. Subject to Paragraph IV.I, LICENSOR shall use commercially reasonable efforts to complete such filing and prosecution in LICENSOR'S name. LICENSEE shall supply, without cost to LICENSOR, from time to time as requested by LICENSOR, such samples, containers, labels, letterheads, and similar materials from such LICENSEE or the PERMITTED SUBLICENSEES as may reasonably be required for such filing and prosecution.

---

**D.** LICENSOR will own all right, title and interest in and to any and all applications for registration of the GE MARKS (including, without limitation, applications filed in accordance with Paragraph V.C), whether filed before or after the EFFECTIVE DATE, and such applications shall be deemed incorporated in the defined term "GE MARKS".

**E.** LICENSEE and the PERMITTED SUBLICENSEES shall give LICENSOR notice promptly of any known or presumed infringements of the GE MARKS, and shall instruct the AUTHORIZED DISTRIBUTORS to give prompt notice to LICENSEE of any such infringements, which LICENSEE shall promptly give to LICENSOR. LICENSEE and the PERMITTED SUBLICENSEES shall render, and instruct the AUTHORIZED DISTRIBUTORS to render, to LICENSOR full and prompt cooperation (at LICENSOR'S expense) for the enforcement and protection of the GE MARKS against such infringements. LICENSOR shall retain all rights to bring all actions and proceedings in connection with infringement or misuse of the GE MARKS at its sole discretion. If LICENSOR decides to enforce the GE MARKS against an infringer, all costs incurred and recoveries made shall be for the account of LICENSOR.

**F.** LICENSEE and the PERMITTED SUBLICENSEES will not, and shall instruct the AUTHORIZED DISTRIBUTORS to not, at any time during the Term, and any time thereafter, for as long as LICENSOR shall own rights in the GE MARKS, do or cause to be done any act or thing disparaging, disputing, attacking, challenging, impairing, diluting, or in any way tending to harm the reputation or goodwill associated with LICENSOR, its AFFILIATES or any of the GE MARKS.

**G.** LICENSEE, the PERMITTED SUBLICENSEES and the AUTHORIZED DISTRIBUTORS have no right (and shall not, and shall instruct the AUTHORIZED DISTRIBUTORS to not, represent that they have the right) to bind or obligate LICENSOR in any way. LICENSOR has no right, and shall not represent that it has the right, to bind or obligate LICENSEE, any PERMITTED SUBLICENSEE or AUTHORIZED DISTRIBUTOR in any way.

#### VI. CORPORATE NAMES

**A.** "GE MARKS" means the LICENSED MARKS, "General Electric", "GE Capital" and "GEFA".

**B.** "LICENSED SUBSIDIARIES" means those PERMITTED SUBLICENSEES that, as of the EFFECTIVE DATE, include in their corporate names the GE MARKS, provided that "LICENSED SUBSIDIARIES" shall not include any such PERMITTED SUBLICENSEES that adopt NEW CORPORATE NAMES after the EFFECTIVE DATE.

**C.** "NEW CORPORATE NAMES" shall mean corporate names that do not consist in whole or in part of, and are not dilutive of or confusingly similar to, the GE MARKS. The parties agree that LICENSEE'S "Genworth" name and mark, and derivatives thereof, do not consist in whole or in part of, and are not dilutive of or confusingly similar to, the GE MARKS, provided that LICENSEE does not highlight, isolate or emphasize the letters "Ge" alone in the "Genworth" name and mark or derivatives thereof.

---

**D.** "TWENTY PERCENT DATE" means the first date on which members of the GE GROUP cease to beneficially own, in the aggregate, (excluding for such purposes shares of GENWORTH COMMON STOCK beneficially owned by LICENSOR but not for its own account, including (in such exclusion) beneficial ownership that arises by virtue of some entity that is an AFFILIATE of LICENSOR being a sponsor of or advisor to a mutual or similar fund that beneficially owns shares of GENWORTH COMMON STOCK) more than twenty percent (20%) of the then outstanding GENWORTH COMMON STOCK.

**E.** Subject to the terms and conditions set forth herein, LICENSOR hereby grants to LICENSEE a limited, non-exclusive, non-transferable, royalty-free license, with no right to sublicense (other than to the LICENSED SUBSIDIARIES as expressly provided herein), to allow the LICENSED SUBSIDIARIES to use the GE

MARKS in their corporate names to the extent such GE MARKS are used in such corporate names as of the EFFECTIVE DATE. Unless sooner terminated in accordance with this Article VI, this license shall expire on the sooner of: (i) the date that any GOVERNMENTAL AUTHORITY requires that such corporate names be changed, but only with respect to the particular LICENSED SUBSIDIARY to which the GOVERNMENTAL AUTHORITY requirement applies and subject to any time frame or transition period established by the GOVERNMENTAL AUTHORITY (alone or in consultation with LICENSEE), (ii) the TWENTY PERCENT DATE or (iii) the expiration of five (5) years from the EFFECTIVE DATE. Upon expiration in accordance with the foregoing (ii), (x) the LICENSED SUBSIDIARY shall use its best efforts to effectuate cessation of its use of the GE MARKS in its corporate name as expeditiously as possible under the circumstances and (y) in the event that a LICENSED SUBSIDIARY is unable to obtain regulatory approval necessary to adopt a NEW CORPORATE NAME in a jurisdiction, or is otherwise unable for regulatory reasons to adopt a NEW CORPORATE NAME in a jurisdiction, such LICENSED SUBSIDIARY shall be allowed to continue its then-current use of the corporate name for a transition period, which shall not exceed one (1) year except upon mutual agreement of the parties, provided that such LICENSED SUBSIDIARY in good faith complies with the obligations contained herein. Such LICENSED SUBSIDIARY shall comply with the applicable transition provisions in Exhibit D during any such transition period. No such transition period shall extend beyond five (5) years from the EFFECTIVE DATE.

**F.** Upon expiration or termination of the license granted under this Article VI, the LICENSED SUBSIDIARIES shall adopt NEW CORPORATE NAMES, subject to applicable TRANSITION PERIODS and other applicable provisions of this Article VI and this Agreement. If adoption of a NEW CORPORATE NAME is consistent with LICENSEE'S and the LICENSED SUBSIDIARIES' business plans and does not subject LICENSEE and the LICENSED SUBSIDIARIES to material incremental costs in addition to costs that LICENSEE and the LICENSED SUBSIDIARIES would incur to adopt NEW CORPORATE NAMES at a future date, LICENSEE and the LICENSED SUBSIDIARIES shall use reasonable best efforts to adopt and change to NEW CORPORATE NAMES as soon as possible after the EFFECTIVE DATE. The obligation to adopt NEW CORPORATE NAMES in connection with the TWENTY PERCENT DATE as set forth in the foregoing Paragraph VI.E shall not apply to the LICENSED SUBSIDIARY known as GE Capital Life Assurance Company of New York ("GECLANY") to the extent that it is necessary for GECLANY to maintain its current corporate name in order to fulfill its existing contractual obligations as of the EFFECTIVE DATE. GECLANY shall,

13

---

however, be required to adopt a NEW CORPORATE NAME no later than the expiration of the TERM.

**G.** The LICENSED SUBSIDIARIES shall operate their businesses in accordance with at least the same standards of quality, appearance, service and other standards that are observed as of the EFFECTIVE DATE by the LICENSED SUBSIDIARIES. In order to promote adherence to such standards and for the purpose of protecting and maintaining the goodwill associated with the GE MARKS and the reputation of LICENSOR, LICENSOR shall have the right to obtain from LICENSEE reasonable information as to the operation of the LICENSED SUBSIDIARIES' businesses and the manner in which the GE MARKS are used in connection with their corporate names. If, at any time, a LICENSED SUBSIDIARY fails, in the reasonable judgment of LICENSOR, to conform to the standards set forth in this Paragraph VI.G, LICENSOR shall notify LICENSEE of such failure in writing (which notice shall provide a description of the nonconformity that is reasonable under the circumstances and, if appropriate and available to LICENSOR, include copies of any documentation relating to such nonconformity). Such LICENSED SUBSIDIARY shall take all necessary steps to bring the nonconforming aspects of its business into conformity with such standards. If such LICENSED SUBSIDIARY fails to bring the nonconforming aspects of its business into conformity with such standards within twenty (20) days (or such other time period mutually agreed upon by the parties) after LICENSEE'S receipt of written notice of nonconformity, then such LICENSED SUBSIDIARY shall use its best efforts to effectuate cessation of its use of the GE MARKS in its corporate name as expeditiously as possible under the circumstances. Notwithstanding the foregoing, in the event that LICENSOR and LICENSEE or a LICENSED SUBSIDIARY do not agree as to (i) whether a nonconformity exists, (ii) a remedy for a nonconformity, or (iii) the date by which a nonconformity will be corrected, LICENSOR and LICENSEE or the LICENSED SUBSIDIARY shall resolve their disagreements in accordance with the Article VI dispute resolution process set forth in Exhibit E. LICENSEE or the LICENSED SUBSIDIARY shall then implement the remedy, if any, that results from the dispute resolution process according to the requirements specified, or agreements reached, during the dispute resolution process. During the pendency of the dispute resolution process, LICENSEE or the LICENSED SUBSIDIARY may take whatever action with respect to the purported nonconforming aspects of the LICENSED SUBSIDIARY'S business as it deems reasonable to address the purported nonconformity (provided that the LICENSED SUBSIDIARY has the right pursuant to this Agreement to take such action), which may include, if applicable, implementing some or all of its proposed remedy.

**H.** The LICENSED SUBSIDIARIES shall comply at all times with all applicable Laws, and shall be accurate in their descriptions of the relationship between LICENSOR and the LICENSED SUBSIDIARIES. For the purpose of protecting and maintaining the goodwill associated with the GE MARKS and the reputation of LICENSOR, LICENSOR or its authorized representative shall have the right at any reasonable time or times during regular business hours on reasonable notice to LICENSEE, and up to two (2) times per calendar year (and otherwise if LICENSOR notifies LICENSEE in writing that it believes a LICENSED SUBSIDIARY is not complying with the requirements of this Article VI, which notice shall provide a description of the nonconformity that is reasonable under the circumstances and, if appropriate and available to LICENSOR, include copies of any documentation relating to such nonconformity), to visit the offices and facilities of the LICENSED SUBSIDIARY. LICENSOR may conduct a reasonable

14

---

inspection and examination of such offices and facilities and the operation of the business of the LICENSED SUBSIDIARY to determine compliance with this Article VI in conjunction with the LICENSED SUBSIDIARY'S use of the GE MARKS in its corporate name. Upon LICENSOR'S reasonable request, the LICENSED SUBSIDIARIES shall permit LICENSOR to promptly examine and audit documents, books, records and other information pertaining to the operation of the LICENSED SUBSIDIARIES' business as LICENSOR may reasonably require to verify that the LICENSED SUBSIDIARIES are complying with the requirements of this Article VI in conjunction with the LICENSED SUBSIDIARIES' use of the GE MARKS in their corporate names. In conducting any such inspection or audit, LICENSOR shall take all steps reasonably required by the LICENSED SUBSIDIARIES to minimize disruption to the LICENSED SUBSIDIARIES' business and to avoid disclosure of the LICENSED SUBSIDIARIES' confidential and proprietary information and materials, including, but not limited to, executing nondisclosure agreements, provided that such steps and agreements shall not prevent LICENSOR from pursuing any claims that it may have in connection with this Agreement.

**I.** The license granted in this Article VI shall automatically terminate with respect to a LICENSED SUBSIDIARY upon notice to LICENSEE upon any of the following events with respect to that LICENSED SUBSIDIARY: (i) any merger or consolidation of such LICENSED SUBSIDIARY with an unrelated third party; (ii) the sale of all or substantially all of the assets of such LICENSED SUBSIDIARY to an unrelated third party; or (iii) a change of control of such LICENSED SUBSIDIARY whereby any unrelated third party acquires fifty percent (50)% or more of the outstanding voting securities of such LICENSED SUBSIDIARY or the power, directly or indirectly, to direct or cause the direction of management or policies (whether through ownership of securities or partnership or other ownership interests, by contract or otherwise) of such LICENSED SUBSIDIARY.

**J.** In the event LICENSEE or a LICENSED SUBSIDIARY breaches in any material respect any representation, warranty or covenant of this Article VI and LICENSOR gives LICENSEE written notice of such breach (which notice shall provide a description of the breach that is reasonable under the circumstances), LICENSEE and the LICENSED SUBSIDIARY, if applicable, shall have forty-five (45) days from LICENSEE'S receipt of such notice to remedy such breach, unless such breach cannot be remedied within such forty-five (45) day period, in which case LICENSEE and the LICENSED SUBSIDIARY, if applicable, shall use best efforts to remedy such breach as promptly as practicable but no later than ninety (90) days from LICENSEE'S receipt of such notice. If the breach is not remedied in accordance with the foregoing time periods, LICENSOR shall have the right to terminate the license granted in this Article VI with respect to LICENSEE and the LICENSED SUBSIDIARY, if applicable, at any time thereafter by giving LICENSEE notice of such termination.

**K.** The license granted in this Article VI shall terminate as to a particular country with notice to LICENSEE on a date established by either LICENSOR or LICENSEE if a controlling substitute or short-form license agreement is required in such country pursuant to Paragraph IV.G hereof and such controlling substitute or short-form license agreement contains provisions unacceptable to the party giving notice hereunder. The LICENSED SUBSIDIARIES will comply with any additional



deems necessary to comply with all applicable foreign Laws and to maintain, enhance and protect LICENSOR'S rights in the GE MARKS in foreign jurisdictions.

**L.** The license granted in this Article VI shall automatically terminate with respect to a LICENSED SUBSIDIARY without notice by LICENSOR in the event such LICENSED SUBSIDIARY commences, or has commenced against it, proceedings under bankruptcy, insolvency or debtor's relief laws or similar laws in any other jurisdiction, which proceedings are not dismissed within sixty (60) days; such LICENSED SUBSIDIARY makes a general assignment for the benefit of its creditors; or such LICENSED SUBSIDIARY ceases operations or is liquidated or dissolved.

**M.** Upon any termination under Paragraphs VI.I or VI.L, any terminated LICENSED SUBSIDIARY (or, subject to Paragraph VI.I, any successor of a LICENSED SUBSIDIARY) shall be permitted to continue its then-current use of the GE MARKS to the extent required to comply with applicable Laws for a TRANSITION PERIOD if LICENSEE obtains LICENSOR'S written consent (which consent shall not be unreasonably withheld) prior to the start of any proposed TRANSITION PERIOD (as defined in Paragraph VII.F.3 below). Upon any termination under Paragraph VI.J, any terminated LICENSED SUBSIDIARY (or, subject to Paragraph VI.I, any successor of a LICENSED SUBSIDIARY) shall be permitted to continue its then-current use of the GE MARKS but shall use its best efforts to effectuate cessation of its use of the GE MARKS in its corporate name as expeditiously as possible under the circumstances.

**N.** LICENSEE shall cause the LICENSED SUBSIDIARIES to comply with the terms and conditions of this Article VI, and hereby grants LICENSOR the right to enforce this Agreement directly against a LICENSED SUBSIDIARY to the extent that such LICENSED SUBSIDIARY breaches the terms and conditions of this Article VI. Any such enforcement by LICENSOR against a LICENSED SUBSIDIARY shall be upon the same terms and conditions as are applicable to enforcement by LICENSOR against LICENSEE under this Agreement. For the avoidance of doubt, LICENSEE'S failure to cause the LICENSED SUBSIDIARIES to comply in any material respect with the terms and conditions of this Article VI shall be a material breach of this Agreement by LICENSEE, and shall subject LICENSEE to termination of the license granted in Paragraph VI.E according to the termination process set forth in Paragraphs VI.J and VI.M. Provided that LICENSEE uses best efforts to address any material breach of a LICENSED SUBSIDIARY (such efforts including termination of such LICENSED SUBSIDIARY if the material breach is continuing), then notwithstanding the foregoing sentence, LICENSEE shall not be deemed to have breached this Agreement for failure to cause a LICENSED SUBSIDIARY to comply in any material respect with the terms and conditions of this Article VI to the extent that such LICENSED SUBSIDIARY'S breach is by its nature not capable of being remedied.

**O.** Any dispute, controversy or claim arising out of or relating to the transactions contemplated by this Article VI, or the validity, interpretation, breach or termination of any provision of this Article VI shall be resolved in accordance with Exhibit E.

## VII. TERMINATION

**A.** Unless terminated pursuant to any provision of this Article VII, this Agreement shall have a term ("TERM") of five (5) years from the EFFECTIVE DATE.

**B.** This Agreement shall terminate as to a particular country with notice to LICENSEE on a date established by either LICENSOR or LICENSEE if a controlling substitute or short-form license agreement is required in such country pursuant to Paragraph IV.G hereof and such controlling substitute or short-form license agreement contains provisions unacceptable to the party giving notice hereunder.

**C.** In the event LICENSEE or the PERMITTED SUBLICENSEES breach in any material respect any representation, warranty or covenant of this Agreement (including, without limitation, any failure to address an AUTHORIZED DISTRIBUTOR'S failure to comply with this Agreement as set forth in Paragraph II.E.3, including, without limitation, the standards and guidelines set forth in Paragraph IV.B), or in the event LICENSEE breaches its indemnification obligations as set forth in Section 5.2 of the Master Agreement, and LICENSOR gives LICENSEE written notice of such breach (which notice shall provide a description of the breach that is reasonable under the circumstances), LICENSEE or the PERMITTED SUBLICENSEES shall have forty-five (45) days from LICENSEE'S receipt of such notice to remedy such breach. If the breach is not remedied within said forty-five (45) days, LICENSOR shall have the right to terminate this Agreement at any time thereafter by giving LICENSEE notice of such termination.

**D.** This Agreement shall automatically terminate upon notice to LICENSEE (i) in its entirety upon any of the following events with respect to LICENSEE and (ii) with respect to any PERMITTED SUBLICENSEE, upon any of the following events with respect to such PERMITTED SUBLICENSEE:

1. any merger or consolidation of LICENSEE or such PERMITTED SUBLICENSEE with an unrelated third party;

2. the sale of all or substantially all of the assets of LICENSEE or such PERMITTED SUBLICENSEE to an unrelated third party; or

3. a change of control of LICENSEE or such PERMITTED SUBLICENSEE whereby any unrelated third party acquires fifty percent (50%) or more of the outstanding voting securities of LICENSEE or such PERMITTED SUBLICENSEE or the power, directly or indirectly, to direct or cause the direction of management or policies (whether through ownership of securities or partnership or other ownership interests, by contract or otherwise) of LICENSEE or such PERMITTED SUBLICENSEE.

Notwithstanding the foregoing, this Agreement shall not terminate if LICENSEE or any PERMITTED SUBLICENSEE acquires or attains control of a business entity, business unit, or block of business that provides PRODUCTS or SERVICES.

**E.** This Agreement shall automatically terminate with respect to LICENSEE, a PERMITTED SUBLICENSEE or AUTHORIZED DISTRIBUTOR without notice to LICENSEE by LICENSOR in the event LICENSEE, such PERMITTED SUBLICENSEE or such AUTHORIZED DISTRIBUTOR commences, or has commenced against it, proceedings

under bankruptcy, insolvency or debtor's relief laws or similar laws in any other jurisdiction, which proceedings are not dismissed within sixty (60) days; LICENSEE, such PERMITTED SUBLICENSEE or such AUTHORIZED DISTRIBUTOR makes a general assignment for the benefit of its creditors; or LICENSEE, such PERMITTED SUBLICENSEE or such AUTHORIZED DISTRIBUTOR ceases operations or is liquidated or dissolved.

### **F. TRANSITION PERIODS.**

1. Upon any termination under Paragraph VII.C, VII.D or VII.E of this Agreement in its entirety or with respect to LICENSEE, any PERMITTED SUBLICENSEE or any AUTHORIZED DISTRIBUTOR (or, subject to Paragraphs VII.D and IX.E, any successor of LICENSEE, any PERMITTED SUBLICENSEE or any AUTHORIZED DISTRIBUTOR by way of merger, consolidation, purchase of all or substantially all of the assets thereof, or change of control), LICENSEE, any such terminated PERMITTED SUBLICENSEE and any such terminated AUTHORIZED DISTRIBUTOR (or any such successor), as the case may be, shall be permitted to

continue its then-current use of the LICENSED MARKS to the extent required to comply with applicable Laws for a TRANSITION PERIOD (as hereinafter defined) if LICENSEE obtains LICENSOR'S written consent (which consent shall not be unreasonably withheld) prior to the start of any proposed TRANSITION PERIOD.

2. Upon any sale, divestiture or transfer by LICENSEE or any PERMITTED SUBLICONSEE of any of its business entities, business units, or blocks of business, such business entity, business unit or block of business shall be permitted to continue its then-current use of the LICENSED MARKS to the extent required to comply with applicable Laws for a TRANSITION PERIOD if LICENSEE obtains LICENSOR'S written consent (which consent shall not be unreasonably withheld) prior to the start of any proposed TRANSITION PERIOD.

3. "TRANSITION PERIOD" means a nine (9) month period, which may be extended with LICENSOR'S prior written consent (which consent shall not be unreasonably withheld) three (3) times for consecutive periods of thirty (30) days each, provided that LICENSEE, all applicable PERMITTED SUBLICONSEES and all applicable AUTHORIZED DISTRIBUTORS, as the case may be, at all times during such time period and such extension periods comply in good faith with the obligations contained herein and discontinue such use as promptly as practicable.

4. Notwithstanding anything in this Agreement to the contrary, no TRANSITION PERIOD shall extend beyond five (5) years from the EFFECTIVE DATE. LICENSEE, all applicable PERMITTED SUBLICONSEES and all applicable AUTHORIZED DISTRIBUTORS, as the case may be, shall comply with the transition provisions in Exhibit D.

G. The termination provisions of this Article VII do not apply to termination of the license granted in Article VI.

H. The following provisions of this Agreement shall survive any termination or expiration of this Agreement: Paragraphs V.A, V.B, V.D, V.F, V.G, VII.F and Articles VIII and IX. Subject to the foregoing sentence, upon termination or expiration of this Agreement, all

18

---

licenses granted to LICENSEE, the PERMITTED SUBLICONSEES and the AUTHORIZED DISTRIBUTORS herein shall immediately terminate.

#### VIII. DISCLAIMER OF WARRANTIES AND ASSUMPTION OF RISK

A. EACH PARTY AGREES AND ACKNOWLEDGES THAT THE GE MARKS ARE LICENSED HEREUNDER AS IS, WITH ALL FAULTS AND WITHOUT WARRANTY OF ANY KIND, AND THAT LICENSOR DOES NOT MAKE, AND LICENSOR HEREBY SPECIFICALLY DISCLAIMS, ANY REPRESENTATION OR WARRANTIES, EXPRESS OR IMPLIED, INCLUDING, WITHOUT LIMITATION, OF MERCHANTABILITY OR FITNESS FOR A PARTICULAR PURPOSE.

B. LICENSEE and the PERMITTED SUBLICONSEES hereby assume all risk and liability resulting from LICENSEE'S, PERMITTED SUBLICONSEES' and AUTHORIZED DISTRIBUTORS' use of the GE MARKS.

#### IX. MISCELLANEOUS PROVISIONS

A. Governing Law. This Agreement shall be governed by and construed and interpreted in accordance with the Laws of the State of New York irrespective of the choice of Laws principles of the State of New York other than Section 5-1401 of the General Obligations Law of the State of New York.

B. Notices. All notices, requests, claims, demands and other communications under this Agreement shall be in writing and shall be given or made (and shall be deemed to have been duly given or made upon receipt) by delivery in person, by overnight courier service, by facsimile with receipt confirmed (followed by delivery of an original via overnight courier service) or by registered or certified mail (postage prepaid, return receipt requested) to the respective parties at the following addresses (or at such other address for a party as shall be specified in a notice given in accordance with this Paragraph IX.B):

LICENSOR:

GE Capital Registry, Inc.  
260 Long Ridge Road  
Stamford, CT 06927  
Attention: General Counsel  
with a copy to:

Weil, Gotshal & Manges LLP  
767 Fifth Avenue  
New York, NY 10153  
Attention: Howard Chatzinoff, Esq.

LICENSEE:

Genworth Financial, Inc.  
6620 West Broad Street

19

---

Richmond, VA 23230  
Attention: General Counsel  
with a copy to:

Hunton & Williams LLP  
Riverfront Plaza, East Tower  
951 East Byrd Street  
Richmond, VA 23219-4074  
Attention: Allen C. Goolsby, Esq.

C. Severability. If any term or other provision of this Agreement is invalid, illegal or incapable of being enforced under any Law or as a matter of public policy, all other conditions and provisions of this Agreement shall nevertheless remain in full force and effect. Upon such determination that any term or other provision is invalid, illegal or incapable of being enforced, the parties to this Agreement shall negotiate in good faith to modify this Agreement so as to effect the original intent of the parties as closely as possible in a mutually acceptable manner in order that the transactions contemplated by this Agreement be consummated as originally contemplated to the greatest extent possible.

**D. Entire Agreement.** This Agreement and the Master Agreement constitute the entire agreement of the parties hereto with respect to the subject matter of this Agreement and supersede all prior agreements and undertakings, both written and oral, between or on behalf of the parties hereto with respect to the subject matter of this Agreement.

**E. Assignment; No Third-Party Beneficiaries.** This Agreement shall not be assigned or transferred in whole or in part by any party hereto without the prior written consent of the other parties hereto, and any attempted assignment or transfer without such consent shall be null and void. Notwithstanding the foregoing, LICENSOR, in its sole discretion, may assign this Agreement in whole or in part to any AFFILIATE of LICENSOR at any time. Except as provided in Paragraph VII.F with respect to successors, this Agreement is for the sole benefit of the parties to this Agreement and their permitted successors and assigns and nothing in this Agreement, express or implied, is intended to or shall confer upon any other Person or entity any legal or equitable right, benefit or remedy of any nature whatsoever under or by reason of this Agreement.

**F. Amendment.** No provision of this Agreement may be amended or modified except by a written instrument signed by all the parties to this Agreement. No waiver by any party of any provision hereof shall be effective unless explicitly set forth in writing and executed by the party so waiving. The waiver by either party hereto of a breach of any provision of this Agreement shall not operate or be construed as a waiver of any other subsequent breach.

**G. Rules of Construction.** Interpretation of this Agreement shall be governed by the following rules of construction: (a) words in the singular shall be held to include the plural and vice versa and words of one gender shall be held to include the other gender as the context requires, (b) references to the terms Article, Section, Paragraph, and Schedule are references to the Articles, Sections, Paragraphs, and Schedules to this Agreement unless otherwise specified,

20

(c) the word "including" and words of similar import shall mean "including, without limitation," (d) provisions shall apply, when appropriate, to successive events and transactions, (e) the headings contained herein are for reference purposes only and shall not affect in any way the meaning or interpretation of this Agreement and (f) this Agreement shall be construed without regard to any presumption or rule requiring construction or interpretation against the party drafting or causing any instrument to be drafted.

**H. Counterparts.** This Agreement may be executed in one or more counterparts, each of which when executed shall be deemed to be an original but all of which taken together shall constitute one and the same agreement. Delivery of an executed counterpart of a signature page to this Agreement by facsimile shall be as effective as delivery of a manually executed counterpart of any such Agreement.

**I. Dispute Resolution.** Any dispute, controversy or claim arising out of or relating to the transactions contemplated by this Agreement, or the validity, interpretation, breach or termination of any provision of this Agreement shall be resolved in accordance with Article VII of the Master Agreement. Notwithstanding the foregoing, any dispute, controversy or claim arising out of or relating to the transactions contemplated by Article VI of this Agreement, or the validity, interpretation, breach or termination of any provision of Article VI of this Agreement shall be resolved in accordance with Exhibit E.

**J. No Waiver.** Failure by LICENSOR at any time to enforce or require strict compliance with any provision of this Agreement shall not affect or impair that provision in any way or the rights of LICENSOR to avail itself of the remedies it may have in respect of any subsequent breach of that or any other provision. The waiver of any term, condition, or provision of this Agreement must be in writing and signed by an authorized representative of the waiving Party. Any such waiver will not be construed as a waiver of any other term, condition, or provision, nor as a waiver of any subsequent breach of the same term, condition, or provision, except as provided in a signed writing.

**K. Headings.** All headings used in this Agreement are for convenience of reference only. They will not limit or extend the meaning of any provision of this Agreement, and will not be relevant in interpreting any provision of this Agreement.

IN WITNESS WHEREOF, LICENSOR and LICENSEE have caused this instrument to be executed in duplicate by their duly authorized representatives as of the date first written above.

GE CAPITAL REGISTRY, INC.

By: \_\_\_\_\_  
Name: \_\_\_\_\_  
Title: \_\_\_\_\_  
Date: \_\_\_\_\_

GENWORTH FINANCIAL, INC.

By: \_\_\_\_\_  
Name: \_\_\_\_\_  
Title: \_\_\_\_\_  
Date: \_\_\_\_\_

21

EXHIBIT A

LICENSED MARKS



- 1.
2. "GE", both unstylized and stylized, subject to the standards and guidelines pursuant to Paragraph IV.B.
3. "Built on GE Heritage"

The parties agree that during the TERM, LICENSEE'S right to use "Built on GE Heritage" shall be exclusive, even as to LICENSOR, provided that such exclusivity shall apply only to all of the words "Built on GE Heritage" used in that order. For the avoidance of doubt, GE may use "GE Heritage" alone or in combination with other words and phrases.

22

EXHIBIT B

STANDARDS AND GUIDELINES

EXHIBIT CSEARCH TERMS AND KEY WORDS

All terms and phrases containing the GE Marks either alone or in combination with other words or phrases, including, without limitation, the following:

ge interest plus  
 ge long term care  
 general electric long term care  
 ge credit cards  
 ge dental plan  
 general electric dental plan  
 ge auto club  
 ge direct stock investing  
 ge health care finance service  
 ge health care finance services  
 ge health care finance solution  
 ge health care finance solutions  
 ge health insurance  
 ge healthcare finance service  
 ge healthcare finance services  
 ge healthcare finance solution  
 ge healthcare finance solutions  
 ge healthcare financial service  
 ge healthcare financial services  
 ge healthcare financial solution  
 ge healthcare financial solutions  
 ge health care financial service  
 ge health care financial services  
 ge health care financial solution  
 ge health care financial solutions  
 ge home insurance  
 ge home mortgages  
 ge immediate annuities  
 ge mutual funds  
 ge protection plans  
 ge short term investing  
 ge short term investment  
 ge short term investments  
 ge stock investing  
 ge term life insurance  
 general electric auto club  
 general electric credit cards  
 general electric direct stock investing

general electric health insurance  
 general electric home insurance  
 general electric home mortgages  
 general electric immediate annuities  
 general electric mutual funds  
 general electric protection plans  
 general electric short term investing  
 general electric short term investment  
 general electric short term investments  
 general electric stock investing  
 general electric term life insurance

EXHIBIT DTRANSITION PROVISIONS

Within two (2) months after the first day of, as the case may be, the transition period set forth in Paragraph VI.E. or the TRANSITION PERIOD, LICENSEE shall prepare and deliver to LICENSOR a reasonable plan (the "Plan") outlining the actions LICENSEE shall take to cease using, as the case may be, the GE MARKS or the LICENSED MARKS. The Plan shall include, without limitation, an expected timeline for taking such actions and a list of all necessary third party and regulatory approvals. Such Plan shall be mutually agreed upon by LICENSOR and LICENSEE. LICENSOR and LICENSEE shall in good faith reach mutual agreement on the Plan within thirty (30) days after LICENSEE'S delivery of the Plan to LICENSOR. In the event that LICENSOR does not provide LICENSEE with a substantive response on the Plan within thirty (30) days after LICENSEE'S delivery of the Plan to LICENSOR, the Plan shall be deemed mutually agreed upon. LICENSEE shall comply with the agreed-upon Plan. If LICENSEE does not comply with its material obligations under the Plan, then LICENSEE will be in breach of Paragraph VI.E. or Paragraph VII.F.4. of this Agreement, and LICENSOR shall have the right to terminate this Agreement pursuant to Paragraph VI.J. or Paragraph VII.C., respectively.

From the time that the Plan is mutually agreed upon through the end of the transition period set forth in Paragraph VI.E or the TRANSITION PERIOD or successful

conclusion of the Plan, whichever comes first, LICENSEE shall provide LICENSOR with written reports each ninety (90) days. Such reports shall summarize the status of LICENSEE'S actions under the Plan, including, without limitation, all approvals sought and received. LICENSEE shall provide any and all additional information as LICENSOR may reasonably request relating to such Plan and LICENSEE'S implementation thereof.

LICENSEE shall comply with all applicable terms and conditions set forth in the Agreement during, as the case may be, such transition period set forth in Paragraph VI.E. or such TRANSITION PERIOD.

---

EXHIBIT E

ARTICLE VI DISPUTE RESOLUTION

1.1 General Provisions.

(a) Any dispute, controversy or claim arising out of or relating to Article VI of this Agreement, or the validity, interpretation, breach or termination thereof (an "Article VI Dispute"), shall be resolved in accordance with the procedures set forth in this Exhibit E, which shall be the sole and exclusive procedures for the resolution of any such Article VI Dispute unless otherwise specified below. The parties expressly agree that dispute resolution procedures in this Exhibit E govern Article VI Disputes and supersede dispute resolution provisions contained in any other Transaction Documents, including but not limited to the Master Agreement, for Article VI Disputes.

(b) Commencing with an Article VI Initial Notice contemplated by Section 1.2 of this Exhibit E, all communications between the parties or their representatives in connection with the attempted resolution of any Article VI Dispute, including any mediator's evaluation referred to in Section 1.3 of this Exhibit E, shall be deemed to have been delivered in furtherance of an Article VI Dispute settlement, shall be exempt from discovery and production, and shall not be admissible in evidence for any reason (whether as an admission or otherwise), in any arbitral or other proceeding for the resolution of the Article VI Dispute

(c) The parties expressly waive and forego any right to (i) punitive, exemplary, statutorily-enhanced or similar damages in excess of compensatory damages, and (ii) trial by jury.

(d) The specific procedures set forth below, including but not limited to the time limits referenced therein, may be modified by agreement of the parties in writing.

(e) All applicable statutes of limitations and defenses based upon the passage of time shall be tolled while the procedures specified in this Exhibit E are pending. The parties will take such action, if any, required to effectuate such tolling.

(f) The parties hereto hereby irrevocably submit to the exclusive jurisdiction of any federal or state court located within the State of Delaware over any such Article VI Dispute and each party hereby irrevocably agrees that all claims in respect of any such Article VI Dispute or any suit, action or proceeding related thereto may be heard and determined in such courts. The parties hereby irrevocably waive, to the fullest extent permitted by applicable Law, any objection which they may now or hereafter have to the laying of venue of any such Article VI Dispute brought in such courts or any defense of inconvenient forum for the maintenance of such dispute. Each of the parties hereto agrees that a judgment in any such Article VI Dispute may be enforced in other jurisdictions by suit on the judgment or in any other manner provided by Law.

---

(g) Each party will bear its own attorney's fees and costs incurred in connection with the resolution of any Article VI Dispute.

1.2 Consideration by Senior Executives. If an Article VI Dispute is not resolved in the normal course of business at the operational level, the parties shall attempt in good faith to resolve such Article VI Dispute by negotiation between executives who hold, at a minimum, the office of President and CEO of the respective business entities involved in such Article VI Dispute. Either party may initiate the executive negotiation process by providing a written notice to the other (the "Article VI Initial Notice"). Ten (10) days after delivery of the Article VI Initial Notice, the receiving party shall submit to the other a written response (the "Article VI Response"). The Article VI Initial Notice and the Article VI Response shall include (i) a statement of the Article VI Dispute and of each party's position, and (ii) the name and title of the executive who will represent that party and of any other person who will accompany the executive. Such executives will meet in person or by telephone within twenty (20) days of the date of the Article VI Initial Notice to seek a resolution of the Article VI Dispute.

1.3 Mediation. If an Article VI Dispute is not resolved by negotiation as provided in Section 1.2 within thirty (30) days from the delivery of the Article VI Initial Notice, then either party may submit the Article VI Dispute for resolution by mediation pursuant to the CPR Institute for Dispute Resolution Model Mediation Procedure as then in effect. The parties will select a mediator from the CPR Panels of Distinguished Neutrals. Either party at commencement of the mediation may ask the mediator to provide an evaluation of the Article VI Dispute and the parties' relative positions. The parties agree to resolve such mediation within thirty (30) days of the selection of a mediator.

1.4 Arbitration. If an Article VI Dispute is not resolved by mediation as provided in Section 1.3 within thirty (30) days of the selection of a mediator (unless the mediator chooses to withdraw sooner), either party may submit the Article VI Dispute to be finally resolved by arbitration pursuant to the CPR Rules for Non-Administered Arbitration as then in effect, but amended as follows: (i) after an Article VI Dispute has arisen but has not been resolved by negotiation or mediation according to the time frames set forth in Sections 1.2 and 1.3, a party (the "Claimant") seeking to initiate arbitration shall send a Notice of Arbitration to the other party (the "Respondent") as soon as practicable; (ii) the Respondent shall deliver to the Claimant a notice of defense within five (5) business days of its receipt of the Notice of Arbitration; (iii) if a counterclaim is asserted in the Notice of Defense, the Claimant shall deliver to the Respondent a reply to counterclaim within five (5) business days of its receipt of the Notice of Defense; (iv) there shall be one (1) arbitrator, who shall be a member of the CPR Panels of Distinguished Neutrals and shall be appointed by agreement of the parties, using their best, good faith efforts, within five (5) days after the Notice of Defense is received by the Claimant, or, if no agreement is reached, by the CPR upon written request of either party; and (v) no discovery will be allowed. The parties agree to resolve such arbitration within thirty (30) days of the date that the Claimant sends the Notice of Arbitration to the Respondent. Such arbitration proceeding shall take place in New York, New York unless the parties mutually agree to another location. The parties agree that no appeal shall lie from the arbitration award, that they will not challenge the arbitration award for any reason in any court, and that the arbitration award shall have the force and effect of a judgment as if a court having jurisdiction thereof has

---

entered judgment on the award. The arbitration shall be governed by the Federal Arbitration Act, 9 U.S.C. §§ 1-16.



## INTELLECTUAL PROPERTY CROSS LICENSE

This INTELLECTUAL PROPERTY CROSS LICENSE (“**Agreement**”) dated as of \_\_\_\_\_, 2004, is entered into by GENERAL ELECTRIC COMPANY, a New York corporation (“**GE**”) and GENWORTH FINANCIAL, INC., a Delaware corporation (“**Genworth**”). GE and Genworth are sometimes referred to herein as a “**party**” or collectively as the “**parties**”.

## PRELIMINARY STATEMENTS

- A. GE, General Electric Capital Corporation, GE Financial Assurance Holdings, Inc., GEI, Inc., and Genworth entered into a Master Agreement, dated \_\_\_\_\_, 2004 (“**Master Agreement**”).
- B. The Master Agreement requires the execution and delivery of this Agreement by the parties at the Closing.
- C. GE and its Affiliates control certain Intellectual Property and desire to license certain Intellectual Property, including, without limitation, patent rights, to Genworth and its Affiliates.
- D. Genworth and its Affiliates control certain Intellectual Property and desire to license certain Intellectual Property, including, without limitation, patent rights, to GE and its Affiliates.
- E. The parties desire to avoid any adverse effect on the GENIUS<sup>®</sup> Applications that may result from the filing and prosecution of continuation-in-part and divisional patent applications based on the GENIUS<sup>®</sup> Applications.

NOW THEREFORE, in consideration of the mutual covenants and agreements contained herein, the parties, intending to be legally bound, hereby agree as follows:

**ARTICLE I**  
**Definitions**

**Section 1.01. Certain Defined Terms.**

- (a) Unless otherwise defined herein, all capitalized terms used herein shall have the same meaning as in the Master Agreement.
- (b) The following capitalized terms used in this Agreement shall have the meanings set forth below:

“**Applications**” means the GENIUS<sup>®</sup> Applications and the GE Applications.

“**Bankruptcy Code**” has the meaning set forth in Section 2.05.

“**CIP**” has the meaning set forth in Section 4.03.

“**CIP Applications**” has the meaning set forth in Section 4.03.

“**Control**” or “**Controlled**” means, with respect to any Intellectual Property, the right to grant a license or sublicense to such Intellectual Property as provided for herein without (i) violating the terms of any agreement or other arrangement with any third party, (ii) requiring any consent, approvals or waivers from any third party, or any breach or default by the party being granted any such license or sublicense being deemed a breach or default affecting the rights of the party granting such license or sublicense or (iii) requiring the payment of material compensation to any third party.

“**Divisional Applications**” has the meaning set forth in Section 4.03.

“**Electronic Materials**” has the meaning set forth in Section 2.09.

“**ERC IP**” has the meaning set forth in Schedule C.

“**GE Accounting Policies**” means GE’s accounting policies and related documentation, which are clarifications of U.S. GAAP, pursuant to which GE keeps its books and records and prepares consolidated financial statements.

“**GEAM IP**” has the meaning set forth in Schedule C.

“**GE Applications**” has the meaning set forth in Section 4.03.

“**GECIS IP**” has the meaning set forth in Schedule C.

“**GE Intellectual Property**” means Intellectual Property that is (x) Controlled by the GE Group as of the Closing Date or the date it is assigned to the GE Group pursuant to the Master Agreement and (y) in use, held for use or contemplated to be used by the Genworth Group as of the Closing Date or the date of such assignment, but specifically excludes (i) Intellectual Property assigned to Genworth and/or its Affiliates under the Master Agreement, (ii) GE Materials and (iii) Intellectual Property obtained by Genworth for GE and its Affiliates pursuant to Section 3.01(b) of the Transition Services Agreement. “**GE Intellectual Property**” includes, without limitation, the Intellectual Property set forth on Schedule A to the extent such Intellectual Property is in use, held for use or contemplated to be used by the Genworth Group as of the Closing Date or the date of such assignment and is Controlled by the GE Group as of the Closing Date or the date of such assignment.

“**GE Materials**” means, collectively, the GE Accounting Policies, Policies and other materials of the GE Group described in Article III.

“**GE Services**” has the meaning set forth in the Transition Services Agreement.

“GENIUS® Applications” has the meaning set forth in Section 4.03.

“Genworth Intellectual Property” means Intellectual Property that is (i) (x) Controlled by the Genworth Group as of the Closing Date or the date it is assigned to the Genworth Group pursuant to the Master Agreement and (y) in use, held for use or contemplated to be used by the GE Group as of the Closing Date or the date of such assignment. “Genworth Intellectual Property” includes, without limitation, the Intellectual Property set forth on Schedule B to the extent such Intellectual Property is in use, held for use or contemplated to be used by the GE Group as of the Closing Date or the date of such assignment and is Controlled by the Genworth Group as of the Closing Date or the date of such assignment.

“Intellectual Property” means all of the following, whether protected, created or arising under the laws of the United States or any other foreign jurisdiction: (i) patents, patent applications (along with all patents issuing thereon), statutory invention registrations, divisions, continuations, continuations-in-part, substitute applications of the foregoing and any extensions, reissues, restorations and reexaminations thereof, and all rights therein provided by international treaties or conventions, (ii) copyrights, mask work rights, database rights and design rights, whether or not registered, published or unpublished, and registrations and applications for registration thereof, and all rights therein whether provided by international treaties or conventions or otherwise, (iii) trade secrets, (iv) intellectual property rights arising from or in respect of Technology and (v) all other applications and registrations related to any of the intellectual property rights set forth in the foregoing clauses (i) — (iv) above. As used in this Agreement, the term “Intellectual Property” expressly excludes (x) trademarks, service marks, trade dress, logos and other identifiers of source, including all goodwill associated therewith and all common law rights, registrations and applications for registration thereof, and all rights therein provided by international treaties or conventions, and all reissues, extensions and renewals of any of the foregoing and (y) intellectual property rights arising from or in respect of domain names, domain name registrations and reservations.

“Improvement” means any modification, derivative work or improvement of any Technology.

“Licensed Products and Services” means those products and services that use, practice or incorporate the Licensor’s Intellectual Property.

“Licensee” means a Person receiving a license or sublicense under this Agreement.

“Licensor” means a Person granting a license or sublicense under this Agreement.

“Policies” has the meaning set forth in Section 3.03.

“Prime Directive” has the meaning set forth in Section 4.03.

3

---

“Prosecution Guidelines” has the meaning set forth in Section 4.03.

“Restriction Requirements” has the meaning set forth in Section 4.03.

“Secondary Directive” has the meaning set forth in Section 4.03.

“Services” has the meaning set forth in the Transition Services Agreement.

“Software” means the object and source code versions of computer programs and sufficient associated documentation, training materials and configurations to use and modify such programs, including programmer, administrator, end user and other documentation.

“Subsequent Applications” has the meaning set forth in Section 4.03.

“Technology” means, collectively, all designs, formulas, algorithms, procedures, techniques, ideas, know-how, Software, programs, models, routines, databases, tools, inventions, creations, improvements, works of authorship, and all recordings, graphs, drawings, reports, analyses, other writings, and any other embodiment of the above, in any form, whether or not specifically listed herein.

“Transition Services Agreement” means the Transition Services Agreement dated \_\_\_\_\_, 2004, by and among GE, General Electric Capital Corporation, GEI, Inc., GE Financial Assurance Holdings, Inc. and Genworth.

“USPTO” has the meaning set forth in Section 4.03.

## ARTICLE II License Grant

### Section 2.01. Grant from GE to Genworth and its Affiliates

(a) GE hereby grants, and shall cause its Affiliates to grant, to Genworth and its Affiliates a non-exclusive, irrevocable, royalty-free, fully paid up, worldwide, perpetual right and license, with no right to sublicense except as provided herein, under the GE Intellectual Property: (i) to allow employees, directors and officers of Genworth and its Affiliates to use and practice the GE Intellectual Property for internal purposes, (ii) to make, have made, use, sell, have sold, import, and otherwise commercialize Licensed Products and Services and (iii) to create Improvements in accordance with Section 2.04.

(b) Genworth and its Affiliates may grant sublicenses of the right and license granted under this Section 2.01 to an acquiror of any of the businesses, operations or assets of Genworth or its Affiliates to which this Agreement relates, which acquiror executes an agreement to be bound by all obligations of Genworth and its Affiliates under this Agreement relating to such right and license (a copy of which agreement is provided to GE).

4

---

(c) Subject to the terms and conditions of Article VI, Genworth and its Affiliates may permit their suppliers, contractors and consultants to exercise the right and license granted to Genworth and its Affiliates under this Section 2.01 on behalf of and at the direction of Genworth and its Affiliates (and not solely for the benefit of such suppliers, contractors and consultants).

(d) Subject to the terms and conditions of Article VI, Genworth and its Affiliates may permit employees (including contract employees), directors and officers of their customers and suppliers in the ordinary course of Genworth’s business (and not Persons who are customers or suppliers merely to access and use the GE Intellectual Property) to use training and productivity-enhancing Software and documentation that is subject to the right and license granted under this Section 2.01 and is for general use by customers and suppliers, provided that Genworth’s or its Affiliates’ purpose in permitting such use is to benefit the business of Genworth or its Affiliates, provided further that such customers and suppliers may not use any such Software and documentation in advertising, publicity or marketing activities without GE’s prior written approval, which approval will not be unreasonably withheld.



(e) With respect to the GE Intellectual Property set forth on Schedule C, the right and license granted to Genworth and its Affiliates under this Section 2.01 shall be further subject to the terms and conditions set forth on Schedule C.

**Section 2.02. Grant from Genworth to GE and its Affiliates**

(a) Genworth hereby grants, and shall cause its Affiliates to grant, to GE and its Affiliates a non-exclusive, irrevocable, royalty-free, fully paid up, worldwide, perpetual right and license, with no right to sublicense except as provided herein, under the Genworth Intellectual Property: (i) to allow employees, directors and officers of GE and its Affiliates to use and practice the Genworth Intellectual Property for internal purposes, (ii) to make, have made, use, sell, have sold, import, and otherwise commercialize Licensed Products and Services and (iii) to create Improvements in accordance with Section 2.04.

(b) GE and its Affiliates may grant sublicenses of the right and license granted under this Section 2.02 to an acquiror of any of the businesses, operations or assets of GE or its Affiliates to which this Agreement relates, which acquiror executes an agreement to be bound by all obligations of GE and its Affiliates under this Agreement relating to such right and license (a copy which agreement is provided to Genworth).

(c) Subject to the terms and conditions of Article VI, GE and its Affiliates may permit their suppliers, contractors and consultants to exercise the right and license granted to GE and its Affiliates under this Section 2.02 on behalf of and at the direction of GE and its Affiliates (and not solely for the benefit of such suppliers, contractors and consultants).

(d) Subject to the terms and conditions of Article VI, GE and its Affiliates may permit employees (including contract employees), directors and officers of their customers and suppliers in the ordinary course of GE's business (and not Persons who are customers or suppliers merely to access and use the Genworth Intellectual Property) to use training and productivity-enhancing Software and documentation that is subject to the right and license

5

---

granted under this Section 2.02 and is for general use by customers and suppliers, provided that GE's or its Affiliates' purpose in permitting such use is to benefit the business of GE or its Affiliates, provided further that such customers and suppliers may not use any such Software and documentation in advertising, publicity or marketing activities without Genworth's prior written approval, which approval will not be unreasonably withheld.

**Section 2.03. Third Party Licenses.** To the extent that any Intellectual Property owned by a third party is licensed under Sections 2.01 or 2.02, such Intellectual Property shall be subject to all of the terms and conditions of the relevant agreement between the Licensor and such third party pursuant to which such Intellectual Property has been licensed.

**Section 2.04. Improvements.** Improvements made after the Closing Date shall be owned by the party making such Improvement, or on whose behalf such Improvement was made, and, as between the parties, such party shall own all Intellectual Property rights in such Improvement. For the avoidance of doubt, (i) such party shall not own any Intellectual Property rights licensed to such party hereunder and (ii) such party may freely assign or license such Improvements but shall not have the right to assign any Intellectual Property of the other party and shall only have the right to sublicense Intellectual Property of the other party as expressly set forth herein. No rights are granted to either party to any Improvements made by, or on behalf of, the other party under the Intellectual Property licensed hereunder to the extent such Improvement was made after the Closing Date.

**Section 2.05. Section 365(n) of the Bankruptcy Code** All rights and licenses granted under this Agreement are, and shall otherwise be deemed to be, for purposes of Section 365(n) of the United States Bankruptcy Code (the "**Bankruptcy Code**"), licenses of rights to "intellectual property" as defined under Section 101(35A) of the Bankruptcy Code. The parties shall retain and may fully exercise all of their respective rights and elections under the Bankruptcy Code.

**Section 2.06. Customers.** Each party agrees that it will use reasonable efforts to not knowingly bring any legal action or proceeding against, or otherwise communicate with, any customer of the other party with respect to any alleged infringement, misappropriation or violation of any Intellectual Property of such party licensed hereunder based on such customer's use of the other party's products or services without first providing the other party written notice of such alleged infringement, misappropriation or violation.

**Section 2.07. Reservation of Rights.** All rights not expressly granted by a party hereunder are reserved by such party. Without limiting the generality of the foregoing, the parties expressly acknowledge that nothing contained herein shall be construed or interpreted as a grant, by implication or otherwise, of any licenses other than the licenses expressly set forth in this Article 2. The licenses granted in Sections 2.01 and 2.02 are subject to, and limited by, any and all licenses, rights, limitations and restrictions with respect to, as applicable, the GE Intellectual Property and the Genworth Intellectual Property previously granted to or otherwise obtained by any third party that are in effect as of the Closing.

6

---

**Section 2.08. Cooperation Regarding Restrictions and Limitations Applicable to Licensed Intellectual Property**

(a) Until two (2) years after the Trigger Date, at the request of Genworth, GE agrees to, and to cause GE's Affiliates to, use commercially reasonable, good faith efforts to provide Genworth such copies of agreements (subject to any confidentiality restrictions that would prevent disclosure of such agreements) or other information that are sufficient to inform Genworth about any limitations or restrictions on the use and sublicensing of the GE Intellectual Property set forth on Schedule A hereto or other specific GE Intellectual Property identified by Genworth in writing to GE, which has not already been provided to the Genworth Group and which is not otherwise in the Genworth Group's possession. GE and its Affiliates shall not have any liability to Genworth and its Affiliates resulting or arising from the failure or inability to provide such agreements or information, and Genworth and its Affiliates shall not have any liability to GE and its Affiliates under this Agreement for failing to comply with limitations and/or restrictions on the use and sublicensing of GE Intellectual Property of which the Genworth Group did not have actual or constructive knowledge. Notwithstanding anything in this Agreement or the Master Agreement to the contrary, GE and its Affiliates shall not indemnify, defend or hold Genworth Group or its Affiliates harmless with respect to any Liabilities to any third party arising out of, or resulting from, any Intellectual Property of such third party licensed from GE or its Affiliates hereunder.

(b) Until two (2) years after the Trigger Date, at the request of GE, Genworth agrees to, and to cause Genworth's Affiliates to, use commercially reasonable, good faith efforts to provide GE such copies of agreements (subject to any confidentiality restrictions that would prevent disclosure of such agreements) or other information that are sufficient to inform GE about any limitations or restrictions on the use and sublicensing of the Genworth Intellectual Property set forth on Schedule B hereto or other specific Genworth Intellectual Property identified by GE in writing to Genworth, which has not already been provided to the GE Group and which is not otherwise in the GE Group's possession. Genworth and its Affiliates shall not have any liability to GE and its Affiliates resulting or arising from the failure or inability to provide such agreements or information, and GE and its Affiliates shall not have any liability to Genworth and its Affiliates under this Agreement for failing to comply with limitations and/or restrictions on the use and sublicensing of Genworth Intellectual Property of which the GE Group did not have actual or constructive knowledge. Notwithstanding anything in this Agreement or the Master Agreement to the contrary, Genworth and its Affiliates shall not indemnify, defend or hold GE or its Affiliates harmless with respect to any Liabilities to any third party arising out of, or resulting from, any Intellectual Property of such third party licensed from Genworth or its Affiliates hereunder.

**Section 2.09. Delivery of Software.**

(a) Until the expiration of two (2) years from the Trigger Date, either party may request one (1) copy of Software or other electronic content maintained on the other party's intranet or other computer network ("Electronic Materials") that (i) is subject to the license granted to such requesting party under this Article II, (ii) has not already been provided to the requesting party, (iii) is not otherwise in the requesting party's possession and (iv) is not used to provide any GE Services or Company Services, as the case may be, to the requesting party or its Affiliates under the Transition Services Agreement, provided that if such requesting party has access to such intranet or computer network, such requesting party has first used commercially reasonable efforts to obtain such Software or Electronic Materials directly from such intranet or

7

---

computer network prior to making such request. Subject to Section 2.03, the delivering party shall make available or deliver to the requesting party a copy of any such Software or Electronic Materials that is in existence at the time of such request and current as of the Closing Date; provided, however, that the delivering party may, at its sole discretion, make available or deliver a version of such Software and Electronic Materials that is current on or about the date of such request and includes upgrades, updates and other modifications made to such Software and Electronic Materials since the Closing Date. Any upgrades, updates or other modifications to Software and Electronic Materials that are made available or delivered to the requesting party pursuant to this Section 2.09 and Controlled by the delivering party as of the date they are made available or delivered shall be deemed to be GE Intellectual Property if made available or delivered by GE or its Affiliates, or Genworth Intellectual Property if made available or delivered by Genworth or its Affiliates, notwithstanding that such upgrades, updates or other modifications were not used, held for use or contemplated to be used by the receiving party as of the Closing Date or Controlled by the delivering party as of the Closing Date.

(b) All Software, Electronic Materials and upgrades, updates or other modifications thereto required to be made available to or delivered to a Licensee pursuant to Section 2.09(a), will be delivered by the Licensor to the Licensee electronically, or with the assistance of the Licensor, downloaded by the Licensee from the Internet, provided that the Licensee complies with all reasonable security measures implemented by the Licensor.

**Section 2.10. Taxes.**

(a) Each party shall be responsible for any personal property taxes on property it or any of its Affiliates owns or leases, for franchise and privilege taxes on its or its Affiliates' business, and for taxes based on its or its Affiliates' net income or gross receipts.

(b) Genworth and its Affiliates may report and (as appropriate) pay any sales, use, excise, value-added, services, consumption, and other taxes and duties (collectively, "Taxes") for which Genworth and its Affiliates are responsible pursuant to Section 2.10(a) directly if Genworth provides GE with a direct pay or exemption certificate.

(c) GE and its Affiliates may report and (as appropriate) pay any Taxes for which GE and its Affiliates are responsible pursuant to Section 2.10(a) directly if GE provides Genworth with a direct pay or exemption certificate.

(d) Each party agrees to cooperate with the other party to enable each to more accurately determine its and its Affiliates' own tax liability and to minimize such liability to the extent legally permissible.

(e) GE shall promptly notify Genworth of any claim for Taxes asserted by applicable taxing authorities for which Genworth or any of its Affiliates is alleged to be financially responsible hereunder. GE shall coordinate with Genworth the response to and settlement of any such claim. Notwithstanding the above, Genworth's and its Affiliates' liability for such Taxes is conditioned upon GE providing Genworth notification within twenty (20) business days of receiving any proposed assessment of any additional Taxes, interest or penalty due by GE or its Affiliates.

8

---

(f) Genworth shall promptly notify GE of any claim for Taxes asserted by applicable taxing authorities for which GE or its Affiliates is alleged to be financially responsible hereunder. Genworth shall coordinate with GE the response to and settlement of any such claim. Notwithstanding the above, GE's and its Affiliates' liability for such Taxes is conditioned upon Genworth providing GE notification within twenty (20) business days of receiving any proposed assessment of any additional Taxes, interest or penalty due by Genworth or its Affiliates.

(g) Genworth and its Affiliates shall be entitled to receive and to retain any refund of Taxes paid by Genworth or its Affiliates to GE or its Affiliates pursuant to this Agreement. In the event GE or its Affiliates shall be entitled to receive a refund of any such Taxes, GE shall promptly pay, or cause the payment of, such refund to Genworth.

(h) GE and its Affiliates shall be entitled to receive and to retain any refund of Taxes paid by GE or its Affiliates to Genworth or its Affiliates pursuant to this Agreement. In the event Genworth or its Affiliates shall be entitled to receive a refund of any such Taxes, Genworth shall promptly pay, or cause the payment of, such refund to GE.

**ARTICLE III  
GE MATERIALS**

**Section 3.01. Prior to the Trigger Date.** Prior to the Trigger Date, GE shall permit Genworth and its Affiliates to use the GE Materials in accordance with GE's standard policies, procedures and guidelines for use thereof by its Subsidiaries.

**Section 3.02. Accounting Policies.**

(a) On and after the Trigger Date, GE shall permit Genworth and its Affiliates to use the GE Accounting Policies for historical purposes of Genworth and its Affiliates. On and after the Trigger Date, GE shall permit Genworth and its Affiliates to use the GE Accounting Policies with the modifications required by Section 3.02(b) ("**Genworth Accounting Policies**") for the accounting and reporting purposes of Genworth and its Affiliates. Genworth and its Affiliates may create (and their respective contractors may create on their behalf), and Genworth and its Affiliates shall own, derivative works and modifications of the Genworth Accounting Policies. The Genworth Accounting Policies used by Genworth and its Affiliates may be (i) used by Genworth's and its Affiliates' employees (including contractors), auditors, accountants and financial advisors, (ii) disclosed as required by applicable Law and (iii) used by an acquiror of Genworth or its Affiliates or any of the businesses, operations or assets of Genworth or its Affiliates to which this Agreement relates, provided that such acquiror executes an agreement to be bound by all obligations of Genworth and its Affiliates under this Agreement relating to such Genworth Accounting Policies (a copy of which agreement is provided to GE) provided further that such acquiror shall be limited to use of such Genworth Accounting Policies solely in connection with such businesses, operations or assets (and not any other businesses, operations or assets of the acquiror). It is understood and agreed that GE makes no representation or warranty as to the suitability of the GE Accounting Policies for use by Genworth and its Affiliates or any of their respective divested businesses.

9

(b) Notwithstanding anything in this Agreement to the contrary, the text of any Genworth Accounting Policies shall not contain any references to GE or its Affiliates, GE or its Affiliates' publications, GE or its Affiliates' personnel (including, without limitation, senior management).

### **Section 3.03. Corporate Policies.**

(a) On and after the Trigger Date, GE shall permit Genworth and its Affiliates to adopt and use the summary of the policies set forth in the compliance guide entitled Integrity: the Spirit and Letter of Our Commitment and the full text of the policies (collectively, the "**Policies**") published on the website "integrity.ge.com" with the modifications required by Section 3.03(b) ("**Genworth Policies**") as Genworth's and its Affiliates' own policies, procedures and guidelines. Genworth and its Affiliates may create (and their respective contractors may create on their behalf), and Genworth and its Affiliates shall own, derivative works and modifications of the Genworth Policies. The Genworth Policies may be (i) used by Genworth's and its Affiliates' employees (including contractors), customers (including brokers and licensed agents) and suppliers, (ii) disclosed as required by applicable Law, and (iii) used by an acquiror of Genworth or its Affiliates or any of the businesses, operations or assets of Genworth or its Affiliates to which this Agreement relates, provided that such acquiror executes an agreement to be bound by all obligations of Genworth and its Affiliates under this Agreement relating to such Policies and Genworth Policies (a copy of which agreement is provided to GE) provided further that such acquiror shall be limited to use of such Genworth Policies solely in connection with such businesses, operations or assets (and not any other businesses, operations or assets of the acquiror). It is understood and agreed that GE makes no representation or warranty as to the suitability of the Policies for use by Genworth and its Affiliates or any of their respective divested businesses.

(b) Notwithstanding anything in this Agreement to the contrary, the text of any Genworth Policies shall not contain (i) any references to GE or its Affiliates, GE or its Affiliates' publications, GE or its Affiliates' personnel (including, without limitation, senior management) or (ii) the title of the Policy Guide (i.e., "Integrity: the Spirit and Letter of Our Commitment"), any portion thereof, or any confusingly similar phrase.

**Section 3.04. Limitation on Rights and Obligations with Respect to the GE Materials** GE shall have no obligation under this Agreement (i) to notify Genworth and its Affiliates of any changes or proposed changes to any of the GE Materials, (ii) to include Genworth and its Affiliates in any consideration of proposed changes to any of the GE Materials, (iii) to provide draft changes of any of the GE Materials to Genworth and its Affiliates for review or comment, or (iv) to provide Genworth and its Affiliates with any updated materials relating to any of the GE Materials (provided that, for the avoidance of doubt, Genworth and its Affiliates shall have no obligation hereunder with respect to any updated or changed GE Materials not received hereunder). The parties hereto acknowledge and agree that, except as expressly set forth above, GE reserves all rights in, to and under, including, without limitation, all Intellectual Property rights with respect to, the GE Materials and no rights with respect to ownership or use, except as otherwise expressly provided herein, shall vest in Genworth and its Affiliates. Further, Genworth and its Affiliates agree to use the same degree of care that Genworth and its Affiliates use with respect to their own information and materials of a similar nature, but in no event less

10

---

than a reasonable degree of care, to ensure that the GE Materials are not used for any purpose other than the purposes set forth above. Genworth and its Affiliates will allow GE reasonable access to personnel and information as reasonably necessary to determine Genworth's and its Affiliates' compliance with the provisions set forth above.

## **ARTICLE IV Covenants**

**Section 4.01. Further Assistance.** Each party hereby covenants and agrees that it shall, at the request of the other party, use commercially reasonable efforts to assist the other party in its efforts to obtain any third party consent, approval or waiver necessary to enable such other party to obtain a license to any Intellectual Property that, but for the requirements set forth in the definition of Control, would be the subject of a license granted pursuant to Section 2.01 or 2.02 hereunder; provided, however, that such party shall not be required to seek broader rights or more favorable terms for the other party than those applicable to such party prior to the date hereof or as may be applicable to such party from time to time thereafter. The parties acknowledge and agree that there can be no assurance that such party's efforts will be successful or that the other party will be able to obtain such licenses or rights on acceptable terms or at all.

**Section 4.02. Ownership.** No party shall represent that it has any ownership interest in any Intellectual Property of the other party licensed hereunder.

### **Section 4.03. Prosecution and Maintenance.**

(a) Generally. Excluding the parties' obligations set forth in Section 4.03(b) in connection with the Applications, each party retains the sole right to protect at its sole discretion the Intellectual Property and Technology owned by such party, including, without limitation, deciding whether and how to file and prosecute applications to register patents, copyrights and mask work rights included in such Intellectual Property, whether to abandon prosecution of such applications, and whether to discontinue payment of any maintenance or renewal fees with respect to any patents; provided, however, that solely with respect to patent applications and issued patents set forth on Schedules A, B, and C, such party will notify the other party in writing prior to abandoning prosecution of such patent applications or discontinuing payment of any maintenance or renewal fees for such issued patents and allow the other party the opportunity to take such action on behalf of such party at the sole expense of the other party.

(b) GENIUS<sup>®</sup>, CIP and Divisional Patent Applications Pursuant to the Master Agreement, GE Financial Assurance Holdings, Inc. or its Affiliate has assigned or will assign to Genworth the patent applications identified on Schedule D (collectively, the "**GENIUS<sup>®</sup> Applications**"). The term "**GENIUS<sup>®</sup> Applications**" as used herein shall include any patents directly resulting from the patent applications described on Schedule D, the first generation of applications based directly on such applications, and any patents directly resulting from such first generation of applications; provided, however, that it shall not include the GE Applications. GE may, at GE's option, file and prosecute with the U.S. Patent and Trademark Office ("**USPTO**") certain continuation-in-part ("**CIP**") and certain divisional patent applications based on the GENIUS<sup>®</sup> Applications as set forth below.

11

---

(i) Before the date hereof, GE shall have filed or caused to be filed with the USPTO the non-provisional CIP patent applications (the "**CIP Applications**"). The term "**CIP Applications**" as used herein shall include any patents directly resulting from the CIP Applications, the first generation of applications based directly on such applications, and any patents directly resulting from such first generation of applications. The CIP Applications shall be described on Schedule E hereto and shall have claims that are independent and distinct from the claims of the GENIUS<sup>®</sup> Applications. Genworth shall promptly notify GE of any restriction requirements from the USPTO permitting the filing of divisional applications based on the GENIUS<sup>®</sup> Applications (the "**Restriction Requirements**"). If GE in its sole discretion elects to file a non-provisional divisional application ("**Divisional Application**") based on any such Restriction Requirement, GE shall so notify Genworth within thirty (30) days of GE's receipt of such Restriction Requirement. The term "**Divisional Applications**" as used herein shall include any patents directly resulting from the Divisional Applications, the first generation of applications based directly on such applications, and any patents directly resulting from such first generation of applications. Any such "**Divisional Applications**" filed prior to the date hereof shall be described on Schedule E. Notwithstanding anything herein to the contrary, GE shall only have the right to file Divisional Applications if the claims of such Divisional Applications correspond to a set of claims identified in a Restriction Requirement, each of which claims in the claim set being directed to subject matter outside of the insurance field. The Divisional Applications and CIP Applications are collectively referred to herein as the "**GE Applications.**" The preparation, filing and prosecution of (i) the GE Applications shall be at GE's sole cost and expense and (ii) the GENIUS<sup>®</sup> Applications shall be at Genworth's sole cost and

expense.

(ii) Each party will use commercially reasonable efforts to ensure that the subject matter and prosecution of the Applications, including all filings and actions taken in connection therewith, do not adversely affect or limit the prosecution, claims, scope, validity or enforceability of the GENIUS® Applications, whether as the result of any double patenting rejection, prior art rejections, prosecution history estoppel matters or otherwise (the “**Prime Directive**”). Each party will also use commercially reasonable efforts to ensure that the subject matter and prosecution of the Applications, including all filings and actions taken in connection therewith, do not adversely affect or limit the prosecution, claims, scope, validity or enforceability of the GE Applications, whether as the result of any double patenting rejection, prior art rejections, prosecution history estoppel matters or otherwise (the “**Secondary Directive**”; the Prime Directive and Secondary Directive are collectively referred to as the “**Prosecution Guidelines**”). The Prosecution Guidelines shall only apply to the Applications. As used in this Section 4.03(b), the terms “prosecute” and “prosecution” and related derivations shall be deemed to include holding and/or maintaining issued patents.

(iii) The parties agree that in the event of any conflict between the Prime Directive and the Secondary Directive, the Prime Directive shall control and take precedence. Subject to the confidentiality provisions of Article VI, each party shall provide the other party with copies of material correspondence with the USPTO relating to the Applications within a sufficient time to allow for meaningful review, and each party shall promptly provide the other party with copies of all Office Actions and correspondence with the USPTO relating to such party’s Applications.

12

---

(iv) In the event it is not possible for a party to prosecute all claims of an Application in compliance with the Prosecution Guidelines, such party shall notify the other party and shall either elect to cease prosecuting the Application or have the other party prosecute the Application. In the event a party elects to cease prosecution of the Application in accordance with the foregoing, such party may abandon the Application, but only after notifying the other party of its intent to do so and, in the event the other party requests assignment of such Application to it, such party shall not abandon the Application and shall assign the Application to the other party whereupon any further prosecution of such Application will be at the other party’s sole cost and expense and the other party shall own all rights to such Application and any resulting patents and such party shall have no right or interest therein. In the event that a rejection with respect to any claims in a GE Application can only be overcome by common ownership by Genworth and GE desires to continue the prosecution of such GE Application, GE will allow Genworth to prosecute such claims, and Genworth shall prosecute such claims, in Genworth’s name at GE’s sole cost and expense. The parties acknowledge that the Applications and all patents issuing on the Applications are subject to the licenses granted under Article II herein; provided, however, that GE and its Affiliates shall have no liability to Genworth in the event a GENIUS® Application is assigned to GE and such GENIUS® Application is not successfully prosecuted, and Genworth and its Affiliates shall have no liability to GE in the event a GE Application is assigned to Genworth and such GE Application is not successfully prosecuted.

(v) In the event a party desires to cease prosecution of or abandon any Application for any reason other than the inability to prosecute such Application in compliance with the Prosecution Guidelines, such party shall notify the other party prior to ceasing prosecution or abandoning the Application and in the event the other party requests assignment of such Application to it, such party shall not abandon the Application and shall assign the Application to the other party whereupon any further prosecution of such Application will be at the other party’s sole cost and expense and the other party shall own all rights to such Application and any resulting patents and such party shall have no right or interest therein.

(vi) As a condition precedent to assignment of any GE Application to a party other than an Affiliate of GE, GE shall (i) notify Genworth prior to such assignment, (ii) obtain the written agreement of such assignee to be bound by the obligations of GE under this Section 4.03 (b), (iii) include Genworth in such written agreement as an intended third party beneficiary thereof and (iv) provide Genworth an executed original of such written agreement.

#### **Section 4.04. Third Party Infringements, Misappropriations, Violations**

(a) Each party shall promptly notify the other party in writing of any actual or possible infringements, misappropriations or other violations of the Intellectual Property of the other party being licensed hereunder by a third party that come to such party’s attention, as well as the identity of such third party or alleged third party and any evidence of such infringement, misappropriation or other violation within such party’s custody or control. The other party shall have the sole right to determine at its sole discretion whether any action shall be taken in response to such infringements, misappropriations or other violations.

13

---

(b) Each party shall promptly notify the other party in writing upon learning of the existence or possible existence of rights held by any third party that may be infringed, misappropriated or otherwise violated by the use or practice of the Intellectual Property of the other party (or any element or portion thereof) licensed hereunder, as well as the identity of such third party and any evidence relating to such purported infringement, misappropriation or other violation within such party’s custody or control. Such party shall cooperate fully with the other party to avoid infringing, misappropriating or violating any third party rights, and shall discontinue all use and practice of such Intellectual Property that is the subject of such purported infringement, misappropriation or other violation upon the reasonable request of the other party.

(c) Each party shall promptly notify the other party in writing upon learning of the existence or possible existence of rights held by any third party that may be infringed, misappropriated or otherwise violated by the use or practice of the Intellectual Property (or any element or portion thereof) licensed to the other party hereunder, as well as the identity of such third party. The other party shall cooperate fully with such party to avoid infringing, misappropriating or violating any third party rights, and shall discontinue all use and practice of such Intellectual Property that is the subject of such purported infringement, misappropriation or other violation upon the reasonable request of such party, and shall provide such party any evidence relating to such purported infringement, misappropriation or other violation within the other party’s custody or control.

**Section 4.05. Patent Marking** Each party acknowledges and agrees that it will comply with all reasonable requests of the other party relative to patent markings required to comply with or obtain the benefit of statutory notice or other provisions.

### **ARTICLE V Term and Termination**

**Section 5.01. Term**. This Agreement shall remain in full force and effect in perpetuity unless terminated in accordance with its terms.

**Section 5.02. No Termination**. This Agreement may only be terminated upon the mutual written agreement of the parties. In the event of a breach of this Agreement, the sole and exclusive remedy of the non-breaching party shall be to recover monetary damages and/or to obtain injunctive or equitable relief.

### **ARTICLE VI Confidentiality**

All Genworth Confidential Information and GE Confidential Information licensed pursuant to this Agreement shall be subject to the terms and conditions set forth in Section 6.2 of the Master Agreement.

14

---

**ARTICLE VII**  
**General Provisions**

**Section 7.01. Assignment.**

(a) This Agreement shall not be assignable, in whole or in part, by any party hereto to any third party, including, without limitation, Affiliates of any party, without the prior written consent of the other party hereto, and any attempted assignment without such consent shall be null and void. Notwithstanding the foregoing, this Agreement may be assigned by any party as follows without obtaining the prior written consent of the other party hereto:

(i) GE, in its sole discretion, may assign this Agreement, and any or all of its rights under this Agreement, and may delegate any or all of its duties under this Agreement to any Affiliate of GE at any time, which expressly accepts such assignment in writing and assumes, as applicable, any such obligations, provided that GE shall continue to remain liable for the performance by such assignee.

(ii) Genworth, in its sole discretion, may assign this Agreement, and any or all of its rights under this Agreement, and may delegate any or all of its duties under this Agreement to any Affiliate of Genworth at any time, which expressly accepts such assignment in writing and assumes, as applicable, any such obligations, provided that Genworth shall continue to remain liable for the performance by such assignee.

(iii) Each party may assign any or all of its rights, or delegate any or all of its duties, under this Agreement to (i) an acquiror of all or substantially all of the equity or assets of the business of such party to which this Agreement relates or (ii) the surviving entity in any merger, consolidation, equity exchange or reorganization involving such party, provided that such acquiror or surviving entity, as the case may be, executes an agreement to be bound by all the obligations of such party under this Agreement (a copy of which agreement is provided to the other party).

(b) If a party requests the written consent of the other party to any assignment of this Agreement, the other party agrees to negotiate in good faith with such party regarding such consent. This Agreement shall also be binding upon and inure to the benefit of and be enforceable by the successors, legal representatives and permitted assigns of each party hereto. All license rights and covenants contained herein shall run with all Intellectual Property of any party licensed hereunder and shall be binding on any successors in interest or assigns thereof.

**Section 7.02. Warranty and Disclaimer.** NOTWITHSTANDING ANYTHING TO THE CONTRARY HEREIN OR IN THE MASTER AGREEMENT, THE INTELLECTUAL PROPERTY LICENSED BY EACH PARTY TO THE OTHER PARTY PURSUANT TO THIS AGREEMENT AND THE GE MATERIALS ARE FURNISHED "AS IS", WITH ALL FAULTS AND WITHOUT WARRANTY OF ANY KIND, EXPRESS, IMPLIED, STATUTORY OR OTHERWISE, INCLUDING, WITHOUT LIMITATION, ANY WARRANTY OF MERCHANTABILITY, FITNESS FOR ANY PARTICULAR PURPOSE, TITLE, NON-INFRINGEMENT, QUALITY, USEFULNESS, COMMERCIAL UTILITY, ADEQUACY, COMPLIANCE WITH ANY LAW, DOMESTIC OR FOREIGN AND IMPLIED WARRANTIES ARISING FROM COURSE OF DEALING OR COURSE OF PERFORMANCE.

**Section 7.03. Consequential and Other Damages.** NEITHER GENWORTH OR ITS AFFILIATES, ON THE ONE HAND, NOR GE OR ITS AFFILIATES, ON THE

15

---

OTHER HAND, SHALL BE LIABLE TO THE OTHER FOR ANY SPECIAL, INDIRECT, INCIDENTAL, PUNITIVE OR CONSEQUENTIAL DAMAGES (PROVIDED THAT ANY SUCH LIABILITY WITH RESPECT TO A THIRD PARTY CLAIM SHALL BE CONSIDERED DIRECT DAMAGES) OF THE OTHER ARISING IN CONNECTION WITH THE TRANSACTIONS HEREUNDER.

**Section 7.04. Assumption of Risk.**

(a) Except as provided in the Master Agreement, Genworth, on behalf of itself and its Affiliates, hereby assumes all risk and liability in connection with their use of the GE Intellectual Property.

(b) Except as provided in the Master Agreement, GE, on behalf of itself and its Affiliates, hereby assumes all risk and liability in connection with their use of the Genworth Intellectual Property.

**Section 7.05. Governing Law.** This Agreement shall be governed by and construed and interpreted in accordance with the Laws of the State of New York irrespective of the choice of Laws principles of the State of New York other than Section 5-1401 of the General Obligations Law of the State of New York.

**Section 7.06. Notices.** All notices, requests, claims, demands and other communications under this Agreement shall be in writing and shall be given or made (and shall be deemed to have been duly given or made upon receipt) by delivery in person, by overnight courier service, by facsimile with receipt confirmed (followed by delivery of an original via overnight courier service) or by registered or certified mail (postage prepaid, return receipt requested) to the respective parties at the following addresses (or at such other address for a party as shall be specified in a notice given in accordance with this Section 7.06):

GE:

General Electric Company  
3135 Easton Turnpike  
Fairfield, CT 06828  
Attention: General Counsel  
with a copy to:

Weil, Gotshal & Manges LLP  
767 Fifth Avenue  
New York, NY 10153  
Attention: Howard Chatzinoff, Esq.

16

---

GENWORTH:

Genworth Financial, Inc.  
6620 West Broad Street  
Richmond, VA 23230

Attention: General Counsel  
with a copy to:

Hunton & Williams LLP  
Riverfront Plaza, East Tower  
951 E. Byrd Street  
Richmond, VA 23219-4074  
Attention: Allen C. Goolsby, Esq.

**Section 7.07. Severability.** If any term or other provision of this Agreement is invalid, illegal or incapable of being enforced under any Law or as a matter of public policy, all other conditions and provisions of this Agreement shall nevertheless remain in full force and effect. Upon such determination that any term or other provision is invalid, illegal or incapable of being enforced, the parties to this Agreement shall negotiate in good faith to modify this Agreement so as to effect the original intent of the parties as closely as possible in a mutually acceptable manner in order that the transactions contemplated by this Agreement be consummated as originally contemplated to the greatest extent possible.

**Section 7.08. Entire Agreement.** This Agreement and the Master Agreement constitute the entire agreement of the parties hereto with respect to the subject matter of this Agreement and supersedes all prior agreements and undertakings, both written and oral, between or on behalf of the parties hereto with respect to the subject matter of this Agreement.

**Section 7.09. No Third-Party Beneficiaries.** This Agreement is for the sole benefit of the parties to this Agreement and their Affiliates and the permitted sublicensees, successors and assigns of the parties and nothing in this Agreement, express or implied, is intended to or shall confer upon any other Person or entity any legal or equitable right, benefit or remedy of any nature whatsoever under or by reason of this Agreement.

**Section 7.10. Amendment.** No provision of this Agreement may be amended or modified except by a written instrument signed by all the parties to this Agreement. No waiver by any party of any provision hereof shall be effective unless explicitly set forth in writing and executed by the party so waiving. The waiver by either party hereto of a breach of any provision of this Agreement shall not operate or be construed as a waiver of any other subsequent breach.

**Section 7.11. Rules of Construction.** Interpretation of this Agreement shall be governed by the following rules of construction: (a) words in the singular shall be held to include the plural and vice versa and words of one gender shall be held to include the other gender as the context requires, (b) references to the terms Article, Section, Paragraph, and Schedule are references to the Articles, Sections, Paragraphs, and Schedules to this Agreement unless otherwise specified, (c) the word "including" and words of similar import shall mean "including,

17

---

without limitation," (d) provisions shall apply, when appropriate, to successive events and transactions, (e) the table of contents and headings contained herein are for reference purposes only and shall not affect in any way the meaning or interpretation of this Agreement and (f) this Agreement shall be construed without regard to any presumption or rule requiring construction or interpretation against the party drafting or causing any instrument to be drafted. Unless specifically stated in the Master Agreement that a particular provision of the Master Agreement should be given effect in lieu of a conflicting provision in this Agreement, to the extent that any provision contained in this Agreement conflicts with, or cannot logically be read in accordance with, any provision of the Master Agreement, the provision contained in this Agreement shall prevail. Notwithstanding the foregoing, nothing in this Agreement shall be deemed to waive a party's rights or relieve or otherwise satisfy any party's obligations under Section 6.12 the Master Agreement.

**Section 7.12. Counterparts.** This Agreement may be executed in one or more counterparts, and by the different parties to each such agreement in separate counterparts, each of which when executed shall be deemed to be an original but all of which taken together shall constitute one and the same agreement. Delivery of an executed counterpart of a signature page to this Agreement by facsimile shall be as effective as delivery of a manually executed counterpart of any such Agreement.

**Section 7.13. Dispute Resolution.** Any dispute, controversy or claim arising out of or relating to the transactions contemplated by this Agreement, or the validity, interpretation, breach or termination of any provision of this Agreement shall be resolved in accordance with Article VII of the Master Agreement.

**Section 7.14. No Waiver.** Failure by either party at any time to enforce or require strict compliance with any provision of this Agreement shall not affect or impair that provision in any way or the rights of such party to avail itself of the remedies it may have in respect of any subsequent breach of that or any other provision. The waiver of any term, condition, or provision of this Agreement must be in writing and signed by an authorized representative of the waiving party. Any such waiver will not be construed as a waiver of any other term, condition, or provision, nor as a waiver of any subsequent breach of the same term, condition, or provision, except as provided in a signed writing.

**Section 7.15. Relationship of the Parties.** Nothing contained herein is intended or shall be deemed to make any party the agent, employee, partner or joint venturer of the other or be deemed to provide such party with the power or authority to act on behalf of the other party or to bind the other party to any contract, agreement or arrangement with any other individual or entity.

*[Remainder of this page left intentionally blank]*

18

---

IN WITNESS WHEREOF, GE and Genworth have caused this Agreement to be executed on the date first written above by their respective duly authorized officers.

GENERAL ELECTRIC COMPANY

By \_\_\_\_\_  
Name:  
Title:

GENWORTH FINANCIAL, INC.

By \_\_\_\_\_  
Name:

**SCHEDULES**

<a href="#">SCHEDULE A</a>	<a href="#">Certain GE Intellectual Property</a>
<a href="#">SCHEDULE B</a>	<a href="#">Certain Genworth Intellectual Property</a>
<a href="#">SCHEDULE C</a>	<a href="#">Restricted GE Intellectual Property</a>
<a href="#">SCHEDULE D</a>	<a href="#">GENIUS<sup>®</sup>-Applications</a>
<a href="#">SCHEDULE E</a>	<a href="#">CIP Applications</a>

**SCHEDULE A****Certain GE Intellectual Property****I. SOFTWARE, TOOLKITS AND OTHER MATERIALS**

All (i) copyrights, mask work rights, database rights and design rights, whether or not registered, published or unpublished, and registrations and applications for registration thereof, and all rights therein whether provided by international treaties or conventions or otherwise and (ii) trade secrets associated with the following:

1. SSO:  
GE Group's Single Sign On Security new user registration and password update Software
  2. Join GE:  
GE Group's H/R onboarding Software
  3. eEMS:  
GE Group's EMS H/R Software
  4. Compensation Planning Application:  
GE Group's Salary, Stock Option & Other Incentive Comp Planning System Software
  5. IT Project Risk Assessment:  
GE Group's IT Project Risk Assessment tool Software
  6. Integrity Website:  
GE Group's Integrity Website Software
  7. Career Opportunity System:  
GE Group's Job opportunities H/R intranet site Software
  8. eSessionC:  
GE Group's eSessionC H/R Software
  9. eExit:  
GE Group's eExit H/R Software
  10. eStart:  
GE Group's eStart H/R Software
  11. Consumer Analytics Platform:  
GE Partnership Marketing Group's (PMG) Consumer Analytics Platform Software, excluding (i) third party data and (ii) customer data
  12. Oracle H/R Software Modifications Owned by the GE Group:  
Enhancements, modifications, configuration, etc. to base Oracle H/R module owned by the GE Group
  13. IP Digital Cockpit:  
IP Digital Cockpit Software
  14. GOLDnet:  
GOLDnet Software
- 
15. A2P2:  
A2P2 Investments Software for cash forecasting, reporting and allocation
  16. DOT:  
DOT Investments Software for real estate loan origination
  17. Monster:  
Monster Investments Software for derivatives accounting
  18. REM:  
REM Investments Software for risk monitoring
  19. PV01:  
PV01 Investments Software for risk monitoring/cash hedging
  20. TIPS:  
TIPS Investments Software
  21. CATS:  
CATS Investments Software
  22. Trading Compliance Limits:  
Limit 5.0 / Trigger 6.0 Investments Software
  23. DREAMS:  
DREAMS Investments Software
  24. Investments Data Warehouse:  
Investments Data Warehouse Software for Insurance
  25. Ulysses Software:  
Ulysses Software, including web-based requisition module and other enhancements, modifications, configuration, etc. to the base Oracle SSS module owned by the GE Group
  26. IMLP Tracking System:  
GE Group's Information Management Leadership Program (IMLP) Tracking System Software
  27. Media Activity System (MAS):  
Media Activity System (MAS) Software

28. GE Group's Strategic Toolkits, including
- Workout!
  - CAP (Change Acceleration Process)
  - Facilitative Leadership
  - ACFC (At the Customer For the Customer)
  - QMI (Quick Market Intelligence)
  - DMAIC
  - NPI/DFSS incl. Gen III (New Product Introduction / Design For Six Sigma)
  - Globalization
  - Session I, II, C, D, IP
  - GE Group's Policies & Procedures
- 
29. Training:  
Crotonville Course Materials including but not limited to
- NMDC (New Manager Development Course)
  - MDC (Manager Development Course)
  - BMC (Business Management Course)
  - EDC (Executive Development Course)
  - AIMC (Advanced Information Management Course)
- CLOE (Center for Learning & Organizational Excellence) Course Materials including but not limited to
- PRL (Personnel Relations Leadership)
30. Finance:  
GE Group's GAAP Reference Materials  
GE Group's Finance Toolkit  
GE Group's Sourcing Toolkit
31. Human Resources:  
GE Group's Human Resources Toolkit  
GE Group's Communications Toolkit  
Resolve  
GE Group's Program Materials, including
- IMLP (Information Management Leadership Program)
  - FMP (Financial Management Program)
  - HRLP (Human Resources Leadership Program)
  - CLP (Commercial Leadership Program)
  - RMLP (Risk Management Leadership Program)
32. Risk:  
GE Group's Risk Management Toolkit
33. Information Technology:  
GE Group's IT Toolkit  
Security Risk Assessment Toolkit
34. Legal/Compliance:  
GE Group's Legal Toolkit  
GE Group's Compliance Toolkit
35. Marketing:  
GE Group's Marketing Toolkit
36. Operations:  
Crisis Management Toolkit
37. Business Development:  
GE Group's Business Development Toolkit
38. GE Group's Survey Suite
39. eHR Website
40. eInvoicing:  
GE will provide Blue Ridge with source code for any enhancements, modification, configurations, etc. to the base eInvoicing Software owned by the GE Group
- 

41. Safari-Expense:  
Safari Expense Software
42. BAAS / Bank Account Administration Software
43. IBS / Intercompany Billing System Software
44. Sourcing Datawarehouse(s) / GSTAR & Proclarity
45. MyDevelopment@GE Software
46. 360 Degree Peer Evaluation System Software
47. Integrity Website Software
48. eMeasure Software
49. Transaction Control Authority Software
50. GE Health Advantage Software
51. Health By Numbers E Program Software
52. PAS Extracts Software (GE/CMS developed)
53. PAS Workflow Software (GE/CMS developed)
54. CMS Data Warehouse Software (GE/CMS developed)
55. FASB 133 Hedge Accounting Software
56. CMS P&L Report Software
57. Deal Tracker Software
58. HotDocs Integration Software



59. PROFITS Toolkit  
 60. Portfolio Optimizer: Asset/Liability Matching, Portfolio Optimization Tool Software

**II. PATENTS**

<u>GE Docket Number</u>	<u>H&amp;W File No.</u>
85FA-00141	52493.000083
85FA-00142	52493.000081
85FA-00143	52493.000082
85FA-00144	52493.000079

**SCHEDULE B**

**Certain Genworth Intellectual Property**

**I. SOFTWARE, TOOLKITS AND OTHER MATERIALS**

All (i) copyrights, mask work rights, database rights and design rights, whether or not registered, published or unpublished, and registrations and applications for registration thereof, and all rights therein whether provided by international treaties or conventions or otherwise and (ii) trade secrets associated with the following:

1. MyGoals:  
Genworth Group's MyGoals H/R Software
2. Privacy/Opt-Out:  
Genworth Group's Consumer Privacy Management Software
3. Complaint Log System (CLS):  
Genworth Group's Complaint Log System Software
4. Death Claims System:  
Genworth Group's Death Claims Cross-Checking Software
5. EWD:  
Genworth Group's Enterprise-Wide Disbursement Software
6. SMART:  
Genworth Group's Sales Management and Report Tracking System Software
7. e-Learning:  
Genworth Group's developed e-Learning courseware Software
8. Change Control System Software (Europe):  
Genworth Group's web-based Change Control System Software
9. Compliance Management System (CMS):  
Genworth Group's Compliance Management System Software
10. Genworth Strategic Toolkits, including:  
P.I.E.  
HomeRun  
e-QuTOPS PMO Toolkit, including Project Place Software
11. Training:  
"GEFA-U" Course Materials including but not limited to
  - Foundations of Leadership
  - Interview & Selections
 Business Leadership Impact Symposium  
 Lean Transactions
12. Human Resources:  
Genworth Group's Program Materials, including
  - LDP (Leadership Development Program)
  - ALDP (Actuarial Leadership Development Program)
13. Risk:  
Genworth Group's Risk Management Toolkit
14. Information Technology:  
Genworth Group's DMADOV Methodology
15. Legal/Compliance:  
Outsourcing Toolkit including the Migration Toolkit
16. Operations:  
Genworth Group's Crisis Management Toolkit
17. GE Center for Financial Learning Materials, including the "Managing Your Credit" Module

**II. PATENTS**

<u>GE Docket Number</u>	<u>H&amp;W File No.</u>
85FA-00100	52493.000118 and 52493.000153
85FA-00101	52493.000032
85FA-00103	52493.000126
85FA-00104	52493.000036
85FA-00105	52493.000037

85FA-00106	52493.000040 and 52493.000170
85FA-00107	52493.000041 and 52493.000169
85FA-00108	52493.000065
85FA-00109	52493.000058 and 52493.000175
85FA-00110	52493.000046 and 52493.000191
85FA-00111	52493.000056
85FA-00112	52493.000183
85FA-00113	52493.000060
85FA-00114	52493.000063 and 52493.000188
85FA-00115	52493.000061

---

<b>GE Docket Number</b>	<b>H&amp;W File No.</b>
85FA-00116	52493.000059 and 52493.000220
85FA-00117	52493.000057
85FA-00118	52493.000130
85FA-00119	52493.000062
85FA-00120	52493.000068
85FA-00121	52493.000054 and 52493.000244
85FA-00123	52493.000045
85FA-00124	52493.000048 and 52493.000217
85FA-00125	52493.000047
85FA-00126	52493.000053
85FA-00127	52493.000050
85FA-00128	52493.000067
85FA-00129	52493.000066
85FA-00130	52493.000075 and 52493.000116
85FA-00132	File # available
85FA-00134	52493.000124 and 52493.000235
85FA-00135	52493.000070
85FA-00136	52493.000072
85FA-00137	52493.000073 and 52493.000189
85FA-00138	52493.000076 and 52493.000197
85FA-00139	52493.000080
85FA-00140	52493.000084
85FA-00145	52493.000085 and 52493.000201

---

<b>GE Docket Number</b>	<b>H&amp;W File No.</b>
85FA-00146	52493.000086
85FA-00147	52493.000087 and 52493.000186

85FA-00148	52493.000091 and 52493.000222
85FA-00149	52493.000090 and 52493.000225
85FA-00150	52493.000089
85FA-00151	52493.000093 and 52493.000212
85FA-00152	52493.000095
85FA-00153	52493.000096
85FA-00154	52493.000221
85FA-00155	52493.000099 and 52493.000266
85FA-00156	52493.000101 and 52493.000196
85FA-00157	52493.000114 and 52493.000193 and 52493.000102
85FA-00158	52493.000100
85FA-00159	52493.000103
85FA-00160	52493.000104 and 52493.000215
85FA-00161	File # available
85FA-00162	52493.000105
85FA-00163	52493.000107 and 52493.000275
85FA-00164	52493.000108
85FA-00165	52493.000109
85FA-00166	52493.000110
85FA-00167	52493.000111
85FA-00168	52493.000112 and 52493.000246

---

<b>GE Docket Number</b>	<b>H&amp;W File No.</b>
85FA-00169	File # available
85FA-00170	52493.000121 and 52493.000202
85FA-00171	52493.000123 and 52493.000338
85FA-00172	52493.000119
85FA-00173	52493.000129 and 52493.000243
85FA-00174	52493.00128
85FA-00175	52493.000127 and 52493.000257
85FA-00176	52493.000125
85FA-00177	52493.000139 and 52493.000224
85FA-00178	52493.000145
85FA-00179	52493.000135
85FA-00180	52493.000131
85FA-00181	52493.000134
85FA-00182	52493.000136 and 52493.000242
85FA-00183	52493.000143
85FA-00184	52493.000138
85FA-00185	52493.000141
85FA-00186	52493.000142
85FA-00187	52493.000163 and 52493.000321
85FA-00188	File # available
85FA-00189	52493.000133 and 52493.000270

85FA-00190	52493.000152 and 52493.000256
85FA-00191	52493.000151 and 52493.000274

---

<u>GE Docket Number</u>	<u>H&amp;W File No.</u>
85FA-00192	52493.000155 and 52493.000255
85FA-00193	52493.000156 and 52493.000278 and 52493.000337
85FA-00194	52493.000157 and 52493.000273
85FA-00195	52493.000164
85FA-00196	52493.000165 and 52493.000247
85FA-00197	52493.000166 and 52493.000265
85FA-00198	52493.000162
85FA-00199	52493.000233
85FA-00200	52493.000229
85FA-00201	52493.000185
85FA-00202	52493.000234
85FA-00203	52493.000237
85FA-00204	52493.000238
85FA-00205	52493.000239
85FA-00206	52493.000161
85FA-00207	52493.000168 and 52493.000282
85FA-00208	52493.000171 and 52493.000286
85FA-00209	52493.000264 and 52493.000172 and 52493.000304 and 52493.000343
85FA-00210	File # available
85FA-00211	File # available
85FA-00212	52493.000176 and 52493.000299

---

<u>GE Docket Number</u>	<u>H&amp;W File No.</u>
85FA-00213	52493.000179
85FA-00214	52493.000187
85FA-00215	52493.000199
85FA-00216	52493.000208
85FA-00217	52493.000205
85FA-00218	52493.000204
85FA-00219	52493.000231
85FA-00220	52493.000230
85FA-00221	52493.000261
85FA-00222	52493.000251 and 52493.000328
85FA-00223	52493.000252
85FA-00224	52493.000253
85FA-00225	52493.000260
85FA-00226	52493.000262
85FA-00227	52493.000277
85FA-00228	52493.000281
85FA-00229	52493.000302
85FA-00230	52493.000301
85FA-00231	52493.000297
85FA-00232	52493.000296
85FA-00233	52493.000295

85FA-00234	52493.000303
85FA-00235	52493.000298
85FA-00236	52493.000300
85FA-00237	File # available
85FA-00238	52493.000328
85FA-00241	52493.000203 and 52493.000339
85FA-00243	File # available
85FA-00244	52493.000170
(US 85FA-00106)	(US .000040)
85FA-00245	52493.000308
85FA-00246	52493.000309
85FA-00247	52493.000311
85FA-00248	52493.000312
85FA-00249	52493.000160

<u>GE Docket Number</u>	<u>H&amp;W File No.</u>
85FA-00250	
129271	52493.000310
RD 30958	
85FA-00250	52493.000313
85FA-00252	52493.000258
85FA-00253	52493.000346
85FA-00254	52493.000344
—	52493.000349

**SCHEDULE C**

**Restricted GE Intellectual Property**

**SCHEDULE D**

**GENIUS® Applications**

<u>Item #</u>	<u>GE PAGE Ref No</u>	<u>H&amp;W Ref No/ Invention</u>
1	132193	52493.000160
2	135072	52493.000161
3	135965	52493.000162
4	129502	52493.000185
5	135017	52493.000229
6	135007	52493.000233
7	135063	52493.000234
8	135066	52493.000237
9	135068	52493.000238
10	135069	52493.000239
11	126469	52493.000295
12	126463	52493.000296
13	126931	52493.000303
14	139466	52493.000308
15	139470	52493.000309
16	129271	52493.000310

**SCHEDULE E**

**CIP Applications**

One CIP Application will add new material to 139470

## COINSURANCE AGREEMENT

between

GE LIFE AND ANNUITY ASSURANCE COMPANY

and

UNION FIDELITY LIFE INSURANCE COMPANY

Dated as of April 15, 2004

TABLE OF CONTENTS

<a href="#">ARTICLE I</a>	<a href="#">DEFINITIONS</a>
<a href="#">ARTICLE II</a>	<a href="#">COVERAGE</a>
<a href="#">ARTICLE III</a>	<a href="#">ADMINISTRATION: GENERAL PROVISIONS</a>
<a href="#">ARTICLE IV</a>	<a href="#">CLAIMS SETTLEMENT ACCOUNT: CLAIMS</a>
<a href="#">ARTICLE V</a>	<a href="#">REINSURANCE ASSET TRANSFER: CEDING COMMISSION</a>
<a href="#">ARTICLE VI</a>	<a href="#">EXPENSE ALLOWANCES</a>
<a href="#">ARTICLE VII</a>	<a href="#">ACCOUNTING AND SETTLEMENT</a>
<a href="#">ARTICLE VIII</a>	<a href="#">DURATION AND TERMINATION</a>
<a href="#">ARTICLE IX</a>	<a href="#">INSOLVENCY</a>
<a href="#">ARTICLE X</a>	<a href="#">CREDIT FOR REINSURANCE</a>
<a href="#">ARTICLE XI</a>	<a href="#">REINSURANCE SECURITY</a>
<a href="#">ARTICLE XII</a>	<a href="#">DEFERRED ACQUISITION COSTS</a>
<a href="#">ARTICLE XIII</a>	<a href="#">DISPUTE RESOLUTION</a>
<a href="#">ARTICLE XIV</a>	<a href="#">MISCELLANEOUS PROVISIONS</a>

SCHEDULES

<a href="#">SCHEDULE A</a>	=	<a href="#">POLICY FORMS</a>
<a href="#">SCHEDULE B</a>	=	<a href="#">FORM OF ADMINISTRATIVE SERVICES AGREEMENT</a>
<a href="#">SCHEDULE C</a>	=	<a href="#">CEDING COMMISSION</a>
<a href="#">SCHEDULE D</a>	=	<a href="#">ASSETS</a>
<a href="#">SCHEDULE E</a>	=	<a href="#">EXPENSE ALLOWANCES</a>
<a href="#">SCHEDULE F - PART I</a>	=	<a href="#">INITIAL REPORT</a>
<a href="#">SCHEDULE F - PART II</a>	=	<a href="#">QUARTERLY REPORT</a>
<a href="#">SCHEDULE F - PART III</a>	=	<a href="#">ANNUAL REPORT</a>
<a href="#">SCHEDULE G</a>	=	<a href="#">FORM OF TRUST AGREEMENT</a>
<a href="#">SCHEDULE H</a>	=	<a href="#">ELIGIBLE SECURITIES</a>

COINSURANCE AGREEMENT

This Coinsurance Agreement, dated as of April 15, 2004 (this "Agreement"), is made and entered into by and between GE Life and Annuity Assurance Company, an insurance company organized under the laws of the Commonwealth of Virginia (the "Company"), and Union Fidelity Life Insurance Company, an insurance company organized under the laws of the State of Illinois (the "Reinsurer"). Defined terms used herein are defined below.

The Company and the Reinsurer mutually agree to reinsure the risks described in this Agreement under the terms and conditions stated herein. This Agreement is an indemnity coinsurance agreement solely between the Company and the Reinsurer, and the performance of the obligations of each party under this Agreement shall be rendered solely to the other party. In no instance shall anyone other than the Company or the Reinsurer have any rights under this Agreement. The Company shall be and shall remain the only party hereunder that is liable to any insured, contract holder, policyholder, claimant or beneficiary under any insurance policy or contract reinsured hereunder.

This Agreement is entered into in connection with an intercompany reorganization among the Company, the Reinsurer and certain of their Affiliates.

## DEFINITIONS

1.1. Definitions. As used in this Agreement, the following terms shall have the following meanings (definitions are applicable to both the singular and the plural forms of each term defined in this Article):

“Accounting Period” means calendar quarter, except that the last Accounting Period shall be the period commencing with the first day of the calendar quarter in which the Termination Date falls and ending with the Termination Date.

“Affiliate” means any other Person that directly or indirectly controls, is controlled by, or is under common control with, the first Person. “Control” (including the terms, “controlled by” and “under common control with”) means the possession, directly or indirectly, of the power to direct or cause the direction of the management and policies of a Person, whether through the ownership of voting securities, by contract or credit arrangement, as trustee or executor, or otherwise.

“Agreement” shall have the meaning specified in the first paragraph of this Agreement.

“Annual Report” shall have the meaning specified in Section 7.4.

“Applicable Law” means any federal, state, local or foreign law (including common law), statute, ordinance, rule, regulation, order, writ, injunction, judgment, permit, governmental agreement or decree applicable to a Person or any of such Person’s subsidiaries,

---

properties, assets, or to such Person’s officers, directors, managing directors, employees or agents in their capacity as such.

“Assets” shall have the meaning specified in Section 5.3(a).

“Assignment Letter Agreement” means the letter agreement dated the date hereof among General Electric Capital Corporation, a Delaware corporation, the Reinsurer, the Company and certain affiliates of the Company relating to the assignment by General Electric Capital Corporation of the Capital Maintenance Agreement.

“Benefits” shall have the meaning specified in Section 2.3(a).

“Business Day” means any day other than a Saturday, Sunday or other day on which commercial banks in the States of Illinois or Virginia are required or authorized by law to be closed.

“Capital Maintenance Agreement” means the Capital Maintenance Agreement between General Electric Capital Corporation, a Delaware corporation, and the Reinsurer.

“Ceding Commission” shall have the meaning specified in Section 5.2.

“Claims Settlement Account” shall have the meaning specified in Section 4.1(a).

“Closing Date” means April 15, 2004.

“Code” means the Internal Revenue Code of 1986, as amended.

“Company Account” shall have the meaning specified in Section 11.1(e).

“CPR” shall have the meaning specified in Section 13.3.

“CPR Arbitration Rules” shall have the meaning specified in Section 13.4(a).

“Dispute” shall have the meaning specified in Section 13.1(a).

“Eligible Securities” shall have the meaning specified in Section 11.1(c).

“Expense Allowance” shall have the meaning specified in Section 6.1.

“Extra Contractual Liabilities” means all liabilities for damages (including compensatory, consequential, exemplary, punitive, bad faith or similar or other damages) which relate to the marketing, sale, underwriting, issuance, delivery, cancellation or administration of the Reinsured Contracts, including liability arising out of or relating to any alleged or actual acts, errors or omissions by the Company or its agents, whether intentional or otherwise, with respect to any of the Reinsured Contracts, including (A) any alleged or actual reckless conduct or bad faith in connection with the handling of any claim arising out of or under Reinsured Contracts, or (B) the marketing, sale, underwriting, issuance, delivery, cancellation or administration of any of the Reinsured Contracts.

---

“Force Majeure” shall have the meaning specified in Section 3.7(b)(iii).

“Funding Requirement” shall have the meaning specified in Section 11.1(e).

“GAAP” means U.S. generally accepted accounting principles consistently applied.

“Governmental Authority” means any foreign or national government, any state or other political subdivision thereof, and any entity exercising executive, legislative, judicial, regulatory or administrative functions of or pertaining to government.

“Inception Date” shall have the meaning specified in Section 2.1.

“Initial Notice” shall have the meaning specified in Section 13.2.

“Initial Reinsurance Premium” shall have the meaning specified in Section 5.1.

“Initial Report” shall have the meaning specified in Section 7.1.

“Insolvency Fund” means any guarantee fund, insolvency fund, plan, pool, association, fund or other arrangement, however denominated, established or governed, which provides for any assessment of or payment or assumption by the Company of part or all of any claim, debt, charge, fee or other obligation of an insurer or reinsurer, or its successors or assigns, which has been declared by any competent authority to be insolvent, or which is otherwise deemed unable to meet any claim, debt, charge, fee or other obligation in whole or in part.

“Minimum Claims Settlement Amount” shall have the meaning specified in Section 4.1(b).

“Person” means any natural person, firm, limited liability company, general partnership, limited partnership, joint venture, association, corporation, trust, Governmental Authority or other entity.

“Quarterly Report” shall have the meaning specified in Section 7.2.

“Quarterly Settlement” shall have the meaning specified in Section 5.3(a).

“RBC Reporting Letter Agreement” means the letter agreement dated the date hereof among the Company, the Reinsurer and certain affiliates of the Company relating to the Reinsurer’s requirement to provide periodic certifications and reports regarding the Reinsurer’s risk based capital ratio.

“Reinsured Contracts” means the structured settlements immediate annuity contracts issued by the Company and recorded in the Company’s valuation system on or prior to December 3, 2003 or reinsured by the Company under reinsurance agreements in effect prior to January 1, 2004, and, in each case, written on the policy forms described in Schedule A.

“Reinsured Risks” shall have the meaning specified in Section 2.1.

3

---

“Response” shall have the meaning specified in Section 13.2.

“SAP” means statutory accounting practices prescribed or permitted by the Insurance Department of the Commonwealth of Virginia.

“Tax DAC” means specified policy acquisition expenses capitalized and amortized under section 848 of the Code.

“Termination Date” means the effective date of any termination of this Agreement as provided in Article VIII.

“Termination Letter Agreement” means the letter agreement dated the date hereof among the Company, the Reinsurer and certain affiliates of the Company relating to the rescission of this Agreement upon the failure of certain events to occur after the date hereof.

“Total SAP Ceded Reserves” means, as of any given date, the gross policy reserves of the Company calculated in accordance with SAP with respect to the Reinsured Risks.

“Total GAAP Ceded Reserves” means, as of any given date, the gross policy reserves of the Company calculated in accordance with GAAP with respect to the Reinsured Risks.

“Trust Account” shall have the meaning set forth in Section 11.1(a).

“Trust Agreement” shall have the meaning set forth in Section 11.1(a).

“Trustee” shall have the meaning set forth in Section 11.1(a).

## ARTICLE II

### COVERAGE

2.1. Coverage. Upon the terms and subject to the conditions and other provisions of this Agreement, as of 12:01 a.m. Eastern Time on January 1, 2004 (the “Inception Date”), the Company hereby cedes to the Reinsurer, and the Reinsurer hereby agrees to indemnify the Company for, one hundred percent (100%) of the liability incurred by the Company for Benefits on or after the Inception Date (the “Reinsured Risks”).

2.2. Conditions. (a) If the Company’s liability under any of the Reinsured Contracts is changed because of changes made on or after the Inception Date in the terms and conditions of the Reinsured Contracts (including to any contract riders or endorsements thereto) that are required due to changes in Applicable Law, the Reinsurer will share in the change proportionately to the coinsurance share hereunder and the Company and the Reinsurer will make all appropriate adjustments to amounts due each other under this Agreement.

(b) Except as otherwise set forth in paragraph (a) above, no changes, amendments or modifications made on or after the Inception Date in the terms and conditions of the

4

---

Reinsured Contracts which adversely affect the liability of the Reinsurer hereunder shall be covered hereunder without the prior written approval of such changes, amendments or modifications by the Reinsurer, which approval shall not be unreasonably withheld or delayed. In the event that any such changes, amendments or modifications are made in any Reinsured Contract without the prior written approval of the Reinsurer, this Agreement will cover liability incurred by the Company for Benefits as if the non-approved changes, amendments or modifications had not been made.

2.3. Benefits. (a) Subject to the provisions of Sections 2.2, 2.3(b) and (c) and the terms and conditions of this Agreement, “Benefits” shall mean the actual benefits payable by the Company under the Reinsured Contracts.

(b) Any Extra Contractual Liabilities resulting from actions of the Company or its agents or reinsured by the Company under the Reinsured Contracts shall be treated as a Benefit payable for the purposes of this Agreement to the extent permitted by state law, except to the extent that any such Extra Contractual Liabilities are attributable to the conduct of the Company in the administration of the Reinsured Contracts on or after the Inception Date, other than actions taken by the Company at the written request or direction of the Reinsurer.

(c) This Agreement excludes all liability arising by contract, operation of law, or otherwise from the Company’s participation or membership, whether voluntary or involuntary, in any Insolvency Fund.



2.4. Territory. The territorial limits of this Agreement shall be identical with those of the Reinsured Contracts.

2.5. Ceded Reinsurance. Subsequent to the Inception Date, the Company will not enter into any reinsurance arrangements with respect to the Reinsured Contracts without the prior written consent of the Reinsurer, in its sole discretion.

### ARTICLE III

#### ADMINISTRATION; GENERAL PROVISIONS

3.1. Contract Administration. (a) Subject to Section 3.7, the Company shall provide policyholder and claims servicing with respect to the Reinsured Contracts in accordance with the terms hereof. All Benefits paid by the Company shall be binding upon the Reinsurer; provided, however, that such Benefits are within the terms, conditions and limitations of the Reinsured Contracts. The Company shall provide policyholder and claims servicing with respect to the Reinsured Contracts (including the administration of claims for Benefits thereunder) in good faith and with the care, skill, prudence and diligence of a person experienced in administering structured settlement business. The Company shall provide policyholder and claims servicing with respect to the Reinsured Contracts, (i) in accordance with the terms of the Reinsured Contracts, (ii) in accordance with the applicable terms of this Agreement, (iii) in compliance with Applicable Law and, subject to the foregoing, (iv) in the same manner as it conducts its own business not subject to this Agreement and (v) in accordance with the Company's administrative performance standards in effect on the date hereof, with such revisions

5

---

to such standards as are no less favorable to the Reinsurer than such standards. Notwithstanding the foregoing, the parties may, from time to time, mutually develop specific and/or different standards for providing such services with respect to the Reinsured Contracts.

(b) The Company may subcontract for the performance of any policyholder or claims servicing service or services with respect to the Reinsured Contracts to (i) an Affiliate or (ii) any other Person with the prior written consent of the Reinsurer, such consent not to be unreasonably withheld; provided, that the Company also subcontracts for such service or services for its own structured settlement annuities business not subject to this Agreement to such subcontractor; and provided, further, that no such subcontracting shall relieve the Company from any of its obligations or liabilities hereunder, and the Company shall remain responsible for all obligations or liabilities of such subcontractor with regards to the providing of such service or services as if provided by the Company.

3.2. Claims Settlements. The Company agrees that it will provide prompt notice to the Reinsurer of its intention to contest, compromise or litigate a claim with respect to a Reinsured Contract, along with copies of all pleadings and reports of investigation with respect thereto. The Reinsurer shall have the right, at its own expense, to participate jointly with the Company in the investigation, adjustment or defense of such claims. In addition, in the event that litigation arises against the Company in connection with a claim which seeks damages in excess of \$1 million or other remedies deemed material to the Reinsurer, the Reinsurer may, upon written notice to the Company, assume the defense thereof with counsel selected by the Reinsurer and reasonably satisfactory to the Company. If the Reinsurer assumes such defense, the Company shall have the right, at its own expense, to participate jointly with the Reinsurer in the defense thereof. If the Reinsurer assumes the defense of litigation, the Reinsurer shall not settle such litigation without the Company's prior written consent (which consent shall not be unreasonably withheld or delayed) unless (i) there is no finding or admission of any violation of law or any violation of the rights of any Person, (ii) such settlement would not reasonably be expected to have material adverse precedential consequences to the Company and (iii) the sole relief provided is monetary damages that are paid in full by the Reinsurer.

3.3. Inspection. The Company shall keep accurate and complete records, files and accounts of all transactions and matters with respect to the Reinsured Contracts and the administration hereof in accordance with Applicable Law and its record management practices in effect from time to time for the Company's insurance business not covered by this Agreement. The Reinsurer and its designated representatives may upon reasonable notice inspect, at the offices of the Company where such records are located, the papers and any and all other books or documents of the Company reasonably relating to this Agreement, including the Reinsured Contracts and the administration thereof by the Company (including compliance with the provisions of Section 3.1), and shall have access to appropriate employees and representatives of the Company, in each case during normal business hours for such period as this Agreement is in effect or for as long thereafter as the Company seeks performance by the Reinsurer pursuant to the terms of this Agreement or the Reinsurer reasonably needs access to such records for regulatory, tax or similar purposes. The information obtained shall be used only for purposes relating to the transactions contemplated under this Agreement.

6

---

3.4. Errors and Omissions. If any delay, omission, error or failure to pay amounts due or to perform any other act required by this Agreement is unintentional and caused by misunderstanding or oversight, the Company and the Reinsurer will adjust the situation to what it would have been had the misunderstanding or oversight not occurred. The party first discovering such misunderstanding or oversight, or an act resulting from such misunderstanding or oversight, will notify the other party in writing promptly upon discovery thereof, and the parties shall act to correct such misunderstanding or oversight within twenty (20) Business Days of such other party's receipt of such notice. However, this Section shall not be construed as a waiver by either party of its right to enforce strictly the terms of this Agreement.

3.5. Age, Sex and Other Adjustments. If the Company's liability under any of the Reinsured Contracts is changed because of a misstatement of age or sex or any other material fact, the Reinsurer will share in the change proportionately to the coinsurance share hereunder and the Company and the Reinsurer will make all appropriate adjustments to amounts due each other under this Agreement.

3.6. Setoff. Any debts or credits, matured or unmatured, in favor of or against either the Company or the Reinsurer with respect to this Agreement or any other reinsurance agreement between the Company and the Reinsurer, are deemed mutual debts or credits, as the case may be, and shall be setoff from any amounts due to the Company or the Reinsurer hereunder, as the case may be, and only the net balance shall be allowed or paid.

3.7. Administration by Reinsurer. (a) At any time from and after the fifteenth (15th) anniversary of the Inception Date, the Reinsurer shall have the right to assume from the Company the administration of the Reinsured Contracts, provided that the Reinsurer provides twelve (12) months prior written notice of such assumption, which notice may be given as early as the fourteenth (14th) anniversary of the Inception Date to take effect as of the fifteenth (15th) anniversary of the Inception Date. The Reinsurer shall bear all transition costs associated with an assumption of the administration of the Reinsured Contracts pursuant to this paragraph (a) of this Section 3.7.

(b) In addition to the provisions of Section 3.7(a), the Reinsurer shall have the right, upon written notice to the Company to assume from the Company the administration of the Reinsured Contracts upon the occurrence of any of the following events:

- (i) A voluntary or involuntary proceeding is commenced in any jurisdiction by or against the Company for the purpose of conserving, rehabilitating or liquidating the Company;
- (ii) There is a material breach by the Company of any material term or condition of this Article III that is not cured by the Company within thirty (30) days after receipt of written notice from the Reinsurer of such breach or act (provided that the Reinsurer shall not have the right to assume such administration (A) for so long as the Company is making a good faith effort to cure such a breach, not to exceed an additional one hundred eighty (180) days or (B) during the pendency of any dispute resolution

proceedings as set forth in Article XIII regarding an alleged material breach); or

(iii) The Company is unable to perform the services required under this Article III for a period of thirty (30) consecutive days for any reason, other than as a result of a Force Majeure, it being understood that nothing in this Section 3.7(b)(iii) shall relieve the Company from its administrative responsibilities under this Agreement. For purposes of this Agreement "Force Majeure" means any acts or omissions of any civil or military authority, acts of God, acts or omissions of the Reinsurer, fires, strikes or other labor disturbances, equipment failures, fluctuations or non-availability of electrical power, heat, light, air conditioning or telecommunications equipment, or any other act, omission or occurrence beyond the Company's reasonable control, irrespective of whether similar to the foregoing enumerated acts, omissions or occurrences.

(c) The Company shall bear all transition costs associated with an assumption of the administration of the Reinsured Contracts pursuant to Section 3.7(b).

(d) In the event of the Reinsurer's assumption of the administration of the Reinsured Contracts, the Reinsurer and the Company shall enter into an administrative services agreement in the form attached hereto as Schedule B and the provisions of Article VI and Article VII shall become inoperative.

#### ARTICLE IV

##### CLAIMS SETTLEMENT ACCOUNT; CLAIMS

4.1. Claims Settlement Account. (a) On the Closing Date, the Reinsurer shall establish a separate bank account (the "Claims Settlement Account") in its own name for the payment of Benefits and shall authorize two signatories who shall be representatives of the Company and approved by the Reinsurer in writing to issue drafts in the name of the Reinsurer and showing the identity of the Company. The Reinsurer shall fund such account for payment of Benefits in accordance with the provisions of Section 4.1(b). Any interest earned on the Claims Settlement Account shall belong to the Reinsurer. The Claims Settlement Account shall be administered by the Company in a fiduciary capacity and shall be used solely by the Company to make payments of Benefits in accordance with the terms of this Agreement.

(b) The Reinsurer shall deposit \$3 million in the Claims Settlement Account on the Closing Date and shall thereafter fund the Claims Settlement Account on or before the fifth (5th) day of each month in amounts agreed by the Company and the Reinsurer from time to time in amounts sufficient to provide funds to the Company for the payment of Benefits during the next thirty (30) days, or such other amount as may be mutually agreed by the parties (such initial deposit amount and each minimum funding amount as agreed from time to time shall be referred to as a "Minimum Claims Settlement Amount"). In addition, the Reinsurer shall deposit to the Claims Settlement Account such additional amounts as may be required to keep

the balance of such account above zero at all times. In consideration of the Reinsurer providing the Claims Settlement Account arrangement, the Company agrees that it shall apply funds in the Claims Settlement Account against the Reinsurer's liability under this Agreement until such funds are exhausted.

(c) The Company shall keep true and complete records, in accordance with Applicable Law and its record management practices in effect from time to time for the Company's insurance business not covered by this Agreement, clearly recording the deposits in and withdrawals from the Claims Settlement Account, including records relating to the payment of Benefits from the Claim Settlement Account. The Company will make available to the Reinsurer or its designated representative, or shall furnish to the Reinsurer or its designated representative, upon request of the Reinsurer or its designated representative, copies of all such records. All copies furnished in the ordinary course of business shall be furnished by the Company at the Company's cost, which shall be included in the Expense Allowance. Any extraordinary costs reasonably incurred by the Company in response to requests from the Reinsurer shall be reimbursed by the Reinsurer.

(d) Within thirty (30) days after each calendar month (or more frequently as mutually agreed by the parties), the Company shall render a complete accounting to the Reinsurer detailing all transactions with respect to the Claims Settlement Account, in such form as agreed by the parties.

(e) The parties agree to deliver to the depository bank such depository resolutions, signature cards, and other documents as may be requested of them in order to use such accounts at the depository bank in accordance with the provisions of this Article IV.

(f) Upon a termination of this Agreement pursuant to Article VIII, the Reinsurer shall close the Claims Settlement Account and any closing balance therein shall be the property of the Reinsurer. The Company's claims payment authority under this Agreement with respect to the Claims Settlement Account shall terminate immediately upon termination of this Agreement pursuant to Article VIII or the assumption by the Reinsurer of the administration of the Reinsured Contracts pursuant to Section 3.7. Upon termination of its authority to pay claims, the Company shall promptly return to the Reinsurer all unused check stock held by it in connection with this Agreement.

#### ARTICLE V

##### REINSURANCE ASSET TRANSFER; CEDING COMMISSION

5.1. Initial Reinsurance Premium. As consideration for the reinsurance by the Reinsurer of the Reinsured Risks under this Agreement, on the Closing Date the Reinsurer shall be entitled to an amount equal to one hundred percent (100%) of the Total SAP Ceded Reserves as of the close of business on the day immediately preceding the Inception Date (the "Initial Reinsurance Premium").

5.2. Ceding Commission. On the Closing Date, the Company shall be entitled to a ceding commission (the "Ceding Commission") in an amount determined in accordance with Schedule C.

5.3. Amounts Due the Parties. (a) Except as otherwise specifically provided herein, all amounts due to be paid to the Company under this Agreement shall be determined on a net basis, giving full effect to Section 3.6. The net amount due the Reinsurer from the Company on the Closing Date under Section 5.1 and Section 5.2 shall consist of (i) the investment assets (the "Assets") set forth on Schedule D, which assets have a statutory book value as of the close of business on the day immediately preceding the Inception Date equal to (A) the Initial Reinsurance Premium, less (B) the Ceding Commission, less (C) an amount equal to accrued but unpaid interest on the Assets as of the close of business on the day immediately preceding the Inception Date, plus (ii) an amount equal to the investment cash flows received on the Assets between the Inception Date and the Closing Date. The Company shall pay such net amount concurrent with its delivery of the Initial Report. Each net amount subsequently due with respect to each Accounting Period ending after the Inception Date (the "Quarterly Settlement") shall be paid in cash by the Reinsurer to the Company no later than thirty (30) days after delivery of the Quarterly Report, as applicable. Each net amount subsequently due with respect to each calendar year ending after the Inception Date as reflected on an Annual Report shall be paid in cash by the Reinsurer to the Company no later than thirty (30) days after delivery of the Annual Report.

(b) The Company shall deliver to the Reinsurer possession of the Assets and such bills of sale, endorsements, assignments and other good and sufficient instruments of conveyance and transfer in form and substance reasonably acceptable to the parties as shall be effective to vest in the Reinsurer all of the right, title and interest of the Company in and to the Assets. Delivery of the Assets shall be a condition precedent of reinsurance coverage hereunder.

ARTICLE VI  
EXPENSE ALLOWANCES

6.1. Expense Allowance. As reimbursement for expenses incurred by the Company in the providing of policyholder and Benefit payment services with respect to the Reinsured Contracts, the Reinsurer shall pay to the Company with respect to each calendar month ending after the Inception Date, an expense allowance (each an "Expense Allowance") in an amount calculated in accordance with Schedule E, as subsequently adjusted in accordance with the methodology and procedures set forth on Schedule E.

ARTICLE VII  
ACCOUNTING AND SETTLEMENT

7.1. Initial Report. A report shall be provided by the Company to the Reinsurer on the Closing Date providing the data required in Schedule F - Part I (the "Initial Report").

10

---

7.2. Quarterly Settlement Reports. As soon as practicable but not more than forty (40) days following each Accounting Period ending after the Closing Date (or more frequently as mutually agreed by the parties), the Company shall supply the Reinsurer with a report that shall provide the financial data for such Accounting Period required in Schedule F - Part II (the "Quarterly Report"). For the avoidance of doubt, the first Quarterly Report will include all transactions with respect to the Reinsured Contracts occurring from the Inception Date through June 30, 2004.

7.3. Quarterly Financial Reports. As soon as practicable but not more than forty (40) days following the end of each Accounting Period ending after the Closing Date (or more frequently as mutually agreed by the parties), the Company shall supply the Reinsurer with reports related to the Reinsured Contracts as may be reasonably requested for use in connection with the preparation of the Reinsurer's SAP financial statements or other reports prepared by the Reinsurer in compliance with its internal reporting requirements. The parties shall cooperate in good faith to establish the form for the providing of such reports.

7.4. Annual Reports. Within forty-five (45) days after the end of each calendar year during the term of this Agreement (or more frequently as mutually agreed by the parties), the Company shall supply the Reinsurer with a report that shall provide the financial data for such year required in Schedule F - Part III (the "Annual Report").

7.5. Additional Reports and Updates. For so long as this Agreement remains in effect, each of the parties shall periodically furnish to the other such other reports and information as may be reasonably requested by such other party for regulatory, tax or similar purposes and reasonably available to it.

7.6. Delayed Payments. In the event that all or any portion of any payment due either party pursuant to this Agreement becomes overdue, the portion of the amount overdue shall bear interest at an annual rate equal to the then current thirty (30) day U.S. Treasury Bill discount rate on the date that the payment becomes overdue plus 200 basis points, for the period that the amount is overdue.

ARTICLE VIII  
DURATION AND TERMINATION

8.1. Duration. Except as otherwise provided herein, this Agreement shall be unlimited in duration.

8.2. Reinsurer's Liability. The Reinsurer's liability with respect to the Reinsured Risks will terminate on the earliest of: (i) the date the Company's liability with respect to the Reinsured Risks is terminated and all amounts due the Company from the Reinsurer with respect to such Reinsured Risks are paid to the Company by or on behalf of the Reinsurer; and (ii) the date this Agreement is terminated upon the written agreement of the parties.

11

---

8.3. Notice of Termination. Upon the termination of the Reinsurer's liability with respect to the Reinsured Risks referred to in Section 8.2 above, the parties shall mutually give the Trustee written notice of their intention to terminate the Trust Account.

ARTICLE IX  
INSOLVENCY

9.1. Payments. In the event of the insolvency of the Company, the reinsurance payable by the Reinsurer hereunder shall be payable directly to the Company or to its domiciliary liquidator or receiver on the basis of the liability of the Reinsurer under the contract or contracts reinsured, without diminution because of the insolvency of the Company. It is agreed and understood, however, that (i) in the event of the insolvency of the Company, the Reinsurer shall be given written notice of the pendency of a claim against the insolvent Company on a Reinsured Contract within a reasonable time after such claim is filed in the insolvency proceeding and (ii) during the pendency of such claim the Reinsurer may investigate such claim and interpose, at its own expense, in the proceeding where such claim is to be adjudicated any defenses which it may deem available to the Company or its domiciliary liquidator, receiver or statutory successor.

9.2. Expenses. It is further understood that any expense thus incurred by the Reinsurer pursuant to Section 9.1 shall be chargeable, subject to court approval, against the insolvent Company as part of the expense of liquidation to the extent of a proportionate share of the benefit which may accrue to the Company solely as a result of the defense undertaken by the Reinsurer. Where two or more assuming reinsurers are involved in the same claim and a majority in interest elect to interpose defenses to such claim, the expense shall be apportioned in accordance with the terms of this Agreement as though such expense had been incurred by the Company.

ARTICLE X  
CREDIT FOR REINSURANCE

10.1. Reinsurance Credit. Notwithstanding any other provision of this Agreement to the contrary, if the Reinsurer becomes unauthorized or otherwise unaccredited as an insurer or reinsurer in any U.S. jurisdiction to which the Company must provide statutory statements of financial condition such that the Company will not obtain full statutory financial statement credit for reinsurance in such state for the reinsurance provided under this Agreement, the Reinsurer, upon the request of the Company,

will establish, at the Reinsurer's sole cost and option, trust accounts for the benefit of the Company, letters of credit, or other acceptable alternatives necessary to permit the Company to obtain such full statutory financial statement credit for such reinsurance in all applicable jurisdictions. The Company shall cooperate with the Reinsurer to take such steps. In addition, in such event, the Reinsurer agrees to amend this Agreement and the Trust Agreement to the extent required under Applicable Law in order to provide the Company with such full statutory financial statement credit.

---

ARTICLE XI

REINSURANCE SECURITY

11.1. Trust. (a) On the Closing Date, the Reinsurer shall enter into a trust agreement in the form attached as Schedule G (the "Trust Agreement") and establish a trust account (the "Trust Account") for the benefit of the Company with respect to the Reinsured Risks with a bank (the "Trustee") designated as a Qualified United States Financial Institution by the Securities Valuation Office of the National Association of Insurance Commissioners or any successor organization or regulatory agency having similar duties.

(b) The Reinsurer agrees to deposit, and maintain in the Trust Account with respect to this Agreement, assets to be held in trust by the Trustee for the benefit of the Company as security for the payment of the Reinsurer's obligations to the Company under this Agreement.

(c) The parties agree that the assets so deposited with respect to this Agreement shall be valued according to their current statutory book value on the books of the Reinsurer and shall consist only of cash (United States legal tender), certificates of deposit (issued by a United States bank and payable in United States legal tender), and other assets of the type specified on Schedule H attached hereto ("Eligible Securities").

(d) The Reinsurer, prior to depositing assets with the Trustee, shall execute all assignments and endorsements in blank, or transfer legal title to the Trustee of all shares, obligations or any other assets requiring assignments, in order that, to the extent practicable, the Company, or the Trustee upon direction of the Company, may whenever necessary negotiate any such assets without consent or signature from the Reinsurer or any other entity. The Company recognizes that certain assets in the Trust Account will not be readily negotiable and that certain notices, opinions of counsel, representations and/or consents will be required for the Company to obtain good and marketable title to such assets.

(e) The Reinsurer and the Company agree that the assets in the Trust Account with respect to this Agreement may be withdrawn for the following purposes only:

- (i) to pay or reimburse the Company for any amount due the Company pursuant to this Agreement to the extent not so paid or reimbursed by the Reinsurer;
- (ii) to pay to the Reinsurer, in accordance with paragraph (h) below, any amounts held in the Trust Account that exceed an amount (the "Funding Requirement") equal to the sum of Total SAP Ceded Reserves and any additional reserves attributable to the Reinsured Risks that arise as a result of regulatory asset adequacy analysis requirements of the Reinsurer, less, prior to the date on which the Claims Settlement Account is closed, the Minimum Claims Settlement Amount then in effect; and
- (iii) in the event that General Electric Capital Corporation breaches its obligations under the Capital Maintenance Agreement, to fund an account

---

with the Company (the "Company Account") in an amount at least equal to the deduction, for reinsurance ceded, from the Company's liabilities ceded under this Agreement. Such amount shall include, but not be limited to, amounts for policy reserves, reserves for claims and losses incurred (including losses incurred but not reported), loss and loss adjustment expenses, and unearned premiums.

(f) In the event that the Company withdraws assets from the Trust Account for the purposes set forth in Section 11.1(e)(i) above in excess of actual amounts required to meet the Reinsurer's obligations to the Company, the Company will promptly return such excess to the Reinsurer, plus interest at an annual rate equal to the then current thirty (30) day U.S. Treasury Bill discount rate on the date of withdrawal plus 200 basis points for the period during which the amounts were held pursuant to Section 11.1(e)(i). In the event that the Company withdraws assets from the Trust Account for the purposes set forth in Section 11.1(e)(iii) above, (i) the Reinsurer shall be relieved of its obligation to maintain assets in the Trust Account pursuant to this Section 11.1 to the extent of the amount of funds held in the Company Account and (ii) the Company shall first apply the funds in the Company Account in satisfaction of the Reinsurer's liability under this Agreement until the funds in the Company Account are exhausted. In the event that the Company withdraws assets from the Trust Account for the purposes set forth in Section 11.1(e)(iii) above, promptly following the date the Reinsurer's liability with respect to the Reinsured Risks is terminated, the Company shall return to the Reinsurer any assets so withdrawn that, together with any and all interest, dividends and other earnings thereon from the date of withdrawal to the date of return, are in excess of actual amounts required to meet the Reinsurer's obligations to the Company under this Agreement.

(g) The initial deposit to the Trust Account with respect to this Agreement shall be made on the Closing Date and shall consist of assets with a statutory book value equal to the Total SAP Ceded Reserves as of the close of business on the day immediately preceding the Inception Date, less an amount of assets with a statutory book value equal to the initial Minimum Claims Settlement Amount.

(h) The aggregate statutory book value of the assets held in the Trust Account with respect to this Agreement, shall at all times be at least equal to the Funding Requirement, and shall be adjusted on a quarterly basis so as to equal the Funding Requirement. On a quarterly basis, the Company shall promptly prepare and deliver to the Reinsurer a specific statement of the Funding Requirement and the Reinsurer shall promptly prepare and deliver to the Company a specific statement of the statutory book value of the assets in the Trust Account, in each case as of the end of the quarter. If the statement shows that the Funding Requirement exceeds 100% of the balance of the Trust Account with respect to this Agreement as of the statement date, the Reinsurer shall, within ten (10) Business Days after receipt of such notice of excess, secure delivery to the Trustee of additional cash or Eligible Securities having a current statutory book value equal to such difference. If the statement shows that the Funding Requirement is less than 100% of the balance of the Trust Account with respect to this Agreement as of the statement date, the Company shall, within ten (10) Business Days after delivery of such statement to the Reinsurer, deliver a notice of withdrawal to the Trustee directing the Trustee to withdraw from the Trust Account and deliver to the Reinsurer assets from the Trust Account having a current statutory book value equal to such excess amount. In

---

addition to the foregoing, the Reinsurer shall prepare and deliver to the Company on a quarterly basis a specific statement of the market value of the assets in the Trust Account as of the end of the quarter.

ARTICLE XII

## DEFERRED ACQUISITION COSTS

12.1. Tax DAC Information Sharing To ensure consistency in their respective Tax DAC calculations for tax purposes, the Company and the Reinsurer will exchange information pertaining to the amount of net consideration under this Agreement each year. The Company will submit a schedule to the Reinsurer by February 28 of each year presenting its calculation of the net consideration for the preceding taxable year. The Reinsurer may contest the calculation by providing to the Company an alternative calculation in writing within thirty (30) days of receipt of the Company's schedule. The Company and the Reinsurer will act in good faith to resolve any differences in the schedule of calculations within thirty (30) days of receipt of the alternative calculation to ensure consistent amounts are reported on the respective tax returns for the preceding tax year.

## ARTICLE XIII

### DISPUTE RESOLUTION

13.1. General Provisions. (a) Any dispute, controversy or claim arising out of or relating to this Agreement or the validity, interpretation, breach or termination thereof (a "Dispute"), shall be resolved in accordance with the procedures set forth in this Article XIII, which shall be the sole and exclusive procedures for the resolution of any such Dispute unless otherwise specified below.

(b) Commencing with the request contemplated by Section 13.2, all communications between the parties or their representatives in connection with the attempted resolution of any Dispute, including any mediator's evaluation referred to in Section 13.3, shall be deemed to have been delivered in furtherance of a Dispute settlement and shall be exempt from discovery and production, and shall not be admissible in evidence for any reason (whether as an admission or otherwise), in any arbitral or other proceeding for the resolution of the Dispute.

(c) In connection with any Dispute, the parties expressly waive and forego any right to (i) punitive, exemplary, statutorily-enhanced or similar damages in excess of compensatory damages, and (ii) trial by jury.

(d) The specific procedures set forth below, including but not limited to the time limits referenced therein, may be modified by agreement of the parties in writing.

15

---

(e) All applicable statutes of limitations and defenses based upon the passage of time shall be tolled while the procedures specified in this Article XIII are pending. The parties will take such action, if any, required to effectuate such tolling.

13.2. Consideration by Senior Executives. If a Dispute is not resolved in the normal course of business at the operational level, the parties shall attempt in good faith to resolve such Dispute by negotiation between executives who hold, at a minimum, the office of President and CEO of the respective business entities involved in such Dispute. Either party may initiate the executive negotiation process by providing a written notice to the other (the "Initial Notice"). Fifteen (15) days after delivery of the Initial Notice, the receiving party shall submit to the other a written response (the "Response"). The Initial Notice and the Response shall include (i) a statement of the Dispute and of each party's position, and (ii) the name and title of the executive who will represent that party and of any other person who will accompany the executive. Such executives will meet in person or by telephone within thirty (30) days of the date of the Initial Notice to seek a resolution of the Dispute.

13.3. Mediation. If a Dispute is not resolved by negotiation as provided in Section 13.2 within forty-five (45) days from the delivery of the Initial Notice, then either party may submit the Dispute for resolution by mediation pursuant to the CPR Institute for Dispute Resolution (the "CPR") Model Mediation Procedure as then in effect. The parties will select a mediator from the CPR Panels of Distinguished Neutrals, but such mediator must have prior U.S. reinsurance experience either as a lawyer or as a present or former officer or management employee of a reinsurance company, but not of the Company, or the Reinsurer, or any of their respective affiliates. Either party at commencement of the mediation may ask the mediator to provide an evaluation of the Dispute and the parties' relative positions.

13.4. Arbitration. (a) If a Dispute is not resolved by mediation as provided in Section 13.3 within thirty (30) days of the selection of a mediator (unless the mediator chooses to withdraw sooner), either party may submit the Dispute to be finally resolved by arbitration pursuant to the CPR Rules for Non-Administered Arbitration as then in effect (the "CPR Arbitration Rules"). The parties consent to a single, consolidated arbitration for all known Disputes existing at the time of the arbitration and for which arbitration is permitted.

(b) The neutral organization for purposes of the CPR Arbitration Rules will be the CPR. The arbitral tribunal shall be composed of three arbitrators who are each experienced in the U.S. reinsurance business, of whom each party shall appoint one in accordance with the "screened" appointment procedure provided in Rule 5.4 of the CPR Arbitration Rules. The non-party appointed arbitrator must have prior U.S. reinsurance experience as a present or former officer or management employee of a reinsurance company, but not of the Company, or the Reinsurer, or any of their respective affiliates. The arbitration shall be conducted in New York City. Each party shall be permitted to present its case, witnesses and evidence, if any, in the presence of the other party. A written transcript of the proceedings shall be made and furnished to the parties. The arbitrators shall determine the Dispute in accordance with the law of Virginia, without giving effect to any conflict of law rules or other rules that might render such law inapplicable or unavailable, and shall apply this Agreement according to its terms, provided that the provisions relating to arbitration shall be governed by the Federal Arbitration Act, 9 U.S.C. §§ 1 et seq. The arbitral tribunal shall endeavor to render its award or order resulting

16

---

from any arbitration within forty-five (45) days following the termination of the arbitration proceedings.

(c) The parties agree to be bound by any award or order resulting from any arbitration conducted hereunder and further agree that judgment on any award or order resulting from an arbitration conducted under this Section may be entered and enforced in any court having jurisdiction thereof.

(d) Except as expressly permitted by this Agreement, no party will commence or voluntarily participate in any court action or proceeding concerning a Dispute, except (i) for enforcement as contemplated by Section 13.4(c) above, (ii) to restrict or vacate an arbitral decision based on the grounds specified under applicable law, or (iii) for interim relief as provided in paragraph (e) below. For purposes of the foregoing the parties hereto submit to the non-exclusive jurisdiction of the courts of the State of New York.

(e) In addition to the authority otherwise conferred on the arbitral tribunal, the tribunal shall have the authority to make such orders for interim relief, including injunctive relief, as it may deem just and equitable. Notwithstanding paragraph (d) above, each party acknowledges that in the event of any actual or threatened breach of certain of the provisions of this Agreement, the remedy at law would not be adequate, and therefore injunctive or other interim relief may be sought immediately to restrain such breach. If the tribunal shall not have been appointed, either party may seek interim relief from a court having jurisdiction if the award to which the applicant may be entitled may be rendered ineffectual without such interim relief. Upon appointment of the tribunal following any grant of interim relief by a court, the tribunal may affirm or disaffirm such relief, and the parties will seek modification or rescission of the court action as necessary to accord with the tribunal's decision.

(f) Each party will bear its own attorneys' fees and costs incurred in connection with the resolution of any Dispute in accordance with this Article XIII.

ARTICLE XIV

MISCELLANEOUS PROVISIONS

14.1. Headings and Schedules. Headings used herein are not a part of this Agreement and shall not affect the terms hereof. The attached Schedules are a part of this Agreement.

14.2. Notices. All notices, requests, demands and other communications under this Agreement must be in writing and will be deemed to have been duly given or made as follows: (a) if sent by registered or certified mail in the United States return receipt requested, upon receipt; (b) if sent by reputable overnight air courier, two business days after mailing; (c) if sent by facsimile transmission, with a copy mailed on the same day in the manner provided in (a) or (b) above, when transmitted and receipt is confirmed by telephone; or (d) if otherwise actually personally delivered, when delivered, and shall be delivered as follows:

17

---

If to the Company:

GE Life and Annuity Assurance Company  
6610 West Broad Street  
Richmond, VA 23230  
Facsimile: (804) 281-6165  
Attention: Chief Executive Officer

With a copy to:

GE Life and Annuity Assurance Company  
6610 West Broad Street  
Richmond, VA 23230  
Facsimile: (804) 281-6005  
Attention: General Counsel

If to the Reinsurer:

Union Fidelity Life Insurance Company  
200 North Martingale Road  
Schaumburg, IL 60173-2096  
Facsimile: (847) 330-3404  
Attention: Chief Financial Officer

With a copy to:

Union Fidelity Life Insurance Company  
200 North Martingale Road  
Schaumburg, IL 60173-2096  
Facsimile: (847) 605-3044  
Attention: General Counsel

or to such other address or to such other Person as either party may have last designated by notice to the other party.

14.3. Successors and Assigns. This Agreement shall be binding upon and inure to the benefit of the parties hereto and their respective successors, permitted assigns and legal representatives. Neither this Agreement, nor any right or obligation hereunder, may be assigned by any party without the prior written consent of the other party hereto. Any assignment in violation of this Section 14.3 shall be void and shall have no force and effect. Nothing in this Section 14.3 shall be construed to prohibit the Reinsurer from retroceding all or any portion of the business reinsured hereunder.

14.4. Execution in Counterpart. This Agreement may be executed by the parties hereto in any number of counterparts, and by each of the parties hereto in separate counterparts, each of which counterparts, when so executed and delivered, shall be deemed to be an original, but all such counterparts shall together constitute but one and the same instrument.

18

---

14.5. Currency. Whenever the word "Dollars" or the "\$" sign appear in this Agreement, they shall be construed to mean United States Dollars, and all transactions under this Agreement shall be in United States Dollars.

14.6. Amendments. This Agreement may not be changed, altered or modified unless the same shall be in writing executed by the Company and the Reinsurer.

14.7. Governing Law. This Agreement will be construed, performed and enforced in accordance with the laws of the Commonwealth of Virginia without giving effect to its principles or rules of conflict of laws thereof to the extent such principles or rules would require or permit the application of the laws of another jurisdiction.

14.8. Entire Agreement; Severability. (a) This Agreement and the Termination Letter Agreement constitute the entire agreement between the parties hereto relating to the subject matter hereof and supersede all prior and contemporaneous agreements, understandings, statements, representations and warranties, negotiations and discussions, whether oral or written, of the parties and there are no general or specific warranties, representations or other agreements by or among the parties in connection with the entering into of this Agreement or the subject matter hereof except as specifically set forth or contemplated herein or in the Termination Letter Agreement.

(b) If any provision of this Agreement is held to be void or unenforceable, in whole or in part, (i) such holding shall not affect the validity and enforceability of the remainder of this Agreement, including any other provision, paragraph or subparagraph, and (ii) the parties agree to attempt in good faith to reform such void or unenforceable provision to the extent necessary to render such provision enforceable and to carry out its original intent.

14.9. Contemporaneous Agreements. Concurrent with the execution of this Agreement, the parties and/or their Affiliates are also entering into the Capital Maintenance Agreement, the RBC Reporting Letter Agreement and the Assignment Letter Agreement.

14.10. No Waiver; Preservation of Remedies. No consent or waiver, express or implied, by any party to or of any breach or default by any other party in the performance by such other party of its obligations hereunder shall be deemed or construed to be a consent or waiver to or of any other breach or default in the performance of obligations hereunder by such other party hereunder. Failure on the part of any party to complain of any act or failure to act of any other party or to declare any other party in default, irrespective of how long such failure continues, shall not constitute a waiver by such first party of any of its rights hereunder. The rights and remedies provided are cumulative and are not exclusive of any rights or remedies that any party may otherwise have at law or equity.

14.11. Cooperation. Each party hereto shall cooperate fully with the other in all reasonable respects in order to accomplish the objectives of this Agreement including making available to each their respective officers and employees for interviews and meetings with Governmental Authorities and furnishing any additional assistance, information and documents as may be reasonably requested by a party from time to time.

19

---

14.12. Third Party Beneficiary. Nothing in this Agreement will confer any rights upon any Person that is not a party or a successor or permitted assignee of a party to this Agreement.

14.13. Tax Exception to Any Confidentiality. Notwithstanding anything to the contrary set forth herein or in any other agreement to which the parties hereto are parties or by which they are bound, any obligations of confidentiality contained herein and therein, as they relate to the transactions, shall not apply to the federal tax structure or federal tax treatment of the transactions, and each party hereto (and any employee, representative, or agent of any party hereto) may disclose to any and all persons, without limitation of any kind, the federal tax structure and federal tax treatment of the transactions. The preceding sentence is intended to cause the transactions to be treated as not having been offered under conditions of confidentiality for purposes of Section 1.6011-4(b)(3) (or any successor provision) of the Treasury Regulations promulgated under Section 6011 of the Internal Revenue Code of 1986, as amended, and shall be construed in a manner consistent with such purpose. In addition, each party hereto acknowledges that it has no proprietary or exclusive rights to the federal tax structure of the transactions or any federal tax matter or federal tax idea related to the transactions.

14.14. Interpretation. Wherever the words "include," "includes" or "including" are used in this Agreement, they shall be deemed to be followed by the words "without limitation."

14.15. Survival. Article XIII and Article XIV shall survive the termination of this Agreement.

20

---

IN WITNESS WHEREOF, the parties hereto have caused this Agreement to be executed by their duly authorized representatives.

GE LIFE AND ANNUITY ASSURANCE COMPANY

By /s/ VICTOR C. MOSES  
Title: Vice President  
Name: Victor C. Moses

UNION FIDELITY LIFE INSURANCE COMPANY

By /s/ GLENN JOPPA  
Name: Glenn Joppa  
Title: Senior Vice President and Secretary

21

---

SCHEDULE A

POLICY FORMS

8001

8101

8201

8401

1700

---

SCHEDULE B

FORM OF ADMINISTRATIVE SERVICES AGREEMENT

---

SSA UFLIC/GELAAC

ADMINISTRATIVE SERVICES AGREEMENT

by and between

GE LIFE AND ANNUITY ASSURANCE COMPANY

and

UNION FIDELITY LIFE INSURANCE COMPANY

Effective as of [       ]

---

---

**ADMINISTRATIVE SERVICES AGREEMENT**

This ADMINISTRATIVE SERVICES AGREEMENT (this "Agreement"), effective as of [       ] (the "Effective Date"), is entered into by and between GE LIFE AND ANNUITY ASSURANCE COMPANY, an insurance company organized under the laws of the Commonwealth of Virginia (the "Company"), and UNION FIDELITY LIFE INSURANCE COMPANY, an insurance company organized under the laws of the State of Illinois (the "Administrator").

**RECITALS:**

WHEREAS, the Company and the Administrator have entered into a Coinsurance Agreement dated as of April 15, 2004 (the "Coinsurance Agreement") which provides for the parties to enter into this Agreement;

WHEREAS, pursuant to the Coinsurance Agreement, the Administrator has agreed to indemnify the Company for, among other things, 100% of the liability of the Company for Benefits payable on or after the Inception Date with respect to the Reinsured Contracts (capitalized terms used herein and not defined herein, unless otherwise indicated, have the respective meanings assigned to them in the Coinsurance Agreement); and

WHEREAS, the Company wishes to appoint the Administrator to provide policyholder and claim servicing with respect to the Reinsured Contracts, and the Administrator desires to provide such administrative services;

NOW, THEREFORE, in consideration of the covenants and agreements set forth herein, the parties hereto agree as follows:

ARTICLE I

AUTHORITY

The Company hereby appoints the Administrator, and the Administrator hereby accepts appointment, to provide as an independent contractor of the Company, from and after the Effective Date, all of the policyholder and claim servicing services necessary or appropriate with respect to the Reinsured Contracts including those set forth in this Agreement (the "Administrative Services"), all on the terms as set forth in this Agreement. Notwithstanding any other provision of this Agreement to the contrary, the Company shall have the right to direct the Administrator to perform any action necessary for the Reinsured Contracts or the policyholder and claim servicing thereof to comply with Applicable Law, or to cease performing any action that constitutes a violation of Applicable Law.

---

ARTICLE II

STANDARD FOR SERVICES; FACILITIES; SUBCONTRACTING

2.1. Standard for Services. The Administrator shall provide policyholder and claims servicing with respect to the Reinsured Contracts in good faith and with the care, skill, prudence and diligence of a person experienced in administering structured settlement business. Without limiting the generality of the foregoing, the Administrator shall provide policyholder and claims servicing with respect to the Reinsured Contracts (i) in accordance with the terms of the Reinsured Contracts, (ii) in accordance with the applicable terms of this Agreement, (iii) in compliance with Applicable Law, (iv) in accordance with industry standards and, subject to the foregoing, (v) to the extent applicable, in the same manner as it conducts its own business not subject to this Agreement.

2.2. Facilities and Personnel. To the extent not sub-contracted to a Subcontractor, the Administrator shall at all times maintain sufficient facilities and trained personnel of the kind necessary to perform its obligations under this Agreement in accordance with the performance standards set forth herein.

2.3. Subcontracting. The Administrator may subcontract for the performance of any policyholder or claims servicing service or services with respect to the Reinsured Contracts to (i) an Affiliate or (ii) any other Person with the prior written consent of the Company, such consent not to be unreasonably withheld (in each case, the "Subcontractor"); provided, that, no such subcontracting shall relieve the Administrator from any of its obligations or liabilities hereunder, and the Administrator shall remain responsible for all obligations or liabilities of such Subcontractor with regards to the providing of such service or services as if provided by the Administrator.

ARTICLE III

CLAIMS HANDLING

The Administrator shall pay all Benefits payable on or after the Inception Date with respect to the Reinsured Contracts (each, a "Claim" and collectively the "Claims").

ARTICLE IV

REGULATORY AND LEGAL PROCEEDINGS

4.1. Regulatory Complaints and Proceedings. The Administrator shall:

- (i) respond to any Claims payment related complaints or inquiries made by any Governmental Authority, within the Governmental Authority's requested time frame for response or, if no such time frame is provided, within the time frame as allowed by Applicable Law; and promptly provide a copy of such response to the Company;



- 
- (ii) promptly notify the Company of any non-Claims payment related complaints or inquiries initiated by a Governmental Authority, and of any proceedings (either Claims or non-Claims related) initiated by a Governmental Authority, and, in either case, prepare and send to the Governmental Authority, with a copy to the Company, a response within the Governmental Authority's requested time frame for response or, if no such time frame is provided, within the time frame as allowed by Applicable Law; provided, that, subject to meeting such time frames, the Administrator shall provide such response to the Company for its prior review and comment;
  - (iii) subject to Section 4.4, supervise and control the investigation, contest, defense and/or settlement of all complaints, inquiries and proceedings by Governmental Authorities at its own cost and expense, and in the name of the Company when necessary; and
  - (iv) at the Company's request, provide to the Company a report in a form mutually agreed by the parties summarizing the nature of any complaints, inquiries or proceedings by Governmental Authorities, the alleged actions or omissions giving rise to such complaints, inquiries or proceedings and copies of any files or other documents that the Company may reasonably request in connection with its review of these matters.

4.2. Legal Proceedings. The Administrator shall:

- (i) notify the Company promptly of any lawsuit, action, arbitration or other dispute resolution proceedings that are instituted or threatened with respect to any matter relating to the Reinsured Contracts ("Legal Proceeding(s)"), and in no event more than five (5) Business Days after receipt of notice thereof;
- (ii) subject to Section 4.4, supervise and control the investigation, contest, defense and/or settlement of all Legal Proceedings at its own cost and expense, and in the name of the Company when necessary; and
- (iii) keep the Company fully informed of the progress of all Legal Proceedings handled by the Administrator in which the Company is named a party and, at the Company's request, provide to the Company a report summarizing the nature of any Legal Proceedings, the alleged actions or omissions giving rise to such Legal Proceedings and copies of any files or other documents that the Company may reasonably request in connection with its review of these matters in each case other than such files, documents and other information as would, in the judgment of counsel to the Administrator, lead to the loss or waiver of legal privilege.

4.3. Notice to Administrator. The Company shall give prompt notice to the Administrator of any Legal Proceeding made or brought against the Company after the Inception

Date arising under or in connection with the Reinsured Contracts to the extent known to it and not made against or served on the Administrator or a Subcontractor as administrator hereunder, and in no event more than five (5) Business Days after receipt of notice thereof, and shall promptly furnish to the Administrator copies of all pleadings in connection therewith. The Administrator shall assume the defense of the Company.

4.4. Defense of Regulatory and Legal Proceedings. Notwithstanding anything in this Agreement to the contrary, the Company shall have the right to engage in its own separate legal representation, at its own expense, and to participate fully in the defense of any Legal Proceedings or complaints, inquiries or proceedings by Governmental Authorities with respect to the Reinsured Contracts in which the Company is a named party without waiving any right to indemnification it may have under Article XV hereof. The Administrator and the Company shall cooperate with each other with respect to the administration of any Legal Proceeding and any complaint, inquiry or proceeding by Governmental Authorities. The Administrator shall not settle any Legal Proceeding or any complaint, inquiry or proceeding by Governmental Authorities without the Company's prior written consent (which consent shall not be unreasonably withheld or delayed) unless (i) there is no finding or admission of any violation of law or any violation of the rights of any Person, (ii) such settlement would not reasonably be expected to have material adverse precedential consequences to the Company and (iii) the sole relief provided is monetary damages that are paid in full by the Administrator.

ARTICLE V

NOTIFICATION TO POLICYHOLDERS

The Administrator agrees to send to policyholders of the Reinsured Contracts a written notice prepared by the Administrator and reasonably acceptable to the Company to the effect that the Administrator, or such other Person designated by the Administrator in accordance with the terms of this Agreement, has been appointed by the Company to provide Administrative Services. The Administrator shall send such notice by first class U.S. mail at a time reasonably acceptable to the Company and the Administrator and in all events in accordance with Applicable Law. The parties intend to minimize the cost associated with any notification under this Article V, including by means of inclusion of the notice in a regularly scheduled mailing to policyholders in lieu of a separate mailing. The cost associated with such notification under this Article V (upon the initial assumption of the administration of the Reinsured Contracts under Section 3.7 of the Coinsurance Agreement) shall be a transition cost payable by the Administrator or the Company in accordance with Section 3.7(a) or 3.7(c) of the Coinsurance Agreement, as applicable.

ARTICLE VI

INSOLVENCY FUND ACCOUNTINGS

6.1. Quarterly Accountings. Within thirty (30) days after the end of each calendar quarter that this Agreement is in effect (or more frequently as mutually agreed by the

parties), the Company shall submit to the Administrator a written statement of accounting in a form and containing such information to be agreed upon by the parties hereto (each, an "Insolvency Fund Quarterly Accounting") setting forth the Insolvency Fund amounts assessed or payable to the extent that such assessments constitute Reinsured Risks with respect to the Reinsured Contracts (collectively, the "Post-Effective Date Assessments"). The Administrator shall remit to the Company an amount equal to the Post-Effective Date Assessments set forth in an Insolvency Fund Quarterly Accounting received by the Administrator within ten (10) Business Days of receipt by the Administrator of such Insolvency Fund Quarterly Accounting.

6.2. Adjustments Regarding Insolvency Fund Accountings. In the event that subsequent data or calculations require revision of any of the Insolvency Fund Quarterly Accountings, the required revision and appropriate payments thereunder shall be made within ten (10) Business Days after the parties hereto mutually agree as to the appropriate revision.

ARTICLE VII

CERTAIN ACTIONS BY COMPANY

7.1. Filings. The Company shall prepare and timely file any filings required to be made with any Governmental Authority that relate to the Company generally and not just to the Reinsured Contracts, including filings with guaranty associations and filings and premium tax returns with taxing authorities. The Administrator shall, in a timely fashion in light of the dates such filings by the Company are required, provide to the Company all information in the possession of the Administrator with respect to the Reinsured Contracts that may be reasonably required for the Company to prepare such filings and tax returns.

7.2. Annual Adjustment. The Company shall pay or provide to the Administrator the benefit of any Post-Effective Date Assessments which have been or can be applied to reduce the Company's premium tax liability ("Premium Tax Credits"). The Company shall provide to the Administrator by March 15 of each year a statement of the amount of Premium Tax Credits for the prior calendar year and the Company will pay or credit to the Administrator an amount equal to such Premium Tax Credits.

ARTICLE VIII

REGULATORY MATTERS AND AUDIT REPORTING

8.1. Regulatory Compliance and Reporting. The Administrator shall provide to the Company such information with respect to the Reinsured Contracts as is required to satisfy all current and future informational reporting, prior approval and any other requirements imposed by any Governmental Authority. Upon the reasonable request of the Company, the Administrator shall timely prepare such reports and summaries, including statistical summaries, as are necessary or reasonably required to satisfy any requirements imposed by a Governmental Authority upon the Company with respect to the Reinsured Contracts. In addition, the Administrator, upon the reasonable request of the Company, shall promptly provide to the Company copies of all existing records relating to the Reinsured Contracts (including, with

5

---

respect to records maintained in machine readable form, hard copies) that are necessary to satisfy such requirements. All copies of records furnished in the ordinary course of business shall be furnished by the Administrator at the Administrator's cost. Any extraordinary costs reasonably incurred by the Administrator in response to requests from the Company shall be reimbursed by the Company. Among other responsibilities:

- (i) The Administrator shall promptly prepare and furnish to Governmental Authorities all reports and related summaries (including, without limitation, statistical summaries), certificates of compliance and other reports required or requested by a Governmental Authority.
- (ii) The Administrator shall assist the Company and cooperate with the Company in doing all things necessary, proper or advisable, in the most expeditious manner practicable in connection with any and all market conduct or other Governmental Authority examinations relating to the Reinsured Contracts.

8.2. Reporting and Accounting. The Administrator shall assume the reporting and accounting obligations set forth below:

- (i) As soon as practicable but not more than forty (40) days after the end of each calendar quarter that this Agreement is in effect (or more frequently as mutually agreed by the parties), the Administrator shall timely provide to the Company reports and summaries of transactions (and, upon request of the Company, detailed supporting records) related to the Reinsured Contracts as may be reasonably required for use in connection with the preparation of the Company's statutory and GAAP financial statements, tax returns and other required financial reports and to comply with the requirements of the regulatory authorities having jurisdiction over the Company. The parties shall cooperate in good faith to establish the manner for the providing of such reports.
- (ii) As soon as practicable but not more than forty (40) days after the end of each calendar quarter that this Agreement is in effect (or more frequently as mutually agreed by the parties), the Administrator shall report to the Company the amount of statutory reserves that the Company is required to maintain in connection with the Reinsured Risks with respect to the Reinsured Contracts as of the quarter end.
- (iii) The Administrator shall promptly provide notice to the Company of any changes in the reserve methodology used by the Administrator in calculating statutory reserves for the Reinsured Contracts.
- (iv) Within forty-five (45) days after each calendar year end (or such longer time as may be agreed by the parties) that this Agreement is in effect, the Administrator shall provide to the Company (a) an opinion of an actuary reasonably acceptable to the Company as to the adequacy of statutory

6

---

reserves for the Reinsured Contracts, prepared according to accepted actuarial standards of practice, and as otherwise required for regulatory reporting purposes and (b) an analysis which reasonably supports such opinion.

8.3. Additional Reports and Updates. For so long as this Agreement remains in effect, each party shall periodically furnish to the other such other reports and information as may be reasonably required by such other party for regulatory, tax or similar purposes and reasonably available to it.

ARTICLE IX

MISCELLANEOUS ADMINISTRATIVE SERVICES

The Administrator shall provide such other Administrative Services as are necessary or appropriate to fully effectuate the purpose of the Reinsurance Agreement and this Agreement, including such Administrative Services as are not performed by or on behalf of the Company on the date hereof but the need for which may arise due to changes or developments in Applicable Law.

ARTICLE X

BOOKS AND RECORDS

The Administrator shall keep accurate and complete records, files and accounts of all transactions and matters with respect to the Reinsured Contracts and the administration thereof in accordance with Applicable Law and its record management practices in effect from time to time for the Administrator's insurance business not covered by this Agreement, if any. The parties to this Agreement and their designated representatives may upon reasonable notice inspect, at the offices of the Administrator or the Company where such records are located, the papers and any and all other books or documents of the Administrator or the Company reasonably relating to this Agreement, including the Reinsured Contracts, and shall have access to appropriate employees and representatives of the other party, in each case during normal business hours for such period as this Agreement is in effect or for as long thereafter as any rights or obligations of any party survives or the Administrator or the Company reasonably

need access to such records for regulatory, tax or similar purposes. The information obtained shall be used only for purposes relating to the transactions contemplated under this Agreement.

## ARTICLE XI

### COOPERATION

Each party hereto shall cooperate fully with the other in all reasonable respects in order to accomplish the objectives of this Agreement including making available to each their respective officers and employees for interviews and meetings with Governmental Authorities and

7

---

furnishing any additional assistance, information and documents as may be reasonably requested by a party from time to time.

## ARTICLE XII

### PRIVACY REQUIREMENTS

In providing the Administrative Services provided for under this Agreement, and in connection with maintaining, administering, handling and transferring the data of the policyholders and other recipients of benefits under the Reinsured Contracts, the Administrator shall, and shall cause its Affiliates and any permitted Subcontractors to, comply with all confidentiality and security obligations applicable to them in connection with the collection, use, disclosure, maintenance and transmission of personal, private, health or financial information about individual policyholders or benefit recipients, including the provisions of privacy policies under which such information was gathered, those laws currently in place and which may become effective during the term of this Agreement, including the Gramm-Leach-Bliley Act, the Health Insurance Portability and Accountability Act of 1996 and any other Applicable Laws. The Administrator shall entitle the Company and its agents and representatives, the Commissioner of Health and Human Services and such other Governmental Authorities, to the extent required by Applicable Law, to audit the Administrator's compliance herewith. The Administrator shall also enable individual subjects of personally identifiable information, upon request from such individuals, to review and correct information maintained by the Administrator about them, and to restrict use of such information. The Administrator shall promptly report to the Company any violation of this provision of which the Administrator becomes aware. Unless required by Applicable Law, the Administrator shall not during the term of this Agreement, modify the privacy policies under which information utilized by the Administrator in administering the Reinsured Contracts is gathered, without the Company's prior written consent, which consent shall not be unreasonably withheld. The parties agree to comply with the terms of the Business Associate Addendum attached hereto, if applicable, or such other written agreement as may be required by Applicable Law on the date hereof.

## ARTICLE XIII

### CONSIDERATION FOR ADMINISTRATIVE SERVICES

Apart from the performance by the Company of its obligations under the Coinsurance Agreement, there shall be no fee or other consideration due to the Administrator for performance of the Administrative Services under this Agreement.

## ARTICLE XIV

### BANK ACCOUNT: USE OF COMPANY LETTERHEAD

When and on terms reasonably requested by the Administrator, the Company shall open, modify or close, and make available for use by the Administrator for the payment of amounts to

8

---

be paid by the Administrator hereunder one or more bank accounts of the Company and check stock of the Company. The Administrator shall maintain such account(s) and pay all applicable bank fees and check stock costs. The Company shall adopt such resolutions and execute such documents as required to designate senior officers of the Administrator (by title) as signatories on such account(s) and authorize the Administrator to certify to such bank(s), from time to time, the names of such officers. The Company shall also make available to the Administrator, at the sole expense of the Administrator, such letterhead, printed forms and other documents of the Company as may be reasonably required by the Administrator in performing services hereunder. Upon termination of this Agreement, the Administrator shall promptly return to the Company all such unused check stock, letterhead, printed forms and other documents held by it in connection with this Agreement as provided under this Article XIV.

## ARTICLE XV

### INDEMNIFICATION

Any claim for or with respect to indemnification arising out of, or relating to, this Agreement or the Administrative Services hereunder shall be permitted under and governed by the provisions of Article V of the Master Agreement, dated as of [ ], 2004, among General Electric Company, General Electric Capital Corporation, GEI, Inc., GE Financial Assurance Holdings, Inc. and Genworth Financial, Inc (the "Master Agreement"), to the extent such provisions are applicable, as if this Agreement were a Transaction Document under the Master Agreement.

## ARTICLE XVI

### DURATION: TERMINATION

16.1. Duration. This Agreement shall commence on the Effective Date and continue with respect to each Reinsured Contract until no further Administrative Services in respect of such Reinsured Contract is required, unless this Agreement is earlier terminated under Section 16.2.

16.2. Termination. (a) This Agreement is subject to immediate termination at the option of the Company, upon written notice to the Administrator, on the occurrence of any of the following events:

- (i) A voluntary or involuntary proceeding is commenced in any jurisdiction by or against the Administrator for the purpose of conserving, rehabilitating or liquidating the Administrator;
- (ii) There is a material breach by the Administrator of any material term or condition of this Agreement that is not cured by the Administrator within thirty (30) days after receipt of written notice from the Company of such breach or act (provided that the Company shall not have the right to terminate this Agreement (A) for so long as the Administrator is making a

good faith effort to cure such breach, not to exceed an additional one hundred eighty (180) days or (B) during the pendency of any dispute resolution proceedings as set forth in Article XVII regarding an alleged material breach); or

(iii) The Administrator is unable to perform the services required under this Agreement for a period of thirty (30) consecutive days for any reason other than as a result of a Force Majeure, it being understood that nothing in this Section 16.2(a)(iii) shall relieve the Administrator from its administrative responsibilities under this Agreement. For purposes of this Agreement, "Force Majeure" means any acts or omissions of any civil or military authority, acts of God, acts or omissions of the Company, fires, strikes or other labor disturbances, equipment failures, fluctuations or non-availability of electrical power, heat, light, air conditioning or telecommunications equipment, or any other act, omission or occurrence beyond the Administrator's reasonable control, irrespective of whether similar to the foregoing enumerated acts, omissions or occurrences.

(b) This Agreement may be terminated at any time upon the mutual written consent of the parties hereto, which writing shall state the effective date of termination.

(c) In the event that this Agreement is terminated under any of the provisions of Section 16.2(a), the Administrator shall select a third-party administrator to perform the services required by this Agreement. The Company shall have the right to approve any such administrator selected by the Administrator, but such approval will not unreasonably be withheld or delayed. If the Administrator fails to select an administrator pursuant to this Section 16.2(c), the Company shall select such an administrator. In either case, the Administrator shall pay all fees and charges imposed by the selected administrator and shall bear all transition costs associated with the transition of the performance of the services required under this Agreement to such administrator, including the expense of sending policyholder notices as provided in Article V.

## ARTICLE XVII

### DISPUTE RESOLUTION

17.1. General Provisions. (a) Any dispute, controversy or claim arising out of or relating to this Agreement or the validity, interpretation, breach or termination thereof (a "Dispute"), shall be resolved in accordance with the procedures set forth in this Article XVII, which shall be the sole and exclusive procedures for the resolution of any such Dispute unless otherwise specified below.

(b) Commencing with the request contemplated by Section 17.2, all communications between the parties or their representatives in connection with the attempted resolution of any Dispute, including any mediator's evaluation referred to in Section 17.3, shall be deemed to have been delivered in furtherance of a Dispute settlement and shall be exempt

10

from discovery and production, and shall not be admissible in evidence for any reason (whether as an admission or otherwise), in any arbitral or other proceeding for the resolution of the Dispute.

(c) In connection with any Dispute, the parties expressly waive and forego any right to (i) punitive, exemplary, statutorily-enhanced or similar damages in excess of compensatory damages (provided that any such liability with respect to a Third Party Claim (as defined in the Master Agreement) shall be considered direct damages), and (ii) trial by jury.

(d) The specific procedures set forth below, including but not limited to the time limits referenced therein, may be modified by agreement of the parties in writing.

(e) All applicable statutes of limitations and defenses based upon the passage of time shall be tolled while the procedures specified in this Article XVII are pending. The parties will take such action, if any, required to effectuate such tolling.

17.2. Consideration by Senior Executives. If a Dispute is not resolved in the normal course of business at the operational level, the parties shall attempt in good faith to resolve such Dispute by negotiation between executives who hold, at a minimum, the office of President and CEO of the respective business entities involved in such Dispute. Either party may initiate the executive negotiation process by providing a written notice to the other (the "Initial Notice"). Fifteen (15) days after delivery of the Initial Notice, the receiving party shall submit to the other a written response (the "Response"). The Initial Notice and the Response shall include (i) a statement of the Dispute and of each party's position, and (ii) the name and title of the executive who will represent that party and of any other person who will accompany the executive. Such executives will meet in person or by telephone within thirty (30) days of the date of the Initial Notice to seek a resolution of the Dispute.

17.3. Mediation. If a Dispute is not resolved by negotiation as provided in Section 17.2 within forty-five (45) days from the delivery of the Initial Notice, then either party may submit the Dispute for resolution by mediation pursuant to the CPR Institute for Dispute Resolution (the "CPR") Model Mediation Procedure as then in effect. The parties will select a mediator from the CPR Panels of Distinguished Neutrals, but such mediator must have prior U.S. reinsurance experience either as a lawyer or as a present or former officer or management employee of a reinsurance company, but not of the Company, or the Administrator, or any of their respective affiliates. Either party at commencement of the mediation may ask the mediator to provide an evaluation of the Dispute and the parties' relative positions.

17.4. Arbitration. (a) If a Dispute is not resolved by mediation as provided in Section 17.3 within thirty (30) days of the selection of a mediator (unless the mediator chooses to withdraw sooner), either party may submit the Dispute to be finally resolved by arbitration pursuant to the CPR Rules for Non-Administered Arbitration as then in effect (the "CPR Arbitration Rules"). The parties consent to a single, consolidated arbitration for all known Disputes existing at the time of the arbitration and for which arbitration is permitted.

(b) The neutral organization for purposes of the CPR Arbitration Rules will be the CPR. The arbitral tribunal shall be composed of three arbitrators who are each experienced in

11

the U.S. reinsurance business, of whom each party shall appoint one in accordance with the "screened" appointment procedure provided in Rule 5.4 of the CPR Arbitration Rules. The non-party appointed arbitrator must have prior U.S. reinsurance experience as a present or former officer or management employee of a reinsurance company, but not of the Company, or the Administrator, or any of their respective affiliates. The arbitration shall be conducted in New York City. Each party shall be permitted to present its case, witnesses and evidence, if any, in the presence of the other party. A written transcript of the proceedings shall be made and furnished to the parties. The arbitrators shall determine the Dispute in accordance with the law of Virginia, without giving effect to any conflict of law rules or other rules that might render such law inapplicable or unavailable, and shall apply this Agreement according to its terms, provided that the provisions relating to arbitration shall be governed by the Federal Arbitration Act, 9 U.S.C. §§ 1 et seq. The arbitral tribunal shall endeavor to render its award or order resulting from any arbitration within forty-five (45) days following the termination of

the arbitration proceedings.

(c) The parties agree to be bound by any award or order resulting from any arbitration conducted hereunder and further agree that judgment on any award or order resulting from an arbitration conducted under this Section 17.4 may be entered and enforced in any court having jurisdiction thereof.

(d) Except as expressly permitted by this Agreement, no party will commence or voluntarily participate in any court action or proceeding concerning a Dispute, except (i) for enforcement as contemplated by Section 17.4(c) above, (ii) to restrict or vacate an arbitral decision based on the grounds specified under applicable law, or (iii) for interim relief as provided in paragraph (e) below. For purposes of the foregoing the parties hereto submit to the non-exclusive jurisdiction of the courts of the State of New York.

(e) In addition to the authority otherwise conferred on the arbitral tribunal, the tribunal shall have the authority to make such orders for interim relief, including injunctive relief, as it may deem just and equitable. Notwithstanding paragraph (d) above, each party acknowledges that in the event of any actual or threatened breach of certain of the provisions of this Agreement, the remedy at law would not be adequate, and therefore injunctive or other interim relief may be sought immediately to restrain such breach. If the tribunal shall not have been appointed, either party may seek interim relief from a court having jurisdiction if the award to which the applicant may be entitled may be rendered ineffectual without such interim relief. Upon appointment of the tribunal following any grant of interim relief by a court, the tribunal may affirm or disaffirm such relief, and the parties will seek modification or rescission of the court action as necessary to accord with the tribunal's decision.

(f) Each party will bear its own attorneys' fees and costs incurred in connection with the resolution of any Dispute in accordance with this Article XVII.

12

---

## ARTICLE XVIII

### MISCELLANEOUS PROVISIONS

18.1. Headings and Schedules. Headings used herein are not a part of this Agreement and shall not affect the terms hereof. The attached Schedules are a part of this Agreement.

18.2. Notices. All notices, requests, demands and other communications under this Agreement must be in writing and will be deemed to have been duly given or made as follows: (a) if sent by registered or certified mail in the United States return receipt requested, upon receipt; (b) if sent by reputable overnight air courier, two business days after mailing; (c) if sent by facsimile transmission, with a copy mailed on the same day in the manner provided in (a) or (b) above, when transmitted and receipt is confirmed by telephone; or (d) if otherwise actually personally delivered, when delivered, and shall be delivered as follows:

If to the Company:

GE Life and Annuity Assurance Company  
6610 West Broad Street  
Richmond, VA 23230  
Facsimile: (804) 281-6165  
Attention: Chief Executive Officer

With a copy to:

GE Life and Annuity Assurance Company  
6610 West Broad Street  
Richmond, VA 23230  
Facsimile: (804) 281-6005  
Attention: General Counsel

If to the Administrator:

Union Fidelity Life Insurance Company  
200 North Martingale Road  
Schaumburg, IL 60173-2096  
Facsimile: (847) 330-3404  
Attention: Chief Financial Officer

With a copy to:

Union Fidelity Life Insurance Company  
200 North Martingale Road  
Schaumburg, IL 60173-2096  
Facsimile: (847) 605-3044  
Attention: General Counsel

13

---

or to such other address or to such other Person as either party may have last designated by notice to the other party.

18.3. Successors and Assigns. This Agreement shall be binding upon and inure to the benefit of the parties hereto and their respective successors, permitted assigns and legal representatives. Neither this Agreement, nor any right or obligation hereunder, may be assigned by any party without the prior written consent of the other party hereto. Any assignment in violation of this Section 18.3 shall be void and shall have no force and effect.

18.4. Execution in Counterpart. This Agreement may be executed by the parties hereto in any number of counterparts, and by each of the parties hereto in separate counterparts, each of which counterparts, when so executed and delivered, shall be deemed to be an original, but all such counterparts shall together constitute but one and the same instrument.

18.5. Currency. Whenever the word "Dollars" or the "\$" sign appear in this Agreement, they shall be construed to mean United States Dollars, and all transactions under this Agreement shall be in United States Dollars.

18.6. Amendments. This Agreement may not be changed, altered or modified unless the same shall be in writing executed by the Company and the

Administrator.

18.7. Governing Law. This Agreement will be construed, performed and enforced in accordance with the laws of the Commonwealth of Virginia without giving effect to its principles or rules of conflict of laws thereof to the extent such principles or rules would require or permit the application of the laws of another jurisdiction.

18.8. Entire Agreement; Severability. (a) This Agreement constitutes the entire agreement between the parties hereto relating to the subject matter hereof and supersedes all prior and contemporaneous agreements, understandings, statements, representations and warranties, negotiations and discussions, whether oral or written, of the parties and there are no general or specific warranties, representations or other agreements by or among the parties in connection with the entering into of this Agreement or the subject matter hereof except as specifically set forth or contemplated herein.

(b) If any provision of this Agreement is held to be void or unenforceable, in whole or in part, (i) such holding or provision shall not affect the validity and enforceability of the remainder of this Agreement, including any other provision, paragraph or subparagraph, and (ii) the parties agree to attempt in good faith to reform such void, unenforceable or violative provision to the extent necessary to render such provision enforceable and to carry out its original intent.

18.9. No Waiver; Preservation of Remedies. No consent or waiver, express or implied, by any party to or of any breach or default by any other party in the performance by such other party of its obligations hereunder shall be deemed or construed to be a consent or waiver to or of any other breach or default in the performance of obligations hereunder by such other party hereunder. Failure on the part of any party to complain of any act or failure to act of any other party or to declare any other party in default, irrespective of how long such failure continues, shall not constitute a waiver by such first party of any of its rights hereunder. The

rights and remedies provided are cumulative and are not exclusive of any rights or remedies that any party may otherwise have at law or equity.

18.10. Third Party Beneficiary. Nothing in this Agreement will confer any rights upon any Person that is not a party or a successor or permitted assignee of a party to this Agreement.

18.11. Tax Exception to Any Confidentiality. Notwithstanding anything to the contrary set forth herein or in any other agreement to which the parties hereto are parties or by which they are bound, any obligations of confidentiality contained herein and therein, as they relate to the transactions, shall not apply to the federal tax structure or federal tax treatment of the transactions, and each party hereto (and any employee, representative, or agent of any party hereto) may disclose to any and all persons, without limitation of any kind, the federal tax structure and federal tax treatment of the transactions. The preceding sentence is intended to cause the transactions to be treated as not having been offered under conditions of confidentiality for purposes of Section 1.6011-4(b)(3) (or any successor provision) of the Treasury Regulations promulgated under Section 6011 of the Internal Revenue Code of 1986, as amended, and shall be construed in a manner consistent with such purpose. In addition, each party hereto acknowledges that it has no proprietary or exclusive rights to the federal tax structure of the transactions or any federal tax matter or federal tax idea related to the transactions.

18.12. Interpretation. Wherever the words "include," "includes" or "including" are used in this Agreement, they shall be deemed to be followed by the words "without limitation."

18.13. Survival. Article XVII and Article XVIII shall survive the termination of this Agreement.

IN WITNESS WHEREOF, the Company and the Administrator have executed this Agreement as of the date first above written.

GE LIFE AND ANNUITY ASSURANCE  
COMPANY

By: \_\_\_\_\_  
Name:  
Title:

UNION FIDELITY LIFE INSURANCE  
COMPANY

By: \_\_\_\_\_  
Name:  
Title:

**BUSINESS ASSOCIATE ADDENDUM**

I. Purpose.

In order to disclose certain information to the party providing a service under this Agreement ("Provider") under this Addendum, some of which may constitute Protected Health Information (defined below), the party to whom a service under this Agreement is being provided ("Recipient") and Provider mutually agree to comply with the terms of this Addendum for the purpose of satisfying the requirements of the Health Insurance Portability and Accountability Act of 1996 ("HIPAA") and its implementing privacy regulations at 45 C.F.R. Parts 160-164 ("HIPAA Privacy Rule"). These provisions shall apply to Provider to the extent that Provider is considered a "Business Associate" under the HIPAA Privacy Rule and all references in this section to Business Associates shall refer to Provider. Capitalized terms not otherwise defined herein shall have the meaning assigned in the Agreement. Notwithstanding anything else to the contrary in the Agreement, in the event of a conflict between this Addendum and the Agreement, the terms of this Addendum shall prevail.

II. Permitted Uses and Disclosures.

A. Business Associate agrees to use or disclose Protected Health Information ("PHI") that it creates for or receives from Recipient or its Subsidiaries only as

follows. The capitalized term “Protected Health Information or PHI” has the meaning set forth in 45 Code of Federal Regulations Section 164.501, as amended from time to time. Generally, this term means individually identifiable health information including, without limitation, all information, data and materials, including without limitation, demographic, medical and financial information, that relates to the past, present, or future physical or mental health or condition of an individual; the provision of health care to an individual; or the past present, or future payment for the provision of health care to an individual; and that identifies the individual or with respect to which there is a reasonable basis to believe the information can be used to identify the individual. This definition shall include any demographic information concerning members and participants in, and applicants for, Recipient’s or its Subsidiaries’ health benefit plans. All other terms used in this Addendum shall have the meanings set forth in the applicable definitions under the HIPAA Privacy Rule.

B. Functions and Activities on Company’s Behalf. Business Associate is permitted to use and disclose PHI it creates for or receives from Recipient or its Subsidiaries only for the purposes described in this Addendum or the Agreement that are not inconsistent with the provisions of this Addendum, or as required by law, or following receipt of prior written approval from whichever of the Recipient or its Subsidiary for which the relevant PHI was created or from which the relevant PHI was received. In addition to these specific requirements below, Business Associate may use or disclose PHI only in a manner that would not violate the HIPAA Privacy Rule if done by the Recipient or its Subsidiaries.

C. Business Associate’s Operations. Business Associate is permitted by this Agreement to use PHI it creates for or receives from Recipient or its Subsidiaries: (i) if such use is reasonably necessary for Business Associate’s proper management and administration; and (ii) as reasonably necessary to carry out Business Associate’s legal responsibilities.

---

Business Associate is permitted to disclose PHI it creates for or receives from Recipient or its Subsidiaries for the purposes identified in this Section only if the following conditions are met:

- (1) The disclosure is required by law; or
- (2) The disclosure is reasonably necessary to Business Associate’s proper management and administration, and Business Associate obtains reasonable assurances in writing from any person or organization to which Business Associate will disclose such PHI that the person or organization will:
  - a. Hold such PHI as confidential and use or further disclose it only for the purpose for which Business Associate disclosed it to the person or organization or as required by law; and
  - b. Notify Business Associate (who will in turn promptly notify whichever of the Recipient or its Subsidiary for which the relevant PHI was created or from which the relevant PHI was received) of any instance of which the person or organization becomes aware in which the confidentiality of such PHI was breached.

D. Minimum Necessary Standard. In performing the functions and activities on Recipient’s or its Subsidiaries’ behalf pursuant to the Agreement, Business Associate agrees to use, disclose or request only the minimum necessary PHI to accomplish the purpose of the use, disclosure or request. Business Associate must have in place policies and procedures that limit the PHI disclosed to meet this minimum necessary standard.

E. Prohibition on Unauthorized Use or Disclosure. Business Associate will neither use nor disclose PHI it creates or receives for or from Recipient, its Subsidiaries, or from another business associate of Recipient or its Subsidiaries, except as permitted or required by this Addendum or the Agreement that are not inconsistent with the provisions of this Addendum, or as required by law, or following receipt of prior written approval from whichever of the Recipient or its Subsidiary for which the relevant PHI was created or from which the relevant PHI was received.

F. De-identification of Information. Business Associate agrees neither to de-identify PHI it creates for or receives from Recipient or its Subsidiaries or from another business associate of Recipient or its Subsidiaries, nor use or disclose such de-identified PHI, unless such de-identification is expressly permitted under the terms and conditions of this Addendum or the Agreement and related to Recipient’s or its Subsidiaries’ activities for purposes of “treatment”, “payment” or “health care operations”, as those terms are defined under the HIPAA Privacy Rule. De-identification of PHI, other than as expressly permitted under the terms and conditions of the Addendum for Business Associate to perform services for Recipient or its Subsidiaries, is not a permitted use of PHI under this Addendum. Business Associate further agrees that it will not create a “Limited Data Set” as defined by the HIPAA Privacy Rule using PHI it creates or receives, or receives from another business associate of Recipient or its Subsidiaries, nor use or disclose such Limited Data Set unless: (i) such creation, use or disclosure is expressly permitted under the terms and conditions of

---

this Addendum or the Agreement that are not inconsistent with the provisions of this Addendum; and such creation, use or disclosure is for services provided by Business Associate that relate to Recipient’s or its Subsidiaries’ activities for purposes of “treatment”, “payment” or “health care operations”, as those terms are defined under the HIPAA Privacy Rule.

G. Information Safeguards. Business Associate will develop, document, implement, maintain and use appropriate administrative, technical and physical safeguards to preserve the integrity and confidentiality of and to prevent non-permitted use or disclosure of PHI created for or received from Recipient or its Subsidiaries. These safeguards must be appropriate to the size and complexity of Business Associate’s operations and the nature and scope of its activities. Business Associate agrees that these safeguards will meet any applicable requirements set forth by the U.S. Department of Health and Human Services, including (as of the effective date or as of the compliance date, whichever is applicable) any requirements set forth in the final HIPAA security regulations. Business Associate agrees to mitigate, to the extent practicable, any harmful effect that is known to Business Associate resulting from a use or disclosure of PHI by Business Associate in violation of the requirements of this Addendum.

III. Conducting Standard Transactions. In the course of performing services for Recipient or its Subsidiaries, to the extent that Business Associate will conduct Standard Transactions for or on behalf of Recipient or its Subsidiaries, Business Associate will comply, and will require any subcontractor or agent involved with the conduct of such Standard Transactions to comply, with each applicable requirement of 45 C.F.R. Part 162. “Standard Transaction(s)” shall mean a transaction that complies with the standards set forth at 45 C.F.R. parts 160 and 162. Further, Business Associate will not enter into, or permit its subcontractors or agents to enter into, any trading partner agreement in connection with the conduct of Standard Transactions for or on behalf of the Recipient or its Subsidiaries that:

- a. Changes the definition, data condition, or use of a data element or segment in a Standard Transaction;
- b. Adds any data element or segment to the maximum defined data set;
- c. Uses any code or data element that is marked “not used” in the Standard Transaction’s implementation specification or is not in the Standard Transaction’s implementation specification; or
- d. Changes the meaning or intent of the Standard Transaction’s implementation specification.

IV. Sub-Contractors, Agents or Other Representatives. Business Associate will require any of its subcontractors, agents or other representatives to which Business

or agent will comply with the same restrictions and conditions that apply to the Business Associate under the terms and conditions of this Addendum with respect to such PHI.

V. Protected Health Information Access, Amendment and Disclosure Accounting.

A. Access. Business Associate will promptly upon Recipient's or its Subsidiary's request make available to Recipient, its Subsidiary, or, at Recipient's or such Subsidiary's direction, to the individual (or the individual's personal representative) for inspection and obtaining copies any PHI about the individual which Business Associate created for or received from Recipient or its Subsidiary and that is in Business Associate's custody or control, so that Recipient or its Subsidiary may meet its access obligations under 45 Code of Federal Regulations § 164.524.

B. Amendment. Upon Recipient's or its Subsidiary's request Business Associate will promptly amend or permit Recipient or its Subsidiary access to amend any portion of the PHI which Business Associate created for or received from Recipient or its Subsidiary, and incorporate any amendments to such PHI, so that Recipient or its Subsidiary may meet its amendment obligations under 45 Code of Federal Regulations § 164.526.

C. Disclosure Accounting. So that Recipient or its Subsidiaries may meet their disclosure accounting obligations under 45 Code of Federal Regulations § 164.528:

1. Disclosure Tracking. Business Associate will record for each disclosure, not excepted from disclosure accounting under Section V.C.2 below, that Business Associate makes to Recipient or its Subsidiaries of PHI that Business Associate creates for or receives from Recipient or its Subsidiaries, (i) the disclosure date, (ii) the name and member or other policy identification number of the person about whom the disclosure is made, (iii) the name and (if known) address of the person or entity to whom Business Associate made the disclosure, (iv) a brief description of the PHI disclosed, and (v) a brief statement of the purpose of the disclosure (items i-v, collectively, the "disclosure information"). For repetitive disclosures Business Associate makes to the same person or entity (including Recipient or its Subsidiaries) for a single purpose, Business Associate may provide a) the disclosure information for the first of these repetitive disclosures, (b) the frequency, periodicity or number of these repetitive disclosures and (c) the date of the last of these repetitive disclosures. Business Associate will make this disclosure information available to Recipient or its Subsidiaries promptly upon Recipient's or its Subsidiaries' request.

2. Exceptions from Disclosure Tracking. Business Associate need not record disclosure information or otherwise account for disclosures of PHI that this Addendum or Recipient or the relevant Subsidiary in writing permits or requires (i) for the purpose of Recipient's or its Subsidiaries' treatment activities, payment activities, or health care operations, (ii) to the individual who is the subject of the PHI disclosed or to that individual's personal representative; (iii) to persons involved in that individual's health care or payment for health care; (iv) for notification for disaster relief purposes, (v) for national security or intelligence purposes, (vi) to law enforcement officials or correctional institutions regarding inmates; or (vii) pursuant to an authorization; (viii) for disclosures

of certain PHI made as part of a Limited Data Set; (ix) for certain incidental disclosures that may occur where reasonable safeguards have been implemented; and (x) for disclosures prior to April 14, 2003.

3. Disclosure Tracking Time Periods. Business Associate must have available for Recipient and its Subsidiaries the disclosure information required by this section for the 6 years preceding Recipient's or its Subsidiaries' request for the disclosure information (except Business Associate need have no disclosure information for disclosures occurring before April 14, 2003).

VI. Additional Business Associate Provisions

A. Reporting of Breach of Privacy Obligations. Business Associate will provide written notice to whichever of the Recipient or its Subsidiary for which the relevant PHI was created or from which the relevant PHI was received of any use or disclosure of PHI that is neither permitted by this Addendum nor given prior written approval by Recipient or the relevant Subsidiary promptly after Business Associate learns of such non-permitted use or disclosure. Business Associate's report will at least:

- (i) Identify the nature of the non-permitted use or disclosure;
- (ii) Identify the PHI used or disclosed;
- (iii) Identify who made the non-permitted use or received the non-permitted disclosure;
- (iv) Identify what corrective action Business Associate took or will take to prevent further non-permitted uses or disclosures;
- (v) Identify what Business Associate did or will do to mitigate any deleterious effect of the non-permitted use or disclosure; and
- (vi) Provide such other information, including a written report, as Recipient or the relevant Subsidiary may reasonably request.

B. Amendment. Upon the effective date of any final regulation or amendment to final regulations promulgated by the U.S. Department of Health and Human Services with respect to PHI, including, but not limited to the HIPAA privacy and security regulations, this Addendum and the Agreement will automatically be amended so that the obligations they impose on Business Associate remain in compliance with these regulations.

In addition, to the extent that new state or federal law requires changes to Business Associate's obligations under this Addendum, this Addendum shall automatically be amended to include such additional obligations, upon notice by Recipient or its Subsidiaries to Business Associate of such obligations. Business Associate's continued performance of services under the Agreement shall be deemed acceptance of these additional obligations.

C. Audit and Review of Policies and Procedures. Business Associate agrees to provide, upon Recipient request, access to and copies of any policies and procedures developed or utilized by Business Associate regarding the protection of PHI. Business Associate agrees to provide, upon Recipient's request, access to Business Associate's internal practices, books, and records, as they relate to Business Associate's services, duties and obligations set forth in this Addendum and the Agreement(s) under which Business Associate provides services and / or products to or on behalf of Recipient or its Subsidiaries, for purposes of Recipient's or its Subsidiaries' review of such internal practices, books, and records.



## SCHEDULE C

CEDING COMMISSION

The Ceding Commission shall be the sum of the following:

1. an amount equal to the excess of the Total SAP Ceded Reserves over Total GAAP Ceded Reserves measured as of the close of business on the day immediately preceding the Inception Date (which amount may be negative);
2. an amount equal to the unamortized PVFP intangible asset balance of the Company (excluding any related mark to market adjustments for SFAS 115 requirement) with respect to the Reinsured Contracts as measured as of the close of business on the day immediately preceding the Inception Date, determined in accordance with GAAP;
3. an amount equal to the unamortized deferred acquisition costs of the Company (excluding any related mark to market adjustments for SFAS 115 requirement) with respect to the Reinsured Contracts as measured as of the close of business on the day immediately preceding the Inception Date, determined in accordance with GAAP; and
4. an amount equal to the excess of the GAAP book value of the Assets (excluding any related mark to market adjustments for SFAS 115 requirement) over the SAP book value of the Assets measured as of the close of business on the day immediately preceding the Inception Date (which amount may be negative).

## SCHEDULE D

ASSETS

Transfer Document		From		To		Nature of Transfer		Cash Map Cross-Reference		Schedule	
GELAAC SS Coinsurance		GELAAC		UFLIC		Treaty		(85)		Schedule D	
Called Securities*	Parent Name	Issuer Name	1Q04 Cusip	1Q04 Tax lot	12/31/03 Local Par	12/31/03 GAAP BV (incl attached derivative)	12/31/03 Accrued Interest	12/31/03 GAAP BV + Accrued Interest	12/31/03 STAT BV (incl attached derivative)	12/31/03 Accrued Interest	12/31/03 STAT BV + Accrued Interest
[Individual Asset Details Omitted]											
<b>Asset Sub Total</b>						<b>177,644,647.60</b>	<b>4,313,861.68</b>	<b>181,958,509.28</b>	<b>177,559,684.47</b>	<b>4,313,861.68</b>	<b>181,873,546.15</b>
Cash									47,523.66		47,523.66
<b>Total</b>									<b>177,607,208.13</b>		<b>181,921,069.81</b>

\* These Securities will not be transferred. The "Call Amount" will be settled in cash

## SCHEDULE E

EXPENSE ALLOWANCES

The "Annual Expense Reimbursement Factor" used to calculate the Expense Allowance is as follows:

Policy Maintenance Factor                      \$23.84 per Policy

Such Annual Expense Reimbursement Factor will be adjusted (i) for the year beginning January 1, 2005 and, thereafter, every three (3) years during the term of this Agreement based on a triennial cost/time study prepared in accordance with the methodology set forth below (the "Triennial Study") and (ii) for the years between the Triennial Studies based on a report setting forth the Annual Expense Reimbursement Factor prepared in accordance with the methodology set forth below (the "Annual Expense Reimbursement Factor Report").

(a) Triennial Study. As soon as practicable (and in any event within sixty (60) days) prior to January 1, 2005 and prior to the beginning of every third calendar year thereafter during the term of this Agreement, the Company shall cause to be prepared and delivered to the Reinsurer the Triennial Study which sets forth the Annual Expense Reimbursement Factor for the next calendar year, together with all supporting data used in preparing the Triennial Study and work papers, in reasonable detail, setting forth the determination of such Annual Expense Reimbursement Factors based on such Triennial Study (such documents, together with the Triennial Study, the "Triennial Study Documents").

(b) Annual Expense Reimbursement Factor Report. As soon as practicable (and in any event within thirty (30) days) prior to January 1, 2006 and prior to the beginning of each calendar year thereafter in which no Triennial Study is prepared, the Company shall cause to be prepared and delivered to the Reinsurer the Annual Expense Reimbursement Factor Report, together with all supporting data used in preparing the Annual Expense Reimbursement Factor Report and work papers, in reasonable detail, setting forth the determination of such Annual Expense Reimbursement Factor for the next calendar year (such documents, together with the Annual Expense Reimbursement Factor Report, the "Annual Expense Reimbursement Factor Documents").

(c) Methodology. At the time of the Triennial Study, historical costs (to include costs directly related to maintaining and administering policies, processing claims and reporting results) will be determined for the Policy Maintenance Factor identified above. For a given Annual Expense Reimbursement Factor the identified costs will be divided by the total historical number of units of measure for both the Reinsured Contracts and the retained block of business to derive an historical cost per unit. The historical cost per unit will be used as a prospective cost per unit for the next calendar year.

For the two succeeding years in the period between the Triennial Studies the historical dollar amounts by Policy Maintenance Factor will be adjusted (rolled forward) for current year cost changes agreed to by the Reinsurer and the Company (in accordance with the procedures set forth below). This rolled forward historical cost will then be divided by the total historical number of units for the current period to determine a prospective cost per unit for the next calendar year.

An additional adjustment, positive or negative, to the prospective cost per unit determined by either the Triennial Study or the two succeeding years may be negotiated between the parties. The additional adjustment is for special projected costs or benefits of productivity, process improvements, inflation, loss of scale, and any other cost variation which was not included in the prior Triennial Study or the succeeding roll forward.

The combined prospective unit cost and additional adjustment is the Annual Expense Reimbursement Factor. The Expense Allowance will be determined quarterly and billed to the Reinsurer in three equal installments during the quarter at the end of the month. Each installment will be determined by multiplying the actual number of units at the beginning of the quarter covered by this Agreement times the Annual Expense Reimbursement Factor (divided by twelve).

(d) Review of Documents. Following the delivery of the Annual Expense Reimbursement Factor Documents or the Triennial Study Documents, as applicable, the Company shall (i) provide to the Reinsurer or its designated representative copies of such additional work papers and other documents relating to its preparation of the Annual Expense Reimbursement Factor Report or Triennial Study, as applicable, as the Reinsurer or its designated representative may reasonably request, including, without limitation, claims files and practices and (ii) cooperate with, and make its personnel and facilities reasonably available to, the Reinsurer and the Reinsurer's designated representative for the purpose of providing such other information as the Reinsurer or the Reinsurer's designated representative may reasonably request concerning Annual Expense Reimbursement Factor Documents or the Triennial Study Documents, as applicable, and the calculation of the Annual Expense Reimbursement Factor.

(e) Notice of Disagreement. In the event that the Reinsurer has any disagreement with any of the Annual Expense Reimbursement Factor Documents or the Triennial Study Documents, as applicable, the Reinsurer shall give written notice of all such disagreements (a "Notice of Disagreement") to the Company within thirty (30) days after the Annual Expense Reimbursement Factor Documents or the Triennial Study Documents, as applicable, are delivered to the Reinsurer. Any Notice of Disagreement shall set forth each item in disagreement and shall provide reasonable specificity as to the basis for each disagreement and shall specify the total adjustment to the Annual Expense Reimbursement Factor, as proposed by the Company as a result of such items in disagreement.

(f) Dispute Resolution. If the Reinsurer does not deliver a Notice of Disagreement to the Company within such thirty (30) day period, the Annual Expense Reimbursement Factor Documents and the Triennial Study Documents, as applicable, shall be final and binding upon

the parties hereto and shall constitute the final calculation of the Annual Expense Reimbursement Factor for the next calendar year. If the Reinsurer delivers a Notice of Disagreement to the Company within such thirty (30) day period, the parties shall (and shall cause their respective designated representatives to) negotiate in good faith to resolve all disagreements as promptly as practicable. Any changes in the Annual Expense Reimbursement Factor, if any, that are agreed to by the Company and the Reinsurer within sixty (60) days of the aforementioned delivery of the Annual Expense Reimbursement Factor Documents or the Triennial Study Documents, as applicable, shall be incorporated into a final calculation of the Annual Expense Reimbursement Factor. If the parties and their respective designated representatives are unable to resolve all disagreements within sixty (60) days of delivery of the Annual Expense Reimbursement Factor Documents or the Triennial Study Documents, as applicable, then all unresolved disagreements will be submitted within ten (10) days after the end of such sixty (60) day period for resolution in accordance herewith to an independent certified public accounting firm of national standing and reputation (the "Accounting Firm") mutually acceptable to the Company and the Reinsurer. The parties shall cooperate in good faith with the Accounting Firm and shall give the Accounting Firm access to all data and other information requested by the Accounting Firm for purposes of such resolution. The Accounting Firm shall, within thirty (30) days after its engagement, deliver to the Company and the Reinsurer a definitive calculation of the Annual Expense Reimbursement Factor, which shall be final and binding upon the parties hereto and shall be so reflected in the calculation of the Annual Expense Reimbursement Factor. The Company and the Reinsurer shall each pay one-half of the fees and expenses of the Accounting Firm.

(g) Expense Allowance Pending Resolution. In the event of a dispute with respect to any Annual Expense Reimbursement Factor for the next succeeding Calendar year, the Company and the Reinsurer agree that the Annual Expense Reimbursement Factor then in effect under this Agreement shall remain in effect pending resolution of such dispute and adjustment, if any, in accordance with the dispute resolution procedure set forth in paragraph (f) above.

## SCHEDULE F - PART I

### INITIAL REPORT

1.	Total SAP Ceded Reserves		
	Gross Policy Reserves calculated in accordance with SAP with respect to the reinsured risks.		\$
2.	Ceding Commission:		
	A. Excess SAP Ceded Reserves over GAAP Ceded Reserves:		
	1) Total SAP Ceded Reserves	\$	
	2) Total GAAP Ceded Reserves:		
	Gross Policy Reserves calculated in accordance with GAAP with respect to the reinsured risks.	\$	
	Excess SAP Reserves over GAAP Reserves (A1-A2)		\$
	B. Present Value of Future Profits (PVFP)		\$
	C. Deferred Acquisition Costs (DAC)		\$
	D. Asset Book Value Difference - Measured as of close of business the day preceding the Inception Date		
	1) Asset Book Value (GAAP basis)	\$	
	2) Asset Book Value (SAP basis)	\$	
	Excess Asset Book Value (D1-D2)		\$
	Total Ceding Commission (A+B+C+D)		\$
3.	Accrued Interest on Assets as of the day before Inception Date		\$
4.	Investment Cash Flows on the Assets from the Inception Date through the Closing Date		\$
	Net Due Reinsurer (1-2-3+4)		\$

SCHEDULE F - PART II

QUARTERLY REPORT

1.	Benefits	\$
2.	Withdrawals from Claims Settlement Account	\$
3.	Expense Allowance	\$
I.	Quarterly Settlement Amount (-1+2-3)	\$
	Net Due to (from) Reinsurer	\$

---

SCHEDULE F - PART III

ANNUAL REPORT

1.	Benefits	\$
2.	Withdrawals from Claims Settlement Account	\$
3.	Expense Allowance	\$
I.	Quarterly Settlement Amount (-1+2-3)	\$
	Net Due to (from) Reinsurer (I-II)	\$

---

SCHEDULE G

FORM OF TRUST AGREEMENT

---

SCHEDULE H

ELIGIBLE SECURITIES

Assets of the types for which an Illinois-domiciled life insurance company could obtain full statutory reserve credit under statutory accounting practices prescribed or permitted by the Director of Insurance of the State of Illinois.

---

## COINSURANCE AGREEMENT

between

FEDERAL HOME LIFE INSURANCE COMPANY

and

UNION FIDELITY LIFE INSURANCE COMPANY

Dated as of April 15, 2004

TABLE OF CONTENTS

<a href="#">ARTICLE I</a>	<a href="#">DEFINITIONS</a>
<a href="#">ARTICLE II</a>	<a href="#">COVERAGE</a>
<a href="#">ARTICLE III</a>	<a href="#">ADMINISTRATION; GENERAL PROVISIONS</a>
<a href="#">ARTICLE IV</a>	<a href="#">CLAIMS SETTLEMENT ACCOUNT; CLAIMS</a>
<a href="#">ARTICLE V</a>	<a href="#">REINSURANCE ASSET TRANSFER; CEDING COMMISSION</a>
<a href="#">ARTICLE VI</a>	<a href="#">EXPENSE ALLOWANCES</a>
<a href="#">ARTICLE VII</a>	<a href="#">ACCOUNTING AND SETTLEMENT</a>
<a href="#">ARTICLE VIII</a>	<a href="#">DURATION AND TERMINATION</a>
<a href="#">ARTICLE IX</a>	<a href="#">INSOLVENCY</a>
<a href="#">ARTICLE X</a>	<a href="#">CREDIT FOR REINSURANCE</a>
<a href="#">ARTICLE XI</a>	<a href="#">REINSURANCE SECURITY</a>
<a href="#">ARTICLE XII</a>	<a href="#">DEFERRED ACQUISITION COSTS</a>
<a href="#">ARTICLE XIII</a>	<a href="#">DISPUTE RESOLUTION</a>
<a href="#">ARTICLE XIV</a>	<a href="#">MISCELLANEOUS PROVISIONS</a>
 <u>SCHEDULES</u>	
<a href="#">SCHEDULE A</a>	- <a href="#">POLICY FORMS</a>
<a href="#">SCHEDULE B</a>	- <a href="#">FORM OF ADMINISTRATIVE SERVICES AGREEMENT</a>
<a href="#">SCHEDULE C</a>	- <a href="#">CEDING COMMISSION</a>
<a href="#">SCHEDULE D</a>	- <a href="#">ASSETS</a>
<a href="#">SCHEDULE E</a>	- <a href="#">EXPENSE ALLOWANCES</a>
<a href="#">SCHEDULE F - PART I</a>	- <a href="#">INITIAL REPORT</a>
<a href="#">SCHEDULE F - PART II</a>	- <a href="#">QUARTERLY REPORT</a>
<a href="#">SCHEDULE F - PART III</a>	- <a href="#">ANNUAL REPORT</a>
<a href="#">SCHEDULE G</a>	- <a href="#">FORM OF TRUST AGREEMENT</a>
<a href="#">SCHEDULE H</a>	- <a href="#">ELIGIBLE SECURITIES</a>

company organized under the laws of the State of Illinois (the "Reinsurer"). Defined terms used herein are defined below.

The Company and the Reinsurer mutually agree to reinsure the risks described in this Agreement under the terms and conditions stated herein. This Agreement is an indemnity coinsurance agreement solely between the Company and the Reinsurer, and the performance of the obligations of each party under this Agreement shall be rendered solely to the other party. In no instance shall anyone other than the Company or the Reinsurer have any rights under this Agreement. The Company shall be and shall remain the only party hereunder that is liable to any insured, contract holder, policyholder, claimant or beneficiary under any insurance policy or contract reinsured hereunder.

This Agreement is entered into in connection with an intercompany reorganization among the Company, the Reinsurer and certain of their Affiliates.

## ARTICLE I

### DEFINITIONS

1.1. Definitions. As used in this Agreement, the following terms shall have the following meanings (definitions are applicable to both the singular and the plural forms of each term defined in this Article):

"Accounting Period" means calendar quarter, except that the last Accounting Period shall be the period commencing with the first day of the calendar quarter in which the Termination Date falls and ending with the Termination Date.

"Affiliate" means any other Person that directly or indirectly controls, is controlled by, or is under common control with, the first Person. "Control" (including the terms, "controlled by" and "under common control with") means the possession, directly or indirectly, of the power to direct or cause the direction of the management and policies of a Person, whether through the ownership of voting securities, by contract or credit arrangement, as trustee or executor, or otherwise.

"Agreement" shall have the meaning specified in the first paragraph of this Agreement.

"Annual Report" shall have the meaning specified in Section 7.4.

"Applicable Law" means any federal, state, local or foreign law (including common law), statute, ordinance, rule, regulation, order, writ, injunction, judgment, permit, governmental agreement or decree applicable to a Person or any of such Person's subsidiaries,

---

properties, assets, or to such Person's officers, directors, managing directors, employees or agents in their capacity as such.

"Assets" shall have the meaning specified in Section 5.3(a).

"Assignment Letter Agreement" means the letter agreement dated the date hereof among General Electric Capital Corporation, a Delaware corporation, the Reinsurer, the Company and certain affiliates of the Company relating to the assignment by General Electric Capital Corporation of the Capital Maintenance Agreement.

"Benefits" shall have the meaning specified in Section 2.3(a).

"Business Day" means any day other than a Saturday, Sunday or other day on which commercial banks in the States of Illinois or Virginia are required or authorized by law to be closed.

"Capital Maintenance Agreement" means the Capital Maintenance Agreement between General Electric Capital Corporation, a Delaware corporation, and the Reinsurer.

"Ceding Commission" shall have the meaning specified in Section 5.2.

"Claims Settlement Account" shall have the meaning specified in Section 4.1(a).

"Closing Date" means April 15, 2004.

"Code" means the Internal Revenue Code of 1986, as amended.

"Company Account" shall have the meaning specified in Section 11.1(e).

"CPR" shall have the meaning specified in Section 13.3.

"CPR Arbitration Rules" shall have the meaning specified in Section 13.4(a).

"Dispute" shall have the meaning specified in Section 13.1(a).

"Eligible Securities" shall have the meaning specified in Section 11.1(c).

"Expense Allowance" shall have the meaning specified in Section 6.1.

"Extra Contractual Liabilities" means all liabilities for damages (including compensatory, consequential, exemplary, punitive, bad faith or similar or other damages) which relate to the marketing, sale, underwriting, issuance, delivery, cancellation or administration of the Reinsured Contracts, including liability arising out of or relating to any alleged or actual acts, errors or omissions by the Company or its agents, whether intentional or otherwise, with respect to any of the Reinsured Contracts, including (A) any alleged or actual reckless conduct or bad faith in connection with the handling of any claim arising out of or under Reinsured Contracts, or (B) the marketing, sale, underwriting, issuance, delivery, cancellation or administration of any of the Reinsured Contracts.

---

"Force Majeure" shall have the meaning specified in Section 3.7(b)(iii).

"Funding Requirement" shall have the meaning specified in Section 11.1(e).

"GAAP" means U.S. generally accepted accounting principles consistently applied.

“Governmental Authority” means any foreign or national government, any state or other political subdivision thereof, and any entity exercising executive, legislative, judicial, regulatory or administrative functions of or pertaining to government.

“Inception Date” shall have the meaning specified in Section 2.1.

“Initial Notice” shall have the meaning specified in Section 13.2.

“Initial Reinsurance Premium” shall have the meaning specified in Section 5.1.

“Initial Report” shall have the meaning specified in Section 7.1.

“Insolvency Fund” means any guarantee fund, insolvency fund, plan, pool, association, fund or other arrangement, however denominated, established or governed, which provides for any assessment of or payment or assumption by the Company of part or all of any claim, debt, charge, fee or other obligation of an insurer or reinsurer, or its successors or assigns, which has been declared by any competent authority to be insolvent, or which is otherwise deemed unable to meet any claim, debt, charge, fee or other obligation in whole or in part.

“Minimum Claims Settlement Amount” shall have the meaning specified in Section 4.1(b).

“Person” means any natural person, firm, limited liability company, general partnership, limited partnership, joint venture, association, corporation, trust, Governmental Authority or other entity.

“Quarterly Report” shall have the meaning specified in Section 7.2.

“Quarterly Settlement” shall have the meaning specified in Section 5.3(a).

“RBC Reporting Letter Agreement” means the letter agreement dated the date hereof among the Company, the Reinsurer and certain affiliates of the Company relating to the Reinsurer’s requirement to provide periodic certifications and reports regarding the Reinsurer’s risk based capital ratio.

“Reinsured Contracts” means the structured settlements immediate annuity contracts issued by the Company and recorded in the Company’s valuation system on or prior to December 3, 2003 or reinsured by the Company under reinsurance agreements in effect prior to January 1, 2004, and, in each case, written on the policy forms described in Schedule A.

“Reinsured Risks” shall have the meaning specified in Section 2.1.

3

---

“Response” shall have the meaning specified in Section 13.2.

“SAP” means statutory accounting practices prescribed or permitted by the Insurance Department of the Commonwealth of Virginia.

“Tax DAC” means specified policy acquisition expenses capitalized and amortized under section 848 of the Code.

“Termination Date” means the effective date of any termination of this Agreement as provided in Article VIII.

“Termination Letter Agreement” means the letter agreement dated the date hereof among the Company, the Reinsurer and certain affiliates of the Company relating to the rescission of this Agreement upon the failure of certain events to occur after the date hereof.

“Total SAP Ceded Reserves” means, as of any given date, the gross policy reserves of the Company calculated in accordance with SAP with respect to the Reinsured Risks.

“Total GAAP Ceded Reserves” means, as of any given date, the gross policy reserves of the Company calculated in accordance with GAAP with respect to the Reinsured Risks.

“Trust Account” shall have the meaning set forth in Section 11.1(a).

“Trust Agreement” shall have the meaning set forth in Section 11.1(a).

“Trustee” shall have the meaning set forth in Section 11.1(a).

## ARTICLE II

### COVERAGE

2.1. Coverage. Upon the terms and subject to the conditions and other provisions of this Agreement, as of 12:01 a.m. Eastern Time on January 1, 2004 (the “Inception Date”), the Company hereby cedes to the Reinsurer, and the Reinsurer hereby agrees to indemnify the Company for, one hundred percent (100%) of the liability incurred by the Company for Benefits on or after the Inception Date (the “Reinsured Risks”).

2.2. Conditions. (a) If the Company’s liability under any of the Reinsured Contracts is changed because of changes made on or after the Inception Date in the terms and conditions of the Reinsured Contracts (including to any contract riders or endorsements thereto) that are required due to changes in Applicable Law, the Reinsurer will share in the change proportionately to the coinsurance share hereunder and the Company and the Reinsurer will make all appropriate adjustments to amounts due each other under this Agreement.

(b) Except as otherwise set forth in paragraph (a) above, no changes, amendments or modifications made on or after the Inception Date in the terms and conditions of the

4

---

Reinsured Contracts which adversely affect the liability of the Reinsurer hereunder shall be covered hereunder without the prior written approval of such changes, amendments or modifications by the Reinsurer, which approval shall not be unreasonably withheld or delayed. In the event that any such changes, amendments or modifications are made in any Reinsured Contract without the prior written approval of the Reinsurer, this Agreement will cover liability incurred by the Company for Benefits as if the non-approved changes, amendments or modifications had not been made.

2.3. Benefits. (a) Subject to the provisions of Sections 2.2, 2.3(b) and (c) and the terms and conditions of this Agreement, "Benefits" shall mean the actual benefits payable by the Company under the Reinsured Contracts.

(b) Any Extra Contractual Liabilities resulting from actions of the Company or its agents or reinsured by the Company under the Reinsured Contracts shall be treated as a Benefit payable for the purposes of this Agreement to the extent permitted by state law, except to the extent that any such Extra Contractual Liabilities are attributable to the conduct of the Company in the administration of the Reinsured Contracts on or after the Inception Date, other than actions taken by the Company at the written request or direction of the Reinsurer.

(c) This Agreement excludes all liability arising by contract, operation of law, or otherwise from the Company's participation or membership, whether voluntary or involuntary, in any Insolvency Fund.

2.4. Territory. The territorial limits of this Agreement shall be identical with those of the Reinsured Contracts.

2.5. Ceded Reinsurance. Subsequent to the Inception Date, the Company will not enter into any reinsurance arrangements with respect to the Reinsured Contracts without the prior written consent of the Reinsurer, in its sole discretion.

### ARTICLE III

#### ADMINISTRATION; GENERAL PROVISIONS

3.1. Contract Administration. (a) Subject to Section 3.7, the Company shall provide policyholder and claims servicing with respect to the Reinsured Contracts in accordance with the terms hereof. All Benefits paid by the Company shall be binding upon the Reinsurer; provided, however, that such Benefits are within the terms, conditions and limitations of the Reinsured Contracts. The Company shall provide policyholder and claims servicing with respect to the Reinsured Contracts (including the administration of claims for Benefits thereunder) in good faith and with the care, skill, prudence and diligence of a person experienced in administering structured settlement business. The Company shall provide policyholder and claims servicing with respect to the Reinsured Contracts, (i) in accordance with the terms of the Reinsured Contracts, (ii) in accordance with the applicable terms of this Agreement, (iii) in compliance with Applicable Law and, subject to the foregoing, (iv) in the same manner as it conducts its own business not subject to this Agreement and (v) in accordance with the Company's administrative performance standards in effect on the date hereof, with such revisions

5

---

to such standards as are no less favorable to the Reinsurer than such standards. Notwithstanding the foregoing, the parties may, from time to time, mutually develop specific and/or different standards for providing such services with respect to the Reinsured Contracts.

(b) The Company may subcontract for the performance of any policyholder or claims servicing service or services with respect to the Reinsured Contracts to (i) an Affiliate or (ii) any other Person with the prior written consent of the Reinsurer, such consent not to be unreasonably withheld; provided, that the Company also subcontracts for such service or services for its own structured settlement annuities business not subject to this Agreement to such subcontractor; and provided, further, that no such subcontracting shall relieve the Company from any of its obligations or liabilities hereunder, and the Company shall remain responsible for all obligations or liabilities of such subcontractor with regards to the providing of such service or services as if provided by the Company.

3.2. Claims Settlements. The Company agrees that it will provide prompt notice to the Reinsurer of its intention to contest, compromise or litigate a claim with respect to a Reinsured Contract, along with copies of all pleadings and reports of investigation with respect thereto. The Reinsurer shall have the right, at its own expense, to participate jointly with the Company in the investigation, adjustment or defense of such claims. In addition, in the event that litigation arises against the Company in connection with a claim which seeks damages in excess of \$1 million or other remedies deemed material to the Reinsurer, the Reinsurer may, upon written notice to the Company, assume the defense thereof with counsel selected by the Reinsurer and reasonably satisfactory to the Company. If the Reinsurer assumes such defense, the Company shall have the right, at its own expense, to participate jointly with the Reinsurer in the defense thereof. If the Reinsurer assumes the defense of litigation, the Reinsurer shall not settle such litigation without the Company's prior written consent (which consent shall not be unreasonably withheld or delayed) unless (i) there is no finding or admission of any violation of law or any violation of the rights of any Person, (ii) such settlement would not reasonably be expected to have material adverse precedential consequences to the Company and (iii) the sole relief provided is monetary damages that are paid in full by the Reinsurer.

3.3. Inspection. The Company shall keep accurate and complete records, files and accounts of all transactions and matters with respect to the Reinsured Contracts and the administration hereof in accordance with Applicable Law and its record management practices in effect from time to time for the Company's insurance business not covered by this Agreement. The Reinsurer and its designated representatives may upon reasonable notice inspect, at the offices of the Company where such records are located, the papers and any and all other books or documents of the Company reasonably relating to this Agreement, including the Reinsured Contracts and the administration thereof by the Company (including compliance with the provisions of Section 3.1), and shall have access to appropriate employees and representatives of the Company, in each case during normal business hours for such period as this Agreement is in effect or for as long thereafter as the Company seeks performance by the Reinsurer pursuant to the terms of this Agreement or the Reinsurer reasonably needs access to such records for regulatory, tax or similar purposes. The information obtained shall be used only for purposes relating to the transactions contemplated under this Agreement.

6

---

3.4. Errors and Omissions. If any delay, omission, error or failure to pay amounts due or to perform any other act required by this Agreement is unintentional and caused by misunderstanding or oversight, the Company and the Reinsurer will adjust the situation to what it would have been had the misunderstanding or oversight not occurred. The party first discovering such misunderstanding or oversight, or an act resulting from such misunderstanding or oversight, will notify the other party in writing promptly upon discovery thereof, and the parties shall act to correct such misunderstanding or oversight within twenty (20) Business Days of such other party's receipt of such notice. However, this Section shall not be construed as a waiver by either party of its right to enforce strictly the terms of this Agreement.

3.5. Age, Sex and Other Adjustments. If the Company's liability under any of the Reinsured Contracts is changed because of a misstatement of age or sex or any other material fact, the Reinsurer will share in the change proportionately to the coinsurance share hereunder and the Company and the Reinsurer will make all appropriate adjustments to amounts due each other under this Agreement.

3.6. Setoff. Any debts or credits, matured or unmatured, in favor of or against either the Company or the Reinsurer with respect to this Agreement or any other reinsurance agreement between the Company and the Reinsurer, are deemed mutual debts or credits, as the case may be, and shall be setoff from any amounts due to the Company or the Reinsurer hereunder, as the case may be, and only the net balance shall be allowed or paid.

3.7. Administration by Reinsurer. (a) At any time from and after the fifteenth (15th) anniversary of the Inception Date, the Reinsurer shall have the right to assume from the Company the administration of the Reinsured Contracts, provided that the Reinsurer provides twelve (12) months prior written notice of such assumption, which notice may be given as early as the fourteenth (14th) anniversary of the Inception Date to take effect as of the fifteenth (15th) anniversary of the Inception Date. The Reinsurer shall bear all transition costs associated with an assumption of the administration of the Reinsured Contracts pursuant to this paragraph (a) of this Section 3.7.

(b) In addition to the provisions of Section 3.7(a), the Reinsurer shall have the right, upon written notice to the Company to assume from the Company the administration of the Reinsured Contracts upon the occurrence of any of the following events:

- (i) A voluntary or involuntary proceeding is commenced in any jurisdiction by or against the Company for the purpose of conserving, rehabilitating or liquidating the Company;
- (ii) There is a material breach by the Company of any material term or condition of this Article III that is not cured by the Company within thirty (30) days after receipt of written notice from the Reinsurer of such breach or act (provided that the Reinsurer shall not have the right to assume such administration (A) for so long as the Company is making a good faith effort to cure such a breach, not to exceed an additional one hundred eighty (180) days or (B) during the pendency of any dispute resolution

7

---

proceedings as set forth in Article XIII regarding an alleged material breach); or

- (iii) The Company is unable to perform the services required under this Article III for a period of thirty (30) consecutive days for any reason, other than as a result of a Force Majeure, it being understood that nothing in this Section 3.7(b)(iii) shall relieve the Company from its administrative responsibilities under this Agreement. For purposes of this Agreement "Force Majeure" means any acts or omissions of any civil or military authority, acts of God, acts or omissions of the Reinsurer, fires, strikes or other labor disturbances, equipment failures, fluctuations or non-availability of electrical power, heat, light, air conditioning or telecommunications equipment, or any other act, omission or occurrence beyond the Company's reasonable control, irrespective of whether similar to the foregoing enumerated acts, omissions or occurrences.

(c) The Company shall bear all transition costs associated with an assumption of the administration of the Reinsured Contracts pursuant to Section 3.7(b).

(d) In the event of the Reinsurer's assumption of the administration of the Reinsured Contracts, the Reinsurer and the Company shall enter into an administrative services agreement in the form attached hereto as Schedule B and the provisions of Article VI and Article VII shall become inoperative.

#### ARTICLE IV

##### CLAIMS SETTLEMENT ACCOUNT; CLAIMS

4.1. Claims Settlement Account. (a) On the Closing Date, the Reinsurer shall establish a separate bank account (the "Claims Settlement Account") in its own name for the payment of Benefits and shall authorize two signatories who shall be representatives of the Company and approved by the Reinsurer in writing to issue drafts in the name of the Reinsurer and showing the identity of the Company. The Reinsurer shall fund such account for payment of Benefits in accordance with the provisions of Section 4.1(b). Any interest earned on the Claims Settlement Account shall belong to the Reinsurer. The Claims Settlement Account shall be administered by the Company in a fiduciary capacity and shall be used solely by the Company to make payments of Benefits in accordance with the terms of this Agreement.

(b) The Reinsurer shall deposit \$5 million in the Claims Settlement Account on the Closing Date and shall thereafter fund the Claims Settlement Account on or before the fifth (5th) day of each month in amounts agreed by the Company and the Reinsurer from time to time in amounts sufficient to provide funds to the Company for the payment of Benefits during the next thirty (30) days, or such other amount as may be mutually agreed by the parties (such initial deposit amount and each minimum funding amount as agreed from time to time shall be referred to as a "Minimum Claims Settlement Amount"). In addition, the Reinsurer shall deposit to the Claims Settlement Account such additional amounts as may be required to keep

8

---

the balance of such account above zero at all times. In consideration of the Reinsurer providing the Claims Settlement Account arrangement, the Company agrees that it shall apply funds in the Claims Settlement Account against the Reinsurer's liability under this Agreement until such funds are exhausted.

(c) The Company shall keep true and complete records, in accordance with Applicable Law and its record management practices in effect from time to time for the Company's insurance business not covered by this Agreement, clearly recording the deposits in and withdrawals from the Claims Settlement Account, including records relating to the payment of Benefits from the Claim Settlement Account. The Company will make available to the Reinsurer or its designated representative, or shall furnish to the Reinsurer or its designated representative, upon request of the Reinsurer or its designated representative, copies of all such records. All copies furnished in the ordinary course of business shall be furnished by the Company at the Company's cost, which shall be included in the Expense Allowance. Any extraordinary costs reasonably incurred by the Company in response to requests from the Reinsurer shall be reimbursed by the Reinsurer.

(d) Within thirty (30) days after each calendar month (or more frequently as mutually agreed by the parties), the Company shall render a complete accounting to the Reinsurer detailing all transactions with respect to the Claims Settlement Account, in such form as agreed by the parties.

(e) The parties agree to deliver to the depository bank such depository resolutions, signature cards, and other documents as may be requested of them in order to use such accounts at the depository bank in accordance with the provisions of this Article IV.

(f) Upon a termination of this Agreement pursuant to Article VIII, the Reinsurer shall close the Claims Settlement Account and any closing balance therein shall be the property of the Reinsurer. The Company's claims payment authority under this Agreement with respect to the Claims Settlement Account shall terminate immediately upon termination of this Agreement pursuant to Article VIII or the assumption by the Reinsurer of the administration of the Reinsured Contracts pursuant to Section 3.7. Upon termination of its authority to pay claims, the Company shall promptly return to the Reinsurer all unused check stock held by it in connection with this Agreement.

#### ARTICLE V

##### REINSURANCE ASSET TRANSFER; CEDING COMMISSION

5.1. Initial Reinsurance Premium. As consideration for the reinsurance by the Reinsurer of the Reinsured Risks under this Agreement, on the Closing Date the Reinsurer shall be entitled to an amount equal to one hundred percent (100%) of the Total SAP Ceded Reserves as of the close of business on the day immediately preceding the Inception Date (the "Initial Reinsurance Premium").

9

---



5.2. Ceding Commission. On the Closing Date, the Company shall be entitled to a ceding commission (the "Ceding Commission") in an amount determined in accordance with Schedule C.

5.3. Amounts Due the Parties. (a) Except as otherwise specifically provided herein, all amounts due to be paid to the Company under this Agreement shall be determined on a net basis, giving full effect to Section 3.6. The net amount due the Reinsurer from the Company on the Closing Date under Section 5.1 and Section 5.2 shall consist of (i) the investment assets (the "Assets") set forth on Schedule D, which assets have a statutory book value as of the close of business on the day immediately preceding the Inception Date equal to (A) the Initial Reinsurance Premium, less (B) the Ceding Commission, less (C) an amount equal to accrued but unpaid interest on the Assets as of the close of business on the day immediately preceding the Inception Date, plus (ii) an amount equal to the investment cash flows received on the Assets between the Inception Date and the Closing Date. The Company shall pay such net amount concurrent with its delivery of the Initial Report. Each net amount subsequently due with respect to each Accounting Period ending after the Inception Date (the "Quarterly Settlement") shall be paid in cash by the Reinsurer to the Company no later than thirty (30) days after delivery of the Quarterly Report, as applicable. Each net amount subsequently due with respect to each calendar year ending after the Inception Date as reflected on an Annual Report shall be paid in cash by the Reinsurer to the Company no later than thirty (30) days after delivery of the Annual Report.

(b) The Company shall deliver to the Reinsurer possession of the Assets and such bills of sale, endorsements, assignments and other good and sufficient instruments of conveyance and transfer in form and substance reasonably acceptable to the parties as shall be effective to vest in the Reinsurer all of the right, title and interest of the Company in and to the Assets. Delivery of the Assets shall be a condition precedent of reinsurance coverage hereunder.

## ARTICLE VI

### EXPENSE ALLOWANCES

6.1. Expense Allowance. As reimbursement for expenses incurred by the Company in the providing of policyholder and Benefit payment services with respect to the Reinsured Contracts, the Reinsurer shall pay to the Company with respect to each calendar month ending after the Inception Date, an expense allowance (each an "Expense Allowance") in an amount calculated in accordance with Schedule E, as subsequently adjusted in accordance with the methodology and procedures set forth on Schedule E.

10

---

## ARTICLE VII

### ACCOUNTING AND SETTLEMENT

7.1. Initial Report. A report shall be provided by the Company to the Reinsurer on the Closing Date providing the data required in Schedule F - Part I (the "Initial Report").

7.2. Quarterly Settlement Reports. As soon as practicable but not more than forty (40) days following each Accounting Period ending after the Closing Date (or more frequently as mutually agreed by the parties), the Company shall supply the Reinsurer with a report that shall provide the financial data for such Accounting Period required in Schedule F - Part II (the "Quarterly Report"). For the avoidance of doubt, the first Quarterly Report will include all transactions with respect to the Reinsured Contracts occurring from the Inception Date through June 30, 2004.

7.3. Quarterly Financial Reports. As soon as practicable but not more than forty (40) days following the end of each Accounting Period ending after the Closing Date (or more frequently as mutually agreed by the parties), the Company shall supply the Reinsurer with reports related to the Reinsured Contracts as may be reasonably requested for use in connection with the preparation of the Reinsurer's SAP financial statements or other reports prepared by the Reinsurer in compliance with its internal reporting requirements. The parties shall cooperate in good faith to establish the form for the providing of such reports.

7.4. Annual Reports. Within forty-five (45) days after the end of each calendar year during the term of this Agreement (or more frequently as mutually agreed by the parties), the Company shall supply the Reinsurer with a report that shall provide the financial data for such year required in Schedule F - Part III (the "Annual Report").

7.5. Additional Reports and Updates. For so long as this Agreement remains in effect, each of the parties shall periodically furnish to the other such other reports and information as may be reasonably requested by such other party for regulatory, tax or similar purposes and reasonably available to it.

7.6. Delayed Payments. In the event that all or any portion of any payment due either party pursuant to this Agreement becomes overdue, the portion of the amount overdue shall bear interest at an annual rate equal to the then current thirty (30) day U.S. Treasury Bill discount rate on the date that the payment becomes overdue plus 200 basis points, for the period that the amount is overdue.

## ARTICLE VIII

### DURATION AND TERMINATION

8.1. Duration. Except as otherwise provided herein, this Agreement shall be unlimited in duration.

11

---

8.2. Reinsurer's Liability. The Reinsurer's liability with respect to the Reinsured Risks will terminate on the earliest of: (i) the date the Company's liability with respect to the Reinsured Risks is terminated and all amounts due the Company from the Reinsurer with respect to such Reinsured Risks are paid to the Company by or on behalf of the Reinsurer; and (ii) the date this Agreement is terminated upon the written agreement of the parties.

8.3. Notice of Termination. Upon the termination of the Reinsurer's liability with respect to the Reinsured Risks referred to in Section 8.2 above, the parties shall mutually give the Trustee written notice of their intention to terminate the Trust Account.

## ARTICLE IX

### INSOLVENCY

9.1. Payments. In the event of the insolvency of the Company, the reinsurance payable by the Reinsurer hereunder shall be payable directly to the Company or to its domiciliary liquidator or receiver on the basis of the liability of the Reinsurer under the contract or contracts reinsured, without diminution because of the insolvency of the Company. It is agreed and understood, however, that (i) in the event of the insolvency of the Company, the Reinsurer shall be given written notice of the pendency of a claim against the insolvent Company on a Reinsured Contract within a reasonable time after such claim is filed in the insolvency proceeding and (ii) during the pendency of such claim the Reinsurer may investigate such claim and interpose, at its own expense, in the proceeding where such claim is to be adjudicated any defenses which it may deem available to the Company or its domiciliary liquidator, receiver or statutory successor.

9.2. Expenses. It is further understood that any expense thus incurred by the Reinsurer pursuant to Section 9.1 shall be chargeable, subject to court approval, against the insolvent Company as part of the expense of liquidation to the extent of a proportionate share of the benefit which may accrue to the Company solely as a result of the defense undertaken by the Reinsurer. Where two or more assuming reinsurers are involved in the same claim and a majority in interest elect to interpose defenses to such claim, the expense shall be apportioned in accordance with the terms of this Agreement as though such expense had been incurred by the Company.

## ARTICLE X

### CREDIT FOR REINSURANCE

10.1. Reinsurance Credit. Notwithstanding any other provision of this Agreement to the contrary, if the Reinsurer becomes unauthorized or otherwise unaccredited as an insurer or reinsurer in any U.S. jurisdiction to which the Company must provide statutory statements of financial condition such that the Company will not obtain full statutory financial statement credit for reinsurance in such state for the reinsurance provided under this Agreement, the Reinsurer, upon the request of the Company, will establish, at the Reinsurer's sole cost and

12

---

option, trust accounts for the benefit of the Company, letters of credit, or other acceptable alternatives necessary to permit the Company to obtain such full statutory financial statement credit for such reinsurance in all applicable jurisdictions. The Company shall cooperate with the Reinsurer to take such steps. In addition, in such event, the Reinsurer agrees to amend this Agreement and the Trust Agreement to the extent required under Applicable Law in order to provide the Company with such full statutory financial statement credit.

## ARTICLE XI

### REINSURANCE SECURITY

11.1. Trust. (a) On the Closing Date, the Reinsurer shall enter into a trust agreement in the form attached as Schedule G (the "Trust Agreement") and establish a trust account (the "Trust Account") for the benefit of the Company with respect to the Reinsured Risks with a bank (the "Trustee") designated as a Qualified United States Financial Institution by the Securities Valuation Office of the National Association of Insurance Commissioners or any successor organization or regulatory agency having similar duties.

(b) The Reinsurer agrees to deposit, and maintain in the Trust Account with respect to this Agreement, assets to be held in trust by the Trustee for the benefit of the Company as security for the payment of the Reinsurer's obligations to the Company under this Agreement.

(c) The parties agree that the assets so deposited with respect to this Agreement shall be valued according to their current statutory book value on the books of the Reinsurer and shall consist only of cash (United States legal tender), certificates of deposit (issued by a United States bank and payable in United States legal tender), and other assets of the type specified on Schedule H attached hereto ("Eligible Securities").

(d) The Reinsurer, prior to depositing assets with the Trustee, shall execute all assignments and endorsements in blank, or transfer legal title to the Trustee of all shares, obligations or any other assets requiring assignments, in order that, to the extent practicable, the Company, or the Trustee upon direction of the Company, may whenever necessary negotiate any such assets without consent or signature from the Reinsurer or any other entity. The Company recognizes that certain assets in the Trust Account will not be readily negotiable and that certain notices, opinions of counsel, representations and/or consents will be required for the Company to obtain good and marketable title to such assets.

(e) The Reinsurer and the Company agree that the assets in the Trust Account with respect to this Agreement may be withdrawn for the following purposes only:

- (i) to pay or reimburse the Company for any amount due the Company pursuant to this Agreement to the extent not so paid or reimbursed by the Reinsurer;
- (ii) to pay to the Reinsurer, in accordance with paragraph (h) below, any amounts held in the Trust Account that exceed an amount (the "Funding

13

---

Requirement") equal to the sum of Total SAP Ceded Reserves and any additional reserves attributable to the Reinsured Risks that arise as a result of regulatory asset adequacy analysis requirements of the Reinsurer, less, prior to the date on which the Claims Settlement Account is closed, the Minimum Claims Settlement Amount then in effect; and

- (iii) in the event that General Electric Capital Corporation breaches its obligations under the Capital Maintenance Agreement, to fund an account with the Company (the "Company Account") in an amount at least equal to the deduction, for reinsurance ceded, from the Company's liabilities ceded under this Agreement. Such amount shall include, but not be limited to, amounts for policy reserves, reserves for claims and losses incurred (including losses incurred but not reported), loss and loss adjustment expenses, and unearned premiums.

(f) In the event that the Company withdraws assets from the Trust Account for the purposes set forth in Section 11.1(e)(i) above in excess of actual amounts required to meet the Reinsurer's obligations to the Company, the Company will promptly return such excess to the Reinsurer, plus interest at an annual rate equal to the then current thirty (30) day U.S. Treasury Bill discount rate on the date of withdrawal plus 200 basis points for the period during which the amounts were held pursuant to Section 11.1(e)(i). In the event that the Company withdraws assets from the Trust Account for the purposes set forth in Section 11.1(e)(iii) above, (i) the Reinsurer shall be relieved of its obligation to maintain assets in the Trust Account pursuant to this Section 11.1 to the extent of the amount of funds held in the Company Account and (ii) the Company shall first apply the funds in the Company Account in satisfaction of the Reinsurer's liability under this Agreement until the funds in the Company Account are exhausted. In the event that the Company withdraws assets from the Trust Account for the purposes set forth in Section 11.1(e)(iii) above, promptly following the date the Reinsurer's liability with respect to the Reinsured Risks is terminated, the Company shall return to the Reinsurer any assets so withdrawn that, together with any and all interest, dividends and other earnings thereon from the date of withdrawal to the date of return, are in excess of actual amounts required to meet the Reinsurer's obligations to the Company under this Agreement.

(g) The initial deposit to the Trust Account with respect to this Agreement shall be made on the Closing Date and shall consist of assets with a statutory book value equal to the Total SAP Ceded Reserves as of the close of business on the day immediately preceding the Inception Date, less an amount of assets with a statutory book value equal to the initial Minimum Claims Settlement Amount.

(h) The aggregate statutory book value of the assets held in the Trust Account with respect to this Agreement, shall at all times be at least equal to the Funding Requirement, and shall be adjusted on a quarterly basis so as to equal the Funding Requirement. On a quarterly basis, the Company shall promptly prepare and deliver to the Reinsurer a specific statement of the Funding Requirement and the Reinsurer shall promptly prepare and deliver to the Company a specific statement of the

statement date, the Reinsurer shall, within ten (10) Business Days after receipt of such notice of excess, secure delivery to the Trustee of additional cash or Eligible Securities having a current statutory book value equal to such difference. If the statement shows that the Funding Requirement is less than 100% of the balance of the Trust Account with respect to this Agreement as of the statement date, the Company shall, within ten (10) Business Days after delivery of such statement to the Reinsurer, deliver a notice of withdrawal to the Trustee directing the Trustee to withdraw from the Trust Account and deliver to the Reinsurer assets from the Trust Account having a current statutory book value equal to such excess amount. In addition to the foregoing, the Reinsurer shall prepare and deliver to the Company on a quarterly basis a specific statement of the market value of the assets in the Trust Account as of the end of the quarter.

## ARTICLE XII

### DEFERRED ACQUISITION COSTS

12.1. Tax DAC Information Sharing. To ensure consistency in their respective Tax DAC calculations for tax purposes, the Company and the Reinsurer will exchange information pertaining to the amount of net consideration under this Agreement each year. The Company will submit a schedule to the Reinsurer by February 28 of each year presenting its calculation of the net consideration for the preceding taxable year. The Reinsurer may contest the calculation by providing to the Company an alternative calculation in writing within thirty (30) days of receipt of the Company's schedule. The Company and the Reinsurer will act in good faith to resolve any differences in the schedule of calculations within thirty (30) days of receipt of the alternative calculation to ensure consistent amounts are reported on the respective tax returns for the preceding tax year.

## ARTICLE XIII

### DISPUTE RESOLUTION

13.1. General Provisions. (a) Any dispute, controversy or claim arising out of or relating to this Agreement or the validity, interpretation, breach or termination thereof (a "Dispute"), shall be resolved in accordance with the procedures set forth in this Article XIII, which shall be the sole and exclusive procedures for the resolution of any such Dispute unless otherwise specified below.

(b) Commencing with the request contemplated by Section 13.2, all communications between the parties or their representatives in connection with the attempted resolution of any Dispute, including any mediator's evaluation referred to in Section 13.3, shall be deemed to have been delivered in furtherance of a Dispute settlement and shall be exempt from discovery and production, and shall not be admissible in evidence for any reason (whether as an admission or otherwise), in any arbitral or other proceeding for the resolution of the Dispute.

(c) In connection with any Dispute, the parties expressly waive and forego any right to (i) punitive, exemplary, statutorily-enhanced or similar damages in excess of compensatory damages, and (ii) trial by jury.

(d) The specific procedures set forth below, including but not limited to the time limits referenced therein, may be modified by agreement of the parties in writing.

(e) All applicable statutes of limitations and defenses based upon the passage of time shall be tolled while the procedures specified in this Article XIII are pending. The parties will take such action, if any, required to effectuate such tolling.

13.2. Consideration by Senior Executives. If a Dispute is not resolved in the normal course of business at the operational level, the parties shall attempt in good faith to resolve such Dispute by negotiation between executives who hold, at a minimum, the office of President and CEO of the respective business entities involved in such Dispute. Either party may initiate the executive negotiation process by providing a written notice to the other (the "Initial Notice"). Fifteen (15) days after delivery of the Initial Notice, the receiving party shall submit to the other a written response (the "Response"). The Initial Notice and the Response shall include (i) a statement of the Dispute and of each party's position, and (ii) the name and title of the executive who will represent that party and of any other person who will accompany the executive. Such executives will meet in person or by telephone within thirty (30) days of the date of the Initial Notice to seek a resolution of the Dispute.

13.3. Mediation. If a Dispute is not resolved by negotiation as provided in Section 13.2 within forty-five (45) days from the delivery of the Initial Notice, then either party may submit the Dispute for resolution by mediation pursuant to the CPR Institute for Dispute Resolution (the "CPR") Model Mediation Procedure as then in effect. The parties will select a mediator from the CPR Panels of Distinguished Neutrals, but such mediator must have prior U.S. reinsurance experience either as a lawyer or as a present or former officer or management employee of a reinsurance company, but not of the Company, or the Reinsurer, or any of their respective affiliates. Either party at commencement of the mediation may ask the mediator to provide an evaluation of the Dispute and the parties' relative positions.

13.4. Arbitration. (a) If a Dispute is not resolved by mediation as provided in Section 13.3 within thirty (30) days of the selection of a mediator (unless the mediator chooses to withdraw sooner), either party may submit the Dispute to be finally resolved by arbitration pursuant to the CPR Rules for Non-Administered Arbitration as then in effect (the "CPR Arbitration Rules"). The parties consent to a single, consolidated arbitration for all known Disputes existing at the time of the arbitration and for which arbitration is permitted.

(b) The neutral organization for purposes of the CPR Arbitration Rules will be the CPR. The arbitral tribunal shall be composed of three arbitrators who are each experienced in the U.S. reinsurance business, of whom each party shall appoint one in accordance with the "screened" appointment procedure provided in Rule 5.4 of the CPR Arbitration Rules. The non-party appointed arbitrator must have prior U.S. reinsurance experience as a present or former officer or management employee of a reinsurance company, but not of the Company, or the Reinsurer, or any of their respective affiliates. The arbitration shall be conducted in New York

City. Each party shall be permitted to present its case, witnesses and evidence, if any, in the presence of the other party. A written transcript of the proceedings shall be made and furnished to the parties. The arbitrators shall determine the Dispute in accordance with the law of Virginia, without giving effect to any conflict of law rules or other rules that might render such law inapplicable or unavailable, and shall apply this Agreement according to its terms, provided that the provisions relating to arbitration shall be governed by the Federal Arbitration Act, 9 U.S.C. §§ 1 et seq. The arbitral tribunal shall endeavor to render its award or order resulting from any arbitration within forty-five (45) days following the termination of the arbitration proceedings.

(c) The parties agree to be bound by any award or order resulting from any arbitration conducted hereunder and further agree that judgment on any

award or order resulting from an arbitration conducted under this Section may be entered and enforced in any court having jurisdiction thereof.

(d) Except as expressly permitted by this Agreement, no party will commence or voluntarily participate in any court action or proceeding concerning a Dispute, except (i) for enforcement as contemplated by Section 13.4(c) above, (ii) to restrict or vacate an arbitral decision based on the grounds specified under applicable law, or (iii) for interim relief as provided in paragraph (e) below. For purposes of the foregoing the parties hereto submit to the non-exclusive jurisdiction of the courts of the State of New York.

(e) In addition to the authority otherwise conferred on the arbitral tribunal, the tribunal shall have the authority to make such orders for interim relief, including injunctive relief, as it may deem just and equitable. Notwithstanding paragraph (d) above, each party acknowledges that in the event of any actual or threatened breach of certain of the provisions of this Agreement, the remedy at law would not be adequate, and therefore injunctive or other interim relief may be sought immediately to restrain such breach. If the tribunal shall not have been appointed, either party may seek interim relief from a court having jurisdiction if the award to which the applicant may be entitled may be rendered ineffectual without such interim relief. Upon appointment of the tribunal following any grant of interim relief by a court, the tribunal may affirm or disaffirm such relief, and the parties will seek modification or rescission of the court action as necessary to accord with the tribunal's decision.

(f) Each party will bear its own attorneys' fees and costs incurred in connection with the resolution of any Dispute in accordance with this Article XIII.

#### ARTICLE XIV

##### MISCELLANEOUS PROVISIONS

14.1. Headings and Schedules. Headings used herein are not a part of this Agreement and shall not affect the terms hereof. The attached Schedules are a part of this Agreement.

14.2. Notices. All notices, requests, demands and other communications under this Agreement must be in writing and will be deemed to have been duly given or made as

17

---

follows: (a) if sent by registered or certified mail in the United States return receipt requested, upon receipt; (b) if sent by reputable overnight air courier, two business days after mailing; (c) if sent by facsimile transmission, with a copy mailed on the same day in the manner provided in (a) or (b) above, when transmitted and receipt is confirmed by telephone; or (d) if otherwise actually personally delivered, when delivered, and shall be delivered as follows:

If to the Company:

Federal Home Life Insurance Company  
6620 West Broad Street  
Richmond, VA 23230  
Facsimile: (804) 662-2414  
Attention: Chief Executive Officer

With a copy to:

Federal Home Life Insurance Company  
700 Main Street  
Lynchburg, VA 24504  
Facsimile: (434) 948-5819  
Attention: General Counsel

If to the Reinsurer:

Union Fidelity Life Insurance Company  
200 North Martingale Road  
Schaumburg, IL 60173-2096  
Facsimile: (847) 330-3404  
Attention: Chief Financial Officer

With a copy to:

Union Fidelity Life Insurance Company  
200 North Martingale Road  
Schaumburg, IL 60173-2096  
Facsimile: (847) 605-3044  
Attention: General Counsel

or to such other address or to such other Person as either party may have last designated by notice to the other party.

14.3. Successors and Assigns. This Agreement shall be binding upon and inure to the benefit of the parties hereto and their respective successors, permitted assigns and legal representatives. Neither this Agreement, nor any right or obligation hereunder, may be assigned by any party without the prior written consent of the other party hereto. Any assignment in violation of this Section 14.3 shall be void and shall have no force and effect. Nothing in this Section 14.3 shall be construed to prohibit the Reinsurer from retroceding all or any portion of the business reinsured hereunder.

18

---

14.4. Execution in Counterpart. This Agreement may be executed by the parties hereto in any number of counterparts, and by each of the parties hereto in separate counterparts, each of which counterparts, when so executed and delivered, shall be deemed to be an original, but all such counterparts shall together constitute but one and the same instrument.

14.5. Currency. Whenever the word "Dollars" or the "\$" sign appear in this Agreement, they shall be construed to mean United States Dollars, and all transactions under this Agreement shall be in United States Dollars.

14.6. Amendments. This Agreement may not be changed, altered or modified unless the same shall be in writing executed by the Company and the

Reinsurer.

14.7. Governing Law. This Agreement will be construed, performed and enforced in accordance with the laws of the Commonwealth of Virginia without giving effect to its principles or rules of conflict of laws thereof to the extent such principles or rules would require or permit the application of the laws of another jurisdiction.

14.8. Entire Agreement; Severability. (a) This Agreement and the Termination Letter Agreement constitute the entire agreement between the parties hereto relating to the subject matter hereof and supersede all prior and contemporaneous agreements, understandings, statements, representations and warranties, negotiations and discussions, whether oral or written, of the parties and there are no general or specific warranties, representations or other agreements by or among the parties in connection with the entering into of this Agreement or the subject matter hereof except as specifically set forth or contemplated herein or in the Termination Letter Agreement.

(b) If any provision of this Agreement is held to be void or unenforceable, in whole or in part, (i) such holding shall not affect the validity and enforceability of the remainder of this Agreement, including any other provision, paragraph or subparagraph, and (ii) the parties agree to attempt in good faith to reform such void or unenforceable provision to the extent necessary to render such provision enforceable and to carry out its original intent.

14.9. Contemporaneous Agreements. Concurrent with the execution of this Agreement, the parties and/or their Affiliates are also entering into the Capital Maintenance Agreement, the RBC Reporting Letter Agreement and the Assignment Letter Agreement.

14.10. No Waiver; Preservation of Remedies. No consent or waiver, express or implied, by any party to or of any breach or default by any other party in the performance by such other party of its obligations hereunder shall be deemed or construed to be a consent or waiver to or of any other breach or default in the performance of obligations hereunder by such other party hereunder. Failure on the part of any party to complain of any act or failure to act of any other party or to declare any other party in default, irrespective of how long such failure continues, shall not constitute a waiver by such first party of any of its rights hereunder. The rights and remedies provided are cumulative and are not exclusive of any rights or remedies that any party may otherwise have at law or equity.

14.11. Cooperation. Each party hereto shall cooperate fully with the other in all reasonable respects in order to accomplish the objectives of this Agreement including making

available to each their respective officers and employees for interviews and meetings with Governmental Authorities and furnishing any additional assistance, information and documents as may be reasonably requested by a party from time to time.

14.12. Third Party Beneficiary. Nothing in this Agreement will confer any rights upon any Person that is not a party or a successor or permitted assignee of a party to this Agreement.

14.13. Tax Exception to Any Confidentiality. Notwithstanding anything to the contrary set forth herein or in any other agreement to which the parties hereto are parties or by which they are bound, any obligations of confidentiality contained herein and therein, as they relate to the transactions, shall not apply to the federal tax structure or federal tax treatment of the transactions, and each party hereto (and any employee, representative, or agent of any party hereto) may disclose to any and all persons, without limitation of any kind, the federal tax structure and federal tax treatment of the transactions. The preceding sentence is intended to cause the transactions to be treated as not having been offered under conditions of confidentiality for purposes of Section 1.6011-4(b)(3) (or any successor provision) of the Treasury Regulations promulgated under Section 6011 of the Internal Revenue Code of 1986, as amended, and shall be construed in a manner consistent with such purpose. In addition, each party hereto acknowledges that it has no proprietary or exclusive rights to the federal tax structure of the transactions or any federal tax matter or federal tax idea related to the transactions.

14.14. Interpretation. Wherever the words "include," "includes" or "including" are used in this Agreement, they shall be deemed to be followed by the words "without limitation."

14.15. Survival. Article XIII and Article XIV shall survive the termination of this Agreement.

IN WITNESS WHEREOF, the parties hereto have caused this Agreement to be executed by their duly authorized representatives.

FEDERAL HOME LIFE INSURANCE COMPANY

By /s/ VICTOR C. MOSES

Name: Victor C. Moses  
Title: Senior Vice President

UNION FIDELITY LIFE INSURANCE COMPANY

By /s/ GLENN JOPPA

Name: Glenn Joppa  
Title: Senior Vice President and Secretary

SCHEDULE A  
POLICY FORMS

8001

8101

8201

8401

## SCHEDULE B

FORM OF ADMINISTRATIVE SERVICES AGREEMENT

SSA UFLIC/FHL

## ADMINISTRATIVE SERVICES AGREEMENT

by and between

FEDERAL HOME LIFE INSURANCE COMPANY

and

UNION FIDELITY LIFE INSURANCE COMPANY

Effective as of [       ]

**ADMINISTRATIVE SERVICES AGREEMENT**

This ADMINISTRATIVE SERVICES AGREEMENT (this "Agreement"), effective as of [       ] (the "Effective Date"), is entered into by and between FEDERAL HOME LIFE INSURANCE COMPANY, an insurance company organized under the laws of the Commonwealth of Virginia (the "Company"), and UNION FIDELITY LIFE INSURANCE COMPANY, an insurance company organized under the laws of the State of Illinois (the "Administrator").

**RECITALS:**

WHEREAS, the Company and the Administrator have entered into a Coinsurance Agreement dated as of April 15, 2004 (the "Coinsurance Agreement") which provides for the parties to enter into this Agreement;

WHEREAS, pursuant to the Coinsurance Agreement, the Administrator has agreed to indemnify the Company for, among other things, 100% of the liability of the Company for Benefits payable on or after the Inception Date with respect to the Reinsured Contracts (capitalized terms used herein and not defined herein, unless otherwise indicated, have the respective meanings assigned to them in the Coinsurance Agreement); and

WHEREAS, the Company wishes to appoint the Administrator to provide policyholder and claim servicing with respect to the Reinsured Contracts, and the Administrator desires to provide such administrative services;

NOW, THEREFORE, in consideration of the covenants and agreements set forth herein, the parties hereto agree as follows:

## ARTICLE I

AUTHORITY

The Company hereby appoints the Administrator, and the Administrator hereby accepts appointment, to provide as an independent contractor of the Company, from and after the Effective Date, all of the policyholder and claim servicing services necessary or appropriate with respect to the Reinsured Contracts including those set forth in this Agreement (the "Administrative Services"), all on the terms as set forth in this Agreement. Notwithstanding any other provision of this Agreement to the contrary, the Company shall have the right to direct the Administrator to perform any action necessary for the Reinsured Contracts or the policyholder and claim servicing thereof to comply with Applicable Law, or to cease performing any action that constitutes a violation of Applicable Law.

## ARTICLE II

STANDARD FOR SERVICES; FACILITIES; SUBCONTRACTING

2.1. Standard for Services. The Administrator shall provide policyholder and claims servicing with respect to the Reinsured Contracts in good faith and with the care, skill, prudence and diligence of a person experienced in administering structured settlement business. Without limiting the generality of the foregoing, the Administrator shall provide policyholder and claims servicing with respect to the Reinsured Contracts (i) in accordance with the terms of the Reinsured Contracts, (ii) in accordance with the applicable terms of this Agreement, (iii) in compliance with Applicable Law, (iv) in accordance with industry standards and, subject to the foregoing, (v) to the extent applicable, in the same manner as it conducts its own business not subject to this Agreement.

2.2. Facilities and Personnel. To the extent not sub-contracted to a Subcontractor, the Administrator shall at all times maintain sufficient facilities and trained personnel of the kind necessary to perform its obligations under this Agreement in accordance with the performance standards set forth herein.

2.3. Subcontracting. The Administrator may subcontract for the performance of any policyholder or claims servicing service or services with respect to the Reinsured Contracts to (i) an Affiliate or (ii) any other Person with the prior written consent of the Company, such consent not to be unreasonably withheld (in each case, the "Subcontractor"); provided, that, no such subcontracting shall relieve the Administrator from any of its obligations or liabilities hereunder, and the Administrator shall

remain responsible for all obligations or liabilities of such Subcontractor with regards to the providing of such service or services as if provided by the Administrator.

### ARTICLE III

#### CLAIMS HANDLING

The Administrator shall pay all Benefits payable on or after the Inception Date with respect to the Reinsured Contracts (each, a "Claim" and collectively the "Claims").

### ARTICLE IV

#### REGULATORY AND LEGAL PROCEEDINGS

4.1. Regulatory Complaints and Proceedings. The Administrator shall:

- (i) respond to any Claims payment related complaints or inquiries made by any Governmental Authority, within the Governmental Authority's requested time frame for response or, if no such time frame is provided, within the time frame as allowed by Applicable Law; and promptly provide a copy of such response to the Company;

2

---

- (ii) promptly notify the Company of any non-Claims payment related complaints or inquiries initiated by a Governmental Authority, and of any proceedings (either Claims or non-Claims related) initiated by a Governmental Authority, and, in either case, prepare and send to the Governmental Authority, with a copy to the Company, a response within the Governmental Authority's requested time frame for response or, if no such time frame is provided, within the time frame as allowed by Applicable Law; provided, that, subject to meeting such time frames, the Administrator shall provide such response to the Company for its prior review and comment;
- (iii) subject to Section 4.4, supervise and control the investigation, contest, defense and/or settlement of all complaints, inquiries and proceedings by Governmental Authorities at its own cost and expense, and in the name of the Company when necessary; and
- (iv) at the Company's request, provide to the Company a report in a form mutually agreed by the parties summarizing the nature of any complaints, inquiries or proceedings by Governmental Authorities, the alleged actions or omissions giving rise to such complaints, inquiries or proceedings and copies of any files or other documents that the Company may reasonably request in connection with its review of these matters.

4.2. Legal Proceedings. The Administrator shall:

- (i) notify the Company promptly of any lawsuit, action, arbitration or other dispute resolution proceedings that are instituted or threatened with respect to any matter relating to the Reinsured Contracts ("Legal Proceeding(s)"), and in no event more than five (5) Business Days after receipt of notice thereof;
- (ii) subject to Section 4.4, supervise and control the investigation, contest, defense and/or settlement of all Legal Proceedings at its own cost and expense, and in the name of the Company when necessary; and
- (iii) keep the Company fully informed of the progress of all Legal Proceedings handled by the Administrator in which the Company is named a party and, at the Company's request, provide to the Company a report summarizing the nature of any Legal Proceedings, the alleged actions or omissions giving rise to such Legal Proceedings and copies of any files or other documents that the Company may reasonably request in connection with its review of these matters in each case other than such files, documents and other information as would, in the judgment of counsel to the Administrator, lead to the loss or waiver of legal privilege.

4.3. Notice to Administrator. The Company shall give prompt notice to the Administrator of any Legal Proceeding made or brought against the Company after the Inception

3

---

Date arising under or in connection with the Reinsured Contracts to the extent known to it and not made against or served on the Administrator or a Subcontractor as administrator hereunder, and in no event more than five (5) Business Days after receipt of notice thereof, and shall promptly furnish to the Administrator copies of all pleadings in connection therewith. The Administrator shall assume the defense of the Company.

4.4. Defense of Regulatory and Legal Proceedings. Notwithstanding anything in this Agreement to the contrary, the Company shall have the right to engage in its own separate legal representation, at its own expense, and to participate fully in the defense of any Legal Proceedings or complaints, inquiries or proceedings by Governmental Authorities with respect to the Reinsured Contracts in which the Company is a named party without waiving any right to indemnification it may have under Article XV hereof. The Administrator and the Company shall cooperate with each other with respect to the administration of any Legal Proceeding and any complaint, inquiry or proceeding by Governmental Authorities. The Administrator shall not settle any Legal Proceeding or any complaint, inquiry or proceeding by Governmental Authorities without the Company's prior written consent (which consent shall not be unreasonably withheld or delayed) unless (i) there is no finding or admission of any violation of law or any violation of the rights of any Person, (ii) such settlement would not reasonably be expected to have material adverse precedential consequences to the Company and (iii) the sole relief provided is monetary damages that are paid in full by the Administrator.

### ARTICLE V

#### NOTIFICATION TO POLICYHOLDERS

The Administrator agrees to send to policyholders of the Reinsured Contracts a written notice prepared by the Administrator and reasonably acceptable to the Company to the effect that the Administrator, or such other Person designated by the Administrator in accordance with the terms of this Agreement, has been appointed by the Company to provide Administrative Services. The Administrator shall send such notice by first class U.S. mail at a time reasonably acceptable to the Company and the Administrator and in all events in accordance with Applicable Law. The parties intend to minimize the cost associated with any notification under this Article V, including by means of inclusion of the notice in a regularly scheduled mailing to policyholders in lieu of a separate mailing. The cost associated with such notification under this Article V (upon the initial assumption of the administration of the Reinsured Contracts under Section 3.7 of the Coinsurance Agreement) shall be a transition cost payable by the Administrator or the Company in accordance with Section 3.7(a) or 3.7(c) of the Coinsurance Agreement, as applicable.

### ARTICLE VI

## INSOLVENCY FUND ACCOUNTINGS

6.1. Quarterly Accountings. Within thirty (30) days after the end of each calendar quarter that this Agreement is in effect (or more frequently as mutually agreed by the

4

---

parties), the Company shall submit to the Administrator a written statement of accounting in a form and containing such information to be agreed upon by the parties hereto (each, an "Insolvency Fund Quarterly Accounting") setting forth the Insolvency Fund amounts assessed or payable to the extent that such assessments constitute Reinsured Risks with respect to the Reinsured Contracts (collectively, the "Post-Effective Date Assessments"). The Administrator shall remit to the Company an amount equal to the Post-Effective Date Assessments set forth in an Insolvency Fund Quarterly Accounting received by the Administrator within ten (10) Business Days of receipt by the Administrator of such Insolvency Fund Quarterly Accounting.

6.2. Adjustments Regarding Insolvency Fund Accountings. In the event that subsequent data or calculations require revision of any of the Insolvency Fund Quarterly Accountings, the required revision and appropriate payments thereunder shall be made within ten (10) Business Days after the parties hereto mutually agree as to the appropriate revision.

## ARTICLE VII

### CERTAIN ACTIONS BY COMPANY

7.1. Filings. The Company shall prepare and timely file any filings required to be made with any Governmental Authority that relate to the Company generally and not just to the Reinsured Contracts, including filings with guaranty associations and filings and premium tax returns with taxing authorities. The Administrator shall, in a timely fashion in light of the dates such filings by the Company are required, provide to the Company all information in the possession of the Administrator with respect to the Reinsured Contracts that may be reasonably required for the Company to prepare such filings and tax returns.

7.2. Annual Adjustment. The Company shall pay or provide to the Administrator the benefit of any Post-Effective Date Assessments which have been or can be applied to reduce the Company's premium tax liability ("Premium Tax Credits"). The Company shall provide to the Administrator by March 15 of each year a statement of the amount of Premium Tax Credits for the prior calendar year and the Company will pay or credit to the Administrator an amount equal to such Premium Tax Credits.

## ARTICLE VIII

### REGULATORY MATTERS AND AUDIT REPORTING

8.1. Regulatory Compliance and Reporting. The Administrator shall provide to the Company such information with respect to the Reinsured Contracts as is required to satisfy all current and future informational reporting, prior approval and any other requirements imposed by any Governmental Authority. Upon the reasonable request of the Company, the Administrator shall timely prepare such reports and summaries, including statistical summaries, as are necessary or reasonably required to satisfy any requirements imposed by a Governmental Authority upon the Company with respect to the Reinsured Contracts. In addition, the Administrator, upon the reasonable request of the Company, shall promptly provide to the Company copies of all existing records relating to the Reinsured Contracts (including, with

5

---

respect to records maintained in machine readable form, hard copies) that are necessary to satisfy such requirements. All copies of records furnished in the ordinary course of business shall be furnished by the Administrator at the Administrator's cost. Any extraordinary costs reasonably incurred by the Administrator in response to requests from the Company shall be reimbursed by the Company. Among other responsibilities:

- (i) The Administrator shall promptly prepare and furnish to Governmental Authorities all reports and related summaries (including, without limitation, statistical summaries), certificates of compliance and other reports required or requested by a Governmental Authority.
- (ii) The Administrator shall assist the Company and cooperate with the Company in doing all things necessary, proper or advisable, in the most expeditious manner practicable in connection with any and all market conduct or other Governmental Authority examinations relating to the Reinsured Contracts.

8.2. Reporting and Accounting. The Administrator shall assume the reporting and accounting obligations set forth below:

- (i) As soon as practicable but not more than forty (40) days after the end of each calendar quarter that this Agreement is in effect (or more frequently as mutually agreed by the parties), the Administrator shall timely provide to the Company reports and summaries of transactions (and, upon request of the Company, detailed supporting records) related to the Reinsured Contracts as may be reasonably required for use in connection with the preparation of the Company's statutory and GAAP financial statements, tax returns and other required financial reports and to comply with the requirements of the regulatory authorities having jurisdiction over the Company. The parties shall cooperate in good faith to establish the manner for the providing of such reports.
- (ii) As soon as practicable but not more than forty (40) days after the end of each calendar quarter that this Agreement is in effect (or more frequently as mutually agreed by the parties), the Administrator shall report to the Company the amount of statutory reserves that the Company is required to maintain in connection with the Reinsured Risks with respect to the Reinsured Contracts as of the quarter end.
- (iii) The Administrator shall promptly provide notice to the Company of any changes in the reserve methodology used by the Administrator in calculating statutory reserves for the Reinsured Contracts.
- (iv) Within forty-five (45) days after each calendar year end (or such longer time as may be agreed by the parties) that this Agreement is in effect, the Administrator shall provide to the Company (a) an opinion of an actuary reasonably acceptable to the Company as to the adequacy of statutory

6

---

reserves for the Reinsured Contracts, prepared according to accepted actuarial standards of practice, and as otherwise required for regulatory reporting purposes and (b) an analysis which reasonably supports such opinion.

8.3. Additional Reports and Updates. For so long as this Agreement remains in effect, each party shall periodically furnish to the other such other



reports and information as may be reasonably required by such other party for regulatory, tax or similar purposes and reasonably available to it.

ARTICLE IX

MISCELLANEOUS ADMINISTRATIVE SERVICES

The Administrator shall provide such other Administrative Services as are necessary or appropriate to fully effectuate the purpose of the Reinsurance Agreement and this Agreement, including such Administrative Services as are not performed by or on behalf of the Company on the date hereof but the need for which may arise due to changes or developments in Applicable Law.

ARTICLE X

BOOKS AND RECORDS

The Administrator shall keep accurate and complete records, files and accounts of all transactions and matters with respect to the Reinsured Contracts and the administration thereof in accordance with Applicable Law and its record management practices in effect from time to time for the Administrator's insurance business not covered by this Agreement, if any. The parties to this Agreement and their designated representatives may upon reasonable notice inspect, at the offices of the Administrator or the Company where such records are located, the papers and any and all other books or documents of the Administrator or the Company reasonably relating to this Agreement, including the Reinsured Contracts, and shall have access to appropriate employees and representatives of the other party, in each case during normal business hours for such period as this Agreement is in effect or for as long thereafter as any rights or obligations of any party survives or the Administrator or the Company reasonably need access to such records for regulatory, tax or similar purposes. The information obtained shall be used only for purposes relating to the transactions contemplated under this Agreement.

ARTICLE XI

COOPERATION

Each party hereto shall cooperate fully with the other in all reasonable respects in order to accomplish the objectives of this Agreement including making available to each their respective officers and employees for interviews and meetings with Governmental Authorities and

7

---

furnishing any additional assistance, information and documents as may be reasonably requested by a party from time to time.

ARTICLE XII

PRIVACY REQUIREMENTS

In providing the Administrative Services provided for under this Agreement, and in connection with maintaining, administering, handling and transferring the data of the policyholders and other recipients of benefits under the Reinsured Contracts, the Administrator shall, and shall cause its Affiliates and any permitted Subcontractors to, comply with all confidentiality and security obligations applicable to them in connection with the collection, use, disclosure, maintenance and transmission of personal, private, health or financial information about individual policyholders or benefit recipients, including the provisions of privacy policies under which such information was gathered, those laws currently in place and which may become effective during the term of this Agreement, including the Gramm-Leach-Bliley Act, the Health Insurance Portability and Accountability Act of 1996 and any other Applicable Laws. The Administrator shall entitle the Company and its agents and representatives, the Commissioner of Health and Human Services and such other Governmental Authorities, to the extent required by Applicable Law, to audit the Administrator's compliance herewith. The Administrator shall also enable individual subjects of personally identifiable information, upon request from such individuals, to review and correct information maintained by the Administrator about them, and to restrict use of such information. The Administrator shall promptly report to the Company any violation of this provision of which the Administrator becomes aware. Unless required by Applicable Law, the Administrator shall not during the term of this Agreement, modify the privacy policies under which information utilized by the Administrator in administering the Reinsured Contracts is gathered, without the Company's prior written consent, which consent shall not be unreasonably withheld. The parties agree to comply with the terms of the Business Associate Addendum attached hereto, if applicable, or such other written agreement as may be required by Applicable Law on the date hereof.

ARTICLE XIII

CONSIDERATION FOR ADMINISTRATIVE SERVICES

Apart from the performance by the Company of its obligations under the Coinsurance Agreement, there shall be no fee or other consideration due to the Administrator for performance of the Administrative Services under this Agreement.

ARTICLE XIV

BANK ACCOUNT; USE OF COMPANY LETTERHEAD

When and on terms reasonably requested by the Administrator, the Company shall open, modify or close, and make available for use by the Administrator for the payment of amounts to

8

---

be paid by the Administrator hereunder one or more bank accounts of the Company and check stock of the Company. The Administrator shall maintain such account(s) and pay all applicable bank fees and check stock costs. The Company shall adopt such resolutions and execute such documents as required to designate senior officers of the Administrator (by title) as signatories on such account(s) and authorize the Administrator to certify to such bank(s), from time to time, the names of such officers. The Company shall also make available to the Administrator, at the sole expense of the Administrator, such letterhead, printed forms and other documents of the Company as may be reasonably required by the Administrator in performing services hereunder. Upon termination of this Agreement, the Administrator shall promptly return to the Company all such unused check stock, letterhead, printed forms and other documents held by it in connection with this Agreement as provided under this Article XIV.

ARTICLE XV

INDEMNIFICATION

Any claim for or with respect to indemnification arising out of, or relating to, this Agreement or the Administrative Services hereunder shall be permitted under and governed by the provisions of Article V of the Master Agreement, dated as of [ ], 2004, among General Electric Company, General Electric Capital Corporation, GEI,

ARTICLE XVI

DURATION; TERMINATION

16.1. Duration. This Agreement shall commence on the Effective Date and continue with respect to each Reinsured Contract until no further Administrative Services in respect of such Reinsured Contract is required, unless this Agreement is earlier terminated under Section 16.2.

16.2. Termination. (a) This Agreement is subject to immediate termination at the option of the Company, upon written notice to the Administrator, on the occurrence of any of the following events:

- (i) A voluntary or involuntary proceeding is commenced in any jurisdiction by or against the Administrator for the purpose of conserving, rehabilitating or liquidating the Administrator;
- (ii) There is a material breach by the Administrator of any material term or condition of this Agreement that is not cured by the Administrator within thirty (30) days after receipt of written notice from the Company of such breach or act (provided that the Company shall not have the right to terminate this Agreement (A) for so long as the Administrator is making a

9

---

good faith effort to cure such breach, not to exceed an additional one hundred eighty (180) days or (B) during the pendency of any dispute resolution proceedings as set forth in Article XVII regarding an alleged material breach); or

- (iii) The Administrator is unable to perform the services required under this Agreement for a period of thirty (30) consecutive days for any reason other than as a result of a Force Majeure, it being understood that nothing in this Section 16.2(a)(iii) shall relieve the Administrator from its administrative responsibilities under this Agreement. For purposes of this Agreement, "Force Majeure" means any acts or omissions of any civil or military authority, acts of God, acts or omissions of the Company, fires, strikes or other labor disturbances, equipment failures, fluctuations or non-availability of electrical power, heat, light, air conditioning or telecommunications equipment, or any other act, omission or occurrence beyond the Administrator's reasonable control, irrespective of whether similar to the foregoing enumerated acts, omissions or occurrences.

(b) This Agreement may be terminated at any time upon the mutual written consent of the parties hereto, which writing shall state the effective date of termination.

(c) In the event that this Agreement is terminated under any of the provisions of Section 16.2(a), the Administrator shall select a third-party administrator to perform the services required by this Agreement. The Company shall have the right to approve any such administrator selected by the Administrator, but such approval will not unreasonably be withheld or delayed. If the Administrator fails to select an administrator pursuant to this Section 16.2(c), the Company shall select such an administrator. In either case, the Administrator shall pay all fees and charges imposed by the selected administrator and shall bear all transition costs associated with the transition of the performance of the services required under this Agreement to such administrator, including the expense of sending policyholder notices as provided in Article V.

ARTICLE XVII

DISPUTE RESOLUTION

17.1. General Provisions. (a) Any dispute, controversy or claim arising out of or relating to this Agreement or the validity, interpretation, breach or termination thereof (a "Dispute"), shall be resolved in accordance with the procedures set forth in this Article XVII, which shall be the sole and exclusive procedures for the resolution of any such Dispute unless otherwise specified below.

(b) Commencing with the request contemplated by Section 17.2, all communications between the parties or their representatives in connection with the attempted resolution of any Dispute, including any mediator's evaluation referred to in Section 17.3, shall be deemed to have been delivered in furtherance of a Dispute settlement and shall be exempt

10

---

from discovery and production, and shall not be admissible in evidence for any reason (whether as an admission or otherwise), in any arbitral or other proceeding for the resolution of the Dispute.

(c) In connection with any Dispute, the parties expressly waive and forego any right to (i) punitive, exemplary, statutorily-enhanced or similar damages in excess of compensatory damages (provided that any such liability with respect to a Third Party Claim (as defined in the Master Agreement) shall be considered direct damages), and (ii) trial by jury.

(d) The specific procedures set forth below, including but not limited to the time limits referenced therein, may be modified by agreement of the parties in writing.

(e) All applicable statutes of limitations and defenses based upon the passage of time shall be tolled while the procedures specified in this Article XVII are pending. The parties will take such action, if any, required to effectuate such tolling.

17.2. Consideration by Senior Executives. If a Dispute is not resolved in the normal course of business at the operational level, the parties shall attempt in good faith to resolve such Dispute by negotiation between executives who hold, at a minimum, the office of President and CEO of the respective business entities involved in such Dispute. Either party may initiate the executive negotiation process by providing a written notice to the other (the "Initial Notice"). Fifteen (15) days after delivery of the Initial Notice, the receiving party shall submit to the other a written response (the "Response"). The Initial Notice and the Response shall include (i) a statement of the Dispute and of each party's position, and (ii) the name and title of the executive who will represent that party and of any other person who will accompany the executive. Such executives will meet in person or by telephone within thirty (30) days of the date of the Initial Notice to seek a resolution of the Dispute.

17.3. Mediation. If a Dispute is not resolved by negotiation as provided in Section 17.2 within forty-five (45) days from the delivery of the Initial Notice, then either party may submit the Dispute for resolution by mediation pursuant to the CPR Institute for Dispute Resolution (the "CPR") Model Mediation Procedure as then in effect. The parties will select a mediator from the CPR Panels of Distinguished Neutrals, but such mediator must have prior U.S. reinsurance experience either as a lawyer or as a present or former officer or management employee of a reinsurance company, but not of the Company, or the Administrator, or any of their respective affiliates. Either party at commencement of the mediation may ask the mediator to provide an evaluation of the Dispute and the parties' relative positions.

17.4. Arbitration. (a) If a Dispute is not resolved by mediation as provided in Section 17.3 within thirty (30) days of the selection of a mediator (unless the mediator chooses to withdraw sooner), either party may submit the Dispute to be finally resolved by arbitration pursuant to the CPR Rules for Non-Administered Arbitration as then in effect (the "CPR Arbitration Rules"). The parties consent to a single, consolidated arbitration for all known Disputes existing at the time of the arbitration and for which arbitration is permitted.

(b) The neutral organization for purposes of the CPR Arbitration Rules will be the CPR. The arbitral tribunal shall be composed of three arbitrators who are each experienced in

11

---

the U.S. reinsurance business, of whom each party shall appoint one in accordance with the "screened" appointment procedure provided in Rule 5.4 of the CPR Arbitration Rules. The non-party appointed arbitrator must have prior U.S. reinsurance experience as a present or former officer or management employee of a reinsurance company, but not of the Company, or the Administrator, or any of their respective affiliates. The arbitration shall be conducted in New York City. Each party shall be permitted to present its case, witnesses and evidence, if any, in the presence of the other party. A written transcript of the proceedings shall be made and furnished to the parties. The arbitrators shall determine the Dispute in accordance with the law of Virginia, without giving effect to any conflict of law rules or other rules that might render such law inapplicable or unavailable, and shall apply this Agreement according to its terms, provided that the provisions relating to arbitration shall be governed by the Federal Arbitration Act, 9 U.S.C. §§ 1 et seq. The arbitral tribunal shall endeavor to render its award or order resulting from any arbitration within forty-five (45) days following the termination of the arbitration proceedings.

(c) The parties agree to be bound by any award or order resulting from any arbitration conducted hereunder and further agree that judgment on any award or order resulting from an arbitration conducted under this Section 17.4 may be entered and enforced in any court having jurisdiction thereof.

(d) Except as expressly permitted by this Agreement, no party will commence or voluntarily participate in any court action or proceeding concerning a Dispute, except (i) for enforcement as contemplated by Section 17.4(c) above, (ii) to restrict or vacate an arbitral decision based on the grounds specified under applicable law, or (iii) for interim relief as provided in paragraph (e) below. For purposes of the foregoing the parties hereto submit to the non-exclusive jurisdiction of the courts of the State of New York.

(e) In addition to the authority otherwise conferred on the arbitral tribunal, the tribunal shall have the authority to make such orders for interim relief, including injunctive relief, as it may deem just and equitable. Notwithstanding paragraph (d) above, each party acknowledges that in the event of any actual or threatened breach of certain of the provisions of this Agreement, the remedy at law would not be adequate, and therefore injunctive or other interim relief may be sought immediately to restrain such breach. If the tribunal shall not have been appointed, either party may seek interim relief from a court having jurisdiction if the award to which the applicant may be entitled may be rendered ineffectual without such interim relief. Upon appointment of the tribunal following any grant of interim relief by a court, the tribunal may affirm or disaffirm such relief, and the parties will seek modification or rescission of the court action as necessary to accord with the tribunal's decision.

(f) Each party will bear its own attorneys' fees and costs incurred in connection with the resolution of any Dispute in accordance with this Article XVII.

12

---

## ARTICLE XVIII

### MISCELLANEOUS PROVISIONS

18.1. Headings and Schedules. Headings used herein are not a part of this Agreement and shall not affect the terms hereof. The attached Schedules are a part of this Agreement.

18.2. Notices. All notices, requests, demands and other communications under this Agreement must be in writing and will be deemed to have been duly given or made as follows: (a) if sent by registered or certified mail in the United States return receipt requested, upon receipt; (b) if sent by reputable overnight air courier, two business days after mailing; (c) if sent by facsimile transmission, with a copy mailed on the same day in the manner provided in (a) or (b) above, when transmitted and receipt is confirmed by telephone; or (d) if otherwise actually personally delivered, when delivered, and shall be delivered as follows:

If to the Company:

Federal Home Life Insurance Company  
6620 West Broad Street  
Richmond, VA 23230  
Facsimile: (804) 662-2414  
Attention: Chief Executive Officer

With a copy to:

Federal Home Life Insurance Company  
700 Main Street  
Lynchburg, VA 24504  
Facsimile: (434) 948-5819  
Attention: General Counsel

If to the Administrator:

Union Fidelity Life Insurance Company  
200 North Martingale Road  
Schaumburg, IL 60173-2096  
Facsimile: (847) 330-3404  
Attention: Chief Financial Officer

With a copy to:

13

---

Union Fidelity Life Insurance Company  
200 North Martingale Road  
Schaumburg, IL 60173-2096  
Facsimile: (847) 605-3044  
Attention: General Counsel

or to such other address or to such other Person as either party may have last designated by notice to the other party.

18.3. Successors and Assigns. This Agreement shall be binding upon and inure to the benefit of the parties hereto and their respective successors, permitted assigns and legal representatives. Neither this Agreement, nor any right or obligation hereunder, may be assigned by any party without the prior written consent of the other party hereto. Any assignment in violation of this Section 18.3 shall be void and shall have no force and effect.

18.4. Execution in Counterpart. This Agreement may be executed by the parties hereto in any number of counterparts, and by each of the parties hereto in separate counterparts, each of which counterparts, when so executed and delivered, shall be deemed to be an original, but all such counterparts shall together constitute but one and the same instrument.

18.5. Currency. Whenever the word "Dollars" or the "\$" sign appear in this Agreement, they shall be construed to mean United States Dollars, and all transactions under this Agreement shall be in United States Dollars.

18.6. Amendments. This Agreement may not be changed, altered or modified unless the same shall be in writing executed by the Company and the Administrator.

18.7. Governing Law. This Agreement will be construed, performed and enforced in accordance with the laws of the Commonwealth of Virginia without giving effect to its principles or rules of conflict of laws thereof to the extent such principles or rules would require or permit the application of the laws of another jurisdiction.

18.8. Entire Agreement; Severability. (a) This Agreement constitutes the entire agreement between the parties hereto relating to the subject matter hereof and supersedes all prior and contemporaneous agreements, understandings, statements, representations and warranties, negotiations and discussions, whether oral or written, of the parties and there are no general or specific warranties, representations or other agreements by or among the parties in connection with the entering into of this Agreement or the subject matter hereof except as specifically set forth or contemplated herein.

(b) If any provision of this Agreement is held to be void or unenforceable, in whole or in part, (i) such holding or provision shall not affect the validity and enforceability of the remainder of this Agreement, including any other provision, paragraph or subparagraph, and (ii) the parties agree to attempt in good faith to reform such void, unenforceable or violative provision to the extent necessary to render such provision enforceable and to carry out its original intent.

14

---

18.9. No Waiver; Preservation of Remedies. No consent or waiver, express or implied, by any party to or of any breach or default by any other party in the performance by such other party of its obligations hereunder shall be deemed or construed to be a consent or waiver to or of any other breach or default in the performance of obligations hereunder by such other party hereunder. Failure on the part of any party to complain of any act or failure to act of any other party or to declare any other party in default, irrespective of how long such failure continues, shall not constitute a waiver by such first party of any of its rights hereunder. The rights and remedies provided are cumulative and are not exclusive of any rights or remedies that any party may otherwise have at law or equity.

18.10. Third Party Beneficiary. Nothing in this Agreement will confer any rights upon any Person that is not a party or a successor or permitted assignee of a party to this Agreement.

18.11. Tax Exception to Any Confidentiality. Notwithstanding anything to the contrary set forth herein or in any other agreement to which the parties hereto are parties or by which they are bound, any obligations of confidentiality contained herein and therein, as they relate to the transactions, shall not apply to the federal tax structure or federal tax treatment of the transactions, and each party hereto (and any employee, representative, or agent of any party hereto) may disclose to any and all persons, without limitation of any kind, the federal tax structure and federal tax treatment of the transactions. The preceding sentence is intended to cause the transactions to be treated as not having been offered under conditions of confidentiality for purposes of Section 1.6011-4(b)(3) (or any successor provision) of the Treasury Regulations promulgated under Section 6011 of the Internal Revenue Code of 1986, as amended, and shall be construed in a manner consistent with such purpose. In addition, each party hereto acknowledges that it has no proprietary or exclusive rights to the federal tax structure of the transactions or any federal tax matter or federal tax idea related to the transactions.

18.12. Interpretation. Wherever the words "include," "includes" or "including" are used in this Agreement, they shall be deemed to be followed by the words "without limitation."

18.13. Survival. Article XVII and Article XVIII shall survive the termination of this Agreement.

15

---

IN WITNESS WHEREOF, the Company and the Administrator have executed this Agreement as of the date first above written.

FEDERAL HOME LIFE INSURANCE  
COMPANY

By: \_\_\_\_\_  
Name:  
Title:

UNION FIDELITY LIFE INSURANCE  
COMPANY

By: \_\_\_\_\_  
Name:  
Title:

16

---

## BUSINESS ASSOCIATE ADDENDUM

### I. Purpose.

In order to disclose certain information to the party providing a service under this Agreement (“Provider”) under this Addendum, some of which may constitute Protected Health Information (defined below), the party to whom a service under this Agreement is being provided (“Recipient”) and Provider mutually agree to comply with the terms of this Addendum for the purpose of satisfying the requirements of the Health Insurance Portability and Accountability Act of 1996 (“HIPAA”) and its implementing privacy regulations at 45 C.F.R. Parts 160-164 (“HIPAA Privacy Rule”). These provisions shall apply to Provider to the extent that Provider is considered a “Business Associate” under the HIPAA Privacy Rule and all references in this section to Business Associates shall refer to Provider. Capitalized terms not otherwise defined herein shall have the meaning assigned in the Agreement. Notwithstanding anything else to the contrary in the Agreement, in the event of a conflict between this Addendum and the Agreement, the terms of this Addendum shall prevail.

### II. Permitted Uses and Disclosures.

A. Business Associate agrees to use or disclose Protected Health Information (“PHI”) that it creates for or receives from Recipient or its Subsidiaries only as follows. The capitalized term “Protected Health Information or PHI” has the meaning set forth in 45 Code of Federal Regulations Section 164.501, as amended from time to time. Generally, this term means individually identifiable health information including, without limitation, all information, data and materials, including without limitation, demographic, medical and financial information, that relates to the past, present, or future physical or mental health or condition of an individual; the provision of health care to an individual; or the past present, or future payment for the provision of health care to an individual; and that identifies the individual or with respect to which there is a reasonable basis to believe the information can be used to identify the individual. This definition shall include any demographic information concerning members and participants in, and applicants for, Recipient’s or its Subsidiaries’ health benefit plans. All other terms used in this Addendum shall have the meanings set forth in the applicable definitions under the HIPAA Privacy Rule.

B. Functions and Activities on Company’s Behalf. Business Associate is permitted to use and disclose PHI it creates for or receives from Recipient or its Subsidiaries only for the purposes described in this Addendum or the Agreement that are not inconsistent with the provisions of this Addendum, or as required by law, or following receipt of prior written approval from whichever of the Recipient or its Subsidiary for which the relevant PHI was created or from which the relevant PHI was received. In addition to these specific requirements below, Business Associate may use or disclose PHI only in a manner that would not violate the HIPAA Privacy Rule if done by the Recipient or its Subsidiaries.

C. Business Associate’s Operations. Business Associate is permitted by this Agreement to use PHI it creates for or receives from Recipient or its Subsidiaries: (i) if such use is reasonably necessary for Business Associate’s proper management and administration; and (ii) as reasonably necessary to carry out Business Associate’s legal responsibilities.

---

Business Associate is permitted to disclose PHI it creates for or receives from Recipient or its Subsidiaries for the purposes identified in this Section only if the following conditions are met:

- (1) The disclosure is required by law; or
- (2) The disclosure is reasonably necessary to Business Associate’s proper management and administration, and Business Associate obtains reasonable assurances in writing from any person or organization to which Business Associate will disclose such PHI that the person or organization will:
  - a. Hold such PHI as confidential and use or further disclose it only for the purpose for which Business Associate disclosed it to the person or organization or as required by law; and
  - b. Notify Business Associate (who will in turn promptly notify whichever of the Recipient or its Subsidiary for which the relevant PHI was created or from which the relevant PHI was received) of any instance of which the person or organization becomes aware in which the confidentiality of such PHI was breached.

D. Minimum Necessary Standard. In performing the functions and activities on Recipient’s or its Subsidiaries’ behalf pursuant to the Agreement, Business Associate agrees to use, disclose or request only the minimum necessary PHI to accomplish the purpose of the use, disclosure or request. Business Associate must have in place policies and procedures that limit the PHI disclosed to meet this minimum necessary standard.

E. Prohibition on Unauthorized Use or Disclosure. Business Associate will neither use nor disclose PHI it creates or receives for or from Recipient, its Subsidiaries, or from another business associate of Recipient or its Subsidiaries, except as permitted or required by this Addendum or the Agreement that are not inconsistent with the provisions of this Addendum, or as required by law, or following receipt of prior written approval from whichever of the Recipient or its Subsidiary for which the relevant PHI was created or from which the relevant PHI was received.

F. De-identification of Information. Business Associate agrees neither to de-identify PHI it creates for or receives from Recipient or its Subsidiaries or from another business associate of Recipient or its Subsidiaries, nor use or disclose such de-identified PHI, unless such de-identification is expressly permitted under the terms and conditions of this Addendum or the Agreement and related to Recipient’s or its Subsidiaries’ activities for purposes of “treatment”, “payment” or “health care operations”, as those terms are defined under the HIPAA Privacy Rule. De-identification of PHI, other than as expressly permitted under the terms and conditions of the Addendum for Business Associate to perform services for Recipient or its Subsidiaries, is not a permitted use of PHI under this Addendum. Business Associate further agrees that it will not create a “Limited Data Set” as defined by the HIPAA Privacy Rule using PHI it creates or receives, or receives from another business associate of Recipient or its Subsidiaries, nor use or disclose such Limited Data Set unless: (i) such creation, use or disclosure is expressly permitted under the terms and conditions of

---

this Addendum or the Agreement that are not inconsistent with the provisions of this Addendum; and such creation, use or disclosure is for services provided by Business Associate that relate to Recipient’s or its Subsidiaries’ activities for purposes of “treatment”, “payment” or “health care operations”, as those terms are defined under the HIPAA Privacy Rule.

G. Information Safeguards. Business Associate will develop, document, implement, maintain and use appropriate administrative, technical and physical safeguards to preserve the integrity and confidentiality of and to prevent non-permitted use or disclosure of PHI created for or received from Recipient or its Subsidiaries. These safeguards must be appropriate to the size and complexity of Business Associate’s operations and the nature and scope of its activities. Business Associate agrees that these safeguards will meet any applicable requirements set forth by the U.S. Department of Health and Human Services, including (as of the effective date or as of the compliance date, whichever is applicable) any requirements set forth in the final HIPAA security regulations. Business Associate agrees to mitigate, to the extent practicable, any harmful effect that is known to Business Associate resulting from a use or disclosure of PHI by Business Associate in violation of the requirements of this

III. Conducting Standard Transactions. In the course of performing services for Recipient or its Subsidiaries, to the extent that Business Associate will conduct Standard Transactions for or on behalf of Recipient or its Subsidiaries, Business Associate will comply, and will require any subcontractor or agent involved with the conduct of such Standard Transactions to comply, with each applicable requirement of 45 C.F.R. Part 162. "Standard Transaction(s)" shall mean a transaction that complies with the standards set forth at 45 C.F.R. parts 160 and 162. Further, Business Associate will not enter into, or permit its subcontractors or agents to enter into, any trading partner agreement in connection with the conduct of Standard Transactions for or on behalf of the Recipient or its Subsidiaries that:

- a. Changes the definition, data condition, or use of a data element or segment in a Standard Transaction;
- b. Adds any data element or segment to the maximum defined data set;
- c. Uses any code or data element that is marked "not used" in the Standard Transaction's implementation specification or is not in the Standard Transaction's implementation specification; or
- d. Changes the meaning or intent of the Standard Transaction's implementation specification.

IV. Sub-Contractors, Agents or Other Representatives. Business Associate will require any of its subcontractors, agents or other representatives to which Business Associate is permitted by this Addendum or the Agreement (or is otherwise given Recipient's or the relevant Subsidiary's prior written approval) to disclose any of the PHI Business Associate creates or receives for or from Recipient or its Subsidiaries, to provide reasonable assurances in writing that subcontractor

or agent will comply with the same restrictions and conditions that apply to the Business Associate under the terms and conditions of this Addendum with respect to such PHI.

V. Protected Health Information Access, Amendment and Disclosure Accounting.

A. Access. Business Associate will promptly upon Recipient's or its Subsidiary's request make available to Recipient, its Subsidiary, or, at Recipient's or such Subsidiary's direction, to the individual (or the individual's personal representative) for inspection and obtaining copies any PHI about the individual which Business Associate created for or received from Recipient or its Subsidiary and that is in Business Associate's custody or control, so that Recipient or its Subsidiary may meet its access obligations under 45 Code of Federal Regulations § 164.524.

B. Amendment. Upon Recipient's or its Subsidiary's request Business Associate will promptly amend or permit Recipient or its Subsidiary access to amend any portion of the PHI which Business Associate created for or received from Recipient or its Subsidiary, and incorporate any amendments to such PHI, so that Recipient or its Subsidiary may meet its amendment obligations under 45 Code of Federal Regulations § 164.526.

C. Disclosure Accounting. So that Recipient or its Subsidiaries may meet their disclosure accounting obligations under 45 Code of Federal Regulations § 164.528:

1. Disclosure Tracking. Business Associate will record for each disclosure, not excepted from disclosure accounting under Section V.C.2 below, that Business Associate makes to Recipient or its Subsidiaries of PHI that Business Associate creates for or receives from Recipient or its Subsidiaries, (i) the disclosure date, (ii) the name and member or other policy identification number of the person about whom the disclosure is made, (iii) the name and (if known) address of the person or entity to whom Business Associate made the disclosure, (iv) a brief description of the PHI disclosed, and (v) a brief statement of the purpose of the disclosure (items i-v, collectively, the "disclosure information"). For repetitive disclosures Business Associate makes to the same person or entity (including Recipient or its Subsidiaries) for a single purpose, Business Associate may provide a) the disclosure information for the first of these repetitive disclosures, (b) the frequency, periodicity or number of these repetitive disclosures and (c) the date of the last of these repetitive disclosures. Business Associate will make this disclosure information available to Recipient or its Subsidiaries promptly upon Recipient's or its Subsidiaries' request.

2. Exceptions from Disclosure Tracking. Business Associate need not record disclosure information or otherwise account for disclosures of PHI that this Addendum or Recipient or the relevant Subsidiary in writing permits or requires (i) for the purpose of Recipient's or its Subsidiaries' treatment activities, payment activities, or health care operations, (ii) to the individual who is the subject of the PHI disclosed or to that individual's personal representative; (iii) to persons involved in that individual's health care or payment for health care; (iv) for notification for disaster relief purposes, (v) for national security or intelligence purposes, (vi) to law enforcement officials or correctional institutions regarding inmates; or (vii) pursuant to an authorization; (viii) for disclosures

of certain PHI made as part of a Limited Data Set; (ix) for certain incidental disclosures that may occur where reasonable safeguards have been implemented; and (x) for disclosures prior to April 14, 2003.

3. Disclosure Tracking Time Periods. Business Associate must have available for Recipient and its Subsidiaries the disclosure information required by this section for the 6 years preceding Recipient's or its Subsidiaries' request for the disclosure information (except Business Associate need have no disclosure information for disclosures occurring before April 14, 2003).

VI. Additional Business Associate Provisions

A. Reporting of Breach of Privacy Obligations. Business Associate will provide written notice to whichever of the Recipient or its Subsidiary for which the relevant PHI was created or from which the relevant PHI was received of any use or disclosure of PHI that is neither permitted by this Addendum nor given prior written approval by Recipient or the relevant Subsidiary promptly after Business Associate learns of such non-permitted use or disclosure. Business Associate's report will at least:

- (i) Identify the nature of the non-permitted use or disclosure;
- (ii) Identify the PHI used or disclosed;
- (iii) Identify who made the non-permitted use or received the non-permitted disclosure;
- (iv) Identify what corrective action Business Associate took or will take to prevent further non-permitted uses or disclosures;
- (v) Identify what Business Associate did or will do to mitigate any deleterious effect of the non-permitted use or disclosure; and
- (vi) Provide such other information, including a written report, as Recipient or the relevant Subsidiary may reasonably request.

B. Amendment. Upon the effective date of any final regulation or amendment to final regulations promulgated by the U.S. Department of Health and Human Services with respect to PHI, including, but not limited to the HIPAA privacy and security regulations, this Addendum and the Agreement will automatically be amended so that the obligations they impose on Business Associate remain in compliance with these regulations.

In addition, to the extent that new state or federal law requires changes to Business Associate's obligations under this Addendum, this Addendum shall automatically be amended to include such additional obligations, upon notice by Recipient or its Subsidiaries to Business Associate of such obligations. Business Associate's continued performance of services under the Agreement shall be deemed acceptance of these additional obligations.

5

C. Audit and Review of Policies and Procedures. Business Associate agrees to provide, upon Recipient request, access to and copies of any policies and procedures developed or utilized by Business Associate regarding the protection of PHI. Business Associate agrees to provide, upon Recipient's request, access to Business Associate's internal practices, books, and records, as they relate to Business Associate's services, duties and obligations set forth in this Addendum and the Agreement(s) under which Business Associate provides services and / or products to or on behalf of Recipient or its Subsidiaries, for purposes of Recipient's or its Subsidiaries' review of such internal practices, books, and records.

6

SCHEDULE C

CEDING COMMISSION

The Ceding Commission shall be the sum of the following:

1. an amount equal to the excess of the Total SAP Ceded Reserves over Total GAAP Ceded Reserves measured as of the close of business on the day immediately preceding the Inception Date (which amount may be negative);
2. an amount equal to the unamortized PVFP intangible asset balance of the Company (excluding any related mark to market adjustments for SFAS 115 requirement) with respect to the Reinsured Contracts as measured as of the close of business on the day immediately preceding the Inception Date, determined in accordance with GAAP;
3. an amount equal to the unamortized deferred acquisition costs of the Company (excluding any related mark to market adjustments for SFAS 115 requirement) with respect to the Reinsured Contracts as measured as of the close of business on the day immediately preceding the Inception Date, determined in accordance with GAAP; and
4. an amount equal to the excess of the GAAP book value of the Assets (excluding any related mark to market adjustments for SFAS 115 requirement) over the SAP book value of the Assets measured as of the close of business on the day immediately preceding the Inception Date (which amount may be negative).

SCHEDULE D

ASSETS

Transfer Document	From	To	Nature of Transfer	Cash Map Cross-Reference	Schedule						
FHL SSA Coinsurance	FHL	UFLIC	Treaty	(82)	Schedule D						
<b>Called Securities*</b>	<b>Parent Name</b>	<b>Issuer Name</b>	<b>1Q04 Cusip</b>	<b>1Q04 Tax lot</b>	<b>12/31/03 Local Par</b>	<b>12/31/03 GAAP BV (incl attached derivative)</b>	<b>12/31/03 Accrued Interest</b>	<b>12/31/03 GAAP BV + Accrued Interest</b>	<b>12/31/03 STAT BV (incl attached derivative)</b>	<b>12/31/03 Accrued Interest</b>	<b>12/31/03 STAT BV + Accrued Interest</b>
[Individual Asset Details Omitted]											
<b>Asset Sub Total</b>						<b>537,516,636.80</b>	<b>9,378,971.69</b>	<b>546,895,608.49</b>	<b>537,622,322.28</b>	<b>9,378,971.69</b>	<b>547,001,293.97</b>
Cash									1,030,722.56		1,030,722.56
<b>Total</b>									<b>538,653,044.84</b>		<b>548,032,016.53</b>

\* These Securities will not be transferred. The "Call Amount" will be settled in cash

SCHEDULE E

EXPENSE ALLOWANCES

The "Annual Expense Reimbursement Factor" used to calculate the Expense Allowance is as follows:

Policy Maintenance Factor      \$23.84 per Policy

Such Annual Expense Reimbursement Factor will be adjusted (i) for the year beginning January 1, 2005 and, thereafter, every three (3) years during the term of this Agreement based on a triennial cost/time study prepared in accordance with the methodology set forth below (the "Triennial Study") and (ii) for the years between the Triennial Studies based on a report setting forth the Annual Expense Reimbursement Factor prepared in accordance with the methodology set forth below (the "Annual

Expense Reimbursement Factor Report”).

(a) Triennial Study. As soon as practicable (and in any event within sixty (60) days) prior to January 1, 2005 and prior to the beginning of every third calendar year thereafter during the term of this Agreement, the Company shall cause to be prepared and delivered to the Reinsurer the Triennial Study which sets forth the Annual Expense Reimbursement Factor for the next calendar year, together with all supporting data used in preparing the Triennial Study and work papers, in reasonable detail, setting forth the determination of such Annual Expense Reimbursement Factors based on such Triennial Study (such documents, together with the Triennial Study, the “Triennial Study Documents”).

(b) Annual Expense Reimbursement Factor Report. As soon as practicable (and in any event within thirty (30) days) prior to January 1, 2006 and prior to the beginning of each calendar year thereafter in which no Triennial Study is prepared, the Company shall cause to be prepared and delivered to the Reinsurer the Annual Expense Reimbursement Factor Report, together with all supporting data used in preparing the Annual Expense Reimbursement Factor Report and work papers, in reasonable detail, setting forth the determination of such Annual Expense Reimbursement Factor for the next calendar year (such documents, together with the Annual Expense Reimbursement Factor Report, the “Annual Expense Reimbursement Factor Documents”).

(c) Methodology. At the time of the Triennial Study, historical costs (to include costs directly related to maintaining and administering policies, processing claims and reporting results) will be determined for the Policy Maintenance Factor identified above. For a given Annual Expense Reimbursement Factor the identified costs will be divided by the total historical number of units of measure for both the Reinsured Contracts and the retained block of business to derive an historical cost per unit. The historical cost per unit will be used as a prospective cost per unit for the next calendar year.

For the two succeeding years in the period between the Triennial Studies the historical dollar amounts by Policy Maintenance Factor will be adjusted (rolled forward) for current year cost changes agreed to by the Reinsurer and the Company (in accordance with the procedures set forth below). This rolled forward historical cost will then be divided by the total historical

---

number of units for the current period to determine a prospective cost per unit for the next calendar year.

An additional adjustment, positive or negative, to the prospective cost per unit determined by either the Triennial Study or the two succeeding years may be negotiated between the parties. The additional adjustment is for special projected costs or benefits of productivity, process improvements, inflation, loss of scale, and any other cost variation which was not included in the prior Triennial Study or the succeeding roll forward.

The combined prospective unit cost and additional adjustment is the Annual Expense Reimbursement Factor. The Expense Allowance will be determined quarterly and billed to the Reinsurer in three equal installments during the quarter at the end of the month. Each installment will be determined by multiplying the actual number of units at the beginning of the quarter covered by this Agreement times the Annual Expense Reimbursement Factor (divided by twelve).

(d) Review of Documents. Following the delivery of the Annual Expense Reimbursement Factor Documents or the Triennial Study Documents, as applicable, the Company shall (i) provide to the Reinsurer or its designated representative copies of such additional work papers and other documents relating to its preparation of the Annual Expense Reimbursement Factor Report or Triennial Study, as applicable, as the Reinsurer or its designated representative may reasonably request, including, without limitation, claims files and practices and (ii) cooperate with, and make its personnel and facilities reasonably available to, the Reinsurer and the Reinsurer’s designated representative for the purpose of providing such other information as the Reinsurer or the Reinsurer’s designated representative may reasonably request concerning Annual Expense Reimbursement Factor Documents or the Triennial Study Documents, as applicable, and the calculation of the Annual Expense Reimbursement Factor.

(e) Notice of Disagreement. In the event that the Reinsurer has any disagreement with any of the Annual Expense Reimbursement Factor Documents or the Triennial Study Documents, as applicable, the Reinsurer shall give written notice of all such disagreements (a “Notice of Disagreement”) to the Company within thirty (30) days after the Annual Expense Reimbursement Factor Documents or the Triennial Study Documents, as applicable, are delivered to the Reinsurer. Any Notice of Disagreement shall set forth each item in disagreement and shall provide reasonable specificity as to the basis for each disagreement and shall specify the total adjustment to the Annual Expense Reimbursement Factor, as proposed by the Company as a result of such items in disagreement.

(f) Dispute Resolution. If the Reinsurer does not deliver a Notice of Disagreement to the Company within such thirty (30) day period, the Annual Expense Reimbursement Factor Documents and the Triennial Study Documents, as applicable, shall be final and binding upon the parties hereto and shall constitute the final calculation of the Annual Expense Reimbursement Factor for the next calendar year. If the Reinsurer delivers a Notice of Disagreement to the Company within such thirty (30) day period, the parties shall (and shall cause their respective designated representatives to) negotiate in good faith to resolve all disagreements as promptly as practicable. Any changes in the Annual Expense Reimbursement Factor, if any, that are agreed to by the Company and the Reinsurer within sixty (60) days of the

---

above-mentioned delivery of the Annual Expense Reimbursement Factor Documents or the Triennial Study Documents, as applicable, shall be incorporated into a final calculation of the Annual Expense Reimbursement Factor. If the parties and their respective designated representatives are unable to resolve all disagreements within sixty (60) days of delivery of the Annual Expense Reimbursement Factor Documents or the Triennial Study Documents, as applicable, then all unresolved disagreements will be submitted within ten (10) days after the end of such sixty (60) day period for resolution in accordance herewith to an independent certified public accounting firm of national standing and reputation (the “Accounting Firm”) mutually acceptable to the Company and the Reinsurer. The parties shall cooperate in good faith with the Accounting Firm and shall give the Accounting Firm access to all data and other information requested by the Accounting Firm for purposes of such resolution. The Accounting Firm shall, within thirty (30) days after its engagement, deliver to the Company and the Reinsurer a definitive calculation of the Annual Expense Reimbursement Factor, which shall be final and binding upon the parties hereto and shall be so reflected in the calculation of the Annual Expense Reimbursement Factor. The Company and the Reinsurer shall each pay one-half of the fees and expenses of the Accounting Firm.

(g) Expense Allowance Pending Resolution. In the event of a dispute with respect to any Annual Expense Reimbursement Factor for the next succeeding Calendar year, the Company and the Reinsurer agree that the Annual Expense Reimbursement Factor then in effect under this Agreement shall remain in effect pending resolution of such dispute and adjustment, if any, in accordance with the dispute resolution procedure set forth in paragraph (f) above.

---

#### SCHEDULE F - PART I

##### INITIAL REPORT

1. Total SAP Ceded Reserves Gross Policy Reserves calculated in accordance with SAP with respect to the reinsured risks.

\$

2. Ceding Commission:

A. Excess SAP Ceded Reserves over GAAP Ceded Reserves:



1) Total SAP Ceded Reserves	\$	
2) Total GAAP Ceded Reserves:		
Gross Policy Reserves calculated in accordance with GAAP with respect to the reinsured risks.	\$	
Excess SAP Reserves over GAAP Reserves (A1-A2)		\$
B. Present Value of Future Profits (PVFP)		\$
C. Deferred Acquisition Costs (DAC)		\$
D. Asset Book Value Difference - Measured as of close of business the day preceding the Inception Date		
1) Asset Book Value (GAAP basis)	\$	
2) Asset Book Value (SAP basis)	\$	
Excess Asset Book Value (D1-D2)		\$
Total Ceding Commission (A+B+C+D)		\$
3. Accrued Interest on Assets as of the day before Inception Date		\$
4. Investment Cash Flows on the Assets from the Inception Date through the Closing Date		\$
Net Due Reinsurer (1-2-3+4)		\$

SCHEDULE F - PART II

QUARTERLY REPORT

1. Benefits		\$
2. Withdrawals from Claims Settlement Account		\$
3. Expense Allowance		\$
I. Quarterly Settlement Amount (-1+2-3)		\$
Net Due to (from) Reinsurer		\$

SCHEDULE F - PART III

ANNUAL REPORT

1. Benefits		\$
2. Withdrawals from Claims Settlement Account		\$
3. Expense Allowance		\$
I. Quarterly Settlement Amount (-1+2-3)		\$
Net Due to (from) Reinsurer (I-II)		\$

SCHEDULE G

FORM OF TRUST AGREEMENT

SCHEDULE H

ELIGIBLE SECURITIES

Assets of the types for which an Illinois-domiciled life insurance company could obtain full statutory reserve credit under statutory accounting practices prescribed or permitted by the Director of Insurance of the State of Illinois.

---

COINSURANCE AGREEMENT  
between  
GENERAL ELECTRIC CAPITAL ASSURANCE COMPANY  
and  
UNION FIDELITY LIFE INSURANCE COMPANY  
Dated as of April 15, 2004

---

---

TABLE OF CONTENTS

<a href="#">ARTICLE I</a>	<a href="#">DEFINITIONS</a>
<a href="#">ARTICLE II</a>	<a href="#">COVERAGE</a>
<a href="#">ARTICLE III</a>	<a href="#">ADMINISTRATION; GENERAL PROVISIONS</a>
<a href="#">ARTICLE IV</a>	<a href="#">CLAIMS SETTLEMENT ACCOUNT; CLAIMS</a>
<a href="#">ARTICLE V</a>	<a href="#">REINSURANCE ASSET TRANSFER; CEDING COMMISSION</a>
<a href="#">ARTICLE VI</a>	<a href="#">EXPENSE ALLOWANCES</a>
<a href="#">ARTICLE VII</a>	<a href="#">ACCOUNTING AND SETTLEMENT</a>
<a href="#">ARTICLE VIII</a>	<a href="#">DURATION AND TERMINATION</a>
<a href="#">ARTICLE IX</a>	<a href="#">INSOLVENCY</a>
<a href="#">ARTICLE X</a>	<a href="#">CREDIT FOR REINSURANCE</a>
<a href="#">ARTICLE XI</a>	<a href="#">REINSURANCE SECURITY</a>
<a href="#">ARTICLE XII</a>	<a href="#">DEFERRED ACQUISITION COSTS</a>
<a href="#">ARTICLE XIII</a>	<a href="#">DISPUTE RESOLUTION</a>
<a href="#">ARTICLE XIV</a>	<a href="#">MISCELLANEOUS PROVISIONS</a>

SCHEDULES

<a href="#">SCHEDULE A</a>	<a href="#">=</a>	<a href="#">POLICY FORMS</a>
<a href="#">SCHEDULE B</a>	<a href="#">=</a>	<a href="#">FORM OF ADMINISTRATIVE SERVICES AGREEMENT</a>
<a href="#">SCHEDULE C</a>	<a href="#">=</a>	<a href="#">CEDING COMMISSION</a>
<a href="#">SCHEDULE D</a>	<a href="#">=</a>	<a href="#">ASSETS</a>
<a href="#">SCHEDULE E</a>	<a href="#">=</a>	<a href="#">EXPENSE ALLOWANCES</a>
<a href="#">SCHEDULE F - PART I</a>	<a href="#">=</a>	<a href="#">INITIAL REPORT</a>
<a href="#">SCHEDULE F - PART II</a>	<a href="#">=</a>	<a href="#">QUARTERLY REPORT</a>
<a href="#">SCHEDULE F - PART III</a>	<a href="#">=</a>	<a href="#">ANNUAL REPORT</a>
<a href="#">SCHEDULE G</a>	<a href="#">=</a>	<a href="#">FORM OF TRUST AGREEMENT</a>
<a href="#">SCHEDULE H</a>	<a href="#">=</a>	<a href="#">ELIGIBLE SECURITIES</a>

## COINSURANCE AGREEMENT

This Coinsurance Agreement, dated as of April 15, 2004 (this "Agreement"), is made and entered into by and between General Electric Capital Assurance Company, an insurance company organized under the laws of the State of Delaware (the "Company"), and Union Fidelity Life Insurance Company, an insurance company organized under the laws of the State of Illinois (the "Reinsurer"). Defined terms used herein are defined below.

The Company and the Reinsurer mutually agree to reinsure the risks described in this Agreement under the terms and conditions stated herein. This Agreement is an indemnity coinsurance agreement solely between the Company and the Reinsurer, and the performance of the obligations of each party under this Agreement shall be rendered solely to the other party. In no instance shall anyone other than the Company or the Reinsurer have any rights under this Agreement. The Company shall be and shall remain the only party hereunder that is liable to any insured, contract holder, policyholder, claimant or beneficiary under any insurance policy or contract reinsured hereunder.

This Agreement is entered into in connection with an intercompany reorganization among the Company, the Reinsurer and certain of their Affiliates.

### ARTICLE I

#### DEFINITIONS

1.1. Definitions. As used in this Agreement, the following terms shall have the following meanings (definitions are applicable to both the singular and the plural forms of each term defined in this Article):

"Accounting Period" means calendar quarter, except that the last Accounting Period shall be the period commencing with the first day of the calendar quarter in which the Termination Date falls and ending with the Termination Date.

"Affiliate" means any other Person that directly or indirectly controls, is controlled by, or is under common control with, the first Person. "Control" (including the terms, "controlled by" and "under common control with") means the possession, directly or indirectly, of the power to direct or cause the direction of the management and policies of a Person, whether through the ownership of voting securities, by contract or credit arrangement, as trustee or executor, or otherwise.

"Agreement" shall have the meaning specified in the first paragraph of this Agreement.

"Annual Report" shall have the meaning specified in Section 7.4.

"Applicable Law" means any federal, state, local or foreign law (including common law), statute, ordinance, rule, regulation, order, writ, injunction, judgment, permit, governmental agreement or decree applicable to a Person or any of such Person's subsidiaries,

---

properties, assets, or to such Person's officers, directors, managing directors, employees or agents in their capacity as such.

"Assets" shall have the meaning specified in Section 5.3(a).

"Assignment Letter Agreement" means the letter agreement dated the date hereof among General Electric Capital Corporation, a Delaware corporation, the Reinsurer, the Company and certain affiliates of the Company relating to the assignment by General Electric Capital Corporation of the Capital Maintenance Agreement.

"Benefits" shall have the meaning specified in Section 2.3(a).

"Business Day" means any day other than a Saturday, Sunday or other day on which commercial banks in the States of Illinois or Virginia are required or authorized by law to be closed.

"Capital Maintenance Agreement" means the Capital Maintenance Agreement between General Electric Capital Corporation, a Delaware corporation, and the Reinsurer.

"Ceding Commission" shall have the meaning specified in Section 5.2.

"Claims Settlement Account" shall have the meaning specified in Section 4.1(a).

"Closing Date" means April 15, 2004.

"Code" means the Internal Revenue Code of 1986, as amended.

"Company Account" shall have the meaning specified in Section 11.1(e).

"CPR" shall have the meaning specified in Section 13.3.

"CPR Arbitration Rules" shall have the meaning specified in Section 13.4(a).

"Dispute" shall have the meaning specified in Section 13.1(a).

"Eligible Securities" shall have the meaning specified in Section 11.1(c).

"Expense Allowance" shall have the meaning specified in Section 6.1.

"Extra Contractual Liabilities" means all liabilities for damages (including compensatory, consequential, exemplary, punitive, bad faith or similar or other damages) which relate to the marketing, sale, underwriting, issuance, delivery, cancellation or administration of the Reinsured Contracts, including liability arising out of or

relating to any alleged or actual acts, errors or omissions by the Company or its agents, whether intentional or otherwise, with respect to any of the Reinsured Contracts, including (A) any alleged or actual reckless conduct or bad faith in connection with the handling of any claim arising out of or under Reinsured Contracts, or (B) the marketing, sale, underwriting, issuance, delivery, cancellation or administration of any of the Reinsured Contracts.

“Force Majeure” shall have the meaning specified in Section 3.7(b)(iii).

“Funding Requirement” shall have the meaning specified in Section 11.1(e).

“GAAP” means U.S. generally accepted accounting principles consistently applied.

“Governmental Authority” means any foreign or national government, any state or other political subdivision thereof, and any entity exercising executive, legislative, judicial, regulatory or administrative functions of or pertaining to government.

“Inception Date” shall have the meaning specified in Section 2.1.

“Initial Notice” shall have the meaning specified in Section 13.2.

“Initial Reinsurance Premium” shall have the meaning specified in Section 5.1.

“Initial Report” shall have the meaning specified in Section 7.1.

“Insolvency Fund” means any guarantee fund, insolvency fund, plan, pool, association, fund or other arrangement, however denominated, established or governed, which provides for any assessment of or payment or assumption by the Company of part or all of any claim, debt, charge, fee or other obligation of an insurer or reinsurer, or its successors or assigns, which has been declared by any competent authority to be insolvent, or which is otherwise deemed unable to meet any claim, debt, charge, fee or other obligation in whole or in part.

“Minimum Claims Settlement Amount” shall have the meaning specified in Section 4.1(b).

“Person” means any natural person, firm, limited liability company, general partnership, limited partnership, joint venture, association, corporation, trust, Governmental Authority or other entity.

“Quarterly Report” shall have the meaning specified in Section 7.2.

“Quarterly Settlement” shall have the meaning specified in Section 5.3(a).

“RBC Reporting Letter Agreement” means the letter agreement dated the date hereof among the Company, the Reinsurer and certain affiliates of the Company relating to the Reinsurer’s requirement to provide periodic certifications and reports regarding the Reinsurer’s risk based capital ratio.

“Reinsured Contracts” means the structured settlements immediate annuity contracts issued by the Company and recorded in the Company’s valuation system on or prior to December 3, 2003 or reinsured by the Company under reinsurance agreements in effect prior to January 1, 2004, and, in each case, written on the policy forms described in Schedule A.

“Reinsured Risks” shall have the meaning specified in Section 2.1.

“Response” shall have the meaning specified in Section 13.2.

“SAP” means statutory accounting practices prescribed or permitted by the Insurance Department of the State of Delaware.

“Tax DAC” means specified policy acquisition expenses capitalized and amortized under section 848 of the Code.

“Termination Date” means the effective date of any termination of this Agreement as provided in Article VIII.

“Termination Letter Agreement” means the letter agreement dated the date hereof among the Company, the Reinsurer and certain affiliates of the Company relating to the rescission of this Agreement upon the failure of certain events to occur after the date hereof.

“Total SAP Ceded Reserves” means, as of any given date, the gross policy reserves of the Company calculated in accordance with SAP with respect to the Reinsured Risks.

“Total GAAP Ceded Reserves” means, as of any given date, the gross policy reserves of the Company calculated in accordance with GAAP with respect to the Reinsured Risks.

“Trust Account” shall have the meaning set forth in Section 11.1(a).

“Trust Agreement” shall have the meaning set forth in Section 11.1(a).

“Trustee” shall have the meaning set forth in Section 11.1(a).

ARTICLE II

COVERAGE

2.1. Coverage. Upon the terms and subject to the conditions and other provisions of this Agreement, as of 12:01 a.m. Eastern Time on January 1, 2004 (the "Inception Date"), the Company hereby cedes to the Reinsurer, and the Reinsurer hereby agrees to indemnify the Company for, one hundred percent (100%) of the liability incurred by the Company for Benefits on or after the Inception Date (the "Reinsured Risks").

2.2. Conditions. (a) If the Company's liability under any of the Reinsured Contracts is changed because of changes made on or after the Inception Date in the terms and conditions of the Reinsured Contracts (including to any contract riders or endorsements thereto) that are required due to changes in Applicable Law, the Reinsurer will share in the change proportionately to the coinsurance share hereunder and the Company and the Reinsurer will make all appropriate adjustments to amounts due each other under this Agreement.

(b) Except as otherwise set forth in paragraph (a) above, no changes, amendments or modifications made on or after the Inception Date in the terms and conditions of the

4

---

Reinsured Contracts which adversely affect the liability of the Reinsurer hereunder shall be covered hereunder without the prior written approval of such changes, amendments or modifications by the Reinsurer, which approval shall not be unreasonably withheld or delayed. In the event that any such changes, amendments or modifications are made in any Reinsured Contract without the prior written approval of the Reinsurer, this Agreement will cover liability incurred by the Company for Benefits as if the non-approved changes, amendments or modifications had not been made.

2.3. Benefits. (a) Subject to the provisions of Sections 2.2, 2.3(b) and (c) and the terms and conditions of this Agreement, "Benefits" shall mean the actual benefits payable by the Company under the Reinsured Contracts.

(b) Any Extra Contractual Liabilities resulting from actions of the Company or its agents or reinsured by the Company under the Reinsured Contracts shall be treated as a Benefit payable for the purposes of this Agreement to the extent permitted by state law, except to the extent that any such Extra Contractual Liabilities are attributable to the conduct of the Company in the administration of the Reinsured Contracts on or after the Inception Date, other than actions taken by the Company at the written request or direction of the Reinsurer.

(c) This Agreement excludes all liability arising by contract, operation of law, or otherwise from the Company's participation or membership, whether voluntary or involuntary, in any Insolvency Fund.

2.4. Territory. The territorial limits of this Agreement shall be identical with those of the Reinsured Contracts.

2.5. Ceded Reinsurance. Subsequent to the Inception Date, the Company will not enter into any reinsurance arrangements with respect to the Reinsured Contracts without the prior written consent of the Reinsurer, in its sole discretion.

ARTICLE III

ADMINISTRATION; GENERAL PROVISIONS

3.1. Contract Administration. (a) Subject to Section 3.7, the Company shall provide policyholder and claims servicing with respect to the Reinsured Contracts in accordance with the terms hereof. All Benefits paid by the Company shall be binding upon the Reinsurer; provided, however, that such Benefits are within the terms, conditions and limitations of the Reinsured Contracts. The Company shall provide policyholder and claims servicing with respect to the Reinsured Contracts (including the administration of claims for Benefits thereunder) in good faith and with the care, skill, prudence and diligence of a person experienced in administering structured settlement business. The Company shall provide policyholder and claims servicing with respect to the Reinsured Contracts, (i) in accordance with the terms of the Reinsured Contracts, (ii) in accordance with the applicable terms of this Agreement, (iii) in compliance with Applicable Law and, subject to the foregoing, (iv) in the same manner as it conducts its own business not subject to this Agreement and (v) in accordance with the Company's administrative performance standards in effect on the date hereof, with such revisions

5

---

to such standards as are no less favorable to the Reinsurer than such standards. Notwithstanding the foregoing, the parties may, from time to time, mutually develop specific and/or different standards for providing such services with respect to the Reinsured Contracts.

(b) The Company may subcontract for the performance of any policyholder or claims servicing service or services with respect to the Reinsured Contracts to (i) an Affiliate or (ii) any other Person with the prior written consent of the Reinsurer, such consent not to be unreasonably withheld; provided, that the Company also subcontracts for such service or services for its own structured settlement annuities business not subject to this Agreement to such subcontractor; and provided, further, that no such subcontracting shall relieve the Company from any of its obligations or liabilities hereunder, and the Company shall remain responsible for all obligations or liabilities of such subcontractor with regards to the providing of such service or services as if provided by the Company.

3.2. Claims Settlements. The Company agrees that it will provide prompt notice to the Reinsurer of its intention to contest, compromise or litigate a claim with respect to a Reinsured Contract, along with copies of all pleadings and reports of investigation with respect thereto. The Reinsurer shall have the right, at its own expense, to participate jointly with the Company in the investigation, adjustment or defense of such claims. In addition, in the event that litigation arises against the Company in connection with a claim which seeks damages in excess of \$1 million or other remedies deemed material to the Reinsurer, the Reinsurer may, upon written notice to the Company, assume the defense thereof with counsel selected by the Reinsurer and reasonably satisfactory to the Company. If the Reinsurer assumes such defense, the Company shall have the right, at its own expense, to participate jointly with the Reinsurer in the defense thereof. If the Reinsurer assumes the defense of litigation, the Reinsurer shall not settle such litigation without the Company's prior written consent (which consent shall not be unreasonably withheld or delayed) unless (i) there is no finding or admission of any violation of law or any violation of the rights of any Person, (ii) such settlement would not reasonably be expected to have material adverse precedential consequences to the Company and (iii) the sole relief provided is monetary damages that are paid in full by the Reinsurer.

3.3. Inspection. The Company shall keep accurate and complete records, files and accounts of all transactions and matters with respect to the

Reinsured Contracts and the administration hereof in accordance with Applicable Law and its record management practices in effect from time to time for the Company's insurance business not covered by this Agreement. The Reinsurer and its designated representatives may upon reasonable notice inspect, at the offices of the Company where such records are located, the papers and any and all other books or documents of the Company reasonably relating to this Agreement, including the Reinsured Contracts and the administration thereof by the Company (including compliance with the provisions of Section 3.1), and shall have access to appropriate employees and representatives of the Company, in each case during normal business hours for such period as this Agreement is in effect or for as long thereafter as the Company seeks performance by the Reinsurer pursuant to the terms of this Agreement or the Reinsurer reasonably needs access to such records for regulatory, tax or similar purposes. The information obtained shall be used only for purposes relating to the transactions contemplated under this Agreement.

6

3.4. Errors and Omissions. If any delay, omission, error or failure to pay amounts due or to perform any other act required by this Agreement is unintentional and caused by misunderstanding or oversight, the Company and the Reinsurer will adjust the situation to what it would have been had the misunderstanding or oversight not occurred. The party first discovering such misunderstanding or oversight, or an act resulting from such misunderstanding or oversight, will notify the other party in writing promptly upon discovery thereof, and the parties shall act to correct such misunderstanding or oversight within twenty (20) Business Days of such other party's receipt of such notice. However, this Section shall not be construed as a waiver by either party of its right to enforce strictly the terms of this Agreement.

3.5. Age, Sex and Other Adjustments. If the Company's liability under any of the Reinsured Contracts is changed because of a misstatement of age or sex or any other material fact, the Reinsurer will share in the change proportionately to the coinsurance share hereunder and the Company and the Reinsurer will make all appropriate adjustments to amounts due each other under this Agreement.

3.6. Setoff. Any debts or credits, matured or unmatured, in favor of or against either the Company or the Reinsurer with respect to this Agreement or any other reinsurance agreement between the Company and the Reinsurer, are deemed mutual debts or credits, as the case may be, and shall be setoff from any amounts due to the Company or the Reinsurer hereunder, as the case may be, and only the net balance shall be allowed or paid.

3.7. Administration by Reinsurer. (a) At any time from and after the fifteenth (15th) anniversary of the Inception Date, the Reinsurer shall have the right to assume from the Company the administration of the Reinsured Contracts, provided that the Reinsurer provides twelve (12) months prior written notice of such assumption, which notice may be given as early as the fourteenth (14th) anniversary of the Inception Date to take effect as of the fifteenth (15th) anniversary of the Inception Date. The Reinsurer shall bear all transition costs associated with an assumption of the administration of the Reinsured Contracts pursuant to this paragraph (a) of this Section 3.7.

(b) In addition to the provisions of Section 3.7(a), the Reinsurer shall have the right, upon written notice to the Company to assume from the Company the administration of the Reinsured Contracts upon the occurrence of any of the following events:

- (i) A voluntary or involuntary proceeding is commenced in any jurisdiction by or against the Company for the purpose of conserving, rehabilitating or liquidating the Company;
- (ii) There is a material breach by the Company of any material term or condition of this Article III that is not cured by the Company within thirty (30) days after receipt of written notice from the Reinsurer of such breach or act (provided that the Reinsurer shall not have the right to assume such administration (A) for so long as the Company is making a good faith effort to cure such a breach, not to exceed an additional one hundred eighty (180) days or (B) during the pendency of any dispute resolution

7

proceedings as set forth in Article XIII regarding an alleged material breach); or

- (iii) The Company is unable to perform the services required under this Article III for a period of thirty (30) consecutive days for any reason, other than as a result of a Force Majeure, it being understood that nothing in this Section 3.7(b)(iii) shall relieve the Company from its administrative responsibilities under this Agreement. For purposes of this Agreement "Force Majeure" means any acts or omissions of any civil or military authority, acts of God, acts or omissions of the Reinsurer, fires, strikes or other labor disturbances, equipment failures, fluctuations or non-availability of electrical power, heat, light, air conditioning or telecommunications equipment, or any other act, omission or occurrence beyond the Company's reasonable control, irrespective of whether similar to the foregoing enumerated acts, omissions or occurrences.

(c) The Company shall bear all transition costs associated with an assumption of the administration of the Reinsured Contracts pursuant to Section 3.7(b).

(d) In the event of the Reinsurer's assumption of the administration of the Reinsured Contracts, the Reinsurer and the Company shall enter into an administrative services agreement in the form attached hereto as Schedule B and the provisions of Article VI and Article VII shall become inoperative.

#### ARTICLE IV

##### CLAIMS SETTLEMENT ACCOUNT; CLAIMS

4.1. Claims Settlement Account. (a) On the Closing Date, the Reinsurer shall establish a separate bank account (the "Claims Settlement Account") in its own name for the payment of Benefits and shall authorize two signatories who shall be representatives of the Company and approved by the Reinsurer in writing to issue drafts in the name of the Reinsurer and showing the identity of the Company. The Reinsurer shall fund such account for payment of Benefits in accordance with the provisions of Section 4.1(b). Any interest earned on the Claims Settlement Account shall belong to the Reinsurer. The Claims Settlement Account shall be administered by the Company in a fiduciary capacity and shall be used solely by the Company to make payments of Benefits in accordance with the terms of this Agreement.

(b) The Reinsurer shall deposit \$26 million in the Claims Settlement Account on the Closing Date and shall thereafter fund the Claims Settlement Account on or before the fifth (5th) day of each month in amounts agreed by the Company and the Reinsurer from time to time in amounts sufficient to provide funds to the Company for the payment of Benefits during the next thirty (30) days, or such other amount as may be mutually agreed by the parties (such initial deposit amount and each minimum funding amount as agreed from time to time shall be referred to as a "Minimum Claims Settlement Amount"). In addition, the Reinsurer shall deposit to the Claims

---

the balance of such account above zero at all times. In consideration of the Reinsurer providing the Claims Settlement Account arrangement, the Company agrees that it shall apply funds in the Claims Settlement Account against the Reinsurer's liability under this Agreement until such funds are exhausted.

(c) The Company shall keep true and complete records, in accordance with Applicable Law and its record management practices in effect from time to time for the Company's insurance business not covered by this Agreement, clearly recording the deposits in and withdrawals from the Claims Settlement Account, including records relating to the payment of Benefits from the Claim Settlement Account. The Company will make available to the Reinsurer or its designated representative, or shall furnish to the Reinsurer or its designated representative, upon request of the Reinsurer or its designated representative, copies of all such records. All copies furnished in the ordinary course of business shall be furnished by the Company at the Company's cost, which shall be included in the Expense Allowance. Any extraordinary costs reasonably incurred by the Company in response to requests from the Reinsurer shall be reimbursed by the Reinsurer.

(d) Within thirty (30) days after each calendar month (or more frequently as mutually agreed by the parties), the Company shall render a complete accounting to the Reinsurer detailing all transactions with respect to the Claims Settlement Account, in such form as agreed by the parties.

(e) The parties agree to deliver to the depository bank such depository resolutions, signature cards and other documents as may be requested of them in order to use such accounts at the depository bank in accordance with the provisions of this Article IV.

(f) Upon a termination of this Agreement pursuant to Article VIII, the Reinsurer shall close the Claims Settlement Account and any closing balance therein shall be the property of the Reinsurer. The Company's claims payment authority under this Agreement with respect to the Claims Settlement Account shall terminate immediately upon termination of this Agreement pursuant to Article VIII or the assumption by the Reinsurer of the administration of the Reinsured Contracts pursuant to Section 3.7. Upon termination of its authority to pay claims, the Company shall promptly return to the Reinsurer all unused check stock held by it in connection with this Agreement.

## ARTICLE V

### REINSURANCE ASSET TRANSFER; CEDING COMMISSION

5.1. Initial Reinsurance Premium. As consideration for the reinsurance by the Reinsurer of the Reinsured Risks under this Agreement, on the Closing Date the Reinsurer shall be entitled to an amount equal to one hundred percent (100%) of the Total SAP Ceded Reserves as of the close of business on the day immediately preceding the Inception Date (the "Initial Reinsurance Premium").

---

5.2. Ceding Commission. On the Closing Date, the Company shall be entitled to a ceding commission (the "Ceding Commission") in an amount determined in accordance with Schedule C.

5.3. Amounts Due the Parties. (a) Except as otherwise specifically provided herein, all amounts due to be paid to the Company under this Agreement shall be determined on a net basis, giving full effect to Section 3.6. The net amount due the Reinsurer from the Company on the Closing Date under Section 5.1 and Section 5.2 shall consist of (i) the investment assets (the "Assets") set forth on Schedule D, which assets have a statutory book value as of the close of business on the day immediately preceding the Inception Date equal to (A) the Initial Reinsurance Premium, less (B) the Ceding Commission, less (C) an amount equal to accrued but unpaid interest on the Assets as of the close of business on the day immediately preceding the Inception Date, plus (ii) an amount equal to the investment cash flows received on the Assets between the Inception Date and the Closing Date. The Company shall pay such net amount concurrent with its delivery of the Initial Report. Each net amount subsequently due with respect to each Accounting Period ending after the Inception Date (the "Quarterly Settlement") shall be paid in cash by the Reinsurer to the Company no later than thirty (30) days after delivery of the Quarterly Report, as applicable. Each net amount subsequently due with respect to each calendar year ending after the Inception Date as reflected on an Annual Report shall be paid in cash by the Reinsurer to the Company no later than thirty (30) days after delivery of the Annual Report.

(b) The Company shall deliver to the Reinsurer possession of the Assets and such bills of sale, endorsements, assignments and other good and sufficient instruments of conveyance and transfer in form and substance reasonably acceptable to the parties as shall be effective to vest in the Reinsurer all of the right, title and interest of the Company in and to the Assets. Delivery of the Assets shall be a condition precedent of reinsurance coverage hereunder.

## ARTICLE VI

### EXPENSE ALLOWANCES

6.1. Expense Allowance. As reimbursement for expenses incurred by the Company in the providing of policyholder and Benefit payment services with respect to the Reinsured Contracts, the Reinsurer shall pay to the Company with respect to each calendar month ending after the Inception Date, an expense allowance (each an "Expense Allowance") in an amount calculated in accordance with Schedule E, as subsequently adjusted in accordance with the methodology and procedures set forth on Schedule E.

## ARTICLE VII

### ACCOUNTING AND SETTLEMENT

7.1. Initial Report. A report shall be provided by the Company to the Reinsurer on the Closing Date providing the data required in Schedule F - Part I (the "Initial Report").

7.2. Quarterly Settlement Reports. As soon as practicable but not more than forty (40) days following each Accounting Period ending after the Closing Date (or more frequently as mutually agreed by the parties), the Company shall supply the Reinsurer with a report that shall provide the financial data for such Accounting Period required in Schedule F - Part II (the "Quarterly Report"). For the avoidance of doubt, the first Quarterly Report will include all transactions with respect to the Reinsured Contracts occurring from the Inception Date through June 30, 2004.

7.3. Quarterly Financial Reports. As soon as practicable but not more than forty (40) days following the end of each Accounting Period ending after the Closing Date (or more frequently as mutually agreed by the parties), the Company shall supply the Reinsurer with reports related to the Reinsured Contracts as may be reasonably requested for use in connection with the preparation of the Reinsurer's SAP financial statements or other reports prepared by the Reinsurer in compliance with its internal reporting requirements. The parties shall cooperate in good faith to establish the form for the providing of such reports.

7.4. Annual Reports. Within forty-five (45) days after the end of each calendar year during the term of this Agreement (or more frequently as mutually agreed by the parties), the Company shall supply the Reinsurer with a report that shall provide the financial data for such year required in Schedule F - Part III (the "Annual Report").

7.5. Additional Reports and Updates. For so long as this Agreement remains in effect, each of the parties shall periodically furnish to the other such other reports and information as may be reasonably requested by such other party for regulatory, tax or similar purposes and reasonably available to it.

7.6. Delayed Payments. In the event that all or any portion of any payment due either party pursuant to this Agreement becomes overdue, the portion of the amount overdue shall bear interest at an annual rate equal to the then current thirty (30) day U.S. Treasury Bill discount rate on the date that the payment becomes overdue plus 200 basis points, for the period that the amount is overdue.

## ARTICLE VIII

### DURATION AND TERMINATION

8.1. Duration. Except as otherwise provided herein, this Agreement shall be unlimited in duration.

11

---

8.2. Reinsurer's Liability. The Reinsurer's liability with respect to the Reinsured Risks will terminate on the earliest of: (i) the date the Company's liability with respect to the Reinsured Risks is terminated and all amounts due the Company from the Reinsurer with respect to such Reinsured Risks are paid to the Company by or on behalf of the Reinsurer; and (ii) the date this Agreement is terminated upon the written agreement of the parties.

8.3. Notice of Termination. Upon the termination of the Reinsurer's liability with respect to the Reinsured Risks referred to in Section 8.2 above, the parties shall mutually give the Trustee written notice of their intention to terminate the Trust Account.

## ARTICLE IX

### INSOLVENCY

9.1. Payments. In the event of the insolvency of the Company, the reinsurance payable by the Reinsurer hereunder shall be payable directly to the Company or to its domiciliary liquidator or receiver on the basis of the liability of the Reinsurer under the contract or contracts reinsured, without diminution because of the insolvency of the Company. It is agreed and understood, however, that (i) in the event of the insolvency of the Company, the Reinsurer shall be given written notice of the pendency of a claim against the insolvent Company on a Reinsured Contract within a reasonable time after such claim is filed in the insolvency proceeding and (ii) during the pendency of such claim the Reinsurer may investigate such claim and interpose, at its own expense, in the proceeding where such claim is to be adjudicated any defenses which it may deem available to the Company or its domiciliary liquidator, receiver or statutory successor.

9.2. Expenses. It is further understood that any expense thus incurred by the Reinsurer pursuant to Section 9.1 shall be chargeable, subject to court approval, against the insolvent Company as part of the expense of liquidation to the extent of a proportionate share of the benefit which may accrue to the Company solely as a result of the defense undertaken by the Reinsurer. Where two or more assuming reinsurers are involved in the same claim and a majority in interest elect to interpose defenses to such claim, the expense shall be apportioned in accordance with the terms of this Agreement as though such expense had been incurred by the Company.

## ARTICLE X

### CREDIT FOR REINSURANCE

10.1. Reinsurance Credit. Notwithstanding any other provision of this Agreement to the contrary, if the Reinsurer becomes unauthorized or otherwise unaccredited as an insurer or reinsurer in any U.S. jurisdiction to which the Company must provide statutory statements of financial condition such that the Company will not obtain full statutory financial statement credit for reinsurance in such state for the reinsurance provided under this Agreement, the Reinsurer, upon the request of the Company, will establish, at the Reinsurer's sole cost and



option, trust accounts for the benefit of the Company, letters of credit, or other acceptable alternatives necessary to permit the Company to obtain such full statutory financial statement credit for such reinsurance in all applicable jurisdictions. The Company shall cooperate with the Reinsurer to take such steps. In addition, in such event, the Reinsurer agrees to amend this Agreement and the Trust Agreement to the extent required under Applicable Law in order to provide the Company with such full statutory financial statement credit.

## ARTICLE XI

### REINSURANCE SECURITY

11.1. Trust. (a) On the Closing Date, the Reinsurer shall enter into a trust agreement in the form attached as Schedule G (the "Trust Agreement") and establish a trust account (the "Trust Account") for the benefit of the Company with respect to the Reinsured Risks with a bank (the "Trustee") designated as a Qualified United States Financial Institution by the Securities Valuation Office of the National Association of Insurance Commissioners or any successor organization or regulatory agency having similar duties.

(b) The Reinsurer agrees to deposit, and maintain in the Trust Account with respect to this Agreement, assets to be held in trust by the Trustee for the benefit of the Company as security for the payment of the Reinsurer's obligations to the Company under this Agreement.

(c) The parties agree that the assets so deposited with respect to this Agreement shall be valued according to their current statutory book value on the books of the Reinsurer and shall consist only of cash (United States legal tender), certificates of deposit (issued by a United States bank and payable in United States legal tender), and other assets of the type specified on Schedule H attached hereto ("Eligible Securities").

(d) The Reinsurer, prior to depositing assets with the Trustee, shall execute all assignments and endorsements in blank, or transfer legal title to the Trustee of all shares, obligations or any other assets requiring assignments, in order that, to the extent practicable, the Company, or the Trustee upon direction of the Company, may whenever necessary negotiate any such assets without consent or signature from the Reinsurer or any other entity. The Company recognizes that certain assets in the Trust Account will not be readily negotiable and that certain notices, opinions of counsel, representations and/or consents will be required for the Company to obtain good and marketable title to such assets.

(e) The Reinsurer and the Company agree that the assets in the Trust Account with respect to this Agreement may be withdrawn for the following purposes only:

- (i) to pay or reimburse the Company for any amount due the Company pursuant to this Agreement to the extent not so paid or reimbursed by the Reinsurer;
- (ii) to pay to the Reinsurer, in accordance with paragraph (h) below, any amounts held in the Trust Account that exceed an amount (the "Funding

Requirement") equal to the sum of Total SAP Ceded Reserves and any additional reserves attributable to the Reinsured Risks that arise as a result of regulatory asset adequacy analysis requirements of the Reinsurer, less, prior to the date on which the Claims Settlement Account is closed, the Minimum Claims Settlement Amount then in effect; and

- (iii) in the event that General Electric Capital Corporation breaches its obligations under the Capital Maintenance Agreement, to fund an account with the Company (the "Company Account") in an amount at least equal to the deduction, for reinsurance ceded, from the Company's liabilities ceded under this Agreement. Such amount shall include, but not be limited to, amounts for policy reserves, reserves for claims and losses incurred (including losses incurred but not reported), loss and loss adjustment expenses, and unearned premiums.

(f) In the event that the Company withdraws assets from the Trust Account for the purposes set forth in Section 11.1(e)(i) above in excess of actual amounts required to meet the Reinsurer's obligations to the Company, the Company will promptly return such excess to the Reinsurer, plus interest at an annual rate equal to the then current thirty (30) day U.S. Treasury Bill discount rate on the date of withdrawal plus 200 basis points for the period during which the amounts were held pursuant to Section 11.1(e)(i). In the event that the Company withdraws assets from the Trust Account for the purposes set forth in Section 11.1(e)(iii) above, (i) the Reinsurer shall be relieved of its obligation to maintain assets in the Trust Account pursuant to this Section 11.1 to the extent of the amount of funds held in the Company Account and (ii) the Company shall first apply the funds in the Company Account in satisfaction of the Reinsurer's liability under this Agreement until the funds in the Company Account are exhausted. In the event that the Company withdraws assets from the Trust Account for the purposes set forth in Section 11.1(e)(iii) above, promptly following the date the Reinsurer's liability with respect to the Reinsured Risks is terminated, the Company shall return to the Reinsurer any assets so withdrawn that, together with any and all interest, dividends and other earnings thereon from the date of withdrawal to the date of return, are in excess of actual amounts required to meet the Reinsurer's obligations to the Company under this Agreement.

(g) The initial deposit to the Trust Account with respect to this Agreement shall be made on the Closing Date and shall consist of assets with a statutory book value equal to the Total SAP Ceded Reserves as of the close of business on the day immediately preceding the Inception Date, less an amount of assets with a statutory book value equal to the initial Minimum Claims Settlement Amount.

(h) The aggregate statutory book value of the assets held in the Trust Account with respect to this Agreement, shall at all times be at least equal to the Funding Requirement, and shall be adjusted on a quarterly basis so as to equal the Funding Requirement. On a quarterly basis, the Company shall promptly prepare and deliver to the Reinsurer a specific statement of the Funding Requirement and the Reinsurer shall promptly prepare and deliver to the Company a specific statement of the statutory book value of the assets in the Trust Account, in each case as of the end of the quarter. If the statement shows that the Funding Requirement exceeds 100% of the balance of the Trust Account with respect to this Agreement as of the statement date, the Reinsurer shall, within ten (10) Business Days after receipt of such notice of excess, secure delivery to the Trustee of additional cash or Eligible Securities having a current statutory book value equal to such difference. If the statement shows that the Funding Requirement is less than 100% of the balance of the Trust Account with respect to this Agreement as of the

statement date, the Company shall, within ten (10) Business Days after delivery of such statement to the Reinsurer, deliver a notice of withdrawal to the Trustee directing the Trustee to withdraw from the Trust Account and deliver to the Reinsurer assets from the Trust Account having a current statutory book value equal to such excess amount. In addition to the foregoing, the Reinsurer shall prepare and deliver to the Company on a quarterly basis a specific statement of the market value of the assets in the Trust Account as of the end of the quarter.

## ARTICLE XI

### DEFERRED ACQUISITION COSTS

12.1. Tax DAC Information Sharing. To ensure consistency in their respective Tax DAC calculations for tax purposes, the Company and the Reinsurer will exchange information pertaining to the amount of net consideration under this Agreement each year. The Company will submit a schedule to the Reinsurer by February 28 of each year presenting its calculation of the net consideration for the preceding taxable year. The Reinsurer may contest the calculation by providing to the Company an alternative calculation in writing within thirty (30) days of receipt of the Company's schedule. The Company and the Reinsurer will act in good faith to resolve any differences in the schedule of calculations within thirty (30) days of receipt of the alternative calculation to ensure consistent amounts are reported on the respective tax returns for the preceding tax year.

## ARTICLE XIII

### DISPUTE RESOLUTION

13.1. General Provisions. (a) Any dispute, controversy or claim arising out of or relating to this Agreement or the validity, interpretation, breach or termination thereof (a "Dispute"), shall be resolved in accordance with the procedures set forth in this Article XIII, which shall be the sole and exclusive procedures for the resolution of any such Dispute unless otherwise specified below.

(b) Commencing with the request contemplated by Section 13.2, all communications between the parties or their representatives in connection with the attempted resolution of any Dispute, including any mediator's evaluation referred to in Section 13.3, shall be deemed to have been delivered in furtherance of a Dispute settlement and shall be exempt from discovery and production, and shall not be admissible in evidence for any reason (whether as an admission or otherwise), in any arbitral or other proceeding for the resolution of the Dispute.

(c) In connection with any Dispute, the parties expressly waive and forego any right to (i) punitive, exemplary, statutorily-enhanced or similar damages in excess of compensatory damages, and (ii) trial by jury.

(d) The specific procedures set forth below, including but not limited to the time limits referenced therein, may be modified by agreement of the parties in writing.

(e) All applicable statutes of limitations and defenses based upon the passage of time shall be tolled while the procedures specified in this Article XIII are pending. The parties will take such action, if any, required to effectuate such tolling.

13.2. Consideration by Senior Executives. If a Dispute is not resolved in the normal course of business at the operational level, the parties shall attempt in good faith to resolve such Dispute by negotiation between executives who hold, at a minimum, the office of President and CEO of the respective business entities involved in such Dispute. Either party may initiate the executive negotiation process by providing a written notice to the other (the "Initial Notice"). Fifteen (15) days after delivery of the Initial Notice, the receiving party shall submit to the other a written response (the "Response"). The Initial Notice and the Response shall include (i) a statement of the Dispute and of each party's position, and (ii) the name and title of the executive who will represent that party and of any other person who will accompany the executive. Such executives will meet in person or by telephone within thirty (30) days of the date of the Initial Notice to seek a resolution of the Dispute.

13.3. Mediation. If a Dispute is not resolved by negotiation as provided in Section 13.2 within forty-five (45) days from the delivery of the Initial Notice, then either party may submit the Dispute for resolution by mediation pursuant to the CPR Institute for Dispute Resolution (the "CPR") Model Mediation Procedure as then in effect. The parties will select a mediator from the CPR Panels of Distinguished Neutrals, but such mediator must have prior U.S. reinsurance experience either as a lawyer or as a present or former officer or management employee of a reinsurance company, but not of the Company, or the Reinsurer, or any of their respective affiliates. Either party at commencement of the mediation may ask the mediator to provide an evaluation of the Dispute and the parties' relative positions.

13.4. Arbitration. (a) If a Dispute is not resolved by mediation as provided in Section 13.3 within thirty (30) days of the selection of a mediator (unless the mediator chooses to withdraw sooner), either party may submit the Dispute to be finally resolved by arbitration pursuant to the CPR Rules for Non-Administered Arbitration as then in effect (the "CPR Arbitration Rules"). The parties consent to a single, consolidated arbitration for all known Disputes existing at the time of the arbitration and for which arbitration is permitted.

(b) The neutral organization for purposes of the CPR Arbitration Rules will be the CPR. The arbitral tribunal shall be composed of three arbitrators who are each experienced in the U.S. reinsurance business, of whom each party shall appoint one in accordance with the "screened" appointment procedure provided in Rule 5.4 of the CPR Arbitration Rules. The non-party appointed arbitrator must have prior U.S. reinsurance experience as a present or former officer or management employee of a reinsurance company, but not of the Company, or the Reinsurer, or any of their respective affiliates. The arbitration shall be conducted in New York

City. Each party shall be permitted to present its case, witnesses and evidence, if any, in the presence of the other party. A written transcript of the proceedings shall be made and furnished to the parties. The arbitrators shall determine the Dispute in accordance with the law of Delaware, without giving effect to any conflict of law rules or other rules that might render such law inapplicable or unavailable, and shall apply this Agreement according to its terms, provided that the provisions relating to arbitration shall be governed by the Federal Arbitration Act, 9 U.S.C. §§ 1 et seq. The arbitral tribunal shall endeavor to render its award or order resulting from any arbitration within forty-five (45) days following the termination of the arbitration proceedings.

(c) The parties agree to be bound by any award or order resulting from any arbitration conducted hereunder and further agree that judgment on any award or order resulting from an arbitration conducted under this Section may be entered and enforced in any court having jurisdiction thereof.

(d) Except as expressly permitted by this Agreement, no party will commence or voluntarily participate in any court action or proceeding concerning a Dispute, except (i) for enforcement as contemplated by Section 13.4(c) above, (ii) to restrict or vacate an arbitral decision based on the grounds specified under applicable law, or (iii) for interim relief as provided in paragraph (e) below. For purposes of the foregoing the parties hereto submit to the non-exclusive jurisdiction of the courts of the State of New York.

(e) In addition to the authority otherwise conferred on the arbitral tribunal, the tribunal shall have the authority to make such orders for interim relief, including injunctive relief, as it may deem just and equitable. Notwithstanding paragraph (d) above, each party acknowledges that in the event of any actual or threatened breach of certain of the provisions of this Agreement, the remedy at law would not be adequate, and therefore injunctive or other interim relief may be sought immediately to restrain such breach. If the tribunal shall not have been appointed, either party may seek interim relief from a court having jurisdiction if the award to which the applicant may be entitled may be rendered ineffectual without such interim relief. Upon appointment of the tribunal following any grant of interim relief by a court, the tribunal may affirm or disaffirm such relief, and the parties will seek modification or rescission of the court action as necessary to accord with the tribunal's decision.

(f) Each party will bear its own attorneys' fees and costs incurred in connection with the resolution of any Dispute in accordance with this Article XIII.

#### ARTICLE XIV

##### MISCELLANEOUS PROVISIONS

14.1. Headings and Schedules. Headings used herein are not a part of this Agreement and shall not affect the terms hereof. The attached Schedules are a part of this Agreement.

14.2. Notices. All notices, requests, demands and other communications under this Agreement must be in writing and will be deemed to have been duly given or made as

---

follows: (a) if sent by registered or certified mail in the United States return receipt requested, upon receipt; (b) if sent by reputable overnight air courier, two business days after mailing; (c) if sent by facsimile transmission, with a copy mailed on the same day in the manner provided in (a) or (b) above, when transmitted and receipt is confirmed by telephone; or (d) if otherwise actually personally delivered, when delivered, and shall be delivered as follows:

If to the Company:

General Electric Capital Assurance Company  
6610 West Broad Street  
Richmond, VA 23230  
Facsimile: (804) 281-6165  
Attention: Executive Officer

With a copy to:

General Electric Capital Assurance Company  
6620 West Broad Street  
Richmond, VA 23230  
Facsimile: (804) 662-2414  
Attention: General Counsel

If to the Reinsurer:

Union Fidelity Life Insurance Company  
200 North Martingale Road  
Schaumburg, IL 60173-2096  
Facsimile: (847) 330-3404  
Attention: Chief Financial Officer

With a copy to:

Union Fidelity Life Insurance Company  
200 North Martingale Road  
Schaumburg, IL 60173-2096  
Facsimile: (847) 605-3044  
Attention: General Counsel

or to such other address or to such other Person as either party may have last designated by notice to the other party.

14.3. Successors and Assigns. This Agreement shall be binding upon and inure to the benefit of the parties hereto and their respective successors, permitted assigns and legal representatives. Neither this Agreement, nor any right or obligation hereunder, may be assigned by any party without the prior written consent of the other party hereto. Any assignment in violation of this Section 14.3 shall be void and shall have no force and effect. Nothing in this Section 14.3 shall be construed to prohibit the Reinsurer from retroceding all or any portion of the business reinsured hereunder.

18

---

14.4. Execution in Counterpart. This Agreement may be executed by the parties hereto in any number of counterparts, and by each of the parties hereto in separate counterparts, each of which counterparts, when so executed and delivered, shall be deemed to be an original, but all such counterparts shall together constitute but one and the same instrument.

14.5. Currency. Whenever the word "Dollars" or the "\$" sign appear in this Agreement, they shall be construed to mean United States Dollars, and all transactions under this Agreement shall be in United States Dollars.

14.6. Amendments. This Agreement may not be changed, altered or modified unless the same shall be in writing executed by the Company and the Reinsurer.

14.7. Governing Law. This Agreement will be construed, performed and enforced in accordance with the laws of the State of Delaware without giving effect to its principles or rules of conflict of laws thereof to the extent such principles or rules would require or permit the application of the laws of another jurisdiction.

14.8. Entire Agreement; Severability. (a) This Agreement and the Termination Letter Agreement constitute the entire agreement between the parties hereto relating to the subject matter hereof and supersede all prior and contemporaneous agreements, understandings, statements, representations and warranties, negotiations and discussions, whether oral or written, of the parties and there are no general or specific warranties, representations or other agreements by or among the parties in connection with the entering into of this Agreement or the subject matter hereof except as specifically set forth or contemplated herein or in the Termination Letter Agreement.

(b) If any provision of this Agreement is held to be void or unenforceable, in whole or in part, (i) such holding shall not affect the validity and enforceability of the remainder of this Agreement, including any other provision, paragraph or subparagraph, and (ii) the parties agree to attempt in good faith to reform such void or unenforceable provision to the extent necessary to render such provision enforceable and to carry out its original intent.

14.9. Contemporaneous Agreements. Concurrent with the execution of this Agreement, the parties and/or their Affiliates are also entering into the Capital Maintenance Agreement, the RBC Reporting Letter Agreement and the Assignment Letter Agreement.

14.10. No Waiver; Preservation of Remedies. No consent or waiver, express or implied, by any party to or of any breach or default by any other party in the performance by such other party of its obligations hereunder shall be deemed or construed to be a consent or waiver to or of any other breach or default in the performance of obligations hereunder by such other party hereunder. Failure on the part of any party to complain of any act or failure to act of any other party or to declare any other party in default, irrespective of how long such failure continues, shall not constitute a waiver by such first party of any of its rights hereunder. The rights and remedies provided are cumulative and are not exclusive of any rights or remedies that any party may otherwise have at law or equity.

14.11. Cooperation. Each party hereto shall cooperate fully with the other in all reasonable respects in order to accomplish the objectives of this Agreement including making

19

---

available to each their respective officers and employees for interviews and meetings with Governmental Authorities and furnishing any additional assistance, information and documents as may be reasonably requested by a party from time to time.

14.12. Third Party Beneficiary. Nothing in this Agreement will confer any rights upon any Person that is not a party or a successor or permitted assignee of a party to this Agreement.

14.13. Tax Exception to Any Confidentiality. Notwithstanding anything to the contrary set forth herein or in any other agreement to which the parties hereto are parties or by which they are bound, any obligations of confidentiality contained herein and therein, as they relate to the transactions, shall not apply to the federal tax structure or federal tax treatment of the transactions, and each party hereto (and any employee, representative, or agent of any party hereto) may disclose to any and all persons, without limitation of any kind, the federal tax structure and federal tax treatment of the transactions. The preceding sentence is intended to cause the transactions to be treated as not having been offered under conditions of confidentiality for purposes of Section 1.6011-4(b)(3) (or any successor provision) of the Treasury Regulations promulgated under Section 6011 of the Internal Revenue Code of 1986, as amended, and shall be construed in a manner consistent with such purpose. In addition, each party hereto acknowledges that it has no proprietary or exclusive rights to the federal tax structure of the transactions or any federal tax matter or federal tax idea related to the transactions.

14.14. Interpretation. Wherever the words "include," "includes" or "including" are used in this Agreement, they shall be deemed to be followed by the words "without limitation."

14.15. Survival. Article XIII and Article XIV shall survive the termination of this Agreement.

20

---



IN WITNESS WHEREOF, the parties hereto have caused this Agreement to be executed by their duly authorized representatives.

GENERAL ELECTRIC CAPITAL ASSURANCE COMPANY

By /s/ VICTOR C. MOSES  
Name: Victor C. Moses  
Title: Senior Vice President and Chief Actuary

UNION FIDELITY LIFE INSURANCE COMPANY

By /s/ GLENN JOPPA  
Name: Glenn Joppa  
Title: Senior Vice President and Secretary

SCHEDULE A

POLICY FORMS

8001

8101

8201

8401

1700

GECA RA&Q

---

-

SCHEDULE B

FORM OF ADMINISTRATIVE SERVICES AGREEMENT

---

SSA UFLIC/GECA

---

ADMINISTRATIVE SERVICES AGREEMENT

by and between

GENERAL ELECTRIC CAPITAL ASSURANCE COMPANY

and

UNION FIDELITY LIFE INSURANCE COMPANY

Effective as of [       ]

---

---

**ADMINISTRATIVE SERVICES AGREEMENT**

This ADMINISTRATIVE SERVICES AGREEMENT (this "Agreement"), effective as of [       ] (the "Effective Date"), is entered into by and between GENERAL ELECTRIC CAPITAL ASSURANCE COMPANY, an insurance company organized under the laws of the State of Delaware (the "Company"), and UNION FIDELITY LIFE INSURANCE COMPANY, an insurance company organized under the laws of the State of Illinois (the "Administrator").

**RECITALS:**

WHEREAS, the Company and the Administrator have entered into a Coinsurance Agreement dated as of April 15, 2004 (the "Coinsurance Agreement") which provides for the parties to enter into this Agreement;

WHEREAS, pursuant to the Coinsurance Agreement, the Administrator has agreed to indemnify the Company for, among other things, 100% of the liability of the Company for Benefits payable on or after the Inception Date with respect to the Reinsured Contracts (capitalized terms used herein and not defined herein, unless otherwise indicated, have the respective meanings assigned to them in the Coinsurance Agreement); and

WHEREAS, the Company wishes to appoint the Administrator to provide policyholder and claim servicing with respect to the Reinsured Contracts, and the Administrator desires to provide such administrative services;

NOW, THEREFORE, in consideration of the covenants and agreements set forth herein, the parties hereto agree as follows:

ARTICLE I

AUTHORITY

The Company hereby appoints the Administrator, and the Administrator hereby accepts appointment, to provide as an independent contractor of the Company, from and after the Effective Date, all of the policyholder and claim servicing services necessary or appropriate with respect to the Reinsured Contracts including those set forth in this Agreement (the "Administrative Services"), all on the terms as set forth in this Agreement. Notwithstanding any other provision of this Agreement to the contrary, the Company shall have the right to direct the Administrator to perform any action necessary for the Reinsured Contracts or the policyholder and claim servicing thereof to



## ARTICLE II

### STANDARD FOR SERVICES; FACILITIES; SUBCONTRACTING

2.1. Standard for Services. The Administrator shall provide policyholder and claims servicing with respect to the Reinsured Contracts in good faith and with the care, skill, prudence and diligence of a person experienced in administering structured settlement business. Without limiting the generality of the foregoing, the Administrator shall provide policyholder and claims servicing with respect to the Reinsured Contracts (i) in accordance with the terms of the Reinsured Contracts, (ii) in accordance with the applicable terms of this Agreement, (iii) in compliance with Applicable Law, (iv) in accordance with industry standards and, subject to the foregoing, (v) to the extent applicable, in the same manner as it conducts its own business not subject to this Agreement.

2.2. Facilities and Personnel. To the extent not sub-contracted to a Subcontractor, the Administrator shall at all times maintain sufficient facilities and trained personnel of the kind necessary to perform its obligations under this Agreement in accordance with the performance standards set forth herein.

2.3. Subcontracting. The Administrator may subcontract for the performance of any policyholder or claims servicing service or services with respect to the Reinsured Contracts to (i) an Affiliate or (ii) any other Person with the prior written consent of the Company, such consent not to be unreasonably withheld (in each case, the "Subcontractor"); provided, that, no such subcontracting shall relieve the Administrator from any of its obligations or liabilities hereunder, and the Administrator shall remain responsible for all obligations or liabilities of such Subcontractor with regards to the providing of such service or services as if provided by the Administrator.

## ARTICLE III

### CLAIMS HANDLING

The Administrator shall pay all Benefits payable on or after the Inception Date with respect to the Reinsured Contracts (each, a "Claim" and collectively the "Claims").

## ARTICLE IV

### REGULATORY AND LEGAL PROCEEDINGS

4.1. Regulatory Complaints and Proceedings. The Administrator shall:

- (i) respond to any Claims payment related complaints or inquiries made by any Governmental Authority, within the Governmental Authority's requested time frame for response or, if no such time frame is provided, within the time frame as allowed by Applicable Law; and promptly provide a copy of such response to the Company;

2

---

- (ii) promptly notify the Company of any non-Claims payment related complaints or inquiries initiated by a Governmental Authority, and of any proceedings (either Claims or non-Claims related) initiated by a Governmental Authority, and, in either case, prepare and send to the Governmental Authority, with a copy to the Company, a response within the Governmental Authority's requested time frame for response or, if no such time frame is provided, within the time frame as allowed by Applicable Law; provided, that, subject to meeting such time frames, the Administrator shall provide such response to the Company for its prior review and comment;

- (iii) subject to Section 4.4, supervise and control the investigation, contest, defense and/or settlement of all complaints, inquiries and proceedings by Governmental Authorities at its own cost and expense, and in the name of the Company when necessary; and

- (iv) at the Company's request, provide to the Company a report in a form mutually agreed by the parties summarizing the nature of any complaints, inquiries or proceedings by Governmental Authorities, the alleged actions or omissions giving rise to such complaints, inquiries or proceedings and copies of any files or other documents that the Company may reasonably request in connection with its review of these matters.

4.2. Legal Proceedings. The Administrator shall:

- (i) notify the Company promptly of any lawsuit, action, arbitration or other dispute resolution proceedings that are instituted or threatened with respect to any matter relating to the Reinsured Contracts ("Legal Proceeding(s)"), and in no event more than five (5) Business Days after receipt of notice thereof;

- (ii) subject to Section 4.4, supervise and control the investigation, contest, defense and/or settlement of all Legal Proceedings at its own cost and expense, and in the name of the Company when necessary; and

- (iii) keep the Company fully informed of the progress of all Legal Proceedings handled by the Administrator in which the Company is named a party and, at the Company's request, provide to the Company a report summarizing the nature of any Legal Proceedings, the alleged actions or omissions giving rise to such Legal Proceedings and copies of any files or other documents that the Company may reasonably request in connection with its review of these matters in each case other than such files, documents and other information as would, in the judgment of counsel to the Administrator, lead to the loss or waiver of legal privilege.

4.3. Notice to Administrator. The Company shall give prompt notice to the Administrator of any Legal Proceeding made or brought against the Company after the Inception

Date arising under or in connection with the Reinsured Contracts to the extent known to it and not made against or served on the Administrator or a Subcontractor as administrator hereunder, and in no event more than five (5) Business Days after receipt of notice thereof, and shall promptly furnish to the Administrator copies of all pleadings in connection therewith. The Administrator shall assume the defense of the Company.

4.4. Defense of Regulatory and Legal Proceedings. Notwithstanding anything in this Agreement to the contrary, the Company shall have the right to engage in its own separate legal representation, at its own expense, and to participate fully in the defense of any Legal Proceedings or complaints, inquiries or proceedings by Governmental Authorities with respect to the Reinsured Contracts in which the Company is a named party without waiving any right to indemnification it may have under Article XV hereof. The Administrator and the Company shall cooperate with each other with respect to the administration of any Legal Proceeding and any complaint, inquiry or proceeding by Governmental Authorities. The Administrator shall not settle any Legal Proceeding or any complaint, inquiry or proceeding by Governmental Authorities without the Company's prior written consent (which consent shall not be unreasonably withheld or delayed) unless (i) there is no finding or admission of any violation of law or any violation of the rights of any Person, (ii) such settlement would not reasonably be expected to have material adverse precedential consequences to the Company and (iii) the sole relief provided is monetary damages that are paid in full by the Administrator.

## ARTICLE V

### NOTIFICATION TO POLICYHOLDERS

The Administrator agrees to send to policyholders of the Reinsured Contracts a written notice prepared by the Administrator and reasonably acceptable to the Company to the effect that the Administrator, or such other Person designated by the Administrator in accordance with the terms of this Agreement, has been appointed by the Company to provide Administrative Services. The Administrator shall send such notice by first class U.S. mail at a time reasonably acceptable to the Company and the Administrator and in all events in accordance with Applicable Law. The parties intend to minimize the cost associated with any notification under this Article V, including by means of inclusion of the notice in a regularly scheduled mailing to policyholders in lieu of a separate mailing. The cost associated with such notification under this Article V (upon the initial assumption of the administration of the Reinsured Contracts under Section 3.7 of the Coinsurance Agreement) shall be a transition cost payable by the Administrator or the Company in accordance with Section 3.7(a) or 3.7(c) of the Coinsurance Agreement, as applicable.

## ARTICLE VI

### INSOLVENCY FUND ACCOUNTINGS

6.1. Quarterly Accountings. Within thirty (30) days after the end of each calendar quarter that this Agreement is in effect (or more frequently as mutually agreed by the

parties), the Company shall submit to the Administrator a written statement of accounting in a form and containing such information to be agreed upon by the parties hereto (each, an "Insolvency Fund Quarterly Accounting") setting forth the Insolvency Fund amounts assessed or payable to the extent that such assessments constitute Reinsured Risks with respect to the Reinsured Contracts (collectively, the "Post-Effective Date Assessments"). The Administrator shall remit to the Company an amount equal to the Post-Effective Date Assessments set forth in an Insolvency Fund Quarterly Accounting received by the Administrator within ten (10) Business Days of receipt by the Administrator of such Insolvency Fund Quarterly Accounting.

6.2. Adjustments Regarding Insolvency Fund Accountings. In the event that subsequent data or calculations require revision of any of the Insolvency Fund Quarterly Accountings, the required revision and appropriate payments thereunder shall be made within ten (10) Business Days after the parties hereto mutually agree as to the appropriate revision.

## ARTICLE VII

### CERTAIN ACTIONS BY COMPANY

7.1. Filings. The Company shall prepare and timely file any filings required to be made with any Governmental Authority that relate to the Company generally and not just to the Reinsured Contracts, including filings with guaranty associations and filings and premium tax returns with taxing authorities. The Administrator shall, in a timely fashion in light of the dates such filings by the Company are required, provide to the Company all information in the possession of the Administrator with respect to the Reinsured Contracts that may be reasonably required for the Company to prepare such filings and tax returns.

7.2. Annual Adjustment. The Company shall pay or provide to the Administrator the benefit of any Post-Effective Date Assessments which have been or can be applied to reduce the Company's premium tax liability ("Premium Tax Credits"). The Company shall provide to the Administrator by March 15 of each year a statement of the amount of Premium Tax Credits for the prior calendar year and the Company will pay or credit to the Administrator an amount equal to such Premium Tax Credits.

## ARTICLE VIII

### REGULATORY MATTERS AND AUDIT REPORTING

8.1. Regulatory Compliance and Reporting. The Administrator shall provide to the Company such information with respect to the Reinsured Contracts as is required to satisfy all current and future informational reporting, prior approval and any other requirements imposed by any Governmental Authority. Upon the reasonable request of the Company, the Administrator shall timely prepare such reports and summaries, including statistical summaries, as are necessary or reasonably required to satisfy any requirements imposed by a Governmental Authority upon the Company with respect to the Reinsured Contracts. In addition, the Administrator, upon

respect to records maintained in machine readable form, hard copies) that are necessary to satisfy such requirements. All copies of records furnished in the ordinary course of business shall be furnished by the Administrator at the Administrator's cost. Any extraordinary costs reasonably incurred by the Administrator in response to requests from the Company shall be reimbursed by the Company. Among other responsibilities:

- (i) The Administrator shall promptly prepare and furnish to Governmental Authorities all reports and related summaries (including, without limitation, statistical summaries), certificates of compliance and other reports required or requested by a Governmental Authority.
- (ii) The Administrator shall assist the Company and cooperate with the Company in doing all things necessary, proper or advisable, in the most expeditious manner practicable in connection with any and all market conduct or other Governmental Authority examinations relating to the Reinsured Contracts.

8.2. Reporting and Accounting. The Administrator shall assume the reporting and accounting obligations set forth below:

- (i) As soon as practicable but not more than forty (40) days after the end of each calendar quarter that this Agreement is in effect (or more frequently as mutually agreed by the parties), the Administrator shall timely provide to the Company reports and summaries of transactions (and, upon request of the Company, detailed supporting records) related to the Reinsured Contracts as may be reasonably required for use in connection with the preparation of the Company's statutory and GAAP financial statements, tax returns and other required financial reports and to comply with the requirements of the regulatory authorities having jurisdiction over the Company. The parties shall cooperate in good faith to establish the manner for the providing of such reports.
- (ii) As soon as practicable but not more than forty (40) days after the end of each calendar quarter that this Agreement is in effect (or more frequently as mutually agreed by the parties), the Administrator shall report to the Company the amount of statutory reserves that the Company is required to maintain in connection with the Reinsured Risks with respect to the Reinsured Contracts as of the quarter end.
- (iii) The Administrator shall promptly provide notice to the Company of any changes in the reserve methodology used by the Administrator in calculating statutory reserves for the Reinsured Contracts.
- (iv) Within forty-five (45) days after each calendar year end (or such longer time as may be agreed by the parties) that this Agreement is in effect, the Administrator shall provide to the Company (a) an opinion of an actuary reasonably acceptable to the Company as to the adequacy of statutory

reserves for the Reinsured Contracts, prepared according to accepted actuarial standards of practice, and as otherwise required for regulatory reporting purposes and (b) an analysis which reasonably supports such opinion.

8.3. Additional Reports and Updates. For so long as this Agreement remains in effect, each party shall periodically furnish to the other such other reports and information as may be reasonably required by such other party for regulatory, tax or similar purposes and reasonably available to it.

#### ARTICLE IX

#### MISCELLANEOUS ADMINISTRATIVE SERVICES

The Administrator shall provide such other Administrative Services as are necessary or appropriate to fully effectuate the purpose of the Reinsurance Agreement and this Agreement, including such Administrative Services as are not performed by or on behalf of the Company on the date hereof but the need for which may arise due to changes or developments in Applicable Law.

#### ARTICLE X

#### BOOKS AND RECORDS

The Administrator shall keep accurate and complete records, files and accounts of all transactions and matters with respect to the Reinsured Contracts and the administration thereof in accordance with Applicable Law and its record management practices in effect from time to time for the Administrator's insurance business not covered by this Agreement, if any. The parties to this Agreement and their designated representatives may upon reasonable notice inspect, at the offices of the Administrator or the Company where such records are located, the papers and any and all other books or documents of the Administrator or the Company reasonably relating to this Agreement, including the Reinsured Contracts, and shall have access to appropriate employees and representatives of the other party, in each case during normal business hours for such period as this Agreement is in effect or for as long thereafter as any rights or obligations of any party survives or the Administrator or the Company reasonably need access to such records for regulatory, tax or similar purposes. The information obtained shall be used only for purposes relating to the transactions contemplated under this Agreement.

#### ARTICLE XI

#### COOPERATION

Each party hereto shall cooperate fully with the other in all reasonable respects in order to accomplish the objectives of this Agreement including making available to each their respective officers and employees for interviews and meetings with Governmental Authorities and

furnishing any additional assistance, information and documents as may be reasonably requested by a party from time to time.

## ARTICLE XII

### PRIVACY REQUIREMENTS

In providing the Administrative Services provided for under this Agreement, and in connection with maintaining, administering, handling and transferring the data of the policyholders and other recipients of benefits under the Reinsured Contracts, the Administrator shall, and shall cause its Affiliates and any permitted Subcontractors to, comply with all confidentiality and security obligations applicable to them in connection with the collection, use, disclosure, maintenance and transmission of personal, private, health or financial information about individual policyholders or benefit recipients, including the provisions of privacy policies under which such information was gathered, those laws currently in place and which may become effective during the term of this Agreement, including the Gramm-Leach-Bliley Act, the Health Insurance Portability and Accountability Act of 1996 and any other Applicable Laws. The Administrator shall entitle the Company and its agents and representatives, the Commissioner of Health and Human Services and such other Governmental Authorities, to the extent required by Applicable Law, to audit the Administrator's compliance herewith. The Administrator shall also enable individual subjects of personally identifiable information, upon request from such individuals, to review and correct information maintained by the Administrator about them, and to restrict use of such information. The Administrator shall promptly report to the Company any violation of this provision of which the Administrator becomes aware. Unless required by Applicable Law, the Administrator shall not during the term of this Agreement, modify the privacy policies under which information utilized by the Administrator in administering the Reinsured Contracts is gathered, without the Company's prior written consent, which consent shall not be unreasonably withheld. The parties agree to comply with the terms of the Business Associate Addendum attached hereto, if applicable, or such other written agreement as may be required by Applicable Law on the date hereof.

## ARTICLE XIII

### CONSIDERATION FOR ADMINISTRATIVE SERVICES

Apart from the performance by the Company of its obligations under the Coinsurance Agreement, there shall be no fee or other consideration due to the Administrator for performance of the Administrative Services under this Agreement.

## ARTICLE XIV

### BANK ACCOUNT; USE OF COMPANY LETTERHEAD

When and on terms reasonably requested by the Administrator, the Company shall open, modify or close, and make available for use by the Administrator for the payment of amounts to

be paid by the Administrator hereunder one or more bank accounts of the Company and check stock of the Company. The Administrator shall maintain such account(s) and pay all applicable bank fees and check stock costs. The Company shall adopt such resolutions and execute such documents as required to designate senior officers of the Administrator (by title) as signatories on such account(s) and authorize the Administrator to certify to such bank(s), from time to time, the names of such officers. The Company shall also make available to the Administrator, at the sole expense of the Administrator, such letterhead, printed forms and other documents of the Company as may be reasonably required by the Administrator in performing services hereunder. Upon termination of this Agreement, the Administrator shall promptly return to the Company all such unused check stock, letterhead, printed forms and other documents held by it in connection with this Agreement as provided under this Article XIV.

## ARTICLE XV

### INDEMNIFICATION

Any claim for or with respect to indemnification arising out of, or relating to, this Agreement or the Administrative Services hereunder shall be permitted under and governed by the provisions of Article V of the Master Agreement, dated as of [ ], 2004, among General Electric Company, General Electric Capital Corporation, GEL, Inc., GE Financial Assurance Holdings, Inc. and Genworth Financial, Inc (the "Master Agreement"), to the extent such provisions are applicable, as if this Agreement were a Transaction Document under the Master Agreement.

## ARTICLE XVI

### DURATION; TERMINATION

16.1. Duration. This Agreement shall commence on the Effective Date and continue with respect to each Reinsured Contract until no further Administrative Services in respect of such Reinsured Contract is required, unless this Agreement is earlier terminated under Section 16.2.

16.2. Termination. (a) This Agreement is subject to immediate termination at the option of the Company, upon written notice to the Administrator, on the occurrence of any of the following events:

- (i) A voluntary or involuntary proceeding is commenced in any jurisdiction by or against the Administrator for the purpose of conserving, rehabilitating or liquidating the Administrator;

- (ii) There is a material breach by the Administrator of any material term or condition of this Agreement that is not cured by the Administrator within thirty (30) days after receipt of written notice from the Company of such breach or act (provided that the Company shall not have the right to terminate this Agreement (A) for so long as the Administrator is making a

good faith effort to cure such breach, not to exceed an additional one hundred eighty (180) days or (B) during the pendency of any dispute resolution proceedings as set forth in Article XVII regarding an alleged material breach); or

- (iii) The Administrator is unable to perform the services required under this Agreement for a period of thirty (30) consecutive days for any reason other than as a result of a Force Majeure, it being understood that nothing in this Section 16.2(a)(iii) shall relieve the Administrator from its administrative responsibilities under this Agreement. For purposes of this Agreement, "Force Majeure" means any acts or omissions of any civil or military authority, acts of God, acts or omissions of the Company, fires, strikes or other labor disturbances, equipment failures, fluctuations or non-availability of electrical power, heat, light, air conditioning or telecommunications equipment, or any other act, omission or occurrence beyond the Administrator's reasonable control, irrespective of whether similar to the foregoing enumerated acts, omissions or occurrences.

(b) This Agreement may be terminated at any time upon the mutual written consent of the parties hereto, which writing shall state the effective date of termination.

(c) In the event that this Agreement is terminated under any of the provisions of Section 16.2(a), the Administrator shall select a third-party administrator to perform the services required by this Agreement. The Company shall have the right to approve any such administrator selected by the Administrator, but such approval will not unreasonably be withheld or delayed. If the Administrator fails to select an administrator pursuant to this Section 16.2(c), the Company shall select such an administrator. In either case, the Administrator shall pay all fees and charges imposed by the selected administrator and shall bear all transition costs associated with the transition of the performance of the services required under this Agreement to such administrator, including the expense of sending policyholder notices as provided in Article V.

## ARTICLE XVII

### DISPUTE RESOLUTION

17.1. General Provisions. (a) Any dispute, controversy or claim arising out of or relating to this Agreement or the validity, interpretation, breach or termination thereof (a "Dispute"), shall be resolved in accordance with the procedures set forth in this Article XVII, which shall be the sole and exclusive procedures for the resolution of any such Dispute unless otherwise specified below.

(b) Commencing with the request contemplated by Section 17.2, all communications between the parties or their representatives in connection with the attempted resolution of any Dispute, including any mediator's evaluation referred to in Section 17.3, shall be deemed to have been delivered in furtherance of a Dispute settlement and shall be exempt

from discovery and production, and shall not be admissible in evidence for any reason (whether as an admission or otherwise), in any arbitral or other proceeding for the resolution of the Dispute.

(c) In connection with any Dispute, the parties expressly waive and forego any right to (i) punitive, exemplary, statutorily-enhanced or similar damages in excess of compensatory damages (provided that any such liability with respect to a Third Party Claim (as defined in the Master Agreement) shall be considered direct damages), and (ii) trial by jury.

(d) The specific procedures set forth below, including but not limited to the time limits referenced therein, may be modified by agreement of the parties in writing.

(e) All applicable statutes of limitations and defenses based upon the passage of time shall be tolled while the procedures specified in this Article XVII are pending. The parties will take such action, if any, required to effectuate such tolling.

17.2. Consideration by Senior Executives. If a Dispute is not resolved in the normal course of business at the operational level, the parties shall attempt in good faith to resolve such Dispute by negotiation between executives who hold, at a minimum, the office of President and CEO of the respective business entities involved in such Dispute. Either party may initiate the executive negotiation process by providing a written notice to the other (the "Initial Notice"). Fifteen (15) days after delivery of the Initial Notice, the receiving party shall submit to the other a written response (the "Response"). The Initial Notice and the Response shall include (i) a statement of the Dispute and of each party's position, and (ii) the name and title of the executive who will represent that party and of any other person who will accompany the executive. Such executives will meet in person or by telephone within thirty (30) days of the date of the Initial Notice to seek a resolution of the Dispute.

17.3. Mediation. If a Dispute is not resolved by negotiation as provided in Section 17.2 within forty-five (45) days from the delivery of the Initial Notice, then either party may submit the Dispute for resolution by mediation pursuant to the CPR Institute for Dispute Resolution (the "CPR") Model Mediation Procedure as then in effect. The parties will select a mediator from the CPR Panels of Distinguished Neutrals, but such mediator must have prior U.S. reinsurance experience either as a lawyer or as a present or former officer or management employee of a reinsurance company, but not of the Company, or the Administrator, or any of their respective affiliates. Either party at commencement of the mediation may ask the mediator to provide an evaluation of the Dispute and the parties' relative positions.

17.4. Arbitration. (a) If a Dispute is not resolved by mediation as provided in Section 17.3 within thirty (30) days of the selection of a mediator (unless the mediator chooses to withdraw sooner), either party may submit the Dispute to be finally resolved by arbitration pursuant to the CPR Rules for Non-Administered Arbitration as then in effect (the "CPR Arbitration Rules"). The parties consent to a single, consolidated arbitration for all known Disputes existing at the time of the arbitration and for which arbitration is permitted.

(b) The neutral organization for purposes of the CPR Arbitration Rules will be the CPR. The arbitral tribunal shall be composed of three arbitrators who are

---

U.S. reinsurance business, of whom each party shall appoint one in accordance with the “screened” appointment procedure provided in Rule 5.4 of the CPR Arbitration Rules. The non-party appointed arbitrator must have prior U.S. reinsurance experience as a present or former officer or management employee of a reinsurance company, but not of the Company, or the Administrator, or any of their respective affiliates. The arbitration shall be conducted in New York City. Each party shall be permitted to present its case, witnesses and evidence, if any, in the presence of the other party. A written transcript of the proceedings shall be made and furnished to the parties. The arbitrators shall determine the Dispute in accordance with the law of Delaware, without giving effect to any conflict of law rules or other rules that might render such law inapplicable or unavailable, and shall apply this Agreement according to its terms, provided that the provisions relating to arbitration shall be governed by the Federal Arbitration Act, 9 U.S.C. §§ 1 et seq. The arbitral tribunal shall endeavor to render its award or order resulting from any arbitration within forty-five (45) days following the termination of the arbitration proceedings.

(c) The parties agree to be bound by any award or order resulting from any arbitration conducted hereunder and further agree that judgment on any award or order resulting from an arbitration conducted under this Section 17.4 may be entered and enforced in any court having jurisdiction thereof.

(d) Except as expressly permitted by this Agreement, no party will commence or voluntarily participate in any court action or proceeding concerning a Dispute, except (i) for enforcement as contemplated by Section 17.4(c) above, (ii) to restrict or vacate an arbitral decision based on the grounds specified under applicable law, or (iii) for interim relief as provided in paragraph (e) below. For purposes of the foregoing the parties hereto submit to the non-exclusive jurisdiction of the courts of the State of New York.

(e) In addition to the authority otherwise conferred on the arbitral tribunal, the tribunal shall have the authority to make such orders for interim relief, including injunctive relief, as it may deem just and equitable. Notwithstanding paragraph (d) above, each party acknowledges that in the event of any actual or threatened breach of certain of the provisions of this Agreement, the remedy at law would not be adequate, and therefore injunctive or other interim relief may be sought immediately to restrain such breach. If the tribunal shall not have been appointed, either party may seek interim relief from a court having jurisdiction if the award to which the applicant may be entitled may be rendered ineffectual without such interim relief. Upon appointment of the tribunal following any grant of interim relief by a court, the tribunal may affirm or disaffirm such relief, and the parties will seek modification or rescission of the court action as necessary to accord with the tribunal’s decision.

(f) Each party will bear its own attorneys’ fees and costs incurred in connection with the resolution of any Dispute in accordance with this Article XVII.

---

ARTICLE XVIII

MISCELLANEOUS PROVISIONS

18.1. Headings and Schedules. Headings used herein are not a part of this Agreement and shall not affect the terms hereof. The attached Schedules are a part of this Agreement.

18.2. Notices. All notices, requests, demands and other communications under this Agreement must be in writing and will be deemed to have been duly given or made as follows: (a) if sent by registered or certified mail in the United States return receipt requested, upon receipt; (b) if sent by reputable overnight air courier, two business days after mailing; (c) if sent by facsimile transmission, with a copy mailed on the same day in the manner provided in (a) or (b) above, when transmitted and receipt is confirmed by telephone; or (d) if otherwise actually personally delivered, when delivered, and shall be delivered as follows:

If to the Company:

General Electric Capital Assurance Company  
6610 West Broad Street  
Richmond, VA 23230  
Facsimile: (804) 281-6165  
Attention: Executive Officer

With a copy to:

General Electric Capital Assurance Company  
6620 West Broad Street  
Richmond, VA 23230  
Facsimile: (804) 662-2414  
Attention: General Counsel

If to the Administrator:

Union Fidelity Life Insurance Company  
200 North Martingale Road  
Schaumburg, IL 60173-2096  
Facsimile: (847) 330-3404  
Attention: Chief Financial Officer

With a copy to:

Union Fidelity Life Insurance Company  
 200 North Martingale Road  
 Schaumburg, IL 60173-2096  
 Facsimile: (847) 605-3044  
 Attention: General Counsel

or to such other address or to such other Person as either party may have last designated by notice to the other party.

18.3. Successors and Assigns. This Agreement shall be binding upon and inure to the benefit of the parties hereto and their respective successors, permitted assigns and legal representatives. Neither this Agreement, nor any right or obligation hereunder, may be assigned by any party without the prior written consent of the other party hereto. Any assignment in violation of this Section 18.3 shall be void and shall have no force and effect.

18.4. Execution in Counterpart. This Agreement may be executed by the parties hereto in any number of counterparts, and by each of the parties hereto in separate counterparts, each of which counterparts, when so executed and delivered, shall be deemed to be an original, but all such counterparts shall together constitute but one and the same instrument.

18.5. Currency. Whenever the word "Dollars" or the "\$" sign appear in this Agreement, they shall be construed to mean United States Dollars, and all transactions under this Agreement shall be in United States Dollars.

18.6. Amendments. This Agreement may not be changed, altered or modified unless the same shall be in writing executed by the Company and the Administrator.

18.7. Governing Law. This Agreement will be construed, performed and enforced in accordance with the laws of the State of Delaware without giving effect to its principles or rules of conflict of laws thereof to the extent such principles or rules would require or permit the application of the laws of another jurisdiction.

18.8. Entire Agreement; Severability. (a) This Agreement constitutes the entire agreement between the parties hereto relating to the subject matter hereof and supersedes all prior and contemporaneous agreements, understandings, statements, representations and warranties, negotiations and discussions, whether oral or written, of the parties and there are no general or specific warranties, representations or other agreements by or among the parties in connection with the entering into of this Agreement or the subject matter hereof except as specifically set forth or contemplated herein.

(b) If any provision of this Agreement is held to be void or unenforceable, in whole or in part, (i) such holding or provision shall not affect the validity and enforceability of the remainder of this Agreement, including any other provision, paragraph or subparagraph, and (ii) the parties agree to attempt in good faith to reform such void, unenforceable or violative provision to the extent necessary to render such provision enforceable and to carry out its original intent.

18.9. No Waiver; Preservation of Remedies. No consent or waiver, express or implied, by any party to or of any breach or default by any other party in the performance by such other party of its obligations hereunder shall be deemed or construed to be a consent or waiver to or of any other breach or default in the performance of obligations hereunder by such other party hereunder. Failure on the part of any party to complain of any act or failure to act of any other party or to declare any other party in default, irrespective of how long such failure continues, shall not constitute a waiver by such first party of any of its rights hereunder. The rights and remedies provided are cumulative and are not exclusive of any rights or remedies that any party may otherwise have at law or equity.

18.10. Third Party Beneficiary. Nothing in this Agreement will confer any rights upon any Person that is not a party or a successor or permitted assignee of a party to this Agreement.

18.11. Tax Exception to Any Confidentiality. Notwithstanding anything to the contrary set forth herein or in any other agreement to which the parties hereto are parties or by which they are bound, any obligations of confidentiality contained herein and therein, as they relate to the transactions, shall not apply to the federal tax structure or federal tax treatment of the transactions, and each party hereto (and any employee, representative, or agent of any party hereto) may disclose to any and all persons, without limitation of any kind, the federal tax structure and federal tax treatment of the transactions. The preceding sentence is intended to cause the transactions to be treated as not having been offered under conditions of confidentiality for purposes of Section 1.6011-4(b)(3) (or any successor provision) of the Treasury Regulations promulgated under Section 6011 of the Internal Revenue Code of 1986, as amended, and shall be construed in a manner consistent with such purpose. In addition, each party hereto acknowledges that it has no proprietary or exclusive rights to the federal tax structure of the transactions or any federal tax matter or federal tax idea related to the transactions.

18.12. Interpretation. Wherever the words "include," "includes" or "including" are used in this Agreement, they shall be deemed to be followed by the words "without limitation."

18.13. Survival. Article XVII and Article XVIII shall survive the termination of this Agreement.

GENERAL ELECTRIC CAPITAL ASSURANCE COMPANY

By: \_\_\_\_\_  
Name:  
Title:

UNION FIDELITY LIFE INSURANCE COMPANY

By: \_\_\_\_\_  
Name:  
Title:

---

**BUSINESS ASSOCIATE ADDENDUM**

I. Purpose.

In order to disclose certain information to the party providing a service under this Agreement (“Provider”) under this Addendum, some of which may constitute Protected Health Information (defined below), the party to whom a service under this Agreement is being provided (“Recipient”) and Provider mutually agree to comply with the terms of this Addendum for the purpose of satisfying the requirements of the Health Insurance Portability and Accountability Act of 1996 (“HIPAA”) and its implementing privacy regulations at 45 C.F.R. Parts 160-164 (“HIPAA Privacy Rule”). These provisions shall apply to Provider to the extent that Provider is considered a “Business Associate” under the HIPAA Privacy Rule and all references in this section to Business Associates shall refer to Provider. Capitalized terms not otherwise defined herein shall have the meaning assigned in the Agreement. Notwithstanding anything else to the contrary in the Agreement, in the event of a conflict between this Addendum and the Agreement, the terms of this Addendum shall prevail.

II. Permitted Uses and Disclosures.

A. Business Associate agrees to use or disclose Protected Health Information (“PHI”) that it creates for or receives from Recipient or its Subsidiaries only as follows. The capitalized term “Protected Health Information or PHI” has the meaning set forth in 45 Code of Federal Regulations Section 164.501, as amended from time to time. Generally, this term means individually identifiable health information including, without limitation, all information, data and materials, including without limitation, demographic, medical and financial information, that relates to the past, present, or future physical or mental health or condition of an individual; the provision of health care to an individual; or the past present, or future payment for the provision of health care to an individual; and that identifies the individual or with respect to which there is a reasonable basis to believe the information can be used to identify the individual. This definition shall include any demographic information concerning members and participants in, and applicants for, Recipient’s or its Subsidiaries’ health benefit plans. All other terms used in this Addendum shall have the meanings set forth in the applicable definitions under the HIPAA Privacy Rule.

B. Functions and Activities on Company’s Behalf. Business Associate is permitted to use and disclose PHI it creates for or receives from Recipient or its Subsidiaries only for the purposes described in this Addendum or the Agreement that are not inconsistent with the provisions of this Addendum, or as required by law, or following receipt of prior written approval from whichever of the Recipient or its Subsidiary for which the relevant PHI was created or from which the relevant PHI was received. In addition to these specific requirements below, Business Associate may use or disclose PHI only in a manner that would not violate the HIPAA Privacy Rule if done by the Recipient or its Subsidiaries.

C. Business Associate’s Operations. Business Associate is permitted by this Agreement to use PHI it creates for or receives from Recipient or its Subsidiaries: (i) if such use is reasonably necessary for Business Associate’s proper management and administration; and (ii) as reasonably necessary to carry out Business Associate’s legal responsibilities.

---

Business Associate is permitted to disclose PHI it creates for or receives from Recipient or its Subsidiaries for the purposes identified in this Section only if the following conditions are met:

- (1) The disclosure is required by law; or
- (2) The disclosure is reasonably necessary to Business Associate’s proper management and administration, and Business Associate obtains reasonable assurances in writing from any person or organization to which Business Associate will disclose such PHI that the person or organization will:
  - a. Hold such PHI as confidential and use or further disclose it only for the purpose for which Business Associate disclosed it to the person or organization or as required by law; and
  - b. Notify Business Associate (who will in turn promptly notify whichever of the Recipient or its Subsidiary for which the relevant PHI was created or from which the relevant PHI was received) of any instance of which the person or organization becomes aware in which the confidentiality of such PHI was breached.



D. Minimum Necessary Standard. In performing the functions and activities on Recipient's or its Subsidiaries' behalf pursuant to the Agreement, Business Associate agrees to use, disclose or request only the minimum necessary PHI to accomplish the purpose of the use, disclosure or request. Business Associate must have in place policies and procedures that limit the PHI disclosed to meet this minimum necessary standard.

E. Prohibition on Unauthorized Use or Disclosure. Business Associate will neither use nor disclose PHI it creates or receives for or from Recipient, its Subsidiaries, or from another business associate of Recipient or its Subsidiaries, except as permitted or required by this Addendum or the Agreement that are not inconsistent with the provisions of this Addendum, or as required by law, or following receipt of prior written approval from whichever of the Recipient or its Subsidiary for which the relevant PHI was created or from which the relevant PHI was received.

F. De-identification of Information. Business Associate agrees neither to de-identify PHI it creates for or receives from Recipient or its Subsidiaries or from another business associate of Recipient or its Subsidiaries, nor use or disclose such de-identified PHI, unless such de-identification is expressly permitted under the terms and conditions of this Addendum or the Agreement and related to Recipient's or its Subsidiaries' activities for purposes of "treatment", "payment" or "health care operations", as those terms are defined under the HIPAA Privacy Rule. De-identification of PHI, other than as expressly permitted under the terms and conditions of the Addendum for Business Associate to perform services for Recipient or its Subsidiaries, is not a permitted use of PHI under this Addendum. Business Associate further agrees that it will not create a "Limited Data Set" as defined by the HIPAA Privacy Rule using PHI it creates or receives, or receives from another business associate of Recipient or its Subsidiaries, nor use or disclose such Limited Data Set unless: (i) such creation, use or disclosure is expressly permitted under the terms and conditions of

2

---

this Addendum or the Agreement that are not inconsistent with the provisions of this Addendum; and such creation, use or disclosure is for services provided by Business Associate that relate to Recipient's or its Subsidiaries' activities for purposes of "treatment", "payment" or "health care operations", as those terms are defined under the HIPAA Privacy Rule.

G. Information Safeguards. Business Associate will develop, document, implement, maintain and use appropriate administrative, technical and physical safeguards to preserve the integrity and confidentiality of and to prevent non-permitted use or disclosure of PHI created for or received from Recipient or its Subsidiaries. These safeguards must be appropriate to the size and complexity of Business Associate's operations and the nature and scope of its activities. Business Associate agrees that these safeguards will meet any applicable requirements set forth by the U.S. Department of Health and Human Services, including (as of the effective date or as of the compliance date, whichever is applicable) any requirements set forth in the final HIPAA security regulations. Business Associate agrees to mitigate, to the extent practicable, any harmful effect that is known to Business Associate resulting from a use or disclosure of PHI by Business Associate in violation of the requirements of this Addendum.

III. Conducting Standard Transactions. In the course of performing services for Recipient or its Subsidiaries, to the extent that Business Associate will conduct Standard Transactions for or on behalf of Recipient or its Subsidiaries, Business Associate will comply, and will require any subcontractor or agent involved with the conduct of such Standard Transactions to comply, with each applicable requirement of 45 C.F.R. Part 162. "Standard Transaction(s)" shall mean a transaction that complies with the standards set forth at 45 C.F.R. parts 160 and 162. Further, Business Associate will not enter into, or permit its subcontractors or agents to enter into, any trading partner agreement in connection with the conduct of Standard Transactions for or on behalf of the Recipient or its Subsidiaries that:

- a. Changes the definition, data condition, or use of a data element or segment in a Standard Transaction;
- b. Adds any data element or segment to the maximum defined data set;
- c. Uses any code or data element that is marked "not used" in the Standard Transaction's implementation specification or is not in the Standard Transaction's implementation specification; or
- d. Changes the meaning or intent of the Standard Transaction's implementation specification.

IV. Sub-Contractors, Agents or Other Representatives. Business Associate will require any of its subcontractors, agents or other representatives to which Business Associate is permitted by this Addendum or the Agreement (or is otherwise given Recipient's or the relevant Subsidiary's prior written approval) to disclose any of the PHI Business Associate creates or receives for or from Recipient or its Subsidiaries, to provide reasonable assurances in writing that subcontractor

3

---

or agent will comply with the same restrictions and conditions that apply to the Business Associate under the terms and conditions of this Addendum with respect to such PHI.

V. Protected Health Information Access, Amendment and Disclosure Accounting.

A. Access. Business Associate will promptly upon Recipient's or its Subsidiary's request make available to Recipient, its Subsidiary, or, at Recipient's or such Subsidiary's direction, to the individual (or the individual's personal representative) for inspection and obtaining copies any PHI about the individual which Business Associate created for or received from Recipient or its Subsidiary and that is in Business Associate's custody or control, so that Recipient or its Subsidiary may meet its access obligations under 45 Code of Federal Regulations § 164.524.

B. Amendment. Upon Recipient's or its Subsidiary's request Business Associate will promptly amend or permit Recipient or its Subsidiary access to amend any portion of the PHI which Business Associate created for or received from Recipient or its Subsidiary, and incorporate any amendments to such PHI, so that Recipient or its Subsidiary may meet its amendment obligations under 45 Code of Federal Regulations § 164.526.

C. Disclosure Accounting. So that Recipient or its Subsidiaries may meet their disclosure accounting obligations under 45 Code of Federal Regulations § 164.528:

1. Disclosure Tracking. Business Associate will record for each disclosure, not excepted from disclosure accounting under Section V.C.2 below, that Business Associate makes to Recipient or its Subsidiaries of PHI that Business Associate creates for or receives from Recipient or its Subsidiaries, (i) the disclosure date, (ii) the name and member or other policy identification number of the person about whom the disclosure is made, (iii) the name and (if known) address of the person or entity to whom Business Associate made the disclosure, (iv) a brief description of the PHI disclosed, and (v) a brief statement of the purpose of the disclosure (items i-v, collectively, the “disclosure information”). For repetitive disclosures Business Associate makes to the same person or entity (including Recipient or its Subsidiaries) for a single purpose, Business Associate may provide a) the disclosure information for the first of these repetitive disclosures, (b) the frequency, periodicity or number of these repetitive disclosures and (c) the date of the last of these repetitive disclosures. Business Associate will make this disclosure information available to Recipient or its Subsidiaries promptly upon Recipient’s or its Subsidiaries’ request.

2. Exceptions from Disclosure Tracking. Business Associate need not record disclosure information or otherwise account for disclosures of PHI that this Addendum or Recipient or the relevant Subsidiary in writing permits or requires (i) for the purpose of Recipient’s or its Subsidiaries’ treatment activities, payment activities, or health care operations, (ii) to the individual who is the subject of the PHI disclosed or to that individual’s personal representative; (iii) to persons involved in that individual’s health care or payment for health care; (iv) for notification for disaster relief purposes, (v) for national security or intelligence purposes, (vi) to law enforcement officials or correctional institutions regarding inmates; or (vii) pursuant to an authorization; (viii) for disclosures

of certain PHI made as part of a Limited Data Set; (ix) for certain incidental disclosures that may occur where reasonable safeguards have been implemented; and (x) for disclosures prior to April 14, 2003.

3. Disclosure Tracking Time Periods. Business Associate must have available for Recipient and its Subsidiaries the disclosure information required by this section for the 6 years preceding Recipient’s or its Subsidiaries’ request for the disclosure information (except Business Associate need have no disclosure information for disclosures occurring before April 14, 2003).

VI. Additional Business Associate Provisions

A. Reporting of Breach of Privacy Obligations. Business Associate will provide written notice to whichever of the Recipient or its Subsidiary for which the relevant PHI was created or from which the relevant PHI was received of any use or disclosure of PHI that is neither permitted by this Addendum nor given prior written approval by Recipient or the relevant Subsidiary promptly after Business Associate learns of such non-permitted use or disclosure. Business Associate’s report will at least:

- (i) Identify the nature of the non-permitted use or disclosure;
- (ii) Identify the PHI used or disclosed;
- (iii) Identify who made the non-permitted use or received the non-permitted disclosure;
- (iv) Identify what corrective action Business Associate took or will take to prevent further non-permitted uses or disclosures;
- (v) Identify what Business Associate did or will do to mitigate any deleterious effect of the non-permitted use or disclosure; and
- (vi) Provide such other information, including a written report, as Recipient or the relevant Subsidiary may reasonably request.

B. Amendment. Upon the effective date of any final regulation or amendment to final regulations promulgated by the U.S. Department of Health and Human Services with respect to PHI, including, but not limited to the HIPAA privacy and security regulations, this Addendum and the Agreement will automatically be amended so that the obligations they impose on Business Associate remain in compliance with these regulations.

In addition, to the extent that new state or federal law requires changes to Business Associate’s obligations under this Addendum, this Addendum shall automatically be amended to include such additional obligations, upon notice by Recipient or its Subsidiaries to Business Associate of such obligations. Business Associate’s continued performance of services under the Agreement shall be deemed acceptance of these additional obligations.

C. Audit and Review of Policies and Procedures. Business Associate agrees to provide, upon Recipient request, access to and copies of any policies and procedures developed or utilized by Business Associate regarding the protection of PHI. Business Associate agrees to provide, upon Recipient’s request, access to Business Associate’s internal practices, books, and records, as they relate to Business Associate’s services, duties and obligations set forth in this Addendum and the Agreement(s) under which Business Associate provides services and / or products to or on behalf of Recipient or its Subsidiaries, for purposes of Recipient’s or its Subsidiaries’ review of such internal practices, books, and records.

SCHEDULE C

CEDING COMMISSION

The Ceding Commission shall be the sum of the following:

1. an amount equal to the excess of the Total SAP Ceded Reserves over Total GAAP Ceded Reserves measured as of the close of business on the day immediately preceding the Inception Date (which amount may be negative);
2. an amount equal to the unamortized PVFP intangible asset balance of the Company (excluding any related mark to market adjustments for SFAS 115 requirement) with respect to the Reinsured Contracts as measured as of the close of business on the day immediately preceding the Inception Date, determined in accordance with GAAP;
3. an amount equal to the unamortized deferred acquisition costs of the Company (excluding any related mark to market adjustments for SFAS 115 requirement) with respect to the Reinsured Contracts as measured as of the close of business on the day immediately preceding the Inception Date, determined in accordance with GAAP; and
4. an amount equal to the excess of the GAAP book value of the Assets (excluding any related mark to market adjustments for SFAS 115 requirement) over the SAP book value of the Assets measured as of the close of business on the day immediately preceding the Inception Date (which amount may be negative).

SCHEDULE D

ASSETS

Transfer Document			From		To		Nature of Transfer		Cash Map Cross-Reference	Schedule	
GECA SS Coinsurance			GECA		UFLIC		Treaty		(90)	Schedule D	
Called Securities*	Parent Name	Issuer Name	1Q04 Cusip	1Q04 Tax lot	12/31/03 Local Par	12/31/03 GAAP BV (incl attached derivative)	12/31/03 Accrued Interest	12/31/03 GAAP BV + Accrued Interest	12/31/03 STAT BV (incl attached derivative)	12/31/03 Accrued Interest	12/31/03 STAT BV + Accrued Interest
[Individual Asset Details Omitted]											
<b>Asset Sub Total</b>						<b>4,066,936,562.98</b>	<b>63,939,042.73</b>	<b>4,130,875,605.71</b>	<b>4,064,372,934.13</b>	<b>63,939,042.73</b>	<b>4,128,311,976.86</b>
Cash									8,381,001.99		8,381,001.99
<b>Total</b>									<b>4,072,753,936.12</b>		<b>4,136,692,978.85</b>

\* These Securities will not be transferred. The "Call Amount" will be settled in cash

SCHEDULE E

EXPENSE ALLOWANCES

The "Annual Expense Reimbursement Factor" used to calculate the Expense Allowance is as follows:

Policy Maintenance Factor            \$23.84 per Policy

Such Annual Expense Reimbursement Factor will be adjusted (i) for the year beginning January 1, 2005 and, thereafter, every three (3) years during the term of this Agreement based on a triennial cost/time study prepared in accordance with the methodology set forth below (the "Triennial Study") and (ii) for the years between the Triennial Studies based on a report setting forth the Annual Expense Reimbursement Factor prepared in accordance with the methodology set forth below (the "Annual Expense Reimbursement Factor Report").

(a) Triennial Study. As soon as practicable (and in any event within sixty (60) days) prior to January 1, 2005 and prior to the beginning of every third calendar year thereafter during the term of this Agreement, the Company shall cause to be prepared and delivered to the Reinsurer the Triennial Study which sets forth the Annual Expense Reimbursement Factor for the next calendar year, together with all supporting data used in preparing the Triennial Study and work papers, in reasonable detail, setting forth the determination of such Annual Expense Reimbursement Factors based on such Triennial Study (such documents, together with the Triennial Study, the "Triennial Study Documents").

(b) Annual Expense Reimbursement Factor Report. As soon as practicable (and in any event within thirty (30) days) prior to January 1, 2006 and prior to the beginning of each calendar year thereafter in which no Triennial Study is prepared, the Company shall cause to be prepared and delivered to the Reinsurer the Annual Expense Reimbursement Factor Report, together with all supporting data used in preparing the Annual Expense Reimbursement Factor Report and work papers, in reasonable detail, setting forth the determination of such Annual Expense Reimbursement Factor for the next calendar year (such documents, together with the Annual Expense Reimbursement Factor Report, the "Annual Expense Reimbursement Factor Documents").

(c) Methodology. At the time of the Triennial Study, historical costs (to include costs directly related to maintaining and administering policies, processing claims and reporting results) will be determined for the Policy Maintenance Factor identified above. For a given Annual Expense Reimbursement Factor the identified costs will be divided by the total historical number of units of measure for both the Reinsured Contracts and the retained block of business to derive an historical cost per unit. The historical cost per unit will be used as a prospective cost per unit for the next calendar year.

---

For the two succeeding years in the period between the Triennial Studies the historical dollar amounts by Policy Maintenance Factor will be adjusted (rolled forward) for current year cost changes agreed to by the Reinsurer and the Company (in accordance with the procedures set forth below). This rolled forward historical cost will then be divided by the total historical number of units for the current period to determine a prospective cost per unit for the next calendar year.

An additional adjustment, positive or negative, to the prospective cost per unit determined by either the Triennial Study or the two succeeding years may be negotiated between the parties. The additional adjustment is for special projected costs or benefits of productivity, process improvements, inflation, loss of scale, and any other cost variation which was not included in the prior Triennial Study or the succeeding roll forward.

The combined prospective unit cost and additional adjustment is the Annual Expense Reimbursement Factor. The Expense Allowance will be determined quarterly and billed to the Reinsurer in three equal installments during the quarter at the end of the month. Each installment will be determined by multiplying the actual number of units at the beginning of the quarter covered by this Agreement times the Annual Expense Reimbursement Factor (divided by twelve).

(d) Review of Documents. Following the delivery of the Annual Expense Reimbursement Factor Documents or the Triennial Study Documents, as applicable, the Company shall (i) provide to the Reinsurer or its designated representative copies of such additional work papers and other documents relating to its preparation of the Annual Expense Reimbursement Factor Report or Triennial Study, as applicable, as the Reinsurer or its designated representative may reasonably request, including, without limitation, claims files and practices and (ii) cooperate with, and make its personnel and facilities reasonably available to, the Reinsurer and the Reinsurer's designated representative for the purpose of providing such other information as the Reinsurer or the Reinsurer's designated representative may reasonably request concerning Annual Expense Reimbursement Factor Documents or the Triennial Study Documents, as applicable, and the calculation of the Annual Expense Reimbursement Factor.

(e) Notice of Disagreement. In the event that the Reinsurer has any disagreement with any of the Annual Expense Reimbursement Factor Documents or the Triennial Study Documents, as applicable, the Reinsurer shall give written notice of all such disagreements (a "Notice of Disagreement") to the Company within thirty (30) days after the Annual Expense Reimbursement Factor Documents or the Triennial Study Documents, as applicable, are delivered to the Reinsurer. Any Notice of Disagreement shall set forth each item in disagreement and shall provide reasonable specificity as to the basis for each disagreement and shall specify the total adjustment to the Annual Expense Reimbursement Factor, as proposed by the Company as a result of such items in disagreement.

(f) Dispute Resolution. If the Reinsurer does not deliver a Notice of Disagreement to the Company within such thirty (30) day period, the Annual Expense Reimbursement Factor Documents and the Triennial Study Documents, as applicable, shall be final and binding upon

---

the parties hereto and shall constitute the final calculation of the Annual Expense Reimbursement Factor for the next calendar year. If the Reinsurer delivers a Notice of Disagreement to the Company within such thirty (30) day period, the parties shall (and shall cause their respective designated representatives to) negotiate in good faith to resolve all disagreements as promptly as practicable. Any changes in the Annual Expense Reimbursement Factor, if any, that are agreed to by the Company and the Reinsurer within sixty (60) days of the aforementioned delivery of the Annual Expense Reimbursement Factor Documents or the Triennial Study Documents, as applicable, shall be incorporated into a final calculation of the Annual Expense Reimbursement Factor. If the parties and their respective designated representatives are unable to resolve all disagreements within sixty (60) days of delivery of the Annual Expense Reimbursement Factor Documents or the Triennial Study Documents, as applicable, then all unresolved disagreements will be submitted within ten (10) days after the end of such sixty (60) day period for resolution in accordance herewith to an independent certified public accounting firm of national standing and reputation (the "Accounting Firm") mutually acceptable to the Company and the Reinsurer. The parties shall cooperate in good faith with the Accounting Firm and shall give the Accounting Firm access to all data and other information requested by the Accounting Firm for purposes of such resolution. The Accounting Firm shall, within thirty (30) days after its engagement, deliver to the Company and the Reinsurer a definitive calculation of the Annual Expense Reimbursement Factor, which shall be final and binding upon the parties hereto and shall be so reflected in the calculation of the Annual Expense Reimbursement Factor. The Company and the Reinsurer shall each pay one-half of the fees and expenses of the Accounting Firm.

(g) Expense Allowance Pending Resolution. In the event of a dispute with respect to any Annual Expense Reimbursement Factor for the next succeeding Calendar year, the Company and the Reinsurer agree that the Annual Expense Reimbursement Factor then in effect under this Agreement shall remain in effect pending resolution of such dispute and adjustment, if any, in accordance with the dispute resolution procedure set forth in paragraph (f) above.

---

SCHEDULE F—PART I

INITIAL REPORT

1. Total SAP Ceded Reserves

Gross Policy Reserves calculated in accordance with SAP with respect to the reinsured risks.

\$ \_\_\_\_\_

2. Ceding Commission:		
A. Excess SAP Ceded Reserves over GAAP Ceded Reserves:		
1) Total SAP Ceded Reserves	\$ _____	
2) Total GAAP Ceded Reserves:	\$ _____	
Gross Policy Reserves calculated in accordance with GAAP with respect to the reinsured risks.	\$ _____	\$ _____
Excess SAP Reserves over GAAP Reserves (A1-A2)		
B. Present Value of Future Profits (PVFP)		\$ _____
C. Deferred Acquisition Costs (DAC)		\$ _____
D. Asset Book Value Difference — Measured as of close of business the day preceding the Inception Date		
1) Asset Book Value (GAAP basis)	\$ _____	
2) Asset Book Value (SAP basis)	\$ _____	
Excess Asset Book Value (D1-D2)		\$ _____
Total Ceding Commission (A+B+C+D)		\$ _____
3. Accrued Interest on Assets as of the day before Inception Date		\$ _____
4. Investment Cash Flows on the Assets from the Inception Date through the Closing Date		\$ _____
Net Due Reinsurer (1-2—3+4)		\$ _____

SCHEDULE F—PART II

QUARTERLY REPORT

-	
1. Benefits	\$ _____
2. Withdrawals from Claims Settlement Account	\$ _____
3. Expense Allowance	\$ _____
I. Quarterly Settlement Amount (-1+2-3)	\$ _____
Net Due to (from) Reinsurer	\$ _____

SCHEDULE F—PART III

ANNUAL REPORT

1. Benefits	\$ _____
2. Withdrawals from Claims Settlement Account	\$ _____
3. Expense Allowance	\$ _____
I. Quarterly Settlement Amount (-1+2-3)	\$ _____
Net Due to (from) Reinsurer (I-II)	\$ _____

SCHEDULE G

FORM OF TRUST AGREEMENT

SCHEDULE H

ELIGIBLE SECURITIES

Assets of the types for which an Illinois-domiciled life insurance company could obtain full statutory reserve credit under statutory accounting practices prescribed or permitted by the Director of Insurance of the State of Illinois.

---

## COINSURANCE AGREEMENT

between

GE CAPITAL LIFE ASSURANCE COMPANY OF NEW YORK

and

UNION FIDELITY LIFE INSURANCE COMPANY

Dated as of April 15, 2004

## TABLE OF CONTENTS

<a href="#">ARTICLE I</a>	<a href="#">DEFINITIONS</a>
<a href="#">ARTICLE II</a>	<a href="#">COVERAGE</a>
<a href="#">ARTICLE III</a>	<a href="#">ADMINISTRATION; GENERAL PROVISIONS</a>
<a href="#">ARTICLE IV</a>	<a href="#">CLAIMS SETTLEMENT ACCOUNT; CLAIMS</a>
<a href="#">ARTICLE V</a>	<a href="#">REINSURANCE ASSET TRANSFER; CEDING COMMISSION</a>
<a href="#">ARTICLE VI</a>	<a href="#">EXPENSE ALLOWANCES</a>
<a href="#">ARTICLE VII</a>	<a href="#">ACCOUNTING AND SETTLEMENT</a>
<a href="#">ARTICLE VIII</a>	<a href="#">DURATION AND TERMINATION</a>
<a href="#">ARTICLE IX</a>	<a href="#">INSOLVENCY</a>
<a href="#">ARTICLE X</a>	<a href="#">CREDIT FOR REINSURANCE</a>
<a href="#">ARTICLE XI</a>	<a href="#">REINSURANCE SECURITY</a>
<a href="#">ARTICLE XII</a>	<a href="#">DEFERRED ACQUISITION COSTS</a>
<a href="#">ARTICLE XIII</a>	<a href="#">DISPUTE RESOLUTION</a>
<a href="#">ARTICLE XIV</a>	<a href="#">MISCELLANEOUS PROVISIONS</a>

SCHEDULES

<a href="#">SCHEDULE A</a>	=	<a href="#">POLICY FORMS</a>
<a href="#">SCHEDULE B</a>	=	<a href="#">FORM OF ADMINISTRATIVE SERVICES AGREEMENT</a>
<a href="#">SCHEDULE C</a>	=	<a href="#">CEDING COMMISSION</a>
<a href="#">SCHEDULE D</a>	=	<a href="#">ASSETS</a>
<a href="#">SCHEDULE E</a>	=	<a href="#">EXPENSE ALLOWANCES</a>
<a href="#">SCHEDULE F - PART I</a>	=	<a href="#">INITIAL REPORT</a>
<a href="#">SCHEDULE F - PART II</a>	=	<a href="#">QUARTERLY REPORT</a>
<a href="#">SCHEDULE F - PART III</a>	=	<a href="#">ANNUAL REPORT</a>
<a href="#">SCHEDULE G</a>	=	<a href="#">FORM OF TRUST AGREEMENT</a>
<a href="#">SCHEDULE H</a>	=	<a href="#">ELIGIBLE SECURITIES</a>

i

COINSURANCE AGREEMENT

This Coinsurance Agreement, dated as of April 15, 2004 (this "Agreement"), is made and entered into by and between GE Capital Life Assurance Company of New York, an insurance company organized under the laws of the State of New York (the "Company"), and Union Fidelity Life Insurance Company, an insurance company organized under the laws of the State of Illinois (the "Reinsurer"). Defined terms used herein are defined below.

The Company and the Reinsurer mutually agree to reinsure the risks described in this Agreement under the terms and conditions stated herein. This Agreement is an indemnity coinsurance agreement solely between the Company and the Reinsurer, and the performance of the obligations of each party under this Agreement shall be rendered solely to the other party. In no instance shall anyone other than the Company or the Reinsurer have any rights under this Agreement. The Company shall be and shall remain the only party hereunder that is liable to any insured, contract holder, policyholder, claimant or beneficiary under any insurance policy or contract reinsured hereunder.

This Agreement is entered into in connection with an intercompany reorganization among the Company, the Reinsurer and certain of their Affiliates.

## DEFINITIONS

1.1. Definitions. As used in this Agreement, the following terms shall have the following meanings (definitions are applicable to both the singular and the plural forms of each term defined in this Article):

“Accounting Period” means calendar quarter, except that the last Accounting Period shall be the period commencing with the first day of the calendar quarter in which the Termination Date falls and ending with the Termination Date.

“Affiliate” means any other Person that directly or indirectly controls, is controlled by, or is under common control with, the first Person. “Control” (including the terms, “controlled by” and “under common control with”) means the possession, directly or indirectly, of the power to direct or cause the direction of the management and policies of a Person, whether through the ownership of voting securities, by contract or credit arrangement, as trustee or executor, or otherwise.

“Agreement” shall have the meaning specified in the first paragraph of this Agreement.

“Annual Report” shall have the meaning specified in Section 7.4.

“Applicable Law” means any federal, state, local or foreign law (including common law), statute, ordinance, rule, regulation, order, writ, injunction, judgment, permit, governmental agreement or decree applicable to a Person or any of such Person’s subsidiaries,

---

properties, assets, or to such Person’s officers, directors, managing directors, employees or agents in their capacity as such.

“Assets” shall have the meaning specified in Section 5.3(a).

“Assignment Letter Agreement” means the letter agreement dated the date hereof among General Electric Capital Corporation, a Delaware corporation, the Reinsurer, the Company and certain affiliates of the Company relating to the assignment by General Electric Capital Corporation of the Capital Maintenance Agreement.

“Benefits” shall have the meaning specified in Section 2.3(a).

“Business Day” means any day other than a Saturday, Sunday or other day on which commercial banks in the States of Illinois or Virginia are required or authorized by law to be closed.

“Capital Maintenance Agreement” means the Capital Maintenance Agreement between General Electric Capital Corporation, a Delaware corporation, and the Reinsurer.

“Ceding Commission” shall have the meaning specified in Section 5.2.

“Claims Settlement Account” shall have the meaning specified in Section 4.1(a).

“Closing Date” means April 15, 2004.

“Code” means the Internal Revenue Code of 1986, as amended.

“Company Account” shall have the meaning specified in Section 11.1(e).

“CPR” shall have the meaning specified in Section 13.3.

“CPR Arbitration Rules” shall have the meaning specified in Section 13.4(a).

“Dispute” shall have the meaning specified in Section 13.1(a).

“Eligible Securities” shall have the meaning specified in Section 11.1(c).

“Expense Allowance” shall have the meaning specified in Section 6.1.

“Extra Contractual Liabilities” means all liabilities for damages (including compensatory, consequential, exemplary, punitive, bad faith or similar or other damages) which relate to the marketing, sale, underwriting, issuance, delivery, cancellation or administration of the Reinsured Contracts, including liability arising out of or relating to any alleged or actual acts, errors or omissions by the Company or its agents, whether intentional or otherwise, with respect to any of the Reinsured Contracts, including (A) any alleged or actual reckless conduct or bad faith in connection with the handling of any claim arising out of or under Reinsured Contracts, or (B) the marketing, sale, underwriting, issuance, delivery, cancellation or administration of any of the Reinsured Contracts.

---

“Force Majeure” shall have the meaning specified in Section 3.7(b)(iii).

“Funding Requirement” shall have the meaning specified in Section 11.1(e).

“GAAP” means U.S. generally accepted accounting principles consistently applied.

“Governmental Authority” means any foreign or national government, any state or other political subdivision thereof, and any entity exercising executive, legislative, judicial, regulatory or administrative functions of or pertaining to government.

“Inception Date” shall have the meaning specified in Section 2.1.

“Initial Notice” shall have the meaning specified in Section 13.2.

“Initial Reinsurance Premium” shall have the meaning specified in Section 5.1.

“Initial Report” shall have the meaning specified in Section 7.1.



“Insolvency Fund” means any guarantee fund, insolvency fund, plan, pool, association, fund or other arrangement, however denominated, established or governed, which provides for any assessment of or payment or assumption by the Company of part or all of any claim, debt, charge, fee or other obligation of an insurer or reinsurer, or its successors or assigns, which has been declared by any competent authority to be insolvent, or which is otherwise deemed unable to meet any claim, debt, charge, fee or other obligation in whole or in part.

“Minimum Claims Settlement Amount” shall have the meaning specified in Section 4.1(b).

“Person” means any natural person, firm, limited liability company, general partnership, limited partnership, joint venture, association, corporation, trust, Governmental Authority or other entity.

“Quarterly Report” shall have the meaning specified in Section 7.2.

“Quarterly Settlement” shall have the meaning specified in Section 5.3(a).

“RBC Reporting Letter Agreement” means the letter agreement dated the date hereof among the Company, the Reinsurer and certain affiliates of the Company relating to the Reinsurer’s requirement to provide periodic certifications and reports regarding the Reinsurer’s risk based capital ratio.

“Reinsured Contracts” means the structured settlements immediate annuity contracts issued by the Company and recorded in the Company’s valuation system on or prior to December 3, 2003 or reinsured by the Company under reinsurance agreements in effect prior to January 1, 2004, and, in each case, written on the policy forms described in Schedule A.

“Reinsured Risks” shall have the meaning specified in Section 2.1.

---

3

“Response” shall have the meaning specified in Section 13.2.

“SAP” means statutory accounting practices prescribed or permitted by the Insurance Department of the State of New York.

“Tax DAC” means specified policy acquisition expenses capitalized and amortized under section 848 of the Code.

“Termination Date” means the effective date of any termination of this Agreement as provided in Article VIII.

“Termination Letter Agreement” means the letter agreement dated the date hereof among the Company, the Reinsurer and certain affiliates of the Company relating to the rescission of this Agreement upon the failure of certain events to occur after the date hereof.

“Total SAP Ceded Reserves” means, as of any given date, the gross policy reserves of the Company calculated in accordance with SAP with respect to the Reinsured Risks.

“Total GAAP Ceded Reserves” means, as of any given date, the gross policy reserves of the Company calculated in accordance with GAAP with respect to the Reinsured Risks.

“Trust Account” shall have the meaning set forth in Section 11.1(a).

“Trust Agreement” shall have the meaning set forth in Section 11.1(a).

“Trustee” shall have the meaning set forth in Section 11.1(a).

## ARTICLE II

### COVERAGE

2.1. Coverage. Upon the terms and subject to the conditions and other provisions of this Agreement, as of 12:01 a.m. Eastern Time on January 1, 2004 (the “Inception Date”), the Company hereby cedes to the Reinsurer, and the Reinsurer hereby agrees to indemnify the Company for, one hundred percent (100%) of the liability incurred by the Company for Benefits on or after the Inception Date (the “Reinsured Risks”).

2.2. Conditions. (a) If the Company’s liability under any of the Reinsured Contracts is changed because of changes made on or after the Inception Date in the terms and conditions of the Reinsured Contracts (including to any contract riders or endorsements thereto) that are required due to changes in Applicable Law, the Reinsurer will share in the change proportionately to the coinsurance share hereunder and the Company and the Reinsurer will make all appropriate adjustments to amounts due each other under this Agreement.

(b) Except as otherwise set forth in paragraph (a) above, no changes, amendments or modifications made on or after the Inception Date in the terms and conditions of the

---

4

Reinsured Contracts which adversely affect the liability of the Reinsurer hereunder shall be covered hereunder without the prior written approval of such changes, amendments or modifications by the Reinsurer, which approval shall not be unreasonably withheld or delayed. In the event that any such changes, amendments or modifications are made in any Reinsured Contract without the prior written approval of the Reinsurer, this Agreement will cover liability incurred by the Company for Benefits as if the non-approved changes, amendments or modifications had not been made.

2.3. Benefits. (a) Subject to the provisions of Sections 2.2, 2.3(b) and (c) and the terms and conditions of this Agreement, “Benefits” shall mean the actual benefits payable by the Company under the Reinsured Contracts.

(b) Any Extra Contractual Liabilities resulting from actions of the Company or its agents or reinsured by the Company under the Reinsured Contracts shall be treated as a Benefit payable for the purposes of this Agreement to the extent permitted by state law, except to the extent that any such Extra Contractual Liabilities are attributable to the conduct of the Company in the administration of the Reinsured Contracts on or after the Inception Date, other than actions taken by the Company at the written request or direction of the Reinsurer.

(c) This Agreement excludes all liability arising by contract, operation of law, or otherwise from the Company’s participation or membership, whether voluntary or involuntary, in any Insolvency Fund.

2.4. Territory. The territorial limits of this Agreement shall be identical with those of the Reinsured Contracts.

2.5. Ceded Reinsurance. Subsequent to the Inception Date, the Company will not enter into any reinsurance arrangements with respect to the Reinsured Contracts without the prior written consent of the Reinsurer, in its sole discretion.

### ARTICLE III

#### ADMINISTRATION; GENERAL PROVISIONS

3.1. Contract Administration. (a) Subject to Section 3.7, the Company shall provide policyholder and claims servicing with respect to the Reinsured Contracts in accordance with the terms hereof. All Benefits paid by the Company shall be binding upon the Reinsurer; provided, however, that such Benefits are within the terms, conditions and limitations of the Reinsured Contracts. The Company shall provide policyholder and claims servicing with respect to the Reinsured Contracts (including the administration of claims for Benefits thereunder) in good faith and with the care, skill, prudence and diligence of a person experienced in administering structured settlement business. The Company shall provide policyholder and claims servicing with respect to the Reinsured Contracts, (i) in accordance with the terms of the Reinsured Contracts, (ii) in accordance with the applicable terms of this Agreement, (iii) in compliance with Applicable Law and, subject to the foregoing, (iv) in the same manner as it conducts its own business not subject to this Agreement and (v) in accordance with the Company's administrative performance standards in effect on the date hereof, with such revisions

5

---

to such standards as are no less favorable to the Reinsurer than such standards. Notwithstanding the foregoing, the parties may, from time to time, mutually develop specific and/or different standards for providing such services with respect to the Reinsured Contracts.

(b) The Company may subcontract for the performance of any policyholder or claims servicing service or services with respect to the Reinsured Contracts to (i) an Affiliate or (ii) any other Person with the prior written consent of the Reinsurer, such consent not to be unreasonably withheld; provided, that the Company also subcontracts for such service or services for its own structured settlement annuities business not subject to this Agreement to such subcontractor; and provided, further, that no such subcontracting shall relieve the Company from any of its obligations or liabilities hereunder, and the Company shall remain responsible for all obligations or liabilities of such subcontractor with regards to the providing of such service or services as if provided by the Company.

3.2. Claims Settlements. The Company agrees that it will provide prompt notice to the Reinsurer of its intention to contest, compromise or litigate a claim with respect to a Reinsured Contract, along with copies of all pleadings and reports of investigation with respect thereto. The Reinsurer shall have the right, at its own expense, to participate jointly with the Company in the investigation, adjustment or defense of such claims. In addition, in the event that litigation arises against the Company in connection with a claim which seeks damages in excess of \$1 million or other remedies deemed material to the Reinsurer, the Reinsurer may, upon written notice to the Company, assume the defense thereof with counsel selected by the Reinsurer and reasonably satisfactory to the Company. If the Reinsurer assumes such defense, the Company shall have the right, at its own expense, to participate jointly with the Reinsurer in the defense thereof. If the Reinsurer assumes the defense of litigation, the Reinsurer shall not settle such litigation without the Company's prior written consent (which consent shall not be unreasonably withheld or delayed) unless (i) there is no finding or admission of any violation of law or any violation of the rights of any Person, (ii) such settlement would not reasonably be expected to have material adverse precedential consequences to the Company and (iii) the sole relief provided is monetary damages that are paid in full by the Reinsurer.

3.3. Inspection. The Company shall keep accurate and complete records, files and accounts of all transactions and matters with respect to the Reinsured Contracts and the administration hereof in accordance with Applicable Law and its record management practices in effect from time to time for the Company's insurance business not covered by this Agreement. The Reinsurer and its designated representatives may upon reasonable notice inspect, at the offices of the Company where such records are located, the papers and any and all other books or documents of the Company reasonably relating to this Agreement, including the Reinsured Contracts and the administration thereof by the Company (including compliance with the provisions of Section 3.1), and shall have access to appropriate employees and representatives of the Company, in each case during normal business hours for such period as this Agreement is in effect or for as long thereafter as the Company seeks performance by the Reinsurer pursuant to the terms of this Agreement or the Reinsurer reasonably needs access to such records for regulatory, tax or similar purposes. The information obtained shall be used only for purposes relating to the transactions contemplated under this Agreement.

6

---

3.4. Errors and Omissions. If any delay, omission, error or failure to pay amounts due or to perform any other act required by this Agreement is unintentional and caused by misunderstanding or oversight, the Company and the Reinsurer will adjust the situation to what it would have been had the misunderstanding or oversight not occurred. The party first discovering such misunderstanding or oversight, or an act resulting from such misunderstanding or oversight, will notify the other party in writing promptly upon discovery thereof, and the parties shall act to correct such misunderstanding or oversight within twenty (20) Business Days of such other party's receipt of such notice. However, this Section shall not be construed as a waiver by either party of its right to enforce strictly the terms of this Agreement.

3.5. Age, Sex and Other Adjustments. If the Company's liability under any of the Reinsured Contracts is changed because of a misstatement of age or sex or any other material fact, the Reinsurer will share in the change proportionately to the coinsurance share hereunder and the Company and the Reinsurer will make all appropriate adjustments to amounts due each other under this Agreement.

3.6. Setoff. Any debts or credits, matured or unmatured, in favor of or against either the Company or the Reinsurer with respect to this Agreement are deemed mutual debts or credits, as the case may be, and shall be setoff from any amounts due to the Company or the Reinsurer hereunder, as the case may be, and only the net balance shall be allowed or paid.

3.7. Administration by Reinsurer. (a) At any time from and after the fifteenth (15th) anniversary of the Inception Date, the Reinsurer shall have the right to assume from the Company the administration of the Reinsured Contracts, provided that the Reinsurer provides twelve (12) months prior written notice of such assumption, which notice may be given as early as the fourteenth (14th) anniversary of the Inception Date to take effect as of the fifteenth (15th) anniversary of the Inception Date. The Reinsurer shall bear all transition costs associated with an assumption of the administration of the Reinsured Contracts pursuant to this paragraph (a) of this Section 3.7.

(b) In addition to the provisions of Section 3.7(a), the Reinsurer shall have the right, upon written notice to the Company to assume from the Company the administration of the Reinsured Contracts upon the occurrence of any of the following events:

- (i) A voluntary or involuntary proceeding is commenced in any jurisdiction by or against the Company for the purpose of conserving, rehabilitating or liquidating the Company;
- (ii) There is a material breach by the Company of any material term or condition of this Article III that is not cured by the Company within thirty (30) days after receipt of written notice from the Reinsurer of such breach or act (provided that the Reinsurer shall not have the right to assume such administration (A) for so long as the Company is making a good faith effort to cure such a breach, not to exceed an additional one hundred eighty (180) days or (B) during the pendency of any dispute resolution proceedings as set forth in Article XIII regarding an alleged material breach); or

(iii) The Company is unable to perform the services required under this Article III for a period of thirty (30) consecutive days for any reason, other than as a result of a Force Majeure, it being understood that nothing in this Section 3.7(b)(iii) shall relieve the Company from its administrative responsibilities under this Agreement. For purposes of this Agreement "Force Majeure" means any acts or omissions of any civil or military authority, acts of God, acts or omissions of the Reinsurer, fires, strikes or other labor disturbances, equipment failures, fluctuations or non-availability of electrical power, heat, light, air conditioning or telecommunications equipment, or any other act, omission or occurrence beyond the Company's reasonable control, irrespective of whether similar to the foregoing enumerated acts, omissions or occurrences.

(c) The Company shall bear all transition costs associated with an assumption of the administration of the Reinsured Contracts pursuant to Section 3.7(b).

(d) In the event of the Reinsurer's assumption of the administration of the Reinsured Contracts, the Reinsurer and the Company shall enter into an administrative services agreement in the form attached hereto as Schedule B and the provisions of Article VI shall become inoperative.

#### ARTICLE IV

##### CLAIMS SETTLEMENT ACCOUNT; CLAIMS

4.1. Claims Settlement Account. (a) On the Closing Date, the Reinsurer shall establish a separate bank account (the "Claims Settlement Account") in its own name for the payment of Benefits and shall authorize two signatories who shall be representatives of the Company and approved by the Reinsurer in writing to issue drafts in the name of the Reinsurer and showing the identity of the Company. The Reinsurer shall fund such account for payment of Benefits in accordance with the provisions of Section 4.1(b). Any interest earned on the Claims Settlement Account shall belong to the Reinsurer. The Claims Settlement Account shall be administered by the Company in a fiduciary capacity and shall be used solely by the Company to make payments of Benefits in accordance with the terms of this Agreement.

(b) The Reinsurer shall deposit \$2 million in the Claims Settlement Account on the Closing Date and shall thereafter fund the Claims Settlement Account on or before the fifth (5th) day of each month in amounts agreed by the Company and the Reinsurer from time to time in amounts sufficient to provide funds to the Company for the payment of Benefits during the next thirty (30) days, or such other amount as may be mutually agreed by the parties (such initial deposit amount and each minimum funding amount as agreed from time to time shall be referred to as a "Minimum Claims Settlement Amount"). In addition, the Reinsurer shall deposit to the Claims Settlement Account such additional amounts as may be required to keep the balance of such account above zero at all times. In consideration of the Reinsurer providing the Claims Settlement Account arrangement, the Company agrees that it shall apply funds in the

Claims Settlement Account against the Reinsurer's liability under this Agreement until such funds are exhausted.

(c) The Company shall keep true and complete records, in accordance with Applicable Law and its record management practices in effect from time to time for the Company's insurance business not covered by this Agreement, clearly recording the deposits in and withdrawals from the Claims Settlement Account, including records relating to the payment of Benefits from the Claim Settlement Account. The Company will make available to the Reinsurer or its designated representative, or shall furnish to the Reinsurer or its designated representative, upon request of the Reinsurer or its designated representative, copies of all such records. All copies furnished in the ordinary course of business shall be furnished by the Company at the Company's cost, which shall be included in the Expense Allowance. Any extraordinary costs reasonably incurred by the Company in response to requests from the Reinsurer shall be reimbursed by the Reinsurer.

(d) Within thirty (30) days after each calendar month (or more frequently as mutually agreed by the parties), the Company shall render a complete accounting to the Reinsurer detailing all transactions with respect to the Claims Settlement Account, in such form as agreed by the parties.

(e) The parties agree to deliver to the depository bank such depository resolutions, signature cards and other documents as may be requested of them in order to use such accounts at the depository bank in accordance with the provisions of this Article IV.

(f) Upon a termination of this Agreement pursuant to Article VIII, the Reinsurer shall close the Claims Settlement Account and any closing balance therein shall be the property of the Reinsurer. The Company's claims payment authority under this Agreement with respect to the Claims Settlement Account shall terminate immediately upon termination of this Agreement pursuant to Article VIII or the assumption by the Reinsurer of the administration of the Reinsured Contracts pursuant to Section 3.7. Upon termination of its authority to pay claims, the Company shall promptly return to the Reinsurer all unused check stock held by it in connection with this Agreement.

#### ARTICLE V

##### REINSURANCE ASSET TRANSFER; CEDING COMMISSION

5.1. Initial Reinsurance Premium. As consideration for the reinsurance by the Reinsurer of the Reinsured Risks under this Agreement, on the Closing Date the Reinsurer shall be entitled to an amount equal to one hundred percent (100%) of the Total SAP Ceded Reserves as of the close of business on the day immediately preceding the Inception Date (the "Initial Reinsurance Premium").

5.2. Ceding Commission. On the Closing Date, the Company shall be entitled to a ceding commission (the "Ceding Commission") in an amount determined in accordance with Schedule C.

5.3. Amounts Due the Parties. (a) Except as otherwise specifically provided herein, all amounts due to be paid to the Company under this Agreement shall be determined on a net basis, giving full effect to Section 3.6. The net amount due the Reinsurer from the Company on the Closing Date under Section 5.1 and Section 5.2 shall consist of (i) the investment assets (the "Assets") set forth on Schedule D, which assets have a statutory book value as of the close of business on the day immediately preceding the Inception Date equal to (A) the Initial Reinsurance Premium, less (B) the Ceding Commission, less (C) an amount equal to accrued but unpaid interest on the Assets as of the close of business on the day immediately preceding the Inception Date, plus (ii) an amount equal to the investment cash flows received on the Assets between the Inception Date and the Closing Date. The Company shall pay such net amount concurrent with its delivery of the Initial Report. Each net amount subsequently due with respect to each Accounting Period ending after the Inception Date (the "Quarterly Settlement") shall be paid in cash by the Reinsurer to the Company no later than thirty (30) days after delivery of the Quarterly Report, as applicable. Each net amount subsequently due with respect to each calendar year ending after the Inception Date as reflected on an Annual Report shall be paid in cash by the Reinsurer to the Company no later than thirty (30) days after delivery of the Annual Report.

(b) The Company shall deliver to the Reinsurer possession of the Assets and such bills of sale, endorsements, assignments and other good and sufficient instruments of conveyance and transfer in form and substance reasonably acceptable to the parties as shall be effective to vest in the Reinsurer all of the right, title and interest of the Company in and to the Assets. Delivery of the Assets shall be a condition precedent of reinsurance coverage hereunder.

## ARTICLE VI

### EXPENSE ALLOWANCES

6.1. Expense Allowance. As reimbursement for expenses incurred by the Company in the providing of policyholder and Benefit payment services with respect to the Reinsured Contracts, the Reinsurer shall pay to the Company with respect to each calendar month ending after the Inception Date, an expense allowance (each an "Expense Allowance") in an amount calculated in accordance with Schedule E, as subsequently adjusted in accordance with the methodology and procedures set forth on Schedule E.

## ARTICLE VII

### ACCOUNTING AND SETTLEMENT

7.1. Initial Report. A report shall be provided by the Company to the Reinsurer on the Closing Date providing the data required in Schedule F – Part I (the "Initial Report").

7.2. Quarterly Settlement Reports. As soon as practicable but not more than forty (40) days following each Accounting Period ending after the Closing Date (or more

10

---

frequently as mutually agreed by the parties), the Company shall supply the Reinsurer with a report that shall provide the financial data for such Accounting Period required in Schedule F – Part II (the "Quarterly Report"). For the avoidance of doubt, the first Quarterly Report will include all transactions with respect to the Reinsured Contracts occurring from the Inception Date through June 30, 2004.

7.3. Quarterly Financial Reports. As soon as practicable but not more than forty (40) days following the end of each Accounting Period ending after the Closing Date (or more frequently as mutually agreed by the parties), the Company shall supply the Reinsurer with reports related to the Reinsured Contracts as may be reasonably requested for use in connection with the preparation of the Reinsurer's SAP financial statements or other reports prepared by the Reinsurer in compliance with its internal reporting requirements. The parties shall cooperate in good faith to establish the form for the providing of such reports.

7.4. Annual Reports. Within forty-five (45) days after the end of each calendar year during the term of this Agreement (or more frequently as mutually agreed by the parties), the Company shall supply the Reinsurer with a report that shall provide the financial data for such year required in Schedule F – Part III (the "Annual Report").

7.5. Additional Reports and Updates. For so long as this Agreement remains in effect, each of the parties shall periodically furnish to the other such other reports and information as may be reasonably requested by such other party for regulatory, tax or similar purposes and reasonably available to it.

7.6. Delayed Payments. In the event that all or any portion of any payment due either party pursuant to this Agreement becomes overdue, the portion of the amount overdue shall bear interest at an annual rate equal to the then current thirty (30) day U.S. Treasury Bill discount rate on the date that the payment becomes overdue plus 200 basis points, for the period that the amount is overdue.

## ARTICLE VIII

### DURATION AND TERMINATION

8.1. Duration. Except as otherwise provided herein, this Agreement shall be unlimited in duration.

8.2. Reinsurer's Liability. The Reinsurer's liability with respect to the Reinsured Risks will terminate on the earliest of: (i) the date the Company's liability with respect to the Reinsured Risks is terminated and all amounts due the Company from the Reinsurer with respect to such Reinsured Risks are paid to the Company by or on behalf of the Reinsurer; and (ii) the date this Agreement is terminated upon the written agreement of the parties.

8.3. Notice of Termination. Upon the termination of the Reinsurer's liability with respect to the Reinsured Risks referred to in Section 8.2 above, the parties shall mutually give the Trustee written notice of their intention to terminate the Trust Account.

11

---

## ARTICLE IX

### INSOLVENCY

9.1. Payments. In the event of the insolvency of the Company, all reinsurance made, ceded, renewed or otherwise becoming effective under this Agreement shall be payable by the Reinsurer directly to the Company or to its liquidator, receiver, or statutory successor on the basis of the liability of the Company under the contracts reinsured, without diminution because of the insolvency of the Company. It is agreed and understood, however, that (i) in the event of the insolvency of the Company, the Reinsurer shall be given written notice of the pendency of a claim against the insolvent Company on a Reinsured Contract within a reasonable time after such claim is filed in the insolvency proceeding and (ii) during the pendency of such claim the Reinsurer may investigate such claim and interpose, at its own expense, in the proceeding where such claim is to be adjudicated any defenses which it may deem available to the Company or its liquidator, receiver or statutory successor.

9.2. Expenses. It is further understood that any expense thus incurred by the Reinsurer pursuant to Section 9.1 shall be chargeable, subject to court approval, against the insolvent Company as part of the expense of liquidation to the extent of a proportionate share of the benefit which may accrue to the Company solely as a result of the defense undertaken by the Reinsurer. Where two or more assuming reinsurers are involved in the same claim and a majority in interest elect to interpose defenses to such claim, the expense shall be apportioned in accordance with the terms of this Agreement as though such expense had been incurred by the Company.

## ARTICLE X

### CREDIT FOR REINSURANCE

10.1. Reinsurance Credit. Notwithstanding any other provision of this Agreement to the contrary, if the Reinsurer becomes unauthorized or otherwise

unaccredited as an insurer or reinsurer in any U.S. jurisdiction to which the Company must provide statutory statements of financial condition such that the Company will not obtain full statutory financial statement credit for reinsurance in such state for the reinsurance provided under this Agreement, the Reinsurer, upon the request of the Company, will establish, at the Reinsurer's sole cost and option, trust accounts for the benefit of the Company, letters of credit, or other acceptable alternatives necessary to permit the Company to obtain such full statutory financial statement credit for such reinsurance in all applicable jurisdictions. The Company shall cooperate with the Reinsurer to take such steps. In addition, in such event, the Reinsurer agrees to amend this Agreement and the Trust Agreement to the extent required under Applicable Law in order to provide the Company with such full statutory financial statement credit.

---

ARTICLE XI

REINSURANCE SECURITY

11.1. Trust. (a) On the Closing Date, the Reinsurer shall enter into a trust agreement in the form attached as Schedule G (the "Trust Agreement") and establish a trust account (the "Trust Account") for the benefit of the Company with respect to the Reinsured Risks with a bank (the "Trustee") designated as a Qualified United States Financial Institution by the Securities Valuation Office of the National Association of Insurance Commissioners or any successor organization or regulatory agency having similar duties.

(b) The Reinsurer agrees to deposit, and maintain in the Trust Account with respect to this Agreement, assets to be held in trust by the Trustee for the benefit of the Company as security for the payment of the Reinsurer's obligations to the Company under this Agreement.

(c) The parties agree that the assets so deposited with respect to this Agreement shall be valued according to their current statutory book value on the books of the Reinsurer and shall consist only of cash (United States legal tender), certificates of deposit (issued by a United States bank and payable in United States legal tender), and other assets of the type specified on Schedule H attached hereto ("Eligible Securities").

(d) The Reinsurer, prior to depositing assets with the Trustee, shall execute all assignments and endorsements in blank, or transfer legal title to the Trustee of all shares, obligations or any other assets requiring assignments, in order that, to the extent practicable, the Company, or the Trustee upon direction of the Company, may whenever necessary negotiate any such assets without consent or signature from the Reinsurer or any other entity. The Company recognizes that certain assets in the Trust Account will not be readily negotiable and that certain notices, opinions of counsel, representations and/or consents will be required for the Company to obtain good and marketable title to such assets.

(e) The Reinsurer and the Company agree that the assets in the Trust Account with respect to this Agreement may be withdrawn for the following purposes only:

- (i) to pay or reimburse the Company for any amount due the Company pursuant to this Agreement to the extent not so paid or reimbursed by the Reinsurer;
- (ii) to pay to the Reinsurer, in accordance with paragraph (h) below, any amounts held in the Trust Account that exceed an amount (the "Funding Requirement") equal to the sum of Total SAP Ceded Reserves and any additional reserves attributable to the Reinsured Risks that arise as a result of regulatory asset adequacy analysis requirements of the Reinsurer, less, prior to the date on which the Claims Settlement Account is closed, the Minimum Claims Settlement Amount then in effect; and
- (iii) in the event that General Electric Capital Corporation breaches its obligations under the Capital Maintenance Agreement, to fund an

---

account with the Company (the "Company Account") in an amount at least equal to the deduction, for reinsurance ceded, from the Company's liabilities ceded under this Agreement. Such amount shall include, but not be limited to, amounts for policy reserves, reserves for claims and losses incurred (including losses incurred but not reported), loss and loss adjustment expenses, and unearned premiums.

(f) In the event that the Company withdraws assets from the Trust Account for the purposes set forth in Section 11.1(e)(i) above in excess of actual amounts required to meet the Reinsurer's obligations to the Company, the Company will promptly return such excess to the Reinsurer, plus interest at an annual rate equal to the then current thirty (30) day U.S. Treasury Bill discount rate on the date of withdrawal plus 200 basis points for the period during which the amounts were held pursuant to Section 11.1(e)(i). In the event that the Company withdraws assets from the Trust Account for the purposes set forth in Section 11.1(e)(iii) above, (i) the Reinsurer shall be relieved of its obligation to maintain assets in the Trust Account pursuant to this Section 11.1 to the extent of the amount of funds held in the Company Account and (ii) the Company shall first apply the funds in the Company Account in satisfaction of the Reinsurer's liability under this Agreement until the funds in the Company Account are exhausted. In the event that the Company withdraws assets from the Trust Account for the purposes set forth in Section 11.1(e)(iii) above, promptly following the date the Reinsurer's liability with respect to the Reinsured Risks is terminated, the Company shall return to the Reinsurer any assets so withdrawn that, together with any and all interest, dividends and other earnings thereon from the date of withdrawal to the date of return, are in excess of actual amounts required to meet the Reinsurer's obligations to the Company under this Agreement.

(g) The initial deposit to the Trust Account with respect to this Agreement shall be made on the Closing Date and shall consist of assets with a statutory book value equal to the Total SAP Ceded Reserves as of the close of business on the day immediately preceding the Inception Date, less an amount of assets with a statutory book value equal to the initial Minimum Claims Settlement Amount.

(h) The aggregate statutory book value of the assets held in the Trust Account with respect to this Agreement, shall at all times be at least equal to the Funding Requirement, and shall be adjusted on a quarterly basis so as to equal the Funding Requirement. On a quarterly basis, the Company shall promptly prepare and deliver to the Reinsurer a specific statement of the Funding Requirement and the Reinsurer shall promptly prepare and deliver to the Company a specific statement of the statutory book value of the assets in the Trust Account, in each case as of the end of the quarter. If the statement shows that the Funding Requirement exceeds 100% of the balance of the Trust Account with respect to this Agreement as of the statement date, the Reinsurer shall, within ten (10) Business Days after receipt of such notice of excess, secure delivery to the Trustee of additional cash or Eligible Securities having a current statutory book value equal to such difference. If the statement shows that the Funding Requirement is less than 100% of the balance of the Trust Account with respect to this Agreement as of the statement date, the Company shall, within ten (10) Business Days after delivery of such statement to the Reinsurer, deliver a notice of withdrawal to the Trustee directing the Trustee to withdraw from the Trust Account and deliver to the Reinsurer assets from the Trust Account having a current statutory book value equal to such excess amount. In

---

addition to the foregoing, the Reinsurer shall prepare and deliver to the Company on a quarterly basis a specific statement of the market value of the assets in the Trust Account as of the end of the quarter.

ARTICLE XII

DEFERRED ACQUISITION COSTS

12.1. Tax DAC Information Sharing. To ensure consistency in their respective Tax DAC calculations for tax purposes, the Company and the Reinsurer will exchange information pertaining to the amount of net consideration under this Agreement each year. The Company will submit a schedule to the Reinsurer by February 28 of each year presenting its calculation of the net consideration for the preceding taxable year. The Reinsurer may contest the calculation by providing to the Company an alternative calculation in writing within thirty (30) days of receipt of the Company's schedule. The Company and the Reinsurer will act in good faith to resolve any differences in the schedule of calculations within thirty (30) days of receipt of the alternative calculation to ensure consistent amounts are reported on the respective tax returns for the preceding tax year.

ARTICLE XIII

DISPUTE RESOLUTION

13.1. General Provisions. (a) Any dispute, controversy or claim arising out of or relating to this Agreement or the validity, interpretation, breach or termination thereof (a "Dispute"), shall be resolved in accordance with the procedures set forth in this Article XIII, which shall be the sole and exclusive procedures for the resolution of any such Dispute unless otherwise specified below.

(b) Commencing with the request contemplated by Section 13.2, all communications between the parties or their representatives in connection with the attempted resolution of any Dispute, including any mediator's evaluation referred to in Section 13.3, shall be deemed to have been delivered in furtherance of a Dispute settlement and shall be exempt from discovery and production, and shall not be admissible in evidence for any reason (whether as an admission or otherwise), in any arbitral or other proceeding for the resolution of the Dispute.

(c) In connection with any Dispute, the parties expressly waive and forego any right to (i) punitive, exemplary, statutorily-enhanced or similar damages in excess of compensatory damages, and (ii) trial by jury.

(d) The specific procedures set forth below, including but not limited to the time limits referenced therein, may be modified by agreement of the parties in writing.

15

---

(e) All applicable statutes of limitations and defenses based upon the passage of time shall be tolled while the procedures specified in this Article XIII are pending. The parties will take such action, if any, required to effectuate such tolling.

13.2. Consideration by Senior Executives. If a Dispute is not resolved in the normal course of business at the operational level, the parties shall attempt in good faith to resolve such Dispute by negotiation between executives who hold, at a minimum, the office of President and CEO of the respective business entities involved in such Dispute. Either party may initiate the executive negotiation process by providing a written notice to the other (the "Initial Notice"). Fifteen (15) days after delivery of the Initial Notice, the receiving party shall submit to the other a written response (the "Response"). The Initial Notice and the Response shall include (i) a statement of the Dispute and of each party's position, and (ii) the name and title of the executive who will represent that party and of any other person who will accompany the executive. Such executives will meet in person or by telephone within thirty (30) days of the date of the Initial Notice to seek a resolution of the Dispute.

13.3. Mediation. If a Dispute is not resolved by negotiation as provided in Section 13.2 within forty-five (45) days from the delivery of the Initial Notice, then either party may submit the Dispute for resolution by mediation pursuant to the CPR Institute for Dispute Resolution (the "CPR") Model Mediation Procedure as then in effect. The parties will select a mediator from the CPR Panels of Distinguished Neutrals, but such mediator must have prior U.S. reinsurance experience either as a lawyer or as a present or former officer or management employee of a reinsurance company, but not of the Company, or the Reinsurer, or any of their respective affiliates. Either party at commencement of the mediation may ask the mediator to provide an evaluation of the Dispute and the parties' relative positions.

13.4. Arbitration. (a) If a Dispute is not resolved by mediation as provided in Section 13.3 within thirty (30) days of the selection of a mediator (unless the mediator chooses to withdraw sooner), either party may submit the Dispute to be finally resolved by arbitration pursuant to the CPR Rules for Non-Administered Arbitration as then in effect (the "CPR Arbitration Rules"). The parties consent to a single, consolidated arbitration for all known Disputes existing at the time of the arbitration and for which arbitration is permitted.

(b) The neutral organization for purposes of the CPR Arbitration Rules will be the CPR. The arbitral tribunal shall be composed of three arbitrators who are each experienced in the U.S. reinsurance business, of whom each party shall appoint one in accordance with the "screened" appointment procedure provided in Rule 5.4 of the CPR Arbitration Rules. The non-party appointed arbitrator must have prior U.S. reinsurance experience as a present or former officer or management employee of a reinsurance company, but not of the Company, or the Reinsurer, or any of their respective affiliates. The arbitration shall be conducted in New York City. Each party shall be permitted to present its case, witnesses and evidence, if any, in the presence of the other party. A written transcript of the proceedings shall be made and furnished to the parties. The arbitrators shall determine the Dispute in accordance with the law of New York, without giving effect to any conflict of law rules or other rules that might render such law inapplicable or unavailable, and shall apply this Agreement according to its terms, provided that the provisions relating to arbitration shall be governed by the Federal Arbitration Act, 9 U.S.C.

16

---

§§ 1 et seq. The arbitral tribunal shall endeavor to render its award or order resulting from any arbitration within forty-five (45) days following the termination of the arbitration proceedings.

(c) The parties agree to be bound by any award or order resulting from any arbitration conducted hereunder and further agree that judgment on any award or order resulting from an arbitration conducted under this Section may be entered and enforced in any court having jurisdiction thereof.

(d) Except as expressly permitted by this Agreement, no party will commence or voluntarily participate in any court action or proceeding concerning a Dispute, except (i) for enforcement as contemplated by Section 13.4(c) above, (ii) to restrict or vacate an arbitral decision based on the grounds specified under applicable law, or (iii) for interim relief as provided in paragraph (e) below. For purposes of the foregoing the parties hereto submit to the non-exclusive jurisdiction of the courts of the State of New York.

(e) In addition to the authority otherwise conferred on the arbitral tribunal, the tribunal shall have the authority to make such orders for interim relief, including injunctive relief, as it may deem just and equitable. Notwithstanding paragraph (d) above, each party acknowledges that in the event of any actual or threatened breach of certain of the provisions of this Agreement, the remedy at law would not be adequate, and therefore injunctive or other interim relief may be sought immediately to restrain such breach. If the tribunal shall not have been appointed, either party may seek interim relief from a court having jurisdiction if the award to which the applicant may be entitled may be rendered ineffectual without such interim relief. Upon appointment of the tribunal following any grant of interim relief by a court, the tribunal may

affirm or disaffirm such relief, and the parties will seek modification or rescission of the court action as necessary to accord with the tribunal's decision.

XIII. (f) Each party will bear its own attorneys' fees and costs incurred in connection with the resolution of any Dispute in accordance with this Article XIII.

#### ARTICLE XIV

##### MISCELLANEOUS PROVISIONS

14.1. Headings and Schedules. Headings used herein are not a part of this Agreement and shall not affect the terms hereof. The attached Schedules are a part of this Agreement.

14.2. Notices. All notices, requests, demands and other communications under this Agreement must be in writing and will be deemed to have been duly given or made as follows: (a) if sent by registered or certified mail in the United States return receipt requested, upon receipt; (b) if sent by reputable overnight air courier, two business days after mailing; (c) if sent by facsimile transmission, with a copy mailed on the same day in the manner provided in (a) or (b) above, when transmitted and receipt is confirmed by telephone; or (d) if otherwise actually personally delivered, when delivered, and shall be delivered as follows:

17

---

If to the Company:

GE Capital Life Assurance Company of New York  
6610 West Broad Street  
Richmond, VA 23230  
Facsimile: (804) 281-6165  
Attention: Chief Executive Officer

With a copy to:

GE Capital Life Assurance Company of New York  
6610 West Broad Street  
Richmond, VA 23230  
Facsimile: (804) 281-6005  
Attention: General Counsel

If to the Reinsurer:

Union Fidelity Life Insurance Company  
200 North Martingale Road  
Schaumburg, IL 60173-2096  
Facsimile: (847) 330-3404  
Attention: Chief Financial Officer

With a copy to:

Union Fidelity Life Insurance Company  
200 North Martingale Road  
Schaumburg, IL 60173-2096  
Facsimile: (847) 605-3044  
Attention: General Counsel

or to such other address or to such other Person as either party may have last designated by notice to the other party.

14.3. Successors and Assigns. This Agreement shall be binding upon and inure to the benefit of the parties hereto and their respective successors, permitted assigns and legal representatives. Neither this Agreement, nor any right or obligation hereunder, may be assigned by any party without the prior written consent of the other party hereto. Any assignment in violation of this Section 14.3 shall be void and shall have no force and effect. Nothing in this Section 14.3 shall be construed to prohibit the Reinsurer from retroceding all or any portion of the business reinsured hereunder.

14.4. Execution in Counterpart. This Agreement may be executed by the parties hereto in any number of counterparts, and by each of the parties hereto in separate counterparts, each of which counterparts, when so executed and delivered, shall be deemed to be an original, but all such counterparts shall together constitute but one and the same instrument.

18

---

14.5. Currency. Whenever the word "Dollars" or the "\$" sign appear in this Agreement, they shall be construed to mean United States Dollars, and all transactions under this Agreement shall be in United States Dollars.

14.6. Amendments. This Agreement may not be changed, altered or modified unless the same shall be in writing executed by the Company and the Reinsurer.

14.7. Governing Law. This Agreement will be construed, performed and enforced in accordance with the laws of the State of New York without giving effect to its principles or rules of conflict of laws thereof to the extent such principles or rules would require or permit the application of the laws of another jurisdiction.

14.8. Entire Agreement; Severability. (a) This Agreement and the Termination Letter Agreement constitute the entire agreement between the parties hereto relating to the subject matter hereof and supersede all prior and contemporaneous agreements, understandings, statements, representations and warranties, negotiations and discussions, whether oral or written, of the parties and there are no general or specific warranties, representations or other agreements by or among the parties in connection with the entering into of this Agreement or the subject matter hereof except as specifically set forth or contemplated herein or in the Termination Letter Agreement.

(b) If any provision of this Agreement is held to be void or unenforceable, in whole or in part, (i) such holding shall not affect the validity and enforceability of the remainder of this Agreement, including any other provision, paragraph or subparagraph, and (ii) the parties agree to attempt in good faith to reform such void or unenforceable provision to the extent necessary to render such provision enforceable and to carry out its original intent.

14.9. Contemporaneous Agreements. Concurrent with the execution of this Agreement, the parties and/or their Affiliates are also entering into the Capital Maintenance Agreement, the RBC Reporting Letter Agreement and the Assignment Letter Agreement.

14.10. No Waiver; Preservation of Remedies. No consent or waiver, express or implied, by any party to or of any breach or default by any other party in the performance by such other party of its obligations hereunder shall be deemed or construed to be a consent or waiver to or of any other breach or default in the performance of obligations hereunder by such other party hereunder. Failure on the part of any party to complain of any act or failure to act of any other party or to declare any other party in default, irrespective of how long such failure continues, shall not constitute a waiver by such first party of any of its rights hereunder. The rights and remedies provided are cumulative and are not exclusive of any rights or remedies that any party may otherwise have at law or equity.

14.11. Cooperation. Each party hereto shall cooperate fully with the other in all reasonable respects in order to accomplish the objectives of this Agreement including making available to each their respective officers and employees for interviews and meetings with Governmental Authorities and furnishing any additional assistance, information and documents as may be reasonably requested by a party from time to time.

19

---

14.12. Third Party Beneficiary. Nothing in this Agreement will confer any rights upon any Person that is not a party or a successor or permitted assignee of a party to this Agreement.

14.13. Tax Exception to Any Confidentiality. Notwithstanding anything to the contrary set forth herein or in any other agreement to which the parties hereto are parties or by which they are bound, any obligations of confidentiality contained herein and therein, as they relate to the transactions, shall not apply to the federal tax structure or federal tax treatment of the transactions, and each party hereto (and any employee, representative, or agent of any party hereto) may disclose to any and all persons, without limitation of any kind, the federal tax structure and federal tax treatment of the transactions. The preceding sentence is intended to cause the transactions to be treated as not having been offered under conditions of confidentiality for purposes of Section 1.6011-4(b)(3) (or any successor provision) of the Treasury Regulations promulgated under Section 6011 of the Internal Revenue Code of 1986, as amended, and shall be construed in a manner consistent with such purpose. In addition, each party hereto acknowledges that it has no proprietary or exclusive rights to the federal tax structure of the transactions or any federal tax matter or federal tax idea related to the transactions.

14.14. Interpretation. Wherever the words “include,” “includes” or “including” are used in this Agreement, they shall be deemed to be followed by the words “without limitation.”

14.15. Survival. Article XIII and Article XIV shall survive the termination of this Agreement.

20

---

IN WITNESS WHEREOF, the parties hereto have caused this Agreement to be executed by their duly authorized representatives.

GE CAPITAL LIFE ASSURANCE COMPANY  
OF NEW YORK

By /s/ VICTOR C. MOSES  
Name: Victor C. Moses  
Title: Senior Vice President

UNION FIDELITY LIFE INSURANCE COMPANY

By /s/ GLENN JOPPA  
Name: Glenn Joppa  
Title: Senior Vice President and Secretary

21

---

SCHEDULE A

POLICY FORMS

8001

8101

8201

8401

1700

GECLANY RA&Q

---

SCHEDULE B

FORM OF ADMINISTRATIVE SERVICES AGREEMENT

---



ADMINISTRATIVE SERVICES AGREEMENT

by and between

GE CAPITAL LIFE ASSURANCE COMPANY OF NEW YORK

and

UNION FIDELITY LIFE INSURANCE COMPANY

Effective as of [ ]

ADMINISTRATIVE SERVICES AGREEMENT

This ADMINISTRATIVE SERVICES AGREEMENT (this "Agreement"), effective as of [ ] (the "Effective Date"), is entered into by and between GE CAPITAL LIFE ASSURANCE COMPANY OF NEW YORK, an insurance company organized under the laws of the State of New York (the "Company"), and UNION FIDELITY LIFE INSURANCE COMPANY, an insurance company organized under the laws of the State of Illinois (the "Administrator").

**RECITALS:**

WHEREAS, the Company and the Administrator have entered into a Coinsurance Agreement dated as of April 15, 2004 (the "Coinsurance Agreement") which provides for the parties to enter into this Agreement;

WHEREAS, pursuant to the Coinsurance Agreement, the Administrator has agreed to indemnify the Company for, among other things, 100% of the liability of the Company for Benefits payable on or after the Inception Date with respect to the Reinsured Contracts (capitalized terms used herein and not defined herein, unless otherwise indicated, have the respective meanings assigned to them in the Coinsurance Agreement); and

WHEREAS, the Company wishes to appoint the Administrator to provide policyholder and claim servicing with respect to the Reinsured Contracts as set forth herein, and the Administrator desires to provide such administrative services;

NOW, THEREFORE, in consideration of the covenants and agreements set forth herein, the parties hereto agree as follows:

ARTICLE I

AUTHORITY

As between the Company and the Administrator, the Company hereby appoints the Administrator, and the Administrator hereby accepts appointment, to provide as an independent contractor of the Company, from and after the Effective Date, all of the policyholder and claim servicing services necessary or appropriate with respect to the Reinsured Contracts including those set forth in this Agreement (the "Administrative Services"), all on the terms as set forth in this Agreement. Notwithstanding any other provision of this Agreement to the contrary, the Company shall have the final right to direct the Administrator in the performance of the Administrative Services in accordance with the standards for services set forth in Section 2.1, including the right to direct the Administrator to perform any action necessary for the Reinsured Contracts or the policyholder and claim servicing thereof to comply with Applicable Law, or to cease performing any action that constitutes a violation of Applicable Law. All services hereunder shall be performed by the Administrator in the name of and on behalf of the Company. The Administrator shall maintain a toll-free number for use by policyholders, certificateholders and

beneficiaries. Any and all correspondence with policyholders, certificateholders and beneficiaries and check stock utilized by the Administrator for payments under the Reinsured Contracts shall be in the name of the Company or in the name of the Administrator and disclosing that the Administrator is acting as the administrative agent of the Company.

ARTICLE II

STANDARD FOR SERVICES; FACILITIES; SUBCONTRACTING;  
POLICYHOLDER SERVICING

2.1. Standard for Services. The Administrator shall provide policyholder and claims servicing with respect to the Reinsured Contracts in good faith and with the care, skill, prudence and diligence of a person experienced in administering structured settlement business. Without limiting the generality of the foregoing, the Administrator shall provide policyholder and claims servicing with respect to the Reinsured Contracts (i) in accordance with the terms of the Reinsured Contracts, (ii) in accordance with the applicable terms of this Agreement, (iii) in compliance with Applicable Law, (iv) in accordance with industry standards, (v) in accordance with standards of service as agreed to by the Administrator and the Company and, subject to the foregoing, (vi) to the extent applicable, in the same manner as it conducts its own business not subject to this Agreement.

2.2. Facilities and Personnel. To the extent not sub-contracted to a Subcontractor, the Administrator shall at all times maintain sufficient facilities and trained personnel of the kind necessary to perform its obligations under this Agreement in accordance with the performance standards set forth herein.

2.3. Subcontracting. The Administrator may subcontract for the performance of any policyholder or claims servicing service or services with respect to the Reinsured Contracts to (i) an Affiliate or (ii) any other Person with the prior written consent of the Company, such consent not to be unreasonably withheld (in each case, the "Subcontractor"); provided, that, no such subcontracting shall relieve the Administrator from any of its obligations or liabilities hereunder, and the Administrator shall remain responsible for all obligations or liabilities of such Subcontractor with regards to the providing of such service or services as if provided by the Administrator.

2.4. Policyholder Servicing. The Administrator shall provide policyholder servicing with regards to the Reinsured Contracts, including changes of address, responding to policyholder inquiries and similar services.

### ARTICLE III

#### CLAIMS HANDLING

The Administrator shall pay all Benefits payable on or after the Inception Date with respect to the Reinsured Contracts (each, a "Claim" and collectively the "Claims") in accordance with procedures and guidelines established by the Company, such procedures and guidelines to be in accordance with the standards of service set forth in Section 2.1.

2

---

### ARTICLE IV

#### REGULATORY AND LEGAL PROCEEDINGS

4.1. Regulatory Complaints and Proceedings. The Administrator shall:

- (i) respond to any Claims payment related complaints or inquiries made by any Governmental Authority, within the Governmental Authority's requested time frame for response or, if no such time frame is provided, within the time frame as allowed by Applicable Law; and promptly provide a copy of such response to the Company;
- (ii) promptly notify the Company of any non-Claims payment related complaints or inquiries initiated by a Governmental Authority, and of any proceedings (either Claims or non-Claims related) initiated by a Governmental Authority, and, in either case, prepare and send to the Governmental Authority, with a copy to the Company, a response within the Governmental Authority's requested time frame for response or, if no such time frame is provided, within the time frame as allowed by Applicable Law; provided, that, subject to meeting such time frames, the Administrator shall provide such response to the Company for its prior review and comment;
- (iii) subject to Section 4.4, supervise and control the investigation, contest, defense and/or settlement of all complaints, inquiries and proceedings by Governmental Authorities at its own cost and expense, and in the name of the Company when necessary; and
- (iv) at the Company's request, provide to the Company a report in a form mutually agreed by the parties summarizing the nature of any complaints, inquiries or proceedings by Governmental Authorities, the alleged actions or omissions giving rise to such complaints, inquiries or proceedings and copies of any files or other documents that the Company may reasonably request in connection with its review of these matters.

Notwithstanding the foregoing, the Company shall retain final authority for the resolution of inquiries by Governmental Authorities and consumer complaints; provided, however the Company agrees to act reasonably in the exercise of such authority.

4.2. Legal Proceedings. The Administrator shall:

- (i) notify the Company promptly of any lawsuit, action, arbitration or other dispute resolution proceedings that are instituted or threatened with respect to any matter relating to the Reinsured Contracts ("Legal Proceeding(s)"), and in no event more than five (5) Business Days after receipt of notice thereof;

3

---

- (ii) subject to Section 4.4, supervise and control the investigation, contest, defense and/or settlement of all Legal Proceedings at its own cost and expense, and in the name of the Company when necessary; and
- (iii) keep the Company fully informed of the progress of all Legal Proceedings handled by the Administrator in which the Company is named a party and, at the Company's request, provide to the Company a report summarizing the nature of any Legal Proceedings, the alleged actions or omissions giving rise to such Legal Proceedings and copies of any files or other documents that the Company may reasonably request in connection with its review of these matters in each case other than such files, documents and other information as would, in the judgment of counsel to the Administrator, lead to the loss or waiver of legal privilege.

4.3. Notice to Administrator. The Company shall give prompt notice to the Administrator of any Legal Proceeding made or brought against the Company after the Inception Date arising under or in connection with the Reinsured Contracts to the extent known to it and not made against or served on the Administrator or a Subcontractor as administrator hereunder, and in no event more than five (5) Business Days after receipt of notice thereof, and shall promptly furnish to the Administrator copies of all pleadings in connection therewith. The Administrator shall assume the defense of the Company.

4.4. Defense of Regulatory and Legal Proceedings. Notwithstanding anything in this Agreement to the contrary, the Company shall have the right to engage in its own separate legal representation, at its own expense, and to participate fully in the defense of any Legal Proceedings or complaints, inquiries or proceedings by Governmental Authorities with respect to the Reinsured Contracts in which the Company is a named party without waiving any right to indemnification it may have under Article XV hereof. The Administrator and the Company shall cooperate with each other with respect to the administration of any Legal Proceeding and any complaint, inquiry or proceeding by Governmental Authorities. The Administrator shall not settle any Legal Proceeding or any complaint, inquiry or proceeding by Governmental Authorities without the Company's prior written consent (which consent shall not be unreasonably withheld or delayed) unless (i) there is no finding or admission of any violation of law or any violation of the rights of any Person, (ii) such settlement would not reasonably be expected to have material adverse precedential consequences to the Company and (iii) the sole relief provided is monetary damages that are paid in full by the Administrator.

### ARTICLE V

#### NOTIFICATION TO POLICYHOLDERS

The Administrator agrees to send to policyholders of the Reinsured Contracts a written notice prepared by the Administrator, reasonably acceptable to the Company and approved by the New York Insurance Department to the effect that the Administrator, or such other Person designated by the Administrator in accordance with the terms of this Agreement, has been appointed by the Company to provide Administrative Services. The Administrator shall send

4

---

such notice by first class U.S. mail at a time reasonably acceptable to the Company and the Administrator and in all events in accordance with Applicable Law. The parties intend to minimize the cost associated with any notification under this Article V, including by means of inclusion of the notice in a regularly scheduled mailing to policyholders in lieu of a separate mailing. The cost associated with such notification under this Article V (upon the initial assumption of the administration of the Reinsured Contracts under Section 3.7 of the Coinsurance Agreement) shall be a transition cost payable by the Administrator or the Company in accordance with Section 3.7(a) or 3.7(c) of the Coinsurance Agreement, as applicable.

## ARTICLE VI

### INSOLVENCY FUND ACCOUNTINGS

6.1. Quarterly Accountings. Within thirty (30) days after the end of each calendar quarter that this Agreement is in effect (or more frequently as mutually agreed by the parties), the Company shall submit to the Administrator a written statement of accounting in a form and containing such information to be agreed upon by the parties hereto (each, an "Insolvency Fund Quarterly Accounting") setting forth the Insolvency Fund amounts assessed or payable to the extent that such assessments constitute Reinsured Risks with respect to the Reinsured Contracts (collectively, the "Post-Effective Date Assessments"). The Administrator shall remit to the Company an amount equal to the Post-Effective Date Assessments set forth in an Insolvency Fund Quarterly Accounting received by the Administrator within ten (10) Business Days of receipt by the Administrator of such Insolvency Fund Quarterly Accounting.

6.2. Adjustments Regarding Insolvency Fund Accountings. In the event that subsequent data or calculations require revision of any of the Insolvency Fund Quarterly Accountings, the required revision and appropriate payments thereunder shall be made within ten (10) Business Days after the parties hereto mutually agree as to the appropriate revision.

## ARTICLE VII

### CERTAIN ACTIONS BY COMPANY

7.1. Filings. The Company shall prepare and timely file any filings required to be made with any Governmental Authority that relate to the Company generally and not just to the Reinsured Contracts, including filings with guaranty associations and filings and premium tax returns with taxing authorities. The Administrator shall, in a timely fashion in light of the dates such filings by the Company are required, provide to the Company all information in the possession of the Administrator with respect to the Reinsured Contracts that may be reasonably required for the Company to prepare such filings and tax returns.

7.2. Annual Adjustment. The Company shall pay or provide to the Administrator the benefit of any Post-Effective Date Assessments which have been or can be applied to reduce the Company's premium tax liability ("Premium Tax Credits"). The Company shall provide to the Administrator by March 15 of each year a statement of the amount of

5

---

Premium Tax Credits for the prior calendar year and the Company will pay or credit to the Administrator an amount equal to such Premium Tax Credits.

## ARTICLE VIII

### REGULATORY MATTERS AND AUDIT REPORTING

8.1. Regulatory Compliance and Reporting. The Administrator shall provide to the Company such information with respect to the Reinsured Contracts as is required to satisfy all current and future informational reporting, prior approval and any other requirements imposed by any Governmental Authority. Upon the reasonable request of the Company, the Administrator shall timely prepare such reports and summaries, including statistical summaries, as are necessary or reasonably required to satisfy any requirements imposed by a Governmental Authority upon the Company with respect to the Reinsured Contracts. In addition, the Administrator, upon the reasonable request of the Company, shall promptly provide to the Company copies of all existing records relating to the Reinsured Contracts (including, with respect to records maintained in machine readable form, hard copies) that are necessary to satisfy such requirements. All copies of records furnished in the ordinary course of business shall be furnished by the Administrator at the Administrator's cost. Any extraordinary costs reasonably incurred by the Administrator in response to requests from the Company shall be reimbursed by the Company. Among other responsibilities:

- (i) The Administrator shall promptly prepare and furnish to Governmental Authorities all reports and related summaries (including, without limitation, statistical summaries), certificates of compliance and other reports required or requested by a Governmental Authority.
- (ii) The Administrator shall assist the Company and cooperate with the Company in doing all things necessary, proper or advisable, in the most expeditious manner practicable in connection with any and all market conduct or other Governmental Authority examinations relating to the Reinsured Contracts.

8.2. Reporting and Accounting. The Administrator shall assume the reporting and accounting obligations set forth below:

- (i) As soon as practicable but not more than forty (40) days after the end of each calendar quarter that this Agreement is in effect (or more frequently as mutually agreed by the parties), the Administrator shall timely provide to the Company the Quarterly Reports. As soon as practicable but not more than forty-five (45) days after the end of each calendar year that this Agreement is in effect, the Administrator shall timely provide to the Company the Annual Reports. In addition, as soon as practicable but not more than forty (40) days after the end of each calendar quarter that this Agreement is in effect (or more frequently as mutually agreed by the parties), the Administrator shall timely provide to the Company such other

6

---

reports and summaries of transactions (and, upon request of the Company, detailed supporting records) related to the Reinsured Contracts as may be reasonably required for use in connection with the preparation of the Company's statutory and GAAP financial statements, tax returns and other required financial reports and to comply with the requirements of the regulatory authorities having jurisdiction over the Company. The parties shall cooperate in good faith to establish the manner for the providing of such reports.

- (ii) As soon as practicable but not more than forty (40) days after the end of each calendar quarter that this Agreement is in effect (or more frequently as mutually agreed by the parties), the Administrator shall report to the Company the amount of statutory reserves that the Company is required to maintain in connection with the Reinsured Risks with respect to the Reinsured Contracts as of the quarter end.
- (iii) The Administrator shall promptly provide notice to the Company of any changes in the reserve methodology used by the Administrator in calculating statutory reserves for the Reinsured Contracts.

- (iv) Within forty-five (45) days after each calendar year end (or such longer time as may be agreed by the parties) that this Agreement is in effect, the Administrator shall provide to the Company (a) an opinion of an actuary reasonably acceptable to the Company as to the adequacy of statutory reserves for the Reinsured Contracts, prepared according to accepted actuarial standards of practice, and as otherwise required for regulatory reporting purposes and (b) an analysis which reasonably supports such opinion.

8.3. Additional Reports and Updates. For so long as this Agreement remains in effect, each party shall periodically furnish to the other such other reports and information as may be reasonably required by such other party for regulatory, tax or similar purposes and reasonably available to it.

## ARTICLE IX

### MISCELLANEOUS ADMINISTRATIVE SERVICES

The Administrator shall provide such Administrative Services as are not performed by or on behalf of the Company on the date hereof but the need for which may arise due to changes or developments in Applicable Law.

7

---

## ARTICLE X

### BOOKS AND RECORDS

The Administrator shall keep accurate and complete records, files and accounts of all transactions and matters with respect to the Reinsured Contracts and the administration thereof in accordance with Applicable Law, including New York Regulation 152, and its record management practices in effect from time to time for the Administrator's insurance business not covered by this Agreement, if any. All such records pertaining to the Reinsured Contracts shall be the property of the Company, provided that the Administrator shall at all times have the right to retain a copy of such books and records. The parties to this Agreement and their designated representatives may upon reasonable notice inspect, at the offices of the Administrator or the Company where such records are located, the papers and any and all other books or documents of the Administrator or the Company reasonably relating to this Agreement, including the Reinsured Contracts, and shall have access to appropriate employees and representatives of the other party, in each case during normal business hours for such period as this Agreement is in effect or for as long thereafter as any rights or obligations of any party survives or the Administrator or the Company reasonably need access to such records for regulatory, tax or similar purposes. The information obtained shall be used only for purposes relating to the transactions contemplated under this Agreement.

## ARTICLE XI

### COOPERATION

Each party hereto shall cooperate fully with the other in all reasonable respects in order to accomplish the objectives of this Agreement including making available to each their respective officers and employees for interviews and meetings with Governmental Authorities and furnishing any additional assistance, information and documents as may be reasonably requested by a party from time to time.

## ARTICLE XII

### PRIVACY REQUIREMENTS

In providing the Administrative Services provided for under this Agreement, and in connection with maintaining, administering, handling and transferring the data of the policyholders and other recipients of benefits under the Reinsured Contracts, the Administrator shall, and shall cause its Affiliates and any permitted Subcontractors to, comply with all confidentiality and security obligations applicable to them in connection with the collection, use, disclosure, maintenance and transmission of personal, private, health or financial information about individual policyholders or benefit recipients, including the provisions of privacy policies under which such information was gathered, those laws currently in place and which may become effective during the term of this Agreement, including the Gramm-Leach-Bliley Act, the Health Insurance Portability and Accountability Act of 1996 and any other Applicable Laws.

8

---

The Administrator shall entitle the Company and its agents and representatives, the Commissioner of Health and Human Services and such other Governmental Authorities, to the extent required by Applicable Law, to audit the Administrator's compliance herewith. The Administrator shall also enable individual subjects of personally identifiable information, upon request from such individuals, to review and correct information maintained by the Administrator about them, and to restrict use of such information. The Administrator shall promptly report to the Company any violation of this provision of which the Administrator becomes aware. Unless required by Applicable Law, the Administrator shall not during the term of this Agreement, modify the privacy policies under which information utilized by the Administrator in administering the Reinsured Contracts is gathered, without the Company's prior written consent, which consent shall not be unreasonably withheld. The parties agree to comply with the terms of the Business Associate Addendum attached hereto, if applicable, or such other written agreement as may be required by Applicable Law on the date hereof.

## ARTICLE XIII

### CONSIDERATION FOR ADMINISTRATIVE SERVICES

Apart from the performance by the Company of its obligations under the Coinsurance Agreement, there shall be no fee or other consideration due to the Administrator for performance of the Administrative Services under this Agreement.

## ARTICLE XIV

### BANK ACCOUNT; USE OF COMPANY LETTERHEAD

When and on terms reasonably requested by the Administrator, the Company shall open, modify or close, and make available for use by the Administrator for the payment of amounts to be paid by the Administrator hereunder one or more bank accounts of the Company and check stock of the Company. The Administrator shall maintain such account(s) and pay all applicable bank fees and check stock costs. The Company shall adopt such resolutions and execute such documents as required to designate senior officers of the Administrator (by title) as signatories on such account(s) and authorize the Administrator to certify to such bank(s), from time to time, the names of such officers. The Company shall also make available to the Administrator, at the sole expense of the Administrator, such letterhead, printed forms and other documents of the Company as may be reasonably required by the Administrator in performing services hereunder. Upon termination of this Agreement, the Administrator shall promptly return to the Company all such unused check stock, letterhead, printed forms and other documents held by it in connection with this Agreement as provided under this Article XIV.

## ARTICLE XV

INDEMNIFICATION

Any claim for or with respect to indemnification arising out of, or relating to, this Agreement or the Administrative Services hereunder shall be permitted under and governed by the provisions of Article V of the Master Agreement, dated as of [ ], 2004, among General Electric Company, General Electric Capital Corporation, GEI, Inc., GE Financial Assurance Holdings, Inc. and Genworth Financial, Inc (the "Master Agreement"), to the extent such provisions are applicable, as if this Agreement were a Transaction Document under the Master Agreement.

## ARTICLE XVI

DURATION; TERMINATION

16.1. Duration. This Agreement shall commence on the Effective Date and continue with respect to each Reinsured Contract until no further Administrative Services in respect of such Reinsured Contract is required, unless this Agreement is earlier terminated under Section 16.2.

16.2. Termination. (a) This Agreement is subject to immediate termination at the option of the Company, upon written notice to the Administrator, on the occurrence of any of the following events:

- (i) A voluntary or involuntary proceeding is commenced in any jurisdiction by or against the Administrator for the purpose of conserving, rehabilitating or liquidating the Administrator;
- (ii) There is a material breach by the Administrator of any material term or condition of this Agreement that is not cured by the Administrator within thirty (30) days after receipt of written notice from the Company of such breach or act (provided that the Company shall not have the right to terminate this Agreement (A) for so long as the Administrator is making a good faith effort to cure such breach, not to exceed an additional one hundred eighty (180) days or (B) during the pendency of any dispute resolution proceedings as set forth in Article XVII regarding an alleged material breach); or
- (iii) The Administrator is unable to perform the services required under this Agreement for a period of thirty (30) consecutive days for any reason other than as a result of a Force Majeure, it being understood that nothing in this Section 16.2(a)(iii) shall relieve the Administrator from its administrative responsibilities under this Agreement. For purposes of this Agreement, "Force Majeure" means any acts or omissions of any civil or military authority, acts of God, acts or omissions of the Company, fires, strikes or other labor disturbances, equipment failures, fluctuations or non-availability

of electrical power, heat, light, air conditioning or telecommunications equipment, or any other act, omission or occurrence beyond the Administrator's reasonable control, irrespective of whether similar to the foregoing enumerated acts, omissions or occurrences.

- (b) This Agreement may be terminated at any time upon the mutual written consent of the parties hereto, which writing shall state the effective date of termination.
- (c) In the event that this Agreement is terminated under any of the provisions of Section 16.2(a), the Administrator shall select a third-party administrator to perform the services required by this Agreement. The Company shall have the right to approve any such administrator selected by the Administrator, but such approval will not unreasonably be withheld or delayed. If the Administrator fails to select an administrator pursuant to this Section 16.2(c), the Company shall select such an administrator. In either case, the Administrator shall pay all fees and charges imposed by the selected administrator and shall bear all transition costs associated with the transition of the performance of the services required under this Agreement to such administrator, including the expense of sending policyholder notices as provided in Article V.

## ARTICLE XVII

DISPUTE RESOLUTION

17.1. General Provisions. (a) Any dispute, controversy or claim arising out of or relating to this Agreement or the validity, interpretation, breach or termination thereof (a "Dispute"), shall be resolved in accordance with the procedures set forth in this Article XVII, which shall be the sole and exclusive procedures for the resolution of any such Dispute unless otherwise specified below.

(b) Commencing with the request contemplated by Section 17.2, all communications between the parties or their representatives in connection with the attempted resolution of any Dispute, including any mediator's evaluation referred to in Section 17.3, shall be deemed to have been delivered in furtherance of a Dispute settlement and shall be exempt from discovery and production, and shall not be admissible in evidence for any reason (whether as an admission or otherwise), in any arbitral or other proceeding for the resolution of the Dispute.

(c) In connection with any Dispute, the parties expressly waive and forego any right to (i) punitive, exemplary, statutorily-enhanced or similar damages in excess of compensatory damages (provided that any such liability with respect to a Third Party Claim (as defined in the Master Agreement) shall be considered direct damages), and (ii) trial by jury.

(d) The specific procedures set forth below, including but not limited to the time limits referenced therein, may be modified by agreement of the parties in writing.

(e) All applicable statutes of limitations and defenses based upon the passage of time shall be tolled while the procedures specified in this Article XVII are pending. The parties will take such action, if any, required to effectuate such tolling.

17.2. Consideration by Senior Executives. If a Dispute is not resolved in the normal course of business at the operational level, the parties shall attempt in good faith to resolve such Dispute by negotiation between executives who hold, at a minimum, the office of President and CEO of the respective business entities involved in such Dispute. Either party may initiate the executive negotiation process by providing a written notice to the other (the "Initial Notice"). Fifteen (15) days after delivery of

the Initial Notice, the receiving party shall submit to the other a written response (the "Response"). The Initial Notice and the Response shall include (i) a statement of the Dispute and of each party's position, and (ii) the name and title of the executive who will represent that party and of any other person who will accompany the executive. Such executives will meet in person or by telephone within thirty (30) days of the date of the Initial Notice to seek a resolution of the Dispute.

17.3. Mediation. If a Dispute is not resolved by negotiation as provided in Section 17.2 within forty-five (45) days from the delivery of the Initial Notice, then either party may submit the Dispute for resolution by mediation pursuant to the CPR Institute for Dispute Resolution (the "CPR") Model Mediation Procedure as then in effect. The parties will select a mediator from the CPR Panels of Distinguished Neutrals, but such mediator must have prior U.S. reinsurance experience either as a lawyer or as a present or former officer or management employee of a reinsurance company, but not of the Company, or the Administrator, or any of their respective affiliates. Either party at commencement of the mediation may ask the mediator to provide an evaluation of the Dispute and the parties' relative positions.

17.4. Arbitration. (a) If a Dispute is not resolved by mediation as provided in Section 17.3 within thirty (30) days of the selection of a mediator (unless the mediator chooses to withdraw sooner), either party may submit the Dispute to be finally resolved by arbitration pursuant to the CPR Rules for Non-Administered Arbitration as then in effect (the "CPR Arbitration Rules"). The parties consent to a single, consolidated arbitration for all known Disputes existing at the time of the arbitration and for which arbitration is permitted.

(b) The neutral organization for purposes of the CPR Arbitration Rules will be the CPR. The arbitral tribunal shall be composed of three arbitrators who are each experienced in the U.S. reinsurance business, of whom each party shall appoint one in accordance with the "screened" appointment procedure provided in Rule 5.4 of the CPR Arbitration Rules. The non-party appointed arbitrator must have prior U.S. reinsurance experience as a present or former officer or management employee of a reinsurance company, but not of the Company, or the Administrator, or any of their respective affiliates. The arbitration shall be conducted in New York City. Each party shall be permitted to present its case, witnesses and evidence, if any, in the presence of the other party. A written transcript of the proceedings shall be made and furnished to the parties. The arbitrators shall determine the Dispute in accordance with the law of New York, without giving effect to any conflict of law rules or other rules that might render such law inapplicable or unavailable, and shall apply this Agreement according to its terms, provided that the provisions relating to arbitration shall be governed by the Federal Arbitration Act, 9 U.S.C. §§ 1 et seq. The arbitral tribunal shall endeavor to render its award or order

12

---

resulting from any arbitration within forty-five (45) days following the termination of the arbitration proceedings.

(c) The parties agree to be bound by any award or order resulting from any arbitration conducted hereunder and further agree that judgment on any award or order resulting from an arbitration conducted under this Section 17.4 may be entered and enforced in any court having jurisdiction thereof.

(d) Except as expressly permitted by this Agreement, no party will commence or voluntarily participate in any court action or proceeding concerning a Dispute, except (i) for enforcement as contemplated by Section 17.4(c) above, (ii) to restrict or vacate an arbitral decision based on the grounds specified under applicable law, or (iii) for interim relief as provided in paragraph (e) below. For purposes of the foregoing the parties hereto submit to the non-exclusive jurisdiction of the courts of the State of New York.

(e) In addition to the authority otherwise conferred on the arbitral tribunal, the tribunal shall have the authority to make such orders for interim relief, including injunctive relief, as it may deem just and equitable. Notwithstanding paragraph (d) above, each party acknowledges that in the event of any actual or threatened breach of certain of the provisions of this Agreement, the remedy at law would not be adequate, and therefore injunctive or other interim relief may be sought immediately to restrain such breach. If the tribunal shall not have been appointed, either party may seek interim relief from a court having jurisdiction if the award to which the applicant may be entitled may be rendered ineffectual without such interim relief. Upon appointment of the tribunal following any grant of interim relief by a court, the tribunal may affirm or disaffirm such relief, and the parties will seek modification or rescission of the court action as necessary to accord with the tribunal's decision.

(f) Each party will bear its own attorneys' fees and costs incurred in connection with the resolution of any Dispute in accordance with this Article XVII.

## ARTICLE XVIII

### MISCELLANEOUS PROVISIONS

18.1. Headings and Schedules. Headings used herein are not a part of this Agreement and shall not affect the terms hereof. The attached Schedules are a part of this Agreement.

18.2. Notices. All notices, requests, demands and other communications under this Agreement must be in writing and will be deemed to have been duly given or made as follows: (a) if sent by registered or certified mail in the United States return receipt requested, upon receipt; (b) if sent by reputable overnight air courier, two business days after mailing; (c) if sent by facsimile transmission, with a copy mailed on the same day in the manner provided in (a) or (b) above, when transmitted and receipt is confirmed by telephone; or (d) if otherwise actually personally delivered, when delivered, and shall be delivered as follows:

13

---

If to the Company:

GE Capital Life Assurance Company of New York  
6610 West Broad Street  
Richmond, VA 23230  
Facsimile: (804) 281-6165  
Attention: Chief Executive Officer

With a copy to:

GE Capital Life Assurance Company of New York  
6610 West Broad Street  
Richmond, VA 23230  
Facsimile: (804) 281-6005  
Attention: General Counsel

If to the Administrator:

Union Fidelity Life Insurance Company  
200 North Martingale Road

Schaumburg, IL 60173-2096  
Facsimile: (847) 330-3404  
Attention: Chief Financial Officer

With a copy to:

Union Fidelity Life Insurance Company  
200 North Martingale Road  
Schaumburg, IL 60173-2096  
Facsimile: (847) 605-3044  
Attention: General Counsel

or to such other address or to such other Person as either party may have last designated by notice to the other party.

18.3. Successors and Assigns. This Agreement shall be binding upon and inure to the benefit of the parties hereto and their respective successors, permitted assigns and legal representatives. Neither this Agreement, nor any right or obligation hereunder, may be assigned by any party without the prior written consent of the other party hereto and without the prior written consent of the New York Insurance Department and the Illinois Insurance Department. Any assignment in violation of this Section 18.3 shall be void and shall have no force and effect.

18.4. Execution in Counterpart. This Agreement may be executed by the parties hereto in any number of counterparts, and by each of the parties hereto in separate counterparts, each of which counterparts, when so executed and delivered, shall be deemed to be an original, but all such counterparts shall together constitute but one and the same instrument.

14

---

18.5. Safeguarding Customer Information. The Administrator shall implement and maintain appropriate measures designed to meet the objectives of New York Insurance Department Regulation No. 173, with respect to safeguarding the Company's customer information and customer information systems. The Administrator shall adjust its information security program at the reasonable request of the Company for any relevant changes indicated by the Company's assessment of risk around its customer information and customer information systems. Confirming evidence that the Administrator has satisfied its obligations under this Agreement shall be made available, during normal business hours, for inspection by the Company, representatives of the Company, and any governmental agency that has regulatory authority over the Company's business activities.

18.6. Currency. Whenever the word "Dollars" or the "\$" sign appear in this Agreement, they shall be construed to mean United States Dollars, and all transactions under this Agreement shall be in United States Dollars.

18.7. Amendments. This Agreement may not be changed, altered or modified unless the same shall be in writing executed by the Company and the Administrator.

18.8. Governing Law. This Agreement will be construed, performed and enforced in accordance with the laws of the State of New York without giving effect to its principles or rules of conflict of laws thereof to the extent such principles or rules would require or permit the application of the laws of another jurisdiction.

18.9. Entire Agreement; Severability. (a) This Agreement constitutes the entire agreement between the parties hereto relating to the subject matter hereof and supersedes all prior and contemporaneous agreements, understandings, statements, representations and warranties, negotiations and discussions, whether oral or written, of the parties and there are no general or specific warranties, representations or other agreements by or among the parties in connection with the entering into of this Agreement or the subject matter hereof except as specifically set forth or contemplated herein.

(b) If any provision of this Agreement is held to be void or unenforceable, in whole or in part, (i) such holding or provision shall not affect the validity and enforceability of the remainder of this Agreement, including any other provision, paragraph or subparagraph, and (ii) the parties agree to attempt in good faith to reform such void, unenforceable or violative provision to the extent necessary to render such provision enforceable and to carry out its original intent.

18.10. No Waiver; Preservation of Remedies. No consent or waiver, express or implied, by any party to or of any breach or default by any other party in the performance by such other party of its obligations hereunder shall be deemed or construed to be a consent or waiver to or of any other breach or default in the performance of obligations hereunder by such other party hereunder. Failure on the part of any party to complain of any act or failure to act of any other party or to declare any other party in default, irrespective of how long such failure continues, shall not constitute a waiver by such first party of any of its rights hereunder. The rights and remedies provided are cumulative and are not exclusive of any rights or remedies that any party may otherwise have at law or equity.

15

---

18.11. Third Party Beneficiary. Nothing in this Agreement will confer any rights upon any Person that is not a party or a successor or permitted assignee of a party to this Agreement.

18.12. Tax Exception to Any Confidentiality. Notwithstanding anything to the contrary set forth herein or in any other agreement to which the parties hereto are parties or by which they are bound, any obligations of confidentiality contained herein and therein, as they relate to the transactions, shall not apply to the federal tax structure or federal tax treatment of the transactions, and each party hereto (and any employee, representative, or agent of any party hereto) may disclose to any and all persons, without limitation of any kind, the federal tax structure and federal tax treatment of the transactions. The preceding sentence is intended to cause the transactions to be treated as not having been offered under conditions of confidentiality for purposes of Section 1.6011-4(b)(3) (or any successor provision) of the Treasury Regulations promulgated under Section 6011 of the Internal Revenue Code of 1986, as amended, and shall be construed in a manner consistent with such purpose. In addition, each party hereto acknowledges that it has no proprietary or exclusive rights to the federal tax structure of the transactions or any federal tax matter or federal tax idea related to the transactions.

18.13. Interpretation. Wherever the words "include," "includes" or "including" are used in this Agreement, they shall be deemed to be followed by the words "without limitation."

18.14. Survival. Article XVII and Article XVIII shall survive the termination of this Agreement.

18.15. Licensing. At all times during the term of this Agreement, the Administrator shall maintain in full force and effect all licenses required to be maintained by it under Applicable Law with respect to this Agreement, including, if applicable, an independent claims adjuster license.

16

---

IN WITNESS WHEREOF, the Company and the Administrator have executed this Agreement as of the date first above written.

GE CAPITAL LIFE ASSURANCE COMPANY  
OF NEW YORK

By: \_\_\_\_\_  
Name:  
Title:

UNION FIDELITY LIFE INSURANCE  
COMPANY

By: \_\_\_\_\_  
Name:  
Title:

17

---

**BUSINESS ASSOCIATE ADDENDUM**

I. Purpose.

In order to disclose certain information to the party providing a service under this Agreement (“Provider”) under this Addendum, some of which may constitute Protected Health Information (defined below), the party to whom a service under this Agreement is being provided (“Recipient”) and Provider mutually agree to comply with the terms of this Addendum for the purpose of satisfying the requirements of the Health Insurance Portability and Accountability Act of 1996 (“HIPAA”) and its implementing privacy regulations at 45 C.F.R. Parts 160-164 (“HIPAA Privacy Rule”). These provisions shall apply to Provider to the extent that Provider is considered a “Business Associate” under the HIPAA Privacy Rule and all references in this section to Business Associates shall refer to Provider. Capitalized terms not otherwise defined herein shall have the meaning assigned in the Agreement. Notwithstanding anything else to the contrary in the Agreement, in the event of a conflict between this Addendum and the Agreement, the terms of this Addendum shall prevail.

II. Permitted Uses and Disclosures.

A. Business Associate agrees to use or disclose Protected Health Information (“PHI”) that it creates for or receives from Recipient or its Subsidiaries only as follows. The capitalized term “Protected Health Information or PHI” has the meaning set forth in 45 Code of Federal Regulations Section 164.501, as amended from time to time. Generally, this term means individually identifiable health information including, without limitation, all information, data and materials, including without limitation, demographic, medical and financial information, that relates to the past, present, or future physical or mental health or condition of an individual; the provision of health care to an individual; or the past present, or future payment for the provision of health care to an individual; and that identifies the individual or with respect to which there is a reasonable basis to believe the information can be used to identify the individual. This definition shall include any demographic information concerning members and participants in, and applicants for, Recipient’s or its Subsidiaries’ health benefit plans. All other terms used in this Addendum shall have the meanings set forth in the applicable definitions under the HIPAA Privacy Rule.

B. Functions and Activities on Company’s Behalf. Business Associate is permitted to use and disclose PHI it creates for or receives from Recipient or its Subsidiaries only for the purposes described in this Addendum or the Agreement that are not inconsistent with the provisions of this Addendum, or as required by law, or following receipt of prior written approval from whichever of the Recipient or its Subsidiary for which the relevant PHI was created or from which the relevant PHI was received. In addition to these specific requirements below, Business Associate may use or disclose PHI only in a manner that would not violate the HIPAA Privacy Rule if done by the Recipient or its Subsidiaries.

C. Business Associate’s Operations. Business Associate is permitted by this Agreement to use PHI it creates for or receives from Recipient or its Subsidiaries: (i) if such use is reasonably necessary for Business Associate’s proper management and administration; and (ii) as reasonably necessary to carry out Business Associate’s legal responsibilities.

---

Business Associate is permitted to disclose PHI it creates for or receives from Recipient or its Subsidiaries for the purposes identified in this Section only if the following conditions are met:

- (1) The disclosure is required by law; or
- (2) The disclosure is reasonably necessary to Business Associate’s proper management and administration, and Business Associate obtains reasonable assurances in writing from any person or organization to which Business Associate will disclose such PHI that the person or organization will:
  - a. Hold such PHI as confidential and use or further disclose it only for the purpose for which Business Associate disclosed it to the person or organization or as required by law; and
  - b. Notify Business Associate (who will in turn promptly notify whichever of the Recipient or its Subsidiary for which the relevant PHI was created or from which the relevant PHI was received) of any instance of which the person or organization becomes aware in which the confidentiality of such PHI was breached.

D. Minimum Necessary Standard. In performing the functions and activities on Recipient’s or its Subsidiaries’ behalf pursuant to the Agreement, Business Associate agrees to use, disclose or request only the minimum necessary PHI to accomplish the purpose of the use, disclosure or request. Business Associate must have in place policies and procedures that limit the PHI disclosed to meet this minimum necessary standard.

E. Prohibition on Unauthorized Use or Disclosure. Business Associate will neither use nor disclose PHI it creates or receives for or from Recipient, its Subsidiaries, or from another business associate of Recipient or its Subsidiaries, except as permitted or required by this Addendum or the Agreement that are not inconsistent with the provisions of this Addendum, or as required by law, or following receipt of prior written approval from whichever of the Recipient or its Subsidiary for which the relevant PHI was created or from which the relevant PHI was received.

F. De-identification of Information. Business Associate agrees neither to de-identify PHI it creates for or receives from Recipient or its Subsidiaries or from



another business associate of Recipient or its Subsidiaries, nor use or disclose such de-identified PHI, unless such de-identification is expressly permitted under the terms and conditions of this Addendum or the Agreement and related to Recipient's or its Subsidiaries' activities for purposes of "treatment", "payment" or "health care operations", as those terms are defined under the HIPAA Privacy Rule. De-identification of PHI, other than as expressly permitted under the terms and conditions of the Addendum for Business Associate to perform services for Recipient or its Subsidiaries, is not a permitted use of PHI under this Addendum. Business Associate further agrees that it will not create a "Limited Data Set" as defined by the HIPAA Privacy Rule using PHI it creates or receives, or receives from another business associate of Recipient or its Subsidiaries, nor use or disclose such Limited Data Set unless: (i) such creation, use or disclosure is expressly permitted under the terms and conditions of

---

this Addendum or the Agreement that are not inconsistent with the provisions of this Addendum; and such creation, use or disclosure is for services provided by Business Associate that relate to Recipient's or its Subsidiaries' activities for purposes of "treatment", "payment" or "health care operations", as those terms are defined under the HIPAA Privacy Rule.

G. Information Safeguards. Business Associate will develop, document, implement, maintain and use appropriate administrative, technical and physical safeguards to preserve the integrity and confidentiality of and to prevent non-permitted use or disclosure of PHI created for or received from Recipient or its Subsidiaries. These safeguards must be appropriate to the size and complexity of Business Associate's operations and the nature and scope of its activities. Business Associate agrees that these safeguards will meet any applicable requirements set forth by the U.S. Department of Health and Human Services, including (as of the effective date or as of the compliance date, whichever is applicable) any requirements set forth in the final HIPAA security regulations. Business Associate agrees to mitigate, to the extent practicable, any harmful effect that is known to Business Associate resulting from a use or disclosure of PHI by Business Associate in violation of the requirements of this Addendum.

III. Conducting Standard Transactions. In the course of performing services for Recipient or its Subsidiaries, to the extent that Business Associate will conduct Standard Transactions for or on behalf of Recipient or its Subsidiaries, Business Associate will comply, and will require any subcontractor or agent involved with the conduct of such Standard Transactions to comply, with each applicable requirement of 45 C.F.R. Part 162. "Standard Transaction(s)" shall mean a transaction that complies with the standards set forth at 45 C.F.R. parts 160 and 162. Further, Business Associate will not enter into, or permit its subcontractors or agents to enter into, any trading partner agreement in connection with the conduct of Standard Transactions for or on behalf of the Recipient or its Subsidiaries that:

- a. Changes the definition, data condition, or use of a data element or segment in a Standard Transaction;
- b. Adds any data element or segment to the maximum defined data set;
- c. Uses any code or data element that is marked "not used" in the Standard Transaction's implementation specification or is not in the Standard Transaction's implementation specification; or
- d. Changes the meaning or intent of the Standard Transaction's implementation specification.

IV. Sub-Contractors, Agents or Other Representatives. Business Associate will require any of its subcontractors, agents or other representatives to which Business Associate is permitted by this Addendum or the Agreement (or is otherwise given Recipient's or the relevant Subsidiary's prior written approval) to disclose any of the PHI Business Associate creates or receives for or from Recipient or its Subsidiaries, to provide reasonable assurances in writing that subcontractor

---

or agent will comply with the same restrictions and conditions that apply to the Business Associate under the terms and conditions of this Addendum with respect to such PHI.

V. Protected Health Information Access, Amendment and Disclosure Accounting.

A. Access. Business Associate will promptly upon Recipient's or its Subsidiary's request make available to Recipient, its Subsidiary, or, at Recipient's or such Subsidiary's direction, to the individual (or the individual's personal representative) for inspection and obtaining copies any PHI about the individual which Business Associate created for or received from Recipient or its Subsidiary and that is in Business Associate's custody or control, so that Recipient or its Subsidiary may meet its access obligations under 45 Code of Federal Regulations § 164.524.

B. Amendment. Upon Recipient's or its Subsidiary's request Business Associate will promptly amend or permit Recipient or its Subsidiary access to amend any portion of the PHI which Business Associate created for or received from Recipient or its Subsidiary, and incorporate any amendments to such PHI, so that Recipient or its Subsidiary may meet its amendment obligations under 45 Code of Federal Regulations § 164.526.

C. Disclosure Accounting. So that Recipient or its Subsidiaries may meet their disclosure accounting obligations under 45 Code of Federal Regulations § 164.528:

1. Disclosure Tracking. Business Associate will record for each disclosure, not excepted from disclosure accounting under Section V.C.2 below, that Business Associate makes to Recipient or its Subsidiaries of PHI that Business Associate creates for or receives from Recipient or its Subsidiaries, (i) the disclosure date, (ii) the name and member or other policy identification number of the person about whom the disclosure is made, (iii) the name and (if known) address of the person or entity to whom Business Associate made the disclosure, (iv) a brief description of the PHI disclosed, and (v) a brief statement of the purpose of the disclosure (items i-v, collectively, the "disclosure information"). For repetitive disclosures Business Associate makes to the same person or entity (including Recipient or its Subsidiaries) for a single purpose, Business Associate may provide a) the disclosure information for the first of these repetitive disclosures, (b) the frequency, periodicity or number of these repetitive disclosures and (c) the date of the last of these repetitive disclosures. Business Associate will make this disclosure information available to Recipient or its Subsidiaries promptly upon Recipient's or its Subsidiaries' request.

2. Exceptions from Disclosure Tracking. Business Associate need not record disclosure information or otherwise account for disclosures of PHI that this Addendum or Recipient or the relevant Subsidiary in writing permits or requires (i) for the purpose of Recipient's or its Subsidiaries' treatment activities, payment activities, or health care operations, (ii) to the individual who is the subject of the PHI disclosed or to that individual's personal representative; (iii) to persons involved in that individual's health care or payment for health care; (iv) for notification for disaster relief purposes, (v) for national security or intelligence purposes, (vi) to law enforcement officials or correctional institutions regarding inmates; or (vii) pursuant to an authorization; (viii) for disclosures

---

of certain PHI made as part of a Limited Data Set; (ix) for certain incidental disclosures that may occur where reasonable safeguards have been implemented; and (x) for disclosures prior to April 14, 2003.

3. Disclosure Tracking Time Periods. Business Associate must have available for Recipient and its Subsidiaries the disclosure information required by this

section for the 6 years preceding Recipient's or its Subsidiaries' request for the disclosure information (except Business Associate need have no disclosure information for disclosures occurring before April 14, 2003).

VI. Additional Business Associate Provisions

A. Reporting of Breach of Privacy Obligations. Business Associate will provide written notice to whichever of the Recipient or its Subsidiary for which the relevant PHI was created or from which the relevant PHI was received of any use or disclosure of PHI that is neither permitted by this Addendum nor given prior written approval by Recipient or the relevant Subsidiary promptly after Business Associate learns of such non-permitted use or disclosure. Business Associate's report will at least:

- (i) Identify the nature of the non-permitted use or disclosure;
- (ii) Identify the PHI used or disclosed;
- (iii) Identify who made the non-permitted use or received the non-permitted disclosure;
- (iv) Identify what corrective action Business Associate took or will take to prevent further non-permitted uses or disclosures;
- (v) Identify what Business Associate did or will do to mitigate any deleterious effect of the non-permitted use or disclosure; and
- (vi) Provide such other information, including a written report, as Recipient or the relevant Subsidiary may reasonably request.

B. Amendment. Upon the effective date of any final regulation or amendment to final regulations promulgated by the U.S. Department of Health and Human Services with respect to PHI, including, but not limited to the HIPAA privacy and security regulations, this Addendum and the Agreement will automatically be amended so that the obligations they impose on Business Associate remain in compliance with these regulations.

In addition, to the extent that new state or federal law requires changes to Business Associate's obligations under this Addendum, this Addendum shall automatically be amended to include such additional obligations, upon notice by Recipient or its Subsidiaries to Business Associate of such obligations. Business Associate's continued performance of services under the Agreement shall be deemed acceptance of these additional obligations.

C. Audit and Review of Policies and Procedures. Business Associate agrees to provide, upon Recipient request, access to and copies of any policies and procedures developed or utilized by Business Associate regarding the protection of PHI. Business Associate agrees to provide, upon Recipient's request, access to Business Associate's internal practices, books, and records, as they relate to Business Associate's services, duties and obligations set forth in this Addendum and the Agreement(s) under which Business Associate provides services and / or products to or on behalf of Recipient or its Subsidiaries, for purposes of Recipient's or its Subsidiaries' review of such internal practices, books, and records.

SCHEDULE C

CEDING COMMISSION

The Ceding Commission shall be the sum of the following:

- 1. an amount equal to the excess of the Total SAP Ceded Reserves over Total GAAP Ceded Reserves measured as of the close of business on the day immediately preceding the Inception Date (which amount may be negative);
- 2. an amount equal to the unamortized PVFP intangible asset balance of the Company (excluding any related mark to market adjustments for SFAS 115 requirement) with respect to the Reinsured Contracts as measured as of the close of business on the day immediately preceding the Inception Date, determined in accordance with GAAP;
- 3. an amount equal to the unamortized deferred acquisition costs of the Company (excluding any related mark to market adjustments for SFAS 115 requirement) with respect to the Reinsured Contracts as measured as of the close of business on the day immediately preceding the Inception Date, determined in accordance with GAAP; and
- 4. an amount equal to the excess of the GAAP book value of the Assets (excluding any related mark to market adjustments for SFAS 115 requirement) over the SAP book value of the Assets measured as of the close of business on the day immediately preceding the Inception Date (which amount may be negative).

SCHEDULE D

ASSETS

Transfer Document		From	To	Nature of Transfer	Cash Map Cross-Reference		Schedule	
GECLANY SS Coinsurance		GECLANY	UFLIC	Treaty	(87)		Schedule D	
Called Securities*	Parent Name	Issuer Name	1Q04 Cusip	1Q04 Tax lot	12/31/03 Local Par	12/31/03 GAAP BV (incl attached derivative)	12/31/03 Accrued Interest	12/31/03 STAT BV + Accrued Interest

[Individual Asset Details Omitted]

Asset Sub Total	372,765,989.34	6,381,126.81	379,147,116.15	372,753,784.91	6,381,126.81	379,134,911.72
Cash				20,269.30		20,269.30
<b>Total</b>				<b>372,774,054.21</b>		<b>379,155,181.02</b>

\* These Securities will not be transferred. The "Call Amount" will be settled in cash

SCHEDULE E

EXPENSE ALLOWANCES

The "Annual Expense Reimbursement Factor" used to calculate the Expense Allowance is as follows:

Policy Maintenance Factor           \$23.84 per Policy

Such Annual Expense Reimbursement Factor will be adjusted (i) for the year beginning January 1, 2005 and, thereafter, every three (3) years during the term of this Agreement based on a triennial cost/time study prepared in accordance with the methodology set forth below (the "Triennial Study") and (ii) for the years between the Triennial Studies based on a report setting forth the Annual Expense Reimbursement Factor prepared in accordance with the methodology set forth below (the "Annual Expense Reimbursement Factor Report").

(a) Triennial Study. As soon as practicable (and in any event within sixty (60) days) prior to January 1, 2005 and prior to the beginning of every third calendar year thereafter during the term of this Agreement, the Company shall cause to be prepared and delivered to the Reinsurer the Triennial Study which sets forth the Annual Expense Reimbursement Factor for the next calendar year, together with all supporting data used in preparing the Triennial Study and work papers, in reasonable detail, setting forth the determination of such Annual Expense Reimbursement Factors based on such Triennial Study (such documents, together with the Triennial Study, the "Triennial Study Documents").

(b) Annual Expense Reimbursement Factor Report. As soon as practicable (and in any event within thirty (30) days) prior to January 1, 2006 and prior to the beginning of each calendar year thereafter in which no Triennial Study is prepared, the Company shall cause to be prepared and delivered to the Reinsurer the Annual Expense Reimbursement Factor Report, together with all supporting data used in preparing the Annual Expense Reimbursement Factor Report and work papers, in reasonable detail, setting forth the determination of such Annual Expense Reimbursement Factor for the next calendar year (such documents, together with the Annual Expense Reimbursement Factor Report, the "Annual Expense Reimbursement Factor Documents").

(c) Methodology. At the time of the Triennial Study, historical costs (to include costs directly related to maintaining and administering policies, processing claims and reporting results) will be determined for the Policy Maintenance Factor identified above. For a given Annual Expense Reimbursement Factor the identified costs will be divided by the total historical number of units of measure for both the Reinsured Contracts and the retained block of business to derive an historical cost per unit. The historical cost per unit will be used as a prospective cost per unit for the next calendar year.

For the two succeeding years in the period between the Triennial Studies the historical dollar amounts by Policy Maintenance Factor will be adjusted (rolled forward) for current year cost changes agreed to by the Reinsurer and the Company (in accordance with the procedures set forth below). This rolled forward historical

cost will then be divided by the total historical number of units for the current period to determine a prospective cost per unit for the next calendar year.

An additional adjustment, positive or negative, to the prospective cost per unit determined by either the Triennial Study or the two succeeding years may be negotiated between the parties. The additional adjustment is for special projected costs or benefits of productivity, process improvements, inflation, loss of scale, and any other cost variation which was not included in the prior Triennial Study or the succeeding roll forward.

The combined prospective unit cost and additional adjustment is the Annual Expense Reimbursement Factor. The Expense Allowance will be determined quarterly and billed to the Reinsurer in three equal installments during the quarter at the end of the month. Each installment will be determined by multiplying the actual number of units at the beginning of the quarter covered by this Agreement times the Annual Expense Reimbursement Factor (divided by twelve).

(d) Review of Documents. Following the delivery of the Annual Expense Reimbursement Factor Documents or the Triennial Study Documents, as applicable, the Company shall (i) provide to the Reinsurer or its designated representative copies of such additional work papers and other documents relating to its preparation of the Annual Expense Reimbursement Factor Report or Triennial Study, as applicable, as the Reinsurer or its designated representative may reasonably request, including, without limitation, claims files and practices and (ii) cooperate with, and make its personnel and facilities reasonably available to, the Reinsurer and the Reinsurer's designated representative for the purpose of providing such other information as the Reinsurer or the Reinsurer's designated representative may reasonably request concerning Annual Expense Reimbursement Factor Documents or the Triennial Study Documents, as applicable, and the calculation of the Annual Expense Reimbursement Factor.

(e) Notice of Disagreement. In the event that the Reinsurer has any disagreement with any of the Annual Expense Reimbursement Factor Documents or the Triennial Study Documents, as applicable, the Reinsurer shall give written notice of all such disagreements (a "Notice of Disagreement") to the Company within thirty (30) days after the Annual Expense Reimbursement Factor Documents or the Triennial Study Documents, as applicable, are delivered to the Reinsurer. Any Notice of Disagreement shall set forth each item in disagreement and shall provide reasonable specificity as to the basis for each disagreement and shall specify the total adjustment to the Annual Expense Reimbursement Factor, as proposed by the Company as a result of such items in disagreement.

(f) Dispute Resolution. If the Reinsurer does not deliver a Notice of Disagreement to the Company within such thirty (30) day period, the Annual Expense Reimbursement Factor Documents and the Triennial Study Documents, as applicable, shall be final and binding upon the parties hereto and shall constitute the final calculation of the Annual Expense Reimbursement Factor for the next calendar year. If the Reinsurer delivers a Notice of Disagreement to the Company within such thirty (30) day period, the parties shall (and shall cause their respective designated representatives to) negotiate in good faith to resolve all disagreements as promptly as practicable. Any changes in the Annual Expense Reimbursement Factor, if any, that are agreed to by the Company and the Reinsurer within sixty (60) days of the

forementioned delivery of the Annual Expense Reimbursement Factor Documents or the Triennial Study Documents, as applicable, shall be incorporated into a final calculation of the Annual Expense Reimbursement Factor. If the parties and their respective designated representatives are unable to resolve all disagreements within sixty

(60) days of delivery of the Annual Expense Reimbursement Factor Documents or the Triennial Study Documents, as applicable, then all unresolved disagreements will be submitted within ten (10) days after the end of such sixty (60) day period for resolution in accordance herewith to an independent certified public accounting firm of national standing and reputation (the "Accounting Firm") mutually acceptable to the Company and the Reinsurer. The parties shall cooperate in good faith with the Accounting Firm and shall give the Accounting Firm access to all data and other information requested by the Accounting Firm for purposes of such resolution. The Accounting Firm shall, within thirty (30) days after its engagement, deliver to the Company and the Reinsurer a definitive calculation of the Annual Expense Reimbursement Factor, which shall be final and binding upon the parties hereto and shall be so reflected in the calculation of the Annual Expense Reimbursement Factor. The Company and the Reinsurer shall each pay one-half of the fees and expenses of the Accounting Firm.

(g) Expense Allowance Pending Resolution. In the event of a dispute with respect to any Annual Expense Reimbursement Factor for the next succeeding Calendar year, the Company and the Reinsurer agree that the Annual Expense Reimbursement Factor then in effect under this Agreement shall remain in effect pending resolution of such dispute and adjustment, if any, in accordance with the dispute resolution procedure set forth in paragraph (f) above.

SCHEDULE F – PART I

INITIAL REPORT

1. Total SAP Ceded Reserves		
Gross Policy Reserves calculated in accordance with SAP with respect to the reinsured risks.		\$
2. Ceding Commission:		
A.Excess SAP Ceded Reserves over GAAP Ceded Reserves:		
1) Total SAP Ceded Reserves	\$	
2) Total GAAP Ceded Reserves:		
Gross Policy Reserves calculated in accordance with GAAP with respect to the reinsured risks.	\$	
Excess SAP Reserves over GAAP Reserves (A1-A2)		\$
B.Present Value of Future Profits (PVFP)		\$
C.Deferred Acquisition Costs (DAC)		\$
D.Asset Book Value Difference -Measured as of close of business the day preceding the Inception Date		
1) Asset Book Value (GAAP basis)	\$	
2) Asset Book Value (SAP basis)	\$	
Excess Asset Book Value (D1-D2)		\$
Total Ceding Commission (A+B+C+D)		\$
3. Accrued Interest on Assets as of the day before Inception Date		\$
4. Investment Cash Flows on the Assets from the Inception Date through the Closing Date		\$
Net Due Reinsurer (1-2-3+4)		\$

SCHEDULE F – PART II

QUARTERLY REPORT

1. Benefits		\$
2. Withdrawals from Claims Settlement Account		\$
3. Expense Allowance		\$
I. Quarterly Settlement Amount (-1+2-3)		\$
Net Due to (from) Reinsurer		\$

SCHEDULE F – PART III

ANNUAL REPORT

1. Benefits		\$
2. Withdrawals from Claims Settlement Account		\$
3. Expense Allowance		\$
I. Quarterly Settlement Amount (-1+2-3)		\$
Net Due to (from) Reinsurer (I-II)		\$

SCHEDULE G

FORM OF TRUST AGREEMENT

SCHEDULE H

ELIGIBLE SECURITIES

Assets of the types for which an Illinois-domiciled life insurance company could obtain full statutory reserve credit under statutory accounting practices prescribed or permitted by the Director of Insurance of the State of Illinois.

---

## COINSURANCE AGREEMENT

between

AMERICAN MAYFLOWER LIFE INSURANCE  
COMPANY OF NEW YORK

and

UNION FIDELITY LIFE INSURANCE COMPANY

Dated as of April 15, 2004

TABLE OF CONTENTS

	<u>Page</u>
<a href="#">ARTICLE I</a>	1
<a href="#">ARTICLE II</a>	4
<a href="#">ARTICLE III</a>	5
<a href="#">ARTICLE IV</a>	8
<a href="#">ARTICLE V</a>	9
<a href="#">ARTICLE VI</a>	10
<a href="#">ARTICLE VII</a>	11
<a href="#">ARTICLE VIII</a>	11
<a href="#">ARTICLE IX</a>	12
<a href="#">ARTICLE X</a>	12
<a href="#">ARTICLE XI</a>	13
<a href="#">ARTICLE XII</a>	15
<a href="#">ARTICLE XIII</a>	15
<a href="#">ARTICLE XIV</a>	17
 <u>SCHEDULES</u>	
<a href="#">SCHEDULE A</a>	—
<a href="#">SCHEDULE B</a>	—
<a href="#">SCHEDULE C</a>	—
<a href="#">SCHEDULE D</a>	—
<a href="#">SCHEDULE E</a>	—
<a href="#">SCHEDULE F - PART I</a>	—
<a href="#">SCHEDULE F - PART II</a>	—
<a href="#">SCHEDULE F - PART III</a>	—
<a href="#">SCHEDULE G</a>	—
<a href="#">SCHEDULE H</a>	—

i

COINSURANCE AGREEMENT

This Coinsurance Agreement, dated as of April 15, 2004 (this "Agreement"), is made and entered into by and between American Mayflower Life Insurance Company of New York, an insurance company organized under the laws of the State of New York (the "Company"), and Union Fidelity Life Insurance Company, an insurance company organized under the laws of the State of Illinois (the "Reinsurer"). Defined terms used herein are defined below.

The Company and the Reinsurer mutually agree to reinsure the risks described in this Agreement under the terms and conditions stated herein. This Agreement is an indemnity coinsurance agreement solely between the Company and the Reinsurer, and the performance of the obligations of each party under this Agreement shall be rendered solely to the other party. In no instance shall anyone other than the Company or the Reinsurer have any rights under this Agreement. The Company shall be and shall remain the only party hereunder that is liable to any insured, contract holder, policyholder, claimant or beneficiary under any insurance policy or contract reinsured hereunder.

This Agreement is entered into in connection with an intercompany reorganization among the Company, the Reinsurer and certain of their Affiliates.

## ARTICLE I

DEFINITIONS

1.1. Definitions. As used in this Agreement, the following terms shall have the following meanings (definitions are applicable to both the singular and the plural forms of each term defined in this Article):

"Accounting Period" means calendar quarter, except that the last Accounting Period shall be the period commencing with the first day of the calendar quarter in which the Termination Date falls and ending with the Termination Date.

"Affiliate" means any other Person that directly or indirectly controls, is controlled by, or is under common control with, the first Person. "Control" (including the terms, "controlled by" and "under common control with") means the possession, directly or indirectly, of the power to direct or cause the direction of the management and policies of a Person, whether through the ownership of voting securities, by contract or credit arrangement, as trustee or executor, or otherwise.

"Agreement" shall have the meaning specified in the first paragraph of this Agreement.

“Annual Report” shall have the meaning specified in Section 7.4.

---

“Applicable Law” means any federal, state, local or foreign law (including common law), statute, ordinance, rule, regulation, order, writ, injunction, judgment, permit, governmental agreement or decree applicable to a Person or any of such Person’s subsidiaries, properties, assets, or to such Person’s officers, directors, managing directors, employees or agents in their capacity as such.

“Assets” shall have the meaning specified in Section 5.3(a).

“Assignment Letter Agreement” means the letter agreement dated the date hereof among General Electric Capital Corporation, a Delaware corporation, the Reinsurer, the Company and certain affiliates of the Company relating to the assignment by General Electric Capital Corporation of the Capital Maintenance Agreement.

“Benefits” shall have the meaning specified in Section 2.3(a).

“Business Day” means any day other than a Saturday, Sunday or other day on which commercial banks in the States of Illinois or Virginia are required or authorized by law to be closed.

“Capital Maintenance Agreement” means the Capital Maintenance Agreement between General Electric Capital Corporation, a Delaware corporation, and the Reinsurer.

“Ceding Commission” shall have the meaning specified in Section 5.2.

“Claims Settlement Account” shall have the meaning specified in Section 4.1(a).

“Closing Date” means April 15, 2004.

“Code” means the Internal Revenue Code of 1986, as amended.

“Company Account” shall have the meaning specified in Section 11.1(e).

“CPR” shall have the meaning specified in Section 13.3.

“CPR Arbitration Rules” shall have the meaning specified in Section 13.4(a).

“Dispute” shall have the meaning specified in Section 13.1(a).

“Eligible Securities” shall have the meaning specified in Section 11.1(c).

“Expense Allowance” shall have the meaning specified in Section 6.1.

“Extra Contractual Liabilities” means all liabilities for damages (including compensatory, consequential, exemplary, punitive, bad faith or similar or other damages) which relate to the marketing, sale, underwriting, issuance, delivery, cancellation or administration of the Reinsured Contracts, including liability arising out of or relating to any alleged or actual acts, errors or omissions by the Company or its agents, whether intentional or otherwise, with respect to any of the Reinsured Contracts, including (A) any alleged or actual reckless conduct or bad faith in connection with the handling of any claim arising out of or under Reinsured Contracts, or

(B) the marketing, sale, underwriting, issuance, delivery, cancellation or administration of any of the Reinsured Contracts.

“Force Majeure” shall have the meaning specified in Section 3.7(b)(iii).

“Funding Requirement” shall have the meaning specified in Section 11.1(e).

“GAAP” means U.S. generally accepted accounting principles consistently applied.

“Governmental Authority” means any foreign or national government, any state or other political subdivision thereof, and any entity exercising executive, legislative, judicial, regulatory or administrative functions of or pertaining to government.

“Inception Date” shall have the meaning specified in Section 2.1.

“Initial Notice” shall have the meaning specified in Section 13.2.

“Initial Reinsurance Premium” shall have the meaning specified in Section 5.1.

“Initial Report” shall have the meaning specified in Section 7.1.

“Insolvency Fund” means any guarantee fund, insolvency fund, plan, pool, association, fund or other arrangement, however denominated, established or governed, which provides for any assessment of or payment or assumption by the Company of part or all of any claim, debt, charge, fee or other obligation of an insurer or reinsurer, or its successors or assigns, which has been declared by any competent authority to be insolvent, or which is otherwise deemed unable to meet any claim, debt, charge, fee or other obligation in whole or in part.

“Minimum Claims Settlement Amount” shall have the meaning specified in Section 4.1(b).

“Person” means any natural person, firm, limited liability company, general partnership, limited partnership, joint venture, association, corporation, trust, Governmental Authority or other entity.

“Quarterly Report” shall have the meaning specified in Section 7.2.

“Quarterly Settlement” shall have the meaning specified in Section 5.3(a).

“RBC Reporting Letter Agreement” means the letter agreement dated the date hereof among the Company, the Reinsurer and certain affiliates of the Company relating to the Reinsurer’s requirement to provide periodic certifications and reports regarding the Reinsurer’s risk based capital ratio.

“Reinsured Contracts” means the structured settlements immediate annuity contracts issued by the Company and recorded in the Company’s valuation system on or prior to

December 3, 2003 or reinsured by the Company under reinsurance agreements in effect prior to January 1, 2004, and, in each case, written on the policy forms described in Schedule A.

“Reinsured Risks” shall have the meaning specified in Section 2.1.

“Response” shall have the meaning specified in Section 13.2.

“SAP” means statutory accounting practices prescribed or permitted by the Insurance Department of the State of New York.

“Tax DAC” means specified policy acquisition expenses capitalized and amortized under section 848 of the Code.

“Termination Date” means the effective date of any termination of this Agreement as provided in Article VIII.

“Termination Letter Agreement” means the letter agreement dated the date hereof among the Company, the Reinsurer and certain affiliates of the Company relating to the rescission of this Agreement upon the failure of certain events to occur after the date hereof.

“Total SAP Ceded Reserves” means, as of any given date, the gross policy reserves of the Company calculated in accordance with SAP with respect to the Reinsured Risks.

“Total GAAP Ceded Reserves” means, as of any given date, the gross policy reserves of the Company calculated in accordance with GAAP with respect to the Reinsured Risks.

“Trust Account” shall have the meaning set forth in Section 11.1(a).

“Trust Agreement” shall have the meaning set forth in Section 11.1(a).

“Trustee” shall have the meaning set forth in Section 11.1(a).

## ARTICLE II

### COVERAGE

2.1. Coverage. Upon the terms and subject to the conditions and other provisions of this Agreement, as of 12:01 a.m. Eastern Time on January 1, 2004 (the “Inception Date”), the Company hereby cedes to the Reinsurer, and the Reinsurer hereby agrees to indemnify the Company for, one hundred percent (100%) of the liability incurred by the Company for Benefits on or after the Inception Date (the “Reinsured Risks”).

2.2. Conditions. (a) If the Company’s liability under any of the Reinsured Contracts is changed because of changes made on or after the Inception Date in the terms and conditions of the Reinsured Contracts (including to any contract riders or endorsements thereto) that are required due to changes in Applicable Law, the Reinsurer will share in the change

proportionately to the coinsurance share hereunder and the Company and the Reinsurer will make all appropriate adjustments to amounts due each other under this Agreement.

(b) Except as otherwise set forth in paragraph (a) above, no changes, amendments or modifications made on or after the Inception Date in the terms and conditions of the Reinsured Contracts which adversely affect the liability of the Reinsurer hereunder shall be covered hereunder without the prior written approval of such changes, amendments or modifications by the Reinsurer, which approval shall not be unreasonably withheld or delayed. In the event that any such changes, amendments or modifications are made in any Reinsured Contract without the prior written approval of the Reinsurer, this Agreement will cover liability incurred by the Company for Benefits as if the non-approved changes, amendments or modifications had not been made.

2.3. Benefits. (a) Subject to the provisions of Sections 2.2, 2.3(b) and (c) and the terms and conditions of this Agreement, “Benefits” shall mean the actual benefits payable by the Company under the Reinsured Contracts.

(b) Any Extra Contractual Liabilities resulting from actions of the Company or its agents or reinsured by the Company under the Reinsured Contracts shall be treated as a Benefit payable for the purposes of this Agreement to the extent permitted by state law, except to the extent that any such Extra Contractual Liabilities are attributable to the conduct of the Company in the administration of the Reinsured Contracts on or after the Inception Date, other than actions taken by the Company at the written request or direction of the Reinsurer.

(c) This Agreement excludes all liability arising by contract, operation of law, or otherwise from the Company’s participation or membership, whether voluntary or involuntary, in any Insolvency Fund.

2.4. Territory. The territorial limits of this Agreement shall be identical with those of the Reinsured Contracts.

2.5. Ceded Reinsurance. Subsequent to the Inception Date, the Company will not enter into any reinsurance arrangements with respect to the Reinsured Contracts without the prior written consent of the Reinsurer, in its sole discretion.

## ARTICLE III

### ADMINISTRATION: GENERAL PROVISIONS

3.1. Contract Administration. (a) Subject to Section 3.7, the Company shall provide policyholder and claims servicing with respect to the Reinsured Contracts in accordance with the terms hereof. All Benefits paid by the Company shall be binding upon the Reinsurer; provided, however, that such Benefits are within the terms, conditions and limitations of the Reinsured Contracts. The Company shall provide policyholder and claims servicing with respect to the Reinsured Contracts (including the administration of claims for Benefits thereunder) in good faith and with the care, skill, prudence and diligence of a person experienced in administering structured settlement business. The Company shall provide policyholder and



claims servicing with respect to the Reinsured Contracts, (i) in accordance with the terms of the Reinsured Contracts, (ii) in accordance with the applicable terms of this Agreement, (iii) in compliance with Applicable Law and, subject to the foregoing, (iv) in the same manner as it conducts its own business not subject to this Agreement and (v) in accordance with the Company's administrative performance standards in effect on the date hereof, with such revisions to such standards as are no less favorable to the Reinsurer than such standards. Notwithstanding the foregoing, the parties may, from time to time, mutually develop specific and/or different standards for providing such services with respect to the Reinsured Contracts.

(b) The Company may subcontract for the performance of any policyholder or claims servicing service or services with respect to the Reinsured Contracts to (i) an Affiliate or (ii) any other Person with the prior written consent of the Reinsurer, such consent not to be unreasonably withheld; provided, that the Company also subcontracts for such service or services for its own structured settlement annuities business not subject to this Agreement to such subcontractor; and provided, further, that no such subcontracting shall relieve the Company from any of its obligations or liabilities hereunder, and the Company shall remain responsible for all obligations or liabilities of such subcontractor with regards to the providing of such service or services as if provided by the Company.

3.2. Claims Settlements. The Company agrees that it will provide prompt notice to the Reinsurer of its intention to contest, compromise or litigate a claim with respect to a Reinsured Contract, along with copies of all pleadings and reports of investigation with respect thereto. The Reinsurer shall have the right, at its own expense, to participate jointly with the Company in the investigation, adjustment or defense of such claims. In addition, in the event that litigation arises against the Company in connection with a claim which seeks damages in excess of \$1 million or other remedies deemed material to the Reinsurer, the Reinsurer may, upon written notice to the Company, assume the defense thereof with counsel selected by the Reinsurer and reasonably satisfactory to the Company. If the Reinsurer assumes such defense, the Company shall have the right, at its own expense, to participate jointly with the Reinsurer in the defense thereof. If the Reinsurer assumes the defense of litigation, the Reinsurer shall not settle such litigation without the Company's prior written consent (which consent shall not be unreasonably withheld or delayed) unless (i) there is no finding or admission of any violation of law or any violation of the rights of any Person, (ii) such settlement would not reasonably be expected to have material adverse precedential consequences to the Company and (iii) the sole relief provided is monetary damages that are paid in full by the Reinsurer.

3.3. Inspection. The Company shall keep accurate and complete records, files and accounts of all transactions and matters with respect to the Reinsured Contracts and the administration hereof in accordance with Applicable Law and its record management practices in effect from time to time for the Company's insurance business not covered by this Agreement. The Reinsurer and its designated representatives may upon reasonable notice inspect, at the offices of the Company where such records are located, the papers and all other books or documents of the Company reasonably relating to this Agreement, including the Reinsured Contracts and the administration thereof by the Company (including compliance with the provisions of Section 3.1), and shall have access to appropriate employees and representatives of the Company, in each case during normal business hours for such period as this Agreement is in effect or for as long thereafter as the Company seeks performance by the Reinsurer pursuant to

6

---

the terms of this Agreement or the Reinsurer reasonably needs access to such records for regulatory, tax or similar purposes. The information obtained shall be used only for purposes relating to the transactions contemplated under this Agreement.

3.4. Errors and Omissions. If any delay, omission, error or failure to pay amounts due or to perform any other act required by this Agreement is unintentional and caused by misunderstanding or oversight, the Company and the Reinsurer will adjust the situation to what it would have been had the misunderstanding or oversight not occurred. The party first discovering such misunderstanding or oversight, or an act resulting from such misunderstanding or oversight, will notify the other party in writing promptly upon discovery thereof, and the parties shall act to correct such misunderstanding or oversight within twenty (20) Business Days of such other party's receipt of such notice. However, this Section shall not be construed as a waiver by either party of its right to enforce strictly the terms of this Agreement.

3.5. Age, Sex and Other Adjustments. If the Company's liability under any of the Reinsured Contracts is changed because of a misstatement of age or sex or any other material fact, the Reinsurer will share in the change proportionately to the coinsurance share hereunder and the Company and the Reinsurer will make all appropriate adjustments to amounts due each other under this Agreement.

3.6. Setoff. Any debts or credits, matured or unmatured, in favor of or against either the Company or the Reinsurer with respect to this Agreement are deemed mutual debts or credits, as the case may be, and shall be setoff from any amounts due to the Company or the Reinsurer hereunder, as the case may be, and only the net balance shall be allowed or paid.

3.7. Administration by Reinsurer. (a) At any time from and after the fifteenth (15th) anniversary of the Inception Date, the Reinsurer shall have the right to assume from the Company the administration of the Reinsured Contracts, provided that the Reinsurer provides twelve (12) months prior written notice of such assumption, which notice may be given as early as the fourteenth (14th) anniversary of the Inception Date to take effect as of the fifteenth (15th) anniversary of the Inception Date. The Reinsurer shall bear all transition costs associated with an assumption of the administration of the Reinsured Contracts pursuant to this paragraph (a) of this Section 3.7.

(b) In addition to the provisions of Section 3.7(a), the Reinsurer shall have the right, upon written notice to the Company to assume from the Company the administration of the Reinsured Contracts upon the occurrence of any of the following events:

- (i) A voluntary or involuntary proceeding is commenced in any jurisdiction by or against the Company for the purpose of conserving, rehabilitating or liquidating the Company;
- (ii) There is a material breach by the Company of any material term or condition of this Article III that is not cured by the Company within thirty (30) days after receipt of written notice from the Reinsurer of such breach or act (provided that the Reinsurer shall not have the right to assume such administration (A) for so long as the Company is making a good faith

7

---

effort to cure such a breach, not to exceed an additional one hundred eighty (180) days or (B) during the pendency of any dispute resolution proceedings as set forth in Article XIII regarding an alleged material breach); or

- (iii) The Company is unable to perform the services required under this Article III for a period of thirty (30) consecutive days for any reason, other than as a result of a Force Majeure, it being understood that nothing in this Section 3.7(b)(iii) shall relieve the Company from its administrative responsibilities under this Agreement. For purposes of this Agreement "Force Majeure" means any acts or omissions of any civil or military authority, acts of God, acts or omissions of the Reinsurer, fires, strikes or other labor disturbances, equipment failures, fluctuations or non-availability of electrical power, heat, light, air conditioning or telecommunications equipment, or any other act, omission or occurrence beyond the Company's reasonable control, irrespective of whether similar to the foregoing enumerated acts, omissions or occurrences.

(c) The Company shall bear all transition costs associated with an assumption of the administration of the Reinsured Contracts pursuant to Section 3.7(b).

(d) In the event of the Reinsurer's assumption of the administration of the Reinsured Contracts, the Reinsurer and the Company shall enter into an administrative services agreement in the form attached hereto as Schedule B and the provisions of Article VI shall become inoperative.

#### ARTICLE IV

##### CLAIMS SETTLEMENT ACCOUNT; CLAIMS

4.1. Claims Settlement Account. (a) On the Closing Date, the Reinsurer shall establish a separate bank account (the "Claims Settlement Account") in its own name for the payment of Benefits and shall authorize two signatories who shall be representatives of the Company and approved by the Reinsurer in writing to issue drafts in the name of the Reinsurer and showing the identity of the Company. The Reinsurer shall fund such account for payment of Benefits in accordance with the provisions of Section 4.1(b). Any interest earned on the Claims

Settlement Account shall belong to the Reinsurer. The Claims Settlement Account shall be administered by the Company in a fiduciary capacity and shall be used solely by the Company to make payments of Benefits in accordance with the terms of this Agreement.

(b) The Reinsurer shall deposit \$2 million in the Claims Settlement Account on the Closing Date and shall thereafter fund the Claims Settlement Account on or before the fifth (5th) day of each month in amounts agreed by the Company and the Reinsurer from time to time in amounts sufficient to provide funds to the Company for the payment of Benefits during the next thirty (30) days, or such other amount as may be mutually agreed by the parties (such initial deposit amount and each minimum funding amount as agreed from time to time shall be

8

---

referred to as a "Minimum Claims Settlement Amount"). In addition, the Reinsurer shall deposit to the Claims Settlement Account such additional amounts as may be required to keep the balance of such account above zero at all times. In consideration of the Reinsurer providing the Claims Settlement Account arrangement, the Company agrees that it shall apply funds in the Claims Settlement Account against the Reinsurer's liability under this Agreement until such funds are exhausted.

(c) The Company shall keep true and complete records, in accordance with Applicable Law and its record management practices in effect from time to time for the Company's insurance business not covered by this Agreement, clearly recording the deposits in and withdrawals from the Claims Settlement Account, including records relating to the payment of Benefits from the Claim Settlement Account. The Company will make available to the Reinsurer or its designated representative, or shall furnish to the Reinsurer or its designated representative, upon request of the Reinsurer or its designated representative, copies of all such records. All copies furnished in the ordinary course of business shall be furnished by the Company at the Company's cost, which shall be included in the Expense Allowance. Any extraordinary costs reasonably incurred by the Company in response to requests from the Reinsurer shall be reimbursed by the Reinsurer.

(d) Within thirty (30) days after each calendar month (or more frequently as mutually agreed by the parties), the Company shall render a complete accounting to the Reinsurer detailing all transactions with respect to the Claims Settlement Account, in such form as agreed by the parties.

(e) The parties agree to deliver to the depository bank such depository resolutions, signature cards and other documents as may be requested of them in order to use such accounts at the depository bank in accordance with the provisions of this Article IV.

(f) Upon a termination of this Agreement pursuant to Article VIII, the Reinsurer shall close the Claims Settlement Account and any closing balance therein shall be the property of the Reinsurer. The Company's claims payment authority under this Agreement with respect to the Claims Settlement Account shall terminate immediately upon termination of this Agreement pursuant to Article VIII or the assumption by the Reinsurer of the administration of the Reinsured Contracts pursuant to Section 3.7. Upon termination of its authority to pay claims, the Company shall promptly return to the Reinsurer all unused check stock held by it in connection with this Agreement.

#### ARTICLE V

##### REINSURANCE ASSET TRANSFER; CEDING COMMISSION

5.1. Initial Reinsurance Premium. As consideration for the reinsurance by the Reinsurer of the Reinsured Risks under this Agreement, on the Closing Date the Reinsurer shall be entitled to an amount equal to one hundred percent (100%) of the Total SAP Ceded Reserves as of the close of business on the day immediately preceding the Inception Date (the "Initial Reinsurance Premium").

9

---

5.2. Ceding Commission. On the Closing Date, the Company shall be entitled to a ceding commission (the "Ceding Commission") in an amount determined in accordance with Schedule C.

5.3. Amounts Due the Parties. (a) Except as otherwise specifically provided herein, all amounts due to be paid to the Company under this Agreement shall be determined on a net basis, giving full effect to Section 3.6. The net amount due the Reinsurer from the Company on the Closing Date under Section 5.1 and Section 5.2 shall consist of (i) the investment assets (the "Assets") set forth on Schedule D, which assets have a statutory book value as of the close of business on the day immediately preceding the Inception Date equal to (A) the Initial Reinsurance Premium, less (B) the Ceding Commission, less (C) an amount equal to accrued but unpaid interest on the Assets as of the close of business on the day immediately preceding the Inception Date, plus (ii) an amount equal to the investment cash flows received on the Assets between the Inception Date and the Closing Date. The Company shall pay such net amount concurrent with its delivery of the Initial Report. Each net amount subsequently due with respect to each Accounting Period ending after the Inception Date (the "Quarterly Settlement") shall be paid in cash by the Reinsurer to the Company no later than thirty (30) days after delivery of the Quarterly Report, as applicable. Each net amount subsequently due with respect to each calendar year ending after the Inception Date as reflected on an Annual Report shall be paid in cash by the Reinsurer to the Company no later than thirty (30) days after delivery of the Annual Report.

(b) The Company shall deliver to the Reinsurer possession of the Assets and such bills of sale, endorsements, assignments and other good and sufficient instruments of conveyance and transfer in form and substance reasonably acceptable to the parties as shall be effective to vest in the Reinsurer all of the right, title and interest of the Company in and to the Assets. Delivery of the Assets shall be a condition precedent of reinsurance coverage hereunder.

#### ARTICLE VI

##### EXPENSE ALLOWANCES

6.1. Expense Allowance. As reimbursement for expenses incurred by the Company in the providing of policyholder and Benefit payment services with respect to the Reinsured Contracts, the Reinsurer shall pay to the Company with respect to each calendar month ending after the Inception Date, an expense allowance (each an "Expense Allowance") in an amount calculated in accordance with Schedule E, as subsequently adjusted in accordance with the methodology and procedures set forth on Schedule E.

10

---

#### ARTICLE VII

##### ACCOUNTING AND SETTLEMENT

7.1. Initial Report. A report shall be provided by the Company to the Reinsurer on the Closing Date providing the data required in Schedule F - Part I (the "Initial Report").

7.2. Quarterly Settlement Reports. As soon as practicable but not more than forty (40) days following each Accounting Period ending after the Closing Date (or more

frequently as mutually agreed by the parties), the Company shall supply the Reinsurer with a report that shall provide the financial data for such Accounting Period required in Schedule F - Part II (the "Quarterly Report"). For the avoidance of doubt, the first Quarterly Report will include all transactions with respect to the Reinsured Contracts occurring from the Inception Date through June 30, 2004.

7.3. Quarterly Financial Reports. As soon as practicable but not more than forty (40) days following the end of each Accounting Period ending after the Closing Date (or more frequently as mutually agreed by the parties), the Company shall supply the Reinsurer with reports related to the Reinsured Contracts as may be reasonably requested for use in connection with the preparation of the Reinsurer's SAP financial statements or other reports prepared by the Reinsurer in compliance with its internal reporting requirements. The parties shall cooperate in good faith to establish the form for the providing of such reports.

7.4. Annual Reports. Within forty-five (45) days after the end of each calendar year during the term of this Agreement (or more frequently as mutually agreed by the parties), the Company shall supply the Reinsurer with a report that shall provide the financial data for such year required in Schedule F - Part III (the "Annual Report").

7.5. Additional Reports and Updates. For so long as this Agreement remains in effect, each of the parties shall periodically furnish to the other such other reports and information as may be reasonably requested by such other party for regulatory, tax or similar purposes and reasonably available to it.

7.6. Delayed Payments. In the event that all or any portion of any payment due either party pursuant to this Agreement becomes overdue, the portion of the amount overdue shall bear interest at an annual rate equal to the then current thirty (30) day U.S. Treasury Bill discount rate on the date that the payment becomes overdue plus 200 basis points, for the period that the amount is overdue.

## ARTICLE VIII

### DURATION AND TERMINATION

8.1. Duration. Except as otherwise provided herein, this Agreement shall be unlimited in duration.

11

---

8.2. Reinsurer's Liability. The Reinsurer's liability with respect to the Reinsured Risks will terminate on the earliest of: (i) the date the Company's liability with respect to the Reinsured Risks is terminated and all amounts due the Company from the Reinsurer with respect to such Reinsured Risks are paid to the Company by or on behalf of the Reinsurer; and (ii) the date this Agreement is terminated upon the written agreement of the parties.

8.3. Notice of Termination. Upon the termination of the Reinsurer's liability with respect to the Reinsured Risks referred to in Section 8.2 above, the parties shall mutually give the Trustee written notice of their intention to terminate the Trust Account.

## ARTICLE IX

### INSOLVENCY

9.1. Payments. In the event of the insolvency of the Company, all reinsurance made, ceded, renewed or otherwise becoming effective under this Agreement shall be payable by the Reinsurer directly to the Company or to its liquidator, receiver, or statutory successor on the basis of the liability of the Company under the contracts reinsured, without diminution because of the insolvency of the Company. It is agreed and understood, however, that (i) in the event of the insolvency of the Company, the Reinsurer shall be given written notice of the pendency of a claim against the insolvent Company on a Reinsured Contract within a reasonable time after such claim is filed in the insolvency proceeding and (ii) during the pendency of such claim the Reinsurer may investigate such claim and interpose, at its own expense, in the proceeding where such claim is to be adjudicated any defenses which it may deem available to the Company or its liquidator, receiver or statutory successor.

9.2. Expenses. It is further understood that any expense thus incurred by the Reinsurer pursuant to Section 9.1 shall be chargeable, subject to court approval, against the insolvent Company as part of the expense of liquidation to the extent of a proportionate share of the benefit which may accrue to the Company solely as a result of the defense undertaken by the Reinsurer. Where two or more assuming reinsurers are involved in the same claim and a majority in interest elect to interpose defenses to such claim, the expense shall be apportioned in accordance with the terms of this Agreement as though such expense had been incurred by the Company.

## ARTICLE X

### CREDIT FOR REINSURANCE

10.1. Reinsurance Credit. Notwithstanding any other provision of this Agreement to the contrary, if the Reinsurer becomes unauthorized or otherwise unaccredited as an insurer or reinsurer in any U.S. jurisdiction to which the Company must provide statutory statements of financial condition such that the Company will not obtain full statutory financial statement credit for reinsurance in such state for the reinsurance provided under this Agreement, the Reinsurer, upon the request of the Company, will establish, at the Reinsurer's sole cost and

12

---

option, trust accounts for the benefit of the Company, letters of credit, or other acceptable alternatives necessary to permit the Company to obtain such full statutory financial statement credit for such reinsurance in all applicable jurisdictions. The Company shall cooperate with the Reinsurer to take such steps. In addition, in such event, the Reinsurer agrees to amend this Agreement and the Trust Agreement to the extent required under Applicable Law in order to provide the Company with such full statutory financial statement credit.

## ARTICLE XI

### REINSURANCE SECURITY

11.1. Trust. (a) On the Closing Date, the Reinsurer shall enter into a trust agreement in the form attached as Schedule G (the "Trust Agreement") and establish a trust account (the "Trust Account") for the benefit of the Company with respect to the Reinsured Risks with a bank (the "Trustee") designated as a Qualified United States Financial Institution by the Securities Valuation Office of the National Association of Insurance Commissioners or any successor organization or regulatory agency having similar duties.

(b) The Reinsurer agrees to deposit, and maintain in the Trust Account with respect to this Agreement, assets to be held in trust by the Trustee for the benefit of the Company as security for the payment of the Reinsurer's obligations to the Company under this Agreement.

(c) The parties agree that the assets so deposited with respect to this Agreement shall be valued according to their current statutory book value on the books of the Reinsurer and shall consist only of cash (United States legal tender), certificates of deposit (issued by a United States bank and payable in United States legal tender), and other assets of the type specified on Schedule H attached hereto ("Eligible Securities").

(d) The Reinsurer, prior to depositing assets with the Trustee, shall execute all assignments and endorsements in blank, or transfer legal title to the Trustee of all shares, obligations or any other assets requiring assignments, in order that, to the extent practicable, the Company, or the Trustee upon direction of the Company, may whenever necessary negotiate any

such assets without consent or signature from the Reinsurer or any other entity. The Company recognizes that certain assets in the Trust Account will not be readily negotiable and that certain notices, opinions of counsel, representations and/or consents will be required for the Company to obtain good and marketable title to such assets.

- (e) The Reinsurer and the Company agree that the assets in the Trust Account with respect to this Agreement may be withdrawn for the following purposes only:
  - (i) to pay or reimburse the Company for any amount due the Company pursuant to this Agreement to the extent not so paid or reimbursed by the Reinsurer;
  - (ii) to pay to the Reinsurer, in accordance with paragraph (h) below, any amounts held in the Trust Account that exceed an amount (the "Funding

13

---

Requirement") equal to the sum of Total SAP Ceded Reserves and any additional reserves attributable to the Reinsured Risks that arise as a result of regulatory asset adequacy analysis requirements of the Reinsurer, less, prior to the date on which the Claims Settlement Account is closed, the Minimum Claims Settlement Amount then in effect; and

- (iii) in the event that General Electric Capital Corporation breaches its obligations under the Capital Maintenance Agreement, to fund an account with the Company (the "Company Account") in an amount at least equal to the deduction, for reinsurance ceded, from the Company's liabilities ceded under this Agreement. Such amount shall include, but not be limited to, amounts for policy reserves, reserves for claims and losses incurred (including losses incurred but not reported), loss and loss adjustment expenses, and unearned premiums.

(f) In the event that the Company withdraws assets from the Trust Account for the purposes set forth in Section 11.1(e)(i) above in excess of actual amounts required to meet the Reinsurer's obligations to the Company, the Company will promptly return such excess to the Reinsurer, plus interest at an annual rate equal to the then current thirty (30) day U.S. Treasury Bill discount rate on the date of withdrawal plus 200 basis points for the period during which the amounts were held pursuant to Section 11.1(e)(i). In the event that the Company withdraws assets from the Trust Account for the purposes set forth in Section 11.1(e)(iii) above, (i) the Reinsurer shall be relieved of its obligation to maintain assets in the Trust Account pursuant to this Section 11.1 to the extent of the amount of funds held in the Company Account and (ii) the Company shall first apply the funds in the Company Account in satisfaction of the Reinsurer's liability under this Agreement until the funds in the Company Account are exhausted. In the event that the Company withdraws assets from the Trust Account for the purposes set forth in Section 11.1(e)(iii) above, promptly following the date the Reinsurer's liability with respect to the Reinsured Risks is terminated, the Company shall return to the Reinsurer any assets so withdrawn that, together with any and all interest, dividends and other earnings thereon from the date of withdrawal to the date of return, are in excess of actual amounts required to meet the Reinsurer's obligations to the Company under this Agreement.

(g) The initial deposit to the Trust Account with respect to this Agreement shall be made on the Closing Date and shall consist of assets with a statutory book value equal to the Total SAP Ceded Reserves as of the close of business on the day immediately preceding the Inception Date, less an amount of assets with a statutory book value equal to the initial Minimum Claims Settlement Amount.

(h) The aggregate statutory book value of the assets held in the Trust Account with respect to this Agreement, shall at all times be at least equal to the Funding Requirement, and shall be adjusted on a quarterly basis so as to equal the Funding Requirement. On a quarterly basis, the Company shall promptly prepare and deliver to the Reinsurer a specific statement of the Funding Requirement and the Reinsurer shall promptly prepare and deliver to the Company a specific statement of the statutory book value of the assets in the Trust Account, in each case as of the end of the quarter. If the statement shows that the Funding Requirement exceeds 100% of the balance of the Trust Account with respect to this Agreement as of the statement date, the Reinsurer shall, within ten (10) Business Days after receipt of such notice of excess, secure delivery to the Trustee of additional cash or Eligible Securities having a current statutory book value equal to such difference. If the statement shows that the Funding Requirement is less than 100% of the balance of the Trust Account with respect to this Agreement as of the

14

---

statement date, the Company shall, within ten (10) Business Days after delivery of such statement to the Reinsurer, deliver a notice of withdrawal to the Trustee directing the Trustee to withdraw from the Trust Account and deliver to the Reinsurer assets from the Trust Account having a current statutory book value equal to such excess amount. In addition to the foregoing, the Reinsurer shall prepare and deliver to the Company on a quarterly basis a specific statement of the market value of the assets in the Trust Account as of the end of the quarter.

## ARTICLE XII

### DEFERRED ACQUISITION COSTS

12.1. Tax DAC Information Sharing. To ensure consistency in their respective Tax DAC calculations for tax purposes, the Company and the Reinsurer will exchange information pertaining to the amount of net consideration under this Agreement each year. The Company will submit a schedule to the Reinsurer by February 28 of each year presenting its calculation of the net consideration for the preceding taxable year. The Reinsurer may contest the calculation by providing to the Company an alternative calculation in writing within thirty (30) days of receipt of the Company's schedule. The Company and the Reinsurer will act in good faith to resolve any differences in the schedule of calculations within thirty (30) days of receipt of the alternative calculation to ensure consistent amounts are reported on the respective tax returns for the preceding tax year.

## ARTICLE XIII

### DISPUTE RESOLUTION

13.1. General Provisions. (a) Any dispute, controversy or claim arising out of or relating to this Agreement or the validity, interpretation, breach or termination thereof (a "Dispute"), shall be resolved in accordance with the procedures set forth in this Article XIII, which shall be the sole and exclusive procedures for the resolution of any such Dispute unless otherwise specified below.

(b) Commencing with the request contemplated by Section 13.2, all communications between the parties or their representatives in connection with the attempted resolution of any Dispute, including any mediator's evaluation referred to in Section 13.3, shall be deemed to have been delivered in furtherance of a Dispute settlement and shall be exempt from discovery and production, and shall not be admissible in evidence for any reason (whether as an admission or otherwise), in any arbitral or other proceeding for the resolution of the Dispute.

15

---

(c) In connection with any Dispute, the parties expressly waive and forego any right to (i) punitive, exemplary, statutorily-enhanced or similar damages in excess of compensatory damages, and (ii) trial by jury.

(d) The specific procedures set forth below, including but not limited to the time limits referenced therein, may be modified by agreement of the parties in writing.

(e) All applicable statutes of limitations and defenses based upon the passage of time shall be tolled while the procedures specified in this Article XIII are pending. The parties will take such action, if any, required to effectuate such tolling.

13.2. Consideration by Senior Executives. If a Dispute is not resolved in the normal course of business at the operational level, the parties shall attempt in good faith to resolve such Dispute by negotiation between executives who hold, at a minimum, the office of President and CEO of the respective business entities involved in such Dispute. Either party may initiate the executive negotiation process by providing a written notice to the other (the "Initial Notice"). Fifteen (15) days after delivery of the Initial Notice, the receiving party shall submit to the other a written response (the "Response"). The Initial Notice and the Response shall include (i) a statement of the Dispute and of each party's position, and (ii) the name and title of the executive who will represent that party and of any other person who will accompany the executive. Such executives will meet in person or by telephone within thirty (30) days of the date of the Initial Notice to seek a resolution of the Dispute.

13.3. Mediation. If a Dispute is not resolved by negotiation as provided in Section 13.2 within forty-five (45) days from the delivery of the Initial Notice, then either party may submit the Dispute for resolution by mediation pursuant to the CPR Institute for Dispute Resolution (the "CPR") Model Mediation Procedure as then in effect. The parties will select a mediator from the CPR Panels of Distinguished Neutrals, but such mediator must have prior U.S. reinsurance experience either as a lawyer or as a present or former officer or management employee of a reinsurance company, but not of the Company, or the Reinsurer, or any of their respective affiliates. Either party at commencement of the mediation may ask the mediator to provide an evaluation of the Dispute and the parties' relative positions.

13.4. Arbitration. (a) If a Dispute is not resolved by mediation as provided in Section 13.3 within thirty (30) days of the selection of a mediator (unless the mediator chooses to withdraw sooner), either party may submit the Dispute to be finally resolved by arbitration pursuant to the CPR Rules for Non-Administered Arbitration as then in effect (the "CPR Arbitration Rules"). The parties consent to a single, consolidated arbitration for all known Disputes existing at the time of the arbitration and for which arbitration is permitted.

(b) The neutral organization for purposes of the CPR Arbitration Rules will be the CPR. The arbitral tribunal shall be composed of three arbitrators who are each experienced in the U.S. reinsurance business, of whom each party shall appoint one in accordance with the "screened" appointment procedure provided in Rule 5.4 of the CPR Arbitration Rules. The non-party appointed arbitrator must have prior U.S. reinsurance experience as a present or former officer or management employee of a reinsurance company, but not of the Company, or the Reinsurer, or any of their respective affiliates. The arbitration shall be conducted in New York

16

---

City. Each party shall be permitted to present its case, witnesses and evidence, if any, in the presence of the other party. A written transcript of the proceedings shall be made and furnished to the parties. The arbitrators shall determine the Dispute in accordance with the law of New York, without giving effect to any conflict of law rules or other rules that might render such law inapplicable or unavailable, and shall apply this Agreement according to its terms, provided that the provisions relating to arbitration shall be governed by the Federal Arbitration Act, 9 U.S.C. §§ 1 et seq. The arbitral tribunal shall endeavor to render its award or order resulting from any arbitration within forty-five (45) days following the termination of the arbitration proceedings.

(c) The parties agree to be bound by any award or order resulting from any arbitration conducted hereunder and further agree that judgment on any award or order resulting from an arbitration conducted under this Section may be entered and enforced in any court having jurisdiction thereof.

(d) Except as expressly permitted by this Agreement, no party will commence or voluntarily participate in any court action or proceeding concerning a Dispute, except (i) for enforcement as contemplated by Section 13.4(c) above, (ii) to restrict or vacate an arbitral decision based on the grounds specified under applicable law, or (iii) for interim relief as provided in paragraph (e) below. For purposes of the foregoing the parties hereto submit to the non-exclusive jurisdiction of the courts of the State of New York.

(e) In addition to the authority otherwise conferred on the arbitral tribunal, the tribunal shall have the authority to make such orders for interim relief, including injunctive relief, as it may deem just and equitable. Notwithstanding paragraph (d) above, each party acknowledges that in the event of any actual or threatened breach of certain of the provisions of this Agreement, the remedy at law would not be adequate, and therefore injunctive or other interim relief may be sought immediately to restrain such breach. If the tribunal shall not have been appointed, either party may seek interim relief from a court having jurisdiction if the award to which the applicant may be entitled may be rendered ineffectual without such interim relief. Upon appointment of the tribunal following any grant of interim relief by a court, the tribunal may affirm or disaffirm such relief, and the parties will seek modification or rescission of the court action as necessary to accord with the tribunal's decision.

(f) Each party will bear its own attorneys' fees and costs incurred in connection with the resolution of any Dispute in accordance with this Article XIII.

#### ARTICLE XIV

##### MISCELLANEOUS PROVISIONS

14.1. Headings and Schedules. Headings used herein are not a part of this Agreement and shall not affect the terms hereof. The attached Schedules are a part of this Agreement.

14.2. Notices. All notices, requests, demands and other communications under this Agreement must be in writing and will be deemed to have been duly given or made as follows: (a) if sent by registered or certified mail in the United States return receipt requested,

17

---

upon receipt; (b) if sent by reputable overnight air courier, two business days after mailing; (c) if sent by facsimile transmission, with a copy mailed on the same day in the manner provided in (a) or (b) above, when transmitted and receipt is confirmed by telephone; or (d) if otherwise actually personally delivered, when delivered, and shall be delivered as follows:

If to the Company:

American Mayflower Life Insurance Company of New York  
700 Main Street  
Lynchburg, VA 24504  
Facsimile: (434) 948-5064  
Attention: Chief Executive Officer

With a copy to:

American Mayflower Life Insurance Company of New York  
700 Main Street  
Lynchburg, VA 24504  
Facsimile: (434) 948-5819  
Attention: General Counsel

If to the Reinsurer:

Union Fidelity Life Insurance Company  
200 North Martingale Road  
Schaumburg, IL 60173-2096  
Facsimile: (847) 330-3404  
Attention: Chief Financial Officer

With a copy to:

Union Fidelity Life Insurance Company  
200 North Martingale Road  
Schaumburg, IL 60173-2096  
Facsimile: (847) 605-3044  
Attention: General Counsel

or to such other address or to such other Person as either party may have last designated by notice to the other party.

14.3. Successors and Assigns. This Agreement shall be binding upon and inure to the benefit of the parties hereto and their respective successors, permitted assigns and legal representatives. Neither this Agreement, nor any right or obligation hereunder, may be assigned by any party without the prior written consent of the other party hereto. Any assignment in violation of this Section 14.3 shall be void and shall have no force and effect. Nothing in this Section 14.3 shall be construed to prohibit the Reinsurer from retroceding all or any portion of the business reinsured hereunder.

18

---

14.4. Execution in Counterpart. This Agreement may be executed by the parties hereto in any number of counterparts, and by each of the parties hereto in separate counterparts, each of which counterparts, when so executed and delivered, shall be deemed to be an original, but all such counterparts shall together constitute but one and the same instrument.

14.5. Currency. Whenever the word "Dollars" or the "\$" sign appear in this Agreement, they shall be construed to mean United States Dollars, and all transactions under this Agreement shall be in United States Dollars.

14.6. Amendments. This Agreement may not be changed, altered or modified unless the same shall be in writing executed by the Company and the Reinsurer.

14.7. Governing Law. This Agreement will be construed, performed and enforced in accordance with the laws of the State of New York without giving effect to its principles or rules of conflict of laws thereof to the extent such principles or rules would require or permit the application of the laws of another jurisdiction.

14.8. Entire Agreement; Severability. (a) This Agreement and the Termination Letter Agreement constitute the entire agreement between the parties hereto relating to the subject matter hereof and supersede all prior and contemporaneous agreements, understandings, statements, representations and warranties, negotiations and discussions, whether oral or written, of the parties and there are no general or specific warranties, representations or other agreements by or among the parties in connection with the entering into of this Agreement or the subject matter hereof except as specifically set forth or contemplated herein or in the Termination Letter Agreement.

(b) If any provision of this Agreement is held to be void or unenforceable, in whole or in part, (i) such holding shall not affect the validity and enforceability of the remainder of this Agreement, including any other provision, paragraph or subparagraph, and (ii) the parties agree to attempt in good faith to reform such void or unenforceable provision to the extent necessary to render such provision enforceable and to carry out its original intent.

14.9. Contemporaneous Agreements. Concurrent with the execution of this Agreement, the parties and/or their Affiliates are also entering into the Capital Maintenance Agreement, the RBC Reporting Letter Agreement and the Assignment Letter Agreement.

14.10. No Waiver; Preservation of Remedies. No consent or waiver, express or implied, by any party to or of any breach or default by any other party in the performance by such other party of its obligations hereunder shall be deemed or construed to be a consent or waiver to or of any other breach or default in the performance of obligations hereunder by such other party hereunder. Failure on the part of any party to complain of any act or failure to act of any other party or to declare any other party in default, irrespective of how long such failure continues, shall not constitute a waiver by such first party of any of its rights hereunder. The rights and remedies provided are cumulative and are not exclusive of any rights or remedies that any party may otherwise have at law or equity.

14.11. Cooperation. Each party hereto shall cooperate fully with the other in all reasonable respects in order to accomplish the objectives of this Agreement including making

19

---

available to each their respective officers and employees for interviews and meetings with Governmental Authorities and furnishing any additional assistance, information and documents as may be reasonably requested by a party from time to time.

14.12. Third Party Beneficiary. Nothing in this Agreement will confer any rights upon any Person that is not a party or a successor or permitted assignee of a party to this Agreement.

14.13. Tax Exception to Any Confidentiality. Notwithstanding anything to the contrary set forth herein or in any other agreement to which the parties hereto are parties or by which they are bound, any obligations of confidentiality contained herein and therein, as they relate to the transactions, shall not apply to the federal tax structure or federal tax treatment of the transactions, and each party hereto (and any employee, representative, or agent of any party hereto) may disclose to any and all persons, without limitation of any kind, the federal tax structure and federal tax treatment of the transactions. The preceding sentence is intended to cause the transactions to be treated as not having been offered under conditions of confidentiality for purposes of Section 1.6011-4(b)(3) (or any successor provision) of the Treasury Regulations promulgated under Section 6011 of the Internal Revenue Code of 1986, as amended, and shall be construed in a manner consistent with such purpose. In addition, each party hereto acknowledges that it has no proprietary or exclusive rights to the federal tax structure of the transactions or any federal tax matter or federal tax idea related to the transactions.

14.14. Interpretation. Wherever the words "include," "includes" or "including" are used in this Agreement, they shall be deemed to be followed by the words "without limitation."

14.15. Survival. Article XIII and Article XIV shall survive the termination of this Agreement.











IN WITNESS WHEREOF, the parties hereto have caused this Agreement to be executed by their duly authorized representatives.

AMERICAN MAYFLOWER LIFE INSURANCE COMPANY OF NEW YORK

By /s/ VICTOR C. MOSES  
Name: Victor C. Moses  
Title: Senior Vice President and Chief Actuary

UNION FIDELITY LIFE INSURANCE COMPANY

By /s/ GLENN JOPPA  
Name: Glenn Joppa  
Title: Senior Vice President and Secretary



SCHEDULE A

POLICY FORMS

8001

8101

8201

8401

1700

AM-ANN-PPR

AM-ANN-PPR-Q

AML RA&Q





FORM OF ADMINISTRATIVE SERVICES AGREEMENT

SSA UFLIC/AML

ADMINISTRATIVE SERVICES AGREEMENT

by and between

AMERICAN MAYFLOWER LIFE INSURANCE COMPANY OF NEW YORK

and

UNION FIDELITY LIFE INSURANCE COMPANY

Effective as of [       ]

ADMINISTRATIVE SERVICES AGREEMENT

This ADMINISTRATIVE SERVICES AGREEMENT (this "Agreement"), effective as of [       ] (the "Effective Date"), is entered into by and between AMERICAN MAYFLOWER LIFE INSURANCE COMPANY OF NEW YORK, an insurance company organized under the laws of the State of New York (the "Company"), and UNION FIDELITY LIFE INSURANCE COMPANY, an insurance company organized under the laws of the State of Illinois (the "Administrator").

**RECITALS:**

WHEREAS, the Company and the Administrator have entered into a Coinsurance Agreement dated as of April 15, 2004 (the "Coinsurance Agreement") which provides for the parties to enter into this Agreement;

WHEREAS, pursuant to the Coinsurance Agreement, the Administrator has agreed to indemnify the Company for, among other things, 100% of the liability of the Company for Benefits payable on or after the Inception Date with respect to the Reinsured Contracts (capitalized terms used herein and not defined herein, unless otherwise indicated, have the respective meanings assigned to them in the Coinsurance Agreement); and

WHEREAS, the Company wishes to appoint the Administrator to provide policyholder and claim servicing with respect to the Reinsured Contracts as set forth herein, and the Administrator desires to provide such administrative services;

NOW, THEREFORE, in consideration of the covenants and agreements set forth herein, the parties hereto agree as follows:

ARTICLE I

AUTHORITY

As between the Company and the Administrator, the Company hereby appoints the Administrator, and the Administrator hereby accepts appointment, to provide as an independent contractor of the Company, from and after the Effective Date, all of the policyholder and claim servicing services necessary or appropriate with respect to the Reinsured Contracts including those set forth in this Agreement (the "Administrative Services"), all on the terms as set forth in this Agreement. Notwithstanding any other provision of this Agreement to the contrary, the Company shall have the final right to direct the Administrator in the performance of the Administrative Services in accordance with the standards for services set forth in Section 2.1, including the right to direct the Administrator to perform any action necessary for the Reinsured Contracts or the policyholder and claim servicing thereof to comply with Applicable Law, or to cease performing any action that constitutes a violation of Applicable Law. All services hereunder shall be performed by the Administrator in the name of and on behalf of the Company. The Administrator shall maintain a toll-free number for use by policyholders, certificateholders and

beneficiaries. Any and all correspondence with policyholders, certificateholders and beneficiaries and check stock utilized by the Administrator for payments under the Reinsured Contracts shall be in the name of the Company or in the name of the Administrator and disclosing that the Administrator is acting as the administrative agent of the Company.

ARTICLE II

STANDARD FOR SERVICES; FACILITIES; SUBCONTRACTING;  
POLICYHOLDER SERVICING



2.1. Standard for Services. The Administrator shall provide policyholder and claims servicing with respect to the Reinsured Contracts in good faith and with the care, skill, prudence and diligence of a person experienced in administering structured settlement business. Without limiting the generality of the foregoing, the Administrator shall provide policyholder and claims servicing with respect to the Reinsured Contracts (i) in accordance with the terms of the Reinsured Contracts, (ii) in accordance with the applicable terms of this Agreement, (iii) in compliance with Applicable Law, (iv) in accordance with industry standards, (v) in accordance with standards of service as agreed to by the Administrator and the Company and, subject to the foregoing, (vi) to the extent applicable, in the same manner as it conducts its own business not subject to this Agreement.

2.2. Facilities and Personnel. To the extent not sub-contracted to a Subcontractor, the Administrator shall at all times maintain sufficient facilities and trained personnel of the kind necessary to perform its obligations under this Agreement in accordance with the performance standards set forth herein.

2.3. Subcontracting. The Administrator may subcontract for the performance of any policyholder or claims servicing service or services with respect to the Reinsured Contracts to (i) an Affiliate or (ii) any other Person with the prior written consent of the Company, such consent not to be unreasonably withheld (in each case, the "Subcontractor"); provided, that, no such subcontracting shall relieve the Administrator from any of its obligations or liabilities hereunder, and the Administrator shall remain responsible for all obligations or liabilities of such Subcontractor with regards to the providing of such service or services as if provided by the Administrator.

2.4. Policyholder Servicing. The Administrator shall provide policyholder servicing with regards to the Reinsured Contracts, including changes of address, responding to policyholder inquiries and similar services.

### ARTICLE III

#### CLAIMS HANDLING

The Administrator shall pay all Benefits payable on or after the Inception Date with respect to the Reinsured Contracts (each, a "Claim" and collectively the "Claims") in accordance

2

---

with procedures and guidelines established by the Company, such procedures and guidelines to be in accordance with the standards of service set forth in Section 2.1.

### ARTICLE IV

#### REGULATORY AND LEGAL PROCEEDINGS

4.1. Regulatory Complaints and Proceedings. The Administrator shall:

- (i) respond to any Claims payment related complaints or inquiries made by any Governmental Authority, within the Governmental Authority's requested time frame for response or, if no such time frame is provided, within the time frame as allowed by Applicable Law; and promptly provide a copy of such response to the Company;
- (ii) promptly notify the Company of any non-Claims payment related complaints or inquiries initiated by a Governmental Authority, and of any proceedings (either Claims or non-Claims related) initiated by a Governmental Authority, and, in either case, prepare and send to the Governmental Authority, with a copy to the Company, a response within the Governmental Authority's requested time frame for response or, if no such time frame is provided, within the time frame as allowed by Applicable Law; provided, that, subject to meeting such time frames, the Administrator shall provide such response to the Company for its prior review and comment;
- (iii) subject to Section 4.4, supervise and control the investigation, contest, defense and/or settlement of all complaints, inquiries and proceedings by Governmental Authorities at its own cost and expense, and in the name of the Company when necessary; and
- (iv) at the Company's request, provide to the Company a report in a form mutually agreed by the parties summarizing the nature of any complaints, inquiries or proceedings by Governmental Authorities, the alleged actions or omissions giving rise to such complaints, inquiries or proceedings and copies of any files or other documents that the Company may reasonably request in connection with its review of these matters.

Notwithstanding the foregoing, the Company shall retain final authority for the resolution of inquiries by Governmental Authorities and consumer complaints; provided, however, the Company agrees to act reasonably in the exercise of such authority.

4.2. Legal Proceedings. The Administrator shall:

- (i) notify the Company promptly of any lawsuit, action, arbitration or other dispute resolution proceedings that are instituted or threatened with respect to any matter relating to the Reinsured Contracts ("Legal

3

---

Proceeding(s)"), and in no event more than five (5) Business Days after receipt of notice thereof;

- (ii) subject to Section 4.4, supervise and control the investigation, contest, defense and/or settlement of all Legal Proceedings at its own cost and expense, and in the name of the Company when necessary; and
- (iii) keep the Company fully informed of the progress of all Legal Proceedings handled by the Administrator in which the Company is named a party and, at the Company's request, provide to the Company a report summarizing the nature of any Legal Proceedings, the alleged actions or omissions giving rise to such Legal Proceedings and copies of any files or other documents that the Company may reasonably request in connection with its review of these matters in each case other than such files, documents and other information as would, in the judgment of counsel to the Administrator, lead to the loss or waiver of legal privilege.

4.3. Notice to Administrator. The Company shall give prompt notice to the Administrator of any Legal Proceeding made or brought against the Company after the Inception Date arising under or in connection with the Reinsured Contracts to the extent known to it and not made against or served on the Administrator or a Subcontractor as administrator hereunder, and in no event more than five (5) Business Days after receipt of notice thereof, and shall promptly furnish to the Administrator copies of all pleadings in connection therewith. The Administrator shall assume the defense of the Company.

4.4. Defense of Regulatory and Legal Proceedings. Notwithstanding anything in this Agreement to the contrary, the Company shall have the right to engage in its own separate legal representation, at its own expense, and to participate fully in the defense of any Legal Proceedings or complaints, inquiries or proceedings by Governmental Authorities with respect to the Reinsured Contracts in which the Company is a named party without waiving any right to indemnification it may have under Article XV hereof. The Administrator and the Company shall cooperate with each other with respect to the administration of any Legal Proceeding and any complaint, inquiry or proceeding by Governmental Authorities. The Administrator shall not settle any Legal Proceeding or any complaint, inquiry or proceeding by Governmental Authorities without the Company's prior written consent (which consent shall not be unreasonably withheld or delayed) unless (i) there is no finding or admission of any violation of law or any violation of the rights of any Person, (ii) such settlement would not reasonably be expected to have material adverse precedential consequences to the Company and (iii) the sole relief provided is monetary damages that are paid in full by the Administrator.

ARTICLE V

NOTIFICATION TO POLICYHOLDERS

The Administrator agrees to send to policyholders of the Reinsured Contracts a written notice prepared by the Administrator, reasonably acceptable to the Company and approved by

4

---

the New York Insurance Department to the effect that the Administrator, or such other Person designated by the Administrator in accordance with the terms of this Agreement, has been appointed by the Company to provide Administrative Services. The Administrator shall send such notice by first class U.S. mail at a time reasonably acceptable to the Company and the Administrator and in all events in accordance with Applicable Law. The parties intend to minimize the cost associated with any notification under this Article V, including by means of inclusion of the notice in a regularly scheduled mailing to policyholders in lieu of a separate mailing. The cost associated with such notification under this Article V (upon the initial assumption of the administration of the Reinsured Contracts under Section 3.7 of the Coinsurance Agreement) shall be a transition cost payable by the Administrator or the Company in accordance with Section 3.7(a) or 3.7(c) of the Coinsurance Agreement, as applicable.

ARTICLE VI

INSOLVENCY FUND ACCOUNTINGS

6.1. Quarterly Accountings. Within thirty (30) days after the end of each calendar quarter that this Agreement is in effect (or more frequently as mutually agreed by the parties), the Company shall submit to the Administrator a written statement of accounting in a form and containing such information to be agreed upon by the parties hereto (each, an "Insolvency Fund Quarterly Accounting") setting forth the Insolvency Fund amounts assessed or payable to the extent that such assessments constitute Reinsured Risks with respect to the Reinsured Contracts (collectively, the "Post-Effective Date Assessments"). The Administrator shall remit to the Company an amount equal to the Post-Effective Date Assessments set forth in an Insolvency Fund Quarterly Accounting received by the Administrator within ten (10) Business Days of receipt by the Administrator of such Insolvency Fund Quarterly Accounting.

6.2. Adjustments Regarding Insolvency Fund Accountings. In the event that subsequent data or calculations require revision of any of the Insolvency Fund Quarterly Accountings, the required revision and appropriate payments thereunder shall be made within ten (10) Business Days after the parties hereto mutually agree as to the appropriate revision.

ARTICLE VII

CERTAIN ACTIONS BY COMPANY

7.1. Filings. The Company shall prepare and timely file any filings required to be made with any Governmental Authority that relate to the Company generally and not just to the Reinsured Contracts, including filings with guaranty associations and filings and premium tax returns with taxing authorities. The Administrator shall, in a timely fashion in light of the dates such filings by the Company are required, provide to the Company all information in the possession of the Administrator with respect to the Reinsured Contracts that may be reasonably required for the Company to prepare such filings and tax returns.

7.2. Annual Adjustment. The Company shall pay or provide to the Administrator the benefit of any Post-Effective Date Assessments which have been or can be

5

---

applied to reduce the Company's premium tax liability ("Premium Tax Credits"). The Company shall provide to the Administrator by March 15 of each year a statement of the amount of Premium Tax Credits for the prior calendar year and the Company will pay or credit to the Administrator an amount equal to such Premium Tax Credits.

ARTICLE VIII

REGULATORY MATTERS AND AUDIT REPORTING

8.1. Regulatory Compliance and Reporting. The Administrator shall provide to the Company such information with respect to the Reinsured Contracts as is required to satisfy all current and future informational reporting, prior approval and any other requirements imposed by any Governmental Authority. Upon the reasonable request of the Company, the Administrator shall timely prepare such reports and summaries, including statistical summaries, as are necessary or reasonably required to satisfy any requirements imposed by a Governmental Authority upon the Company with respect to the Reinsured Contracts. In addition, the Administrator, upon the reasonable request of the Company, shall promptly provide to the Company copies of all existing records relating to the Reinsured Contracts (including, with respect to records maintained in machine readable form, hard copies) that are necessary to satisfy such requirements. All copies of records furnished in the ordinary course of business shall be furnished by the Administrator at the Administrator's cost. Any extraordinary costs reasonably incurred by the Administrator in response to requests from the Company shall be reimbursed by the Company. Among other responsibilities:

- (i) The Administrator shall promptly prepare and furnish to Governmental Authorities all reports and related summaries (including, without limitation, statistical summaries), certificates of compliance and other reports required or requested by a Governmental Authority.
- (ii) The Administrator shall assist the Company and cooperate with the Company in doing all things necessary, proper or advisable, in the most expeditious manner practicable in connection with any and all market conduct or other Governmental Authority examinations relating to the Reinsured Contracts.

8.2. Reporting and Accounting. The Administrator shall assume the reporting and accounting obligations set forth below:

- (i) As soon as practicable but not more than forty (40) days after the end of each calendar quarter that this Agreement is in effect (or more frequently as mutually agreed by the parties), the Administrator shall timely provide to the Company the Quarterly Reports. As soon as practicable but not more than forty-five (45) days after the end of each calendar year that this Agreement is in effect, the Administrator shall timely provide to the Company the Annual Reports. In addition, as soon as practicable but not more than forty (40) days after the end of each calendar quarter that this

6

---

Agreement is in effect (or more frequently as mutually agreed by the parties), the Administrator shall timely provide to the Company such other reports and summaries of transactions (and, upon request of the Company, detailed supporting records) related to the Reinsured Contracts as may be reasonably required for use in connection with the preparation of the Company's statutory and GAAP financial statements, tax returns and other required financial reports and to comply with the requirements of the

regulatory authorities having jurisdiction over the Company. The parties shall cooperate in good faith to establish the manner for the providing of such reports.

- (ii) As soon as practicable but not more than forty (40) days after the end of each calendar quarter that this Agreement is in effect (or more frequently as mutually agreed by the parties), the Administrator shall report to the Company the amount of statutory reserves that the Company is required to maintain in connection with the Reinsured Risks with respect to the Reinsured Contracts as of the quarter end.
- (iii) The Administrator shall promptly provide notice to the Company of any changes in the reserve methodology used by the Administrator in calculating statutory reserves for the Reinsured Contracts.
- (iv) Within forty-five (45) days after each calendar year end (or such longer time as may be agreed by the parties) that this Agreement is in effect, the Administrator shall provide to the Company (a) an opinion of an actuary reasonably acceptable to the Company as to the adequacy of statutory reserves for the Reinsured Contracts, prepared according to accepted actuarial standards of practice, and as otherwise required for regulatory reporting purposes and (b) an analysis which reasonably supports such opinion.

8.3. Additional Reports and Updates. For so long as this Agreement remains in effect, each party shall periodically furnish to the other such other reports and information as may be reasonably required by such other party for regulatory, tax or similar purposes and reasonably available to it.

#### ARTICLE IX

##### MISCELLANEOUS ADMINISTRATIVE SERVICES

The Administrator shall provide such Administrative Services as are not performed by or on behalf of the Company on the date hereof but the need for which may arise due to changes or developments in Applicable Law.

7

---

#### ARTICLE X

##### BOOKS AND RECORDS

The Administrator shall keep accurate and complete records, files and accounts of all transactions and matters with respect to the Reinsured Contracts and the administration thereof in accordance with Applicable Law, including New York Regulation 152, and its record management practices in effect from time to time for the Administrator's insurance business not covered by this Agreement, if any. All such records pertaining to the Reinsured Contracts shall be the property of the Company, provided that the Administrator shall at all times have the right to retain a copy of such books and records. The parties to this Agreement and their designated representatives may upon reasonable notice inspect, at the offices of the Administrator or the Company where such records are located, the papers and any and all other books or documents of the Administrator or the Company reasonably relating to this Agreement, including the Reinsured Contracts, and shall have access to appropriate employees and representatives of the other party, in each case during normal business hours for such period as this Agreement is in effect or for as long thereafter as any rights or obligations of any party survives or the Administrator or the Company reasonably need access to such records for regulatory, tax or similar purposes. The information obtained shall be used only for purposes relating to the transactions contemplated under this Agreement.

#### ARTICLE XI

##### COOPERATION

Each party hereto shall cooperate fully with the other in all reasonable respects in order to accomplish the objectives of this Agreement including making available to each their respective officers and employees for interviews and meetings with Governmental Authorities and furnishing any additional assistance, information and documents as may be reasonably requested by a party from time to time.

#### ARTICLE XII

##### PRIVACY REQUIREMENTS

In providing the Administrative Services provided for under this Agreement, and in connection with maintaining, administering, handling and transferring the data of the policyholders and other recipients of benefits under the Reinsured Contracts, the Administrator shall, and shall cause its Affiliates and any permitted Subcontractors to, comply with all confidentiality and security obligations applicable to them in connection with the collection, use, disclosure, maintenance and transmission of personal, private, health or financial information about individual policyholders or benefit recipients, including the provisions of privacy policies under which such information was gathered, those laws currently in place and which may become effective during the term of this Agreement, including the Gramm-Leach-Bliley Act, the Health Insurance Portability and Accountability Act of 1996 and any other Applicable Laws.

8

---

The Administrator shall entitle the Company and its agents and representatives, the Commissioner of Health and Human Services and such other Governmental Authorities, to the extent required by Applicable Law, to audit the Administrator's compliance herewith. The Administrator shall also enable individual subjects of personally identifiable information, upon request from such individuals, to review and correct information maintained by the Administrator about them, and to restrict use of such information. The Administrator shall promptly report to the Company any violation of this provision of which the Administrator becomes aware. Unless required by Applicable Law, the Administrator shall not during the term of this Agreement, modify the privacy policies under which information utilized by the Administrator in administering the Reinsured Contracts is gathered, without the Company's prior written consent, which consent shall not be unreasonably withheld. The parties agree to comply with the terms of the Business Associate Addendum attached hereto, if applicable, or such other written agreement as may be required by Applicable Law on the date hereof.

#### ARTICLE XIII

##### CONSIDERATION FOR ADMINISTRATIVE SERVICES

Apart from the performance by the Company of its obligations under the Coinsurance Agreement, there shall be no fee or other consideration due to the Administrator for performance of the Administrative Services under this Agreement.

#### ARTICLE XIV

##### BANK ACCOUNT; USE OF COMPANY LETTERHEAD

When and on terms reasonably requested by the Administrator, the Company shall open, modify or close, and make available for use by the Administrator for the payment of amounts to be paid by the Administrator hereunder one or more bank accounts of the Company and check stock of the Company. The Administrator shall maintain such account(s) and pay all applicable bank fees and check stock costs. The Company shall adopt such resolutions and execute such documents as required to designate senior officers of the Administrator (by title) as signatories on such

account(s) and authorize the Administrator to certify to such bank(s), from time to time, the names of such officers. The Company shall also make available to the Administrator, at the sole expense of the Administrator, such letterhead, printed forms and other documents of the Company as may be reasonably required by the Administrator in performing services hereunder. Upon termination of this Agreement, the Administrator shall promptly return to the Company all such unused check stock, letterhead, printed forms and other documents held by it in connection with this Agreement as provided under this Article XIV.

---

ARTICLE XV

INDEMNIFICATION

Any claim for or with respect to indemnification arising out of, or relating to, this Agreement or the Administrative Services hereunder shall be permitted under and governed by the provisions of Article V of the Master Agreement, dated as of [ ], 2004, among General Electric Company, General Electric Capital Corporation, GEI, Inc., GE Financial Assurance Holdings, Inc. and Genworth Financial, Inc (the "Master Agreement"), to the extent such provisions are applicable, as if this Agreement were a Transaction Document under the Master Agreement.

ARTICLE XVI

DURATION; TERMINATION

16.1. Duration. This Agreement shall commence on the Effective Date and continue with respect to each Reinsured Contract until no further Administrative Services in respect of such Reinsured Contract is required, unless this Agreement is earlier terminated under Section 16.2.

16.2. Termination. (a) This Agreement is subject to immediate termination at the option of the Company, upon written notice to the Administrator, on the occurrence of any of the following events:

- (i) A voluntary or involuntary proceeding is commenced in any jurisdiction by or against the Administrator for the purpose of conserving, rehabilitating or liquidating the Administrator;
- (ii) There is a material breach by the Administrator of any material term or condition of this Agreement that is not cured by the Administrator within thirty (30) days after receipt of written notice from the Company of such breach or act (provided that the Company shall not have the right to terminate this Agreement (A) for so long as the Administrator is making a good faith effort to cure such breach, not to exceed an additional one hundred eighty (180) days or (B) during the pendency of any dispute resolution proceedings as set forth in Article XVII regarding an alleged material breach); or
- (iii) The Administrator is unable to perform the services required under this Agreement for a period of thirty (30) consecutive days for any reason other than as a result of a Force Majeure, it being understood that nothing in this Section 16.2(a)(iii) shall relieve the Administrator from its administrative responsibilities under this Agreement. For purposes of this Agreement, "Force Majeure" means any acts or omissions of any civil or military authority, acts of God, acts or omissions of the Company, fires, strikes or other labor disturbances, equipment failures, fluctuations or non-

---

availability of electrical power, heat, light, air conditioning or telecommunications equipment, or any other act, omission or occurrence beyond the Administrator's reasonable control, irrespective of whether similar to the foregoing enumerated acts, omissions or occurrences.

(b) This Agreement may be terminated at any time upon the mutual written consent of the parties hereto, which writing shall state the effective date of termination.

(c) In the event that this Agreement is terminated under any of the provisions of Section 16.2(a), the Administrator shall select a third-party administrator to perform the services required by this Agreement. The Company shall have the right to approve any such administrator selected by the Administrator, but such approval will not unreasonably be withheld or delayed. If the Administrator fails to select an administrator pursuant to this Section 16.2(c), the Company shall select such an administrator. In either case, the Administrator shall pay all fees and charges imposed by the selected administrator and shall bear all transition costs associated with the transition of the performance of the services required under this Agreement to such administrator, including the expense of sending policyholder notices as provided in Article V.

ARTICLE XVII

DISPUTE RESOLUTION

17.1. General Provisions. (a) Any dispute, controversy or claim arising out of or relating to this Agreement or the validity, interpretation, breach or termination thereof (a "Dispute"), shall be resolved in accordance with the procedures set forth in this Article XVII, which shall be the sole and exclusive procedures for the resolution of any such Dispute unless otherwise specified below.

(b) Commencing with the request contemplated by Section 17.2, all communications between the parties or their representatives in connection with the attempted resolution of any Dispute, including any mediator's evaluation referred to in Section 17.3, shall be deemed to have been delivered in furtherance of a Dispute settlement and shall be exempt from discovery and production, and shall not be admissible in evidence for any reason (whether as an admission or otherwise), in any arbitral or other proceeding for the resolution of the Dispute.

(c) In connection with any Dispute, the parties expressly waive and forego any right to (i) punitive, exemplary, statutorily-enhanced or similar damages in excess of compensatory damages (provided that any such liability with respect to a Third Party Claim (as defined in the Master Agreement) shall be considered direct damages), and (ii) trial by jury.

(d) The specific procedures set forth below, including but not limited to the time limits referenced therein, may be modified by agreement of the parties in writing.

---

(e) All applicable statutes of limitations and defenses based upon the passage of time shall be tolled while the procedures specified in this Article XVII are pending. The parties will take such action, if any, required to effectuate such tolling.

17.2. Consideration by Senior Executives. If a Dispute is not resolved in the normal course of business at the operational level, the parties shall attempt in good faith to

resolve such Dispute by negotiation between executives who hold, at a minimum, the office of President and CEO of the respective business entities involved in such Dispute. Either party may initiate the executive negotiation process by providing a written notice to the other (the "Initial Notice"). Fifteen (15) days after delivery of the Initial Notice, the receiving party shall submit to the other a written response (the "Response"). The Initial Notice and the Response shall include (i) a statement of the Dispute and of each party's position, and (ii) the name and title of the executive who will represent that party and of any other person who will accompany the executive. Such executives will meet in person or by telephone within thirty (30) days of the date of the Initial Notice to seek a resolution of the Dispute.

17.3. Mediation. If a Dispute is not resolved by negotiation as provided in Section 17.2 within forty-five (45) days from the delivery of the Initial Notice, then either party may submit the Dispute for resolution by mediation pursuant to the CPR Institute for Dispute Resolution (the "CPR") Model Mediation Procedure as then in effect. The parties will select a mediator from the CPR Panels of Distinguished Neutrals, but such mediator must have prior U.S. reinsurance experience either as a lawyer or as a present or former officer or management employee of a reinsurance company, but not of the Company, or the Administrator, or any of their respective affiliates. Either party at commencement of the mediation may ask the mediator to provide an evaluation of the Dispute and the parties' relative positions.

17.4. Arbitration. (a) If a Dispute is not resolved by mediation as provided in Section 17.3 within thirty (30) days of the selection of a mediator (unless the mediator chooses to withdraw sooner), either party may submit the Dispute to be finally resolved by arbitration pursuant to the CPR Rules for Non-Administered Arbitration as then in effect (the "CPR Arbitration Rules"). The parties consent to a single, consolidated arbitration for all known Disputes existing at the time of the arbitration and for which arbitration is permitted.

(b) The neutral organization for purposes of the CPR Arbitration Rules will be the CPR. The arbitral tribunal shall be composed of three arbitrators who are each experienced in the U.S. reinsurance business, of whom each party shall appoint one in accordance with the "screened" appointment procedure provided in Rule 5.4 of the CPR Arbitration Rules. The non-party appointed arbitrator must have prior U.S. reinsurance experience as a present or former officer or management employee of a reinsurance company, but not of the Company, or the Administrator, or any of their respective affiliates. The arbitration shall be conducted in New York City. Each party shall be permitted to present its case, witnesses and evidence, if any, in the presence of the other party. A written transcript of the proceedings shall be made and furnished to the parties. The arbitrators shall determine the Dispute in accordance with the law of New York, without giving effect to any conflict of law rules or other rules that might render such law inapplicable or unavailable, and shall apply this Agreement according to its terms, provided that the provisions relating to arbitration shall be governed by the Federal Arbitration Act, 9 U.S.C. §§ 1 et seq. The arbitral tribunal shall endeavor to render its award or order

12

---

resulting from any arbitration within forty-five (45) days following the termination of the arbitration proceedings.

(c) The parties agree to be bound by any award or order resulting from any arbitration conducted hereunder and further agree that judgment on any award or order resulting from an arbitration conducted under this Section 17.4 may be entered and enforced in any court having jurisdiction thereof.

(d) Except as expressly permitted by this Agreement, no party will commence or voluntarily participate in any court action or proceeding concerning a Dispute, except (i) for enforcement as contemplated by Section 17.4(c) above, (ii) to restrict or vacate an arbitral decision based on the grounds specified under applicable law, or (iii) for interim relief as provided in paragraph (e) below. For purposes of the foregoing the parties hereto submit to the non-exclusive jurisdiction of the courts of the State of New York.

(e) In addition to the authority otherwise conferred on the arbitral tribunal, the tribunal shall have the authority to make such orders for interim relief, including injunctive relief, as it may deem just and equitable. Notwithstanding paragraph (d) above, each party acknowledges that in the event of any actual or threatened breach of certain of the provisions of this Agreement, the remedy at law would not be adequate, and therefore injunctive or other interim relief may be sought immediately to restrain such breach. If the tribunal shall not have been appointed, either party may seek interim relief from a court having jurisdiction if the award to which the applicant may be entitled may be rendered ineffectual without such interim relief. Upon appointment of the tribunal following any grant of interim relief by a court, the tribunal may affirm or disaffirm such relief, and the parties will seek modification or rescission of the court action as necessary to accord with the tribunal's decision.

(f) Each party will bear its own attorneys' fees and costs incurred in connection with the resolution of any Dispute in accordance with this Article XVII.

#### ARTICLE XVIII

##### MISCELLANEOUS PROVISIONS

18.1. Headings and Schedules. Headings used herein are not a part of this Agreement and shall not affect the terms hereof. The attached Schedules are a part of this Agreement.

18.2. Notices. All notices, requests, demands and other communications under this Agreement must be in writing and will be deemed to have been duly given or made as follows: (a) if sent by registered or certified mail in the United States return receipt requested, upon receipt; (b) if sent by reputable overnight air courier, two business days after mailing; (c) if sent by facsimile transmission, with a copy mailed on the same day in the manner provided in (a) or (b) above, when transmitted and receipt is confirmed by telephone; or (d) if otherwise actually personally delivered, when delivered, and shall be delivered as follows:

If to the Company:

13

---

American Mayflower Life Insurance Company of New York  
700 Main Street  
Lynchburg, VA 24504  
Facsimile: (434) 948-5064  
Attention: Chief Executive Officer

With a copy to:

American Mayflower Life Insurance Company of New York  
700 Main Street  
Lynchburg, VA 24504  
Facsimile: (434) 948-5819  
Attention: General Counsel  
If to the Administrator:

Union Fidelity Life Insurance Company  
200 North Martingale Road  
Schaumburg, IL 60173-2096  
Facsimile: (847) 330-3404

Attention: Chief Financial Officer

With a copy to:

Union Fidelity Life Insurance Company  
200 North Martingale Road  
Schaumburg, IL 60173-2096  
Facsimile: (847) 605-3044  
Attention: General Counsel

or to such other address or to such other Person as either party may have last designated by notice to the other party.

18.3. Successors and Assigns. This Agreement shall be binding upon and inure to the benefit of the parties hereto and their respective successors, permitted assigns and legal representatives. Neither this Agreement, nor any right or obligation hereunder, may be assigned by any party without the prior written consent of the other party hereto and without the prior written consent of the New York Insurance Department and the Illinois Insurance Department. Any assignment in violation of this Section 18.3 shall be void and shall have no force and effect.

18.4. Execution in Counterpart. This Agreement may be executed by the parties hereto in any number of counterparts, and by each of the parties hereto in separate counterparts, each of which counterparts, when so executed and delivered, shall be deemed to be an original, but all such counterparts shall together constitute but one and the same instrument.

14

---

18.5. Safeguarding Customer Information. The Administrator shall implement and maintain appropriate measures designed to meet the objectives of New York Insurance Department Regulation No. 173, with respect to safeguarding the Company's customer information and customer information systems. The Administrator shall adjust its information security program at the reasonable request of the Company for any relevant changes indicated by the Company's assessment of risk around its customer information and customer information systems. Confirming evidence that the Administrator has satisfied its obligations under this Agreement shall be made available, during normal business hours, for inspection by the Company, representatives of the Company, and any governmental agency that has regulatory authority over the Company's business activities.

18.6. Currency. Whenever the word "Dollars" or the "\$" sign appear in this Agreement, they shall be construed to mean United States Dollars, and all transactions under this Agreement shall be in United States Dollars.

18.7. Amendments. This Agreement may not be changed, altered or modified unless the same shall be in writing executed by the Company and the Administrator.

18.8. Governing Law. This Agreement will be construed, performed and enforced in accordance with the laws of the State of New York without giving effect to its principles or rules of conflict of laws thereof to the extent such principles or rules would require or permit the application of the laws of another jurisdiction.

18.9. Entire Agreement; Severability. (a) This Agreement constitutes the entire agreement between the parties hereto relating to the subject matter hereof and supersedes all prior and contemporaneous agreements, understandings, statements, representations and warranties, negotiations and discussions, whether oral or written, of the parties and there are no general or specific warranties, representations or other agreements by or among the parties in connection with the entering into of this Agreement or the subject matter hereof except as specifically set forth or contemplated herein.

(b) If any provision of this Agreement is held to be void or unenforceable, in whole or in part, (i) such holding or provision shall not affect the validity and enforceability of the remainder of this Agreement, including any other provision, paragraph or subparagraph, and (ii) the parties agree to attempt in good faith to reform such void, unenforceable or violative provision to the extent necessary to render such provision enforceable and to carry out its original intent.

18.10. No Waiver; Preservation of Remedies. No consent or waiver, express or implied, by any party to or of any breach or default by any other party in the performance by such other party of its obligations hereunder shall be deemed or construed to be a consent or waiver to or of any other breach or default in the performance of obligations hereunder by such other party hereunder. Failure on the part of any party to complain of any act or failure to act of any other party or to declare any other party in default, irrespective of how long such failure continues, shall not constitute a waiver by such first party of any of its rights hereunder. The rights and remedies provided are cumulative and are not exclusive of any rights or remedies that any party may otherwise have at law or equity.

15

---

18.11. Third Party Beneficiary. Nothing in this Agreement will confer any rights upon any Person that is not a party or a successor or permitted assignee of a party to this Agreement.

18.12. Tax Exception to Any Confidentiality. Notwithstanding anything to the contrary set forth herein or in any other agreement to which the parties hereto are parties or by which they are bound, any obligations of confidentiality contained herein and therein, as they relate to the transactions, shall not apply to the federal tax structure or federal tax treatment of the transactions, and each party hereto (and any employee, representative, or agent of any party hereto) may disclose to any and all persons, without limitation of any kind, the federal tax structure and federal tax treatment of the transactions. The preceding sentence is intended to cause the transactions to be treated as not having been offered under conditions of confidentiality for purposes of Section 1.6011-4(b)(3) (or any successor provision) of the Treasury Regulations promulgated under Section 6011 of the Internal Revenue Code of 1986, as amended, and shall be construed in a manner consistent with such purpose. In addition, each party hereto acknowledges that it has no proprietary or exclusive rights to the federal tax structure of the transactions or any federal tax matter or federal tax idea related to the transactions.

18.13. Interpretation. Wherever the words "include," "includes" or "including" are used in this Agreement, they shall be deemed to be followed by the words "without limitation."

18.14. Survival. Article XVII and Article XVIII shall survive the termination of this Agreement.

18.15. Licensing. At all times during the term of this Agreement, the Administrator shall maintain in full force and effect all licenses required to be maintained by it under Applicable Law with respect to this Agreement, including, if applicable, an independent claims adjuster license.

16

---

IN WITNESS WHEREOF, the Company and the Administrator have executed this Agreement as of the date first above written.

AMERICAN MAYFLOWER LIFE INSURANCE COMPANY OF NEW YORK

By: \_\_\_\_\_  
Name \_\_\_\_\_ :  
Title \_\_\_\_\_

UNION FIDELITY LIFE INSURANCE COMPANY

By: \_\_\_\_\_  
Name \_\_\_\_\_ :  
Title \_\_\_\_\_

17

---

**BUSINESS ASSOCIATE ADDENDUM**

**I. Purpose.**

In order to disclose certain information to the party providing a service under this Agreement (“Provider”) under this Addendum, some of which may constitute Protected Health Information (defined below), the party to whom a service under this Agreement is being provided (“Recipient”) and Provider mutually agree to comply with the terms of this Addendum for the purpose of satisfying the requirements of the Health Insurance Portability and Accountability Act of 1996 (“HIPAA”) and its implementing privacy regulations at 45 C.F.R. Parts 160-164 (“HIPAA Privacy Rule”). These provisions shall apply to Provider to the extent that Provider is considered a “Business Associate” under the HIPAA Privacy Rule and all references in this section to Business Associates shall refer to Provider. Capitalized terms not otherwise defined herein shall have the meaning assigned in the Agreement. Notwithstanding anything else to the contrary in the Agreement, in the event of a conflict between this Addendum and the Agreement, the terms of this Addendum shall prevail.

**II. Permitted Uses and Disclosures.**

A. Business Associate agrees to use or disclose Protected Health Information (“PHI”) that it creates for or receives from Recipient or its Subsidiaries only as follows. The capitalized term “Protected Health Information or PHI” has the meaning set forth in 45 Code of Federal Regulations Section 164.501, as amended from time to time. Generally, this term means individually identifiable health information including, without limitation, all information, data and materials, including without limitation, demographic, medical and financial information, that relates to the past, present, or future physical or mental health or condition of an individual; the provision of health care to an individual; or the past present, or future payment for the provision of health care to an individual; and that identifies the individual or with respect to which there is a reasonable basis to believe the information can be used to identify the individual. This definition shall include any demographic information concerning members and participants in, and applicants for, Recipient’s or its Subsidiaries’ health benefit plans. All other terms used in this Addendum shall have the meanings set forth in the applicable definitions under the HIPAA Privacy Rule.

B. Functions and Activities on Company’s Behalf. Business Associate is permitted to use and disclose PHI it creates for or receives from Recipient or its Subsidiaries only for the purposes described in this Addendum or the Agreement that are not inconsistent with the provisions of this Addendum, or as required by law, or following receipt of prior written approval from whichever of the Recipient or its Subsidiary for which the relevant PHI was created or from which the relevant PHI was received. In addition to these specific requirements below, Business Associate may use or disclose PHI only in a manner that would not violate the HIPAA Privacy Rule if done by the Recipient or its Subsidiaries.

C. Business Associate’s Operations. Business Associate is permitted by this Agreement to use PHI it creates for or receives from Recipient or its Subsidiaries: (i) if such use is reasonably necessary for Business Associate’s proper management and administration; and (ii) as reasonably necessary to carry out Business Associate’s legal responsibilities.

---

Business Associate is permitted to disclose PHI it creates for or receives from Recipient or its Subsidiaries for the purposes identified in this Section only if the following conditions are met:

- (1) The disclosure is required by law; or
- (2) The disclosure is reasonably necessary to Business Associate’s proper management and administration, and Business Associate obtains reasonable assurances in writing from any person or organization to which Business Associate will disclose such PHI that the person or organization will:
  - a. Hold such PHI as confidential and use or further disclose it only for the purpose for which Business Associate disclosed it to the person or organization or as required by law; and
  - b. Notify Business Associate (who will in turn promptly notify whichever of the Recipient or its Subsidiary for which the relevant PHI was created or from which the relevant PHI was received) of any instance of which the person or organization becomes aware in which the confidentiality of such PHI was breached.

D. Minimum Necessary Standard. In performing the functions and activities on Recipient’s or its Subsidiaries’ behalf pursuant to the Agreement, Business Associate agrees to use, disclose or request only the minimum necessary PHI to accomplish the purpose of the use, disclosure or request. Business Associate must have in place policies and procedures that limit the PHI disclosed to meet this minimum necessary standard.

E. Prohibition on Unauthorized Use or Disclosure. Business Associate will neither use nor disclose PHI it creates or receives for or from Recipient, its Subsidiaries, or from another business associate of Recipient or its Subsidiaries, except as permitted or required by this Addendum or the Agreement that are not inconsistent with the provisions of this Addendum, or as required by law, or following receipt of prior written approval from whichever of the Recipient or its Subsidiary for which the relevant PHI was created or from which the relevant PHI was received.

F. De-identification of Information. Business Associate agrees neither to de-identify PHI it creates for or receives from Recipient or its Subsidiaries or from another business associate of Recipient or its Subsidiaries, nor use or disclose such de-identified PHI, unless such de-identification is expressly permitted under the terms and conditions of this Addendum or the Agreement and related to Recipient’s or its Subsidiaries’ activities for purposes of “treatment”, “payment” or “health care operations”, as those terms are defined under the HIPAA Privacy Rule. De-identification of PHI, other than as expressly permitted under the terms and conditions of the Addendum for Business Associate to perform services for Recipient or its Subsidiaries, is not a permitted use of PHI under this Addendum. Business Associate further agrees that it will not create a “Limited Data Set” as defined by the HIPAA Privacy Rule using PHI it creates or receives, or receives from another business associate of Recipient or its Subsidiaries, nor use or disclose such Limited Data Set unless: (i) such creation, use or disclosure is expressly permitted under the terms and conditions of

---

this Addendum or the Agreement that are not inconsistent with the provisions of this Addendum; and such creation, use or disclosure is for services provided by Business Associate that relate to Recipient's or its Subsidiaries' activities for purposes of "treatment", "payment" or "health care operations", as those terms are defined under the HIPAA Privacy Rule.

G. Information Safeguards. Business Associate will develop, document, implement, maintain and use appropriate administrative, technical and physical safeguards to preserve the integrity and confidentiality of and to prevent non-permitted use or disclosure of PHI created for or received from Recipient or its Subsidiaries. These safeguards must be appropriate to the size and complexity of Business Associate's operations and the nature and scope of its activities. Business Associate agrees that these safeguards will meet any applicable requirements set forth by the U.S. Department of Health and Human Services, including (as of the effective date or as of the compliance date, whichever is applicable) any requirements set forth in the final HIPAA security regulations. Business Associate agrees to mitigate, to the extent practicable, any harmful effect that is known to Business Associate resulting from a use or disclosure of PHI by Business Associate in violation of the requirements of this Addendum.

III. Conducting Standard Transactions. In the course of performing services for Recipient or its Subsidiaries, to the extent that Business Associate will conduct Standard Transactions for or on behalf of Recipient or its Subsidiaries, Business Associate will comply, and will require any subcontractor or agent involved with the conduct of such Standard Transactions to comply, with each applicable requirement of 45 C.F.R. Part 162. "Standard Transaction(s)" shall mean a transaction that complies with the standards set forth at 45 C.F.R. parts 160 and 162. Further, Business Associate will not enter into, or permit its subcontractors or agents to enter into, any trading partner agreement in connection with the conduct of Standard Transactions for or on behalf of the Recipient or its Subsidiaries that:

- a. Changes the definition, data condition, or use of a data element or segment in a Standard Transaction;
- b. Adds any data element or segment to the maximum defined data set;
- c. Uses any code or data element that is marked "not used" in the Standard Transaction's implementation specification or is not in the Standard Transaction's implementation specification; or
- d. Changes the meaning or intent of the Standard Transaction's implementation specification.

IV. Sub-Contractors, Agents or Other Representatives. Business Associate will require any of its subcontractors, agents or other representatives to which Business Associate is permitted by this Addendum or the Agreement (or is otherwise given Recipient's or the relevant Subsidiary's prior written approval) to disclose any of the PHI Business Associate creates or receives for or from Recipient or its Subsidiaries, to provide reasonable assurances in writing that subcontractor

or agent will comply with the same restrictions and conditions that apply to the Business Associate under the terms and conditions of this Addendum with respect to such PHI.

V. Protected Health Information Access, Amendment and Disclosure Accounting.

A. Access. Business Associate will promptly upon Recipient's or its Subsidiary's request make available to Recipient, its Subsidiary, or, at Recipient's or such Subsidiary's direction, to the individual (or the individual's personal representative) for inspection and obtaining copies any PHI about the individual which Business Associate created for or received from Recipient or its Subsidiary and that is in Business Associate's custody or control, so that Recipient or its Subsidiary may meet its access obligations under 45 Code of Federal Regulations § 164.524.

B. Amendment. Upon Recipient's or its Subsidiary's request Business Associate will promptly amend or permit Recipient or its Subsidiary access to amend any portion of the PHI which Business Associate created for or received from Recipient or its Subsidiary, and incorporate any amendments to such PHI, so that Recipient or its Subsidiary may meet its amendment obligations under 45 Code of Federal Regulations § 164.526.

C. Disclosure Accounting. So that Recipient or its Subsidiaries may meet their disclosure accounting obligations under 45 Code of Federal Regulations § 164.528:

1. Disclosure Tracking. Business Associate will record for each disclosure, not excepted from disclosure accounting under Section V.C.2 below, that Business Associate makes to Recipient or its Subsidiaries of PHI that Business Associate creates for or receives from Recipient or its Subsidiaries, (i) the disclosure date, (ii) the name and member or other policy identification number of the person about whom the disclosure is made, (iii) the name and (if known) address of the person or entity to whom Business Associate made the disclosure, (iv) a brief description of the PHI disclosed, and (v) a brief statement of the purpose of the disclosure (items i-v, collectively, the "disclosure information"). For repetitive disclosures Business Associate makes to the same person or entity (including Recipient or its Subsidiaries) for a single purpose, Business Associate may provide a) the disclosure information for the first of these repetitive disclosures, (b) the frequency, periodicity or number of these repetitive disclosures and (c) the date of the last of these repetitive disclosures. Business Associate will make this disclosure information available to Recipient or its Subsidiaries promptly upon Recipient's or its Subsidiaries' request.

2. Exceptions from Disclosure Tracking. Business Associate need not record disclosure information or otherwise account for disclosures of PHI that this Addendum or Recipient or the relevant Subsidiary in writing permits or requires (i) for the purpose of Recipient's or its Subsidiaries' treatment activities, payment activities, or health care operations, (ii) to the individual who is the subject of the PHI disclosed or to that individual's personal representative; (iii) to persons involved in that individual's health care or payment for health care; (iv) for notification for disaster relief purposes, (v) for national security or intelligence purposes, (vi) to law enforcement officials or correctional institutions regarding inmates; or (vii) pursuant to an authorization; (viii) for disclosures

of certain PHI made as part of a Limited Data Set; (ix) for certain incidental disclosures that may occur where reasonable safeguards have been implemented; and (x) for disclosures prior to April 14, 2003.

3. Disclosure Tracking Time Periods. Business Associate must have available for Recipient and its Subsidiaries the disclosure information required by this section for the 6 years preceding Recipient's or its Subsidiaries' request for the disclosure information (except Business Associate need have no disclosure information for disclosures occurring before April 14, 2003).

VI. Additional Business Associate Provisions

A. Reporting of Breach of Privacy Obligations. Business Associate will provide written notice to whichever of the Recipient or its Subsidiary for which the relevant PHI was created or from which the relevant PHI was received of any use or disclosure of PHI that is neither permitted by this Addendum nor given prior written approval by Recipient or the relevant Subsidiary



promptly after Business Associate learns of such non-permitted use or disclosure. Business Associate's report will at least:

- (i) Identify the nature of the non-permitted use or disclosure;
- (ii) Identify the PHI used or disclosed;
- (iii) Identify who made the non-permitted use or received the non-permitted disclosure;
- (iv) Identify what corrective action Business Associate took or will take to prevent further non-permitted uses or disclosures;
- (v) Identify what Business Associate did or will do to mitigate any deleterious effect of the non-permitted use or disclosure; and
- (vi) Provide such other information, including a written report, as Recipient or the relevant Subsidiary may reasonably request.

B. Amendment. Upon the effective date of any final regulation or amendment to final regulations promulgated by the U.S. Department of Health and Human Services with respect to PHI, including, but not limited to the HIPAA privacy and security regulations, this Addendum and the Agreement will automatically be amended so that the obligations they impose on Business Associate remain in compliance with these regulations.

In addition, to the extent that new state or federal law requires changes to Business Associate's obligations under this Addendum, this Addendum shall automatically be amended to include such additional obligations, upon notice by Recipient or its Subsidiaries to Business Associate of such obligations. Business Associate's continued performance of services under the Agreement shall be deemed acceptance of these additional obligations.

C. Audit and Review of Policies and Procedures. Business Associate agrees to provide, upon Recipient request, access to and copies of any policies and procedures developed or utilized by Business Associate regarding the protection of PHI. Business Associate agrees to provide, upon Recipient's request, access to Business Associate's internal practices, books, and records, as they relate to Business Associate's services, duties and obligations set forth in this Addendum and the Agreement(s) under which Business Associate provides services and / or products to or on behalf of Recipient or its Subsidiaries, for purposes of Recipient's or its Subsidiaries' review of such internal practices, books, and records.

SCHEDULE C

CEDING COMMISSION

The Ceding Commission shall be the sum of the following:

1. an amount equal to the excess of the Total SAP Ceded Reserves over Total GAAP Ceded Reserves measured as of the close of business on the day immediately preceding the Inception Date (which amount may be negative);
2. an amount equal to the unamortized PVFP intangible asset balance of the Company (excluding any related mark to market adjustments for SFAS 115 requirement) with respect to the Reinsured Contracts as measured as of the close of business on the day immediately preceding the Inception Date, determined in accordance with GAAP;
3. an amount equal to the unamortized deferred acquisition costs of the Company (excluding any related mark to market adjustments for SFAS 115 requirement) with respect to the Reinsured Contracts as measured as of the close of business on the day immediately preceding the Inception Date, determined in accordance with GAAP; and
4. an amount equal to the excess of the GAAP book value of the Assets (excluding any related mark to market adjustments for SFAS 115 requirement) over the SAP book value of the Assets measured as of the close of business on the day immediately preceding the Inception Date (which amount may be negative).

SCHEDULE D

ASSETS

Transfer Document	From	To	Nature of Transfer	Cash Map Cross-Reference	Schedule						
						12/31/03 GAAP BV (incl attached derivative)	12/31/03 Accrued Interest	12/31/03 GAAP BV + Accrued Interest	12/31/03 STAT BV (incl attached derivative)	12/31/03 Accrued Interest	12/31/03 STAT BV + Accrued Interest
AML SSA Coinsurance	AML	UFLIC	Treaty	(81)	Schedule D						
[Individual Asset Details Omitted]											
<b>Asset Sub Total</b>						<b>306,876,291.67</b>	<b>5,242,943.17</b>	<b>312,119,234.84</b>	<b>303,388,501.92</b>	<b>5,242,943.17</b>	<b>308,631,445.09</b>
Cash									24,390.39		24,390.39
<b>Total</b>									<b>303,412,892.31</b>		<b>308,655,835.48</b>

\* These Securities will not be transferred. The "Call Amount" will be settled in cash

---

SCHEDULE E  
EXPENSE ALLOWANCES

The "Annual Expense Reimbursement Factor" used to calculate the Expense Allowance is as follows:

Policy Maintenance Factor           \$23.84 per Policy

Such Annual Expense Reimbursement Factor will be adjusted (i) for the year beginning January 1, 2005 and, thereafter, every three (3) years during the term of this Agreement based on a triennial cost/time study prepared in accordance with the methodology set forth below (the "Triennial Study") and (ii) for the years between the Triennial Studies based on a report setting forth the Annual Expense Reimbursement Factor prepared in accordance with the methodology set forth below (the "Annual Expense Reimbursement Factor Report").

(a) Triennial Study. As soon as practicable (and in any event within sixty (60) days) prior to January 1, 2005 and prior to the beginning of every third calendar year thereafter during the term of this Agreement, the Company shall cause to be prepared and delivered to the Reinsurer the Triennial Study which sets forth the Annual Expense Reimbursement Factor for the next calendar year, together with all supporting data used in preparing the Triennial Study and work papers, in reasonable detail, setting forth the determination of such Annual Expense Reimbursement Factors based on such Triennial Study (such documents, together with the Triennial Study, the "Triennial Study Documents").

(b) Annual Expense Reimbursement Factor Report. As soon as practicable (and in any event within thirty (30) days) prior to January 1, 2006 and prior to the beginning of each calendar year thereafter in which no Triennial Study is prepared, the Company shall cause to be prepared and delivered to the Reinsurer the Annual Expense Reimbursement Factor Report, together with all supporting data used in preparing the Annual Expense Reimbursement Factor Report and work papers, in reasonable detail, setting forth the determination of such Annual Expense Reimbursement Factor for the next calendar year (such documents, together with the Annual Expense Reimbursement Factor Report, the "Annual Expense Reimbursement Factor Documents").

(c) Methodology. At the time of the Triennial Study, historical costs (to include costs directly related to maintaining and administering policies, processing claims and reporting results) will be determined for the Policy Maintenance Factor identified above. For a given Annual Expense Reimbursement Factor the identified costs will be divided by the total historical number of units of measure for both the Reinsured Contracts and the retained block of business to derive an historical cost per unit. The historical cost per unit will be used as a prospective cost per unit for the next calendar year.

For the two succeeding years in the period between the Triennial Studies the historical dollar amounts by Policy Maintenance Factor will be adjusted (rolled forward) for current year cost changes agreed to by the Reinsurer and the Company (in accordance with the procedures set forth below). This rolled forward historical cost will then be divided by the total historical

---

number of units for the current period to determine a prospective cost per unit for the next calendar year.

An additional adjustment, positive or negative, to the prospective cost per unit determined by either the Triennial Study or the two succeeding years may be negotiated between the parties. The additional adjustment is for special projected costs or benefits of productivity, process improvements, inflation, loss of scale, and any other cost variation which was not included in the prior Triennial Study or the succeeding roll forward.

The combined prospective unit cost and additional adjustment is the Annual Expense Reimbursement Factor. The Expense Allowance will be determined quarterly and billed to the Reinsurer in three equal installments during the quarter at the end of the month. Each installment will be determined by multiplying the actual number of units at the beginning of the quarter covered by this Agreement times the Annual Expense Reimbursement Factor (divided by twelve).

(d) Review of Documents. Following the delivery of the Annual Expense Reimbursement Factor Documents or the Triennial Study Documents, as applicable, the Company shall (i) provide to the Reinsurer or its designated representative copies of such additional work papers and other documents relating to its preparation of the Annual Expense Reimbursement Factor Report or Triennial Study, as applicable, as the Reinsurer or its designated representative may reasonably request, including, without limitation, claims files and practices and (ii) cooperate with, and make its personnel and facilities reasonably available to, the Reinsurer and the Reinsurer's designated representative for the purpose of providing such other information as the Reinsurer or the Reinsurer's designated representative may reasonably request concerning Annual Expense Reimbursement Factor Documents or the Triennial Study Documents, as applicable, and the calculation of the Annual Expense Reimbursement Factor.

(e) Notice of Disagreement. In the event that the Reinsurer has any disagreement with any of the Annual Expense Reimbursement Factor Documents or the Triennial Study Documents, as applicable, the Reinsurer shall give written notice of all such disagreements (a "Notice of Disagreement") to the Company within thirty (30) days after the Annual Expense Reimbursement Factor Documents or the Triennial Study Documents, as applicable, are delivered to the Reinsurer. Any Notice of Disagreement shall set forth each item in disagreement and shall provide reasonable specificity as to the basis for each disagreement and shall specify the total adjustment to the Annual Expense Reimbursement Factor, as proposed by the Company as a result of such items in disagreement.

(f) Dispute Resolution. If the Reinsurer does not deliver a Notice of Disagreement to the Company within such thirty (30) day period, the Annual Expense Reimbursement Factor Documents and the Triennial Study Documents, as applicable, shall be final and binding upon the parties hereto and shall constitute the final calculation of the Annual Expense Reimbursement Factor for the next calendar year. If the Reinsurer delivers a Notice of Disagreement to the Company within such thirty (30) day period, the parties shall (and shall cause their respective designated representatives to) negotiate in good faith to resolve all disagreements as promptly as practicable. Any changes in the Annual Expense Reimbursement Factor, if any, that are agreed to by the Company and the Reinsurer within sixty (60) days of the

---

above-mentioned delivery of the Annual Expense Reimbursement Factor Documents or the Triennial Study Documents, as applicable, shall be incorporated into a final calculation of the Annual Expense Reimbursement Factor. If the parties and their respective designated representatives are unable to resolve all disagreements within sixty (60) days of delivery of the Annual Expense Reimbursement Factor Documents or the Triennial Study Documents, as applicable, then all unresolved disagreements will be submitted within ten (10) days after the end of such sixty (60) day period for resolution in accordance herewith to an independent certified public accounting firm of national standing and reputation (the "Accounting Firm") mutually acceptable to the Company and the Reinsurer. The parties shall cooperate in good faith with the Accounting Firm and shall give the Accounting Firm access to all data and other information requested by the Accounting Firm for purposes of such resolution. The Accounting Firm shall, within thirty (30) days after its engagement, deliver to the Company and the Reinsurer a definitive calculation of the Annual Expense Reimbursement Factor, which shall be final and binding upon the parties hereto and shall be so reflected in the calculation of the Annual Expense Reimbursement Factor. The Company and the Reinsurer shall each pay one-half of the fees and expenses of the Accounting Firm.

(g) Expense Allowance Pending Resolution. In the event of a dispute with respect to any Annual Expense Reimbursement Factor for the next succeeding Calendar year, the Company and the Reinsurer agree that the Annual Expense Reimbursement Factor then in effect under this Agreement shall remain in effect pending resolution of such dispute and adjustment, if any, in accordance with the dispute resolution procedure set forth in paragraph (f) above.

---



SCHEDULE F - PART I

INITIAL REPORT

1. Total SAP Ceded Reserves Gross Policy Reserves calculated in accordance with SAP with respect to the reinsured risks.
  
  2. Ceding Commission:
    - A. Excess SAP Ceded Reserves over GAAP Ceded Reserves:
      - 1) Total SAP Ceded Reserves \$ \_\_\_\_\_
      - 2) Total GAAP Ceded Reserves:  
Gross Policy Reserves calculated in accordance with GAAP with respect to the reinsured risks. \$ \_\_\_\_\_Excess SAP Reserves over GAAP Reserves (A1-A2)
  
    - B. Present Value of Future Profits (PVFP)
  
    - C. Deferred Acquisition Costs (DAC)
  
    - D. Asset Book Value Difference — Measured as of close of business the day preceding the Inception Date
      - 1) Asset Book Value (GAAP basis) \$ \_\_\_\_\_
      - 2) Asset Book Value (SAP basis) \$ \_\_\_\_\_Excess Asset Book Value (D1-D2)  
Total Ceding Commission (A+B+C+D)
  
  3. Accrued Interest on Assets as of the day before Inception Date
  
  4. Investment Cash Flows on the Assets from the Inception Date through the Closing Date  
Net Due Reinsurer (1-2-3+4)
- 
-



SCHEDULE F - PART II

QUARTERLY REPORT

-

1. Benefits	\$ _____
2. Withdrawals from Claims Settlement Account	\$ _____
3. Expense Allowance	\$ _____
I. Quarterly Settlement Amount (-1+2-3) Net Due to (from) Reinsurer	\$ _____ \$ _____

---

SCHEDULE F - PART III

ANNUAL REPORT

1. Benefits	\$ _____
2. Withdrawals from Claims Settlement Account	\$ _____
3. Expense Allowance	\$ _____
I. Quarterly Settlement Amount (-1+2-3) Net Due to (from) Reinsurer (I-II)	\$ _____ \$ _____

---

SCHEDULE G

FORM OF TRUST AGREEMENT

-

SCHEDULE H

ELIGIBLE SECURITIES

Assets of the types for which an Illinois-domiciled life insurance company could obtain full statutory reserve credit under statutory accounting practices prescribed or permitted by the Director of Insurance of the State of Illinois.

---

**RETROCESSION AGREEMENT**  
**between**  
**GENERAL ELECTRIC CAPITAL ASSURANCE COMPANY**  
**and**  
**UNION FIDELITY LIFE INSURANCE COMPANY**  
**Dated as of April 15, 2004**

---

TABLE OF CONTENTS

<a href="#">ARTICLE I</a>	<a href="#">DEFINITIONS</a>	
<a href="#">ARTICLE II</a>	<a href="#">COVERAGE</a>	
<a href="#">ARTICLE III</a>	<a href="#">ADMINISTRATION; GENERAL PROVISIONS</a>	
<a href="#">ARTICLE IV</a>	<a href="#">CLAIMS SETTLEMENT ACCOUNT; CLAIMS</a>	
<a href="#">ARTICLE V</a>	<a href="#">REINSURANCE ASSET TRANSFER; CEDING COMMISSION</a>	
<a href="#">ARTICLE VI</a>	<a href="#">EXPENSE ALLOWANCES</a>	
<a href="#">ARTICLE VII</a>	<a href="#">ACCOUNTING AND SETTLEMENT</a>	
<a href="#">ARTICLE VIII</a>	<a href="#">EXPERIENCE REFUND</a>	
<a href="#">ARTICLE IX</a>	<a href="#">DURATION AND TERMINATION</a>	
<a href="#">ARTICLE X</a>	<a href="#">INSOLVENCY</a>	
<a href="#">ARTICLE XI</a>	<a href="#">CREDIT FOR REINSURANCE</a>	
<a href="#">ARTICLE XII</a>	<a href="#">REINSURANCE SECURITY</a>	
<a href="#">ARTICLE XIII</a>	<a href="#">DEFERRED ACQUISITION COSTS</a>	
<a href="#">ARTICLE XIV</a>	<a href="#">INDEMNIFICATION</a>	
<a href="#">ARTICLE XV</a>	<a href="#">DISPUTE RESOLUTION</a>	
<a href="#">ARTICLE XVI</a>	<a href="#">PRIVACY REQUIREMENTS</a>	
<a href="#">ARTICLE XVII</a>	<a href="#">MISCELLANEOUS PROVISIONS</a>	
<u>SCHEDULES</u>		
<a href="#">SCHEDULE A</a>		<a href="#">= POLICY FORMS</a>
<a href="#">SCHEDULE B</a>		<a href="#">= FORM OF ADMINISTRATIVE SERVICES AGREEMENT</a>
<a href="#">SCHEDULE C</a>		<a href="#">= CEDING COMMISSION</a>
<a href="#">SCHEDULE D</a>		<a href="#">= ASSETS</a>
<a href="#">SCHEDULE E</a>		<a href="#">= EXPENSE ALLOWANCES</a>
<a href="#">SCHEDULE E-1</a>		<a href="#">= BUSINESS OVERHEAD SERVICES</a>
<a href="#">SCHEDULE F</a>	<a href="#">= PART I</a>	<a href="#">= INITIAL REPORT</a>
<a href="#">SCHEDULE F</a>	<a href="#">= PART II</a>	<a href="#">= MONTHLY SETTLEMENT REPORT</a>
<a href="#">SCHEDULE F</a>	<a href="#">= PART III</a>	<a href="#">= QUARTERLY SETTLEMENT REPORT</a>
<a href="#">SCHEDULE F</a>	<a href="#">= PART IV</a>	<a href="#">= ANNUAL REPORT</a>
<a href="#">SCHEDULE G</a>		<a href="#">= FORM OF TRUST AGREEMENT</a>
<a href="#">SCHEDULE H</a>		<a href="#">= ELIGIBLE SECURITIES</a>
<a href="#">SCHEDULE I</a>		<a href="#">= EXPERIENCE REFUND</a>

## RETROCESSION AGREEMENT

This Retrocession Agreement, dated as of April 15, 2004 (this "Agreement"), is made and entered into by and between General Electric Capital Assurance Company, an insurance company organized under the laws of the State of Delaware (the "Company"), and Union Fidelity Life Insurance Company, an insurance company organized under the laws of the State of Illinois (the "Reinsurer"). Defined terms used herein are defined below.

The Company and the Reinsurer mutually agree to reinsure the risks described in this Agreement under the terms and conditions stated herein. This Agreement is an indemnity retrocession agreement solely between the Company and the Reinsurer, and the performance of the obligations of each party under this Agreement shall be rendered solely to the other party. In no instance shall anyone other than the Company or the Reinsurer have any rights under this Agreement. The Company shall be and shall remain the only party hereunder that is liable to Travelers under the Travelers Reinsurance Agreement or to any insured, contract holder, policyholder, claimant or beneficiary under any Novated Policy.

This Agreement is entered into in connection with an intercompany reorganization among the Company, the Reinsurer and certain of their Affiliates.

Nothing in this Agreement, express or implied, is intended to or shall assign, delegate, sublicense or transfer, in whole or in part, any rights, interests or obligations under the Travelers Agreements.

### ARTICLE I

#### DEFINITIONS

1.1. Definitions. As used in this Agreement, the following terms shall have the following meanings (definitions are applicable to both the singular and the plural forms of each term defined in this Article):

"Accounting Period" means each calendar month, except that the last Accounting Period shall be the period commencing with the first day of the month in which the Termination Date falls and ending with the Termination Date.

"Affiliate" means any other Person that directly or indirectly controls, is controlled by, or is under common control with, the first Person. "Control" (including the terms, "controlled by" and "under common control with") means the possession, directly or indirectly, of the power to direct or cause the direction of the management and policies of a Person, whether through the ownership of voting securities, by contract or credit arrangement, as trustee or executor, or otherwise.

"Agreement" shall have the meaning specified in the first paragraph of this Agreement.

---

"Allocated Loss Adjustment Expenses" means all costs, fees and expenses incurred by the Company or its Affiliates in the investigation, adjustment, settlement or defense of all claims or the monitoring, preservation or enforcement of rights, interests or benefits arising out of or relating to the Reinsured Policies (excluding office expenses and salaries of officials of the Company or its Affiliates or any other administrative or overhead expenses of the Company or of its Affiliates), and court costs, and interest on any judgment or award. Allocated Loss Adjustment Expenses shall also include expenses associated with an action by any entity for declaratory judgment filed in connection with the Reinsured Policies.

"Annual Report" shall have the meaning specified in Section 7.5.

"Applicable Law" means any federal, state, local or foreign law (including common law), statute, ordinance, rule, regulation, order, writ, injunction, judgment, permit governmental agreement or decree applicable to a Person or any of such Person's subsidiaries, properties, assets, or to such Person's officers, directors, managing directors, employees or agents in their capacity as such.

"Assets" shall have the meaning specified in Section 5.4(a).

"Assignment Letter Agreement" means the letter agreement dated the date hereof among General Electric Capital Corporation, a Delaware corporation, the Reinsurer, the Company and certain affiliates of the Company relating to the assignment by General Electric Capital Corporation of the Capital Maintenance Agreement.

"Business Day" means any day other than a Saturday, Sunday or other day on which commercial banks in the States of Illinois or Virginia are required or authorized by law to be closed.

"Business Overhead Services" shall have the meaning specified in Schedule E-1 hereto.

"Capital Maintenance Agreement" means the Capital Maintenance Agreement between General Electric Capital Corporation, a Delaware corporation, and the Reinsurer.

"Ceding Commission" shall have the meaning specified in Section 5.3.

"Claims Settlement Account" shall have the meaning specified in Section 4.1(a).

"Closing Date" means April 15, 2004.

"Code" means the Internal Revenue Code of 1986, as amended.

"Company Account" shall have the meaning specified in Section 12.1(e).

"CPR" shall have the meaning specified in Section 15.3.

"CPR Arbitration Rules" shall have the meaning specified in Section 15.4(a).



---

“Dispute” shall have the meaning specified in Section 15.1(a).

“Eligible Securities” shall have the meaning specified in Section 12.1(c).

“Expense Allowance” shall have the meaning specified in Section 6.1.

“Experience Account” has the meaning set forth in Section 8.1(a)

“Experience Refund” has the meaning set forth in Section 8.1(c)

“Experience Refund Baseline” has the meaning set forth in Section 8.1(a)

“Extra Contractual Liabilities” means all liabilities for damages (including compensatory, consequential, exemplary, punitive, bad faith or similar or other damages) which (i) arise out of the conduct of the Company on or prior to the Inception Date in seeking premium rate increases pursuant to the terms of the Travelers Reinsurance Agreement or the Travelers Servicing Agreement or (ii) relate to the marketing, sale, underwriting, issuance, delivery, cancellation or administration of the Reinsured Policies, including liability arising out of or relating to any alleged or actual acts, errors or omissions by the Company or its agents, whether intentional or otherwise, with respect to any of the Reinsured Policies, including (A) any alleged or actual reckless conduct or bad faith in connection with the handling of any claim arising out of or under Reinsured Policies, or (B) the marketing, sale, underwriting, issuance, delivery, cancellation or administration of any of the Reinsured Policies.

“Force Majeure” shall have the meaning specified in Section 3.9(b)(iii).

“Funding Requirement” shall have the meaning specified in Section 12.1(e).

“GAAP” means U.S. generally accepted accounting principles consistently applied.

“Governmental Authority” means any foreign or national government, any state or other political subdivision thereof, and any entity exercising executive, legislative, judicial, regulatory or administrative functions of or pertaining to government.

“Inception Date” shall have the meaning specified in Section 2.1.

“Initial Notice” shall have the meaning specified in Section 15.2.

“Initial Reinsurance Premium” shall have the meaning specified in Section 5.1.

“Initial Report” shall have the meaning specified in Section 7.1.

“Insolvency Fund” means any guarantee fund, insolvency fund, plan, pool, association, fund or other arrangement, however denominated, established or governed, which provides for any assessment of or payment or assumption by the Company of part or all of any claim, debt, charge, fee or other obligation of an insurer or reinsurer, or its successors or assigns,

which has been declared by any competent authority to be insolvent, or which is otherwise deemed unable to meet any claim, debt, charge, fee or other obligation in whole or in part.

“Loss” or “Losses” means the amount of liability paid or payable by the Company with respect to claims, losses, liabilities, damages, deficiencies, costs or expenses, including without limitation, any settlements or compromises or disputed claims, arising under the Reinsured Policies.

“Loss Carry Forward Amount” shall have the meaning specified in the Travelers Reinsurance Agreement.

“Minimum Claims Settlement Amount” shall have the meaning specified in Section 4.1(b).

“Monthly Settlement” shall have the meaning specified in Section 5.4(a).

“Monthly Settlement Report” shall have the meaning specified in Section 7.2.

“Novated Policies” shall have the meaning specified in Section 2.6.

“Person” means any natural person, firm, limited liability company, general partnership, limited partnership, joint venture, association, corporation, trust, Governmental Authority or other entity.

“Quarterly Settlement” shall have the meaning specified in Section 5.4(a).

“Quarterly Settlement Report” shall have the meaning specified in Section 7.3.

“RBC Reporting Letter Agreement” means the letter agreement dated the date hereof among the Company, the Reinsurer and certain affiliates of the Company relating to the Reinsurer’s requirement to provide periodic certifications and reports regarding the Reinsurer’s risk based capital ratio.

“Reinsured Policies” means the long term care insurance policies issued by or on behalf of Travelers prior to January 1, 2004 and written on the policy forms described in Schedule A and reinsured by the Company pursuant to the Travelers Reinsurance Agreement.

“Reinsured Risks” shall have the meaning specified in Section 2.1.

“Response” shall have the meaning specified in Section 15.2.

“SAP” means statutory accounting practices prescribed or permitted by the Insurance Department of the State of Delaware.

“Stop-Loss Payments” means the payments required by the Company or Travelers, as the case may be, pursuant to Section 2.5 of the Travelers Reinsurance Agreement.

“Tax DAC” means specified policy acquisition expenses capitalized and amortized under section 848 of the Code.

4

---

“Termination Date” means the effective date of any termination of this Agreement as provided in Article IX.

“Termination Letter Agreement” means the letter agreement dated the date hereof among the Company, the Reinsurer and certain affiliates of the Company relating to the rescission of this Agreement upon the failure of certain events to occur after the date hereof.

“Total Annual Contribution” has the meaning set forth in Section 8.1(b).

“Total SAP Ceded Reserves” means, as of any given date, the gross reserves of the Company calculated in accordance with SAP with respect to the Reinsured Risks, which shall consist of the sum of (A) (i) active life reserves, (ii) claim reserves (both case and incurred but not reported), (iii) unearned premium reserves, and (iv) advance premiums, less (B) due and unpaid premium receivable balances.

“Total GAAP Ceded Reserves” means, as of any given date, the gross reserves of the Company calculated in accordance with GAAP with respect to the Reinsured Risks, which shall consist of the sum of (A) (i) active life reserves (including related maintenance and loss expense reserves), (ii) claim reserves (both case and incurred but not reported), (iii) unearned premium reserves, and (iv) advance premiums, less (B) due and unpaid premium receivable balances.

“Travelers” means The Travelers Insurance Company, a Connecticut insurance company.

“Travelers Agreements” means, collectively, the Travelers Acquisition Agreement, the Travelers Reinsurance Agreement, the Travelers Servicing Agreement and the Travelers Side Letter.

“Travelers Acquisition Agreement” means the Acquisition Agreement dated as of April 14, 2000 between the Company and Travelers, including all amendments, modifications and supplements thereto made prior to January 1, 2004 or on or after January 1, 2004 with the consent of the Reinsurer.

“Travelers Reinsurance Agreement” means the Indemnity Reinsurance Agreement dated as of July 1, 2000 between the Company and Travelers, including all amendments, modifications and supplements thereto made prior to January 1, 2004, or on or after January 1, 2004 with the consent of the Reinsurer, and as contemplated in Section 2.7.

“Travelers Servicing Agreement” means the Administrative Services Agreement dated as of July 1, 2000 between Travelers and the Company, including all amendments, modifications and supplements thereto made prior to January 1, 2004 or on or after January 1, 2004 with the consent of the Reinsurer.

“Travelers Side Letter” means the letter agreement, dated April 14, 2000, between Travelers and the Company relating to or governing the novation of the Reinsured Policies reinsured by the Company pursuant to the Travelers Reinsurance Agreement, including all amendments, modifications and supplements thereto made prior to January 1, 2004 (including

5

---

without limitation the amendment thereto dated July 31, 2000) or on or after January 1, 2004 with the consent of the Reinsurer.

“Trust Account” shall have the meaning set forth in Section 12.1(a).

“Trust Agreement” shall have the meaning set forth in Section 12.1(a).

“Trustee” shall have the meaning set forth in Section 12.1(a).

“Ultimate Net Loss” shall have the meaning specified in Section 2.3(a).

## ARTICLE II

### COVERAGE

2.1. Coverage. Upon the terms and subject to the conditions and other provisions of this Agreement, as of 12:01 a.m. Eastern Time on January 1, 2004 (the “Inception Date”), the Company hereby retrocedes to the Reinsurer, and the Reinsurer hereby agrees to indemnify the Company for, one hundred percent (100%) of Ultimate Net Loss incurred by the Company and unpaid as of the Inception Date (the “Reinsured Risks”).

2.2. Conditions. (a) If the Company’s liability under any of the Reinsured Policies is changed because of changes made on or after the Inception Date in the terms and conditions of the Reinsured Policies (including to any contract riders or endorsements thereto) that are required due to changes in Applicable Law, the Reinsurer will share in the change proportionately to the coinsurance share hereunder and the Company and the Reinsurer will make all appropriate adjustments to amounts due each other under this Agreement.

(b) Except as otherwise set forth in paragraph (a) above, no changes, amendments or modifications made by the Company on or after the Inception Date in the terms and conditions of the Reinsured Policies which adversely affect the liability of the Reinsurer hereunder shall be covered hereunder without the prior written approval of such changes, amendments or modifications by the Reinsurer, which approval shall not be unreasonably withheld or delayed. In the event that any such changes, amendments or modifications are made by the Company in any Reinsured Policy without the prior written approval of the Reinsurer, this Agreement will cover Ultimate Net Loss incurred by the Company as if the non-approved changes, amendments or modifications had not been made.

2.3. Ultimate Net Loss. (a) Subject to the provisions of Sections 2.2, 2.3(b) and (c) and the terms and conditions of this Agreement, "Ultimate Net Loss" shall mean (i) in the case of all Reinsured Policies other than the Novated Policies, one hundred percent (100%) of the Company's liability arising under the Travelers Reinsurance Agreement (including without limitation Stop-Loss Payments due by the Company to Travelers under the Travelers Reinsurance Agreement) after making deductions for all recoveries, salvage and subrogations actually recovered, and (ii) in the case of Novated Policies (A) the actual Losses and Allocated Loss Adjustment Expenses payable by the Company after making deductions for all recoveries, salvage and subrogations actually recovered, (B) premium taxes due in respect of premiums and

6

---

other amounts paid on or after the Inception Date with respect to the Novated Policies, (C) Insolvency Fund assessments, net of any premium tax credits of the Company arising out of any such assessments, in respect of premiums and other amounts paid on or after the Inception Date with respect to the Novated Policies, (D) all amounts payable on or after the Inception Date for returns or refunds of premiums under the Novated Policies, (E) all liability for commission payments and other fees or compensation payable with respect to the Reinsured Policies in respect of premiums and other amounts paid on or after the Inception Date and (F) unclaimed property liabilities and obligations arising under or related to the Reinsured Policies and payable on or after the Inception Date.

(b) Any Extra Contractual Liabilities resulting from actions of the Company or its agents or reinsured by the Company under the Travelers Reinsurance Agreement shall be treated as a Loss for the purposes of this Agreement to the extent permitted by state law, except to the extent that any such Extra Contractual Liabilities are attributable to the conduct of the Company in its administration of the Reinsured Policies on or after the Inception Date, other than actions taken by the Company at the written request or direction of the Reinsurer.

(c) All recoveries or payments received by the Company subsequent to a loss settlement under this Agreement shall be applied as if recovered or received prior to the aforesaid settlement and all necessary adjustments shall be made by the parties hereto; provided, that nothing in this Section 2.3(c) shall be construed to mean that the Reinsurer's share of the Losses and Allocated Loss Adjustment Expenses under this Agreement are not recoverable until the Company's Ultimate Net Loss has been ascertained.

2.4. Territory. The territorial limits of this Agreement shall be identical with those of the Reinsured Policies.

2.5. Ceded Reinsurance. Subsequent to the Inception Date, the Company will not enter into any reinsurance arrangements with respect to the Reinsured Policies without the prior written consent of the Reinsurer, in its sole discretion.

2.6. Novation of Reinsured Policies. The Reinsurer acknowledges that the Company is obligated under the terms of the Travelers Agreements to use its reasonable best efforts to assume and effect the novation of each of the Reinsured Policies from Travelers to the Company, so as to substitute the Company, in lieu of Travelers, as the insurer directly liable to the underlying insureds under the Reinsured Policies. Any Reinsured Policy that has been novated to the Company is referred to in this Agreement as a "Novated Policy". In the event that a Reinsured Policy is novated from Travelers to the Company, such Reinsured Policy shall continue for all purposes of this Agreement to be a Reinsured Policy hereunder. The Reinsurer shall reimburse the Company for all costs reasonably incurred by the Company in seeking to so novate the Reinsured Policies, which, for the avoidance of doubt, are not included in the Expense Allowance.

2.7. Travelers Reinsurance Agreement. The Reinsurer acknowledges that the Company is obligated under the terms of the Travelers Side Letter to amend the Travelers Reinsurance Agreement not later than July 31, 2008, to increase the portion of the underlying business that Travelers has ceded to the Company on a coinsurance basis from ninety percent

7

---

(90%) to one hundred percent (100%) of the Reinsured Liabilities (as such term is defined in the Travelers Reinsurance Agreement). Any such increased cession of the Reinsured Liabilities (as such term is defined in the Travelers Reinsurance Agreement) shall be reinsured under this Agreement.

### ARTICLE III

#### ADMINISTRATION; GENERAL PROVISIONS

3.1. Contract Administration. (a) Subject to Section 3.9, the Company shall provide policyholder and claims servicing and Business Overhead Services identified on Schedule E-1 hereto with respect to the Reinsured Policies in accordance with the terms hereof. All claims paid by the Company shall be binding upon the Reinsurer; provided, however, that such claims are within the terms, conditions and limitations of the Reinsured Policies. The Company shall administer the Travelers Reinsurance Agreement and provide policyholder and claims servicing and such Business Overhead Services with respect to the Reinsured Policies in good faith and with the care, skill, prudence and diligence of a person experienced in administering long term care insurance business. The Company shall provide policyholder and claims servicing and such Business Overhead Services with respect to the Reinsured Policies, (i) in accordance with the terms of the Reinsured Policies, (ii) in accordance with the terms of the Travelers Agreements, (iii) in accordance with the applicable terms of this Agreement, (iv) in compliance with Applicable Law and, subject to the foregoing, (v) in the same manner as it conducts its own business not subject to this Agreement and (vi) in accordance with the Company's administrative performance standards in effect on the date hereof, with such revisions to such standards as are no less favorable to the Reinsurer than the Company's standards in effect on the date hereof. Notwithstanding the foregoing, the parties may, from time to time, mutually develop specific and/or different standards for providing such services with respect to the Reinsured Policies, provided, that such standards are not in conflict with the terms of the Travelers Agreements.

(b) The Company may subcontract for the performance of any policyholder or claims servicing service or services and such Business Overhead Services with respect to the Reinsured Policies to (i) an Affiliate or (ii) any other Person with the prior written consent of the Reinsurer, such consent not to be unreasonably withheld; provided, that the Company also subcontracts for such service or services for its own long term care insurance business not subject to this Agreement to such subcontractor; provided, further, that such subcontracting is permitted under the Travelers Servicing Agreement; and provided, further, that no such subcontracting shall relieve the Company from any of its obligations or liabilities hereunder, and the Company shall remain responsible for all obligations or liabilities of such subcontractor with regards to the providing of such service or services as if provided by the Company.

3.2. Claims Settlements. (a) With respect to Reinsured Policies that are not Novated Policies, the Company agrees that it will provide prompt notice to the Reinsurer of its intention to litigate a claim with respect to such Reinsured Policy, along with copies of all pleadings and reports of investigation with respect thereto. The Reinsurer shall have the right, at

8

its own expense, to participate jointly with the Company in the investigation, adjustment or defense of such litigation.

(b) With respect to Novated Policies, the Company agrees that it will provide prompt notice to the Reinsurer of its intention to contest, compromise or litigate a claim with respect to a Novated Policy, along with copies of all pleadings and reports of investigation with respect thereto. The Reinsurer shall have the right, at its own expense, to participate jointly with the Company in the investigation, adjustment or defense of such claims with respect to Novated Policies. In addition, in the event that litigation arises against the Company in connection with a claim with respect to a Novated Policy which seeks damages in excess of \$1 million or other remedies deemed material to the Reinsurer, the Reinsurer may, upon written notice to the Company, assume the defense thereof with counsel selected by the Reinsurer and reasonably satisfactory to the Company. If the Reinsurer assumes such defense, the Company shall have the right, at its own expense, to participate jointly with the Reinsurer in the defense thereof. If the Reinsurer assumes the defense of litigation, the Reinsurer shall not settle such litigation without the Company's prior written consent (which consent shall not be unreasonably withheld or delayed) unless (i) there is no finding or admission of any violation of law or any violation of the rights of any Person, (ii) such settlement would not reasonably be expected to have material adverse precedential consequences to the Company and (iii) the sole relief provided is monetary damages that are paid in full by the Reinsurer.

3.3. Re-rating of Novated Policies. The Company (i) agrees to promptly seek to increase or decrease the premium rates under the Novated Policies from and after the Inception Date as directed by the Reinsurer and (ii) shall be entitled to increase premium rates without the consent of the Reinsurer. With respect to the Novated Policies, neither the Reinsurer nor the Company may seek or implement, as applicable, a premium rate increase unless such premium rate increase would have been permitted under the terms of Section 3.2(i) of the Travelers Servicing Agreement assuming such Novated Policies continued to be "Reinsured Contracts" as defined under the Travelers Servicing Agreement. Notwithstanding the foregoing, neither the Reinsurer nor the Company may seek or implement, as applicable, more than one (1) premium rate increase with respect to the Novated Policies in any state in any period of three (3) calendar years.

Except as required by Section 3.3(i) or by Applicable Law, the Company shall refrain from seeking any decrease in the premium rates under the Novated Policies from and after the Inception Date.

The Reinsurer shall bear, and shall indemnify the Company for, all costs and liabilities incurred in or arising out of seeking or effecting any premium rate changes at the direction of the Reinsurer, which, for the avoidance of doubt, are not included in the Expense Allowance.

3.4. Inspection. The Company shall keep accurate and complete records, files and accounts of all transactions and matters with respect to the Reinsured Policies and the administration thereof in accordance with Applicable Law and its record management practices in effect from time to time for the Company's insurance business not covered by this Agreement. The Reinsurer and its designated representatives may upon reasonable notice inspect, at the

9

---

offices of the Company where such records are located, the papers and any and all other books or documents of the Company reasonably relating to this Agreement, including the Reinsured Policies and the administration thereof by the Company (including compliance with the provisions of Section 3.1), and shall have access to appropriate employees and representatives of the Company, in each case during normal business hours for such period as this Agreement is in effect or for as long thereafter as the Company seeks performance by the Reinsurer pursuant to the terms of this Agreement or the Reinsurer reasonably needs access to such records for regulatory, tax or similar purposes. The information obtained shall be used only for purposes relating to the transactions contemplated under this Agreement.

3.5. Errors and Omissions. If any delay, omission, error or failure to pay amounts due or to perform any other act required by this Agreement is unintentional and caused by misunderstanding or oversight, the Company and the Reinsurer will adjust the situation to what it would have been had the misunderstanding or oversight not occurred. The party first discovering such misunderstanding or oversight, or an act resulting from such misunderstanding or oversight, will notify the other party in writing promptly upon discovery thereof, and the parties shall act to correct such misunderstanding or oversight within twenty (20) Business Days of such other party's receipt of such notice. However, this Section shall not be construed as a waiver by either party of its right to enforce strictly the terms of this Agreement.

3.6. Age, Sex and Other Adjustments. If the Company's liability under any of the Reinsured Policies is changed because of a misstatement of age or sex or any other material fact, the Reinsurer will share in the change proportionately to the coinsurance share hereunder and the Company and the Reinsurer will make all appropriate adjustments to amounts due each other under this Agreement.

3.7. Setoff. Any debts or credits, matured or unmatured, in favor of or against either the Company or the Reinsurer with respect to this Agreement or any other reinsurance agreement between the Company and the Reinsurer, are deemed mutual debts or credits, as the case may be, and shall be setoff from any amounts due to the Company or the Reinsurer hereunder, as the case may be, and only the net balance shall be allowed or paid.

3.8. Salvage and Subrogation. The Company shall use all commercially reasonable efforts to fully obtain the benefit of any and all potential recoveries, salvage and subrogations that would reasonably be expected to reduce the amount of Ultimate Net Loss.

3.9. Administration by Reinsurer. (a) At any time from and after the fifteenth (15<sup>th</sup>) anniversary of the Inception Date, the Reinsurer shall have the right to assume from the Company the administration of the Novated Policies, provided that the Reinsurer provides twelve (12) months prior written notice of such assumption, which notice may be given as early as the fourteenth (14<sup>th</sup>) anniversary of the Inception Date to take effect as of the fifteenth (15<sup>th</sup>) anniversary of the Inception Date. The Reinsurer shall bear all transition costs associated with an assumption of the administration of the Novated Policies pursuant to this paragraph (a) of this Section 3.9.

10

---

(b) In addition to the provisions of Section 3.9(a), the Reinsurer shall have the right, upon written notice to the Company to assume from the Company the administration of the Novated Policies upon the occurrence of any of the following events:

- (i) A voluntary or involuntary proceeding is commenced in any jurisdiction by or against the Company for the purpose of conserving, rehabilitating or liquidating the Company;
- (ii) There is a material breach by the Company of any material term or condition of this Article III that is not cured by the Company within thirty (30) days after receipt of written notice from the Reinsurer of such breach or act (provided that the Reinsurer shall not have the right to assume such administration (A) for so long as the Company is making a good faith effort to cure such breach, not to exceed an additional one hundred eighty

(180) days or (B) during the pendency of any dispute resolution proceedings as set forth in Article XV regarding an alleged material breach); or

(iii) The Company is unable to perform the services required under this Article III for a period of thirty (30) consecutive days for any reason, other than as a result of a Force Majeure, it being understood that nothing in this Section 3.9(b)(iii) shall relieve the Company from its administrative responsibilities under this Agreement. For purposes of this Agreement "Force Majeure" means any acts or omissions of any civil or military authority, acts of God, acts or omissions of the Reinsurer, fires, strikes or other labor disturbances, equipment failures, fluctuations or non-availability of electrical power, heat, light, air conditioning or telecommunications equipment, or any other act, omission or occurrence beyond the Company's reasonable control, irrespective of whether similar to the foregoing enumerated acts, omissions or occurrences.

(c) The Company shall bear all transition costs associated with an assumption of the administration of the Novated Policies pursuant to Section 3.9(b).

(d) In the event of the Reinsurer's assumption of the administration of the Novated Policies, the Reinsurer and the Company shall enter into an administrative services agreement in the form attached hereto as Schedule B and the provisions of Article IV, Article VI and Article VII shall become inoperative with respect to the Novated Policies.

#### ARTICLE IV

##### CLAIMS SETTLEMENT ACCOUNT; CLAIMS

4.1. Claims Settlement Account. (a) On the Closing Date, the Reinsurer shall establish a separate bank account (the "Claims Settlement Account") in its own name for the payment of Reinsured Risks and shall authorize two signatories who shall be representatives of the Company and approved by the Reinsurer in writing to issue drafts in the name of the

11

---

Reinsurer and showing the identity of the Company. The Reinsurer shall fund such account for payment of claims in accordance with the provisions of Section 4.1(b). Any interest earned on the Claims Settlement Account shall belong to the Reinsurer. The Claims Settlement Account shall be administered by the Company in a fiduciary capacity and shall be used solely by the Company to make payments of claims in accordance with the terms of this Agreement.

(b) The Reinsurer shall deposit \$7.5 million in the Claims Settlement Account on the Closing Date and shall thereafter fund the Claims Settlement Account on or before the fifth (5th) day of each month in amounts agreed by the Company and the Reinsurer from time to time in amounts sufficient to provide funds to the Company for the payment of Reinsured Risks during the next thirty (30) days, or such other amount as may be mutually agreed by the parties (such initial deposit amount and each minimum funding amount as agreed from time to time shall be referred to as a "Minimum Claims Settlement Amount"). In addition, the Reinsurer shall deposit to the Claims Settlement Account such additional amounts as may be required to keep the balance of such account above zero at all times. In consideration of the Reinsurer providing the Claims Settlement Account arrangement, the Company agrees that it shall apply funds in the Claims Settlement Account against the Reinsurer's liability under this Agreement until such funds are exhausted.

(c) The Company shall keep true and complete records, in accordance with Applicable Law and its record management practices in effect from time to time for the Company's insurance business not covered by this Agreement, clearly recording the deposits in and withdrawals from the Claims Settlement Account, including records relating to the payment of Reinsured Risks from the Claim Settlement Account. The Company will make available to the Reinsurer, or shall furnish to the Reinsurer or its designated representative, upon request of the Reinsurer or its designated representative, copies of all such records. All copies furnished in the ordinary course of business shall be furnished by the Company at the Company's cost, which shall be included in the Expense Allowance. Any extraordinary costs reasonably incurred by the Company in response to requests from the Reinsurer shall be reimbursed by the Reinsurer.

(d) Within thirty (30) days after each Accounting Period (or more frequently as mutually agreed by the parties), the Company shall render a complete accounting to the Reinsurer detailing all transactions with respect to the Claims Settlement Account, in such form as agreed by the parties.

(e) The parties agree to deliver to the depository bank such depository resolutions, signature cards and other documents as may be requested of them in order to use such accounts at the depository bank in accordance with the provisions of this Article IV.

(f) Upon a termination of this Agreement pursuant to Article IX, the Reinsurer shall close the Claims Settlement Account and any closing balance therein shall be the property of the Reinsurer. The Company's claims payment authority under this Agreement with respect to the Claims Settlement Account shall terminate immediately upon termination of this Agreement pursuant to Article IX. Upon termination of its authority to pay claims, the Company shall promptly return to the Reinsurer all unused check stock held by it in connection with this Agreement.

12

#### ARTICLE V

##### REINSURANCE ASSET TRANSFER; CEDING COMMISSION

5.1. Initial Reinsurance Premium. As consideration for the reinsurance by the Reinsurer of the Reinsured Risks under this Agreement, on the Closing Date the Reinsurer shall be entitled to an amount equal to one hundred percent (100%) of the Total SAP Ceded Reserves as of the close of business on the day immediately preceding the Inception Date (the "Initial Reinsurance Premium").

5.2. Additional Reinsurance Premium. As additional consideration for the Reinsurer entering into this Agreement, Reinsurer shall be entitled to 100% of all premiums and other considerations (including all reinsurance premium and Stop-Loss Payments from Travelers to the Company under the Travelers Reinsurance Agreement) to the extent received on or after the Inception Date by the Company or the Reinsurer with respect to the Reinsured Policies, including premium receivables that were due and unpaid as of the Inception Date that were taken into account in the calculation of the Initial Reinsurance Premium.

5.3. Ceding Commission. On the Closing Date, the Company shall be entitled to a ceding commission (the "Ceding Commission") in an amount determined in accordance with Schedule C. On the date of amendment of the Travelers Reinsurance Agreement as described in Section 2.7, the Reinsurer shall pay to the Company an additional ceding commission equal to the ceding commission payable by the Company to Travelers at such time pursuant to such agreement.

5.4. Amounts Due the Parties. (a) Except as otherwise specifically provided herein, all amounts due to be paid to the Company under this Agreement shall be determined on a net basis, giving full effect to Section 3.7. The net amount due the Reinsurer from the Company on the Closing Date under Section 5.1 and Section 5.3 shall consist of (i) the investment assets (the "Assets") set forth on Schedule D, which assets have a statutory book value as of the close of business on the day

immediately preceding the Inception Date equal to (A) the Initial Reinsurance Premium, less (B) the Ceding Commission, less (C) an amount equal to accrued but unpaid interest on the Assets as of the close of business on the day immediately preceding the Inception Date, plus (ii) an amount equal to the investment cash flows received on the Assets between the Inception Date and the Closing Date. The Company shall pay such net amount concurrent with its delivery of the Initial Report. Each net amount subsequently due with respect to each Accounting Period ending after the Inception Date (the "Monthly Settlement") shall be paid in cash by the Reinsurer to the Company no later than thirty (30) days after delivery of the Monthly Settlement Report. Each net amount subsequently due with respect to each calendar quarter ending after the Inception Date (the "Quarterly Settlement") shall be paid in cash by the Reinsurer to the Company no later than thirty (30) days after delivery of the Quarterly Settlement Report. Each net amount subsequently due with respect to each calendar year ending after the Inception Date as reflected on an Annual Report shall be paid in cash by the Reinsurer to the Company no later than thirty (30) days after delivery of the Annual Report.

(b) The Company shall deliver to the Reinsurer possession of the Assets and such bills of sale, endorsements, assignments and other good and sufficient instruments of

13

---

conveyance and transfer in form and substance reasonably acceptable to the parties as shall be effective to vest in the Reinsurer all of the right, title and interest of the Company in and to the Assets. Delivery of the Assets shall be a condition precedent of reinsurance coverage hereunder.

## ARTICLE VI

### EXPENSE ALLOWANCES

6.1. Expense Allowance. As reimbursement for expenses incurred by the Company in providing services with respect to the Reinsured Policies and Travelers Agreements, the Reinsurer shall pay to the Company with respect to each Accounting Period ending after the Inception Date, an expense allowance (each an "Expense Allowance") in an amount calculated in accordance with Schedule E, as subsequently adjusted in accordance with the methodology and procedures set forth in Schedule E.

## ARTICLE VII

### ACCOUNTING AND SETTLEMENT

7.1. Initial Report. A report shall be provided by the Company to the Reinsurer on the Closing Date providing the data required in Schedule F - Part I (the "Initial Report").

7.2. Monthly Settlement Reports. As soon as practicable but not more than thirty (30) days following the end of each Accounting Period ending after the Closing Date (or more frequently as mutually agreed by the parties), the Company shall supply the Reinsurer with a report that shall provide the financial data for such Accounting Period required in Schedule F - Part II (the "Monthly Settlement Report").

7.3. Quarterly Settlement Reports. As soon as practicable but not more than forty (40) days following the end of each calendar quarter ending after the Closing Date (or more frequently as mutually agreed by the parties), the Company shall supply the Reinsurer with a report that shall provide the financial data for such quarter required in Schedule F - Part III (the "Quarterly Settlement Report"). The Company and the Reinsurer agree that the financial data set forth on the Monthly Settlement Reports used for purposes of the Monthly Settlements, shall be true-up to actual amounts in the next Quarterly Settlement Report and the net amount, if any, subsequently due to the Company or the Reinsurer, as the case may be, as a result of such adjustments shall be paid to the Company or the Reinsurer, as applicable. For the avoidance of doubt, the first Quarterly Settlement Report will include all transactions with respect to the Reinsured Policies occurring from the Inception Date through June 30, 2004.

7.4. Quarterly Financial Reports. As soon as practicable but not more than forty (40) days following the end of each calendar quarter ending after the Closing Date (or more frequently as mutually agreed by the parties), the Company shall supply the Reinsurer with reports related to the Reinsured Policies as may be reasonably requested for use in connection

14

---

with the preparation of the Reinsurer's SAP financial statements or other reports prepared by the Reinsurer in compliance with its internal reporting requirements. The parties shall cooperate in good faith to establish the form for the providing of such reports.

7.5. Annual Reports. Within forty-five (45) days after the end of each calendar year during the term of this Agreement (or more frequently as mutually agreed by the parties), the Company shall supply the Reinsurer with a report that shall provide the financial data for such year required in Schedule F - Part IV (the "Annual Report").

7.6. Additional Reports and Updates. For so long as this Agreement remains in effect, each of the parties shall periodically furnish to the other such other reports and information as may be reasonably requested by such other party for regulatory, tax or similar purposes and reasonably available to it.

7.7. Delayed Payments. In the event that all or any portion of any payment due either party pursuant to this Agreement becomes overdue, the portion of the amount overdue shall bear interest at an annual rate equal to the then current thirty (30) day U.S. Treasury Bill discount rate on the date that the payment becomes overdue plus 200 basis points, for the period that the amount is overdue.

## ARTICLE VIII

### EXPERIENCE REFUND

8.1. Experience Refund. (a) The Reinsurer shall establish, and maintain through December 31, 2018, a notional account known as the "Experience Account" in connection with this Agreement, and record therein certain cumulative experience on the Reinsured Policies as described below. As of the Inception Date, the balance of the Experience Account will equal zero. Within the first forty five (45) days of each calendar year beginning January 1, 2005, through calendar year beginning January 1, 2019, the Company shall make the following calculation regarding certain experience on the Reinsured Policies during the preceding calendar year (which result may be a positive or a negative number), and shall promptly thereafter deliver to the Reinsurer the result of such calculation:

X equals the excess of (i) over (ii) (the result of which may be a positive number or a negative number), where (i) is the actual statutory basis pre-tax income earned on the Reinsured Policies for the calendar year for which the calculation is being made, calculated consistent with projected statutory basis pre-tax income earned on the Reinsured Policies (the "Experience Refund Baseline") as calculated on Schedule I hereto, but utilizing actual experience (e.g., actual premiums and expenses will be used in place of the projected amounts shown on Schedule I), except for investment income during the first three years (see below) and (ii) is the Experience Refund Baseline for the calendar year for which the calculation is being made as set forth on Schedule I hereto; and Y equals 90% for calculations made with respect to calendar years 2004 through 2006 and 50% for calculations made with respect to calendar years thereafter; provided.

however, that if the cumulative amount of X during the calendar years 2004-2006 exceeds \$65 million, then Y shall be reduced to 50% for any amounts of X over \$65 million. The calculation of investment income and the IMR income components of the actual pre-tax income for 2004-2006 shall be based on an assumed net annual yield of 6.19%, 6.08% and 6.02% respectively. To derive investment income, the prior stated rates should be applied to a 2 point average of the sum of Total SAP Ceded Reserves and statutory IMR liability. The two points should be December 31<sup>st</sup> for the applicable settlement year and December 31<sup>st</sup> for the immediately prior year. Surplus assets and investment income thereon are excluded from the Experience Refund Baseline calculation, and therefore should also be excluded from the Total Annual Contribution calculation. Thereafter the investment income and IMR income shall be similarly calculated using the actual net yield (net of investment expenses and default costs) and allocated IMR from the Reinsurer's LTC asset portfolio backing the Total SAP Ceded Reserves.

(b) The result of the calculation in Section 8.1(a) for each calendar year shall be referred to in this Agreement as the "Total Annual Contribution." Following each calculation of Total Annual Contribution, the balance of the Experience Account will be adjusted as of the end of the preceding calendar year as follows:

- (i) The balance of the Experience Account will be increased by: (A) the amount of the Total Annual Contribution for the preceding calendar year, but only if such Total Annual Contribution is a positive number and (B) interest credited in accordance with the terms of Section 8.1(d) below on any positive balance of the Experience Account.
- (ii) The balance of the Experience Account will be decreased by: (A) the amount of the Total Annual Contribution for the preceding calendar year, but only if such Total Annual Contribution is a negative number, (B) interest credited in accordance with the terms of Section 8.1(d) below on any negative balance of the Experience Account, and (C) the amount, if any, paid by the Reinsurer to the Company in accordance with the terms of Section 8.1(c) below.

(c) Subject to Section 8.1(c), each calendar year that the balance of the Experience Account is a positive number following the adjustments contemplated in Section 8.1(b) above (other than the adjustment contemplated in Section 8.1(b)(ii)(C)), the Reinsurer shall pay to the Company an "Experience Refund" as follows: (i) For calendar years ending prior to December 31, 2018, the Reinsurer shall pay to the Company the lesser of (A) the balance of the Experience Account and (B) an amount equal to the sum of (x) 20% of each positive Total Annual Contribution made with respect to the previous five (5) calendar years (or shorter period in the event that this Agreement has not been in effect for five (5) years) plus (y) interest credited to the balance of the Experience Account during the previous calendar year in accordance with Section 8.1(d) below if the balance of the Experience Account was positive during such year; and (ii) For calendar year ending December 31, 2018, the Reinsurer shall pay to the Company the balance of the Experience Account as of December 31, 2018 (if a positive number). Any amounts due pursuant to this Section 8.1(c) shall be paid by the Reinsurer to the Company not later than thirty (30) days following the Company's delivery to the Reinsurer of the Company's calculation of the Total Annual Contribution for the preceding calendar year. In

no event shall the Company be required to make any Experience Refund payments to the Reinsurer or return any Experience Refund payments to the Reinsurer, including if the balance of the Experience Account was, is or becomes a negative number.

(d) Interest shall accrue on the balance of the Experience Account (positive or negative) at an annual rate equal to the one (1) year U.S. Treasury Bill discount rate in effect on the close of business on July 1 or, if July 1 is not a Business Day, on the next Business Day of the current calendar year plus 100 basis points. Interest shall be credited to the balance of the Experience Account as of the end of each calendar year immediately before making any adjustments for the Total Annual Contribution with respect to such calendar year.

(e) Notwithstanding anything contained in this Section 8.1 to the contrary, no Experience Refund payments shall be made to the Company on any Reinsured Policies with respect to any period following the Reinsurer's assumption of the administration of the Novated Policies pursuant to Section 3.9.

#### ARTICLE IX

##### DURATION AND TERMINATION

9.1. Duration. Except as otherwise provided herein, this Agreement shall be unlimited in duration.

9.2. Reinsurer's Liability. The Reinsurer's liability with respect to the Reinsured Risks will terminate on the earliest of: (i) the date the Company's liability with respect to the Reinsured Risks is terminated and all amounts due the Company from the Reinsurer with respect to such Reinsured Risks are paid to the Company by or on behalf of the Reinsurer; and (ii) the date this Agreement is terminated upon the written agreement of the parties.

9.3. Notice of Termination. Upon the termination of the Reinsurer's liability with respect to the Reinsured Risks referred to in Section 9.2 above, the parties shall mutually give the Trustee written notice of their intention to terminate the Trust Account.

#### ARTICLE X

##### INSOLVENCY

10.1. Payments. In the event of the insolvency of the Company, the reinsurance payable by the Reinsurer hereunder shall be payable directly to the Company or to its domiciliary liquidator or receiver on the basis of liability of the Reinsurer under the contract or contracts reinsured, without diminution because of the insolvency of the Company. It is agreed and understood, however, that (i) in the event of the insolvency of the Company, the Reinsurer shall be given written notice of the pendency of a claim against the insolvent Company on a Reinsured Policy within a reasonable time after such claim is filed in the insolvency proceeding and (ii) during the pendency of such claim the Reinsurer may investigate such claim and

interpose, at its own expense, in the proceeding where such claim is to be adjudicated any defenses which it may deem available to the Company or its domiciliary liquidator, receiver or statutory successor.

10.2. Expenses. It is further understood that any expense thus incurred by the Reinsurer pursuant to Section 10.1 shall be chargeable, subject to court approval, against the insolvent Company as part of the expense of liquidation to the extent of a proportionate share of the benefit which may accrue to the Company solely as a result of the defense undertaken by the Reinsurer. Where two or more assuming reinsurers are involved in the same claim and a majority in interest elect to interpose defenses to such claim, the expense shall be apportioned in accordance with the terms of this Agreement as though such expense had been incurred by the Company.

## ARTICLE XI

### CREDIT FOR REINSURANCE

11.1. Reinsurance Credit. Notwithstanding any other provision of this Agreement to the contrary, if the Reinsurer becomes unauthorized or otherwise unaccredited as an insurer or reinsurer in any U.S. jurisdiction to which the Company must provide statutory statements of financial condition such that the Company will not obtain full statutory financial statement credit for reinsurance in such state for the reinsurance provided under this Agreement, the Reinsurer, upon the request of the Company, will establish, at the Reinsurer's sole cost and option, trust accounts for the benefit of the Company, letters of credit, or other acceptable alternatives necessary to permit the Company to obtain such full statutory financial statement credit for such reinsurance in all applicable jurisdictions. The Company shall cooperate with the Reinsurer to take such steps. In addition, in such event, the Reinsurer agrees to amend this Agreement and the Trust Agreement to the extent required under Applicable Law in order to provide the Company with such full statutory financial statement credit.

## ARTICLE XII

### REINSURANCE SECURITY

12.1. Trust. (a) On the Closing Date, the Reinsurer shall enter into a trust agreement in the form attached as Schedule G (the "Trust Agreement") and establish a trust account (the "Trust Account") for the benefit of the Company with respect to the Reinsured Risks with a bank (the "Trustee") designated as a Qualified United States Financial Institution by the Securities Valuation Office of the National Association of Insurance Commissioners or any successor organization or regulatory agency having similar duties.

(b) The Reinsurer agrees to deposit, and maintain in the Trust Account with respect to this Agreement, assets to be held in trust by the Trustee for the benefit of the Company as security for the payment of the Reinsurer's obligations to the Company under this Agreement.

(c) The parties agree that the assets so deposited with respect to this Agreement shall be valued according to their current statutory book value on the books of the Reinsurer and shall consist only of cash (United States legal tender), certificates of deposit (issued by a United States bank and payable in United States legal tender), and other assets of the type specified on Schedule H attached hereto ("Eligible Securities").

(d) The Reinsurer, prior to depositing assets with the Trustee, shall execute all assignments and endorsements in blank, or transfer legal title to the Trustee of all shares, obligations or any other assets requiring assignments, in order that, to the extent practicable, the Company, or the Trustee upon direction of the Company, may whenever necessary negotiate any such assets without consent or signature from the Reinsurer or any other entity. The Company recognizes that certain assets in the Trust Account will not be readily negotiable and that certain notices, opinions of counsel, representations and/or consents will be required for the Company to obtain good and marketable title to such assets.

(e) The Reinsurer and the Company agree that the assets in the Trust Account with respect to this Agreement may be withdrawn for the following purposes only:

- (i) to pay or reimburse the Company for any amount due the Company pursuant to this Agreement to the extent not so paid or reimbursed by the Reinsurer;
- (ii) to pay to the Reinsurer, in accordance with paragraph (h) below, any amounts held in the Trust Account that exceed an amount (the "Funding Requirement") equal to the sum of Total SAP Ceded Reserves and any additional reserves attributable to the Reinsured Risks that arise as a result of regulatory asset adequacy analysis requirements of the Reinsurer, less, prior to the date on which the Claims Settlement Account is closed, the Minimum Claims Settlement Amount then in effect; and
- (iii) in the event that General Electric Capital Corporation breaches its obligations under the Capital Maintenance Agreement, to fund an account with the Company (the "Company Account") in an amount at least equal to the deduction, for reinsurance ceded, from the Company's liabilities ceded under this Agreement. Such amount shall include, but not be limited to, amounts for policy reserves, reserves for claims and losses incurred (including losses incurred but not reported), loss and loss adjustment expenses, and unearned premiums.

(f) In the event that the Company withdraws assets from the Trust Account for the purposes set forth in Section 12.1(e)(i) above in excess of actual amounts required to meet the Reinsurer's obligations to the Company, the Company will promptly return such excess to the Reinsurer, plus interest at an annual rate equal to the then current thirty (30) day U.S. Treasury Bill discount rate on the date of withdrawal plus 200 basis points for the period during which the amounts were held pursuant to Section 12.1(e)(i). In the event that the Company withdraws assets from the Trust Account for the purposes set forth in Section 12.1(e)(iii) above, (i) the Reinsurer shall be relieved of its obligation to maintain assets in the Trust Account

pursuant to this Section 12.1 to the extent of the amount of funds held in the Company Account and (ii) the Company shall first apply the funds in the Company Account in satisfaction of the Reinsurer's liability under this Agreement until the funds in the Company Account are exhausted. In the event that the Company withdraws assets from the



Trust Account for the purposes set forth in Section 12.1(e)(iii) above, promptly following the date the Reinsurer's liability with respect to the Reinsured Risks is terminated, the Company shall return to the Reinsurer any assets so withdrawn that, together with any and all interest, dividends and other earnings thereon from the date of withdrawal to the date of return, are in excess of actual amounts required to meet the Reinsurer's obligations to the Company under this Agreement.

(g) The initial deposit to the Trust Account with respect to this Agreement shall be made on the Closing Date and shall consist of assets with a statutory book value equal to the Total SAP Ceded Reserves as of the close of business on the day immediately preceding the Inception Date, less an amount of assets with a statutory book value equal to the initial Minimum Claims Settlement Amount.

(h) The aggregate statutory book value of the assets held in the Trust Account with respect to this Agreement, shall at all times be at least equal to the Funding Requirement, and shall be adjusted on a quarterly basis so as to equal the Funding Requirement. On a quarterly basis, the Company shall promptly prepare and deliver to the Reinsurer a specific statement of the Funding Requirement and the Reinsurer shall promptly prepare and deliver to the Company a specific statement of the statutory book value of the assets in the Trust Account, in each case as of the end of the quarter. If the statement shows that the Funding Requirement exceeds 100% of the balance of the Trust Account with respect to this Agreement as of the statement date, the Reinsurer shall, within ten (10) Business Days after receipt of such notice of excess, secure delivery to the Trustee of additional cash or Eligible Securities having a current statutory book value equal to such difference. If the statement shows that the Funding Requirement is less than 100% of the balance of the Trust Account with respect to this Agreement as of the statement date, the Company shall, within ten (10) Business Days after delivery of such statement to the Reinsurer, deliver a notice of withdrawal to the Trustee directing the Trustee to withdraw from the Trust Account and deliver to the Reinsurer assets from the Trust Account having a current statutory book value equal to such excess amount. In addition to the foregoing, the Reinsurer shall prepare and deliver to the Company on a quarterly basis a specific statement of the market value of the assets in the Trust Account as of the end of the quarter.

## ARTICLE XIII

### DEFERRED ACQUISITION COSTS

13.1. Tax DAC Information Sharing. To ensure consistency in their respective Tax DAC calculations for tax purposes, the Company and the Reinsurer will exchange information pertaining to the amount of net consideration under this Agreement each year. The Company will submit a schedule to the Reinsurer by February 28 of each year presenting its calculation of the net consideration for the preceding taxable year. The Reinsurer may contest the calculation by providing to the Company and alternative calculation in writing within thirty

20

---

(30) days of receipt of the Company's schedule. The Company and the Reinsurer will act in good faith to resolve any differences in the schedule of calculations within thirty (30) days of receipt of the alternative calculation to ensure consistent amounts are reported on the respective tax returns for the preceding tax year.

## ARTICLE XIV

### INDEMNIFICATION

14.1. Indemnification. (a) The Reinsurer agrees to indemnify and hold the Company harmless from any and all Losses (as defined in the Travelers Reinsurance Agreement) paid by the Company to any Cedent Indemnities (as defined in the Travelers Reinsurance Agreement) pursuant to Section 16.1 of the Travelers Reinsurance Agreement.

(b) The Company shall provide to the Reinsurer the benefits of any of the Company's indemnification rights under Section 16.2 of the Travelers Reinsurance Agreement and under Section 9.2 of the Travelers Acquisition Agreement. Except as contemplated by Section 2.7, without the prior written consent of the Reinsurer, which consent shall not be unreasonably withheld, the Company shall not amend, modify, waive or fail to enforce any term or provision of any of the Travelers Agreements, if such amendment, modification, waiver or failure to enforce could reasonably be expected to increase the liability of the Reinsurer hereunder.

(c) The Company shall use its commercially reasonable efforts to take, fully at the Reinsurer's expense, all actions necessary to maintain in full force and effect the Company's rights of indemnification under the Travelers Agreements. The Company shall refrain from taking any action that would reasonably be expected to limit or diminish Travelers' obligations thereunder; provided, however, that this paragraph shall not prohibit a Change of Control of the Reinsurer (as defined in the Travelers Acquisition Agreement).

## ARTICLE XV

### DISPUTE RESOLUTION

15.1. General Provisions. (a) Any dispute, controversy or claim arising out of or relating to this Agreement or the validity, interpretation, breach or termination thereof (a "Dispute"), shall be resolved in accordance with the procedures set forth in this Article XV, which shall be the sole and exclusive procedures for the resolution of any such Dispute unless otherwise specified below.

(b) Commencing with the request contemplated by Section 15.2, all communications between the parties or their representatives in connection with the attempted resolution of any Dispute, including any mediator's evaluation referred to in Section 15.3, shall be deemed to have been delivered in furtherance of a Dispute settlement and shall be exempt from discovery and production, and shall not be admissible in evidence for any reason (whether

21

---

as an admission or otherwise), in any arbitral or other proceeding for the resolution of the Dispute.

(c) In connection with any Dispute, the parties expressly waive and forego any right to (i) punitive, exemplary, statutorily-enhanced or similar damages in excess of compensatory damages, and (ii) trial by jury.

(d) The specific procedures set forth below, including but not limited to the time limits referenced therein, may be modified by agreement of the parties in writing.

(e) All applicable statutes of limitations and defenses based upon the passage of time shall be tolled while the procedures specified in this Article XV are pending. The parties will take such action, if any, required to effectuate such tolling.

15.2. Consideration by Senior Executives. If a Dispute is not resolved in the normal course of business at the operational level, the parties shall attempt in good faith to resolve such Dispute by negotiation between executives who hold, at a minimum, the office of President and CEO of the respective business entities involved in such Dispute. Either party may initiate the executive negotiation process by providing a written notice to the other (the "Initial Notice"). Fifteen (15) days after delivery of the Initial Notice, the receiving party shall submit to the other a written response (the "Response"). The Initial Notice and the Response shall include (i) a statement of the Dispute and of each party's position, and (ii) the name and title of the executive who will represent that party and of any other person who will accompany the executive. Such executives will meet in person or by telephone within thirty (30) days of the date of the Initial Notice to seek a resolution of the Dispute.

15.3. Mediation. If a Dispute is not resolved by negotiation as provided in Section 15.2 within forty-five (45) days from the delivery of the Initial Notice, then either party may submit the Dispute for resolution by mediation pursuant to the CPR Institute for Dispute Resolution (the "CPR") Model Mediation Procedure as then in effect. The parties will select a mediator from the CPR Panels of Distinguished Neutrals, but such mediator must have prior U.S. reinsurance experience either as a lawyer or as a present or former officer or management employee of a reinsurance company, but not of the Company, or the Reinsurer, or any of their respective affiliates. Either party at commencement of the mediation may ask the mediator to provide an evaluation of the Dispute and the parties' relative positions.

15.4. Arbitration. (a) If a Dispute is not resolved by mediation as provided in Section 15.3 within thirty (30) days of the selection of a mediator (unless the mediator chooses to withdraw sooner), either party may submit the Dispute to be finally resolved by arbitration pursuant to the CPR Rules for Non-Administered Arbitration as then in effect (the "CPR Arbitration Rules"). The parties consent to a single, consolidated arbitration for all known Disputes existing at the time of the arbitration and for which arbitration is permitted.

(b) The neutral organization for purposes of the CPR Arbitration Rules will be the CPR. The arbitral tribunal shall be composed of three arbitrators who are each experienced in the U.S. reinsurance business, of whom each party shall appoint one in accordance with the "screened" appointment procedure provided in Rule 5.4 of the CPR Arbitration Rules. The non-

22

---

party appointed arbitrator must have prior U.S. reinsurance experience as a present or former officer or management employee of a reinsurance company, but not of the Company, or the Reinsurer, or any of their respective affiliates. The arbitration shall be conducted in New York City. Each party shall be permitted to present its case, witnesses and evidence, if any, in the presence of the other party. A written transcript of the proceedings shall be made and furnished to the parties. The arbitrators shall determine the Dispute in accordance with the law of Delaware, without giving effect to any conflict of law rules or other rules that might render such law inapplicable or unavailable, and shall apply this Agreement according to its terms, provided that the provisions relating to arbitration shall be governed by the Federal Arbitration Act, 9 U.S.C. §§ 1 et seq. The arbitral tribunal shall endeavor to render its award or order resulting from any arbitration within forty-five (45) days following the termination of the arbitration proceedings.

(c) The parties agree to be bound by any award or order resulting from any arbitration conducted hereunder and further agree that judgment on any award or order resulting from an arbitration conducted under this Section may be entered and enforced in any court having jurisdiction thereof.

(d) Except as expressly permitted by this Agreement, no party will commence or voluntarily participate in any court action or proceeding concerning a Dispute, except (i) for enforcement as contemplated by Section 15.4(c) above, (ii) to restrict or vacate an arbitral decision based on the grounds specified under applicable law, or (iii) for interim relief as provided in paragraph (e) below. For purposes of the foregoing the parties hereto submit to the non-exclusive jurisdiction of the courts of the State of New York.

(e) In addition to the authority otherwise conferred on the arbitral tribunal, the tribunal shall have the authority to make such orders for interim relief, including injunctive relief, as it may deem just and equitable. Notwithstanding paragraph (d) above, each party acknowledges that in the event of any actual or threatened breach of certain of the provisions of this Agreement, the remedy at law would not be adequate, and therefore injunctive or other interim relief may be sought immediately to restrain such breach. If the tribunal shall not have been appointed, either party may seek interim relief from a court having jurisdiction if the award to which the applicant may be entitled may be rendered ineffectual without such interim relief. Upon appointment of the tribunal following any grant of interim relief by a court, the tribunal may affirm or disaffirm such relief, and the parties will seek modification or rescission of the court action as necessary to accord with the tribunal's decision.

(f) Each party will bear its own attorneys' fees and costs incurred in connection with the resolution of any Dispute in accordance with this Article XV.

## ARTICLE XVI

### PRIVACY REQUIREMENTS

16.1. Privacy Requirements. In providing the administrative services provided for under this Agreement, and in connection with maintaining, administering, handling and

23

---

transferring the data of the policyholders and other recipients of benefits under the Reinsured Policies, the Company shall, and shall cause its Affiliates and any permitted subcontractor to, comply with all confidentiality and security obligations applicable to them in connection with the collection, use, disclosure, maintenance and transmission of personal, private, health or financial information about individual policyholders or benefit recipients, including the provisions of privacy policies under which such information was gathered, those laws currently in place and which may become effective during the term of this Agreement, including the Gramm-Leach-Bliley Act, the Health Insurance Portability and Accountability Act of 1996 and any other Applicable Laws. The Company shall entitle the Reinsurer and its agents and representatives, the Commissioner of Health and Human Services and such other Governmental Authorities, to the extent required by Applicable Law, to audit the Company's compliance herewith. The Company shall also enable individual subjects of personally identifiable information, upon request from such individuals, to review and correct information maintained by the Company about them, and to restrict use of such information. The Company shall promptly report to the Reinsurer any violation of this provision of which the Company becomes aware. Unless required by Applicable Law, the Company shall not during the term of this Agreement, modify the privacy policies under which information utilized by the Company in administering the Reinsured Policies is gathered, without the Reinsurer's prior written consent, which consent shall not be unreasonably withheld. The parties hereto agree to comply with the terms of the Business Associate Addendum attached hereto.

## ARTICLE XVII

### MISCELLANEOUS PROVISIONS

17.1. Headings and Schedules. Headings used herein are not a part of this Agreement and shall not affect the terms hereof. The attached Schedules are

a part of this Agreement.

17.2. Notices. All notices, requests, demands and other communications under this Agreement must be in writing and will be deemed to have been duly given or made as follows: (a) if sent by registered or certified mail in the United States return receipt requested, upon receipt; (b) if sent by reputable overnight air courier, two business days after mailing; (c) if sent by facsimile transmission, with a copy mailed on the same day in the manner provided in (a) or (b) above, when transmitted and receipt is confirmed by telephone; or (d) if otherwise actually personally delivered, when delivered, and shall be delivered as follows:

If to the Company:

General Electric Capital Assurance Company  
6610 West Broad Street  
Richmond, VA 23230  
Facsimile: (804) 281-6165  
Attention: Chief Executive Officer

24

---

With a copy to:

General Electric Capital Assurance Company  
6620 West Broad Street  
Richmond, VA 23230  
Facsimile: (804) 662-2414  
Attention: General Counsel

If to the Reinsurer:

Union Fidelity Life Insurance Company  
200 North Martingale Road  
Schaumburg, IL 60173-2096  
Facsimile: (847) 330-3404  
Attention: Chief Financial Officer

With a copy to:

Union Fidelity Life Insurance Company  
200 North Martingale Road  
Schaumburg, IL 60173-2096  
Facsimile: (847) 605-3044  
Attention: General Counsel

or to such other address or to such other Person as either party may have last designated by notice to the other party.

17.3. Successors and Assigns. This Agreement shall be binding upon and inure to the benefit of the parties hereto and their respective successors, permitted assigns and legal representatives. Neither this Agreement, nor any right or obligation hereunder, may be assigned by any party without the prior written consent of the other party hereto. Any assignment in violation of this Section 17.3 shall be void and shall have no force and effect. Nothing in this Section 17.3 shall be construed to prohibit the Reinsurer from retroceding all or any portion of the business reinsured hereunder.

17.4. Execution in Counterpart. This Agreement may be executed by the parties hereto in any number of counterparts, and by each of the parties hereto in separate counterparts, each of which counterparts, when so executed and delivered, shall be deemed to be an original, but all such counterparts shall together constitute but one and the same instrument.

17.5. Currency. Whenever the word "Dollars" or the "\$" sign appear in this Agreement, they shall be construed to mean United States Dollars, and all transactions under this Agreement shall be in United States Dollars.

17.6. Amendments. This Agreement may not be changed, altered or modified unless the same shall be in writing executed by the Company and the Reinsurer.

25

---

17.7. Governing Law. This Agreement will be construed, performed and enforced in accordance with the laws of the State of Delaware, without giving effect to its principles or rules of conflict of laws thereof to the extent such principles or rules would require or permit the application of the laws of another jurisdiction.

17.8. Entire Agreement; Severability. (a) This Agreement and the Termination Letter Agreement constitute the entire agreement between the parties hereto relating to the subject matter hereof and supersede all prior and contemporaneous agreements, understandings, statements, representations and warranties, negotiations and discussions, whether oral or written, of the parties and there are no general or specific warranties, representations or other agreements by or among the parties in connection with the entering into of this Agreement or the subject matter hereof except as specifically set forth or contemplated herein or in the Termination Letter Agreement.

(b) If any provision of this Agreement is held to be void, unenforceable or in violation of any provision of the Travelers Agreements, in whole or in part, (i) such holding or provision shall not affect the validity and enforceability of the remainder of this Agreement, including any other provision, paragraph or subparagraph, and (ii) the parties agree to attempt in good faith to reform such void, unenforceable or violative provision to the extent necessary to render such provision enforceable and to carry out its original intent.

17.9. Contemporaneous Agreements. Concurrent with the execution of this Agreement, the parties and/or their Affiliates are also entering into the Capital Maintenance Agreement, the RBC Reporting Letter Agreement and the Assignment Letter Agreement.

17.10. No Waiver; Preservation of Remedies. No consent or waiver, express or implied, by any party to or of any breach or default by any other party in

the performance by such other party of its obligations hereunder shall be deemed or construed to be a consent or waiver to or of any other breach or default in the performance of obligations hereunder by such other party hereunder. Failure on the part of any party to complain of any act or failure to act of any other party or to declare any other party in default, irrespective of how long such failure continues, shall not constitute a waiver by such first party of any of its rights hereunder. The rights and remedies provided are cumulative and are not exclusive of any rights or remedies that any party may otherwise have at law or equity.

17.11. Cooperation. Each party hereto shall cooperate fully with the other in all reasonable respects in order to accomplish the objectives of this Agreement including making available to each their respective officers and employees for interviews and meetings with Governmental Authorities and furnishing any additional assistance, information and documents as may be reasonably requested by a party from time to time

17.12. Third Party Beneficiary. Nothing in this Agreement will confer any rights upon any Person that is not a party or a successor or permitted assignee of a party to this Agreement.

17.13. Tax Exception to Any Confidentiality. Notwithstanding anything to the contrary set forth herein or in any other agreement to which the parties hereto are parties or by

26

---

which they are bound, any obligations of confidentiality contained herein and therein, as they relate to the transactions, shall not apply to the federal tax structure or federal tax treatment of the transactions, and each party hereto (and any employee, representative, or agent of any party hereto) may disclose to any and all persons, without limitation of any kind, the federal tax structure and federal tax treatment of the transactions. The preceding sentence is intended to cause the transactions to be treated as not having been offered under conditions of confidentiality for purposes of Section 1.6011-4(b)(3) (or any successor provision) of the Treasury Regulations promulgated under Section 6011 of the Internal Revenue Code of 1986, as amended, and shall be construed in a manner consistent with such purpose. In addition, each party hereto acknowledges that it has no proprietary or exclusive rights to the federal tax structure of the transactions or any federal tax matter or federal tax idea related to the transactions.

17.14. Interpretation. Wherever the words "include," "includes" or "including" are used in this Agreement, they shall be deemed to be followed by the words "without limitation."

17.15. Survival. Article XV and Article XVII shall survive the termination of this Agreement.

27

---

IN WITNESS WHEREOF, the parties hereto have caused this Agreement to be executed by their duly authorized representatives.

GENERAL ELECTRIC CAPITAL ASSURANCE COMPANY

By /s/ VICTOR C. MOSES

Name: Victor C. Moses

Title: Senior Vice President and Chief Actuary

UNION FIDELITY LIFE INSURANCE COMPANY

By /s/ GLENN JOPPA

Name: Glenn Joppa

Title: Senior Vice President and Secretary

28

---

SCHEDULE A

POLICY FORMS

LTC1 (1990-92)  
LTC2 Qualified (1990-99)  
LTC2 Non-Qualified (1990-99)  
LC2  
LTC3 (1993-95)  
LTC3+ Qualified Comprehensive (1993-2001)  
LTC3+ Non-Qualified Comprehensive (1993-2001)  
LTC3+ Qualified Facility (1993-1999)  
LTC3+ Non-Qualified Facility (1993-1999)  
LC3 Non-Qualified (1993-99)  
LC3+ Qualified (1996-97)  
LC3+ Non-Qualified (1996-97)  
LTC4 Qualified Comprehensive (1997-2001)  
LTC4 Non-Qualified Comprehensive (1998-2001)  
LTC4 Qualified Facility (1997-1999)  
LTC4 Non-Qualified Facility (1998-2001)  
LC4

---

SCHEDULE B

FORM OF ADMINISTRATIVE SERVICES AGREEMENT

---

LTC UFLIC/GECA

ADMINISTRATIVE SERVICES AGREEMENT

by and between

GENERAL ELECTRIC CAPITAL ASSURANCE COMPANY

and

UNION FIDELITY LIFE INSURANCE COMPANY

Effective as of [       ]

---

**ADMINISTRATIVE SERVICES AGREEMENT**

This ADMINISTRATIVE SERVICES AGREEMENT (this "Agreement"), effective as of [       ] (the "Effective Date"), is entered into by and between GENERAL ELECTRIC CAPITAL ASSURANCE COMPANY, an insurance company organized under the laws of the State of Delaware (the "Company"), and UNION FIDELITY LIFE INSURANCE COMPANY, an insurance company organized under the laws of the State of Illinois (the "Administrator").

**RECITALS:**

WHEREAS, the Company and the Administrator have entered into a Retrocession Agreement dated as of April 15, 2004 (the "Retrocession Agreement") which provides for the parties to enter into this Agreement;

WHEREAS, pursuant to the Retrocession Agreement, the Administrator has agreed to indemnify the Company for, among other things, 100% of Ultimate Net Loss incurred by the Company and unpaid as of the Inception Date with respect to the Novated Policies (capitalized terms used herein and not defined herein, unless otherwise indicated, have the respective meanings assigned to them in the Retrocession Agreement); and

WHEREAS, the Company wishes to appoint the Administrator to provide policyholder and claim servicing with respect to the Novated Policies, and the Administrator desires to provide such administrative services;

NOW, THEREFORE, in consideration of the covenants and agreements set forth herein, the parties hereto agree as follows:

ARTICLE I

AUTHORITY

The Company hereby appoints the Administrator, and the Administrator hereby accepts appointment, to provide as an independent contractor of the Company, from and after the Effective Date, all of the policyholder and claim servicing services necessary or appropriate with respect to the Novated Policies including those set forth in this Agreement (the "Administrative Services"), all on the terms as set forth in this Agreement. In providing the policyholder and claim servicing with respect to the Novated Policies, the Administrator shall handle all such matters, including but not limited to the billing and collection of premiums and the defense, adjustment, settlement and payment of all claims arising under the Novated Policies, as more fully described below. Notwithstanding any other provision of this Agreement to the contrary, the Company shall have the right to direct the Administrator to perform any action necessary for the Novated Policies or the policyholder and claim servicing thereof to comply with Applicable Law, or to cease performing any action that constitutes a violation of Applicable Law.

---

ARTICLE II

STANDARD FOR SERVICES; FACILITIES; SUBCONTRACTING

2.1. Standard for Services. The Administrator shall provide policyholder and claims servicing with respect to the Novated Policies in good faith and with the care, skill, prudence and diligence of a person experienced in administering long term care insurance business. Without limiting the generality of the foregoing, the Administrator shall provide policyholder and claims servicing with respect to the Novated Policies (i) in accordance with the terms of the Novated Policies, (ii) in accordance with the applicable terms of this Agreement, (iii) in compliance with Applicable Law, (iv) in accordance with industry standards and, subject to the foregoing, (v) to the extent applicable, in the same manner as it conducts its own business not subject to this Agreement.

2.2. Facilities and Personnel. To the extent not sub-contracted to a Subcontractor, the Administrator shall at all times maintain sufficient facilities and trained personnel of the kind necessary to perform its obligations under this Agreement in accordance with the performance standards set forth herein.

2.3. Subcontracting. The Administrator may subcontract for the performance of any policyholder or claims servicing service or services with respect to the Novated Policies to (i) an Affiliate or (ii) any other Person with the prior written consent of the Company, such consent not to be unreasonably withheld (in each case, the "Subcontractor"); provided, that, no such subcontracting shall relieve the Administrator from any of its obligations or liabilities hereunder, and the Administrator shall remain responsible for all obligations or liabilities of such Subcontractor with regards to the providing of such service or services as if provided by the Administrator.

ARTICLE III  
CLAIMS HANDLING

The Administrative Services with respect to claims for benefits including claims outstanding on the Effective Date, shall include the following:

3.1. Claim Administration Services. The Administrator shall acknowledge, consider, review, investigate, deny, settle, pay or otherwise dispose of each claim for benefits reported under each Novated Policy (each, a "Claim" and collectively the "Claims").

3.2. Description of Claim Administration Services. Without limiting the foregoing, the Administrator shall:

(i) provide claimants under the Novated Policy and their authorized representatives (collectively, "Claimants") with Claim forms and provide reasonable explanatory guidance to Claimants in connection therewith;

2

---

(ii) establish, maintain and organize Claim files and maintain and organize other Claims-related records;

(iii) review all Claims and determine whether the Claimant is eligible for benefits and if so, the nature and extent of such benefits;

(iv) prepare and distribute to the appropriate recipients any reports required by Applicable Law;

(v) respond to all written or oral Claims-related communications that the Administrator reasonably believes to require a response; and

(vi) maintain a complaint log with respect to the Novated Policies in accordance with applicable requirements of Governmental Authorities and provide a copy of such log, continuously updated through the last day of each calendar quarter during the term of this Agreement, to the Company on or before the tenth Business Day of each calendar quarter covering changes during the preceding calendar quarter.

ARTICLE IV  
REGULATORY AND LEGAL PROCEEDINGS

4.1. Regulatory Complaints and Proceedings. The Administrator shall:

(i) respond to any Claims payment related complaints or inquiries made by any Governmental Authority, within the Governmental Authority's requested time frame for response or, if no such time frame is provided, within the time frame as allowed by Applicable Law; and promptly provide a copy of such response to the Company;

(ii) promptly notify the Company of any non-Claims payment related complaints or inquiries initiated by a Governmental Authority, and of any proceedings (either Claims or non-Claims related) initiated by a Governmental Authority, and, in either case, prepare and send to the Governmental Authority, with a copy to the Company, a response within the Governmental Authority's requested time frame for response or, if no such time frame is provided, within the time frame as allowed by Applicable Law; provided, that, subject to meeting such time frames, the Administrator shall provide such response to the Company for its prior review and comment;

(iii) subject to Section 4.4, supervise and control the investigation, contest, defense and/or settlement of all complaints, inquiries and proceedings by Governmental Authorities at its own cost and expense, and in the name of the Company when necessary; and

3

---

(iv) at the Company's request, provide to the Company a report in a form mutually agreed by the parties summarizing the nature of any complaints, inquiries or proceedings by Governmental Authorities, the alleged actions or omissions giving rise to such complaints, inquiries or proceedings and copies of any files or other documents that the Company may reasonably request in connection with its review of these matters.

4.2. Legal Proceedings. The Administrator shall:

(i) notify the Company promptly of any lawsuit, action, arbitration or other dispute resolution proceedings that are instituted or threatened with respect to any matter relating to the Novated Policies ("Legal Proceeding(s)"), and in no event more than five (5) Business Days after receipt of notice thereof;

(ii) subject to Section 4.4, supervise and control the investigation, contest, defense and/or settlement of all Legal Proceedings at its own cost and expense, and in the name of the Company when necessary; and

(iii) keep the Company fully informed of the progress of all Legal Proceedings handled by the Administrator in which the Company is named a party and, at the Company's request, provide to the Company a report summarizing the nature of any Legal Proceedings, the alleged actions or omissions giving rise to such Legal Proceedings and copies of any files or other documents that the Company may reasonably request in connection with its review of these matters in each case other than such files, documents and other information as would, in the judgment of counsel to the Administrator, lead to the loss or waiver of legal privilege.

4.3. Notice to Administrator. The Company shall give prompt notice to the Administrator of any Legal Proceeding made or brought against the Company after the Inception Date arising under or in connection with the Novated Policies to the extent known to it and not made against or served on the Administrator or a Subcontractor as administrator hereunder, and in no event more than five (5) Business Days after receipt of notice thereof, and shall promptly furnish to the Administrator copies of all pleadings in connection therewith. The Administrator shall assume the defense of the Company.

4.4. Defense of Regulatory and Legal Proceedings. Notwithstanding anything in this Agreement to the contrary, the Company shall have the right to engage in its own separate legal representation, at its own expense, and to participate fully in the defense of any Legal Proceedings or complaints, inquiries or proceedings by Governmental Authorities with respect to the Novated Policies in which the Company is a named party without waiving any right to indemnification it may have under Article XVI hereof. The Administrator and the Company shall cooperate with each other with respect to the administration of any Legal Proceeding and any complaint, inquiry or

---

unreasonably withheld or delayed) unless (i) there is no finding or admission of any violation of law or any violation of the rights of any Person, (ii) such settlement would not reasonably be expected to have material adverse precedential consequences to the Company and (iii) the sole relief provided is monetary damages that are paid in full by the Administrator.

ARTICLE V

NOTIFICATION TO POLICYHOLDERS

The Administrator agrees to send to policyholders of the Novated Policies a written notice prepared by the Administrator and reasonably acceptable to the Company to the effect that the Administrator, or such other Person designated by the Administrator in accordance with the terms of this Agreement, has been appointed by the Company to provide Administrative Services. The Administrator shall send such notice by first class U.S. mail at a time reasonably acceptable to the Company and the Administrator and in all events in accordance with Applicable Law. The parties intend to minimize the cost associated with any notification under this Article V, including by means of inclusion of the notice in a regularly scheduled mailing to policyholders in lieu of a separate mailing. The cost associated with such notification under this Article V (upon the initial assumption of the administration of the Novated Policies under Section 3.9 of the Retrocession Agreement) shall be a transition cost payable by the Administrator or the Company in accordance with Section 3.9(a) or 3.9(c) of the Retrocession Agreement, as applicable.

ARTICLE VI

BILLINGS AND COLLECTIONS; RE-RATING OF NOVATED POLICIES

6.1. Billing and Collection Services. The Administrator shall assume all responsibility for billing and collecting premiums and other amounts payable with respect to the Novated Policies from and after the Effective Date. The Company shall promptly remit to the Administrator any such amounts received by it with respect to the Novated Policies.

6.2. Re-rating of Novated Policies. Subject to compliance with Applicable Law and this Section 6.2, the Administrator shall have the exclusive right, on behalf of the Company, to increase or decrease the premium rates under the Novated Policies from and after the Effective Date without the consent of the Company. The Administrator may not seek or implement, as applicable, a premium rate increase unless such premium rate increase would have been permitted under the terms of Section 3.2(i) of the Travelers Servicing Agreement assuming such Novated Policies continued to be "Reinsured Contracts" as defined under the Travelers Servicing Agreement. Notwithstanding the foregoing, the Administrator may not seek or implement, as applicable, more than one (1) premium rate increase with respect to the Novated Policies in any state in any period of three (3) calendar years. The Administrator shall bear, and shall indemnify the Company for, all costs and liabilities incurred in or arising out of seeking or effecting any premium rate changes at the direction of the Administrator.

---

ARTICLE VII

QUARTERLY PREMIUM TAX AND INSOLVENCY FUND ACCOUNTINGS

7.1. Quarterly Accountings. Within thirty (30) days after the end of each calendar quarter that this Agreement is in effect (or more frequently as mutually agreed by the parties), the Company shall submit to the Administrator a written statement of accounting in a form and containing such information to be agreed upon by the parties hereto (each, an "Insolvency Fund Quarterly Accounting") setting forth the Insolvency Fund amounts assessed or payable to the extent that such assessments constitute Reinsured Risks with respect to the Novated Policies (collectively, the "Post-Effective Date Assessments"). Within thirty (30) days after the last day of each calendar quarter that this Agreement is in effect (or more frequently as mutually agreed by the parties), the Administrator shall submit to the Company a written statement of accounting in a form and containing such information to be agreed upon by the parties hereto (each, a "Quarterly Premium Tax Accounting", and together with the Insolvency Fund Quarterly Accountings, the "Quarterly Accountings") setting forth the estimated premium taxes due with respect to the Novated Policies as a result of premiums collected during such quarter. Concurrent with the delivery of each Quarterly Premium Tax Accounting, the Administrator shall remit to the Company the amount set forth on such Quarterly Premium Tax Accounting with respect to such estimated premium taxes due and the amount set forth in such Insolvency Fund Quarterly Accounting with respect to the Post-Effective Date Assessments, and any other amounts owed to the Company pursuant to this Agreement; provided, however, that any Post-Effective Date Assessments set forth in an Insolvency Fund Quarterly Accounting received by the Administrator less than five (5) Business Days prior to the Administrator's delivery of such Quarterly Premium Tax Accounting will be paid within ten (10) Business Days of receipt by the Administrator of such Insolvency Fund Quarterly Accounting. Each of the parties agrees to supply to the other a copy of all supporting data used in preparing the Quarterly Accountings prepared by such party.

7.2. Adjustments Regarding Quarterly Accountings. In the event that subsequent data or calculations require revision of any of the Quarterly Accountings, the required revision and appropriate payments thereunder shall be made within ten (10) Business Days after the parties hereto mutually agree as to the appropriate revision.

ARTICLE VIII

CERTAIN ACTIONS BY COMPANY

8.1. Filings. The Company shall prepare and timely file any filings required to be made with any Governmental Authority that relate to the Company generally and not just to the Novated Policies, including filings with guaranty associations and filings and premium tax returns with taxing authorities. The Administrator shall, in a timely fashion in light of the dates such filings by the Company are required, provide to the Company all information in the possession of the Administrator with respect to the Novated Policies that may be reasonably required for the Company to prepare such filings and tax returns.

---

8.2. Annual Adjustment. The Company shall pay or provide to the Administrator the benefit of any Post-Effective Date Assessments which have



been or can be applied to reduce the Company's premium tax liability ("Premium Tax Credits"). The Company shall provide to the Administrator by March 15 of each year a statement of the amount (the "Annual Adjustment") of (i) premium taxes due with respect to premiums collected during the prior calendar year (to the extent that such premium taxes constitute Reinsured Risks with respect to the Novated Policies), less (ii) estimated premium taxes paid by the Administrator to the Company with respect to such premiums under the provisions of Article VII, less (iii) Premium Tax Credits for the prior calendar year. By March 30 of each year the Administrator shall pay to the Company the Annual Adjustment, if a positive amount, and the Company will pay or credit to the Administrator the Annual Adjustment, if a negative amount.

## ARTICLE IX

### REGULATORY MATTERS AND AUDIT REPORTING

9.1. Regulatory Compliance and Reporting. The Administrator shall provide to the Company such information with respect to the Novated Policies as is required to satisfy all current and future informational reporting, prior approval and any other requirements imposed by any Governmental Authority. Upon the reasonable request of the Company, the Administrator shall timely prepare such reports and summaries, including statistical summaries, as are necessary or reasonably required to satisfy any requirements imposed by a Governmental Authority upon the Company with respect to the Novated Policies. In addition, the Administrator, upon the reasonable request of the Company, shall promptly provide to the Company copies of all existing records relating to the Novated Policies (including, with respect to records maintained in machine readable form, hard copies) that are necessary to satisfy such requirements. All copies of records furnished in the ordinary course of business shall be furnished by the Administrator at the Administrator's cost. Any extraordinary costs reasonably incurred by the Administrator in response to requests from the Company shall be reimbursed by the Company. Among other responsibilities:

- (i) The Administrator shall promptly prepare and furnish to Governmental Authorities all reports and related summaries (including, without limitation, statistical summaries), certificates of compliance and other reports required or requested by a Governmental Authority.
- (ii) The Administrator shall assist the Company and cooperate with the Company in doing all things necessary, proper or advisable, in the most expeditious manner practicable in connection with any and all market conduct or other Governmental Authority examinations relating to the Novated Policies.

9.2. Reporting and Accounting. The Administrator shall assume the reporting and accounting obligations set forth below:

7

---

- (i) As soon as practicable but not more than forty (40) days after the end of each calendar quarter that this Agreement is in effect (or more frequently as mutually agreed by the parties), the Administrator shall timely provide to the Company reports and summaries of transactions (and, upon request of the Company, detailed supporting records) related to the Novated Policies as may be reasonably required for use in connection with the preparation of the Company's statutory and GAAP financial statements, tax returns and other required financial reports and to comply with the requirements of the regulatory authorities having jurisdiction over the Company, including all premium written and earned and all Losses and Allocated Loss Adjustment Expenses reserved, paid, and outstanding. The parties shall cooperate in good faith to establish the manner for the providing of such reports.
- (ii) The Administrator shall provide to the Company such reports or summaries (and, upon the request of the Company, detailed supporting records therefor) related to the payment of commissions under the Novated Policies as agreed by the parties.
- (iii) As soon as practicable but not more than forty (40) days after the end of each calendar quarter that this Agreement is in effect (or more frequently as mutually agreed by the parties), the Administrator shall report to the Company the amount of statutory reserves that the Company is required to maintain in connection with the Reinsured Risks with respect to the Novated Policies as of the quarter end.
- (iv) The Administrator shall promptly provide notice to the Company of any changes in the reserve methodology used by the Administrator in calculating statutory reserves for the Novated Policies.
- (v) Within forty-five (45) days after each calendar year end (or such longer time as may be agreed by the parties) that this Agreement is in effect, the Administrator shall provide to the Company (a) an opinion of an actuary reasonably acceptable to the Company as to the adequacy of statutory reserves for the Novated Policies, prepared according to accepted actuarial standards of practice, and as otherwise required for regulatory reporting purposes and (b) an analysis which reasonably supports such opinion.

9.3. Additional Reports and Updates. For so long as this Agreement remains in effect, each party shall periodically furnish to the other such other reports and information as may be reasonably required by such other party for regulatory, tax or similar purposes and reasonably available to it.

8

---

## ARTICLE X

### MISCELLANEOUS ADMINISTRATIVE SERVICES

The Administrator shall assume the obligations set forth below:

- (i) The Administrator shall timely pay to the policyholders, including any certificateholder thereunder, any refunds of any kind due under the Novated Policies.
- (ii) The Administrator shall process all policy changes, lapses, cancellations, and reinstatements in accordance with the terms of this Agreement and the express terms of the Novated Policies and shall assume responsibility for providing all other policyholder servicing in connection with the Novated Policies.
- (iii) The Administrator shall pay commissions due under the Novated Policies.
- (iv) The Administrator shall provide such other Administrative Services as are necessary or appropriate to fully effectuate the purpose of the Retrocession Agreement and this Agreement, including such Administrative Services as are not performed by or on behalf of Company on the date hereof but the need for which may arise due to changes or developments in Applicable Law.

ARTICLE XI  
BOOKS AND RECORDS

The Administrator shall keep accurate and complete records, files and accounts of all transactions and matters with respect to the Novated Policies and the administration thereof in accordance with Applicable Law and its record management practices in effect from time to time for the Administrator's insurance business not covered by this Agreement, if any. The parties to this Agreement and their designated representatives may upon reasonable notice inspect, at the offices of the Administrator or the Company where such records are located, the papers and any and all other books or documents of the Administrator or the Company reasonably relating to this Agreement, including the Novated Policies, and shall have access to appropriate employees and representatives of the other party, in each case during normal business hours for such period as this Agreement is in effect or for as long thereafter as any rights or obligations of any party survives or the Administrator or the Company reasonably need access to such records for regulatory, tax or similar purposes. The information obtained shall be used only for purposes relating to the transactions contemplated under this Agreement.

9

---

ARTICLE XII  
COOPERATION

Each party hereto shall cooperate fully with the other in all reasonable respects in order to accomplish the objectives of this Agreement including making available to each their respective officers and employees for interviews and meetings with Governmental Authorities and furnishing any additional assistance, information and documents as may be reasonably requested by a party from time to time.

ARTICLE XIII  
PRIVACY REQUIREMENTS

In providing the Administrative Services provided for under this Agreement, and in connection with maintaining, administering, handling and transferring the data of the policyholders and other recipients of benefits under the Novated Policies, the Administrator shall, and shall cause its Affiliates and any permitted Subcontractors to, comply with all confidentiality and security obligations applicable to them in connection with the collection, use, disclosure, maintenance and transmission of personal, private, health or financial information about individual policyholders or benefit recipients, including the provisions of privacy policies under which such information was gathered, those laws currently in place and which may become effective during the term of this Agreement, including the Gramm-Leach-Bliley Act, the Health Insurance Portability and Accountability Act of 1996 and any other Applicable Laws. The Administrator shall entitle the Company and its agents and representatives, the Commissioner of Health and Human Services and such other Governmental Authorities, to the extent required by Applicable Law, to audit the Administrator's compliance herewith. The Administrator shall also enable individual subjects of personally identifiable information, upon request from such individuals, to review and correct information maintained by the Administrator about them, and to restrict use of such information. The Administrator shall promptly report to the Company any violation of this provision of which the Administrator becomes aware. Unless required by Applicable Law, the Administrator shall not during the term of this Agreement, modify the privacy policies under which information utilized by the Administrator in administering the Novated Policies is gathered, without the Company's prior written consent, which consent shall not be unreasonably withheld. The parties agree to comply with the terms of the Business Associate Addendum attached hereto or such other written agreement as may be required by Applicable Law on the date hereof.

ARTICLE XIV  
CONSIDERATION FOR ADMINISTRATIVE SERVICES

Apart from the performance by the Company of its obligations under the Retrocession Agreement, there shall be no fee or other consideration due to the Administrator for performance of the Administrative Services under this Agreement.

10

---

ARTICLE XV  
BANK ACCOUNT; USE OF COMPANY LETTERHEAD

When and on terms reasonably requested by the Administrator, the Company shall open, modify or close, and make available for use by the Administrator for the payment of amounts to be paid by the Administrator hereunder one or more bank accounts of the Company and check stock of the Company. The Administrator shall maintain such account(s) and pay all applicable bank fees and check stock costs. The Company shall adopt such resolutions and execute such documents as required to designate senior officers of the Administrator (by title) as signatories on such account(s) and authorize the Administrator to certify to such bank(s), from time to time, the names of such officers. The Company shall also make available to the Administrator, at the sole expense of the Administrator, such letterhead, printed forms and other documents of the Company as may be reasonably required by the Administrator in performing services hereunder. Upon termination of this Agreement, the Administrator shall promptly return to the Company all such unused check stock, letterhead, printed forms and other documents held by it in connection with this Agreement as provided under this Article XV.

ARTICLE XVI  
INDEMNIFICATION

Any claim for or with respect to indemnification arising out of, or relating to, this Agreement or the Administrative Services hereunder shall be permitted under and governed by the provisions of Article V of the Master Agreement, dated as of [ ], 2004, among General Electric Company, General Electric Capital Corporation, GEI, Inc., GE Financial Assurance Holdings, Inc. and Genworth Financial, Inc (the "Master Agreement"), to the extent such provisions are applicable, as if this Agreement were a Transaction Document under the Master Agreement.

ARTICLE XVII  
DURATION; TERMINATION

17.1. Duration. This Agreement shall commence on the Effective Date and continue with respect to each Novated Policy until no further

Administrative Services in respect of such Novated Policy is required, unless this Agreement is earlier terminated under Section 17.2.

17.2. Termination. (a) This Agreement is subject to immediate termination at the option of the Company, upon written notice to the Administrator, on the occurrence of any of the following events:

- (i) A voluntary or involuntary proceeding is commenced in any jurisdiction by or against the Administrator for the purpose of conserving, rehabilitating or liquidating the Administrator;

11

---

- (ii) There is a material breach by the Administrator of any material term or condition of this Agreement that is not cured by the Administrator within thirty (30) days after receipt of written notice from the Company of such breach or act (provided that the Company shall not have the right to terminate this Agreement (A) for so long as the Administrator is making a good faith effort to cure such breach, not to exceed an additional one hundred eighty (180) days or (B) during the pendency of any dispute resolution proceedings as set forth in Article XVIII regarding an alleged material breach); or
- (iii) The Administrator is unable to perform the services required under this Agreement for a period of thirty (30) consecutive days for any reason other than as a result of a Force Majeure, it being understood that nothing in this Section 17.2(a)(iii) shall relieve the Administrator from its administrative responsibilities under this Agreement. For purposes of this Agreement, "Force Majeure" means any acts or omissions of any civil or military authority, acts of God, acts or omissions of the Company, fires, strikes or other labor disturbances, equipment failures, fluctuations or non-availability of electrical power, heat, light, air conditioning or telecommunications equipment, or any other act, omission or occurrence beyond the Administrator's reasonable control, irrespective of whether similar to the foregoing enumerated acts, omissions or occurrences.

(b) This Agreement may be terminated at any time upon the mutual written consent of the parties hereto, which writing shall state the effective date of termination.

(c) In the event that this Agreement is terminated under any of the provisions of Section 17.2(a), the Administrator shall select a third-party administrator to perform the services required by this Agreement. The Company shall have the right to approve any such administrator selected by the Administrator, but such approval will not unreasonably be withheld or delayed. If the Administrator fails to select an administrator pursuant to this Section 17.2(c), the Company shall select such an administrator. In either case, the Administrator shall pay all fees and charges imposed by the selected administrator and shall bear all transition costs associated with the transition of the performance of the services required under this Agreement to such administrator, including the expense of sending policyholder notices as provided in Article V.

#### ARTICLE XVIII

#### DISPUTE RESOLUTION

18.1. General Provisions. (a) Any dispute, controversy or claim arising out of or relating to this Agreement or the validity, interpretation, breach or termination thereof (a "Dispute"), shall be resolved in accordance with the procedures set forth in this Article XVIII, which shall be the sole and exclusive procedures for the resolution of any such Dispute unless otherwise specified below.

12

---

(b) Commencing with the request contemplated by Section 18.2, all communications between the parties or their representatives in connection with the attempted resolution of any Dispute, including any mediator's evaluation referred to in Section 18.3, shall be deemed to have been delivered in furtherance of a Dispute settlement and shall be exempt from discovery and production, and shall not be admissible in evidence for any reason (whether as an admission or otherwise), in any arbitral or other proceeding for the resolution of the Dispute.

(c) In connection with any Dispute, the parties expressly waive and forego any right to (i) punitive, exemplary, statutorily-enhanced or similar damages in excess of compensatory damages (provided that any such liability with respect to a Third Party Claim (as defined in the Master Agreement) shall be considered direct damages), and (ii) trial by jury.

(d) The specific procedures set forth below, including but not limited to the time limits referenced therein, may be modified by agreement of the parties in writing.

(e) All applicable statutes of limitations and defenses based upon the passage of time shall be tolled while the procedures specified in this Article XVIII are pending. The parties will take such action, if any, required to effectuate such tolling.

18.2. Consideration by Senior Executives. If a Dispute is not resolved in the normal course of business at the operational level, the parties shall attempt in good faith to resolve such Dispute by negotiation between executives who hold, at a minimum, the office of President and CEO of the respective business entities involved in such Dispute. Either party may initiate the executive negotiation process by providing a written notice to the other (the "Initial Notice"). Fifteen (15) days after delivery of the Initial Notice, the receiving party shall submit to the other a written response (the "Response"). The Initial Notice and the Response shall include (i) a statement of the Dispute and of each party's position, and (ii) the name and title of the executive who will represent that party and of any other person who will accompany the executive. Such executives will meet in person or by telephone within thirty (30) days of the date of the Initial Notice to seek a resolution of the Dispute.

18.3. Mediation. If a Dispute is not resolved by negotiation as provided in Section 18.2 within forty-five (45) days from the delivery of the Initial Notice, then either party may submit the Dispute for resolution by mediation pursuant to the CPR Institute for Dispute Resolution (the "CPR") Model Mediation Procedure as then in effect. The parties will select a mediator from the CPR Panels of Distinguished Neutrals, but such mediator must have prior U.S. reinsurance experience either as a lawyer or as a present or former officer or management employee of a reinsurance company, but not of the Company, or the Administrator, or any of their respective affiliates. Either party at commencement of the mediation may ask the mediator to provide an evaluation of the Dispute and the parties' relative positions.

18.4. Arbitration. (a) If a Dispute is not resolved by mediation as provided in Section 18.3 within thirty (30) days of the selection of a mediator (unless the mediator chooses to withdraw sooner), either party may submit the Dispute to be finally resolved by arbitration pursuant to the CPR Rules for Non-Administered Arbitration as then in effect (the "CPR

13

---

Arbitration Rules”). The parties consent to a single, consolidated arbitration for all known Disputes existing at the time of the arbitration and for which arbitration is permitted.

(b) The neutral organization for purposes of the CPR Arbitration Rules will be the CPR. The arbitral tribunal shall be composed of three arbitrators who are each experienced in the U.S. reinsurance business, of whom each party shall appoint one in accordance with the “screened” appointment procedure provided in Rule 5.4 of the CPR Arbitration Rules. The non-party appointed arbitrator must have prior U.S. reinsurance experience as a present or former officer or management employee of a reinsurance company, but not of the Company, or the Administrator, or any of their respective affiliates. The arbitration shall be conducted in New York City. Each party shall be permitted to present its case, witnesses and evidence, if any, in the presence of the other party. A written transcript of the proceedings shall be made and furnished to the parties. The arbitrators shall determine the Dispute in accordance with the law of Delaware, without giving effect to any conflict of law rules or other rules that might render such law inapplicable or unavailable, and shall apply this Agreement according to its terms, provided that the provisions relating to arbitration shall be governed by the Federal Arbitration Act, 9 U.S.C. §§ 1 et seq. The arbitral tribunal shall endeavor to render its award or order resulting from any arbitration within forty-five (45) days following the termination of the arbitration proceedings.

(c) The parties agree to be bound by any award or order resulting from any arbitration conducted hereunder and further agree that judgment on any award or order resulting from an arbitration conducted under this Section 18.4 may be entered and enforced in any court having jurisdiction thereof.

(d) Except as expressly permitted by this Agreement, no party will commence or voluntarily participate in any court action or proceeding concerning a Dispute, except (i) for enforcement as contemplated by Section 18.4(c) above, (ii) to restrict or vacate an arbitral decision based on the grounds specified under applicable law, or (iii) for interim relief as provided in paragraph (e) below. For purposes of the foregoing the parties hereto submit to the non-exclusive jurisdiction of the courts of the State of New York.

(e) In addition to the authority otherwise conferred on the arbitral tribunal, the tribunal shall have the authority to make such orders for interim relief, including injunctive relief, as it may deem just and equitable. Notwithstanding paragraph (d) above, each party acknowledges that in the event of any actual or threatened breach of certain of the provisions of this Agreement, the remedy at law would not be adequate, and therefore injunctive or other interim relief may be sought immediately to restrain such breach. If the tribunal shall not have been appointed, either party may seek interim relief from a court having jurisdiction if the award to which the applicant may be entitled may be rendered ineffectual without such interim relief. Upon appointment of the tribunal following any grant of interim relief by a court, the tribunal may affirm or disaffirm such relief, and the parties will seek modification or rescission of the court action as necessary to accord with the tribunal’s decision.

(f) Each party will bear its own attorneys’ fees and costs incurred in connection with the resolution of any Dispute in accordance with this Article XVIII.

---

ARTICLE XIX

MISCELLANEOUS PROVISIONS

19.1. Headings and Schedules. Headings used herein are not a part of this Agreement and shall not affect the terms hereof. The attached Schedules are a part of this Agreement.

19.2. Notices. All notices, requests, demands and other communications under this Agreement must be in writing and will be deemed to have been duly given or made as follows: (a) if sent by registered or certified mail in the United States return receipt requested, upon receipt; (b) if sent by reputable overnight air courier, two business days after mailing; (c) if sent by facsimile transmission, with a copy mailed on the same day in the manner provided in (a) or (b) above, when transmitted and receipt is confirmed by telephone; or (d) if otherwise actually personally delivered, when delivered, and shall be delivered as follows:

If to the Company:

General Electric Capital Assurance Company  
6610 West Broad Street  
Richmond, VA 23230  
Facsimile: (804) 281-6165  
Attention: Chief Executive Officer

With a copy to:

General Electric Capital Assurance Company  
6620 West Broad Street  
Richmond, VA 23230  
Facsimile: (804) 662-2414  
Attention: General Counsel

If to the Administrator:

Union Fidelity Life Insurance Company  
200 North Martingale Road  
Schaumburg, IL 60173-2096  
Facsimile: (847) 330-3404  
Attention: Chief Financial Officer

With a copy to:

Union Fidelity Life Insurance Company  
200 North Martingale Road  
Schaumburg, IL 60173-2096  
Facsimile: (847) 605-3044  
Attention: General Counsel

or to such other address or to such other Person as either party may have last designated by notice to the other party.

19.3. Successors and Assigns. This Agreement shall be binding upon and inure to the benefit of the parties hereto and their respective successors, permitted assigns and legal representatives. Neither this Agreement, nor any right or obligation hereunder, may be assigned by any party without the prior written consent of the other party hereto. Any assignment in violation of this Section 19.3 shall be void and shall have no force and effect.

19.4. Execution in Counterpart. This Agreement may be executed by the parties hereto in any number of counterparts, and by each of the parties hereto in separate counterparts, each of which counterparts, when so executed and delivered, shall be deemed to be an original, but all such counterparts shall together constitute but one and the same instrument.

19.5. Currency. Whenever the word "Dollars" or the "\$" sign appear in this Agreement, they shall be construed to mean United States Dollars, and all transactions under this Agreement shall be in United States Dollars.

19.6. Amendments. This Agreement may not be changed, altered or modified unless the same shall be in writing executed by the Company and the Administrator.

19.7. Governing Law. This Agreement will be construed, performed and enforced in accordance with the laws of the State of Delaware without giving effect to its principles or rules of conflict of laws thereof to the extent such principles or rules would require or permit the application of the laws of another jurisdiction.

19.8. Entire Agreement; Severability. (a) This Agreement constitutes the entire agreement between the parties hereto relating to the subject matter hereof and supersedes all prior and contemporaneous agreements, understandings, statements, representations and warranties, negotiations and discussions, whether oral or written, of the parties and there are no general or specific warranties, representations or other agreements by or among the parties in connection with the entering into of this Agreement or the subject matter hereof except as specifically set forth or contemplated herein.

(b) If any provision of this Agreement is held to be void, unenforceable or in violation of any provision of the Travelers Agreements, in whole or in part, (i) such holding or provision shall not affect the validity and enforceability of the remainder of this Agreement, including any other provision, paragraph or subparagraph, and (ii) the parties agree to attempt in good faith to reform such void, unenforceable or violative provision to the extent necessary to render such provision enforceable and to carry out its original intent.

19.9. No Waiver; Preservation of Remedies. No consent or waiver, express or implied, by any party to or of any breach or default by any other party in the performance by such other party of its obligations hereunder shall be deemed or construed to be a consent or waiver to or of any other breach or default in the performance of obligations hereunder by such other party hereunder. Failure on the part of any party to complain of any act or failure to act of any other party or to declare any other party in default, irrespective of how long such failure continues, shall not constitute a waiver by such first party of any of its rights hereunder. The

16

rights and remedies provided are cumulative and are not exclusive of any rights or remedies that any party may otherwise have at law or equity.

19.10. Third Party Beneficiary. Nothing in this Agreement will confer any rights upon any Person that is not a party or a successor or permitted assignee of a party to this Agreement.

19.11. Tax Exception to Any Confidentiality. Notwithstanding anything to the contrary set forth herein or in any other agreement to which the parties hereto are parties or by which they are bound, any obligations of confidentiality contained herein and therein, as they relate to the transactions, shall not apply to the federal tax structure or federal tax treatment of the transactions, and each party hereto (and any employee, representative, or agent of any party hereto) may disclose to any and all persons, without limitation of any kind, the federal tax structure and federal tax treatment of the transactions. The preceding sentence is intended to cause the transactions to be treated as not having been offered under conditions of confidentiality for purposes of Section 1.6011-4(b)(3) (or any successor provision) of the Treasury Regulations promulgated under Section 6011 of the Internal Revenue Code of 1986, as amended, and shall be construed in a manner consistent with such purpose. In addition, each party hereto acknowledges that it has no proprietary or exclusive rights to the federal tax structure of the transactions or any federal tax matter or federal tax idea related to the transactions.

19.12. Interpretation. Wherever the words "include," "includes" or "including" are used in this Agreement, they shall be deemed to be followed by the words "without limitation."

19.13. Survival. Article XVIII and Article XIX shall survive the termination of this Agreement.

17

IN WITNESS WHEREOF, the Company and the Administrator have executed this Agreement as of the date first above written.

GENERAL ELECTRIC CAPITAL ASSURANCE COMPANY

By: \_\_\_\_\_

Name:  
Title:

UNION FIDELITY LIFE INSURANCE COMPANY

By: \_\_\_\_\_

Name:  
Title:

18

## BUSINESS ASSOCIATE ADDENDUM

### I. Purpose.

In order to disclose certain information to the party providing a service under this Agreement (“Provider”) under this Addendum, some of which may constitute Protected Health Information (defined below), the party to whom a service under this Agreement is being provided (“Recipient”) and Provider mutually agree to comply with the terms of this Addendum for the purpose of satisfying the requirements of the Health Insurance Portability and Accountability Act of 1996 (“HIPAA”) and its implementing privacy regulations at 45 C.F.R. Parts 160-164 (“HIPAA Privacy Rule”). These provisions shall apply to Provider to the extent that Provider is considered a “Business Associate” under the HIPAA Privacy Rule and all references in this section to Business Associates shall refer to Provider. Capitalized terms not otherwise defined herein shall have the meaning assigned in the Agreement. Notwithstanding anything else to the contrary in the Agreement, in the event of a conflict between this Addendum and the Agreement, the terms of this Addendum shall prevail.

### II. Permitted Uses and Disclosures.

A. Business Associate agrees to use or disclose Protected Health Information (“PHI”) that it creates for or receives from Recipient or its Subsidiaries only as follows. The capitalized term “Protected Health Information or PHI” has the meaning set forth in 45 Code of Federal Regulations Section 164.501, as amended from time to time. Generally, this term means individually identifiable health information including, without limitation, all information, data and materials, including without limitation, demographic, medical and financial information, that relates to the past, present, or future physical or mental health or condition of an individual; the provision of health care to an individual; or the past present, or future payment for the provision of health care to an individual; and that identifies the individual or with respect to which there is a reasonable basis to believe the information can be used to identify the individual. This definition shall include any demographic information concerning members and participants in, and applicants for, Recipient’s or its Subsidiaries’ health benefit plans. All other terms used in this Addendum shall have the meanings set forth in the applicable definitions under the HIPAA Privacy Rule.

B. Functions and Activities on Company’s Behalf. Business Associate is permitted to use and disclose PHI it creates for or receives from Recipient or its Subsidiaries only for the purposes described in this Addendum or the Agreement that are not inconsistent with the provisions of this Addendum, or as required by law, or following receipt of prior written approval from whichever of the Recipient or its Subsidiary for which the relevant PHI was created or from which the relevant PHI was received. In addition to these specific requirements below, Business Associate may use or disclose PHI only in a manner that would not violate the HIPAA Privacy Rule if done by the Recipient or its Subsidiaries.

C. Business Associate’s Operations. Business Associate is permitted by this Agreement to use PHI it creates for or receives from Recipient or its Subsidiaries: (i) if such use is reasonably necessary for Business Associate’s proper management and administration; and (ii) as reasonably necessary to carry out Business Associate’s legal responsibilities. Business

---

Associate is permitted to disclose PHI it creates for or receives from Recipient or its Subsidiaries for the purposes identified in this Section only if the following conditions are met:

- (1) The disclosure is required by law; or
- (2) The disclosure is reasonably necessary to Business Associate’s proper management and administration, and Business Associate obtains reasonable assurances in writing from any person or organization to which Business Associate will disclose such PHI that the person or organization will:
  - a. Hold such PHI as confidential and use or further disclose it only for the purpose for which Business Associate disclosed it to the person or organization or as required by law; and
  - b. Notify Business Associate (who will in turn promptly notify whichever of the Recipient or its Subsidiary for which the relevant PHI was created or from which the relevant PHI was received) of any instance of which the person or organization becomes aware in which the confidentiality of such PHI was breached.

D. Minimum Necessary Standard. In performing the functions and activities on Recipient’s or its Subsidiaries’ behalf pursuant to the Agreement, Business Associate agrees to use, disclose or request only the minimum necessary PHI to accomplish the purpose of the use, disclosure or request. Business Associate must have in place policies and procedures that limit the PHI disclosed to meet this minimum necessary standard.

E. Prohibition on Unauthorized Use or Disclosure. Business Associate will neither use nor disclose PHI it creates or receives for or from Recipient, its Subsidiaries, or from another business associate of Recipient or its Subsidiaries, except as permitted or required by this Addendum or the Agreement that are not inconsistent with the provisions of this Addendum, or as required by law, or following receipt of prior written approval from whichever of the Recipient or its Subsidiary for which the relevant PHI was created or from which the relevant PHI was received.

F. De-identification of Information. Business Associate agrees neither to de-identify PHI it creates for or receives from Recipient or its Subsidiaries or from another business associate of Recipient or its Subsidiaries, nor use or disclose such de-identified PHI, unless such de-identification is expressly permitted under the terms and conditions of this Addendum or the Agreement and related to Recipient’s or its Subsidiaries’ activities for purposes of “treatment”, “payment” or “health care operations”, as those terms are defined under the HIPAA Privacy Rule. De-identification of PHI, other than as expressly permitted under the terms and conditions of the Addendum for Business Associate to perform services for Recipient or its Subsidiaries, is not a permitted use of PHI under this Addendum. Business Associate further agrees that it will not create a “Limited Data Set” as defined by the HIPAA Privacy Rule using PHI it creates or receives, or receives from another business associate of Recipient or its Subsidiaries, nor use or disclose such Limited Data Set unless: (i) such creation, use or disclosure is expressly permitted under the terms and conditions of this Addendum or the Agreement that are not inconsistent with

---

the provisions of this Addendum; and such creation, use or disclosure is for services provided by Business Associate that relate to Recipient’s or its Subsidiaries’ activities for purposes of “treatment”, “payment” or “health care operations”, as those terms are defined under the HIPAA Privacy Rule.

G. Information Safeguards. Business Associate will develop, document, implement, maintain and use appropriate administrative, technical and physical safeguards to preserve the integrity and confidentiality of and to prevent non-permitted use or disclosure of PHI created for or received from Recipient or its Subsidiaries. These safeguards must be appropriate to the size and complexity of Business Associate’s operations and the nature and scope of its activities. Business Associate agrees that these safeguards will meet any applicable requirements set forth by the U.S. Department of Health and Human Services, including (as of the effective date or as of the compliance date, whichever is applicable) any requirements set forth in the final HIPAA security regulations. Business Associate agrees to mitigate, to the extent practicable,

any harmful effect that is known to Business Associate resulting from a use or disclosure of PHI by Business Associate in violation of the requirements of this Addendum.

III. Conducting Standard Transactions. In the course of performing services for Recipient or its Subsidiaries, to the extent that Business Associate will conduct Standard Transactions for or on behalf of Recipient or its Subsidiaries, Business Associate will comply, and will require any subcontractor or agent involved with the conduct of such Standard Transactions to comply, with each applicable requirement of 45 C.F.R. Part 162. "Standard Transaction(s)" shall mean a transaction that complies with the standards set forth at 45 C.F.R. parts 160 and 162. Further, Business Associate will not enter into, or permit its subcontractors or agents to enter into, any trading partner agreement in connection with the conduct of Standard Transactions for or on behalf of the Recipient or its Subsidiaries that:

- a. Changes the definition, data condition, or use of a data element or segment in a Standard Transaction;
- b. Adds any data element or segment to the maximum defined data set;
- c. Uses any code or data element that is marked "not used" in the Standard Transaction's implementation specification or is not in the Standard Transaction's implementation specification; or
- d. Changes the meaning or intent of the Standard Transaction's implementation specification.

IV. Sub-Contractors, Agents or Other Representatives. Business Associate will require any of its subcontractors, agents or other representatives to which Business Associate is permitted by this Addendum or the Agreement (or is otherwise given Recipient's or the relevant Subsidiary's prior written approval) to disclose any of the PHI Business Associate creates or receives for or from Recipient or its Subsidiaries, to provide reasonable assurances in writing that subcontractor or agent will comply with the same restrictions and conditions that apply to the Business Associate under the terms and conditions of this Addendum with respect to such PHI.

3

---

V. Protected Health Information Access, Amendment and Disclosure Accounting.

A. Access. Business Associate will promptly upon Recipient's or its Subsidiary's request make available to Recipient, its Subsidiary, or, at Recipient's or such Subsidiary's direction, to the individual (or the individual's personal representative) for inspection and obtaining copies any PHI about the individual which Business Associate created for or received from Recipient or its Subsidiary and that is in Business Associate's custody or control, so that Recipient or its Subsidiary may meet its access obligations under 45 Code of Federal Regulations § 164.524.

B. Amendment. Upon Recipient's or its Subsidiary's request Business Associate will promptly amend or permit Recipient or its Subsidiary access to amend any portion of the PHI which Business Associate created for or received from Recipient or its Subsidiary, and incorporate any amendments to such PHI, so that Recipient or its Subsidiary may meet its amendment obligations under 45 Code of Federal Regulations § 164.526.

C. Disclosure Accounting. So that Recipient or its Subsidiaries may meet their disclosure accounting obligations under 45 Code of Federal Regulations § 164.528:

1. Disclosure Tracking. Business Associate will record for each disclosure, not excepted from disclosure accounting under Section V.C.2 below, that Business Associate makes to Recipient or its Subsidiaries of PHI that Business Associate creates for or receives from Recipient or its Subsidiaries, (i) the disclosure date, (ii) the name and member or other policy identification number of the person about whom the disclosure is made, (iii) the name and (if known) address of the person or entity to whom Business Associate made the disclosure, (iv) a brief description of the PHI disclosed, and (v) a brief statement of the purpose of the disclosure (items i-v, collectively, the "disclosure information"). For repetitive disclosures Business Associate makes to the same person or entity (including Recipient or its Subsidiaries) for a single purpose, Business Associate may provide a) the disclosure information for the first of these repetitive disclosures, (b) the frequency, periodicity or number of these repetitive disclosures and (c) the date of the last of these repetitive disclosures. Business Associate will make this disclosure information available to Recipient or its Subsidiaries promptly upon Recipient's or its Subsidiaries' request.

2. Exceptions from Disclosure Tracking. Business Associate need not record disclosure information or otherwise account for disclosures of PHI that this Addendum or Recipient or the relevant Subsidiary in writing permits or requires (i) for the purpose of Recipient's or its Subsidiaries' treatment activities, payment activities, or health care operations, (ii) to the individual who is the subject of the PHI disclosed or to that individual's personal representative; (iii) to persons involved in that individual's health care or payment for health care; (iv) for notification for disaster relief purposes, (v) for national security or intelligence purposes, (vi) to law enforcement officials or correctional institutions regarding inmates; or (vii) pursuant to an authorization; (viii) for disclosures of certain PHI made as part of a Limited Data Set; (ix) for certain incidental disclosures that may occur where reasonable safeguards have been implemented; and (x) for disclosures prior to April 14, 2003.

4

---

3. Disclosure Tracking Time Periods. Business Associate must have available for Recipient and its Subsidiaries the disclosure information required by this section for the 6 years preceding Recipient's or its Subsidiaries' request for the disclosure information (except Business Associate need have no disclosure information for disclosures occurring before April 14, 2003).

VI. Additional Business Associate Provisions

A. Reporting of Breach of Privacy Obligations. Business Associate will provide written notice to whichever of the Recipient or its Subsidiary for which the relevant PHI was created or from which the relevant PHI was received of any use or disclosure of PHI that is neither permitted by this Addendum nor given prior written approval by Recipient or the relevant Subsidiary promptly after Business Associate learns of such non-permitted use or disclosure. Business Associate's report will at least:

- (i) Identify the nature of the non-permitted use or disclosure;
- (ii) Identify the PHI used or disclosed;
- (iii) Identify who made the non-permitted use or received the non-permitted disclosure;
- (iv) Identify what corrective action Business Associate took or will take to prevent further non-permitted uses or disclosures;
- (v) Identify what Business Associate did or will do to mitigate any deleterious effect of the non-permitted use or disclosure; and
- (vi) Provide such other information, including a written report, as Recipient or the relevant Subsidiary may reasonably request.

B. Amendment. Upon the effective date of any final regulation or amendment to final regulations promulgated by the U.S. Department of Health and Human Services with respect to PHI, including, but not limited to the HIPAA privacy and security regulations, this Addendum and the Agreement will automatically be amended so that the obligations they impose on Business Associate remain in compliance with these regulations.

In addition, to the extent that new state or federal law requires changes to Business Associate's obligations under this Addendum, this Addendum shall automatically be amended to include such additional obligations, upon notice by Recipient or its Subsidiaries to Business Associate of such obligations. Business Associate's continued performance of services under the Agreement shall be deemed acceptance of these additional obligations.

C. Audit and Review of Policies and Procedures. Business Associate agrees to provide, upon Recipient request, access to and copies of any policies and procedures developed or utilized by Business Associate regarding the protection of PHI. Business Associate agrees to provide, upon Recipient's request, access to Business Associate's internal practices, books, and records, as they relate to Business Associate's services, duties and obligations set forth in this Addendum and the Agreement(s) under which Business Associate provides services and / or

products to or on behalf of Recipient or its Subsidiaries, for purposes of Recipient's or its Subsidiaries' review of such internal practices, books, and records.



SCHEDULE C

CEDING COMMISSION

The Ceding Commission shall be the sum of the following:

1. an amount equal to the excess of the Total SAP Ceded Reserves over Total GAAP Ceded Reserves measured as of the close of business on the day immediately preceding the Inception Date (which amount may be negative);
2. an amount equal to the unamortized PVFP intangible asset balance of the Company with respect to the Reinsured Policies as measured as of the close of business on the day immediately preceding the Inception Date, determined in accordance with GAAP;
3. an amount equal to the unamortized deferred acquisition costs of the Company with respect to the Reinsured Policies as measured as of the close of business on the day immediately preceding the Inception Date, determined in accordance with GAAP;
4. an amount equal to the balance of the Loss Carry Forward Amount as of the close of business on the day immediately preceding the Inception Date, determined in accordance with GAAP; and
5. an amount equal to the excess of the GAAP book value of the Assets (excluding any related mark to market adjustments for SFAS 115 requirement) over the SAP book value of the Assets measured as of the close of business on the day immediately preceding the Inception Date (which amount may be negative).

SCHEDULE D

ASSETS

Transfer Document		From		To		Nature of Transfer		Cash Map Cross-Reference		Schedule	
GECALTC Retrocession		GECA		UFLIC		Treaty		(91)		Schedule D	
Called Securities*	Parent Name	Issuer Name	1Q04 Cusip	1Q04 Tax lot	12/31/03 Local Par	12/31/03 GAAP BV (incl attached derivative)	12/31/03 Accrued Interest	12/31/03 GAAP BV + Accrued Interest	12/31/03 STAT BV (incl attached derivative)	12/31/03 Account Interest	12/31/03 STAT BV + Interest
[Individual Asset Details Omitted]											
<b>Asset Sub Total</b>						<b>763,710,320.40</b>	<b>8,850,410.11</b>	<b>772,560,730.51</b>	<b>763,264,319.36</b>	<b>8,850,410.11</b>	<b>772,114,729.47</b>
Cash									313,250.88		313,250.68
<b>Total</b>									<b>763,577,570.04</b>		<b>772,427,980.15</b>

\* These Securities will not be transferred. The "Call Amount" will be settled in cash.

SCHEDULE E

EXPENSE ALLOWANCES

The "Annual Expense Reimbursement Factors" used to calculate the Expense Allowance are as follows:

Policy Maintenance Factor	\$7.12 per Policy
Claims Factor	\$876.00 per Open and Pending Claim
Travelers Agreement Maintenance Factor	\$45.24 per Policy

Such Annual Expense Reimbursement Factors will be adjusted (i) for the year beginning January 1, 2005 and, thereafter, every three (3) years during the term of this Agreement based on a triennial cost/time study prepared in accordance with the methodology set forth below (the "Triennial Study") and (ii) for the years between the Triennial Studies based on a report setting forth the Annual Expense Reimbursement Factors prepared in accordance with the methodology set forth below (the "Annual Expense Reimbursement Factor Report").

(a) Triennial Study. As soon as practicable (and in any event within sixty (60) days) prior to January 1, 2005 and prior to the beginning of every third calendar year thereafter during the term of this Agreement, the Company shall cause to be prepared and delivered to the Reinsurer the Triennial Study which sets forth the Annual Expense Reimbursement Factors for the next calendar year, together with all supporting data used in preparing the Triennial Study and work papers, in reasonable detail, setting forth the determination of such Annual Expense Reimbursement Factors based on such Triennial Study (such documents, together with the Triennial Study, the "Triennial Study Documents").

(b) Annual Expense Reimbursement Factor Report. As soon as practicable (and in any event within thirty (30) days) prior to January 1, 2006 and prior to the beginning of each calendar year thereafter in which no Triennial Study is prepared, the Company shall cause to be prepared and delivered to the Reinsurer the Annual Expense Reimbursement Factor Report, together with all supporting data used in preparing the Annual Expense Reimbursement Factor Report and work papers, in reasonable detail, setting forth the determination of such Annual Expense Reimbursement Factors for the next calendar year (such documents, together with the Annual Expense Reimbursement Factor Report, the "Annual Expense Reimbursement Factor Documents").

(c) Methodology. At the time of the Triennial Study, historical costs (to include costs (excluding costs identified as "Allocated Loss Adjustment Expenses") directly related to maintaining and administering policies, processing claims and reporting results, including, without limitation, for Business Overhead Services set forth on Schedule E-1 hereto) will be determined for the Policy Maintenance Factor, the Claims Factor and the Travelers Agreement Maintenance Factor identified above. For a given Annual Expense Reimbursement Factor the identified costs will be divided by the total historical number of units of measure for both the Reinsured Policies and the retained block of business to derive an historical cost per unit. The historical cost per unit will be used as a prospective cost per unit for the next calendar year.

For the two succeeding years in the period between the Triennial Studies the historical dollar amounts by Policy Maintenance Factor, Claims Factor and Travelers Agreement Maintenance Factor will be adjusted (rolled forward) for current year cost changes agreed to by the Reinsurer and the Company (in

accordance with the procedures set forth below). This rolled forward historical cost will then be divided by the total historical number of units for the current period to determine a prospective cost per unit for the next calendar year.

An additional adjustment, positive or negative, to the prospective cost per unit determined by either the Triennial Study or the two succeeding years may be negotiated between the parties. The additional adjustment is for special projected costs or benefits of productivity, process improvements, inflation, loss of scale, and any other cost variation which was not included in the prior Triennial Study or the succeeding roll forward.

The combined prospective unit cost and additional adjustment is the Annual Expense Reimbursement Factor. The Expense Allowance will be determined quarterly and billed to the Reinsurer in three equal installments during the quarter at the end of the month. Each installment of the monthly amount billed will be determined by multiplying the actual number of units at the beginning of the quarter covered by this Agreement times the Annual Expense Reimbursement Factor (divided by twelve).

(d) Review of Documents. Following the delivery of the Annual Expense Reimbursement Factor Documents or the Triennial Study Documents, as applicable, the Company shall (i) provide to the Reinsurer or its designated representative copies of such additional work papers and other documents relating to its preparation of the Annual Expense Reimbursement Factor Report or Triennial Study, as applicable, as the Reinsurer or its designated representative may reasonably request, including, without limitation, claims files and practices and (ii) cooperate with, and make its personnel and facilities reasonably available to, the Reinsurer and the Reinsurer's designated representative for the purpose of providing such other information as the Reinsurer or the Reinsurer's designated representative may reasonably request concerning Annual Expense Reimbursement Factor Documents or the Triennial Study Documents, as applicable, and the calculation of the Annual Expense Reimbursement Factors.

(e) Notice of Disagreement. In the event that the Reinsurer has any disagreement with any of the Annual Expense Reimbursement Factor Documents or the Triennial Study Documents, as applicable, the Reinsurer shall give written notice of all such disagreements (a "Notice of Disagreement") to the Company within thirty (30) days after the Annual Expense Reimbursement Factor Documents or the Triennial Study Documents, as applicable, are delivered to the Reinsurer. Any Notice of Disagreement shall set forth each item in disagreement and shall provide reasonable specificity as to the basis for each disagreement and shall specify the total adjustment to the Annual Expense Reimbursement Factors as proposed by the Company as a result of such items in disagreement.

(f) Dispute Resolution. If the Reinsurer does not deliver a Notice of Disagreement to the Company within such thirty (30) day period, the Annual Expense Reimbursement Factor Documents and the Triennial Study Documents, as applicable, shall be final and binding upon the parties hereto and shall constitute the final calculation of the Annual Expense Reimbursement Factor for the next calendar year. If the Reinsurer delivers a Notice of

---

Disagreement to the Company within such thirty (30) day period, the parties shall (and shall cause their respective designated representatives to) negotiate in good faith to resolve all disagreements as promptly as practicable. Any changes in the Annual Expense Reimbursement Factors, if any, that are agreed to by the Company and the Reinsurer within sixty (60) days of the aforementioned delivery of the Annual Expense Reimbursement Factor Documents or the Triennial Study Documents, as applicable, shall be incorporated into a final calculation of the Annual Expense Reimbursement Factors. If the parties and their respective designated representatives are unable to resolve all disagreements within sixty (60) days of delivery of the Annual Expense Reimbursement Factor Documents or the Triennial Study Documents, as applicable, then all unresolved disagreements will be submitted within ten (10) days after the end of such sixty (60) day period for resolution in accordance herewith to an independent certified public accounting firm of national standing and reputation (the "Accounting Firm") mutually acceptable to the Company and the Reinsurer. The parties shall cooperate in good faith with the Accounting Firm and shall give the Accounting Firm access to all data and other information requested by the Accounting Firm for purposes of such resolution. The Accounting Firm shall, within thirty (30) days after its engagement, deliver to the Company and the Reinsurer a definitive calculation of the Annual Expense Reimbursement Factors, which shall be final and binding upon the parties hereto and shall be so reflected in the calculation of the Annual Expense Reimbursement Factors. The Company and the Reinsurer shall each pay one-half of the fees and expenses of the Accounting Firm.

(g) Expense Allowance Pending Resolution. In the event of a dispute with respect to any Annual Expense Reimbursement Factors for the next succeeding Calendar year, the Company and the Reinsurer agree that the Annual Expense Reimbursement Factors then in effect under this Agreement shall remain in effect pending resolution of such dispute and adjustment, if any, in accordance with the dispute resolution procedure set forth in paragraph (f) above.

---

## SCHEDULE E-1

### BUSINESS OVERHEAD SERVICES

#### Business Overhead Services

The "Business Overhead Services" are broadly defined as activities performed by the "LTC" business unit of GNA Corporation ("GNA") and its subsidiaries and Affiliates that benefit the business reinsured under this Agreement. GNA will provide, as a subcontractor, the Business Overhead Services, which will include, without limitation, the services described below.

#### Executive:

General support, counsel, strategy and leadership provided by LTC's Chief Executive Officer including managing existing business relationship with Travelers.

#### Human Resources:

General business level Human Resource related activities including but not limited to leadership development, employee recruitment and staffing, implementation of compensation policies and practices, payroll and benefit administration, organizational communication, training, general security and employee issue resolution and guidance.

#### Finance:

Cost of finance activities including but not limited to product financial support and analysis, account reconciliations, state reporting, product profitability analysis, investment income planning & analysis, expense management, audit support, statutory & GAAP accounting, reporting & analysis and ad hoc financial analysis. Finance supports the existing reinsurance treaty and all related filings.

#### Legal/Compliance:

Cost of support and coordination of litigation, government relations, human resource, intellectual property, insurance regulatory, consumer privacy, contract, compliance, and public relations matters. Additional relationships with the DOI and with Travelers are managed within this group.

#### Risk:

Cost of Risk Management and reinsurance support---Monitor production vs. authority limits, monitor and review key risk measures. General oversight of inforce product performance analysis and reviews. Reinsurance oversight and treaty management including settlement with reinsurers. Reserve analysis and general risk management.

#### Sourcing / Facilities:

Campus expenses including building rent and maintenance, parking garage, cafeteria, campus lawn care and utilities. Procurement of necessary business software, supplies, EDP.

---

Information Technology:

General business technology infrastructure costs including but not limited to general management, help desk assistance, data center management, disaster recovery plans and digitization of processes.

Six Sigma Quality:

Costs including business project management and process improvement coaching, execution and leadership.

Actuarial:

Sets Reserving Levels, Provides analysis on in-force blocks, evaluates product risk analysis, forecasting and planning for future periods. Manages reinsurance analysis.

eQuTOps:

Project budget associated to large scale projects that impact the business via digitization, streamlining of processes, system enhancements or regulatory mandated projects (e.g., HIPAA).

Product Management:

Costs for product line managers to manage inforce policies and general product line maintenance activities such as risk assessment, return on equity ("ROE") variance analysis and related ROE improvement projects.

Operations:

Costs including management, project leadership and administrative support for service operations supporting customers, policyholders, claims delivery and other stakeholders.

Other:

Costs including corporate insurance allocation to product lines (e.g., cost of building insurance and other property, plant and equipment).

Retention:

Costs including monitoring of inforce policy retention levels, design and execute programs to retain inforce business.

Changes in Services

The Business Overhead Services shall include such other comparable and/or successor services implemented or maintained from time to time by GNA and its subsidiaries and Affiliates.

SCHEDULE F - PART I

INITIAL REPORT

1. Total SAP Ceded Reserves:		
A. Active Life Reserves	\$	
B. Claim Reserves	\$	
C. Unearned Premium Reserves	\$	
D. Advanced Premium	\$	
E. Less: Due and Unpaid Premium	\$	
Total SAP Ceded Reserves (A+B+C+D-E)		\$
2. Ceding Commission:		
A. Excess SAP Ceded Reserves over GAAP Ceded Reserves:		
1) Total SAP Ceded Reserves	\$	
2) Total GAAP Ceded Reserves:		
a. Active Life Reserves	\$	
b. Maintenance Reserves	\$	
c. Loss Expense Reserves	\$	
d. Claim Reserves	\$	
e. Unearned Premium Reserves	\$	
f. Advanced Premium	\$	
g. Less: Due and Unpaid Premium	\$	
Total GAAP Ceded Reserves (a+b+c+d+e+f-g)	\$	
Excess SAP Reserves over GAAP Reserves (A1-A2)		\$
B. Present Value of Future Profits (PVFP)		\$
C. Deferred Acquisition Costs (DAC)		\$
D. Loss Carry Forward Amount (Stop Loss Balance)		\$
E. Asset Book Value Difference		
1) Asset Book Value (GAAP basis)	\$	
2) Asset Book Value (SAP basis)	\$	
Excess Asset Book Value (E1-E2)		\$
Total Ceding Commission (A+B+C+D+E)		\$
3. Accrued Interest on Assets as of the day before Inception Date		
		\$
4. Investment Cash Flows on the Assets from the Inception Date through the Closing Date		
		\$
Net Due Reinsurer (1-2-3+4)		\$

SCHEDULE F - PART II

MONTHLY SETTLEMENT REPORT

1. Additional Premium Due:

A. Premiums Received:		\$	
1. Direct Premium Collected on Reinsured Policies		\$	
2. Additional Reinsurance Premium Collected from Travelers		\$	
3. Less: Premiums Paid to Travelers on retained business		\$	
Total Premiums Received (A1+A2-A3)			\$
B. 12/31/03 Due and Unpaid Premium Receivable Collected			\$
C. Stop Loss Payments Received from Travelers			\$
Total Additional Premium Due (A+B+C)			\$
2. Ultimate Net Loss Paid:			
A. Losses (Claims Incurred)			
1. Direct Losses Incurred		\$	
2. Less: Losses Reimbursed by Travelers on retained business		\$	
Total Losses (Claims Incurred) (A1+A2)			\$
B. Stop Loss Payments to Travelers		\$	
C. Allocated Loss Adjustment Expense		\$	
D. Premium Taxes Due		\$	
E. Insolvency Fund Assessments, net		\$	
F. Returns or Refunds of Premiums		\$	
G. Commissions Paid		\$	
H. Unclaimed Property Liabilities		\$	
Total Ultimate Net Loss Paid (A+B+C+D+E+F+G+H)			\$
3. Withdrawals from Claims Settlement Account			\$
4. Expense Allowance:		\$	
A. Policy Maintenance		\$	
B. Claims		\$	
C. Traveler's Agreement Maintenance		\$	
Total Expense Commission (A+B+C)			\$
5. Additional Expenses:			
A. Novation Costs Incurred (pursuant to Section 2.6)		\$	
B. Re-rating costs incurred (pursuant to Section 3.3)		\$	
Total Additional Expense (A+B)			\$
6. Additional Ceding Commission Paid to Travelers			\$
Net Due Reinsurer (1-2+3-4-5-6)			\$

SCHEDULE F - PART III

QUARTERLY SETTLEMENT REPORT

1. Additional Premium Due:			
A. Premiums Received:			
1. Direct Premium Collected on Reinsured Policies		\$	
2. Additional Reinsurance Premium Collected from Travelers		\$	
3. Less: Premiums Paid to Travelers on retained business		\$	
Total Premiums Received (A1+A2-A3)			\$
B. 12/31/03 Due and Unpaid Premium Receivable Collected			\$
C. Stop Loss Payments Received from Travelers			\$
Total Additional Premium Due (A+B+C)			\$
2. Ultimate Net Loss Paid:			
A. Losses (Claims Incurred)			
1. Direct Losses Incurred		\$	
2. Less: Losses Reimbursed by Travelers on retained business		\$	
Total Losses (Claims Incurred) (A1+A2)			\$
B. Stop Loss Payments to Travelers		\$	
C. Allocated Loss Adjustment Expense		\$	
D. Premium Taxes Due		\$	
E. Insolvency Fund Assessments, net		\$	
F. Returns or Refunds of Premiums		\$	
G. Commissions Paid		\$	
H. Unclaimed Property Liabilities		\$	
Total Ultimate Net Loss Paid (A+B+C+D+E+F+G+H)			\$
3. Withdrawals from Claims Settlement Account			\$
4. Expense Allowance:			
A. Policy Maintenance		\$	
B. Claims		\$	
C. Traveler's Agreement Maintenance		\$	
Total Expense Commission (A+B+C)			\$
5. Additional Expenses:			
A. Novation Costs Incurred (pursuant to Section 2.6)		\$	

B. Re-rating costs incurred (pursuant to Section 3.3)	\$	
Total Additional Expense (A+B)		\$
6. Additional Ceding Commission Paid to Travelers		\$
I. Quarterly Settlement Amount (1-2+3-4-5-6)		\$
II. Sum of Monthly Settlements for Quarter Ended		\$
Net Due to (from) Reinsurer (I-II)		\$

SCHEDULE F - PART IV

ANNUAL REPORT

1. Additional Premium Due:		
A. Premiums Received:		
1. Direct Premium Collected on Reinsured Policies	\$	
2. Additional Reinsurance Premium Collected from Travelers	\$	
3. Less: Premiums Paid to Travelers on retained business	\$	
Total Premiums Received (A1+A2-A3)		\$
B. 12/31/03 Due and Unpaid Premium Receivable Collected		\$
C. Stop Loss Payments Received from Travelers		\$
Total Additional Premium Due (A+B+C)		\$
2. Ultimate Net Loss Paid:		
A. Losses (Claims Incurred)		
1. Direct Losses Incurred	\$	
2. Less: Losses Reimbursed by Travelers on retained business	\$	
Total Losses (Claims Incurred) (A1+A2)		\$
B. Stop Loss Payments to Travelers	\$	
C. Allocated Loss Adjustment Expense	\$	
D. Premium Taxes Due	\$	
E. Insolvency Fund Assessments, net	\$	
F. Returns or Refunds of Premiums	\$	
G. Commissions Paid	\$	
H. Unclaimed Property Liabilities	\$	
Total Ultimate Net Loss Paid (A+B+C+D+E+F+G+H)		\$
3. Withdrawals from Claims Settlement Account		\$
4. Expense Allowance:		
A. Policy Maintenance	\$	
B. Claims	\$	
C. Traveler's Agreement Maintenance	\$	
Total Expense Commission (A+B+C)		\$
5. Additional Expenses:		
A. Novation Costs Incurred (pursuant to Section 2.6)	\$	
B. Re-rating costs incurred (pursuant to Section 3.3)	\$	
Total Additional Expense (A+B)		\$
6. Additional Ceding Commission Paid to Travelers		\$
7. Experience Refund Amounts Due to the Company Under Article VIII		\$
I. Annual Settlement Amount (1-2+3-4-5-6-7)		\$
II. Sum of Monthly Settlements for Calendar Year		\$
Net Due to (from) Reinsurer (I-II)		\$

SCHEDULE G

FORM OF TRUST AGREEMENT

SCHEDULE H

ELIGIBLE SECURITIES

SCHEDULE I

EXPERIENCE REFUND<sup>1</sup>

Scenario I—Base Case	Net Yield	6.19%	6.08%	6.02%	5.93%	5.90%	5.87%	5.85%	5.82%	5.81%	5.78%	5.74%	5.73%	5.71%	5.70%	5.70%
<b>Calculated By taking Investment Income Including IMR amort and dividing by a 2 point avg of the sum of Total Ceded SAP Reserves plus IMR</b>																
LTC Reinsurance Segment Proje	2004	2005	2006	2007	2008	2009	2010	2011	2012	2013	2014	2015	2016	2017	2018	
(in \$1,000's)																
Premium Income	149,771	155,435	148,086	140,612	133,047	125,438	117,799	110,067	102,297	94,545	86,865	79,311	71,937	64,794	57,924	
Investment Inc on LTC Rsvs (Net of Defaults & Inv Exp)	78,304	87,570	96,510	104,068	111,669	118,543	124,737	130,152	135,233	139,341	142,454	145,636	147,692	149,124	150,135	
IMR Amortization for LTC Segment	467	469	475	481	481	494	475	453	438	415	407	397	378	356	327	
<b>TOTAL REVENUE:</b>	<b>228,542</b>	<b>243,474</b>	<b>245,071</b>	<b>245,161</b>	<b>245,197</b>	<b>244,475</b>	<b>243,011</b>	<b>240,672</b>	<b>237,967</b>	<b>234,301</b>	<b>229,726</b>	<b>225,344</b>	<b>220,008</b>	<b>214,274</b>	<b>208,386</b>	
Paid Benefits	69,640	82,274	89,969	96,614	102,100	106,392	109,895	114,025	118,659	123,617	128,753	133,935	138,995	143,805	148,266	
Increase in Active Life Reserves	140,189	134,678	127,692	119,882	111,585	102,794	93,175	82,739	71,708	60,167	48,189	35,724	23,161	10,784	(1,502)	
Increase in Claim Reserves (incl IBNR)	32,842	27,722	24,569	21,217	17,519	13,705	11,187	13,184	14,799	15,833	16,399	16,546	16,157	15,360	14,245	
Loss Exp (Incl Rsv Change & LAE)	1,624	1,594	1,575	1,540	1,484	1,413	1,372	1,470	1,561	1,639	1,704	1,758	1,795	1,817	1,827	
Expense Allowances - Commissions	18,754	19,382	18,556	17,706	16,834	15,947	15,051	14,149	13,248	12,354	11,471	10,604	9,760	8,942	8,155	
Expense Allowances - Treaty (Claims Dept, PHS, Blue Sky)	9,365	7,877	7,956	7,993	7,987	8,002	7,982	7,975	7,976	7,981	7,986	7,986	7,979	7,960	7,927	
Expense Allowances - BSA Expenses (COH)	3,390	3,230	3,118	3,003	2,884	2,762	2,638	2,512	2,384	2,255	2,126	1,998	1,870	1,743	1,619	
Stop-loss & 10% Novation Costs	4,438	2,817	1,894	838	25,023											
Impairments - 15bps	2,064	2,368	2,647	2,905	3,140	3,349	3,530	3,684	3,829	3,939	4,036	4,111	4,158	4,186	4,192	
<b>TOTAL EXPENSES:</b>	<b>282,307</b>	<b>281,942</b>	<b>277,976</b>	<b>271,697</b>	<b>288,555</b>	<b>254,364</b>	<b>244,830</b>	<b>239,738</b>	<b>234,165</b>	<b>227,786</b>	<b>220,665</b>	<b>212,662</b>	<b>203,874</b>	<b>194,597</b>	<b>184,729</b>	
<b>Pre-Tax Income 90% TLA</b>	<b>(53,765)</b>	<b>(38,469)</b>	<b>(32,905)</b>	<b>(26,536)</b>	<b>(43,358)</b>	<b>(9,889)</b>	<b>(1,820)</b>	<b>934</b>	<b>3,802</b>	<b>6,516</b>	<b>9,061</b>	<b>12,682</b>	<b>16,135</b>	<b>19,677</b>	<b>23,658</b>	
<b>10% Novation Segment Pre-Tax Profits</b>	<b>—</b>	<b>—</b>	<b>—</b>	<b>—</b>	<b>—</b>	<b>(1,099)</b>	<b>(202)</b>	<b>104</b>	<b>422</b>	<b>724</b>	<b>1,007</b>	<b>1,409</b>	<b>1,793</b>	<b>2,186</b>	<b>2,629</b>	
<b>Pre-Tax Income = Experience Refund Baseline</b>	<b>(53,765)</b>	<b>(38,469)</b>	<b>(32,905)</b>	<b>(26,536)</b>	<b>(43,358)</b>	<b>(10,988)</b>	<b>(2,022)</b>	<b>1,038</b>	<b>4,225</b>	<b>7,240</b>	<b>10,068</b>	<b>14,091</b>	<b>17,927</b>	<b>21,863</b>	<b>26,286</b>	

<sup>1</sup> In recognition of the limited amount of time available to the Reinsurer to verify the accuracy of the calculation of the Experience Refund Baseline and the recent availability of 2003 experience on the Reinsured Policies, the parties to this Agreement agree to update the values set forth in the Experience Refund Baseline on this Schedule I, at any time on or before June 30, 2004, (a) to correct material errors or omissions in the models and workbooks used to derive the Experience Refund Baseline and (b) to reflect adjustments to projected rate increase filings resulting from further analysis of 2003 experience on the Reinsured Policies.

BUSINESS ASSOCIATE ADDENDUM

I. Purpose.

In order to disclose certain information to the party providing a service under this Agreement (“Provider”) under this Addendum, some of which may constitute Protected Health Information (defined below), the party to whom a service under this Agreement is being provided (“Recipient”) and Provider mutually agree to comply with the terms of this Addendum for the purpose of satisfying the requirements of the Health Insurance Portability and Accountability Act of 1996 (“HIPAA”) and its implementing privacy regulations at 45 C.F.R. Parts 160-164 (“HIPAA Privacy Rule”). These provisions shall apply to Provider to the extent that Provider is considered a “Business Associate” under the HIPAA Privacy Rule and all references in this section to Business Associates shall refer to Provider. Capitalized terms not otherwise defined herein shall have the meaning assigned in the Agreement. Notwithstanding anything else to the contrary in the Agreement, in the event of a conflict between this Addendum and the Agreement, the terms of this Addendum shall prevail.

II. Permitted Uses and Disclosures.

A. Business Associate agrees to use or disclose Protected Health Information (“PHI”) that it creates for or receives from Recipient or its Subsidiaries only as follows. The capitalized term “Protected Health Information or PHI” has the meaning set forth in 45 Code of Federal Regulations Section 164.501, as amended from time to time. Generally, this term means individually identifiable health information including, without limitation, all information, data and materials, including without limitation, demographic, medical and financial information, that relates to the past, present, or future physical or mental health or condition of an individual; the provision of health care to an individual; or the past present, or future payment for the provision of health care to an individual; and that identifies the individual or with respect to which there is a reasonable basis to believe the information can be used to identify the individual. This definition shall include any demographic information concerning members and participants in, and applicants for, Recipient’s or its Subsidiaries’ health benefit plans. All other terms used in this Addendum shall have the meanings set forth in the applicable definitions under the HIPAA Privacy Rule.

B. Functions and Activities on Company’s Behalf. Business Associate is permitted to use and disclose PHI it creates for or receives from Recipient or its Subsidiaries only for the purposes described in this Addendum or the Agreement that are not inconsistent with the provisions of this Addendum, or as required by law, or following receipt of prior written approval from whichever of the Recipient or its Subsidiary for which the relevant PHI was created or from which the relevant PHI was received. In addition to these specific requirements below, Business Associate may use or disclose PHI only in a manner that would not violate the HIPAA Privacy Rule if done by the Recipient or its Subsidiaries.

C. Business Associate’s Operations. Business Associate is permitted by this Agreement to use PHI it creates for or receives from Recipient or its Subsidiaries: (i) if such use is reasonably necessary for Business Associate’s proper management and administration; and (ii) as reasonably necessary to carry out Business Associate’s legal responsibilities. Business

Associate is permitted to disclose PHI it creates for or receives from Recipient or its Subsidiaries for the purposes identified in this Section only if the following conditions are met:

- (1) The disclosure is required by law; or
- (2) The disclosure is reasonably necessary to Business Associate's proper management and administration, and Business Associate obtains reasonable assurances in writing from any person or organization to which Business Associate will disclose such PHI that the person or organization will:
  - a. Hold such PHI as confidential and use or further disclose it only for the purpose for which Business Associate disclosed it to the person or organization or as required by law; and
  - b. Notify Business Associate (who will in turn promptly notify whichever of the Recipient or its Subsidiary for which the relevant PHI was created or from which the relevant PHI was received) of any instance of which the person or organization becomes aware in which the confidentiality of such PHI was breached.

D. Minimum Necessary Standard. In performing the functions and activities on Recipient's or its Subsidiaries' behalf pursuant to the Agreement, Business Associate agrees to use, disclose or request only the minimum necessary PHI to accomplish the purpose of the use, disclosure or request. Business Associate must have in place policies and procedures that limit the PHI disclosed to meet this minimum necessary standard.

E. Prohibition on Unauthorized Use or Disclosure. Business Associate will neither use nor disclose PHI it creates or receives for or from Recipient, its Subsidiaries, or from another business associate of Recipient or its Subsidiaries, except as permitted or required by this Addendum or the Agreement that are not inconsistent with the provisions of this Addendum, or as required by law, or following receipt of prior written approval from whichever of the Recipient or its Subsidiary for which the relevant PHI was created or from which the relevant PHI was received.

F. De-identification of Information. Business Associate agrees neither to de-identify PHI it creates for or receives from Recipient or its Subsidiaries or from another business associate of Recipient or its Subsidiaries, nor use or disclose such de-identified PHI, unless such de-identification is expressly permitted under the terms and conditions of this Addendum or the Agreement and related to Recipient's or its Subsidiaries' activities for purposes of "treatment", "payment" or "health care operations", as those terms are defined under the HIPAA Privacy Rule. De-identification of PHI, other than as expressly permitted under the terms and conditions of the Addendum for Business Associate to perform services for Recipient or its Subsidiaries, is not a permitted use of PHI under this Addendum. Business Associate further agrees that it will not create a "Limited Data Set" as defined by the HIPAA Privacy Rule using PHI it creates or receives, or receives from another business associate of Recipient or its Subsidiaries, nor use or disclose such Limited Data Set unless: (i) such creation, use or disclosure is expressly permitted under the terms and conditions of this Addendum or the Agreement that are not inconsistent with the provisions of this Addendum; and such creation, use or disclosure is for services provided by

2

---

Business Associate that relate to Recipient's or its Subsidiaries' activities for purposes of "treatment", "payment" or "health care operations", as those terms are defined under the HIPAA Privacy Rule.

G. Information Safeguards. Business Associate will develop, document, implement, maintain and use appropriate administrative, technical and physical safeguards to preserve the integrity and confidentiality of and to prevent non-permitted use or disclosure of PHI created for or received from Recipient or its Subsidiaries. These safeguards must be appropriate to the size and complexity of Business Associate's operations and the nature and scope of its activities. Business Associate agrees that these safeguards will meet any applicable requirements set forth by the U.S. Department of Health and Human Services, including (as of the effective date or as of the compliance date, whichever is applicable) any requirements set forth in the final HIPAA security regulations. Business Associate agrees to mitigate, to the extent practicable, any harmful effect that is known to Business Associate resulting from a use or disclosure of PHI by Business Associate in violation of the requirements of this Addendum.

III. Conducting Standard Transactions. In the course of performing services for Recipient or its Subsidiaries, to the extent that Business Associate will conduct Standard Transactions for or on behalf of Recipient or its Subsidiaries, Business Associate will comply, and will require any subcontractor or agent involved with the conduct of such Standard Transactions to comply, with each applicable requirement of 45 C.F.R. Part 162. "Standard Transaction(s)" shall mean a transaction that complies with the standards set forth at 45 C.F.R. parts 160 and 162. Further, Business Associate will not enter into, or permit its subcontractors or agents to enter into, any trading partner agreement in connection with the conduct of Standard Transactions for or on behalf of the Recipient or its Subsidiaries that:

- a. Changes the definition, data condition, or use of a data element or segment in a Standard Transaction;
- b. Adds any data element or segment to the maximum defined data set;
- c. Uses any code or data element that is marked "not used" in the Standard Transaction's implementation specification or is not in the Standard Transaction's implementation specification; or
- d. Changes the meaning or intent of the Standard Transaction's implementation specification.

IV. Sub-Contractors, Agents or Other Representatives. Business Associate will require any of its subcontractors, agents or other representatives to which Business Associate is permitted by this Addendum or the Agreement (or is otherwise given Recipient's or the relevant Subsidiary's prior written approval) to disclose any of the PHI Business Associate creates or receives for or from Recipient or its Subsidiaries, to provide reasonable assurances in writing that subcontractor or agent will comply with the same restrictions and conditions that apply to the Business Associate under the terms and conditions of this Addendum with respect to such PHI.

3

---

V. Protected Health Information Access, Amendment and Disclosure Accounting.

A. Access. Business Associate will promptly upon Recipient's or its Subsidiary's request make available to Recipient, its Subsidiary, or, at Recipient's or such Subsidiary's direction, to the individual (or the individual's personal representative) for inspection and obtaining copies any PHI about the individual which Business Associate created for or received from Recipient or its Subsidiary and that is in Business Associate's custody or control, so that Recipient or its Subsidiary may meet its access obligations under 45 Code of Federal Regulations § 164.524.

B. Amendment. Upon Recipient's or its Subsidiary's request Business Associate will promptly amend or permit Recipient or its Subsidiary access to amend any portion of the PHI which Business Associate created for or received from Recipient or its Subsidiary, and incorporate any amendments to such PHI, so that Recipient or its Subsidiary may meet its amendment obligations under 45 Code of Federal Regulations § 164.526.

C. Disclosure Accounting. So that Recipient or its Subsidiaries may meet their disclosure accounting obligations under 45 Code of Federal Regulations § 164.528:

1. Disclosure Tracking. Business Associate will record for each disclosure, not excepted from disclosure accounting under Section V.C.2 below, that Business Associate makes to Recipient or its Subsidiaries of PHI that Business Associate creates for or receives from Recipient or its Subsidiaries, (i) the disclosure date, (ii) the name and member or other policy identification number of the person about whom the disclosure is made, (iii) the name and (if known) address of the person or entity to whom Business Associate made the disclosure, (iv) a brief description of the PHI disclosed, and (v) a brief statement of the purpose of the disclosure (items i-v, collectively, the “disclosure information”). For repetitive disclosures Business Associate makes to the same person or entity (including Recipient or its Subsidiaries) for a single purpose, Business Associate may provide a) the disclosure information for the first of these repetitive disclosures, (b) the frequency, periodicity or number of these repetitive disclosures and (c) the date of the last of these repetitive disclosures. Business Associate will make this disclosure information available to Recipient or its Subsidiaries promptly upon Recipient’s or its Subsidiaries’ request.

2. Exceptions from Disclosure Tracking. Business Associate need not record disclosure information or otherwise account for disclosures of PHI that this Addendum or Recipient or the relevant Subsidiary in writing permits or requires (i) for the purpose of Recipient’s or its Subsidiaries’ treatment activities, payment activities, or health care operations, (ii) to the individual who is the subject of the PHI disclosed or to that individual’s personal representative; (iii) to persons involved in that individual’s health care or payment for health care; (iv) for notification for disaster relief purposes, (v) for national security or intelligence purposes, (vi) to law enforcement officials or correctional institutions regarding inmates; or (vii) pursuant to an authorization; (viii) for disclosures of certain PHI made as part of a Limited Data Set; (ix) for certain incidental disclosures that may occur where reasonable safeguards have been implemented; and (x) for disclosures prior to April 14, 2003.

3. Disclosure Tracking Time Periods. Business Associate must have available for Recipient and its Subsidiaries the disclosure information required by this section for the 6 years preceding Recipient’s or its Subsidiaries’ request for the disclosure information (except Business Associate need have no disclosure information for disclosures occurring before April 14, 2003).

4

---

## VI. Additional Business Associate Provisions

A. Reporting of Breach of Privacy Obligations. Business Associate will provide written notice to whichever of the Recipient or its Subsidiary for which the relevant PHI was created or from which the relevant PHI was received of any use or disclosure of PHI that is neither permitted by this Addendum nor given prior written approval by Recipient or the relevant Subsidiary promptly after Business Associate learns of such non-permitted use or disclosure. Business Associate’s report will at least:

- (vii) Identify the nature of the non-permitted use or disclosure;
- (viii) Identify the PHI used or disclosed;
- (ix) Identify who made the non-permitted use or received the non-permitted disclosure;
- (x) Identify what corrective action Business Associate took or will take to prevent further non-permitted uses or disclosures;
- (xi) Identify what Business Associate did or will do to mitigate any deleterious effect of the non-permitted use or disclosure; and
- (xii) Provide such other information, including a written report, as Recipient or the relevant Subsidiary may reasonably request.

B. Amendment. Upon the effective date of any final regulation or amendment to final regulations promulgated by the U.S. Department of Health and Human Services with respect to PHI, including, but not limited to the HIPAA privacy and security regulations, this Addendum and the Agreement will automatically be amended so that the obligations they impose on Business Associate remain in compliance with these regulations.

In addition, to the extent that new state or federal law requires changes to Business Associate’s obligations under this Addendum, this Addendum shall automatically be amended to include such additional obligations, upon notice by Recipient or its Subsidiaries to Business Associate of such obligations. Business Associate’s continued performance of services under the Agreement shall be deemed acceptance of these additional obligations.

C. Audit and Review of Policies and Procedures. Business Associate agrees to provide, upon Recipient request, access to and copies of any policies and procedures developed or utilized by Business Associate regarding the protection of PHI. Business Associate agrees to provide, upon Recipient’s request, access to Business Associate’s internal practices, books, and records, as they relate to Business Associate’s services, duties and obligations set forth in this Addendum and the Agreement(s) under which Business Associate provides services and / or products to or on behalf of Recipient or its Subsidiaries, for purposes of Recipient’s or its Subsidiaries’ review of such internal practices, books, and records.

5

---



**RETROCESSION AGREEMENT**  
**between**  
**GE CAPITAL LIFE ASSURANCE COMPANY OF NEW YORK**  
**and**  
**UNION FIDELITY LIFE INSURANCE COMPANY**  
**Dated as of April 15, 2004**

---

---

TABLE OF CONTENTS

<a href="#">ARTICLE I</a>	<u>DEFINITIONS</u>
<a href="#">ARTICLE II</a>	<u>COVERAGE</u>
<a href="#">ARTICLE III</a>	<u>ADMINISTRATION; GENERAL PROVISIONS</u>
<a href="#">ARTICLE IV</a>	<u>CLAIMS SETTLEMENT ACCOUNT; CLAIMS</u>
<a href="#">ARTICLE V</a>	<u>REINSURANCE ASSET TRANSFER; CEDING COMMISSION</u>
<a href="#">ARTICLE VI</a>	<u>EXPENSE ALLOWANCES</u>
<a href="#">ARTICLE VII</a>	<u>ACCOUNTING AND SETTLEMENT</u>
<a href="#">ARTICLE VIII</a>	<u>EXPERIENCE REFUND</u>
<a href="#">ARTICLE IX</a>	<u>DURATION AND TERMINATION</u>
<a href="#">ARTICLE X</a>	<u>INSOLVENCY</u>
<a href="#">ARTICLE XI</a>	<u>CREDIT FOR REINSURANCE</u>
<a href="#">ARTICLE XII</a>	<u>REINSURANCE SECURITY</u>
<a href="#">ARTICLE XIII</a>	<u>DEFERRED ACQUISITION COSTS</u>
<a href="#">ARTICLE XIV</a>	<u>INDEMNIFICATION</u>
<a href="#">ARTICLE XV</a>	<u>DISPUTE RESOLUTION</u>
<a href="#">ARTICLE XVI</a>	<u>PRIVACY REQUIREMENTS</u>
<a href="#">ARTICLE XVII</a>	<u>MISCELLANEOUS PROVISIONS</u>
 <u>SCHEDULES</u>	
SCHEDULE A	— POLICY FORMS
SCHEDULE B	— FORM OF ADMINISTRATIVE SERVICES AGREEMENT
SCHEDULE C	— CEDING COMMISSION
SCHEDULE D	— ASSETS
SCHEDULE E	— EXPENSE ALLOWANCES

SCHEDULE F	—	PART I	—	INITIAL REPORT
SCHEDULE F	—	PART II	—	MONTHLY SETTLEMENT REPORT
SCHEDULE F	—	PART III	—	QUARTERLY SETTLEMENT REPORT
SCHEDULE F	—	PART IV	—	ANNUAL REPORT
SCHEDULE G	—	FORM OF TRUST AGREEMENT		
SCHEDULE H	—	ELIGIBLE SECURITIES		
SCHEDULE I	—	EXPERIENCE REFUND		

RETROCESSION AGREEMENT

This Retrocession Agreement, dated as of April 15, 2004 (this “Agreement”), is made and entered into by and between GE Capital Life Assurance Company of New York, an insurance company organized under the laws of the State of New York (the “Company”), and Union Fidelity Life Insurance Company, an insurance company organized under the laws of the State of Illinois (the “Reinsurer”). Defined terms used herein are defined below.

The Company and the Reinsurer mutually agree to reinsure the risks described in this Agreement under the terms and conditions stated herein. This Agreement is an indemnity retrocession agreement solely between the Company and the Reinsurer, and the performance of the obligations of each party under this Agreement shall be rendered solely to the other party. In no instance shall anyone other than the Company or the Reinsurer have any rights under this Agreement. The Company shall be and shall remain the only party hereunder that is liable to Travelers under the Travelers Reinsurance Agreement or to any insured, contract holder, policyholder, claimant or beneficiary under any Novated Policy.

This Agreement is entered into in connection with an intercompany reorganization among the Company, the Reinsurer and certain of their Affiliates.

Nothing in this Agreement, express or implied, is intended to or shall assign, delegate, sublicense or transfer, in whole or in part, any rights, interests or obligations under the Travelers Agreements.

ARTICLE I

DEFINITIONS

1.1. Definitions. As used in this Agreement, the following terms shall have the following meanings (definitions are applicable to both the singular and the plural forms of each term defined in this Article):

“Accounting Period” means each calendar month, except that the last Accounting Period shall be the period commencing with the first day of the month in which the Termination Date falls and ending with the Termination Date.

“Affiliate” means any other Person that directly or indirectly controls, is controlled by, or is under common control with, the first Person. “Control” (including the terms, “controlled by” and “under common control with”) means the possession, directly or indirectly, of the power to direct or cause the direction of the management and policies of a Person, whether through the ownership of voting securities, by contract or credit arrangement, as trustee or executor, or otherwise.

“Agreement” shall have the meaning specified in the first paragraph of this Agreement.

“Allocated Loss Adjustment Expenses” means all costs, fees and expenses incurred by the Company or its Affiliates in the investigation, adjustment, settlement or defense of all claims or the monitoring, preservation or enforcement of rights, interests or benefits arising out of or relating to the Reinsured Policies (excluding office expenses and salaries of officials of the Company or its Affiliates or any other administrative or overhead expenses of the Company or of its Affiliates), and court costs, and interest on any judgment or award. Allocated Loss Adjustment Expenses shall also include expenses associated with an action by any entity for declaratory judgment filed in connection with the Reinsured Policies.

“Annual Report” shall have the meaning specified in Section 7.5.

“Applicable Law” means any federal, state, local or foreign law (including common law), statute, ordinance, rule, regulation, order, writ, injunction, judgment, permit governmental agreement or decree applicable to a Person or any of such Person’s subsidiaries, properties, assets, or to such Person’s officers, directors, managing directors, employees or agents in their capacity as such.

“Assets” shall have the meaning specified in Section 5.4(a).

“Assignment Letter Agreement” means the letter agreement dated the date hereof among General Electric Capital Corporation, a Delaware corporation, the Reinsurer, the Company and certain affiliates of the Company relating to the assignment by General Electric Capital Corporation of the Capital Maintenance Agreement.

“Business Day” means any day other than a Saturday, Sunday or other day on which commercial banks in the States of Illinois or Virginia are required or authorized by law to be closed.

“Business Overhead Services” shall have the meaning specified in Schedule E-1 hereto.

“Capital Maintenance Agreement” means the Capital Maintenance Agreement between General Electric Capital Corporation, a Delaware corporation, and the Reinsurer.

“Ceding Commission” shall have the meaning specified in Section 5.3.

“Claims Settlement Account” shall have the meaning specified in Section 4.1(a).

“Closing Date” means April 15, 2004.

“Code” means the Internal Revenue Code of 1986, as amended.

“Company Account” shall have the meaning specified in Section 12.1(e).

“CPR” shall have the meaning specified in Section 15.3.

“CPR Arbitration Rules” shall have the meaning specified in Section 15.4(a).

“Dispute” shall have the meaning specified in Section 15.1(a).

“Eligible Securities” shall have the meaning specified in Section 12.1(c).

“Expense Allowance” shall have the meaning specified in Section 6.1.

“Experience Account” has the meaning set forth in Section 8.1(a).

“Experience Refund” has the meaning set forth in Section 8.1(c).

“Experience Refund Baseline” has the meaning set forth in Section 8.1(a).

“Extra Contractual Liabilities” means all liabilities for damages (including compensatory, consequential, exemplary, punitive, bad faith or similar or other damages) which (i) arise out of the conduct of the Company on or prior to the Inception Date in seeking premium rate increases pursuant to the terms of the Travelers Reinsurance Agreement or the Travelers Servicing Agreement or (ii) relate to the marketing, sale, underwriting, issuance, delivery, cancellation or administration of the Reinsured Policies, including liability arising out of or relating to any alleged or actual acts, errors or omissions by the Company or its agents, whether intentional or otherwise, with respect to any of the Reinsured Policies, including (A) any alleged or actual reckless conduct or bad faith in connection with the handling of any claim arising out of or under Reinsured Policies, or (B) the marketing, sale, underwriting, issuance, delivery, cancellation or administration of any of the Reinsured Policies.

“Force Majeure” shall have the meaning specified in Section 3.9(b)(iii).

“Funding Requirement” shall have the meaning specified in Section 12.1(e).

“GAAP” means U.S. generally accepted accounting principles consistently applied.

“GECA” means General Electric Capital Assurance Company, an insurance company organized under the laws of the State of Delaware, and an affiliate of the Company.

“Governmental Authority” means any foreign or national government, any state or other political subdivision thereof, and any entity exercising executive, legislative, judicial, regulatory or administrative functions of or pertaining to government.

“Inception Date” shall have the meaning specified in Section 2.1.

“Initial Notice” shall have the meaning specified in Section 15.2.

“Initial Reinsurance Premium” shall have the meaning specified in Section 5.1.

“Initial Report” shall have the meaning specified in Section 7.1.

“Insolvency Fund” means any guarantee fund, insolvency fund, plan, pool, association, fund or other arrangement, however denominated, established or governed, which provides for any assessment of or payment or assumption by the Company of part or all of any

claim, debt, charge, fee or other obligation of an insurer or reinsurer, or its successors or assigns, which has been declared by any competent authority to be insolvent, or which is otherwise deemed unable to meet any claim, debt, charge, fee or other obligation in whole or in part.

“Loss” or “Losses” means the amount of liability paid or payable by the Company with respect to claims, losses, liabilities, damages, deficiencies, costs or expenses, including without limitation, any settlements or compromises or disputed claims, arising under the Reinsured Policies.

“Loss Carry Forward Amount” shall have the meaning specified in the Travelers Reinsurance Agreement.

“Minimum Claims Settlement Amount” shall have the meaning specified in Section 4.1(b).

“Monthly Settlement” shall have the meaning specified in Section 5.4(a).

“Monthly Settlement Report” shall have the meaning specified in Section 7.2.

“Novated Policies” shall have the meaning specified in Section 2.6.

“Person” means any natural person, firm, limited liability company, general partnership, limited partnership, joint venture, association, corporation, trust, Governmental Authority or other entity.

“Quarterly Settlement” shall have the meaning specified in Section 5.4(a).

“Quarterly Settlement Report” shall have the meaning specified in Section 7.3.

“RBC Reporting Letter Agreement” means the letter agreement dated the date hereof among the Company, the Reinsurer and certain affiliates of the Company relating to the Reinsurer’s requirement to provide periodic certifications and reports regarding the Reinsurer’s risk based capital ratio.

“Reinsured Policies” means the long term care insurance policies issued by or on behalf of Travelers prior to January 1, 2004 and written on the policy forms described in Schedule A and reinsured by the Company pursuant to the Travelers Reinsurance Agreement.

“Reinsured Risks” shall have the meaning specified in Section 2.1.

“Response” shall have the meaning specified in Section 15.2.

“SAP” means statutory accounting practices prescribed or permitted by the Insurance Department of the State of New York.

“Tax DAC” means specified policy acquisition expenses capitalized and amortized under section 848 of the Code.

“Termination Date” means the effective date of any termination of this Agreement as provided in Article IX.

“Termination Letter Agreement” means the letter agreement dated the date hereof among the Company, the Reinsurer and certain affiliates of the Company relating to the rescission of this Agreement upon the failure of certain events to occur after the date hereof.

“Total Annual Contribution” has the meaning set forth in Section 8.1(b).

“Total SAP Ceded Reserves” means, as of any given date, the gross reserves of the Company calculated in accordance with SAP with respect to the Reinsured Risks, which shall consist of the sum of (A) (i) active life reserves, (ii) claim reserves (both case and incurred but not reported), (iii) unearned premium reserves, and (iv) advance premiums, less (B) due and unpaid premium receivable balances.

“Total GAAP Ceded Reserves” means, as of any given date, the gross reserves of the Company calculated in accordance with GAAP with respect to the Reinsured Risks, which shall consist of the sum of (A) (i) active life reserves (including related maintenance and loss expense reserves), (ii) claim reserves (both case and incurred but not reported), (iii) unearned premium reserves, and (iv) advance premiums, less (B) due and unpaid premium receivable balances.

“Travelers” means The Travelers Insurance Company, a Connecticut insurance company.

“Travelers Agreements” means, collectively, the Travelers Acquisition Agreement, the Travelers Reinsurance Agreement, the Travelers Servicing Agreement and the Travelers Side Letter.

“Travelers Acquisition Agreement” means the Acquisition Agreement dated as of April 14, 2000 between GECA and Travelers, including all amendments, modifications and supplements thereto made prior to January 1, 2004 or on or after January 1, 2004 with the consent of the Reinsurer.

“Travelers Reinsurance Agreement” means the New York Indemnity Reinsurance Agreement dated as of July 1, 2000 between the Company and Travelers, including all amendments, modifications and supplements thereto made prior to January 1, 2004, or on or after January 1, 2004 with the consent of the Reinsurer, and as contemplated in Section 2.7.

“Travelers Servicing Agreement” means the New York Administrative Services Agreement dated as of July 1, 2000 between Travelers and the Company, including all amendments, modifications and supplements thereto made prior to January 1, 2004 or on or after January 1, 2004 with the consent of the Reinsurer.

“Travelers Side Letter” means the letter agreement, dated April 14, 2000, between Travelers and GECA relating to or governing the novation of the Reinsured Policies reinsured by the Company pursuant to the Travelers Reinsurance Agreement, including all amendments, modifications and supplements thereto made prior to January 1, 2004 (including without limitation the amendment thereto dated July 31, 2000) or on or after January 1, 2004 with the consent of the Reinsurer.

“Trust Account” shall have the meaning set forth in Section 12.1(a).

“Trust Agreement” shall have the meaning set forth in Section 12.1(a).

“Trustee” shall have the meaning set forth in Section 12.1(a).

“Ultimate Net Loss” shall have the meaning specified in Section 2.3(a).

## ARTICLE II

### COVERAGE

2.1. Coverage. Upon the terms and subject to the conditions and other provisions of this Agreement, as of 12:01 a.m. Eastern Time on January 1, 2004 (the “Inception Date”), the Company hereby retrocedes to the Reinsurer, and the Reinsurer hereby agrees to indemnify the Company for, one hundred percent (100%) of Ultimate Net Loss incurred by the Company and unpaid as of the Inception Date (the “Reinsured Risks”).

2.2. Conditions. (a) If the Company’s liability under any of the Reinsured Policies is changed because of changes made on or after the Inception Date in the terms and conditions of the Reinsured Policies (including to any contract riders or endorsements thereto) that are required due to changes in Applicable Law, the Reinsurer will share in the change proportionately to the coinsurance share hereunder and the Company and the Reinsurer will make all appropriate adjustments to amounts due each other under this Agreement.

(b) Except as otherwise set forth in paragraph (a) above, no changes, amendments or modifications made by the Company on or after the Inception Date in the terms and conditions of the Reinsured Policies which adversely affect the liability of the Reinsurer hereunder shall be covered hereunder without the prior written approval of such changes, amendments or modifications by the Reinsurer, which approval shall not be unreasonably withheld or delayed. In the event that any such changes, amendments or modifications are made by the Company in any Reinsured Policy without the prior written approval of the Reinsurer, this Agreement will cover Ultimate Net Loss incurred by the Company as if the non-approved changes, amendments or modifications had not been made.

2.3. Ultimate Net Loss. (a) Subject to the provisions of Sections 2.2, 2.3(b) and (c) and the terms and conditions of this Agreement, “Ultimate Net Loss” shall mean (i) in the case of all Reinsured Policies other than the Novated Policies, one hundred percent (100%) of the Company’s liability arising under the Travelers Reinsurance Agreement (including without limitation Stop-Loss Payments due by the Company to Travelers under the Travelers

returns or refunds of premiums under the Novated Policies, (E) all liability for commission payments and other fees or compensation payable with respect to the Reinsured Policies in respect of premiums and other amounts paid on or after the Inception Date and (F) unclaimed property liabilities and obligations arising under or related to the Reinsured Policies and payable on or after the Inception Date.

(b) Any Extra Contractual Liabilities resulting from actions of the Company or its agents or reinsured by the Company under the Travelers Reinsurance Agreement shall be treated as a Loss for the purposes of this Agreement to the extent permitted by state law, except to the extent that any such Extra Contractual Liabilities are attributable to the conduct of the Company in its administration of the Reinsured Policies on or after the Inception Date, other than actions taken by the Company at the written request or direction of the Reinsurer.

(c) All recoveries or payments received by the Company subsequent to a loss settlement under this Agreement shall be applied as if recovered or received prior to the aforesaid settlement and all necessary adjustments shall be made by the parties hereto; provided, that nothing in this Section 2.3(c) shall be construed to mean that the Reinsurer's share of the Losses and Allocated Loss Adjustment Expenses under this Agreement are not recoverable until the Company's Ultimate Net Loss has been ascertained.

2.4. Territory. The territorial limits of this Agreement shall be identical with those of the Reinsured Policies.

2.5. Ceded Reinsurance. Subsequent to the Inception Date, the Company will not enter into any reinsurance arrangements with respect to the Reinsured Policies without the prior written consent of the Reinsurer, in its sole discretion.

2.6. Novation of Reinsured Policies. The Reinsurer acknowledges that the Company is obligated under the terms of the Travelers Agreements to use its reasonable best efforts to assume and effect the novation of each of the Reinsured Policies from Travelers to the Company, so as to substitute the Company, in lieu of Travelers, as the insurer directly liable to the underlying insureds under the Reinsured Policies. Any Reinsured Policy that has been novated to the Company is referred to in this Agreement as a "Novated Policy". In the event that a Reinsured Policy is novated from Travelers to the Company, such Reinsured Policy shall continue for all purposes of this Agreement to be a Reinsured Policy hereunder. The Reinsurer shall reimburse the Company for all costs reasonably incurred by the Company in seeking to so novate the Reinsured Policies, which, for the avoidance of doubt, are not included in the Expense Allowance.

7

---

2.7. Travelers Reinsurance Agreement. The Reinsurer acknowledges that the Company is obligated under the terms of the Travelers Side Letter to amend the Travelers Reinsurance Agreement not later than July 31, 2008, to increase the portion of the underlying business that Travelers has ceded to the Company on a coinsurance basis from ninety percent (90%) to one hundred percent (100%) of the New York Reinsured Liabilities (as such term is defined in the Travelers Reinsurance Agreement). Any such increased cession of the New York Reinsured Liabilities (as such term is defined in the Travelers Reinsurance Agreement) shall be reinsured under this Agreement.

### ARTICLE III

#### ADMINISTRATION: GENERAL PROVISIONS

3.1. Contract Administration. (a) Subject to Section 3.9, the Company shall provide policyholder and claims servicing and Business Overhead Services identified on Schedule E-1 hereto with respect to the Reinsured Policies in accordance with the terms hereof. All claims paid by the Company shall be binding upon the Reinsurer; provided, however, that such claims are within the terms, conditions and limitations of the Reinsured Policies. The Company shall administer the Travelers Reinsurance Agreement and provide policyholder and claims servicing and such Business Overhead Services with respect to the Reinsured Policies in good faith and with the care, skill, prudence and diligence of a person experienced in administering long term care insurance business. The Company shall provide policyholder and claims servicing and such Business Overhead Services with respect to the Reinsured Policies, (i) in accordance with the terms of the Reinsured Policies, (ii) in accordance with the terms of the Travelers Agreements, (iii) in accordance with the applicable terms of this Agreement, (iv) in compliance with Applicable Law and, subject to the foregoing, (v) in the same manner as it conducts its own business not subject to this Agreement and (vi) in accordance with the Company's administrative performance standards in effect on the date hereof, with such revisions to such standards as are no less favorable to the Reinsurer than the Company's standards in effect on the date hereof. Notwithstanding the foregoing, the parties may, from time to time, mutually develop specific and/or different standards for providing such services with respect to the Reinsured Policies, provided, that such standards are not in conflict with the terms of the Travelers Agreements.

(b) The Company may subcontract for the performance of any policyholder or claims servicing service or services and such Business Overhead Services with respect to the Reinsured Policies to (i) an Affiliate or (ii) any other Person with the prior written consent of the Reinsurer, such consent not to be unreasonably withheld; provided, that the Company also subcontracts for such service or services for its own long term care insurance business not subject to this Agreement to such subcontractor; provided, further, that such subcontracting is permitted under the Travelers Servicing Agreement; and provided, further, that no such subcontracting shall relieve the Company from any of its obligations or liabilities hereunder, and the Company shall remain responsible for all obligations or liabilities of such subcontractor with regards to the providing of such service or services as if provided by the Company.

8

---

3.2. Claims Settlements. (a) With respect to Reinsured Policies that are not Novated Policies, the Company agrees that it will provide prompt notice to the Reinsurer of its intention to litigate a claim with respect to such Reinsured Policy, along with copies of all pleadings and reports of investigation with respect thereto. The Reinsurer shall have the right, at its own expense, to participate jointly with the Company in the investigation, adjustment or defense of such litigation.

(b) With respect to Novated Policies, the Company agrees that it will provide prompt notice to the Reinsurer of its intention to contest, compromise or litigate a claim with respect to a Novated Policy, along with copies of all pleadings and reports of investigation with respect thereto. The Reinsurer shall have the right, at its own expense, to participate jointly with the Company in the investigation, adjustment or defense of such claims with respect to Novated Policies. In addition, in the event that litigation arises against the Company in connection with a claim with respect to a Novated Policy which seeks damages in excess of \$1 million or other remedies deemed material to the Reinsurer, the Reinsurer may, upon written notice to the Company, assume the defense thereof with counsel selected by the Reinsurer and reasonably satisfactory to the Company. If the Reinsurer assumes such defense, the Company shall have the right, at its own expense, to participate jointly with the Reinsurer in the defense thereof. If the Reinsurer assumes the defense of litigation, the Reinsurer shall not settle such litigation without the Company's prior written consent (which consent shall not be unreasonably withheld or delayed) unless (i) there is no finding or admission of any violation of law or any violation of the rights of any Person, (ii) such settlement would not reasonably be expected to have material adverse precedential consequences to the Company and (iii) the sole relief provided is monetary damages that are paid in full by the Reinsurer.

3.3. Re-rating of Novated Policies. The Company (i) agrees to promptly seek to increase or decrease the premium rates under the Novated Policies from and after the Inception Date as requested by the Reinsurer and approved by the Company and (ii) shall be entitled to increase premium rates without the consent of the Reinsurer. In approving or disapproving premium rate increases requested by the Reinsurer, the Company agrees to not unreasonably withhold or delay its approval. Notwithstanding the foregoing, with respect to the Novated Policies, neither the Reinsurer nor the Company may request or implement, as applicable, a premium rate increase unless such premium rate increase would have been permitted under the terms of Section 4.2(i) of the Travelers Servicing Agreement assuming such Novated Policies continued to be "New York Reinsured Contracts" as defined under the Travelers Servicing Agreement. In addition, neither the Reinsurer nor the Company may request or implement, as applicable, more than one (1) premium rate increase with respect to the Novated Policies in any state in any period of three (3) calendar years.

Except as required by Section 3.3(i) or by Applicable Law, the Company shall refrain from seeking any decrease in the premium rates under the Novated Policies from and after the Inception Date.

The Reinsurer shall bear, and shall indemnify the Company for, all costs and liabilities incurred in or arising out of seeking or effecting any premium rate changes at the direction of the Reinsurer, which, for the avoidance of doubt, are not included in the Expense Allowance.

9

---

3.4. Inspection. The Company shall keep accurate and complete records, files and accounts of all transactions and matters with respect to the Reinsured Policies and the administration thereof in accordance with Applicable Law and its record management practices in effect from time to time for the Company's insurance business not covered by this Agreement. The Reinsurer and its designated representatives may upon reasonable notice inspect, at the offices of the Company where such records are located, the papers and any and all other books or documents of the Company reasonably relating to this Agreement, including the Reinsured Policies and the administration thereof by the Company (including compliance with the provisions of Section 3.1), and shall have access to appropriate employees and representatives of the Company, in each case during normal business hours for such period as this Agreement is in effect or for as long thereafter as the Company seeks performance by the Reinsurer pursuant to the terms of this Agreement or the Reinsurer reasonably needs access to such records for regulatory, tax or similar purposes. The information obtained shall be used only for purposes relating to the transactions contemplated under this Agreement.

3.5. Errors and Omissions. If any delay, omission, error or failure to pay amounts due or to perform any other act required by this Agreement is unintentional and caused by misunderstanding or oversight, the Company and the Reinsurer will adjust the situation to what it would have been had the misunderstanding or oversight not occurred. The party first discovering such misunderstanding or oversight, or an act resulting from such misunderstanding or oversight, will notify the other party in writing promptly upon discovery thereof, and the parties shall act to correct such misunderstanding or oversight within twenty (20) Business Days of such other party's receipt of such notice. However, this Section shall not be construed as a waiver by either party of its right to enforce strictly the terms of this Agreement.

3.6. Age, Sex and Other Adjustments. If the Company's liability under any of the Reinsured Policies is changed because of a misstatement of age or sex or any other material fact, the Reinsurer will share in the change proportionately to the coinsurance share hereunder and the Company and the Reinsurer will make all appropriate adjustments to amounts due each other under this Agreement.

3.7. Setoff. Any debts or credits, matured or unmatured, in favor of or against either the Company or the Reinsurer with respect to this Agreement are deemed mutual debts or credits, as the case may be, and shall be setoff from any amounts due to the Company or the Reinsurer hereunder, as the case may be, and only the net balance shall be allowed or paid.

3.8. Salvage and Subrogation. The Company shall use all commercially reasonable efforts to fully obtain the benefit of any and all potential recoveries, salvage and subrogations that would reasonably be expected to reduce the amount of Ultimate Net Loss.

3.9. Administration by Reinsurer. (a) At any time from and after the fifteenth (15<sup>th</sup>) anniversary of the Inception Date, the Reinsurer shall have the right to assume from the Company the administration of the Novated Policies, provided that the Reinsurer provides twelve (12) months prior written notice of such assumption, which notice may be given as early as the fourteenth (14<sup>th</sup>) anniversary of the Inception Date to take effect as of the fifteenth (15<sup>th</sup>) anniversary of the Inception Date. The Reinsurer shall bear all transition costs associated with

10

---

an assumption of the administration of the Novated Policies pursuant to this paragraph (a) of this Section 3.9.

(b) In addition to the provisions of Section 3.9(a), the Reinsurer shall have the right, upon written notice to the Company to assume from the Company the administration of the Novated Policies upon the occurrence of any of the following events:

- (i) A voluntary or involuntary proceeding is commenced in any jurisdiction by or against the Company for the purpose of conserving, rehabilitating or liquidating the Company;
- (ii) There is a material breach by the Company of any material term or condition of this Article III that is not cured by the Company within thirty (30) days after receipt of written notice from the Reinsurer of such breach or act (provided that the Reinsurer shall not have the right to assume such administration (A) for so long as the Company is making a good faith effort to cure such breach, not to exceed an additional one hundred eighty (180) days or (B) during the pendency of any dispute resolution proceedings as set forth in Article XV regarding an alleged material breach); or
- (iii) The Company is unable to perform the services required under this Article III for a period of thirty (30) consecutive days for any reason, other than as a result of a Force Majeure, it being understood that nothing in this Section 3.9(b)(iii) shall relieve the Company from its administrative responsibilities under this Agreement. For purposes of this Agreement "Force Majeure" means any acts or omissions of any civil or military authority, acts of God, acts or omissions of the Reinsurer, fires, strikes or other labor disturbances, equipment failures, fluctuations or non-availability of electrical power, heat, light, air conditioning or telecommunications equipment, or any other act, omission or occurrence beyond the Company's reasonable control, irrespective of whether similar to the foregoing enumerated acts, omissions or occurrences.

(c) The Company shall bear all transition costs associated with an assumption of the administration of the Novated Policies pursuant to Section 3.9(b).

(d) In the event of the Reinsurer's assumption of the administration of the Novated Policies, the Reinsurer and the Company shall enter into an administrative services agreement in the form attached hereto as Schedule B and the provisions of Article IV and Article VI shall become inoperative with respect to the Novated Policies.

11

---

#### ARTICLE IV

##### CLAIMS SETTLEMENT ACCOUNT; CLAIMS

4.1. Claims Settlement Account. (a) On the Closing Date, the Reinsurer shall establish a separate bank account (the "Claims Settlement Account") in its own name for the payment of Reinsured Risks and shall authorize two signatories who shall be representatives of the Company and approved by the Reinsurer in writing to issue drafts in the name of the Reinsurer and showing the identity of the Company. The Reinsurer shall fund such account for payment of claims in accordance with the provisions of Section 4.1(b). Any interest earned on the Claims Settlement Account shall belong to the Reinsurer. The Claims Settlement Account shall be administered by the Company in a fiduciary capacity and shall be used solely by the Company to make payments of claims in accordance with the terms of this Agreement.

(b) The Reinsurer shall deposit \$2.5 million in the Claims Settlement Account on the Closing Date and shall thereafter fund the Claims Settlement Account on or before the fifth (5<sup>th</sup>) day of each month in amounts agreed by the Company and the Reinsurer from time to time in amounts sufficient to provide funds to the Company for the payment of Reinsured Risks during the next thirty (30) days, or such other amount as may be mutually agreed by the parties (such initial deposit amount and each minimum funding amount as agreed from time to time shall be referred to as a "Minimum Claims Settlement Amount"). In addition, the Reinsurer shall deposit to the Claims Settlement Account such additional amounts as may be required to keep the balance of such account above zero at all times. In consideration of the Reinsurer providing the Claims Settlement Account arrangement, the Company agrees that it shall apply funds in the Claims Settlement Account against the Reinsurer's liability under this Agreement until such funds are exhausted.

(c) The Company shall keep true and complete records, in accordance with Applicable Law and its record management practices in effect from time to time for the Company's insurance business not covered by this Agreement, clearly recording the deposits in and withdrawals from the Claims Settlement Account, including records relating to the payment of Reinsured Risks from the Claim Settlement Account. The Company will make available to the Reinsurer, or shall furnish to the Reinsurer or its designated representative, upon request of

the Reinsurer or its designated representative, copies of all such records. All copies furnished in the ordinary course of business shall be furnished by the Company at the Company's cost, which shall be included in the Expense Allowance. Any extraordinary costs reasonably incurred by the Company in response to requests from the Reinsurer shall be reimbursed by the Reinsurer.

(d) Within thirty (30) days after each Accounting Period (or more frequently as mutually agreed by the parties), the Company shall render a complete accounting to the Reinsurer detailing all transactions with respect to the Claims Settlement Account, in such form as agreed by the parties.

(e) The parties agree to deliver to the depository bank such depository resolutions, signature cards and other documents as may be requested of them in order to use such accounts at the depository bank in accordance with the provisions of this Article IV.

12

---

(f) Upon a termination of this Agreement pursuant to Article IX, the Reinsurer shall close the Claims Settlement Account and any closing balance therein shall be the property of the Reinsurer. The Company's claims payment authority under this Agreement with respect to the Claims Settlement Account shall terminate immediately upon termination of this Agreement pursuant to Article IX. Upon termination of its authority to pay claims, the Company shall promptly return to the Reinsurer all unused check stock held by it in connection with this Agreement.

#### ARTICLE V

##### REINSURANCE ASSET TRANSFER; CEDING COMMISSION

5.1. Initial Reinsurance Premium. As consideration for the reinsurance by the Reinsurer of the Reinsured Risks under this Agreement, on the Closing Date the Reinsurer shall be entitled to an amount equal to one hundred percent (100%) of the Total SAP Ceded Reserves as of the close of business on the day immediately preceding the Inception Date (the "Initial Reinsurance Premium").

5.2. Additional Reinsurance Premium. As additional consideration for the Reinsurer entering into this Agreement, Reinsurer shall be entitled to 100% of all premiums and other considerations (including all reinsurance premium and Stop-Loss Payments from Travelers to the Company under the Travelers Reinsurance Agreement) to the extent received on or after the Inception Date by the Company or the Reinsurer with respect to the Reinsured Policies, including premium receivables that were due and unpaid as of the Inception Date that were taken into account in the calculation of the Initial Reinsurance Premium.

5.3. Ceding Commission. On the Closing Date, the Company shall be entitled to a ceding commission (the "Ceding Commission") in an amount determined in accordance with Schedule C. On the date of amendment of the Travelers Reinsurance Agreement as described in Section 2.7, the Reinsurer shall pay to the Company an additional ceding commission equal to the ceding commission payable by the Company to Travelers at such time pursuant to such agreement.

5.4. Amounts Due the Parties. (a) Except as otherwise specifically provided herein, all amounts due to be paid to the Company under this Agreement shall be determined on a net basis, giving full effect to Section 3.7. The net amount due the Reinsurer from the Company on the Closing Date under Section 5.1 and Section 5.3 shall consist of (i) the investment assets (the "Assets") set forth on Schedule D, which assets have a statutory book value as of the close of business on the day immediately preceding the Inception Date equal to (A) the Initial Reinsurance Premium, less (B) the Ceding Commission, less (C) an amount equal to accrued but unpaid interest on the Assets as of the close of business on the day immediately preceding the Inception Date, plus (ii) an amount equal to the investment cash flows received on the Assets between the Inception Date and the Closing Date. The Company shall pay such net amount concurrent with its delivery of the Initial Report. Each net amount subsequently due with respect to each Accounting Period ending after the Inception Date (the "Monthly Settlement") shall be paid in cash by the Reinsurer to the Company no later than thirty (30) days

13

---

after delivery of the Monthly Settlement Report. Each net amount subsequently due with respect to each calendar quarter ending after the Inception Date (the "Quarterly Settlement") shall be paid in cash by the Reinsurer to the Company no later than thirty (30) days after delivery of the Quarterly Settlement Report. Each net amount subsequently due with respect to each calendar year ending after the Inception Date as reflected on an Annual Report shall be paid in cash by the Reinsurer to the Company no later than thirty (30) days after delivery of the Annual Report.

(b) The Company shall deliver to the Reinsurer possession of the Assets and such bills of sale, endorsements, assignments and other good and sufficient instruments of conveyance and transfer in form and substance reasonably acceptable to the parties as shall be effective to vest in the Reinsurer all of the right, title and interest of the Company in and to the Assets. Delivery of the Assets shall be a condition precedent of reinsurance coverage hereunder.

#### ARTICLE VI

##### EXPENSE ALLOWANCES

6.1. Expense Allowance. As reimbursement for expenses incurred by the Company in providing services with respect to the Reinsured Policies and Travelers Agreements, the Reinsurer shall pay to the Company with respect to each Accounting Period ending after the Inception Date, an expense allowance (each an "Expense Allowance") in an amount calculated in accordance with Schedule E, as subsequently adjusted in accordance with the methodology and procedures set forth in Schedule E.

#### ARTICLE VII

##### ACCOUNTING AND SETTLEMENT

7.1. Initial Report. A report shall be provided by the Company to the Reinsurer on the Closing Date providing the data required in Schedule F - Part I (the "Initial Report").

7.2. Monthly Settlement Reports. As soon as practicable but not more than thirty (30) days following the end of each Accounting Period ending after the Closing Date (or more frequently as mutually agreed by the parties), the Company shall supply the Reinsurer with a report that shall provide the financial data for such Accounting Period required in Schedule F - Part II (the "Monthly Settlement Report").

7.3. Quarterly Settlement Reports. As soon as practicable but not more than forty (40) days following the end of each calendar quarter ending after the Closing Date (or more frequently as mutually agreed by the parties), the Company shall supply the Reinsurer with a report that shall provide the financial data for such quarter required in Schedule F - Part III (the "Quarterly Settlement Report"). The Company and the Reinsurer agree that the financial data set forth on the Monthly Settlement Reports used for purposes of the Monthly Settlements, shall be true-up to actual amounts in the next Quarterly Settlement Report and the net amount, if any,

14

---

subsequently due to the Company or the Reinsurer, as the case may be, as a result of such adjustments shall be paid to the Company or the Reinsurer, as applicable. For the avoidance of doubt, the first Quarterly Settlement Report will include all transactions with respect to the Reinsured Policies occurring from the Inception Date through June 30, 2004.

7.4. Quarterly Financial Reports. As soon as practicable but not more than forty (40) days following the end of each calendar quarter ending after the Closing Date (or more frequently as mutually agreed by the parties), the Company shall supply the Reinsurer with reports related to the Reinsured Policies as may be reasonably requested for use in connection with the preparation of the Reinsurer's SAP financial statements or other reports prepared by the Reinsurer in compliance with its internal reporting requirements. The parties shall cooperate in good faith to establish the form for the providing of such reports.

7.5. Annual Reports. Within forty-five (45) days after the end of each calendar year during the term of this Agreement (or more frequently as mutually agreed by the parties), the Company shall supply the Reinsurer with a report that shall provide the financial data for such year required in Schedule F - Part IV (the "Annual Report").

7.6. Additional Reports and Updates. For so long as this Agreement remains in effect, each of the parties shall periodically furnish to the other such other reports and information as may be reasonably requested by such other party for regulatory, tax or similar purposes and reasonably available to it.

7.7. Delayed Payments. In the event that all or any portion of any payment due either party pursuant to this Agreement becomes overdue, the portion of the amount overdue shall bear interest at an annual rate equal to the then current thirty (30) day U.S. Treasury Bill discount rate on the date that the payment becomes overdue plus 200 basis points, for the period that the amount is overdue.

## ARTICLE VIII

### EXPERIENCE REFUND

8.1. Experience Refund. (a) The Reinsurer shall establish, and maintain through December 31, 2018, a notional account known as the "Experience Account" in connection with this Agreement, and record therein certain cumulative experience on the Reinsured Policies as described below. As of the Inception Date, the balance of the Experience Account will equal zero. Within the first forty five (45) days of each calendar year beginning January 1, 2005, through calendar year beginning January 1, 2019, the Company shall make the following calculation regarding certain experience on the Reinsured Policies during the preceding calendar year (which result may be a positive or a negative number), and shall promptly thereafter deliver to the Reinsurer the result of such calculation:

[X] x [Y], where

X equals the excess of (i) over (ii) (the result of which may be a positive number or a negative number), where (i) is the actual statutory basis pre-tax income earned on the Reinsured Policies

15

---

for the calendar year for which the calculation is being made, calculated consistent with projected statutory basis pre-tax income earned on the Reinsured Policies (the "Experience Refund Baseline") as calculated on Schedule I hereto, but utilizing actual experience (e.g., actual premiums and expenses will be used in place of the projected amounts shown on Schedule I), except for investment income during the first three years (see below) and (ii) is the Experience Refund Baseline for the calendar year for which the calculation is being made as set forth on Schedule I hereto; and

Y equals 90% for calculations made with respect to calendar years 2004 through 2006 and 50% for calculations made with respect to calendar years thereafter provided, however that if the cumulative amount of X during the calendar years 2004-2006 exceeds \$15 million, then Y shall be reduced to 50% for any amounts of X over \$15 million.

The calculation of investment income and the IMR income components of the actual pre-tax income for 2004-2006 shall be based on an assumed net annual yield of 5.95%, 5.89% and 5.83% respectively. To derive investment income, the prior stated rates should be applied to a 2 point average of the sum of Total SAP Ceded Reserves and statutory IMR liability. The two points should be December 31<sup>st</sup> for the applicable settlement year and December 31<sup>st</sup> for the immediately prior year. Surplus assets and investment income thereon are excluded from the Experience Refund Baseline calculation, and therefore should also be excluded from the Total Annual Contribution calculation. Thereafter the investment income and IMR income shall be similarly calculated using the actual net yield (net of investment expenses and default costs) and allocated IMR from the Reinsurer's LTC asset portfolio backing the Total SAP Ceded Reserves.

(b) The result of the calculation in Section 8.1(a) for each calendar year shall be referred to in this Agreement as the "Total Annual Contribution." Following each calculation of Total Annual Contribution, the balance of the Experience Account will be adjusted as of the end of the preceding calendar year as follows:

- (i) The balance of the Experience Account will be increased by: (A) the amount of the Total Annual Contribution for the preceding calendar year, but only if such Total Annual Contribution is a positive number and (B) interest credited in accordance with the terms of Section 8.1(d) below on any positive balance of the Experience Account.
- (ii) The balance of the Experience Account will be decreased by: (A) the amount of the Total Annual Contribution for the preceding calendar year, but only if such Total Annual Contribution is a negative number, (B) interest credited in accordance with the terms of Section 8.1(d) below on any negative balance of the Experience Account, and (C) the amount, if any, paid by the Reinsurer to the Company in accordance with the terms of Section 8.1(c) below.

(c) Subject to Section 8.1(e), each calendar year that the balance of the Experience Account is a positive number following the adjustments contemplated in Section 8.1(b) above (other than the adjustment contemplated in Section 8.1(b)(ii)(C)), the Reinsurer shall pay to the Company an "Experience Refund" as follows: (i) For calendar years ending

16

---

prior to December 31, 2018, the Reinsurer shall pay to the Company the lesser of (A) the balance of the Experience Account and (B) an amount equal to the sum of (x) 20% of each positive Total Annual Contribution made with respect to the previous five (5) calendar years (or shorter period in the event that this Agreement has not been in effect for five (5) years) plus (y) interest credited to the balance of the Experience Account during the previous calendar year in accordance with Section 8.1(d) below if the balance of the Experience Account was positive during such year; and (ii) For calendar year ending December 31, 2018, the Reinsurer shall pay to the Company the balance of the Experience Account as of December 31, 2018 (if a positive number). Any amounts due pursuant to this Section 8.1(c) shall be paid by the Reinsurer to the Company not later than thirty (30) days following the Company's delivery to the Reinsurer of the Company's calculation of the Total Annual Contribution for the preceding calendar year. In no event shall the Company be required to make any Experience Refund payments to the Reinsurer or return any Experience Refund payments to the Reinsurer, including if the balance of the Experience Account was, is or becomes a negative number.

(d) Interest shall accrue on the balance of the Experience Account (positive or negative) at an annual rate equal to the one (1) year U.S. Treasury Bill discount rate in effect on the close of business on July 1 or, if July 1 is not a Business Day, on the next Business Day of the current calendar year plus 100 basis points. Interest shall be credited to the balance of the Experience Account as of the end of each calendar year immediately before making any adjustments for the Total Annual Contribution with respect to such calendar year.

(e) Notwithstanding anything contained in this Section 8.1 to the contrary, no Experience Refund payments shall be made to the Company on any Reinsured Policies with respect to any period following the Reinsurer's assumption of the administration of the Novated Policies pursuant to Section 3.9.



ARTICLE IX

DURATION AND TERMINATION

9.1. Duration. Except as otherwise provided herein, this Agreement shall be unlimited in duration.

9.2. Reinsurer's Liability. The Reinsurer's liability with respect to the Reinsured Risks will terminate on the earliest of: (i) the date the Company's liability with respect to the Reinsured Risks is terminated and all amounts due the Company from the Reinsurer with respect to such Reinsured Risks are paid to the Company by or on behalf of the Reinsurer; and (ii) the date this Agreement is terminated upon the written agreement of the parties.

9.3. Notice of Termination. Upon the termination of the Reinsurer's liability with respect to the Reinsured Risks referred to in Section 9.2 above, the parties shall mutually give the Trustee written notice of their intention to terminate the Trust Account.

17

---

ARTICLE X

INSOLVENCY

10.1. Payments. In the event of the insolvency of the Company, all reinsurance made, ceded, renewed or otherwise becoming effective under this Agreement shall be payable by the Reinsurer directly to the Company or to its liquidator, receiver, or statutory successor on the basis of the liability of the Company under the policies reinsured, without diminution because of the insolvency of the Company. It is agreed and understood, however, that (i) in the event of the insolvency of the Company, the Reinsurer shall be given written notice of the pendency of a claim against the insolvent Company on a Reinsured Policy within a reasonable time after such claim is filed in the insolvency proceeding and (ii) during the pendency of such claim the Reinsurer may investigate such claim and interpose, at its own expense, in the proceeding where such claim is to be adjudicated any defenses which it may deem available to the Company or its liquidator, receiver or statutory successor.

10.2. Expenses. It is further understood that any expense thus incurred by the Reinsurer pursuant to Section 10.1 shall be chargeable, subject to court approval, against the insolvent Company as part of the expense of liquidation to the extent of a proportionate share of the benefit which may accrue to the Company solely as a result of the defense undertaken by the Reinsurer. Where two or more assuming reinsurers are involved in the same claim and a majority in interest elect to interpose defenses to such claim, the expense shall be apportioned in accordance with the terms of this Agreement as though such expense had been incurred by the Company.

ARTICLE XI

CREDIT FOR REINSURANCE

11.1. Reinsurance Credit. Notwithstanding any other provision of this Agreement to the contrary, if the Reinsurer becomes unauthorized or otherwise unaccredited as an insurer or reinsurer in any U.S. jurisdiction to which the Company must provide statutory statements of financial condition such that the Company will not obtain full statutory financial statement credit for reinsurance in such state for the reinsurance provided under this Agreement, the Reinsurer, upon the request of the Company, will establish, at the Reinsurer's sole cost and option, trust accounts for the benefit of the Company, letters of credit, or other acceptable alternatives necessary to permit the Company to obtain such full statutory financial statement credit for such reinsurance in all applicable jurisdictions. The Company shall cooperate with the Reinsurer to take such steps. In addition, in such event, the Reinsurer agrees to amend this Agreement and the Trust Agreement to the extent required under Applicable Law in order to provide the Company with such full statutory financial statement credit.

18

---

ARTICLE XII

REINSURANCE SECURITY

12.1. Trust. (a) On the Closing Date, the Reinsurer shall enter into a trust agreement in the form attached as Schedule G (the "Trust Agreement") and establish a trust account (the "Trust Account") for the benefit of the Company with respect to the Reinsured Risks with a bank (the "Trustee") designated as a Qualified United States Financial Institution by the Securities Valuation Office of the National Association of Insurance Commissioners or any successor organization or regulatory agency having similar duties.

(b) The Reinsurer agrees to deposit, and maintain in the Trust Account with respect to this Agreement, assets to be held in trust by the Trustee for the benefit of the Company as security for the payment of the Reinsurer's obligations to the Company under this Agreement.

(c) The parties agree that the assets so deposited with respect to this Agreement shall be valued according to their current statutory book value on the books of the Reinsurer and shall consist only of cash (United States legal tender), certificates of deposit (issued by a United States bank and payable in United States legal tender), and other assets of the type specified on Schedule H attached hereto ("Eligible Securities").

(d) The Reinsurer, prior to depositing assets with the Trustee, shall execute all assignments and endorsements in blank, or transfer legal title to the Trustee of all shares, obligations or any other assets requiring assignments, in order that, to the extent practicable, the Company, or the Trustee upon direction of the Company, may whenever necessary negotiate any such assets without consent or signature from the Reinsurer or any other entity. The Company recognizes that certain assets in the Trust Account will not be readily negotiable and that certain notices, opinions of counsel, representations and/or consents will be required for the Company to obtain good and marketable title to such assets.

(e) The Reinsurer and the Company agree that the assets in the Trust Account with respect to this Agreement may be withdrawn for the following purposes only:

(i) to pay or reimburse the Company for any amount due the Company pursuant to this Agreement to the extent not so paid or reimbursed by the Reinsurer;

(ii) to pay to the Reinsurer, in accordance with paragraph (h) below, any amounts held in the Trust Account that exceed an amount (the "Funding Requirement") equal to the sum of Total SAP Ceded Reserves and any additional reserves attributable to the Reinsured Risks that arise as a result of regulatory asset adequacy analysis requirements of the Reinsurer, less, prior to the date on which the Claims Settlement Account is closed, the Minimum Claims Settlement Amount then in effect; and

(iii) in the event that General Electric Capital Corporation breaches its obligations under the Capital Maintenance Agreement, to fund an account

19

---

with the Company (the "Company Account") in an amount at least equal to the deduction, for reinsurance ceded, from the Company's liabilities ceded under this Agreement. Such amount shall include, but not be limited to, amounts for policy reserves, reserves for claims and losses incurred (including losses incurred but not reported), loss and loss adjustment expenses, and unearned premiums.

(f) In the event that the Company withdraws assets from the Trust Account for the purposes set forth in Section 12.1(e)(i) above in excess of actual amounts required to meet the Reinsurer's obligations to the Company, the Company will promptly return such excess to the Reinsurer, plus interest at an annual rate equal to the then current thirty (30) day U.S. Treasury Bill discount rate on the date of withdrawal plus 200 basis points for the period during which the amounts were held pursuant to Section 12.1(e)(i). In the event that the Company withdraws assets from the Trust Account for the purposes set forth in Section 12.1(e)(iii) above, (i) the Reinsurer shall be relieved of its obligation to maintain assets in the Trust Account pursuant to this Section 12.1 to the extent of the amount of funds held in the Company Account and (ii) the Company shall first apply the funds in the Company Account in satisfaction of the Reinsurer's liability under this Agreement until the funds in the Company Account are exhausted. In the event that the Company withdraws assets from the Trust Account for the purposes set forth in Section 12.1(e)(iii) above, promptly following the date the Reinsurer's liability with respect to the Reinsured Risks is terminated, the Company shall return to the Reinsurer any assets so withdrawn that, together with any and all interest, dividends and other earnings thereon from the date of withdrawal to the date of return, are in excess of actual amounts required to meet the Reinsurer's obligations to the Company under this Agreement.

(g) The initial deposit to the Trust Account with respect to this Agreement shall be made on the Closing Date and shall consist of assets with a statutory book value equal to the Total SAP Ceded Reserves as of the close of business on the day immediately preceding the Inception Date, less an amount of assets with a statutory book value equal to the initial Minimum Claims Settlement Amount.

(h) The aggregate statutory book value of the assets held in the Trust Account with respect to this Agreement, shall at all times be at least equal to the Funding Requirement, and shall be adjusted on a quarterly basis so as to equal the Funding Requirement. On a quarterly basis, the Company shall promptly prepare and deliver to the Reinsurer a specific statement of the Funding Requirement and the Reinsurer shall promptly prepare and deliver to the Company a specific statement of the statutory book value of the assets in the Trust Account, in each case as of the end of the quarter. If the statement shows that the Funding Requirement exceeds 100% of the balance of the Trust Account with respect to this Agreement as of the statement date, the Reinsurer shall, within ten (10) Business Days after receipt of such notice of excess, secure delivery to the Trustee of additional cash or Eligible Securities having a current statutory book value equal to such difference. If the statement shows that the Funding Requirement is less than 100% of the balance of the Trust Account with respect to this Agreement as of the statement date, the Company shall, within ten (10) Business Days after delivery of such statement to the Reinsurer, deliver a notice of withdrawal to the Trustee directing the Trustee to withdraw from the Trust Account and deliver to the Reinsurer assets from the Trust Account having a current statutory book value equal to such excess amount. In

20

---

addition to the foregoing, the Reinsurer shall prepare and deliver to the Company on a quarterly basis a specific statement of the market value of the assets in the Trust Account as of the end of the quarter.

#### ARTICLE XIII

##### DEFERRED ACQUISITION COSTS

13.1. Tax DAC Information Sharing To ensure consistency in their respective Tax DAC calculations for tax purposes, the Company and the Reinsurer will exchange information pertaining to the amount of net consideration under this Agreement each year. The Company will submit a schedule to the Reinsurer by February 28 of each year presenting its calculation of the net consideration for the preceding taxable year. The Reinsurer may contest the calculation by providing to the Company and alternative calculation in writing within thirty (30) days of receipt of the Company's schedule. The Company and the Reinsurer will act in good faith to resolve any differences in the schedule of calculations within thirty (30) days of receipt of the alternative calculation to ensure consistent amounts are reported on the respective tax returns for the preceding tax year.

#### ARTICLE XIV

##### INDEMNIFICATION

14.1. Indemnification. (a) The Reinsurer agrees to indemnify and hold the Company harmless from any and all Losses (as defined in the Travelers Reinsurance Agreement) paid by the Company to any Cedent Indemnities (as defined in the Travelers Reinsurance Agreement) pursuant to Section 16.1 of the Travelers Reinsurance Agreement.

(b) The Company shall provide to the Reinsurer the benefits of any of the Company's indemnification rights under Section 16.2 of the Travelers Reinsurance Agreement and under Section 9.2 of the Travelers Acquisition Agreement. Except as contemplated by Section 2.7, without the prior written consent of the Reinsurer, which consent shall not be unreasonably withheld, the Company shall not amend, modify, waive or fail to enforce any term or provision of any of the Travelers Agreements, if such amendment, modification, waiver or failure to enforce could reasonably be expected to increase the liability of the Reinsurer hereunder.

(c) The Company shall use its commercially reasonable efforts to take, fully at the Reinsurer's expense, all actions necessary to maintain in full force and effect the Company's rights of indemnification under the Travelers Agreements. The Company shall refrain from taking any action that would reasonably be expected to limit or diminish Travelers' obligations thereunder; provided, however, that this paragraph shall not prohibit a Change of Control of the Reinsurer (as defined in the Travelers Acquisition Agreement).

21

---

#### ARTICLE XV

##### DISPUTE RESOLUTION

15.1. General Provisions. (a) Any dispute, controversy or claim arising out of or relating to this Agreement or the validity, interpretation, breach or termination thereof (a "Dispute"), shall be resolved in accordance with the procedures set forth in this Article XV, which shall be the sole and exclusive procedures for the resolution of any such Dispute unless otherwise specified below.

(b) Commencing with the request contemplated by Section 15.2, all communications between the parties or their representatives in connection with the attempted resolution of any Dispute, including any mediator's evaluation referred to in Section 15.3, shall be deemed to have been delivered in furtherance of a Dispute settlement and shall be exempt from discovery and production, and shall not be admissible in evidence for any reason (whether as an admission or otherwise), in any arbitral or other proceeding for the resolution of the Dispute.

(c) In connection with any Dispute, the parties expressly waive and forego any right to (i) punitive, exemplary, statutorily-enhanced or similar damages in excess of compensatory damages, and (ii) trial by jury.

(d) The specific procedures set forth below, including but not limited to the time limits referenced therein, may be modified by agreement of the parties in writing.

(e) All applicable statutes of limitations and defenses based upon the passage of time shall be tolled while the procedures specified in this Article XV are pending. The parties will take such action, if any, required to effectuate such tolling.

15.2. Consideration by Senior Executives. If a Dispute is not resolved in the normal course of business at the operational level, the parties shall attempt in good faith to resolve such Dispute by negotiation between executives who hold, at a minimum, the office of President and CEO of the respective business entities involved in such Dispute. Either party may initiate the executive negotiation process by providing a written notice to the other (the "Initial Notice"). Fifteen (15) days after delivery of the Initial Notice, the receiving party shall submit to the other a written response (the "Response"). The Initial Notice and the Response shall include (i) a statement of the Dispute and of each party's position, and (ii) the name and title of the executive who will represent that party and of any other person who will accompany the executive. Such executives will meet in person or by telephone within thirty (30) days of the date of the Initial Notice to seek a resolution of the Dispute.

15.3. Mediation. If a Dispute is not resolved by negotiation as provided in Section 15.2 within forty-five (45) days from the delivery of the Initial Notice, then either party may submit the Dispute for resolution by mediation pursuant to the CPR Institute for Dispute Resolution (the "CPR") Model Mediation Procedure as then in effect. The parties will select a mediator from the CPR Panels of Distinguished Neutrals, but such mediator must have prior U.S. reinsurance experience either as a lawyer or as a present or former officer or management

22

---

employee of a reinsurance company, but not of the Company, or the Reinsurer, or any of their respective affiliates. Either party at commencement of the mediation may ask the mediator to provide an evaluation of the Dispute and the parties' relative positions.

15.4. Arbitration. (a) If a Dispute is not resolved by mediation as provided in Section 15.3 within thirty (30) days of the selection of a mediator (unless the mediator chooses to withdraw sooner), either party may submit the Dispute to be finally resolved by arbitration pursuant to the CPR Rules for Non-Administered Arbitration as then in effect (the "CPR Arbitration Rules"). The parties consent to a single, consolidated arbitration for all known Disputes existing at the time of the arbitration and for which arbitration is permitted.

(b) The neutral organization for purposes of the CPR Arbitration Rules will be the CPR. The arbitral tribunal shall be composed of three arbitrators who are each experienced in the U.S. reinsurance business, of whom each party shall appoint one in accordance with the "screened" appointment procedure provided in Rule 5.4 of the CPR Arbitration Rules. The non-party appointed arbitrator must have prior U.S. reinsurance experience as a present or former officer or management employee of a reinsurance company, but not of the Company, or the Reinsurer, or any of their respective affiliates. The arbitration shall be conducted in New York City. Each party shall be permitted to present its case, witnesses and evidence, if any, in the presence of the other party. A written transcript of the proceedings shall be made and furnished to the parties. The arbitrators shall determine the Dispute in accordance with the law of New York, without giving effect to any conflict of law rules or other rules that might render such law inapplicable or unavailable, and shall apply this Agreement according to its terms, provided that the provisions relating to arbitration shall be governed by the Federal Arbitration Act, 9 U.S.C. §§ 1 et seq. The arbitral tribunal shall endeavor to render its award or order resulting from any arbitration within forty-five (45) days following the termination of the arbitration proceedings.

(c) The parties agree to be bound by any award or order resulting from any arbitration conducted hereunder and further agree that judgment on any award or order resulting from an arbitration conducted under this Section may be entered and enforced in any court having jurisdiction thereof.

(d) Except as expressly permitted by this Agreement, no party will commence or voluntarily participate in any court action or proceeding concerning a Dispute, except (i) for enforcement as contemplated by Section 15.4(c) above, (ii) to restrict or vacate an arbitral decision based on the grounds specified under applicable law, or (iii) for interim relief as provided in paragraph (e) below. For purposes of the foregoing the parties hereto submit to the non-exclusive jurisdiction of the courts of the State of New York.

(e) In addition to the authority otherwise conferred on the arbitral tribunal, the tribunal shall have the authority to make such orders for interim relief, including injunctive relief, as it may deem just and equitable. Notwithstanding paragraph (d) above, each party acknowledges that in the event of any actual or threatened breach of certain of the provisions of this Agreement, the remedy at law would not be adequate, and therefore injunctive or other interim relief may be sought immediately to restrain such breach. If the tribunal shall not have been appointed, either party may seek interim relief from a court having jurisdiction if the award to which the applicant may be entitled may be rendered ineffectual without such interim

23

---

relief. Upon appointment of the tribunal following any grant of interim relief by a court, the tribunal may affirm or disaffirm such relief, and the parties will seek modification or rescission of the court action as necessary to accord with the tribunal's decision.

(f) Each party will bear its own attorneys' fees and costs incurred in connection with the resolution of any Dispute in accordance with this Article XV.

## ARTICLE XVI

### PRIVACY REQUIREMENTS

16.1. Privacy Requirements. In providing the administrative services provided for under this Agreement, and in connection with maintaining, administering, handling and transferring the data of the policyholders and other recipients of benefits under the Reinsured Policies, the Company shall, and shall cause its Affiliates and any permitted subcontractor to, comply with all confidentiality and security obligations applicable to them in connection with the collection, use, disclosure, maintenance and transmission of personal, private, health or financial information about individual policyholders or benefit recipients, including the provisions of privacy policies under which such information was gathered, those laws currently in place and which may become effective during the term of this Agreement, including the Gramm-Leach-Bliley Act, the Health Insurance Portability and Accountability Act of 1996 and any other Applicable Laws. The Company shall entitle the Reinsurer and its agents and representatives, the Commissioner of Health and Human Services and such other Governmental Authorities, to the extent required by Applicable Law, to audit the Company's compliance herewith. The Company shall also enable individual subjects of personally identifiable information, upon request from such individuals, to review and correct information maintained by the Company about them, and to restrict use of such information. The Company shall promptly report to the Reinsurer any violation of this provision of which the Company becomes aware. Unless required by Applicable Law, the Company shall not during the term of this Agreement, modify the privacy policies under which information utilized by the Company in administering the Reinsured Policies is gathered, without the Reinsurer's prior written consent, which consent shall not be unreasonably withheld. The parties hereto agree to comply with the terms of the Business Associate Addendum attached hereto.

## ARTICLE XVII

### MISCELLANEOUS PROVISIONS

17.1. Headings and Schedules. Headings used herein are not a part of this Agreement and shall not affect the terms hereof. The attached Schedules are a part of this Agreement.

17.2. Notices. All notices, requests, demands and other communications under this Agreement must be in writing and will be deemed to have been duly given or made as follows: (a) if sent by registered or certified mail in the United States return receipt requested, upon receipt; (b) if sent by reputable overnight air courier, two business days after mailing; (c) if

24

sent by facsimile transmission, with a copy mailed on the same day in the manner provided in (a) or (b) above, when transmitted and receipt is confirmed by telephone; or (d) if otherwise actually personally delivered, when delivered, and shall be delivered as follows:

If to the Company:

GE Capital Life Assurance Company of New York  
6610 West Broad Street  
Richmond, VA 23230  
Facsimile: (804) 281-6165  
Attention: Chief Executive Officer

With a copy to:

GE Capital Life Assurance Company of New York  
6610 West Broad Street  
Richmond, VA 23230  
Facsimile: (804) 281-6005  
Attention: General Counsel

If to the Reinsurer:

Union Fidelity Life Insurance Company  
200 North Martingale Road  
Schaumburg, IL 60173-2096  
Facsimile: (847) 330-3404  
Attention: Chief Financial Officer

With a copy to:

Union Fidelity Life Insurance Company  
200 North Martingale Road  
Schaumburg, IL 60173-2096  
Facsimile: (847) 605-3044  
Attention: General Counsel

or to such other address or to such other Person as either party may have last designated by notice to the other party.

17.3. Successors and Assigns. This Agreement shall be binding upon and inure to the benefit of the parties hereto and their respective successors, permitted assigns and legal representatives. Neither this Agreement, nor any right or obligation hereunder, may be assigned by any party without the prior written consent of the other party hereto. Any assignment in violation of this Section 17.3 shall be void and shall have no force and effect. Nothing in this Section 17.3 shall be construed to prohibit the Reinsurer from retroceding all or any portion of the business reinsured hereunder.

25

---

17.4. Execution in Counterpart. This Agreement may be executed by the parties hereto in any number of counterparts, and by each of the parties hereto in separate counterparts, each of which counterparts, when so executed and delivered, shall be deemed to be an original, but all such counterparts shall together constitute but one and the same instrument.

17.5. Currency. Whenever the word "Dollars" or the "\$" sign appear in this Agreement, they shall be construed to mean United States Dollars, and all transactions under this Agreement shall be in United States Dollars.

17.6. Amendments. This Agreement may not be changed, altered or modified unless the same shall be in writing executed by the Company and the Reinsurer.

17.7. Governing Law. This Agreement will be construed, performed and enforced in accordance with the laws of the State of New York without giving effect to its principles or rules of conflict of laws thereof to the extent such principles or rules would require or permit the application of the laws of another jurisdiction.

17.8. Entire Agreement; Severability. (a) This Agreement and the Termination Letter Agreement constitute the entire agreement between the parties hereto relating to the subject matter hereof and supersede all prior and contemporaneous agreements, understandings, statements, representations and warranties, negotiations and discussions, whether oral or written, of the parties and there are no general or specific warranties, representations or other agreements by or among the parties in connection with the entering into of this Agreement or the subject matter hereof except as specifically set forth or contemplated herein or in the Termination Letter Agreement.

(b) If any provision of this Agreement is held to be void, unenforceable or in violation of any provision of the Travelers Agreements, in whole or in part, (i) such holding or provision shall not affect the validity and enforceability of the remainder of this Agreement, including any other provision, paragraph or subparagraph, and (ii) the parties agree to attempt in good faith to reform such void, unenforceable or violative provision to the extent necessary to render such provision enforceable and to carry out its original intent.

17.9. Contemporaneous Agreements. Concurrent with the execution of this Agreement, the parties and/or their Affiliates are also entering into the Capital Maintenance Agreement, the RBC Reporting Letter Agreement and the Assignment Letter Agreement.

17.10. No Waiver; Preservation of Remedies. No consent or waiver, express or implied, by any party to or of any breach or default by any other party in the performance by such other party of its obligations hereunder shall be deemed or construed to be a consent or waiver to or of any other breach or default in the performance of obligations hereunder by such other party hereunder. Failure on the part of any party to complain of any act or failure to act of any other party or to declare any other party in default, irrespective of how long such failure continues, shall not constitute a waiver by such first party of any of its rights hereunder. The rights and remedies provided are cumulative and are not exclusive of any rights or remedies that any party may otherwise have at law or equity.

26

---

17.11. Cooperation. Each party hereto shall cooperate fully with the other in all reasonable respects in order to accomplish the objectives of this Agreement including making available to each their respective officers and employees for interviews and meetings with Governmental Authorities and furnishing any additional assistance, information and documents as may be reasonably requested by a party from time to time.

17.12. Third Party Beneficiary. Nothing in this Agreement will confer any rights upon any Person that is not a party or a successor or permitted assignee of a party to this Agreement.

17.13. Tax Exception to Any Confidentiality. Notwithstanding anything to the contrary set forth herein or in any other agreement to which the parties hereto are parties or by which they are bound, any obligations of confidentiality contained herein and therein, as they relate to the transactions, shall not apply to the federal tax structure or federal tax treatment of the transactions, and each party hereto (and any employee, representative, or agent of any party hereto) may disclose to any and all persons, without limitation of any kind, the federal tax structure and federal tax treatment of the transactions. The preceding sentence is intended to cause the transactions to be treated as not having been offered under conditions of confidentiality for purposes of Section 1.6011-4(b)(3) (or any successor provision) of the Treasury Regulations promulgated under Section 6011 of the Internal Revenue Code of 1986, as amended, and shall be construed in a manner consistent with such purpose. In addition, each party hereto acknowledges that it has no proprietary or exclusive rights to the federal tax structure of the transactions or any federal tax matter or federal tax idea related to the transactions.

17.14. Interpretation. Wherever the words “include,” “includes” or “including” are used in this Agreement, they shall be deemed to be followed by the words “without limitation.”

17.15. Survival. Article XV and Article XVII shall survive the termination of this Agreement.

IN WITNESS WHEREOF, the parties hereto have caused this Agreement to be executed by their duly authorized representatives.

GE CAPITAL LIFE ASSURANCE COMPANY  
OF NEW YORK

By /s/ VICTOR C. MOSES  
Name: Victor C. Moses  
Title: Senior Vice President

UNION FIDELITY LIFE INSURANCE COMPANY

By /s/ GLENN JOPPA  
Name: Glenn Joppa  
Title: Senior Vice President and Secretary









SCHEDULE A

POLICY FORMS

LTC1 (1990-92)  
LTC2 Qualified (1990-99)  
LTC2 Non-Qualified (1990-99)  
LTC3+ Qualified Comprehensive (1993-2001)  
LTC3+ Non-Qualified Comprehensive (1993-2001)  
LTC3+ Non-Qualified Facility (1993-1999)  
LC3 Qualified (1993-99)  
LC3 Non-Qualified (1993-99)  
LTC4 Qualified Comprehensive (1997-2001)  
LTC4 Qualified Facility (1997-1999)  
LC4





FORM OF ADMINISTRATIVE SERVICES AGREEMENT

LTC UFLIC/GECLANY

ADMINISTRATIVE SERVICES AGREEMENT

by and between

GE CAPITAL LIFE ASSURANCE COMPANY OF NEW YORK

and

UNION FIDELITY LIFE INSURANCE COMPANY

Effective as of [       ]

ADMINISTRATIVE SERVICES AGREEMENT

This ADMINISTRATIVE SERVICES AGREEMENT (this "Agreement"), effective as of [       ] (the "Effective Date"), is entered into by and between GE CAPITAL LIFE ASSURANCE COMPANY OF NEW YORK, an insurance company organized under the laws of the State of New York (the "Company"), and UNION FIDELITY LIFE INSURANCE COMPANY, an insurance company organized under the laws of the State of Illinois (the "Administrator").

**RECITALS:**

WHEREAS, the Company and the Administrator have entered into a Retrocession Agreement dated as of April 15, 2004 (the "Retrocession Agreement") which provides for the parties to enter into this Agreement;

WHEREAS, pursuant to the Retrocession Agreement, the Administrator has agreed to indemnify the Company for, among other things, 100% of Ultimate Net Loss incurred by the Company and unpaid as of the Inception Date with respect to the Novated Policies (capitalized terms used herein and not defined herein, unless otherwise indicated, have the respective meanings assigned to them in the Retrocession Agreement); and

WHEREAS, the Company wishes to appoint the Administrator to provide policyholder and claim servicing with respect to the Novated Policies as set forth herein, and the Administrator desires to provide such administrative services;

NOW, THEREFORE, in consideration of the covenants and agreements set forth herein, the parties hereto agree as follows:

ARTICLE I

AUTHORITY

As between the Company and the Administrator, the Company hereby appoints the Administrator, and the Administrator hereby accepts appointment, to provide as an independent contractor of the Company, from and after the Effective Date, all of the policyholder and claim servicing services necessary or appropriate with respect to the Novated Policies including those set forth in this Agreement (the "Administrative Services"), all on the terms as set forth in this Agreement. In providing the policyholder and claim servicing with respect to the Novated Policies, the Administrator shall handle all such matters, including but not limited to the billing and collection of premiums and the defense, adjustment, settlement and payment of all claims arising under the Novated Policies, as more fully described below. Notwithstanding any other provision of this Agreement to the contrary, the Company shall have the final right to direct the Administrator in the performance of the Administrative Services in accordance with the standards for services set forth in Section 2.1, including the right to direct the Administrator to perform any action necessary for the Novated Policies or the policyholder and claim servicing thereof to comply with Applicable Law, or to cease performing any action that constitutes a

violation of Applicable Law. All services hereunder shall be performed by the Administrator in the name of and on behalf of the Company. The Administrator shall maintain a toll-free number for use by policyholders, certificateholders and beneficiaries. Any and all correspondence with policyholders, certificateholders and beneficiaries and check stock utilized by the Administrator for payments under the Reinsured Policies shall be in the name of the Company or in the name of the Administrator and disclosing that the Administrator is acting as the administrative agent of the Company.

## ARTICLE II

### STANDARD FOR SERVICES; FACILITIES; SUBCONTRACTING; POLICYHOLDER SERVICING

2.1. Standard for Services. The Administrator shall provide policyholder and claims servicing with respect to the Novated Policies in good faith and with the care, skill, prudence and diligence of a person experienced in administering long term care insurance business. Without limiting the generality of the foregoing, the Administrator shall provide policyholder and claims servicing with respect to the Novated Policies (i) in accordance with the terms of the Novated Policies, (ii) in accordance with the applicable terms of this Agreement, (iii) in compliance with Applicable Law, (iv) in accordance with industry standards, (v) in accordance with standards of service as agreed to by the Administrator and the Company and, subject to the foregoing, (vi) to the extent applicable, in the same manner as it conducts its own business not subject to this Agreement.

2.2. Facilities and Personnel. To the extent not sub-contracted to a Subcontractor, the Administrator shall at all times maintain sufficient facilities and trained personnel of the kind necessary to perform its obligations under this Agreement in accordance with the performance standards set forth herein.

2.3. Subcontracting. The Administrator may subcontract for the performance of any policyholder or claims servicing service or services with respect to the Novated Policies to (i) an Affiliate or (ii) any other Person with the prior written consent of the Company, such consent not to be unreasonably withheld (in each case, the "Subcontractor"); provided, that, no such subcontracting shall relieve the Administrator from any of its obligations or liabilities hereunder, and the Administrator shall remain responsible for all obligations or liabilities of such Subcontractor with regards to the providing of such service or services as if provided by the Administrator.

2.4. Policyholder Servicing. The Administrator shall provide policyholder servicing with regards to the Novated Policies, including changes of address, responding to policyholder inquiries and similar services.

2

---

## ARTICLE III

### CLAIMS HANDLING

The Administrative Services with respect to claims for benefits including claims outstanding on the Effective Date, shall include the following:

3.1. Claim Administration Services. The Administrator shall acknowledge, consider, review, investigate, deny, settle, pay or otherwise dispose of each claim for benefits reported under each Novated Policy (each, a "Claim" and collectively the "Claims") in accordance with procedures and guidelines established by the Company, such procedures and guidelines to be in accordance with the standards of service set forth in Section 2.1.

3.2. Description of Claim Administration Services. Without limiting the foregoing, the Administrator shall:

- (i) provide claimants under the Novated Policy and their authorized representatives (collectively, "Claimants") with Claim forms and provide reasonable explanatory guidance to Claimants in connection therewith;
- (ii) establish, maintain and organize Claim files and maintain and organize other Claims-related records;
- (iii) review all Claims and determine whether the Claimant is eligible for benefits and if so, the nature and extent of such benefits;
- (iv) prepare and distribute to the appropriate recipients any reports required by Applicable Law;
- (v) respond to all written or oral Claims-related communications that the Administrator reasonably believes to require a response; and
- (vi) maintain a complaint log with respect to the Novated Policies in accordance with applicable requirements of Governmental Authorities and provide a copy of such log, continuously updated through the last day of each calendar quarter during the term of this Agreement, to the Company on or before the tenth Business Day of each calendar quarter covering changes during the preceding calendar quarter.

## ARTICLE IV

### REGULATORY AND LEGAL PROCEEDINGS

4.1. Regulatory Complaints and Proceedings. The Administrator shall:

- (i) respond to any Claims payment related complaints or inquiries made by any Governmental Authority, within the Governmental Authority's

3

---

requested time frame for response or, if no such time frame is provided, within the time frame as allowed by Applicable Law; and promptly provide a copy of such response to the Company; b

- (ii) promptly notify the Company of any non-Claims payment related complaints or inquiries initiated by a Governmental Authority, and of any proceedings (either Claims or non-Claims related) initiated by a Governmental Authority, and, in either case, prepare and send to the Governmental Authority, with a copy to the Company, a response within the Governmental Authority's requested time frame for response or, if no such time frame is provided, within the time frame as allowed by Applicable Law; provided, that, subject to meeting such time frames, the Administrator shall provide such response to the Company for its prior review and comment;
- (iii) subject to Section 4.4, supervise and control the investigation, contest, defense and/or settlement of all complaints, inquiries and proceedings by Governmental Authorities at its own cost and expense, and in the name of the Company when necessary; and
- (iv) at the Company's request, provide to the Company a report in a form mutually agreed by the parties summarizing the nature of any complaints, inquiries or proceedings by Governmental Authorities, the alleged actions or omissions giving rise to such complaints, inquiries or proceedings and copies of any files or other documents that the Company may reasonably request in connection with its review of these matters.

Notwithstanding the foregoing, the Company shall retain final authority for the resolution of inquiries by Governmental Authorities and consumer complaints; provided, however, the Company agrees to act reasonably in the exercise of such authority.

4.2. Legal Proceedings. The Administrator shall:

- (i) notify the Company promptly of any lawsuit, action, arbitration or other dispute resolution proceedings that are instituted or threatened with respect to any matter

relating to the Novated Policies (“Legal Proceeding(s)”), and in no event more than five (5) Business Days after receipt of notice thereof;

- (ii) subject to Section 4.4, supervise and control the investigation, contest, defense and/or settlement of all Legal Proceedings at its own cost and expense, and in the name of the Company when necessary; and
- (iii) keep the Company fully informed of the progress of all Legal Proceedings handled by the Administrator in which the Company is named a party and, at the Company’s request, provide to the Company a report summarizing the nature of any Legal Proceedings, the alleged actions or omissions

4

---

giving rise to such Legal Proceedings and copies of any files or other documents that the Company may reasonably request in connection with its review of these matters in each case other than such files, documents and other information as would, in the judgment of counsel to the Administrator, lead to the loss or waiver of legal privilege.

4.3. Notice to Administrator. The Company shall give prompt notice to the Administrator of any Legal Proceeding made or brought against the Company after the Inception Date arising under or in connection with the Novated Policies to the extent known to it and not made against or served on the Administrator or a Subcontractor as administrator hereunder, and in no event more than five (5) Business Days after receipt of notice thereof, and shall promptly furnish to the Administrator copies of all pleadings in connection therewith. The Administrator shall assume the defense of the Company.

4.4. Defense of Regulatory and Legal Proceedings. Notwithstanding anything in this Agreement to the contrary, the Company shall have the right to engage in its own separate legal representation, at its own expense, and to participate fully in the defense of any Legal Proceedings or complaints, inquiries or proceedings by Governmental Authorities with respect to the Novated Policies in which the Company is a named party without waiving any right to indemnification it may have under Article XVI hereof. The Administrator and the Company shall cooperate with each other with respect to the administration of any Legal Proceeding and any complaint, inquiry or proceeding by Governmental Authorities. The Administrator shall not settle any Legal Proceeding or any complaint, inquiry or proceeding by Governmental Authorities without the Company’s prior written consent (which consent shall not be unreasonably withheld or delayed) unless (i) there is no finding or admission of any violation of law or any violation of the rights of any Person, (ii) such settlement would not reasonably be expected to have material adverse precedential consequences to the Company and (iii) the sole relief provided is monetary damages that are paid in full by the Administrator.

## ARTICLE V

### NOTIFICATION TO POLICYHOLDERS

The Administrator agrees to send to policyholders of the Novated Policies a written notice prepared by the Administrator, reasonably acceptable to the Company and approved by the New York Insurance Department to the effect that the Administrator, or such other Person designated by the Administrator in accordance with the terms of this Agreement, has been appointed by the Company to provide Administrative Services. The Administrator shall send such notice by first class U.S. mail at a time reasonably acceptable to the Company and the Administrator and in all events in accordance with Applicable Law. The parties intend to minimize the cost associated with any notification under this Article V, including by means of inclusion of the notice in a regularly scheduled mailing to policyholders in lieu of a separate mailing. The cost associated with such notification under this Article V (upon the initial assumption of the administration of the Novated Policies under Section 3.9 of the Retrocession Agreement) shall be a transition cost payable by the Administrator or the Company in accordance with Section 3.9(a) or 3.9(c) of the Retrocession Agreement, as applicable.

5

---

## ARTICLE VI

### BILLINGS AND COLLECTIONS: RE-RATING OF NOVATED POLICIES

6.1. Billing and Collection Services. The Administrator shall assume all responsibility for billing and collecting premiums and other amounts payable with respect to the Novated Policies from and after the Effective Date. The Company shall promptly remit to the Administrator any such amounts received by it with respect to the Novated Policies.

6.2. Re-rating of Novated Policies. Subject to compliance with Applicable Law and this Section 6.2, the Administrator shall have the exclusive right, on behalf of the Company, to increase or decrease the premium rates under the Novated Policies from and after the Effective Date without the consent of the Company. The Administrator may not seek or implement, as applicable, a premium rate increase unless such premium rate increase would have been permitted under the terms of Section 3.2(i) of the Travelers Servicing Agreement assuming such Novated Policies continued to be “Reinsured Contracts” as defined under the Travelers Servicing Agreement. Notwithstanding the foregoing, the Administrator may not seek or implement, as applicable, more than one (1) premium rate increase with respect to the Novated Policies in any state in any period of three (3) calendar years. The Administrator shall bear, and shall indemnify the Company for, all costs and liabilities incurred in or arising out of seeking or effecting any premium rate changes at the direction of the Administrator.

## ARTICLE VII

### QUARTERLY PREMIUM TAX AND INSOLVENCY FUND ACCOUNTINGS

7.1. Quarterly Accountings. Within thirty (30) days after the end of each calendar quarter that this Agreement is in effect (or more frequently as mutually agreed by the parties), the Company shall submit to the Administrator a written statement of accounting in a form and containing such information to be agreed upon by the parties hereto (each, an “Insolvency Fund Quarterly Accounting”) setting forth the Insolvency Fund amounts assessed or payable to the extent that such assessments constitute Reinsured Risks with respect to the Novated Policies (collectively, the “Post-Effective Date Assessments”). Within thirty (30) days after the last day of each calendar quarter that this Agreement is in effect (or more frequently as mutually agreed by the parties), the Administrator shall submit to the Company a written statement of accounting in a form and containing such information to be agreed upon by the parties hereto (each, a “Quarterly Premium Tax Accounting”, and together with the Insolvency Fund Quarterly Accountings, the “Quarterly Accountings”) setting forth the estimated premium taxes due with respect to the Novated Policies as a result of premiums collected during such quarter. Concurrent with the delivery of each Quarterly Premium Tax Accounting, the Administrator shall remit to the Company the amount set forth on such Quarterly Premium Tax Accounting with respect to such estimated premium taxes due and the amount set forth in such Insolvency Fund Quarterly Accounting with respect to the Post-Effective Date Assessments, and any other amounts owed to the Company pursuant to this Agreement; provided, however, that any Post-Effective Date Assessments set forth in an Insolvency Fund Quarterly Accounting received by the Administrator less than five (5) Business Days prior to the Administrator’s

6

---

delivery of such Quarterly Premium Tax Accounting will be paid within ten (10) Business Days of receipt by the Administrator of such Insolvency Fund Quarterly Accounting. Each of the parties agrees to supply to the other a copy of all supporting data used in preparing the Quarterly Accountings prepared by such party.

7.2. Adjustments Regarding Quarterly Accountings. In the event that subsequent data or calculations require revision of any of the Quarterly Accountings, the required revision and appropriate payments thereunder shall be made within ten (10) Business Days after the parties hereto mutually agree as to the appropriate revision.

ARTICLE VIII

CERTAIN ACTIONS BY COMPANY

8.1. Filings. The Company shall prepare and timely file any filings required to be made with any Governmental Authority that relate to the Company generally and not just to the Novated Policies, including filings with guaranty associations and filings and premium tax returns with taxing authorities. The Administrator shall, in a timely fashion in light of the dates such filings by the Company are required, provide to the Company all information in the possession of the Administrator with respect to the Novated Policies that may be reasonably required for the Company to prepare such filings and tax returns.

8.2. Annual Adjustment. The Company shall pay or provide to the Administrator the benefit of any Post-Effective Date Assessments which have been or can be applied to reduce the Company's premium tax liability ("Premium Tax Credits"). The Company shall provide to the Administrator by March 15 of each year a statement of the amount (the "Annual Adjustment") of (i) premium taxes due with respect to premiums collected during the prior calendar year (to the extent that such premium taxes constitute Reinsured Risks with respect to the Novated Policies), less (ii) estimated premium taxes paid by the Administrator to the Company with respect to such premiums under the provisions of Article VII, less (iii) Premium Tax Credits for the prior calendar year. By March 30 of each year the Administrator shall pay to the Company the Annual Adjustment, if a positive amount, and the Company will pay or credit to the Administrator the Annual Adjustment, if a negative amount.

ARTICLE IX

REGULATORY MATTERS AND AUDIT REPORTING

9.1. Regulatory Compliance and Reporting. The Administrator shall provide to the Company such information with respect to the Novated Policies as is required to satisfy all current and future informational reporting, prior approval and any other requirements imposed by any Governmental Authority. Upon the reasonable request of the Company, the Administrator shall timely prepare such reports and summaries, including statistical summaries, as are necessary or reasonably required to satisfy any requirements imposed by a Governmental Authority upon the Company with respect to the Novated Policies. In addition, the Administrator, upon the reasonable request of the Company, shall promptly provide to the

7

---

Company copies of all existing records relating to the Novated Policies (including, with respect to records maintained in machine readable form, hard copies) that are necessary to satisfy such requirements. All copies of records furnished in the ordinary course of business shall be furnished by the Administrator at the Administrator's cost. Any extraordinary costs reasonably incurred by the Administrator in response to requests from the Company shall be reimbursed by the Company. Among other responsibilities:

- (i) The Administrator shall promptly prepare and furnish to Governmental Authorities all reports and related summaries (including, without limitation, statistical summaries), certificates of compliance and other reports required or requested by a Governmental Authority.
- (ii) The Administrator shall assist the Company and cooperate with the Company in doing all things necessary, proper or advisable, in the most expeditious manner practicable in connection with any and all market conduct or other Governmental Authority examinations relating to the Novated Policies.

9.2. Reporting and Accounting. The Administrator shall assume the reporting and accounting obligations set forth below:

- (i) As soon as practicable but not more than thirty (30) days after the end of each Accounting Period (or more frequently as mutually agreed by the parties), the Administrator shall timely provide to the Company the Monthly Settlement Reports. As soon as practicable but not more than forty (40) days after the end of each calendar quarter that this Agreement is in effect (or more frequently as mutually agreed by the parties), the Administrator shall timely provide to the Company the Quarterly Settlement Reports. As soon as practicable but not more than forty-five (45) days after the end of each calendar year that this Agreement is in effect, the Administrator shall timely provide to the Company the Annual Reports. In addition, as soon as practicable but not more than forty (40) days after the end of each calendar quarter that this Agreement is in effect (or more frequently as mutually agree by the parties), the Administrator shall timely provide to the Company such other reports and summaries of transactions (and, upon request of the Company, detailed supporting records) related to the Novated Policies as may be reasonably required for use in connection with the preparation of the Company's statutory and GAAP financial statements, tax returns and other required financial reports and to comply with the requirements of the regulatory authorities having jurisdiction over the Company, including all premium written and earned and all Losses and Allocated Loss Adjustment Expenses reserved, paid, and outstanding. The parties shall cooperate in good faith to establish the manner for the providing of such reports.
- (ii) The Administrator shall provide to the Company such reports or summaries (and, upon the request of the Company, detailed supporting

8

---

records therefor) related to the payment of commissions under the Novated Policies as agreed by the parties.

- (iii) As soon as practicable but not more than forty (40) days after the end of each calendar quarter that this Agreement is in effect (or more frequently as mutually agreed by the parties), the Administrator shall report to the Company the amount of statutory reserves that the Company is required to maintain in connection with the Reinsured Risks with respect to the Novated Policies as of the quarter end.
- (iv) The Administrator shall promptly provide notice to the Company of any changes in the reserve methodology used by the Administrator in calculating statutory reserves for the Novated Policies.
- (v) Within forty-five (45) days after each calendar year end (or such longer time as may be agreed by the parties) that this Agreement is in effect, the Administrator shall provide to the Company (a) an opinion of an actuary reasonably acceptable to the Company as to the adequacy of statutory reserves for the Novated Policies, prepared according to accepted actuarial standards of practice, and as otherwise required for regulatory reporting purposes and (b) an analysis which reasonably supports such opinion.

9.3. Additional Reports and Updates. For so long as this Agreement remains in effect, each party shall periodically furnish to the other such other reports and information as may be reasonably required by such other party for regulatory, tax or similar purposes and reasonably available to it.

ARTICLE X

MISCELLANEOUS ADMINISTRATIVE SERVICES

The Administrator shall assume the obligations set forth below:

- (i) The Administrator shall timely pay to the policyholders, including any certificateholder thereunder, any refunds of any kind due under the Novated Policies.
- (ii) The Administrator shall process all policy changes, lapses, cancellations, and reinstatements in accordance with the terms of this Agreement and the express terms of the Novated Policies and shall assume responsibility for providing all other policyholder servicing in connection with the Novated Policies.

(iii) The Administrator shall pay commissions due under the Novated Policies.

(iv) The Administrator shall provide such Administrative Services as are not performed by or on behalf of Company on the date hereof but the need for which may arise due to changes or developments in Applicable Law.

ARTICLE XI

BOOKS AND RECORDS

The Administrator shall keep accurate and complete records, files and accounts of all transactions and matters with respect to the Novated Policies and the administration thereof in accordance with Applicable Law, including New York Regulation 152, and its record management practices in effect from time to time for the Administrator's insurance business not covered by this Agreement, if any. All such records pertaining to the Novated Policies shall be the property of the Company, provided that the Administrator shall at all times have the right to retain a copy of such books and records. The parties to this Agreement and their designated representatives may upon reasonable notice inspect, at the offices of the Administrator or the Company where such records are located, the papers and any and all other books or documents of the Administrator or the Company reasonably relating to this Agreement, including the Novated Policies, and shall have access to appropriate employees and representatives of the other party, in each case during normal business hours for such period as this Agreement is in effect or for as long thereafter as any rights or obligations of any party survives or the Administrator or the Company reasonably need access to such records for regulatory, tax or similar purposes. The information obtained shall be used only for purposes relating to the transactions contemplated under this Agreement.

ARTICLE XII

COOPERATION

Each party hereto shall cooperate fully with the other in all reasonable respects in order to accomplish the objectives of this Agreement including making available to each their respective officers and employees for interviews and meetings with Governmental Authorities and furnishing any additional assistance, information and documents as may be reasonably requested by a party from time to time.

ARTICLE XIII

PRIVACY REQUIREMENTS

In providing the Administrative Services provided for under this Agreement, and in connection with maintaining, administering, handling and transferring the data of the policyholders and other recipients of benefits under the Novated Policies, the Administrator shall, and shall cause its Affiliates and any permitted Subcontractors to, comply with all confidentiality and security obligations applicable to them in connection with the collection, use, disclosure, maintenance and transmission of personal, private, health or financial information

about individual policyholders or benefit recipients, including the provisions of privacy policies under which such information was gathered, those laws currently in place and which may become effective during the term of this Agreement, including the Gramm-Leach-Bliley Act, the Health Insurance Portability and Accountability Act of 1996 and any other Applicable Laws. The Administrator shall entitle the Company and its agents and representatives, the Commissioner of Health and Human Services and such other Governmental Authorities, to the extent required by Applicable Law, to audit the Administrator's compliance herewith. The Administrator shall also enable individual subjects of personally identifiable information, upon request from such individuals, to review and correct information maintained by the Administrator about them, and to restrict use of such information. The Administrator shall promptly report to the Company any violation of this provision of which the Administrator becomes aware. Unless required by Applicable Law, the Administrator shall not during the term of this Agreement, modify the privacy policies under which information utilized by the Administrator in administering the Novated Policies is gathered, without the Company's prior written consent, which consent shall not be unreasonably withheld. The parties agree to comply with the terms of the Business Associate Addendum attached hereto or such other written agreement as may be required by Applicable Law on the date hereof.

ARTICLE XIV

CONSIDERATION FOR ADMINISTRATIVE SERVICES

Apart from the performance by the Company of its obligations under the Retrocession Agreement, there shall be no fee or other consideration due to the Administrator for performance of the Administrative Services under this Agreement.

ARTICLE XV

BANK ACCOUNT: USE OF COMPANY LETTERHEAD

When and on terms reasonably requested by the Administrator, the Company shall open, modify or close, and make available for use by the Administrator for the payment of amounts to be paid by the Administrator hereunder one or more bank accounts of the Company and check stock of the Company. The Administrator shall maintain such account(s) and pay all applicable bank fees and check stock costs. The Company shall adopt such resolutions and execute such documents as required to designate senior officers of the Administrator (by title) as signatories on such account(s) and authorize the Administrator to certify to such bank(s), from time to time, the names of such officers. The Company shall also make available to the Administrator, at the sole expense of the Administrator, such letterhead, printed forms and other documents of the Company as may be reasonably required by the Administrator in performing services hereunder. Upon termination of this Agreement, the Administrator shall promptly return to the Company all such unused check stock, letterhead, printed forms and other documents held by it in connection with this Agreement as provided under this Article XV.

ARTICLE XVI

INDEMNIFICATION

Any claim for or with respect to indemnification arising out of, or relating to, this Agreement or the Administrative Services hereunder shall be permitted under and governed by the



provisions of Article V of the Master Agreement, dated as of [ ], 2004, among General Electric Company, General Electric Capital Corporation, GEI, Inc., GE Financial Assurance Holdings, Inc. and Genworth Financial, Inc (the "Master Agreement"), to the extent such provisions are applicable, as if this Agreement were a Transaction Document under the Master Agreement.

## ARTICLE XVII

### DURATION; TERMINATION

17.1. Duration. This Agreement shall commence on the Effective Date and continue with respect to each Novated Policy until no further Administrative Services in respect of such Novated Policy is required, unless this Agreement is earlier terminated under Section 17.2.

17.2. Termination. (a) This Agreement is subject to immediate termination at the option of the Company, upon written notice to the Administrator, on the occurrence of any of the following events:

- (i) A voluntary or involuntary proceeding is commenced in any jurisdiction by or against the Administrator for the purpose of conserving, rehabilitating or liquidating the Administrator;
- (ii) There is a material breach by the Administrator of any material term or condition of this Agreement that is not cured by the Administrator within thirty (30) days after receipt of written notice from the Company of such breach or act (provided that the Company shall not have the right to terminate this Agreement (A) for so long as the Administrator is making a good faith effort to cure such breach, not to exceed an additional one hundred eighty (180) days or (B) during the pendency of any dispute resolution proceedings as set forth in Article XVIII regarding an alleged material breach); or
- (iii) The Administrator is unable to perform the services required under this Agreement for a period of thirty (30) consecutive days for any reason other than as a result of a Force Majeure, it being understood that nothing in this Section 17.2(a)(iii) shall relieve the Administrator from its administrative responsibilities under this Agreement. For purposes of this Agreement, "Force Majeure" means any acts or omissions of any civil or military authority, acts of God, acts or omissions of the Company, fires, strikes or other labor disturbances, equipment failures, fluctuations or non-

12

---

availability of electrical power, heat, light, air conditioning or telecommunications equipment, or any other act, omission or occurrence beyond the Administrator's reasonable control, irrespective of whether similar to the foregoing enumerated acts, omissions or occurrences.

(b) This Agreement may be terminated at any time upon the mutual written consent of the parties hereto, which writing shall state the effective date of termination.

(c) In the event that this Agreement is terminated under any of the provisions of Section 17.2(a), the Administrator shall select a third-party administrator to perform the services required by this Agreement. The Company shall have the right to approve any such administrator selected by the Administrator, but such approval will not unreasonably be withheld or delayed. If the Administrator fails to select an administrator pursuant to this Section 17.2(c), the Company shall select such an administrator. In either case, the Administrator shall pay all fees and charges imposed by the selected administrator and shall bear all transition costs associated with the transition of the performance of the services required under this Agreement to such administrator, including the expense of sending policyholder notices as provided in Article V.

## ARTICLE XVIII

### DISPUTE RESOLUTION

18.1. General Provisions. (a) Any dispute, controversy or claim arising out of or relating to this Agreement or the validity, interpretation, breach or termination thereof (a "Dispute"), shall be resolved in accordance with the procedures set forth in this Article XVIII, which shall be the sole and exclusive procedures for the resolution of any such Dispute unless otherwise specified below.

(b) Commencing with the request contemplated by Section 18.2, all communications between the parties or their representatives in connection with the attempted resolution of any Dispute, including any mediator's evaluation referred to in Section 18.3, shall be deemed to have been delivered in furtherance of a Dispute settlement and shall be exempt from discovery and production, and shall not be admissible in evidence for any reason (whether as an admission or otherwise), in any arbitral or other proceeding for the resolution of the Dispute.

(c) In connection with any Dispute, the parties expressly waive and forego any right to (i) punitive, exemplary, statutorily-enhanced or similar damages in excess of compensatory damages (provided that any such liability with respect to a Third Party Claim (as defined in the Master Agreement) shall be considered direct damages), and (ii) trial by jury.

(d) The specific procedures set forth below, including but not limited to the time limits referenced therein, may be modified by agreement of the parties in writing.

13

---

(e) All applicable statutes of limitations and defenses based upon the passage of time shall be tolled while the procedures specified in this Article XVIII are pending. The parties will take such action, if any, required to effectuate such tolling.

18.2. Consideration by Senior Executives. If a Dispute is not resolved in the normal course of business at the operational level, the parties shall attempt in good faith to resolve such Dispute by negotiation between executives who hold, at a minimum, the office of President and CEO of the respective business entities involved in such Dispute. Either party may initiate the executive negotiation process by providing a written notice to the other (the "Initial Notice"). Fifteen (15) days after delivery of the Initial Notice, the receiving party shall submit to the other a written response (the "Response"). The Initial Notice and the Response shall include (i) a statement of the Dispute and of each party's position, and (ii) the name and title of the executive who will represent that party and of any other person who will accompany the executive. Such executives will meet in person or by telephone within thirty (30) days of the date of the Initial Notice to seek a resolution of the Dispute.

18.3. Mediation. If a Dispute is not resolved by negotiation as provided in Section 18.2 within forty-five (45) days from the delivery of the Initial Notice, then either party may submit the Dispute for resolution by mediation pursuant to the CPR Institute for Dispute Resolution (the "CPR") Model Mediation Procedure as then in effect. The parties will select a mediator from the CPR Panels of Distinguished Neutrals, but such mediator must have prior U.S. reinsurance experience either as a lawyer or as a present or former officer or management employee of a reinsurance company, but not of the Company, or the Administrator, or any of their respective affiliates. Either party at commencement of the mediation may ask the mediator to provide an evaluation of the Dispute and the parties' relative positions.

18.4. Arbitration. (a) If a Dispute is not resolved by mediation as provided in Section 18.3 within thirty (30) days of the selection of a mediator (unless the mediator chooses to withdraw sooner), either party may submit the Dispute to be finally resolved by arbitration pursuant to the CPR Rules for Non-Administered Arbitration as then in effect (the "CPR Arbitration Rules"). The parties consent to a single, consolidated arbitration for all known Disputes existing at the time of the arbitration and for which arbitration is permitted.

(b) The neutral organization for purposes of the CPR Arbitration Rules will be the CPR. The arbitral tribunal shall be composed of three arbitrators who are each experienced in the U.S. reinsurance business, of whom each party shall appoint one in accordance with the "screened" appointment procedure provided in Rule 5.4 of the CPR Arbitration

Rules. The non-party appointed arbitrator must have prior U.S. reinsurance experience as a present or former officer or management employee of a reinsurance company, but not of the Company, or the Administrator, or any of their respective affiliates. The arbitration shall be conducted in New York City. Each party shall be permitted to present its case, witnesses and evidence, if any, in the presence of the other party. A written transcript of the proceedings shall be made and furnished to the parties. The arbitrators shall determine the Dispute in accordance with the law of New York, without giving effect to any conflict of law rules or other rules that might render such law inapplicable or unavailable, and shall apply this Agreement according to its terms, provided that the provisions relating to arbitration shall be governed by the Federal Arbitration Act, 9 U.S.C. §§ 1 et seq. The arbitral tribunal shall endeavor to render its award or order

---

resulting from any arbitration within forty-five (45) days following the termination of the arbitration proceedings.

(c) The parties agree to be bound by any award or order resulting from any arbitration conducted hereunder and further agree that judgment on any award or order resulting from an arbitration conducted under this Section 18.4 may be entered and enforced in any court having jurisdiction thereof.

(d) Except as expressly permitted by this Agreement, no party will commence or voluntarily participate in any court action or proceeding concerning a Dispute, except (i) for enforcement as contemplated by Section 18.4(c) above, (ii) to restrict or vacate an arbitral decision based on the grounds specified under applicable law, or (iii) for interim relief as provided in paragraph (e) below. For purposes of the foregoing the parties hereto submit to the non-exclusive jurisdiction of the courts of the State of New York.

(e) In addition to the authority otherwise conferred on the arbitral tribunal, the tribunal shall have the authority to make such orders for interim relief, including injunctive relief, as it may deem just and equitable. Notwithstanding paragraph (d) above, each party acknowledges that in the event of any actual or threatened breach of certain of the provisions of this Agreement, the remedy at law would not be adequate, and therefore injunctive or other interim relief may be sought immediately to restrain such breach. If the tribunal shall not have been appointed, either party may seek interim relief from a court having jurisdiction if the award to which the applicant may be entitled may be rendered ineffectual without such interim relief. Upon appointment of the tribunal following any grant of interim relief by a court, the tribunal may affirm or disaffirm such relief, and the parties will seek modification or rescission of the court action as necessary to accord with the tribunal's decision.

(f) Each party will bear its own attorneys' fees and costs incurred in connection with the resolution of any Dispute in accordance with this Article XVIII.

#### ARTICLE XIX

##### MISCELLANEOUS PROVISIONS

19.1. Headings and Schedules. Headings used herein are not a part of this Agreement and shall not affect the terms hereof. The attached Schedules are a part of this Agreement.

19.2. Notices. All notices, requests, demands and other communications under this Agreement must be in writing and will be deemed to have been duly given or made as follows: (a) if sent by registered or certified mail in the United States return receipt requested, upon receipt; (b) if sent by reputable overnight air courier, two business days after mailing; (c) if sent by facsimile transmission, with a copy mailed on the same day in the manner provided in (a) or (b) above, when transmitted and receipt is confirmed by telephone; or (d) if otherwise actually personally delivered, when delivered, and shall be delivered as follows:

---

If to the Company:

GE Capital Life Assurance Company of New York  
6610 West Broad Street  
Richmond, VA 23230  
Facsimile: (804) 281-6165  
Attention: Chief Executive Officer

With a copy to:

GE Capital Life Assurance Company of New York  
6610 West Broad Street  
Richmond, VA 23230  
Facsimile: (804) 281-6005  
Attention: General Counsel

If to the Administrator:

Union Fidelity Life Insurance Company  
200 North Martingale Road  
Schaumburg, IL 60173-2096  
Facsimile: (847) 330-3404  
Attention: Chief Financial Officer

With a copy to:

Union Fidelity Life Insurance Company  
200 North Martingale Road  
Schaumburg, IL 60173-2096  
Facsimile: (847) 605-3044  
Attention: General Counsel

or to such other address or to such other Person as either party may have last designated by notice to the other party.

19.3. Successors and Assigns. This Agreement shall be binding upon and inure to the benefit of the parties hereto and their respective successors, permitted assigns and legal representatives. Neither this Agreement, nor any right or obligation hereunder, may be assigned by any party without the prior written consent of the other party hereto and without the prior written consent of the New York Insurance Department and the Illinois Insurance Department. Any assignment in violation of this Section 19.3 shall be void and shall have no force and effect.

19.4. Execution in Counterpart. This Agreement may be executed by the parties hereto in any number of counterparts, and by each of the parties hereto in separate

19.5. Safeguarding Customer Information. The Administrator shall implement and maintain appropriate measures designed to meet the objectives of New York Insurance Department Regulation No. 173, with respect to safeguarding the Company's customer information and customer information systems. The Administrator shall adjust its information security program at the reasonable request of the Company for any relevant changes indicated by the Company's assessment of risk around its customer information and customer information systems. Confirming evidence that the Administrator has satisfied its obligations under this Agreement shall be made available, during normal business hours, for inspection by the Company, representatives of the Company, and any governmental agency that has regulatory authority over the Company's business activities.

19.6. Currency. Whenever the word "Dollars" or the "\$" sign appear in this Agreement, they shall be construed to mean United States Dollars, and all transactions under this Agreement shall be in United States Dollars.

19.7. Amendments. This Agreement may not be changed, altered or modified unless the same shall be in writing executed by the Company and the Administrator.

19.8. Governing Law. This Agreement will be construed, performed and enforced in accordance with the laws of the State of New York without giving effect to its principles or rules of conflict of laws thereof to the extent such principles or rules would require or permit the application of the laws of another jurisdiction.

19.9. Entire Agreement; Severability. (a) This Agreement constitutes the entire agreement between the parties hereto relating to the subject matter hereof and supersedes all prior and contemporaneous agreements, understandings, statements, representations and warranties, negotiations and discussions, whether oral or written, of the parties and there are no general or specific warranties, representations or other agreements by or among the parties in connection with the entering into of this Agreement or the subject matter hereof except as specifically set forth or contemplated herein.

(b) If any provision of this Agreement is held to be void, unenforceable or in violation of any provision of the Travelers Agreements, in whole or in part, (i) such holding or provision shall not affect the validity and enforceability of the remainder of this Agreement, including any other provision, paragraph or subparagraph, and (ii) the parties agree to attempt in good faith to reform such void, unenforceable or violative provision to the extent necessary to render such provision enforceable and to carry out its original intent.

19.10. No Waiver: Preservation of Remedies. No consent or waiver, express or implied, by any party to or of any breach or default by any other party in the performance by such other party of its obligations hereunder shall be deemed or construed to be a consent or waiver to or of any other breach or default in the performance of obligations hereunder by such other party hereunder. Failure on the part of any party to complain of any act or failure to act of any other party or to declare any other party in default, irrespective of how long such failure continues, shall not constitute a waiver by such first party of any of its rights hereunder. The rights and remedies provided are cumulative and are not exclusive of any rights or remedies that any party may otherwise have at law or equity.

19.11. Third Party Beneficiary. Nothing in this Agreement will confer any rights upon any Person that is not a party or a successor or permitted assignee of a party to this Agreement.

19.12. Tax Exception to Any Confidentiality. Notwithstanding anything to the contrary set forth herein or in any other agreement to which the parties hereto are parties or by which they are bound, any obligations of confidentiality contained herein and therein, as they relate to the transactions, shall not apply to the federal tax structure or federal tax treatment of the transactions, and each party hereto (and any employee, representative, or agent of any party hereto) may disclose to any and all persons, without limitation of any kind, the federal tax structure and federal tax treatment of the transactions. The preceding sentence is intended to cause the transactions to be treated as not having been offered under conditions of confidentiality for purposes of Section 1.6011-4(b)(3) (or any successor provision) of the Treasury Regulations promulgated under Section 6011 of the Internal Revenue Code of 1986, as amended, and shall be construed in a manner consistent with such purpose. In addition, each party hereto acknowledges that it has no proprietary or exclusive rights to the federal tax structure of the transactions or any federal tax matter or federal tax idea related to the transactions.

19.13. Interpretation. Wherever the words "include," "includes" or "including" are used in this Agreement, they shall be deemed to be followed by the words "without limitation."

19.14. Survival. Article XVIII and Article XIX shall survive the termination of this Agreement.

19.15. Licensing. At all times during the term of this Agreement, the Administrator shall maintain in full force and effect all licenses required to be maintained by it under Applicable Law with respect to this Agreement, including, if applicable, an independent claims adjuster license.

IN WITNESS WHEREOF, the Company and the Administrator have executed this Agreement as of the date first above written.

GE CAPITAL LIFE ASSURANCE COMPANY  
OF NEW YORK

By: \_\_\_\_\_  
Name:  
Title:

UNION FIDELITY LIFE INSURANCE  
COMPANY

By: \_\_\_\_\_  
Name:  
Title:

---

**BUSINESS ASSOCIATE ADDENDUM**
**I. Purpose.**

In order to disclose certain information to the party providing a service under this Agreement (“Provider”) under this Addendum, some of which may constitute Protected Health Information (defined below), the party to whom a service under this Agreement is being provided (“Recipient”) and Provider mutually agree to comply with the terms of this Addendum for the purpose of satisfying the requirements of the Health Insurance Portability and Accountability Act of 1996 (“HIPAA”) and its implementing privacy regulations at 45 C.F.R. Parts 160-164 (“HIPAA Privacy Rule”). These provisions shall apply to Provider to the extent that Provider is considered a “Business Associate” under the HIPAA Privacy Rule and all references in this section to Business Associates shall refer to Provider. Capitalized terms not otherwise defined herein shall have the meaning assigned in the Agreement. Notwithstanding anything else to the contrary in the Agreement, in the event of a conflict between this Addendum and the Agreement, the terms of this Addendum shall prevail.

**II. Permitted Uses and Disclosures.**

A. Business Associate agrees to use or disclose Protected Health Information (“PHI”) that it creates for or receives from Recipient or its Subsidiaries only as follows. The capitalized term “Protected Health Information or PHI” has the meaning set forth in 45 Code of Federal Regulations Section 164.501, as amended from time to time. Generally, this term means individually identifiable health information including, without limitation, all information, data and materials, including without limitation, demographic, medical and financial information, that relates to the past, present, or future physical or mental health or condition of an individual; the provision of health care to an individual; or the past present, or future payment for the provision of health care to an individual; and that identifies the individual or with respect to which there is a reasonable basis to believe the information can be used to identify the individual. This definition shall include any demographic information concerning members and participants in, and applicants for, Recipient’s or its Subsidiaries’ health benefit plans. All other terms used in this Addendum shall have the meanings set forth in the applicable definitions under the HIPAA Privacy Rule.

B. Functions and Activities on Company’s Behalf. Business Associate is permitted to use and disclose PHI it creates for or receives from Recipient or its Subsidiaries only for the purposes described in this Addendum or the Agreement that are not inconsistent with the provisions of this Addendum, or as required by law, or following receipt of prior written approval from whichever of the Recipient or its Subsidiary for which the relevant PHI was created or from which the relevant PHI was received. In addition to these specific requirements below, Business Associate may use or disclose PHI only in a manner that would not violate the HIPAA Privacy Rule if done by the Recipient or its Subsidiaries.

C. Business Associate’s Operations. Business Associate is permitted by this Agreement to use PHI it creates for or receives from Recipient or its Subsidiaries: (i) if such use is reasonably necessary for Business Associate’s proper management and administration; and (ii) as reasonably necessary to carry out Business Associate’s legal responsibilities. Business

---

Associate is permitted to disclose PHI it creates for or receives from Recipient or its Subsidiaries for the purposes identified in this Section only if the following conditions are met:

- (1) The disclosure is required by law; or
- (2) The disclosure is reasonably necessary to Business Associate’s proper management and administration, and Business Associate obtains reasonable assurances in writing from any person or organization to which Business Associate will disclose such PHI that the person or organization will:
  - a. Hold such PHI as confidential and use or further disclose it only for the purpose for which Business Associate disclosed it to the person or organization or as required by law; and
  - b. Notify Business Associate (who will in turn promptly notify whichever of the Recipient or its Subsidiary for which the relevant PHI was created or from which the relevant PHI was received) of any instance of which the person or organization becomes aware in which the confidentiality of such PHI was breached.

D. Minimum Necessary Standard. In performing the functions and activities on Recipient’s or its Subsidiaries’ behalf pursuant to the Agreement, Business Associate agrees to use, disclose or request only the minimum necessary PHI to accomplish the purpose of the use, disclosure or request. Business Associate must have in place policies and procedures that limit the PHI disclosed to meet this minimum necessary standard.

E. Prohibition on Unauthorized Use or Disclosure. Business Associate will neither use nor disclose PHI it creates or receives for or from Recipient, its Subsidiaries, or from another business associate of Recipient or its Subsidiaries, except as permitted or required by this Addendum or the Agreement that are not inconsistent with the provisions of this Addendum, or as required by law, or following receipt of prior written approval from whichever of the Recipient or its Subsidiary for which the relevant PHI was created or from which the relevant PHI was received.

F. De-identification of Information. Business Associate agrees neither to de-identify PHI it creates for or receives from Recipient or its Subsidiaries or from another business associate of Recipient or its Subsidiaries, nor use or disclose such de-identified PHI, unless such de-identification is expressly permitted under the terms and conditions of this Addendum or the Agreement and related to Recipient’s or its Subsidiaries’ activities for purposes of “treatment”, “payment” or “health care operations”, as those terms are defined under the HIPAA Privacy Rule. De-identification of PHI, other than as expressly permitted under the terms and conditions of the Addendum for Business Associate to perform services for Recipient or its Subsidiaries, is not a permitted use of PHI under this Addendum. Business Associate further agrees that it will not create a “Limited Data Set” as defined by the HIPAA Privacy Rule using PHI it creates or receives, or receives from another business associate of Recipient or its Subsidiaries, nor use or disclose such Limited Data Set unless: (i) such creation, use or disclosure is expressly permitted under the terms and conditions of this Addendum or the Agreement that are not inconsistent with the provisions of this Addendum; and such creation, use or disclosure is for services provided by

---

Business Associate that relate to Recipient’s or its Subsidiaries’ activities for purposes of “treatment”, “payment” or “health care operations”, as those terms are defined under the HIPAA Privacy Rule.

G. Information Safeguards. Business Associate will develop, document, implement, maintain and use appropriate administrative, technical and physical safeguards to preserve the integrity and confidentiality of and to prevent non-permitted use or disclosure of PHI created for or received from Recipient or its Subsidiaries. These safeguards must be appropriate to the size and complexity of Business Associate’s operations and the nature and scope of its activities. Business Associate agrees that these safeguards will meet any applicable requirements set forth by the U.S. Department of Health and Human Services, including (as of the effective date or as of the compliance date, whichever is applicable) any requirements set forth in the final HIPAA security regulations. Business Associate agrees to mitigate, to the extent practicable, any harmful effect that is known to Business Associate resulting from a use or disclosure of PHI by Business Associate in violation of the requirements of this Addendum.

III. Conducting Standard Transactions. In the course of performing services for Recipient or its Subsidiaries, to the extent that Business Associate will conduct Standard Transactions for

or on behalf of Recipient or its Subsidiaries, Business Associate will comply, and will require any subcontractor or agent involved with the conduct of such Standard Transactions to comply, with each applicable requirement of 45 C.F.R. Part 162. "Standard Transaction(s)" shall mean a transaction that complies with the standards set forth at 45 C.F.R. parts 160 and 162. Further, Business Associate will not enter into, or permit its subcontractors or agents to enter into, any trading partner agreement in connection with the conduct of Standard Transactions for or on behalf of the Recipient or its Subsidiaries that:

- a. Changes the definition, data condition, or use of a data element or segment in a Standard Transaction;
- b. Adds any data element or segment to the maximum defined data set;
- c. Uses any code or data element that is marked "not used" in the Standard Transaction's implementation specification or is not in the Standard Transaction's implementation specification; or
- d. Changes the meaning or intent of the Standard Transaction's implementation specification.

IV. Sub-Contractors, Agents or Other Representatives. Business Associate will require any of its subcontractors, agents or other representatives to which Business Associate is permitted by this Addendum or the Agreement (or is otherwise given Recipient's or the relevant Subsidiary's prior written approval) to disclose any of the PHI Business Associate creates or receives for or from Recipient or its Subsidiaries, to provide reasonable assurances in writing that subcontractor or agent will comply with the same restrictions and conditions that apply to the Business Associate under the terms and conditions of this Addendum with respect to such PHI.

3

---

V. Protected Health Information Access, Amendment and Disclosure Accounting.

A. Access. Business Associate will promptly upon Recipient's or its Subsidiary's request make available to Recipient, its Subsidiary, or, at Recipient's or such Subsidiary's direction, to the individual (or the individual's personal representative) for inspection and obtaining copies any PHI about the individual which Business Associate created for or received from Recipient or its Subsidiary and that is in Business Associate's custody or control, so that Recipient or its Subsidiary may meet its access obligations under 45 Code of Federal Regulations § 164.524.

B. Amendment. Upon Recipient's or its Subsidiary's request Business Associate will promptly amend or permit Recipient or its Subsidiary access to amend any portion of the PHI which Business Associate created for or received from Recipient or its Subsidiary, and incorporate any amendments to such PHI, so that Recipient or its Subsidiary may meet its amendment obligations under 45 Code of Federal Regulations § 164.526.

C. Disclosure Accounting. So that Recipient or its Subsidiaries may meet their disclosure accounting obligations under 45 Code of Federal Regulations § 164.528:

1. Disclosure Tracking. Business Associate will record for each disclosure, not excepted from disclosure accounting under Section V.C.2 below, that Business Associate makes to Recipient or its Subsidiaries of PHI that Business Associate creates for or receives from Recipient or its Subsidiaries, (i) the disclosure date, (ii) the name and member or other policy identification number of the person about whom the disclosure is made, (iii) the name and (if known) address of the person or entity to whom Business Associate made the disclosure, (iv) a brief description of the PHI disclosed, and (v) a brief statement of the purpose of the disclosure (items i-v, collectively, the "disclosure information"). For repetitive disclosures Business Associate makes to the same person or entity (including Recipient or its Subsidiaries) for a single purpose, Business Associate may provide a) the disclosure information for the first of these repetitive disclosures, (b) the frequency, periodicity or number of these repetitive disclosures and (c) the date of the last of these repetitive disclosures. Business Associate will make this disclosure information available to Recipient or its Subsidiaries promptly upon Recipient's or its Subsidiaries' request.

2. Exceptions from Disclosure Tracking. Business Associate need not record disclosure information or otherwise account for disclosures of PHI that this Addendum or Recipient or the relevant Subsidiary in writing permits or requires (i) for the purpose of Recipient's or its Subsidiaries' treatment activities, payment activities, or health care operations, (ii) to the individual who is the subject of the PHI disclosed or to that individual's personal representative; (iii) to persons involved in that individual's health care or payment for health care; (iv) for notification for disaster relief purposes, (v) for national security or intelligence purposes, (vi) to law enforcement officials or correctional institutions regarding inmates; or (vii) pursuant to an authorization; (viii) for disclosures of certain PHI made as part of a Limited Data Set; (ix) for certain incidental disclosures that may occur where reasonable safeguards have been implemented; and (x) for disclosures prior to April 14, 2003.

4

---

3. Disclosure Tracking Time Periods. Business Associate must have available for Recipient and its Subsidiaries the disclosure information required by this section for the 6 years preceding Recipient's or its Subsidiaries' request for the disclosure information (except Business Associate need have no disclosure information for disclosures occurring before April 14, 2003).

VI. Additional Business Associate Provisions

A. Reporting of Breach of Privacy Obligations. Business Associate will provide written notice to whichever of the Recipient or its Subsidiary for which the relevant PHI was created or from which the relevant PHI was received of any use or disclosure of PHI that is neither permitted by this Addendum nor given prior written approval by Recipient or the relevant Subsidiary promptly after Business Associate learns of such non-permitted use or disclosure. Business Associate's report will at least:

- (i) Identify the nature of the non-permitted use or disclosure;
- (ii) Identify the PHI used or disclosed;
- (iii) Identify who made the non-permitted use or received the non-permitted disclosure;
- (iv) Identify what corrective action Business Associate took or will take to prevent further non-permitted uses or disclosures;
- (v) Identify what Business Associate did or will do to mitigate any deleterious effect of the non-permitted use or disclosure; and
- (vi) Provide such other information, including a written report, as Recipient or the relevant Subsidiary may reasonably request.

B. Amendment. Upon the effective date of any final regulation or amendment to final regulations promulgated by the U.S. Department of Health and Human Services with respect to PHI, including, but not limited to the HIPAA privacy and security regulations, this Addendum and the Agreement will automatically be amended so that the obligations they impose on Business Associate remain in compliance with these regulations.

In addition, to the extent that new state or federal law requires changes to Business Associate's obligations under this Addendum, this Addendum shall automatically be amended to include

such additional obligations, upon notice by Recipient or its Subsidiaries to Business Associate of such obligations. Business Associate's continued performance of services under the Agreement shall be deemed acceptance of these additional obligations.

C. Audit and Review of Policies and Procedures. Business Associate agrees to provide, upon Recipient request, access to and copies of any policies and procedures developed or utilized by Business Associate regarding the protection of PHI. Business Associate agrees to provide, upon Recipient's request, access to Business Associate's internal practices, books, and records, as they relate to Business Associate's services, duties and obligations set forth in this Addendum and the Agreement(s) under which Business Associate provides services and / or

products to or on behalf of Recipient or its Subsidiaries, for purposes of Recipient's or its Subsidiaries' review of such internal practices, books, and records.











SCHEDULE C

CEDING COMMISSION

The Ceding Commission shall be the sum of the following:

1. an amount equal to the excess of the Total SAP Ceded Reserves over Total GAAP Ceded Reserves measured as of the close of business on the day immediately preceding the Inception Date (which amount may be negative);
  2. an amount equal to the unamortized PVFP intangible asset balance of the Company with respect to the Reinsured Policies as measured as of the close of business on the day immediately preceding the Inception Date, determined in accordance with GAAP;
  3. an amount equal to the unamortized deferred acquisition costs of the Company with respect to the Reinsured Policies as measured as of the close of business on the day immediately preceding the Inception Date, determined in accordance with GAAP;
  4. an amount equal to the balance of the Loss Carry Forward Amount as of the close of business on the day immediately preceding the Inception Date, determined in accordance with GAAP; and
  5. an amount equal to the excess of the GAAP book value of the Assets (excluding any related mark to market adjustments for SFAS 115 requirement) over the SAP book value of the Assets measured as of the close of business on the day immediately preceding the Inception Date (which amount may be negative).
-



SCHEDULE D

ASSETS

Transfer Document	From	To	Nature of Transfer	Cash Map Cross-Reference	Schedule
GECLANY LTC Retrocession	GECLANY	UFLIC	Treaty	(89)	Schedule D

Called Securities *	Parent Name	Issuer Name	IQ04 Cusip	IQ04 Tax lot	12/31/03 Local Par	12/31/03 GAAP BV (incl attached derivative)	12/31/03 Accrued Interest	12/31/03 GAAP BV + Accrued Interest	12/31/03 STAT BV (incl attached derivative)	12/31/03 Accrued Interest	12/31/03 STAT BV + Accrued Interest
						[Individual Asset Details Omitted]					
	Asset Sub Total					360,525,356.37	5,210,003.59	365,735,359.96	360,438,234.29	5,210,003.59	365,648,237.88
	Cash								398,450.63		398,450.63
	Total								360,836,684.92		366,046,688.51

\* These Securities will not be transferred. The "Call Amount" will be settled in cash

SCHEDULE E

EXPENSE ALLOWANCES

The "Annual Expense Reimbursement Factors" used to calculate the Expense Allowance are as follows:

Policy Maintenance Factor	\$7.12 per Policy
Claims Factor	\$876.00 per Open and Pending Claim
Travelers Agreement Maintenance Factor	\$45.24 per Policy

Such Annual Expense Reimbursement Factors will be adjusted (i) for the year beginning January 1, 2005 and, thereafter, every three (3) years during the term of this Agreement based on a triennial cost/time study prepared in accordance with the methodology set forth below (the "Triennial Study") and (ii) for the years between the Triennial Studies based on a report setting forth the Annual Expense Reimbursement Factors prepared in accordance with the methodology set forth below (the "Annual Expense Reimbursement Factor Report").

(a) **Triennial Study.** As soon as practicable (and in any event within sixty (60) days) prior to January 1, 2005 and prior to the beginning of every third calendar year thereafter during the term of this Agreement, the Company shall cause to be prepared and delivered to the Reinsurer the Triennial Study which sets forth the Annual Expense Reimbursement Factors for the next calendar year, together with all supporting data used in preparing the Triennial Study and work papers, in reasonable detail, setting forth the determination of such Annual Expense Reimbursement Factors based on such Triennial Study (such documents, together with the Triennial Study, the "Triennial Study Documents").

(b) **Annual Expense Reimbursement Factor Report.** As soon as practicable (and in any event within thirty (30) days) prior to January 1, 2006 and prior to the beginning of each calendar year thereafter in which no Triennial Study is prepared, the Company shall cause to be prepared and delivered to the Reinsurer the Annual Expense Reimbursement Factor Report, together with all supporting data used in preparing the Annual Expense Reimbursement Factor Report and work papers, in reasonable detail, setting forth the determination of such Annual Expense Reimbursement Factors for the next calendar year (such documents, together with the Annual Expense Reimbursement Factor Report, the "Annual Expense Reimbursement Factor Documents").

(c) **Methodology.** At the time of the Triennial Study, historical costs (to include costs (excluding costs identified as "Allocated Loss Adjustment Expenses") directly related to maintaining and administering policies, processing claims and reporting results, including, without limitation, for Business Overhead Services set forth on Schedule E-1 hereto) will be determined for the Policy Maintenance Factor, the Claims Factor and the Travelers Agreement Maintenance Factor identified above. For a given Annual Expense Reimbursement Factor the identified costs will be divided by the total historical number of units of measure for both the Reinsured Policies and the retained block of business to derive an historical cost per unit. The historical cost per unit will be used as a prospective cost per unit for the next calendar year.

For the two succeeding years in the period between the Triennial Studies the historical dollar amounts by Policy Maintenance Factor, Claims Factor and Travelers Agreement Maintenance Factor will be adjusted (rolled forward) for current year cost changes agreed to by the Reinsurer and the Company (in accordance with the procedures set forth below). This rolled forward historical cost will then be divided by the total historical number of units for the current period to determine a prospective cost per unit for the next calendar year.

An additional adjustment, positive or negative, to the prospective cost per unit determined by either the Triennial Study or the two succeeding years may be negotiated between the parties. The additional adjustment is for special projected costs or benefits of productivity, process improvements, inflation, loss of scale, and any other cost variation which was not included in the prior Triennial Study or the succeeding roll forward.

The combined prospective unit cost and additional adjustment is the Annual Expense Reimbursement Factor. The Expense Allowance will be determined quarterly and billed to the Reinsurer in three equal installments during the quarter at the end of the month. Each installment of the monthly amount billed will be determined by multiplying the actual number of units at the beginning of the quarter covered by this Agreement times the Annual Expense Reimbursement Factor (divided by twelve).

(d) **Review of Documents.** Following the delivery of the Annual Expense Reimbursement Factor Documents or the Triennial Study Documents, as applicable, the Company shall (i) provide to the Reinsurer or its designated representative copies of such additional work papers and other documents relating to its preparation of the Annual Expense Reimbursement Factor Report or Triennial Study, as applicable, as the Reinsurer or its designated representative may reasonably request, including, without limitation, claims files and practices and (ii) cooperate with, and make its personnel and facilities reasonably available to, the Reinsurer and the Reinsurer's designated representative for the purpose of providing such other information as the Reinsurer or the Reinsurer's designated representative may reasonably request concerning Annual Expense Reimbursement Factor Documents or the Triennial Study Documents, as applicable, and the calculation of the Annual Expense Reimbursement Factors.

(e) **Notice of Disagreement.** In the event that the Reinsurer has any disagreement with any of the Annual Expense Reimbursement Factor Documents or the Triennial Study Documents, as applicable, the Reinsurer shall give written notice of all such disagreements (a "Notice of Disagreement") to the Company within thirty (30) days after the Annual Expense Reimbursement Factor Documents or the Triennial Study Documents, as applicable, are delivered to the Reinsurer. Any Notice of Disagreement shall set forth each item in disagreement and shall provide reasonable specificity as to the basis for each disagreement and shall specify the total adjustment to the Annual Expense Reimbursement Factors as proposed by the Company as a result of such items in disagreement.

(f) **Dispute Resolution.** If the Reinsurer does not deliver a Notice of Disagreement to the Company within such thirty (30) day period, the Annual Expense Reimbursement Factor Documents and the Triennial Study Documents, as applicable, shall be final and binding upon the parties hereto and shall constitute the final calculation of the Annual Expense Reimbursement Factor for the next calendar year. If the Reinsurer delivers a Notice of

Disagreement to the Company within such thirty (30) day period, the parties shall (and shall cause their respective designated representatives to) negotiate in good faith to resolve all disagreements as promptly as practicable. Any changes in the Annual Expense Reimbursement Factors, if any, that are agreed to by the Company and the Reinsurer within sixty (60) days of the aforementioned delivery of the Annual Expense Reimbursement Factor Documents or the Triennial Study Documents, as applicable, shall be incorporated into a final calculation of the Annual Expense Reimbursement Factors. If the parties and their respective designated representatives are unable to resolve all disagreements within sixty (60) days of delivery of the Annual Expense Reimbursement Factor Documents or the Triennial Study Documents, as applicable, then all unresolved disagreements will be submitted within ten (10) days after the end of such sixty (60) day period for resolution in accordance herewith to an independent certified public accounting firm of national standing and reputation (the "Accounting Firm") mutually acceptable to the Company and the Reinsurer. The parties shall cooperate in good faith with the Accounting Firm and shall give the Accounting Firm access to all data and other information requested by the Accounting Firm for purposes of such resolution. The Accounting Firm shall, within thirty (30) days after its engagement, deliver to the Company and the Reinsurer a definitive calculation of the Annual Expense Reimbursement Factors, which shall be final and binding upon the parties hereto and shall be so reflected in the calculation of the Annual Expense Reimbursement Factors. The Company and the Reinsurer shall each pay one-half of the fees and expenses of the Accounting Firm.

(g) Expense Allowance Pending Resolution. In the event of a dispute with respect to any Annual Expense Reimbursement Factors for the next succeeding Calendar year, the Company and the Reinsurer agree that the Annual Expense Reimbursement Factors then in effect under this Agreement shall remain in effect pending resolution of such dispute and adjustment, if any, in accordance with the dispute resolution procedure set forth in paragraph (f) above.

---

-

SCHEDULE E-1

BUSINESS OVERHEAD SERVICES

Business Overhead Services

The "Business Overhead Services" are broadly defined as activities performed by the "LTC" business unit of GNA Corporation ("GNA") and its subsidiaries and Affiliates that benefit the business reinsured under this Agreement. GNA will provide, as a subcontractor, the Business Overhead Services, which will include, without limitation, the services described below.

**Executive:**

General support, counsel, strategy and leadership provided by LTC's Chief Executive Officer including managing existing business relationship with Travelers.

**Human Resources:**

General business level Human Resource related activities including but not limited to leadership development, employee recruitment and staffing, implementation of compensation policies and practices, payroll and benefit administration, organizational communication, training, general security and employee issue resolution and guidance.

**Finance:**

Cost of finance activities including but not limited to product financial support and analysis, account reconciliations, state reporting, product profitability analysis, investment income planning & analysis, expense management, audit support, statutory & GAAP accounting, reporting & analysis and ad hoc financial analysis. Finance supports the existing reinsurance treaty and all related filings.

**Legal/Compliance:**

Cost of support and coordination of litigation, government relations, human resource, intellectual property, insurance regulatory, consumer privacy, contract, compliance, and public relations matters. Additional relationships with the DOI and with Travelers are managed within this group.

**Risk:**

Cost of Risk Management and reinsurance support---Monitor production vs. authority limits, monitor and review key risk measures. General oversight of inforce product performance analysis and reviews. Reinsurance oversight and treaty management including settlement with reinsurers. Reserve analysis and general risk management.

**Sourcing / Facilities:**

Campus expenses including building rent and maintenance, parking garage, cafeteria, campus lawn care and utilities. Procurement of necessary business software, supplies, EDP.

---

**Information Technology:**

General business technology infrastructure costs including but not limited to general management, help desk assistance, data center management, disaster recovery plans and digitization of processes.

**Six Sigma Quality:**

Costs including business project management and process improvement coaching, execution and leadership.

**Actuarial:**

Sets Reserving Levels, Provides analysis on in-force blocks, evaluates product risk analysis, forecasting and planning for future periods. Manages reinsurance analysis.

**eQuTOPs:**

Project budget associated to large scale projects that impact the business via digitization, streamlining of processes, system enhancements or regulatory mandated projects (e.g., HIPAA).

**Product Management:**

Costs for product line managers to manage inforce policies and general product line maintenance activities such as risk assessment, return on equity ("ROE") variance analysis and related ROE improvement projects.

**Operations:**

Costs including management, project leadership and administrative support for service operations supporting customers, policyholders, claims delivery and other stakeholders.

**Other:**

Costs including corporate insurance allocation to product lines (e.g., cost of building insurance and other property, plant and equipment).

**Retention:**

Costs including monitoring of inforce policy retention levels, design and execute programs to retain inforce business.

Changes in Services

The Business Overhead Services shall include such other comparable and/or successor services implemented or maintained from time to time by GNA and its subsidiaries and Affiliates.

-  
SCHEDULE F - PART I

INITIAL REPORT

1. Total SAP Ceded Reserves:		
A. Active Life Reserves		
B. Claim Reserves	\$	
C. Unearned Premium Reserves	\$	
D. Advanced Premium	\$	
E. Less: Due and Unpaid Premium	\$	
Total SAP Ceded Reserves (A+B+C+D-E)		\$
2. Ceding Commission:		
A. Excess SAP Ceded Reserves over GAAP Ceded Reserves:		
1) Total SAP Ceded Reserves	\$	
2) Total GAAP Ceded Reserves:		
a. Active Life Reserves	\$	
b. Maintenance Reserves	\$	
c. Loss Expense Reserves	\$	
d. Claim Reserves	\$	
e. Unearned Premium Reserves	\$	
f. Advanced Premium	\$	
g. Less: Due and Unpaid Premium	\$	
Total GAAP Ceded Reserves (a+b+c+d+e+f-g)	\$	
Excess SAP Reserves over GAAP Reserves (A1-A2)		\$
B. Present Value of Future Profits (PVFP)		\$
C. Deferred Acquisition Costs (DAC)		\$
D. Loss Carry Forward Amount (Stop Loss Balance)		\$
E. Asset Book Value Difference —		
1) Asset Book Value (GAAP basis)	\$	
2) Asset Book Value (SAP basis)	\$	
Excess Asset Book Value (E1-E2)		\$
Total Ceding Commission (A+B+C+D+E)		\$
3. Accrued Interest on Assets as of the day before Inception Date		\$
4. Investment Cash Flows on the Assets from the Inception Date through the Closing Date		\$
Net Due Reinsurer (1-2-3+4)		\$

-  
SCHEDULE F - PART II

MONTHLY SETTLEMENT REPORT

1. Additional Premium Due:		
A. Premiums Received:		
1. Direct Premium Collected on Reinsured Policies	\$	
2. Additional Reinsurance Premium Collected from Travelers	\$	
3. Less: Premiums Paid to Travelers on retained business	\$	
Total Premiums Received (A1+A2-A3)		\$
B. 12/31/03 Due and Unpaid Premium Receivable Collected		\$
C. Stop Loss Payments Received from Travelers		\$
Total Additional Premium Due (A+B+C)		\$
2. Ultimate Net Loss Paid:		
A. Losses (Claims Incurred)		
1. Direct Losses Incurred	\$	
2. Less: Losses Reimbursed by Travelers on retained business	\$	
Total Losses (Claims Incurred) (A1+A2)		\$
B. Stop Loss Payments to Travelers	\$	
C. Allocated Loss Adjustment Expense	\$	
D. Premium Taxes Due	\$	
E. Insolvency Fund Assessments, net	\$	
F. Returns or Refunds of Premiums	\$	
G. Commissions Paid	\$	
H. Unclaimed Property Liabilities	\$	
Total Ultimate Net Loss Paid (A+B+C+D+E+F+G+H)		\$
3. Withdrawals from Claims Settlement Account		\$
4. Expense Allowance:		
A. Policy Maintenance	\$	
B. Claims	\$	
C. Traveler's Agreement Maintenance	\$	
Total Expense Commission (A+B+C)		\$
5. Additional Expenses:		

A. Novation Costs Incurred (pursuant to Section 2.6)	\$	
B. Re-rating costs incurred (pursuant to Section 3.3)	\$	
Total Additional Expense (A+B)		\$
6. Additional Ceding Commission Paid to Travelers		\$
Net Due Reinsurer (1-2+3-4-5-6)		\$

-  
SCHEDULE F - PART III

QUARTERLY SETTLEMENT REPORT

1. Additional Premium Due:		
A. Premiums Received:		
1. Direct Premium Collected on Reinsured Policies	\$	
2. Additional Reinsurance Premium Collected from Travelers	\$	
3. Less: Premiums Paid to Travelers on retained business	\$	
Total Premiums Received (A1+A2-A3)		\$
B. 12/31/03 Due and Unpaid Premium Receivable Collected		\$
C. Stop Loss Payments Received from Travelers		\$
Total Additional Premium Due (A+B+C)		\$
2. Ultimate Net Loss Paid:		
A. Losses (Claims Incurred)		
1. Direct Losses Incurred	\$	
2. Less: Losses Reimbursed by Travelers on retained business	\$	
Total Losses (Claims Incurred) (A1+A2)		\$
B. Stop Loss Payments to Travelers	\$	
C. Allocated Loss Adjustment Expense	\$	
D. Premium Taxes Due	\$	
E. Insolvency Fund Assessments, net	\$	
F. Returns or Refunds of Premiums	\$	
G. Commissions Paid	\$	
H. Unclaimed Property Liabilities	\$	
Total Ultimate Net Loss Paid (A+B+C+D+E+F+G+H)		\$
3. Withdrawals from Claims Settlement Account		\$
4. Expense Allowance:		
A. Policy Maintenance	\$	
B. Claims	\$	
C. Traveler's Agreement Maintenance	\$	
Total Expense Commission (A+B+C)		\$
5. Additional Expenses:		
A. Novation Costs Incurred (pursuant to Section 2.6)	\$	
B. Re-rating costs incurred (pursuant to Section 3.3)	\$	
Total Additional Expense (A+B)		\$
6. Additional Ceding Commission Paid to Travelers		\$
I. Quarterly Settlement Amount (1-2+3-4-5-6)		\$
II. Sum of Monthly Settlements for Quarter Ended		\$
Net Due to (from) Reinsurer (I-II)		\$

-  
SCHEDULE F - PART IV

ANNUAL REPORT

1. Additional Premium Due:		
A. Premiums Received:		
1. Direct Premium Collected on Reinsured Policies	\$	
2. Additional Reinsurance Premium Collected from Travelers	\$	
3. Less: Premiums Paid to Travelers on retained business	\$	
Total Premiums Received (A1+A2-A3)		\$
B. 12/31/03 Due and Unpaid Premium Receivable Collected		\$
C. Stop Loss Payments Received from Travelers		\$
Total Additional Premium Due (A+B+C)		\$
2. Ultimate Net Loss Paid:		
A. Losses (Claims Incurred)		
1. Direct Losses Incurred	\$	
2. Less: Losses Reimbursed by Travelers on retained business	\$	



Total Losses (Claims Incurred) (A1+A2)		\$
B. Stop Loss Payments to Travelers	\$	
C. Allocated Loss Adjustment Expense	\$	
D. Premium Taxes Due	\$	
E. Insolvency Fund Assessments, net	\$	
F. Returns or Refunds of Premiums	\$	
G. Commissions Paid	\$	
H. Unclaimed Property Liabilities	\$	
Total Ultimate Net Loss Paid (A+B+C+D+E+F+G+H)		\$
3. Withdrawals from Claims Settlement Account		\$
4. Expense Allowance:		
A. Policy Maintenance	\$	
B. Claims	\$	
C. Traveler's Agreement Maintenance	\$	
Total Expense Commission (A+B+C)		\$
5. Additional Expenses:		
A. Novation Costs Incurred (pursuant to Section 2.6)	\$	
B. Re-rating costs incurred (pursuant to Section 3.3)	\$	
Total Additional Expense (A+B)		\$
6. Additional Ceding Commission Paid to Travelers		\$
7. Experience Refund Amounts Due to the Company Under Article VIII		\$
I. Annual Settlement Amount (1-2+3-4-5-6-7)		\$
II. Sum of Monthly Settlements for Calendar Year		\$
Net Due to (from) Reinsurer (I-II)		\$

SCHEDULE G  
FORM OF TRUST AGREEMENT

SCHEDULE H  
ELIGIBLE SECURITIES

Assets of the types for which an Illinois-domiciled life insurance company could obtain full statutory reserve credit under statutory accounting practices prescribed or permitted by the Director of Insurance of the State of Illinois.

SCHEDULE I  
EXPERIENCE REFUND<sup>1</sup>

LTC Experience Refund Sample Calculation		Scenario 1 — Base Case													
		Net Yield	5.95%	5.89%	5.83%	5.80%	5.77%	5.76%	5.75%	5.74%	5.74%	5.74%	5.72%		
		Calculated By taking Investment Income Including IMR amort and dividing by a 2 point avg of the sum of Total Ceded SAP Reserves plus IMR													
LTC Reinsurance Segment Projection	(in \$1,000's)	2004	2005	2006	2007	2008	2009	2010	2011	2012	2013	2014	2		
Premium Income	64,078	65,125	62,117	59,082	56,030	52,972	49,871	46,731	43,566	40,397	37,243	34,128	31,071	28,093	25,214
Investment Inc on LTC Rsvs (Net of Defaults & Inv Exp)	29,778	34,124	38,080	41,730	44,992	47,989	50,663	53,132	55,353	57,291	58,802	60,252	61,281	62,078	62,566
IMR Amortization for LTC Segment	255	240	229	227	231	235	245	253	263	268	282	306	330	367	393
<b>TOTAL REVENUE:</b>	<b>94,111</b>	<b>99,489</b>	<b>100,426</b>	<b>101,039</b>	<b>101,252</b>	<b>101,195</b>	<b>100,779</b>	<b>100,116</b>	<b>99,182</b>	<b>97,956</b>	<b>96,328</b>	<b>94,685</b>	<b>92,682</b>	<b>90,538</b>	<b>88,173</b>
Paid Benefits	24,105	31,590	35,922	39,479	42,266	44,330	46,397	48,606	50,999	53,518	56,105	58,705	61,252	63,691	65,960
Increase in Active Life Reserves	57,269	54,960	52,141	48,950	45,466	41,724	37,642	33,195	28,428	23,400	18,191	12,833	7,450	2,141	(3,102)
Increase in Claim Reserves (incl IBNR)	22,728	17,867	15,240	12,516	9,806	7,263	7,273	7,771	8,419	8,863	9,104	9,147	8,963	8,581	7,982
Loss Exp (Incl Rsv Change & LAE)	1,599	793	753	703	648	591	608	642	681	716	745	768	784	794	796
Expense Allowances — Commissions	7,963	8,096	7,769	7,431	7,085	6,732	6,373	6,012	5,650	5,289	4,930	4,577	4,231	3,894	3,568
Expense Allowances — Treaty (Claims Dept, PHS, Blue Sky)	3,244	2,570	2,644	2,693	2,717	2,739	2,759	2,780	2,804	2,830	2,855	2,879	2,899	2,916	2,927
Expense Allowances — BSA Expenses (COH)	1,090	1,040	1,004	968	930	892	853	813	772	731	690	649	608	568	528
Stop-loss & 10% Novation Costs	2,060	1,440	1,035	537	9,508	1,250	1,327	1,397	1,464	1,515	1,558	1,587	1,619	1,631	1,639
Impairments — 15bps	680	818	943	1,056	1,159	1,250	1,327	1,397	1,464	1,515	1,558	1,587	1,619	1,631	1,639
<b>TOTAL EXPENSES:</b>	<b>120,738</b>	<b>119,173</b>	<b>117,451</b>	<b>114,333</b>	<b>119,585</b>	<b>105,521</b>	<b>103,232</b>	<b>101,216</b>	<b>99,216</b>	<b>96,861</b>	<b>94,179</b>	<b>91,145</b>	<b>87,808</b>	<b>84,217</b>	<b>80,298</b>
<b>Pre-Tax Income 90% TLA</b>	<b>(26,627)</b>	<b>(19,684)</b>	<b>(17,025)</b>	<b>(13,294)</b>	<b>(18,334)</b>	<b>(4,325)</b>	<b>(2,454)</b>	<b>(1,100)</b>	<b>(34)</b>	<b>1,094</b>	<b>2,149</b>	<b>3,540</b>	<b>4,874</b>	<b>6,322</b>	<b>7,875</b>

10% Novation Segment Pre-Tax Profits	—	—	—	—	—	(481)	(273)	(122)	(4)	122	239	393	542	702	875
Pre-Tax Income = Experience Refund Baseline	(26,627)	(19,684)	(17,025)	(13,294)	(18,334)	(4,806)	(2,726)	(1,223)	(38)	1,216	2,388	3,934	5,416	7,024	8,750

<sup>1</sup> In recognition of the limited amount of time available to the Reinsurer to verify the accuracy of the calculation of the Experience Refund Baseline and the recent availability of 2003 experience on the Reinsured Policies, the parties to this Agreement agree to update the values set forth in the Experience Refund Baseline on this Schedule I, at any time on or before June 30, 2004, (a) to correct material errors or omissions in the models and workbooks used to derive the Experience Refund Baseline and (b) to reflect adjustments to projected rate increase filings resulting from further analysis of 2003 experience on the Reinsured Policies.

## BUSINESS ASSOCIATE ADDENDUM

### I. Purpose.

In order to disclose certain information to the party providing a service under this Agreement (“Provider”) under this Addendum, some of which may constitute Protected Health Information (defined below), the party to whom a service under this Agreement is being provided (“Recipient”) and Provider mutually agree to comply with the terms of this Addendum for the purpose of satisfying the requirements of the Health Insurance Portability and Accountability Act of 1996 (“HIPAA”) and its implementing privacy regulations at 45 C.F.R. Parts 160-164 (“HIPAA Privacy Rule”). These provisions shall apply to Provider to the extent that Provider is considered a “Business Associate” under the HIPAA Privacy Rule and all references in this section to Business Associates shall refer to Provider. Capitalized terms not otherwise defined herein shall have the meaning assigned in the Agreement. Notwithstanding anything else to the contrary in the Agreement, in the event of a conflict between this Addendum and the Agreement, the terms of this Addendum shall prevail.

### II. Permitted Uses and Disclosures.

A. Business Associate agrees to use or disclose Protected Health Information (“PHI”) that it creates for or receives from Recipient or its Subsidiaries only as follows. The capitalized term “Protected Health Information or PHI” has the meaning set forth in 45 Code of Federal Regulations Section 164.501, as amended from time to time. Generally, this term means individually identifiable health information including, without limitation, all information, data and materials, including without limitation, demographic, medical and financial information, that relates to the past, present, or future physical or mental health or condition of an individual; the provision of health care to an individual; or the past present, or future payment for the provision of health care to an individual; and that identifies the individual or with respect to which there is a reasonable basis to believe the information can be used to identify the individual. This definition shall include any demographic information concerning members and participants in, and applicants for, Recipient’s or its Subsidiaries’ health benefit plans. All other terms used in this Addendum shall have the meanings set forth in the applicable definitions under the HIPAA Privacy Rule.

B. Functions and Activities on Company’s Behalf. Business Associate is permitted to use and disclose PHI it creates for or receives from Recipient or its Subsidiaries only for the purposes described in this Addendum or the Agreement that are not inconsistent with the provisions of this Addendum, or as required by law, or following receipt of prior written approval from whichever of the Recipient or its Subsidiary for which the relevant PHI was created or from which the relevant PHI was received. In addition to these specific requirements below, Business Associate may use or disclose PHI only in a manner that would not violate the HIPAA Privacy Rule if done by the Recipient or its Subsidiaries.

C. Business Associate’s Operations. Business Associate is permitted by this Agreement to use PHI it creates for or receives from Recipient or its Subsidiaries: (i) if such use is reasonably necessary for Business Associate’s proper management and administration; and (ii) as reasonably necessary to carry out Business Associate’s legal responsibilities. Business

1

Associate is permitted to disclose PHI it creates for or receives from Recipient or its Subsidiaries for the purposes identified in this Section only if the following conditions are met:

- (1) The disclosure is required by law; or
- (2) The disclosure is reasonably necessary to Business Associate’s proper management and administration, and Business Associate obtains reasonable assurances in writing from any person or organization to which Business Associate will disclose such PHI that the person or organization will:
  - a. Hold such PHI as confidential and use or further disclose it only for the purpose for which Business Associate disclosed it to the person or organization or as required by law; and
  - b. Notify Business Associate (who will in turn promptly notify whichever of the Recipient or its Subsidiary for which the relevant PHI was created or from which the relevant PHI was received) of any instance of which the person or organization becomes aware in which the confidentiality of such PHI was breached.

D. Minimum Necessary Standard. In performing the functions and activities on Recipient’s or its Subsidiaries’ behalf pursuant to the Agreement, Business Associate agrees to use, disclose or request only the minimum necessary PHI to accomplish the purpose of the use, disclosure or request. Business Associate must have in place policies and procedures that limit the PHI disclosed to meet this minimum necessary standard.

E. Prohibition on Unauthorized Use or Disclosure. Business Associate will neither use nor disclose PHI it creates or receives for or from Recipient, its Subsidiaries, or from another business associate of Recipient or its Subsidiaries, except as permitted or required by this Addendum or the Agreement that are not inconsistent with the provisions of this Addendum, or as required by law, or following receipt of prior written approval from whichever of the Recipient or its Subsidiary for which the relevant PHI was created or from which the relevant PHI was received.

F. De-identification of Information. Business Associate agrees neither to de-identify PHI it creates for or receives from Recipient or its Subsidiaries or from another business associate of Recipient or its Subsidiaries, nor use or disclose such de-identified PHI, unless such de-identification is expressly permitted under the terms and conditions of this Addendum or the Agreement and related to Recipient’s or its Subsidiaries’ activities for purposes of “treatment”, “payment” or “health care operations”, as those terms are defined under the HIPAA Privacy Rule. De-identification of PHI, other than as expressly permitted under the terms and conditions of the Addendum for Business Associate to perform services for Recipient or its Subsidiaries, is not a permitted use of PHI under this Addendum. Business Associate further agrees that it will not create a “Limited Data Set” as defined by the HIPAA Privacy Rule using PHI it creates or receives, or receives from another business associate of Recipient or its Subsidiaries, nor use or disclose such Limited Data Set unless: (i) such creation, use or disclosure is expressly permitted under the terms and conditions of this Addendum or the Agreement that are not inconsistent with the provisions of this Addendum; and such creation, use or disclosure is for services provided by Business Associate that relate to Recipient’s or its Subsidiaries’ activities for purposes of

2

G. Information Safeguards. Business Associate will develop, document, implement, maintain and use appropriate administrative, technical and physical safeguards to preserve the integrity and confidentiality of and to prevent non-permitted use or disclosure of PHI created for or received from Recipient or its Subsidiaries. These safeguards must be appropriate to the size and complexity of Business Associate's operations and the nature and scope of its activities. Business Associate agrees that these safeguards will meet any applicable requirements set forth by the U.S. Department of Health and Human Services, including (as of the effective date or as of the compliance date, whichever is applicable) any requirements set forth in the final HIPAA security regulations. Business Associate agrees to mitigate, to the extent practicable, any harmful effect that is known to Business Associate resulting from a use or disclosure of PHI by Business Associate in violation of the requirements of this Addendum.

III. Conducting Standard Transactions. In the course of performing services for Recipient or its Subsidiaries, to the extent that Business Associate will conduct Standard Transactions for or on behalf of Recipient or its Subsidiaries, Business Associate will comply, and will require any subcontractor or agent involved with the conduct of such Standard Transactions to comply, with each applicable requirement of 45 C.F.R. Part 162. "Standard Transaction(s)" shall mean a transaction that complies with the standards set forth at 45 C.F.R. parts 160 and 162. Further, Business Associate will not enter into, or permit its subcontractors or agents to enter into, any trading partner agreement in connection with the conduct of Standard Transactions for or on behalf of the Recipient or its Subsidiaries that:

- a. Changes the definition, data condition, or use of a data element or segment in a Standard Transaction;
- b. Adds any data element or segment to the maximum defined data set;
- c. Uses any code or data element that is marked "not used" in the Standard Transaction's implementation specification or is not in the Standard Transaction's implementation specification; or
- d. Changes the meaning or intent of the Standard Transaction's implementation specification.

IV. Sub-Contractors, Agents or Other Representatives. Business Associate will require any of its subcontractors, agents or other representatives to which Business Associate is permitted by this Addendum or the Agreement (or is otherwise given Recipient's or the relevant Subsidiary's prior written approval) to disclose any of the PHI Business Associate creates or receives for or from Recipient or its Subsidiaries, to provide reasonable assurances in writing that subcontractor or agent will comply with the same restrictions and conditions that apply to the Business Associate under the terms and conditions of this Addendum with respect to such PHI.

V. Protected Health Information Access, Amendment and Disclosure Accounting.

- A. Access. Business Associate will promptly upon Recipient's or its Subsidiary's request make available to Recipient, its Subsidiary, or, at Recipient's or such Subsidiary's

3

---

direction, to the individual (or the individual's personal representative) for inspection and obtaining copies any PHI about the individual which Business Associate created for or received from Recipient or its Subsidiary and that is in Business Associate's custody or control, so that Recipient or its Subsidiary may meet its access obligations under 45 Code of Federal Regulations § 164.524.

B. Amendment. Upon Recipient's or its Subsidiary's request Business Associate will promptly amend or permit Recipient or its Subsidiary access to amend any portion of the PHI which Business Associate created for or received from Recipient or its Subsidiary, and incorporate any amendments to such PHI, so that Recipient or its Subsidiary may meet its amendment obligations under 45 Code of Federal Regulations § 164.526.

- C. Disclosure Accounting. So that Recipient or its Subsidiaries may meet their disclosure accounting obligations under 45 Code of Federal Regulations § 164.528:

1. Disclosure Tracking. Business Associate will record for each disclosure, not excepted from disclosure accounting under Section V.C.2 below, that Business Associate makes to Recipient or its Subsidiaries of PHI that Business Associate creates for or receives from Recipient or its Subsidiaries, (i) the disclosure date, (ii) the name and member or other policy identification number of the person about whom the disclosure is made, (iii) the name and (if known) address of the person or entity to whom Business Associate made the disclosure, (iv) a brief description of the PHI disclosed, and (v) a brief statement of the purpose of the disclosure (items i-v, collectively, the "disclosure information"). For repetitive disclosures Business Associate makes to the same person or entity (including Recipient or its Subsidiaries) for a single purpose, Business Associate may provide a) the disclosure information for the first of these repetitive disclosures, (b) the frequency, periodicity or number of these repetitive disclosures and (c) the date of the last of these repetitive disclosures. Business Associate will make this disclosure information available to Recipient or its Subsidiaries promptly upon Recipient's or its Subsidiaries' request.

2. Exceptions from Disclosure Tracking. Business Associate need not record disclosure information or otherwise account for disclosures of PHI that this Addendum or Recipient or the relevant Subsidiary in writing permits or requires (i) for the purpose of Recipient's or its Subsidiaries' treatment activities, payment activities, or health care operations, (ii) to the individual who is the subject of the PHI disclosed or to that individual's personal representative; (iii) to persons involved in that individual's health care or payment for health care; (iv) for notification for disaster relief purposes, (v) for national security or intelligence purposes, (vi) to law enforcement officials or correctional institutions regarding inmates; or (vii) pursuant to an authorization; (viii) for disclosures of certain PHI made as part of a Limited Data Set; (ix) for certain incidental disclosures that may occur where reasonable safeguards have been implemented; and (x) for disclosures prior to April 14, 2003.

3. Disclosure Tracking Time Periods. Business Associate must have available for Recipient and its Subsidiaries the disclosure information required by this section for the 6 years preceding Recipient's or its Subsidiaries' request for the disclosure information (except Business Associate need have no disclosure information for disclosures occurring before April 14, 2003).

4

---

VI. Additional Business Associate Provisions

- A. Reporting of Breach of Privacy Obligations. Business Associate will provide written notice to whichever of the Recipient or its Subsidiary for which the relevant PHI was created or from which the relevant PHI was received of any use or disclosure of PHI that is neither permitted by this Addendum nor given prior written approval by Recipient or the relevant Subsidiary promptly after Business Associate learns of such non-permitted use or disclosure. Business Associate's report will at least:

- (i) Identify the nature of the non-permitted use or disclosure;
- (ii) Identify the PHI used or disclosed;
- (iii) Identify who made the non-permitted use or received the non-permitted disclosure;
- (iv) Identify what corrective action Business Associate took or will take to prevent further non-permitted uses or disclosures;
- (v) Identify what Business Associate did or will do to mitigate any deleterious effect of the non-permitted use or disclosure; and
- (vi) Provide such other information, including a written report, as Recipient or the relevant Subsidiary may reasonably request.

B. Amendment. Upon the effective date of any final regulation or amendment to final regulations promulgated by the U.S. Department of Health and Human Services with respect to PHI, including, but not limited to the HIPAA privacy and security regulations, this Addendum and the Agreement will automatically be amended so that the obligations they impose on Business Associate remain in compliance with these regulations.

In addition, to the extent that new state or federal law requires changes to Business Associate's obligations under this Addendum, this Addendum shall automatically be amended to include such additional obligations, upon notice by Recipient or its Subsidiaries to Business Associate of such obligations. Business Associate's continued performance of services under the Agreement shall be deemed acceptance of these additional obligations.

C. Audit and Review of Policies and Procedures. Business Associate agrees to provide, upon Recipient request, access to and copies of any policies and procedures developed or utilized by Business Associate regarding the protection of PHI. Business Associate agrees to provide, upon Recipient's request, access to Business Associate's internal practices, books, and records, as they relate to Business Associate's services, duties and obligations set forth in this Addendum and the Agreement(s) under which Business Associate provides services and / or products to or on behalf of Recipient or its Subsidiaries, for purposes of Recipient's or its Subsidiaries' review of such internal practices, books, and records.

<sup>1</sup> In recognition of the limited amount of time available to the Reinsurer to verify the accuracy of the calculation of the Experience Refund Baseline and the recent availability of 2003 experience on the Reinsured Policies, the parties to this Agreement agree to update the values set forth in the Experience Refund Baseline on this Schedule I, at any time on or before June 30, 2004, (a) to correct material errors or omissions in the models and workbooks used to derive the Experience Refund Baseline and (b) to reflect adjustments to projected rate increase filings resulting from further analysis of 2003 experience on the Reinsured Policies.

REINSURANCE AGREEMENT  
 between  
 GE LIFE AND ANNUITY ASSURANCE COMPANY  
 and  
 UNION FIDELITY LIFE INSURANCE COMPANY  
 Dated as of April 15, 2004

TABLE OF CONTENTS

<a href="#">ARTICLE I</a>	<a href="#">DEFINITIONS</a>
<a href="#">ARTICLE II</a>	<a href="#">COVERAGE</a>
<a href="#">ARTICLE III</a>	<a href="#">ADMINISTRATION; GENERAL PROVISIONS</a>
<a href="#">ARTICLE IV</a>	<a href="#">GENERAL ACCOUNT ASSET TRANSFER; CEDING COMMISSION; INITIAL MODCO RESERVE ADJUSTMENT</a>
<a href="#">ARTICLE V</a>	<a href="#">EXPENSE ALLOWANCES</a>
<a href="#">ARTICLE VI</a>	<a href="#">ACCOUNTING AND SETTLEMENT; MODCO ADJUSTMENT</a>
<a href="#">ARTICLE VII</a>	<a href="#">DURATION AND TERMINATION</a>
<a href="#">ARTICLE VIII</a>	<a href="#">INSOLVENCY</a>
<a href="#">ARTICLE IX</a>	<a href="#">CREDIT FOR REINSURANCE</a>
<a href="#">ARTICLE X</a>	<a href="#">REINSURANCE SECURITY</a>
<a href="#">ARTICLE XI</a>	<a href="#">DEFERRED ACQUISITION COSTS</a>
<a href="#">ARTICLE XII</a>	<a href="#">DISPUTE RESOLUTION</a>
<a href="#">ARTICLE XIII</a>	<a href="#">MISCELLANEOUS PROVISIONS</a>

<u>SCHEDULES</u>	
SCHEDULE A	— POLICY FORMS
SCHEDULE B	— SEPARATE ACCOUNTS
SCHEDULE C	— FORM OF ADMINISTRATIVE SERVICES AGREEMENT
SCHEDULE D	— CEDING COMMISSION
SCHEDULE E	— ASSETS
SCHEDULE F	— EXPENSE ALLOWANCES
SCHEDULE G	— Part I - INITIAL REPORT
SCHEDULE G	— Part II - DAILY SETTLEMENT REPORT
SCHEDULE G	— Part III - MONTHLY SETTLEMENT REPORT
SCHEDULE G	— Part IV - QUARTERLY SETTLEMENT REPORT
SCHEDULE G	— Part V - ANNUAL REPORT
SCHEDULE H	— FORM OF TRUST AGREEMENT
SCHEDULE I	— ELIGIBLE SECURITIES
SCHEDULE J	— COMMISSIONS

REINSURANCE AGREEMENT

This Reinsurance Agreement, dated as of April 15, 2004 (this "Agreement"), is made and entered into by and between GE Life and Annuity Assurance Company, an insurance company organized under the laws of the Commonwealth of Virginia (the "Company"), and Union Fidelity Life Insurance Company, an insurance company organized under the laws of the State of Illinois (the "Reinsurer"). Defined terms used herein are defined below.

The Company and the Reinsurer mutually agree to reinsure the risks described in this Agreement under the terms and conditions stated herein. This Agreement is an indemnity coinsurance and modified coinsurance agreement solely between the Company and the Reinsurer, and the performance of the obligations of each party under this Agreement shall be rendered solely to the other party. In no instance shall anyone other than the Company or the Reinsurer have any rights under this Agreement. The Company shall be and shall remain the only party hereunder that is liable to any insured, Contractholder, policyholder, claimant or beneficiary under any insurance policy or contract reinsured hereunder.

This Agreement is entered into in connection with an intercompany reorganization among the Company, the Reinsurer and certain of their Affiliates.

1.1. Definitions. As used in this Agreement, the following terms shall have the following meanings (definitions are applicable to both the singular and the plural forms of each term defined in this Article):

"Affiliate" means any other Person that directly or indirectly controls, is controlled by, or is under common control with, the first Person. "Control" (including the terms, "controlled by" and "under common control with") means the possession, directly or indirectly, of the power to direct or cause the direction of the management and policies of a Person, whether through the ownership of voting securities, by contract or credit arrangement, as trustee or executor, or otherwise.

"Agreement" shall have the meaning specified in the first paragraph of this Agreement.

"Annual Report" shall have the meaning specified in Section 6.6.

"Applicable Law" means any federal, state, local or foreign law (including common law), statute, ordinance, rule, regulation, order, writ, injunction, judgment, permit, governmental agreement or decree applicable to a Person or any of such Person's subsidiaries, properties, assets, or to such Person's officers, directors, managing directors, employees or agents in their capacity as such.

"Assets" shall have the meaning specified in Section 4.4(a).

---

"Assignment Letter Agreement" means the letter agreement dated the date hereof among General Electric Capital Corporation, a Delaware corporation, the Reinsurer, the Company and certain affiliates of the Company relating to the assignment by General Electric Capital Corporation of the Capital Maintenance Agreement.

"Business Day" means any day other than a Saturday, Sunday or other day on which the New York Stock Exchange is closed for trading.

"Capital Maintenance Agreement" means the Capital Maintenance Agreement between General Electric Capital Corporation, a Delaware corporation, and the Reinsurer.

"Ceded Reinsurance" means all reinsurance ceded by the Company pursuant to contracts, binders, certificates, treaties or other evidence of reinsurance relating to the Reinsured Risks in effect on or prior to the Inception Date, except the reinsurance provided pursuant to this Agreement.

"Ceded Reinsurance Agreements" means all of the contracts, binders, certificates, treaties or other evidence for Ceded Reinsurance.

"Ceding Commission" shall have the meaning specified in Section 4.2.

"Closing Date" means April 15, 2004.

"Code" means the Internal Revenue Code of 1986, as amended.

"Commutation" means, with respect to any portion of the Ceded Reinsurance, a commutation or other similar transaction that results in the termination of such Ceded Reinsurance with respect to the Reinsured Contracts.

"Company Account" shall have the meaning specified in Section 10.1(e).

"Contractholder" shall mean the holder of any Reinsured Contract.

"CPR" shall have the meaning specified in Section 12.3.

"CPR Arbitration Rules" shall have the meaning specified in Section 12.4(a).

"Daily Settlement Account" shall have the meaning specified in Section 6.2(a).

"Daily Settlement Amount" means, with respect to a particular Business Day, the results of the calculation set forth on Schedule G - Part II for such day.

"Daily Settlement Report" shall have the meaning specified in Section 6.2(b).

"Dispute" shall have the meaning specified in Section 12.1(a).

"Eligible Securities" shall have the meaning specified in Section 10.1(c).

"Expense Allowance" shall have the meaning specified in Section 5.1.

2

---

"Extra Contractual Liabilities" means all liabilities for damages (including compensatory, consequential, exemplary, punitive, bad faith or similar or other damages) which relate to the marketing, sale, underwriting, issuance, delivery, cancellation or administration of the Reinsured Contracts, including liability arising out of or relating to any alleged or actual acts, errors or omissions by the Company or its agents, whether intentional or otherwise, with respect to any of the Reinsured Contracts, including (A) any alleged or actual reckless conduct or bad faith in connection with the handling of any claim arising out of or under Reinsured Contracts, or (B) the marketing, sale, underwriting, issuance, delivery, cancellation or administration of any of the Reinsured Contracts.

"Force Majeure" shall have the meaning specified in Section 3.10(b)(iii).

"Funding Requirement" shall have the meaning specified in Section 10.1(e).

"GAAP" means U.S. generally accepted accounting principles consistently applied.

"General Account Liabilities" means all net retained general account insurance liabilities and obligations arising under the Reinsured Contracts, including, without limitation (i) benefits, surrender amounts and other amounts payable to Contractholders under the terms of the Reinsured Contracts, (ii) premium taxes due in respect of premiums and other consideration paid on or after the Inception Date with respect to the Reinsured Contracts, (iii) Insolvency Fund or other premium based assessments, net of any premium tax credits of the Company arising out of any such assessments, based on premiums and other consideration paid on or after the Inception Date with respect to the Reinsured Contracts, (iv) all amounts payable on or after the Inception Date for returns or refunds of premiums under the Reinsured Contracts, (v) all liability for commission payments and other fees or compensation payable with respect to the Reinsured Contracts in respect of premiums and other consideration paid on or after the Inception Date and (vi) all Extra Contractual Liabilities resulting from actions of the Company or its agents to the extent reinsurance of such liabilities is permitted by state law; but in all cases excluding: (w) the Separate Account Liabilities; (x) Post-Inception Date Extra Contractual Liabilities; (y) any general account liabilities which relate to (A) amounts transferred from the Separate Accounts to the general account of the Company pending distribution to holders of the Reinsured Contracts, and (B) amounts held in the general account of the Company pending transfer to the Separate Accounts; and (z) compensation agreements, arrangements and practices (A) that exceed the broker commission rates as shown for each product on Schedule J, (B) that exceed the wholesale expense rates as shown for each product on Schedule J, (C) that exceed the firm marketing related expense reimbursement rates as shown for each firm on Schedule J, (D) that exceed the marketing allowance as shown on Schedule J, or (E) that result from changes to compensation plans for any sales organization on or after the Inception Date, unless otherwise agreed to in writing by the Reinsurer or to the extent such excess costs are offset by an increase in the fund company administrative expense service share referred to in Schedule F.

"General Account Reserves" means the general account statutory reserves of the Company (without regard to the transactions contemplated by this Agreement) with respect to the General Account Liabilities determined pursuant to SAP, as such reserves would have been

3

---

included in lines 1 and 13 of the Liabilities, Surplus and Other Funds page of the NAIC Annual Statement Blank (2003 Format).

"Governmental Authority" means any foreign or national government, any state or other political subdivision thereof or any self regulatory authority, and any entity exercising executive, legislative, judicial, regulatory or administrative functions of or pertaining to government.

"Inception Date" shall have the meaning specified in Section 2.1(a).

"Initial MODCO Reserve Adjustment" means the amount specified in Section 4.3.

"Initial Notice" shall have the meaning specified in Section 12.2.

"Initial Reinsurance Premium" shall have the meaning specified in Section 4.1(a).

"Initial Report" shall have the meaning specified in Section 6.1.

"Insolvency Fund" means any guarantee fund, insolvency fund, plan, pool, association, fund or other arrangement, however denominated, established or governed, which provides for any assessment of or payment or assumption by the Company of part or all of any claim, debt, charge, fee or other obligation of an insurer or reinsurer, or its successors or assigns, which has been declared by any competent authority to be insolvent, or which is otherwise deemed unable to meet any claim, debt, charge, fee or other obligation in whole or in part.

"Monthly Accounting Period" means each calendar month, except that the last Monthly Accounting Period shall be the period commencing with the first day of the calendar month in which the Termination Date falls and ending with the Termination Date.

"Monthly Settlement" shall have the meaning specified in Section 4.4(a).

"Monthly Settlement Report" shall have the meaning specified in Section 6.3.

"NAIC" means the National Association of Insurance Commissioners.

"Non-Guaranteed Elements" shall have the meaning specified in Section 3.3.

"Person" means any natural person, firm, limited liability company, general partnership, limited partnership, joint venture, association, corporation, trust, Governmental Authority or other entity.

"Post-Inception Date Extra Contractual Liabilities" means Extra Contractual Liabilities attributable to the conduct of the Company on or after the Inception Date in connection with the Company's administration of the Reinsured Contracts, other than actions taken by the Company at the written request or direction of the Reinsurer or in connection with the Company's marketing activities with respect to the Reinsured Contracts.

"Quarterly Accounting Period" means each calendar quarter, except that the last Quarterly Accounting Period shall be the period commencing with the first day of the calendar quarter in which the Termination Date falls and ending with the Termination Date.

"Quarterly Accounting Period MODCO Adjustment" shall have the meaning set forth in Section 6.7.

"Quarterly Settlement" shall have the meaning specified in Section 4.4(a).

"Quarterly Settlement Report" shall have the meaning specified in Section 6.4.

"RBC Reporting Letter Agreement" means the letter agreement dated the date hereof among the Company, the Reinsurer and certain affiliates of the Company relating to the Reinsurer's requirement to provide periodic certifications and reports regarding the Reinsurer's risk based capital ratio.

"Reinsurance Recoverables" means the amount of reinsurance recoverables that are actually collected under Ceded Reinsurance.

"Reinsured Contracts" means the variable annuity contracts issued by the Company and recorded in the Company's administration system on or prior to December 4, 2003 and written on the policy forms described in Schedule A, including any contract riders or endorsements issued with respect thereto after the Inception Date with the prior written consent of the Reinsurer.

"Reinsured Risks" shall have the meaning specified in Section 2.1(a).

"Response" shall have the meaning specified in Section 12.2.

"SAP" means statutory accounting practices prescribed or permitted by the Insurance Department of the Commonwealth of Virginia.

"Separate Account Charges" shall have the meaning specified in Section 4.1(b).

"Separate Account Liabilities" means those insurance liabilities that are reflected in the Separate Accounts and that relate to the Reinsured Contracts, including (i) amounts transferred from the Separate Accounts to the general account of the Company pending distribution to holders of the Reinsured Contracts, and (ii) amounts held in the general account of the Company pending transfer to the Separate Accounts.

"Separate Account Reserves" means the separate account statutory reserves of the Separate Accounts (without regard to the transactions contemplated by this Agreement) with respect to the Reinsured Contracts determined pursuant to SAP, as such reserves would have been included in line 27 of the Liabilities, Surplus and Other Funds page of the NAIC Annual Statement Blank (2003 Format).

"Separate Accounts" means the separate accounts of the Company described on Schedule B hereto.

"Tax DAC" means specified policy acquisition expenses capitalized and amortized under section 848 of the Code.

"Termination Date" means the effective date of any termination of this Agreement as provided in Article VII.

"Termination Letter Agreement" means the letter agreement dated the date hereof among the Company, the Reinsurer and certain affiliates of the Company relating to the rescission of this Agreement upon the failure of certain events to occur after the date hereof.

"Trust Account" shall have the meaning specified in Section 10.1(a).

"Trust Agreement" shall have the meaning specified in Section 10.1(a).

"Trustee" shall have the meaning specified in Section 10.1(a).

## ARTICLE II

### COVERAGE

2.1. Coverage. (a) Upon the terms and subject to the conditions and other provisions of this Agreement, as of 12:01 a.m. Eastern Time on January 1, 2004 (the "Inception Date"), the Company hereby cedes to the Reinsurer, and the Reinsurer hereby agrees to indemnify the Company (i) on a coinsurance basis, for one hundred percent (100%) of the General Account Liabilities and (ii) on a modified coinsurance basis, for 100% of the Separate Account Liabilities, in each case, payable by the Company under the Reinsured Contracts on or after the Inception Date (the "Reinsured Risks"). For the avoidance of doubt, the Reinsurer shall assume the risk for all uncollectible or uncollected reinsurance recoverables under the Ceded Reinsurance.

(b) Upon the annuitization of a Reinsured Contract, such Reinsured Contract will be considered surrendered and the Reinsurer will pay to the Company an amount equal to the general account value applied to the annuitization. In such event, no further obligation or liability will exist for the Reinsurer with respect to such annuitized Reinsured Contract.

2.2. Conditions. (a) If the Company's liability under any of the Reinsured Contracts is changed because of changes made on or after the Inception Date in the terms and conditions of the Reinsured Contracts (including to any contract riders or endorsements thereto) that are required due to changes in Applicable Law, the Reinsurer will share in the change proportionately to the coinsurance share hereunder and the Company and the Reinsurer will make all appropriate adjustments to amounts due each other under this Agreement.

(b) Except as otherwise set forth or contemplated herein, including in paragraph (a) above, no changes, amendments or modifications made on or after the Inception Date in the terms and conditions of the Reinsured Contracts (including to any contract riders or endorsements thereto) which adversely affect the liability of the Reinsurer hereunder shall be covered hereunder without the prior written approval of such changes, amendments or modifications by the Reinsurer, which approval shall not be unreasonably withheld or delayed. In the event that any such changes, amendments or

modifications are made in any Reinsured Contract without the prior written approval of the Reinsurer, this Agreement will cover Reinsured Risks incurred by the Company under such Reinsured Contract as if the non-approved changes, amendments or modifications had not been made.

(c) The Company will not change fund options for the Separate Accounts from and after the Inception Date unless such changes are made: (a) with the prior written consent of the Reinsurer, in its sole discretion, (b) in fulfillment of the fiduciary obligations of the Company after consultation with the Reinsurer or (c) by the Board of Trustees of an unaffiliated fund (trust) to liquidate, merge or remove a fund pursuant to the terms of the then existing fund participation agreements or through a regulatory process.

2.3. Territory. The territorial limits of this Agreement shall be identical with those of the Reinsured Contracts.

2.4. Commutation of Ceded Reinsurance. (a) The Company shall not, without the Reinsurer's prior written approval in its sole discretion, take any action to amend, waive or terminate, in whole or in part, any Ceded Reinsurance under any Ceded Reinsurance Agreement or enter into any Commutation of Ceded Reinsurance.

(b) Subsequent to the Inception Date, the Company will not enter into any reinsurance arrangements with respect to the Reinsured Contracts without the prior written consent of the Reinsurer, in its sole discretion.

## ARTICLE III

### ADMINISTRATION: GENERAL PROVISIONS

3.1. Contract Administration. (a) Subject to Section 3.10, the Company shall provide policyholder and claims servicing with respect to the Reinsured Contracts and administer the Separate Accounts in accordance with the terms hereof including, but not limited to, the collection of premiums and other amounts due from Contractholders, the payment of all General Account Liabilities and Separate Account Liabilities and the administration of claims and disbursements, which disbursements shall be made (i) directly by the Company with respect to such disbursements relating to the General Account Liabilities and (ii) from the Separate Accounts with respect to such disbursements relating to the Separate Account Liabilities. The Company shall provide policyholder and claims servicing with respect to the Reinsured Contracts and administer the Separate Accounts in good faith and with the care, skill, prudence and diligence of a person experienced in administering variable annuity business. The Company shall provide policyholder and claims servicing with respect to the Reinsured Contracts and administer the Separate Accounts, (i) in accordance with the terms of the Reinsured Contracts, (ii) in accordance with the applicable terms of this Agreement, (iii) in compliance with Applicable Law and, subject to the foregoing, (iv) in the same manner as it conducts its own business not subject to this Agreement and (v) in accordance with the Company's administrative performance standards in effect on the date hereof, with such revisions to such standards as are

no less favorable to the Reinsurer than such standards. Notwithstanding the foregoing, the parties may, from time to time, mutually develop specific and/or different standards for providing such services with respect to the Reinsured Contracts and the Separate Accounts.

(b) The Company may subcontract for the performance of any policyholder or claims servicing service or services with respect to the Reinsured Contracts or any services the Company is to provide in the administration of the Separate Accounts to (i) an Affiliate or (ii) any other Person with the prior written consent of the Reinsurer, such consent not to be unreasonably withheld; provided, that the Company also subcontracts for such service or services for its own variable annuities business not subject to this Agreement to such subcontractor; and provided, further, that no such subcontracting shall relieve the Company from any of its obligations or liabilities hereunder, and the Company shall remain responsible for all obligations or liabilities of such subcontractor with regards to the providing of such service or services as if provided by the Company.

3.2. Ceded Reinsurance Agreements. The Company shall manage and administer the Ceded Reinsurance Agreements, including providing all reports and notices required with regard to the Ceded Reinsurance Agreements to the reinsurers within the time required by the applicable reinsurance agreement and doing all other things necessary to comply with the terms and conditions of the Ceded Reinsurance Agreements. Without limiting the foregoing, the Company shall timely pay all reinsurance premiums due to reinsurers under the Ceded Reinsurance Agreements and diligently collect from such reinsurers all reinsurance recoverables due thereunder.

3.3. Non-Guaranteed Elements. The Company shall set all rider charges, interest rates to be credited on the Reinsured Contracts and other non-guaranteed elements of the Reinsured Contracts ("Non-Guaranteed Elements") from and after the Inception Date. The Company shall allow the Reinsurer to participate in all decisions made by the Company with respect to setting Non-Guaranteed Elements.

3.4. Policy Exchanges. Unless otherwise agreed by the parties, the Company will not make any targeted exchange offers with regards to the Reinsured Contracts or otherwise target the Reinsured Contracts for replacement.

3.5. Claims Settlements. The Company agrees that it will provide prompt notice to the Reinsurer of its intention to contest, compromise or litigate a claim with respect to a Reinsured Contract, along with copies of all pleadings and reports of investigation with respect thereto. The Reinsurer shall have the right, at its own expense, to participate jointly with the Company in the investigation, adjustment or defense of such claims. In addition, in the event that litigation arises against the Company in connection with a claim which seeks damages in excess of \$1 million or other remedies deemed material to the Reinsurer, the Reinsurer may, upon written notice to the Company, assume the defense thereof with counsel selected by the Reinsurer and reasonably satisfactory to the Company. If the Reinsurer assumes such defense, the Company shall have the right, at its own expense, to participate jointly with the Reinsurer in the defense thereof. If the Reinsurer assumes the defense of litigation, the Reinsurer shall not settle such litigation without the Company's prior written consent (which consent shall not be unreasonably withheld or delayed) unless (i) there is no finding or admission of any violation of law or any violation of

8

the rights of any Person, (ii) such settlement would not reasonably be expected to have material adverse precedential consequences to the Company and (iii) the sole relief provided is monetary damages that are paid in full by the Reinsurer.

3.6. Inspection. The Company shall keep accurate and complete records, files and accounts of all transactions and matters with respect to the Reinsured Contracts and the Company's administration thereof in accordance with Applicable Law and its record management practices in effect from time to time for the Company's insurance business not covered by this Agreement. The Reinsurer and its designated representatives may upon reasonable notice inspect, at the offices of the Company where such records are located, the papers and any and all other books or documents of the Company reasonably relating to this Agreement, including the Reinsured Contracts and the administration thereof by the Company (including compliance with the provisions of Section 3.1), and shall have access to appropriate employees and representatives of the Company, in each case during normal business hours for such period as this Agreement is in effect or for as long thereafter as the Company seeks performance by the Reinsurer pursuant to the terms of this Agreement or the Reinsurer reasonably needs access to such records for regulatory, tax or similar purposes. The information obtained shall be used only for purposes relating to the transactions contemplated under this Agreement.

3.7. Errors and Omissions. If any delay, omission, error or failure to pay amounts due or to perform any other act required by this Agreement is unintentional and caused by misunderstanding or oversight, the Company and the Reinsurer will adjust the situation to what it would have been had the misunderstanding or oversight not occurred. The party first discovering such misunderstanding or oversight, or an act resulting from such misunderstanding or oversight, will notify the other party in writing promptly upon discovery thereof, and the parties shall act to correct such misunderstanding or oversight within twenty (20) Business Days of such other party's receipt of such notice. However, this Section shall not be construed as a waiver by either party of its right to enforce strictly the terms of this Agreement.

3.8. Age, Sex and Other Adjustments. If the Company's liability under any of the Reinsured Contracts is changed because of a misstatement of age or sex or any other material fact, the Reinsurer will share in the change proportionately to the coinsurance share hereunder and the Company and the Reinsurer will make all appropriate adjustments to amounts due each other under this Agreement.

3.9. Setoff. Any debts or credits, matured or unmatured, in favor of or against either the Company or the Reinsurer with respect to this Agreement or any other reinsurance agreement between the Company and the Reinsurer, are deemed mutual debts or credits, as the case may be, and shall be setoff from any amounts due to the Company or the Reinsurer hereunder, as the case may be, and only the net balance shall be allowed or paid.

3.10. Administration by Reinsurer. (a) At any time from and after the fifteenth (15th) anniversary of the Inception Date, the Reinsurer shall have the right to assume from the Company the administration of the Reinsured Contracts, provided that the Reinsurer provides twelve (12) months prior written notice of such assumption, which notice may be given as early as the fourteenth (14th) anniversary of the Inception Date to take effect as of the fifteenth (15th)

9

anniversary of the Inception Date. The Reinsurer shall bear all transition costs associated with an assumption of the administration of the Reinsured Contracts pursuant to this paragraph (a) of this Section 3.10.

(b) In addition to the provisions of Section 3.10(a), the Reinsurer shall have the right, upon written notice to the Company, to assume from the Company, the administration of the Reinsured Contracts upon the occurrence of any of the following events:

(i) A voluntary or involuntary proceeding is commenced in any jurisdiction by or against the Company for the purpose of conserving, rehabilitating or liquidating the Company;

(ii) There is a material breach by the Company of any material term or condition of this Article III that is not cured by the Company within thirty (30) days after receipt of written notice from the Reinsurer of such breach or act (provided that the Reinsurer shall not have the right to assume such administration (A) for so long as the Company is making a good faith effort to cure such a breach, not to exceed an additional one hundred eighty (180) days or (B) during the pendency of any dispute resolution proceedings as set forth in Article XII regarding an alleged material breach); or

(iii) The Company is unable to perform the services required under this Article III for a period of thirty (30) consecutive days for any reason, other than as a result of a Force Majeure, it being understood that nothing in this Section 3.10(b)(iii) shall relieve the Company from its administrative responsibilities under this Agreement. For purposes of this Agreement "Force Majeure" means any acts or omissions of any civil or military authority, acts of God, acts or omissions of the Reinsurer, fires, strikes or other labor disturbances, equipment failures, fluctuations or non-availability of electrical power, heat, light, air conditioning or telecommunications equipment, or any other act, omission or occurrence beyond the Company's reasonable control, irrespective of whether similar to the foregoing enumerated acts, omissions or occurrences.

(c) The Company shall bear all transition costs associated with an assumption of the administration of the Reinsured Contracts pursuant to Section 3.10(b).

(d) In the event of the Reinsurer's assumption of the administration of the Reinsured Contracts, the Reinsurer and the Company shall enter into an administrative services agreement in the form attached hereto as Schedule C and the provisions of Section 2.1(b), Article V and Article VI shall become inoperative.

(e) In the event that the Reinsurer is not properly licensed to administer the Reinsured Contracts at the time of a proposed transfer of administration under this Section 3.10, the Reinsurer may designate a properly licensed entity that has appropriately trained and licensed personnel reasonably acceptable to the Company to administer the Reinsured Contracts

10

in its stead, and the administrative services agreement referred to in paragraph (d) above shall be executed by such properly licensed entity in lieu of the Reinsurer. The designation and assumption of administration by such entity shall not relieve the Reinsurer from any of its obligations or liabilities hereunder (except as set forth in paragraph (d) above), and the Reinsurer shall remain responsible for all obligations or liabilities of such entity with regards to the providing of such administration as if provided by the Reinsurer. The parties shall take all actions reasonably necessary to effect the prompt transfer of administration provided in this Section 3.10.

(f) In the event of the assumption of the administration of the Reinsured Contracts under this Section 3.10, the Reinsurer and the Company shall take all actions necessary or appropriate to transfer administration of the Separate Account Liabilities to the Reinsurer or its permitted designee. Such actions shall include, without limitation, the establishment and maintenance of a new separate account of the Company solely for the Reinsured Contracts and the transfer of the assets of the Separate Account allocable to the Reinsured Contracts to such new separate account.

#### ARTICLE IV

##### GENERAL ACCOUNT ASSET TRANSFER; CEDING COMMISSION; INITIAL MODCO RESERVE ADJUSTMENT

4.1. Asset Transfer. (a) As consideration for the reinsurance by the Reinsurer of the General Account Liabilities under this Agreement, on the Closing Date, the Reinsurer shall be entitled to an amount equal to one hundred percent (100%) of the General Account Reserves as of the close of business on the day immediately preceding the Inception Date (the "Initial Reinsurance Premium").

(b) As additional consideration for the Reinsurer entering into this Agreement, the Reinsurer shall be entitled to 100% of all premiums and other considerations to the extent received on or after the Inception Date by the Company or the Reinsurer with respect to the General Account Liabilities, less an amount equal to the reinsurance premium due under the Ceded Reinsurance Agreements to the extent such premium relates to coverage on or after the Inception Date with respect to the Reinsured Contracts. In addition, with respect to the Separate Account Liabilities, the Reinsurer shall be entitled to 100% of all (i) mortality and expense risk charges and administrative expense charges (collectively, "asset charges"), any rider charges (to the extent the riders are reinsured hereunder), and contract maintenance charges, back-end sales loads and other considerations billed separately for the Reinsured Contracts collected by the Company on or after the Inception Date, and (ii) any other charges, fees and similar amounts received by the Company from the Separate Accounts on or after the Inception Date (collectively, the "Separate Account Funds"). The Company hereby assigns to the Reinsurer all of its rights to such premiums and other considerations payable to the Company. For the avoidance of doubt, the Separate Account Charges shall not include any distribution fees received from underlying mutual funds pursuant to a plan adopted pursuant to Rule 12b-1 under the Investment Company Act of 1940.

11

4.2. Ceding Commission. On the Closing Date, the Company shall be entitled to a ceding commission (the "Ceding Commission") in an amount determined in accordance with Schedule D.

4.3. Initial MODCO Reserve Adjustment. As additional consideration for the reinsurance by the Reinsurer of the Separate Account Liabilities under this Agreement, on the Closing Date, the Company shall transfer to the Reinsurer an amount equal to the net of (a) minus (b) where (a) is an amount equal to the Separate Account Liabilities as of the Inception Date and (b) is the Initial MODCO Reserve Adjustment. The "Initial MODCO Reserve Adjustment" shall be an amount equal to the Separate Account Liabilities as of the Inception Date.

4.4. Amounts Due the Parties. (a) Except as otherwise specifically provided herein, all amounts due to be paid to the Company or the Reinsurer under this Agreement shall be determined on a net basis, giving full effect to Section 3.9. The net amount due the Reinsurer from the Company on the Closing Date under Section 4.1(a) and Section 4.2 shall consist of (i) the investment assets (the "Assets") set forth on Schedule E, which assets have a statutory book value as of the close of business on the day immediately preceding the Inception Date equal to (A) the Initial Reinsurance Premium, less (B) the Ceding Commission, less (C) an amount equal to accrued but unpaid interest on the Assets as of the close of business on the day immediately preceding the Inception Date, plus (ii) an amount equal to the investment cash flows received on the Assets between the Inception Date and the Closing Date. The Company shall pay such net amount concurrent with its delivery of the Initial Report. Each net amount subsequently due the Company or the Reinsurer with respect to each Monthly Accounting Period ending after the Inception Date as reflected on a Monthly Settlement Report (the "Monthly Settlement") shall be paid in cash by the owing party no later than thirty (30) days after delivery of the Monthly Settlement Report. Each net amount subsequently due the Company or the Reinsurer with respect to each Quarterly Accounting Period ending after the Inception Date as reflected on a Quarterly Settlement Report (the "Quarterly Settlement") shall be paid in cash by the owing party no later than thirty (30) days after delivery of the Quarterly Settlement Report. Each net amount subsequently due the Company or the Reinsurer with respect to each calendar year ending after the Inception Date as reflected on an Annual Report shall be paid in cash by the owing party no later than thirty (30) days after delivery of the Annual Report.

(b) The Company shall deliver to the Reinsurer possession of the Assets and such bills of sale, endorsements, assignments and other good and sufficient instruments of conveyance and transfer in form and substance reasonably acceptable to the parties as shall be effective to vest in the Reinsurer all of the right, title and interest of the Company in and to the Assets. Delivery of the Assets shall be a condition precedent of reinsurance coverage hereunder.

12



ARTICLE V

EXPENSE ALLOWANCES

5.1. Expense Allowance. As reimbursement for expenses incurred by the Company in the providing of policyholder and claims servicing services with respect to the Reinsured Contracts, the Reinsurer shall pay to the Company with respect to each Monthly Accounting Period ending after the Inception Date, an expense allowance (each an "Expense Allowance") in an amount calculated in accordance with Schedule F, as subsequently adjusted in accordance with the methodology and procedures set forth on Schedule F; provided that if the amount calculated in accordance with Schedule F with respect to any Monthly Accounting Period should be negative, such negative amount shall be credited to the Reinsurer on the Monthly Settlement Report for such period.

ARTICLE VI

ACCOUNTING AND SETTLEMENT; MODCO ADJUSTMENT

- 6.1. Initial Report. A report shall be provided by the Company to the Reinsurer on the Closing Date providing the data required in Schedule G - Part I (the "Initial Report").
- 6.2. Daily Settlement Amounts. (a) On the Closing Date, the Reinsurer shall establish a separate bank account (the "Daily Settlement Account") in its own name for the payment of Daily Settlement Amounts and shall authorize at least two signatories who shall be representatives of the Company and approved by the Reinsurer to make deposits to, and withdrawals from, the Daily Settlement Account.
- (b) By 10:00 a.m. Eastern Time each Business Day following the Closing Date during the term of this Agreement, the Company shall calculate the Daily Settlement Amount for the prior Business Day. Promptly following such calculation, the Company shall forward to the Reinsurer a report in the form of Schedule G - Part II that shall provide the details of such calculation (the "Daily Settlement Report"). Prior to 6:00 p.m. of such Business Day, the Company or the Reinsurer, as appropriate, shall deposit into the Daily Settlement Account an amount equal to such Daily Settlement Amount owed by such party to the other. The party to whom such Daily Settlement Amount is owed shall have a right to withdraw such deposited amount at any time following such deposit.
- (c) The Company shall keep true and complete records, in accordance with Applicable Law and its record management practices in effect from time to time for the Company's insurance business not covered by this Agreement, clearly recording the deposits in and withdrawals from the Daily Settlement Account. The Company will make available to the Reinsurer or its designated representative, or shall furnish to the Reinsurer or its designated representative, upon request of the Reinsurer or its designated representative, copies of all such records. All copies furnished in the ordinary course of business shall be furnished by the Company at the Company's cost, which shall be included in the Expense Allowance. Any

13

extraordinary costs reasonably incurred by the Company in response to requests from the Reinsurer shall be reimbursed by the Reinsurer.

- (d) The parties agree to deliver to the depository bank such depository resolutions, signature cards and other documents as may be requested of them in order to use such accounts at the depository bank in accordance with the provisions of this Section 6.2.
- (e) Upon a termination of this Agreement pursuant to Article VII, the Reinsurer shall close the Daily Settlement Account and any closing balance therein shall be the property of the Reinsurer.
- 6.3. Monthly Settlement Reports. As soon as practicable but not more than thirty (30) days following the end of each Monthly Accounting Period ending after the Closing Date (or more frequently as mutually agreed by the parties), the Company shall supply the Reinsurer with a report that shall provide the financial data for such Monthly Accounting Period required in Schedule G - Part III (the "Monthly Settlement Report").
- 6.4. Quarterly Settlement Reports. As soon as practicable but not more than forty (40) days following the end of each Quarterly Accounting Period ending after the Closing Date (or more frequently as mutually agreed by the parties), the Company shall supply the Reinsurer with a report that shall provide the financial data for such Quarterly Accounting Period required in Schedule G - Part IV (the "Quarterly Settlement Report"). The Company and the Reinsurer agree that the financial data set forth on the Monthly Settlement Reports used for purposes of the Monthly Settlements, shall be true-up to actual amounts in the next Quarterly Settlement Report and the net amount, if any, subsequently due to the Company or the Reinsurer, as the case may be, as a result of such adjustments shall be paid to the Company or the Reinsurer, as applicable. For the avoidance of doubt, the first Quarterly Settlement Report will include all transactions with respect to the Reinsured Contracts occurring from the Inception Date through June 30, 2004.
- 6.5. Quarterly Financial Reports. As soon as practicable but not more than forty (40) days following the end of each Quarterly Accounting Period ending after the Closing Date (or more frequently as mutually agreed by the parties), the Company shall supply the Reinsurer with reports related to the Reinsured Contracts as may be reasonably requested for use in connection with the preparation of the Reinsurer's SAP financial statements or other reports prepared by the Reinsurer in compliance with its internal reporting requirements. The parties shall cooperate in good faith to establish the form for the providing of such reports.
- 6.6. Annual Reports. Within forty-five (45) days after the end of each calendar year during the term of this Agreement (or more frequently as mutually agreed by the parties), the Company shall supply the Reinsurer with a report that shall provide the financial data for such year required in Schedule G - Part V (the "Annual Report").
- 6.7. Accounting Period MODCO Reserve Adjustment. At the end of each Quarterly Accounting Period, the Company shall compute an amount equal to the absolute value of the increase or decrease in the Separate Account Reserves due to subaccount investment performance for the Quarterly Accounting Period just ended (the "Quarterly Accounting Period

14

MODCO Adjustment"). The Quarterly Accounting Period MODCO Adjustment for each Quarterly Accounting Period shall be reflected in the Quarterly Settlement Report for such Quarterly Accounting Period.

- 6.8. Additional Reports and Updates. For so long as this Agreement remains in effect, each of the parties shall periodically furnish to the other such other reports and information as may be reasonably requested by such other party for regulatory, tax or similar purposes and reasonably available to it.
- 6.9. Delayed Payments. In the event that all or any portion of any payment due either party pursuant to this Agreement becomes overdue, the portion of the amount overdue shall bear interest at an annual rate equal to the then current thirty (30) day U.S. Treasury Bill discount rate on the date that the payment becomes overdue plus 200 basis points, for the period that the amount is overdue.

ARTICLE VII

DURATION AND TERMINATION

- 7.1. Duration. Except as otherwise provided herein, this Agreement shall be unlimited in duration.
- 7.2. Reinsurer's Liability. The Reinsurer's liability with respect to the Reinsured Risks will terminate on the earliest of: (i) the date the Company's liability with respect to the Reinsured Risks is terminated and all amounts due the Company from the Reinsurer with respect to such Reinsured Risks are paid to the Company by or on behalf of the Reinsurer; and (ii) the date this Agreement is terminated upon the written agreement of the parties.
- 7.3. Notice of Termination. Upon the termination of the Reinsurer's liability with respect to the Reinsured Risks referred to in Section 7.2 above, the parties shall mutually give the Trustee written notice of their intention to terminate the Trust Account.

ARTICLE VIII

INSOLVENCY

8.1. Payments. In the event of the insolvency of the Company, the reinsurance payable by the Reinsurer hereunder shall be payable directly to the Company or to its domiciliary liquidator or receiver on the basis of the liability of the Reinsurer under the contract or contracts reinsured, without diminution because of the insolvency of the Company. It is agreed and understood, however, that (i) in the event of the insolvency of the Company, the Reinsurer shall be given written notice of the pendency of a claim against the insolvent Company on a Reinsured Contract within a reasonable time after such claim is filed in the insolvency proceeding and (ii) during the pendency of such claim the Reinsurer may investigate such claim and interpose, at its own expense, in the proceeding where such claim is to be adjudicated any

15

defenses which it may deem available to the Company or its domiciliary liquidator, receiver or statutory successor.

8.2. Expenses. It is further understood that any expense thus incurred by the Reinsurer pursuant to Section 8.1 shall be chargeable, subject to court approval, against the insolvent Company as part of the expense of liquidation to the extent of a proportionate share of the benefit which may accrue to the Company solely as a result of the defense undertaken by the Reinsurer. Where two or more assuming reinsurers are involved in the same claim and a majority in interest elect to interpose defenses to such claim, the expense shall be apportioned in accordance with the terms of this Agreement as though such expense had been incurred by the Company.

ARTICLE IX

CREDIT FOR REINSURANCE

9.1. Reinsurance Credit. Notwithstanding any other provision of this Agreement to the contrary, if the Reinsurer becomes unauthorized or otherwise unaccredited as an insurer or reinsurer in any U.S. jurisdiction to which the Company must provide statutory statements of financial condition such that the Company will not obtain full statutory financial statement credit for reinsurance in such state for the reinsurance provided under this Agreement, the Reinsurer, upon the request of the Company, will establish, at the Reinsurer's sole cost and option, any trust accounts for the benefit of the Company, letters of credit, or other acceptable alternatives necessary to permit the Company to obtain such full statutory financial statement credit for such reinsurance in all applicable jurisdictions. The Company shall cooperate with the Reinsurer to take such steps. In addition, in such event, the Reinsurer agrees to amend this Agreement and the Trust Agreement to the extent required under Applicable Law in order to provide the Company with such full statutory financial statement credit.

ARTICLE X

REINSURANCE SECURITY

10.1. Trust. (a) On the Closing Date, the Reinsurer shall enter into a trust agreement in the form attached as Schedule H (the "Trust Agreement") and establish a trust account (the "Trust Account") for the benefit of the Company with respect to the Reinsured Risks with a bank (the "Trustee") designated as a Qualified United States Financial Institution by the Securities Valuation Office of the National Association of Insurance Commissioners or any successor organization or regulatory agency having similar duties.

(b) The Reinsurer agrees to deposit, and maintain in the Trust Account with respect to this Agreement, assets to be held in trust by the Trustee for the benefit of the Company as security for the payment of the Reinsurer's obligations to the Company under this Agreement.

16

(c) The parties agree that the assets so deposited with respect to this Agreement shall be valued according to their current statutory book value on the books of the Reinsurer and shall consist only of cash (United States legal tender), certificates of deposit (issued by a United States bank and payable in United States legal tender), and other assets of the type specified on Schedule I attached hereto ("Eligible Securities").

(d) The Reinsurer, prior to depositing assets with the Trustee, shall execute all assignments and endorsements in blank, or transfer legal title to the Trustee of all shares, obligations or any other assets requiring assignments, in order that, to the extent practicable, the Company, or the Trustee upon direction of the Company, may whenever necessary negotiate any such assets without consent or signature from the Reinsurer or any other entity. The Company recognizes that certain assets in the Trust Account will not be readily negotiable and that certain notices, opinions of counsel, representations and/or consents will be required for the Company to obtain good and marketable title to such assets.

(e) The Reinsurer and the Company agree that the assets in the Trust Account with respect to this Agreement may be withdrawn for the following purposes only:

(i) to pay or reimburse the Company for any amount due the Company pursuant to this Agreement to the extent not so paid or reimbursed by the Reinsurer;

(ii) to pay to the Reinsurer, in accordance with paragraph (h) below, any amounts held in the Trust Account that exceed an amount (the "Funding Requirement") equal to the sum of General Account Reserves and any additional reserves attributable to the Reinsured Risks that arise as a result of regulatory asset adequacy analysis requirements of the Reinsurer; and

(iii) in the event that General Electric Capital Corporation breaches its obligations under the Capital Maintenance Agreement, to fund an account with the Company (the "Company Account") in an amount at least equal to the deduction, for reinsurance ceded, from the Company's liabilities ceded under this Agreement. Such amount shall include, but not be limited to, amounts for policy reserves, reserves for claims and losses incurred (including losses incurred but not reported), loss and loss adjustment expenses, and unearned premiums.

(f) In the event that the Company withdraws assets from the Trust Account for the purposes set forth in Section 10.1(e)(i) above in excess of actual amounts required to meet the Reinsurer's obligations to the Company, the Company will promptly return such excess to the Reinsurer plus interest at an annual rate equal to the then current thirty (30) day U.S. Treasury Bill discount rate on the date of withdrawal plus 200 basis points for the period during which the amounts were held pursuant to Section 10.1(e)(i). In the event that the Company withdraws assets from the Trust Account for the purposes set forth in Section 10.1(e)(iii) above, (i) the Reinsurer shall be relieved of its obligation to maintain assets in the Trust Account pursuant to this Section 10.1 to the extent of the amount of funds held in the Company Account and (ii) the Company shall first apply the funds in the Company Account in satisfaction of the

17

Reinsurer's liability under this Agreement until the funds in the Company Account are exhausted. In the event that the Company withdraws assets from the Trust Account for the purposes set forth in Section 10.1(e)(iii) above, promptly following the date the Reinsurer's liability with respect to the Reinsured Risks is terminated, the Company shall return to the Reinsurer any assets so withdrawn that, together with any and all interest, dividends and other earnings thereon from the date of withdrawal to the date of return, are in excess of actual amounts required to meet the Reinsurer's obligations to the Company under this Agreement.

(g) The initial deposit to the Trust Account with respect to this Agreement shall be made on the Closing Date and shall consist of assets with a statutory book value equal to the General Account Reserves as of the close of business on the day immediately preceding the Inception Date.

(h) The aggregate statutory book value of the assets held in the Trust Account with respect to this Agreement, shall at all times be at least equal to the Funding Requirement, and shall be adjusted on a quarterly basis so as to equal the Funding Requirement. On a quarterly basis, the Company shall promptly prepare and deliver to the Reinsurer a specific statement of the Funding Requirement and the Reinsurer shall promptly prepare and deliver to the Company a specific statement of the statutory book value of the assets in the Trust Account, in each case as of the end of the quarter. If the statement shows that the Funding Requirement exceeds 100% of the balance of the Trust Account with respect to this Agreement as of the statement date, the Reinsurer shall, within ten (10) Business Days after receipt of such notice of excess, secure delivery to the Trustee of additional cash or Eligible Securities having a current statutory book value equal to such difference. If the statement shows that the Funding Requirement is less than 100% of the balance of the Trust Account with respect to this Agreement as of the statement date, the Company shall, within ten (10) Business Days after delivery of such statement to the Reinsurer, deliver a notice of withdrawal to the Trustee directing the Trustee to withdraw from the Trust Account and deliver to the Reinsurer assets from the Trust Account having a current statutory book value equal to such excess amount. In addition to the foregoing, the Reinsurer shall prepare and deliver to the Company on a quarterly basis a specific statement of the market value of the assets in the Trust Account as of the end of the quarter.

#### ARTICLE XI

##### DEFERRED ACQUISITION COSTS

11.1. Tax DAC Information Sharing. To ensure consistency in their respective Tax DAC calculations for tax purposes, the Company and the Reinsurer will exchange information pertaining to the amount of net consideration under this Agreement each year. The Company will submit a schedule to the Reinsurer by February 28 of each year presenting its calculation of the net consideration for the preceding taxable year. The Reinsurer may contest the calculation by providing to the Company an alternative calculation in writing within thirty (30) days of receipt of the Company's schedule. The Company and the Reinsurer will act in good faith to resolve any differences in the schedule of calculations within thirty (30) days of

18

receipt of the alternative calculation to ensure consistent amounts are reported on the respective tax returns for the preceding tax year.

#### ARTICLE XII

##### DISPUTE RESOLUTION

12.1. General Provisions. (a) Any dispute, controversy or claim arising out of or relating to this Agreement or the validity, interpretation, breach or termination thereof (a "Dispute"), shall be resolved in accordance with the procedures set forth in this Article XII, which shall be the sole and exclusive procedures for the resolution of any such Dispute unless otherwise specified below.

(b) Commencing with the request contemplated by Section 12.2, all communications between the parties or their representatives in connection with the attempted resolution of any Dispute, including any mediator's evaluation referred to in Section 12.3, shall be deemed to have been delivered in furtherance of a Dispute settlement and shall be exempt from discovery and production, and shall not be admissible in evidence for any reason (whether as an admission or otherwise), in any arbitral or other proceeding for the resolution of the Dispute.

(c) In connection with any Dispute, the parties expressly waive and forego any right to (i) punitive, exemplary, statutorily-enhanced or similar damages in excess of compensatory damages, and (ii) trial by jury.

(d) The specific procedures set forth below, including but not limited to the time limits referenced therein, may be modified by agreement of the parties in writing.

(e) All applicable statutes of limitations and defenses based upon the passage of time shall be tolled while the procedures specified in this Article XII are pending. The parties will take such action, if any, required to effectuate such tolling.

12.2. Consideration by Senior Executives. If a Dispute is not resolved in the normal course of business at the operational level, the parties shall attempt in good faith to resolve such Dispute by negotiation between executives who hold, at a minimum, the office of President and CEO of the respective business entities involved in such Dispute. Either party may initiate the executive negotiation process by providing a written notice to the other (the "Initial Notice"). Fifteen (15) days after delivery of the Initial Notice, the receiving party shall submit to the other a written response (the "Response"). The Initial Notice and the Response shall include (i) a statement of the Dispute and of each party's position, and (ii) the name and title of the executive who will represent that party and of any other person who will accompany the executive. Such executives will meet in person or by telephone within thirty (30) days of the date of the Initial Notice to seek a resolution of the Dispute.

12.3. Mediation. If a Dispute is not resolved by negotiation as provided in Section 12.2 within forty-five (45) days from the delivery of the Initial Notice, then either party may submit the Dispute for resolution by mediation pursuant to the CPR Institute for Dispute

19

Resolution (the "CPR") Model Mediation Procedure as then in effect. The parties will select a mediator from the CPR Panels of Distinguished Neutrals, but such mediator must have prior U.S. reinsurance experience either as a lawyer or as a present or former officer or management employee of a reinsurance company, but not of the Company, or the Reinsurer, or any of their respective affiliates. Either party at commencement of the mediation may ask the mediator to provide an evaluation of the Dispute and the parties' relative positions.

12.4. Arbitration. (a) If a Dispute is not resolved by mediation as provided in Section 12.3 within thirty (30) days of the selection of a mediator (unless the mediator chooses to withdraw sooner), either party may submit the Dispute to be finally resolved by arbitration pursuant to the CPR Rules for Non-Administered Arbitration as then in effect (the "CPR Arbitration Rules"). The parties consent to a single, consolidated arbitration for all known Disputes existing at the time of the arbitration and for which arbitration is permitted.

(b) The neutral organization for purposes of the CPR Arbitration Rules will be the CPR. The arbitral tribunal shall be composed of three arbitrators who are each experienced in the U.S. reinsurance business, of whom each party shall appoint one in accordance with the "screened" appointment procedure provided in Rule 5.4 of the CPR Arbitration Rules. The non-party appointed arbitrator must have prior U.S. reinsurance experience as a present or former officer or management employee of a reinsurance company, but not of the Company, or the Reinsurer, or any of their respective affiliates. The arbitration shall be conducted in New York City. Each party shall be permitted to present its case, witnesses and evidence, if any, in the presence of the other party. A written transcript of the proceedings shall be made and furnished to the parties. The arbitrators shall determine the Dispute in accordance with the law of Virginia, without giving effect to any conflict of law rules or other rules that might render such law inapplicable or unavailable, and shall apply this Agreement according to its terms, provided that the provisions relating to arbitration shall be governed by the Federal Arbitration Act, 9 U.S.C. §§ 1 et seq. The arbitral tribunal shall endeavor to render its award or order resulting from any arbitration within forty-five (45) days following the termination of the arbitration proceedings.

(c) The parties agree to be bound by any award or order resulting from any arbitration conducted hereunder and further agree that judgment on any award or order resulting from an arbitration conducted under this Section may be entered and enforced in any court having jurisdiction thereof.

(d) Except as expressly permitted by this Agreement, no party will commence or voluntarily participate in any court action or proceeding concerning a Dispute, except (i) for enforcement as contemplated by Section 12.4(c) above, (ii) to restrict or vacate an arbitral

decision based on the grounds specified under Applicable Law, or (iii) for interim relief as provided in paragraph (e) below. For purposes of the foregoing the parties hereto submit to the non-exclusive jurisdiction of the courts of the State of New York.

(e) In addition to the authority otherwise conferred on the arbitral tribunal, the tribunal shall have the authority to make such orders for interim relief, including injunctive relief, as it may deem just and equitable. Notwithstanding paragraph (d) above, each party acknowledges that in the event of any actual or threatened breach of certain of the provisions of

20

this Agreement, the remedy at law would not be adequate, and therefore injunctive or other interim relief may be sought immediately to restrain such breach. If the tribunal shall not have been appointed, either party may seek interim relief from a court having jurisdiction if the award to which the applicant may be entitled may be rendered ineffectual without such interim relief. Upon appointment of the tribunal following any grant of interim relief by a court, the tribunal may affirm or disaffirm such relief, and the parties will seek modification or rescission of the court action as necessary to accord with the tribunal's decision.

(f) Each party will bear its own attorneys' fees and costs incurred in connection with the resolution of any Dispute in accordance with this Article XII.

#### ARTICLE XIII

##### MISCELLANEOUS PROVISIONS

13.1. Headings and Schedules. Headings used herein are not a part of this Agreement and shall not affect the terms hereof. The attached Schedules are a part of this Agreement.

13.2. Notices. All notices, requests, demands and other communications under this Agreement must be in writing and will be deemed to have been duly given or made as follows: (a) if sent by registered or certified mail in the United States return receipt requested, upon receipt; (b) if sent by reputable overnight air courier, two business days after mailing; (c) if sent by facsimile transmission, with a copy mailed on the same day in the manner provided in (a) or (b) above, when transmitted and receipt is confirmed by telephone; or (d) if otherwise actually personally delivered, when delivered, and shall be delivered as follows:

If to the Company:

GE Life and Annuity Assurance Company  
6610 West Broad Street  
Richmond, VA 23230  
Facsimile: (804) 281-6165  
Attention: Chief Executive Officer

With a copy to:

GE Life and Annuity Assurance Company  
6610 West Broad Street  
Richmond, VA 23230  
Facsimile: (804) 281-6005  
Attention: General Counsel

21

If to the Reinsurer:

Union Fidelity Life Insurance Company  
200 North Martingale Road  
Schaumburg, IL 60173-2096  
Facsimile: (847) 330-3404  
Attention: Chief Financial Officer

With a copy to:

Union Fidelity Life Insurance Company  
200 North Martingale Road  
Schaumburg, IL 60173-2096  
Facsimile: (847) 605-3044  
Attention: General Counsel

or to such other address or to such other Person as either party may have last designated by notice to the other party.

13.3. Successors and Assigns. This Agreement shall be binding upon and inure to the benefit of the parties hereto and their respective successors, permitted assigns and legal representatives. Neither this Agreement, nor any right or obligation hereunder, may be assigned by any party without the prior written consent of the other party hereto. Any assignment in violation of this Section 13.3 shall be void and shall have no force and effect. Nothing in this Section 13.3 shall be construed to prohibit the Reinsurer from retroceding all or any portion of the business reinsured hereunder.

13.4. Execution in Counterpart. This Agreement may be executed by the parties hereto in any number of counterparts, and by each of the parties hereto in separate counterparts, each of which counterparts, when so executed and delivered, shall be deemed to be an original, but all such counterparts shall together constitute but one and the same instrument.

13.5. Currency. Whenever the word "Dollars" or the "\$" sign appear in this Agreement, they shall be construed to mean United States Dollars, and all transactions under this Agreement shall be in United States Dollars.

13.6. Amendments. This Agreement may not be changed, altered or modified unless the same shall be in writing executed by the Company and the Reinsurer.

13.7. Governing Law. This Agreement will be construed, performed and enforced in accordance with the laws of the Commonwealth of Virginia without giving effect to its principles or rules of conflict of laws thereof to the extent such principles or rules would require or permit the application of the laws of another jurisdiction.

13.8. Entire Agreement; Severability. (a) This Agreement and the Termination Letter Agreement constitute the entire agreement between the parties hereto relating to the subject matter hereof and supersede all prior and contemporaneous agreements, understandings,

22

statements, representations and warranties, negotiations and discussions, whether oral or written, of the parties and there are no general or specific warranties, representations or other agreements by or among the parties in connection with the entering into of this Agreement or the subject matter hereof except as specifically set forth or contemplated herein or in the Termination Letter Agreement.

(b) If any provision of this Agreement is held to be void or unenforceable, in whole or in part, (i) such holding shall not affect the validity and enforceability of the remainder of this Agreement, including any other provision, paragraph or subparagraph, and (ii) the parties agree to attempt in good faith to reform such void or unenforceable provision to the extent necessary to render such provision enforceable and to carry out its original intent.

13.9. Contemporaneous Agreements. Concurrent with the execution of this Agreement, the parties and/or their Affiliates are also entering into the Capital Maintenance Agreement, the RBC Reporting Letter Agreement and the Assignment Letter Agreement.

13.10. No Waiver; Preservation of Remedies. No consent or waiver, express or implied, by any party to or of any breach or default by any other party in the performance by such other party of its obligations hereunder shall be deemed or construed to be a consent or waiver to or of any other breach or default in the performance of obligations hereunder by such other party hereunder. Failure on the part of any party to complain of any act or failure to act of any other party or to declare any other party in default, irrespective of how long such failure continues, shall not constitute a waiver by such first party of any of its rights hereunder. The rights and remedies provided are cumulative and are not exclusive of any rights or remedies that any party may otherwise have at law or equity.

13.11. Cooperation. Each party hereto shall cooperate fully with the other in all reasonable respects in order to accomplish the objectives of this Agreement including making available to each their respective officers and employees for interviews and meetings with Governmental Authorities and furnishing any additional assistance, information and documents as may be reasonably requested by a party from time to time.

13.12. Third Party Beneficiary. Nothing in this Agreement will confer any rights upon any Person that is not a party or a successor or permitted assignee of a party to this Agreement.

13.13. Tax Exception to Any Confidentiality. Notwithstanding anything to the contrary set forth herein or in any other agreement to which the parties hereto are parties or by which they are bound, any obligations of confidentiality contained herein and therein, as they relate to the transactions, shall not apply to the federal tax structure or federal tax treatment of the transactions, and each party hereto (and any employee, representative, or agent of any party hereto) may disclose to any and all persons, without limitation of any kind, the federal tax structure and federal tax treatment of the transactions. The preceding sentence is intended to cause the transactions to be treated as not having been offered under conditions of confidentiality for purposes of Section 1.6011-4(b)(3) (or any successor provision) of the Treasury Regulations promulgated under Section 6011 of the Internal Revenue Code of 1986, as amended, and shall be construed in a manner consistent with such purpose. In addition, each party hereto

23

acknowledges that it has no proprietary or exclusive rights to the federal tax structure of the transactions or any federal tax matter or federal tax idea related to the transactions.

13.14. Interpretation. Wherever the words "include," "includes" or "including" are used in this Agreement, they shall be deemed to be followed by the words "without limitation."

13.15. Survival. Article XII and Article XIII shall survive the termination of this Agreement.



IN WITNESS WHEREOF, the parties hereto have caused this Agreement to be executed by their duly authorized representatives.

GE LIFE AND ANNUITY ASSURANCE COMPANY

By /s/ VICTOR C. MOSES  
Name: Victor C. Moses  
Title: Vice President

UNION FIDELITY LIFE INSURANCE COMPANY

By /s/ GLENN JOPPA  
Name: Glenn Joppa  
Title: Senior Vice President and Secretary

SCHEDULE A

POLICY FORMS

P1098	Asset Allocation Annuity/Commonwealth Variable Annuity
P1143	CVA Plus
P1140	CVA 90
P5166	—Partial Surrender Endorsement
P4909	—Guarantee Acct. Rider
P4910	—Death Provisions Endorsement
P4911	—Surrender Charge Endorsement
P5058	—Nursing Home Waiver
P5077	—Joint Annuitant
P5076	—Trust Endorsement
P4912	—Deferred Premium Tax Endorsement
P1142	CVA Mitchell
P5166	—Partial Surrender Endorsement
P4907	—Guarantee Acct. Rider
P4910	—Death Provisions Endorsement
P4911	—Surrender Charge Endorsement
P5058	—Nursing Home Waiver
P5077	—Joint Annuitant
P5076	—Trust Endorsement
P4912	—Deferred Premium Tax Endorsement
P1150	CVA Plus
P5158	—Ratchet
P5166	—Partial Surrender Endorsement
P4907	—Guarantee Acct. Rider (3%)
P4909	—Guarantee Acct. Rider (4%)
P4911	—Surrender Charge Endorsement
P5058	—Nursing Home Waiver
P5117	—Overage Issues (Death Benefit)
P5137	—Immediate Allocation
P5103	—Guaranteed Minimum Death Benefit
P1152	Extra
P5235	—Step-up or Roll-up Rider
P5222	—Step-up
P5240	—Estate Protector
P5234	—Roll-up Rider
P1151	Freedom*
P5235	—Step-up or Roll-up Rider
P5222	—Step-up
P5240	—Estate Protector
P5234	—Roll-up Rider
P1153	Savvy

P1154	Choice*
P5234	—Step-up or Roll-up Rider
P5233	—Step-up
P5239	—Estate Protector
P5223	—Roll-up Rider
P1156	Selections
P5234	—Step-up or Roll-up Rider
P5233	—Step-up
P5239	—Estate Protector
P5223	—Roll-up Rider
P1160	401k

\*Excluding Cross Funding Policies with plan sequence numbers 261, 262 and 263 on Freedom and Choice products.

SCHEDULE B

SEPARATE ACCOUNTS

GE Life & Annuity Separate Account 4

SCHEDULE C

FORM OF ADMINISTRATIVE SERVICES AGREEMENT

VA UF LIC/GELAAC

ADMINISTRATIVE SERVICES AGREEMENT  
 by and between  
 GE LIFE AND ANNUITY ASSURANCE COMPANY  
 and  
 UNION FIDELITY LIFE INSURANCE COMPANY

Effective as of [     ]

ADMINISTRATIVE SERVICES AGREEMENT

This ADMINISTRATIVE SERVICES AGREEMENT (this "Agreement"), effective as of [ ] (the "Effective Date"), is entered into by and between GE LIFE AND ANNUITY ASSURANCE COMPANY, an insurance company organized under the laws of the Commonwealth of Virginia (the "Company"), and UNION FIDELITY LIFE INSURANCE COMPANY, an insurance company organized under the laws of the State of Illinois (the "Administrator").

**RECITALS:**

WHEREAS, the Company and the Administrator have entered into a Reinsurance Agreement dated as of April 15, 2004 (the "Reinsurance Agreement") which provides for the parties to enter into this Agreement;

WHEREAS, pursuant to the Reinsurance Agreement, the Administrator has agreed to indemnify the Company for, among other things, (i) on a coinsurance basis, 100% of the General Account Liabilities and (ii) on a modified coinsurance basis, 100% of the Separate Account Liabilities, in each case, payable by the Company under the Reinsured Contracts (capitalized terms used herein and not defined herein, unless otherwise indicated, have the respective meanings assigned to them in the Reinsurance Agreement); and

WHEREAS, the Company wishes to appoint the Administrator to provide contractholder and claim servicing with respect to the Reinsured Contracts and the Separate Accounts, and the Administrator desires to provide such administrative services;

NOW, THEREFORE, in consideration of the covenants and agreements set forth herein, the parties hereto agree as follows:

ARTICLE I

AUTHORITY

The Company hereby appoints the Administrator, and the Administrator hereby accepts appointment, to provide as an independent contractor of the Company, from and after the Effective Date, all of the contractholder and claim servicing services necessary or appropriate with respect to the Reinsured Contracts and the Separate Accounts, including those set forth in this Agreement and on Schedule A hereto (the "Administrative Services"), all on the terms as set forth in this Agreement. In providing the contractholder and claim servicing with respect to the Reinsured Contracts, the Administrator shall handle all such matters, including but not limited to the billing and collection of premiums and the defense, adjustment, settlement and payment of all contractholder claims arising under the Reinsured Contracts, as more fully described below. Notwithstanding any other provision of this Agreement to the contrary, the Company shall have the right to direct the Administrator to perform any action necessary for the Reinsured Contracts or the contractholder and claim servicing thereof to comply with Applicable Law, or to cease performing any action that constitutes a violation of Applicable Law.

ARTICLE II

STANDARD FOR SERVICES; FACILITIES; SUBCONTRACTING

2.1. Standard for Services. The Administrator shall provide the contractholder and claims servicing with respect to the Reinsured Contracts and the Separate Accounts in good faith and with the care, skill, prudence and diligence of a person experienced in administering variable annuity business. Without limiting the generality of the foregoing, the Administrator shall provide contractholder and claims servicing with respect to the Reinsured Contracts and the Separate Accounts (i) in accordance with the terms of the Reinsured Contracts, (ii) in accordance with the applicable terms of this Agreement, (iii) in compliance with Applicable Law, (iv) in accordance with industry standards and, subject to the foregoing, (v) to the extent applicable, in the same manner as it conducts its own business not subject to this Agreement.

2.2. Facilities and Personnel. To the extent not sub-contracted to a Subcontractor, the Administrator shall at all times maintain sufficient facilities and trained personnel of the kind necessary to perform its obligations under this Agreement in accordance with the performance standards set forth herein.

2.3. Subcontracting. The Administrator may subcontract for the performance of any contractholder or claims servicing service or services with respect to the Reinsured Contracts or any services the Administrator is to provide in the administration of the Separate Accounts to (i) an Affiliate or (ii) any other Person with the prior written consent of the Company, such consent not to be unreasonably withheld (in each case, the "Subcontractor"); provided, that, no such subcontracting shall relieve the Administrator from any of its obligations or liabilities hereunder, and the Administrator shall remain responsible for all obligations or liabilities of such Subcontractor with regards to the providing of such service or services as if provided by the Administrator.

ARTICLE III

CLAIMS HANDLING

The Administrative Services with respect to claims for benefits including claims outstanding on the Effective Date, shall include the following:

3.1. Claim Administration Services. The Administrator shall acknowledge, consider, review, investigate, deny, settle, pay or otherwise dispose of each claim for benefits and disbursements reported under each Reinsured Contract (each, a "Claim" and collectively the "Claims").

3.2. Description of Claim Administration Services. Without limiting the foregoing, the Administrator shall:

- (i) provide claimants under the Reinsured Contract and their authorized representatives (collectively, "Claimants") with Claim forms and provide reasonable explanatory guidance to Claimants in connection therewith;

2

- (ii) establish, maintain and organize Claim files and maintain and organize other Claims-related records;

- (iii) review all Claims and determine whether the Claimant is eligible for benefits and if so, the nature and extent of such benefits;

- (iv) prepare and distribute to the appropriate recipients any reports required by Applicable Law;

- (v) respond to all written or oral Claims-related communications that the Administrator reasonably believes to require a response; and

- (vi) maintain a complaint log with respect to the Reinsured Contracts in accordance with applicable requirements of Governmental Authorities and provide a copy of such log, continuously updated through the last day of each calendar quarter during the term of this Agreement, to the Company on or before the tenth Business Day of each calendar quarter covering changes during the preceding calendar quarter.

ARTICLE IV

REGULATORY AND LEGAL PROCEEDINGS

4.1. Regulatory Complaints and Proceedings. The Administrator shall:

- (i) to the extent permitted by Applicable Law, respond to any Claims payment related complaints or inquiries made by any Governmental Authority within the Governmental Authority's requested time frame for response or, if no such time frame is provided, within the time frame as allowed by Applicable Law; and promptly provide a copy of such response to the Company;

- (ii) promptly notify the Company of any non-Claims payment related complaints or inquiries initiated by a Governmental Authority, and of any proceedings (either Claims or non-Claims related) initiated by a Governmental Authority, and, in either case, to the extent permitted by Applicable Law, prepare and send to the Governmental Authority, with a copy to the Company, a response within the Governmental Authority's requested time frame for response or, if no such time frame is provided, within the time frame as allowed by Applicable Law; provided, that, subject to meeting such time frames, the Administrator shall provide such response to the Company for its prior review and comment;

- (iii) subject to Section 4.4, supervise and control the investigation, contest, defense and/or settlement of all complaints, inquiries and proceedings by Governmental Authorities, at its own cost and expense, and in the name of the Company when necessary; and

3

- (iv) at the Company's request, provide to the Company a report in a form mutually agreed by the parties summarizing the nature of any complaints, inquiries or proceedings by Governmental Authorities, the alleged actions or omissions giving rise to such complaints, inquiries or proceedings and copies of any files or other documents that the Company may reasonably request in connection with its review of these matters.

4.2. Legal Proceedings. The Administrator shall:

- (i) notify the Company promptly of any lawsuit, action, arbitration or other dispute resolution proceedings that are instituted or threatened with respect to any matter relating to the Reinsured Contracts ("Legal Proceeding(s)"), and in no event more than five (5) Business Days after receipt of notice thereof;

- (ii) subject to Section 4.4, supervise and control the investigation, contest, defense and/or settlement of all Legal Proceedings at its own cost and expense, and in the name of the Company when necessary; and

- (iii) keep the Company fully informed of the progress of all Legal Proceedings handled by the Administrator in which the Company is named a party and, at the Company's request, provide to the Company a report summarizing the nature of such Legal Proceedings, the alleged actions or omissions giving rise to any Legal Proceedings and copies of any files or other documents that the Company may reasonably request in connection with its review of these matters in each case other than such files, documents and other information as would, in the judgment of counsel to the Administrator, lead to the loss or waiver of legal privilege.

4.3. Notice to Administrator. The Company shall give prompt notice to the Administrator of any Legal Proceeding made or brought against the Company after the Inception Date arising under or in connection with the Reinsured Contracts to the extent known to it and not made against or served on the Administrator or a Subcontractor as administrator hereunder, and in no event more than five (5) Business Days after receipt of notice thereof, and shall promptly furnish to the Administrator copies of all pleadings in connection therewith. The Administrator shall assume the defense of the Company.

4.4. Defense of Regulatory and Legal Proceedings. Notwithstanding anything in this Agreement to the contrary, the Company shall supervise and control the investigation, contest, defense and/or settlement of all complaints, inquiries and proceedings by Governmental Authorities to the extent required by Applicable Law. In addition, the Company shall have the right to engage in its own separate legal representation, at its own expense, and to otherwise participate fully in the defense of any Legal Proceedings or complaints, inquiries or proceedings by Governmental Authorities with respect to the Reinsured Contracts in which the Company is a named party, without the Company waiving any right to indemnification it may have under Article XVII hereof. The Administrator and the Company shall cooperate with each other with respect to the administration of any Legal Proceeding and any complaint, inquiry or proceeding

4

by Governmental Authorities. The Administrator shall not settle any Legal Proceeding or any complaint, inquiry or proceeding by Governmental Authorities without the Company's prior written consent (which consent shall not be unreasonably withheld or delayed) unless (i) there is no finding or admission of any violation of law or any violation of the rights of any Person, (ii) such settlement would not reasonably be expected to have material adverse precedential consequences to the Company and (iii) the sole relief provided is monetary damages that are paid in full by the Administrator.

#### ARTICLE V

##### NOTIFICATION TO CONTRACTHOLDERS

The Administrator agrees to send to contractholders of the Reinsured Contracts a written notice prepared by the Administrator and reasonably acceptable to the Company to the effect that the Administrator, or such other Person designated by the Administrator in accordance with the terms of this Agreement, has been appointed by the Company to provide Administrative Services. The Administrator shall send such notice by first class U.S. mail at a time reasonably acceptable to the Company and the Administrator and in all events in accordance with Applicable Law. The parties intend to minimize the cost associated with any notification under this Article V, including by means of inclusion of the notice in a regularly scheduled mailing to contractholders in lieu of a separate mailing. The cost associated with such notification under this Article V (upon the initial assumption of the administration of the Reinsured Contracts under Section 3.10 of the Reinsurance Agreement) shall be a transition cost payable by the Administrator or the Company in accordance with Section 3.10(a) or 3.10(c) of the Reinsurance Agreement, as applicable.

#### ARTICLE VI

##### BILLINGS AND COLLECTIONS

6.1. Billing and Collection Services. The Administrator shall assume all responsibility for billing and collecting premiums and other amounts payable with respect to the Reinsured Contracts, including Separate Account Charges, from and after the Effective Date. The Company shall promptly remit to the Administrator any such amounts received by it with respect to the Reinsured Contracts.

#### ARTICLE VII

##### QUARTERLY PREMIUM TAX AND INSOLVENCY FUND ACCOUNTINGS

7.1. Quarterly Accountings. Within thirty (30) days after the end of each calendar quarter that this Agreement is in effect (or more frequently as mutually agreed by the parties), the Company shall submit to the Administrator a written statement of accounting in a form and containing such information to be agreed upon by the parties hereto (each, an "Insolvency Fund Quarterly Accounting") setting forth the Insolvency Fund amounts assessed or

5

---

payable to the extent that such assessments constitute Reinsured Risks with respect to the Reinsured Contracts (collectively, the "Post-Effective Date Assessments"). Within thirty (30) days after the last day of each calendar quarter that this Agreement is in effect (or more frequently as mutually agreed by the parties), the Administrator shall submit to the Company a written statement of accounting in a form and containing such information to be agreed upon by the parties hereto (each, a "Quarterly Premium Tax Accounting", and together with the Insolvency Fund Quarterly Accountings, the "Quarterly Accountings") setting forth the estimated premium taxes due with respect to the Reinsured Contracts as a result of premiums collected during such quarter. Concurrent with the delivery of each Quarterly Premium Tax Accounting, the Administrator shall remit to the Company the amount set forth on such Quarterly Premium Tax Accounting with respect to such estimated premium taxes due and the amount set forth in such Insolvency Fund Quarterly Accounting with respect to the Post-Effective Date Assessments, and any other amounts owed to the Company pursuant to this Agreement; provided, however, that any Post-Effective Date Assessments set forth in an Insolvency Fund Quarterly Accounting received by the Administrator less than five (5) Business Days prior to the Administrator's delivery of such Quarterly Premium Tax Accounting will be paid within ten (10) Business Days of receipt by the Administrator of such Insolvency Fund Quarterly Accounting. Each of the parties agrees to supply to the other a copy of all supporting data used in preparing the Quarterly Accountings prepared by such party.

7.2. Adjustments Regarding Quarterly Accountings. In the event that subsequent data or calculations require revision of any of the Quarterly Accountings, the required revision and appropriate payments thereunder shall be made within ten (10) Business Days after the parties hereto mutually agree as to the appropriate revision.

#### ARTICLE VIII

##### CERTAIN ACTIONS BY COMPANY

8.1. Filings. The Company shall prepare and timely file any filings required to be made with any Governmental Authority that relate to the Company generally and not just to the Reinsured Contracts, including filings with guaranty associations and filings and premium tax returns with taxing authorities. The Administrator shall, in a timely fashion in light of the dates such filings by the Company are required, provide to the Company all information in the possession of the Administrator with respect to the Reinsured Contracts that may be reasonably required for the Company to prepare such filings and tax returns. In order to enable the Administrator to perform the requirements as set forth in Item 6(c) of Schedule A hereto attached, the Company shall make available to the Administrator drafts of such documents sufficiently in advance of the proposed filings thereof.

8.2. Annual Adjustment. The Company shall pay or provide to the Administrator the benefit of any Post-Effective Date Assessments which have been or can be applied to reduce the Company's premium tax liability ("Premium Tax Credits"). The Company shall provide to the Administrator by March 15 of each year a statement of the amount (the "Annual Adjustment") of (i) premium taxes due with respect to premiums collected during the prior calendar year (to the extent that such premium taxes constitute Reinsured Risks with

6

---

respect to the Reinsured Contracts), less (ii) estimated premium taxes paid by the Administrator to the Company with respect to such premiums under the provisions of Article VII, less (iii) Premium Tax Credits for the prior calendar year. By March 30 of each year the Administrator shall pay to the Company the Annual Adjustment, if a positive amount, and the Company will pay or credit to the Administrator the Annual Adjustment, if a negative amount.

#### ARTICLE IX

##### REGULATORY MATTERS AND AUDIT REPORTING

9.1. Regulatory Compliance and Reporting. The Administrator shall provide to the Company such information with respect to the Reinsured Contracts as is required to satisfy all current and future informational reporting, prior approval and any other requirements imposed by any Governmental Authority. Upon the reasonable request of the Company, the Administrator shall timely prepare such reports and summaries, including statistical summaries and certifications, as are necessary or reasonably required to satisfy any requirements imposed by a Governmental Authority upon the Company with respect to the Reinsured Contracts. In addition, the Administrator, upon the reasonable request of the Company, shall promptly provide to the Company copies of all existing records relating to the Reinsured Contracts (including, with respect to records maintained in machine readable form, hard copies) that are necessary to satisfy such requirements. All copies of records furnished in the ordinary course of business shall be furnished by the Administrator at the Administrator's cost. Any extraordinary costs reasonably incurred by the Administrator in response to requests from the Company shall be reimbursed by the Company. Among other responsibilities:

- (i) The Administrator shall promptly prepare and furnish to Governmental Authorities all reports and related summaries (including, without limitation, statistical summaries), certificates of compliance and other reports required or requested by a Governmental Authority.
- (ii) The Administrator shall assist the Company and cooperate with the Company in doing all things necessary, proper or advisable, in the most expeditious manner practicable in connection with any and all market conduct or other Governmental Authority examinations relating to the Reinsured Contracts.

9.2. Reporting and Accountings. The Administrator shall assume the reporting and accounting obligations set forth below:

- (i) As soon as practicable but not more than forty (40) days after the end of each calendar quarter that this Agreement is in effect (or more frequently as mutually agreed by the parties), the Administrator shall timely provide to the Company reports and summaries of transactions (and, upon request of the Company, detailed supporting records) related to the Reinsured Contracts as may be reasonably required for use in connection with the preparation of the Company's statutory and GAAP financial statements,

7

---

tax returns and other required financial reports and to comply with the requirements of the regulatory authorities having jurisdiction over the Company, including all premiums received and all benefits paid. The parties shall cooperate in good faith to establish the manner for the providing of such reports.

- (ii) The Administrator shall provide to the Company such reports or summaries (and, upon the request of the Company, detailed supporting records therefor) related to the payment of commissions under the Reinsured Contracts as agreed by the parties.
- (iii) As soon as practicable but not more than forty (40) days after the end of each calendar quarter that this Agreement is in effect (or more frequently as mutually agreed by the parties), the Administrator shall report to the Company the amount of statutory reserves that the Company is required to maintain in connection with the Reinsured Risks with respect to the Reinsured Contracts as of the quarter end.
- (iv) The Administrator shall promptly provide notice to the Company of any changes in the reserve methodology used by the Administrator in calculating statutory reserves for the Reinsured Contracts.
- (v) Within forty-five (45) days after each calendar year end (or such longer time as may be agreed by the parties) that this Agreement is in effect, the Administrator shall provide to the Company (a) an opinion of an actuary reasonably acceptable to the Company as to the adequacy of statutory reserves for the Reinsured Contracts, prepared according to accepted actuarial standards of practice, and as otherwise required for regulatory reporting purposes and (b) an analysis which reasonably supports such opinion.

9.3. Additional Reports and Updates. For so long as this Agreement remains in effect, each party shall periodically furnish to the other such other reports and information as may be reasonably required by such other party for regulatory, tax or similar purposes and reasonably available to it.

#### ARTICLE X

##### MISCELLANEOUS ADMINISTRATIVE SERVICES

The Administrator shall assume the obligations set forth below:

- (i) The Administrator shall timely pay to the contractholders, including any certificateholder thereunder, any refunds of any kind due under the Reinsured Contracts.



- (ii) The Administrator shall have the exclusive authority to manage and administer the Ceded Reinsurance Agreements, including providing all reports and notices required with regard to the Ceded Reinsurance Agreements to the reinsurers within the time required by the applicable reinsurance agreement and doing all other things necessary to comply with the terms and conditions of the Ceded Reinsurance Agreements. Without limiting the foregoing, the Administrator shall timely pay all reinsurance premiums due to reinsurers under the Ceded Reinsurance Agreements and shall use commercially reasonable efforts to collect from such reinsurers all reinsurance recoverables due thereunder. The Administrator shall forward to the Company upon receipt any such reinsurance recoverables collected by the Administrator that are not the property of Administrator under the terms of the Reinsurance Agreement.
- (iii) The Administrator shall process all policy changes, lapses, cancellations, and reinstatements in accordance with the terms of this Agreement and the express terms of the Reinsured Contracts and shall assume responsibility for providing all other contractholder servicing in connection with the Reinsured Contracts.
- (iv) The Administrator shall pay commissions due under the Reinsured Contracts.
- (v) The Administrator shall provide such other Administrative Services as are necessary or appropriate to fully effectuate the purpose of the Reinsurance Agreement and this Agreement, including such Administrative Services as are not performed by or on behalf of Company on the date hereof but the need for which may arise due to changes or developments in Applicable Law.

ARTICLE XI

SEPARATE ACCOUNT ADMINISTRATIVE SERVICES

Without limiting the generality of any of the foregoing, in addition to the Administrative Services described in any Article of this Agreement, the contractholder and claim services with respect to, or as a result of, the Separate Accounts shall include those services set forth on Schedule A hereto.

ARTICLE XII

BOOKS AND RECORDS

The Administrator shall keep accurate and complete records, files and accounts of all transactions and matters with respect to the Reinsured Contracts and the administration thereof in accordance with Applicable Law and its record management practices in effect from time to time

for the Administrator's insurance business not covered by this Agreement, if any. The parties to this Agreement and their designated representatives may upon reasonable notice inspect, at the offices of the Administrator or the Company where such records are located, the papers and any and all other books or documents of the Administrator or the Company reasonably relating to this Agreement, including the Reinsured Contracts, and shall have access to appropriate employees and representatives of the other party, in each case during normal business hours for such period as this Agreement is in effect or for as long thereafter as any rights or obligations of any party survives or the Administrator or the Company reasonably need access to such records for regulatory, tax or similar purposes. The information obtained shall be used only for purposes relating to the transactions contemplated under this Agreement.

ARTICLE XIII

COOPERATION

Each party hereto shall cooperate fully with the other in all reasonable respects in order to accomplish the objectives of this Agreement including making available to each their respective officers and employees for interviews and meetings with Governmental Authorities and furnishing any additional assistance, information and documents as may be reasonably requested by a party from time to time.

ARTICLE XIV

PRIVACY REQUIREMENTS

In providing the Administrative Services provided for under this Agreement, and in connection with maintaining, administering, handling and transferring the data of the contractholders and other recipients of benefits under the Reinsured Contracts, the Administrator shall, and shall cause its Affiliates and any permitted Subcontractors to, comply with all confidentiality and security obligations applicable to them in connection with the collection, use, disclosure, maintenance and transmission of personal, private, health or financial information about individual contractholders or benefit recipients, including the provisions of privacy policies under which such information was gathered, those laws currently in place and which may become effective during the term of this Agreement, including the Gramm-Leach-Bliley Act, the Health Insurance Portability and Accountability Act of 1996 and any other Applicable Laws. The Administrator shall entitle the Company and its agents and representatives, the Commissioner of Health and Human Services and such other Governmental Authorities, to the extent required by Applicable Law, to audit the Administrator's compliance herewith. The Administrator shall also enable individual subjects of personally identifiable information, upon request from such individuals, to review and correct information maintained by the Administrator about them, and to restrict use of such information. The Administrator shall promptly report to the Company any violation of this provision of which the Administrator becomes aware. Unless required by Applicable Law, the Administrator shall not during the term of this Agreement, modify the privacy policies under which information utilized by the Administrator in administering the Reinsured Contracts is gathered, without the Company's prior

written consent, which consent shall not be unreasonably withheld. The parties agree to comply with the terms of the Business Associate Addendum attached hereto, if applicable, or such other written agreement as may be required by Applicable Law on the date hereof.

ARTICLE XV

CONSIDERATION FOR ADMINISTRATIVE SERVICES

Apart from the performance by the Company of its obligations under the Reinsurance Agreement, there shall be no fee or other consideration due to the Administrator for performance of the Administrative Services under this Agreement.

ARTICLE XVI

BANK ACCOUNT; USE OF COMPANY LETTERHEAD

When and on terms reasonably requested by the Administrator, the Company shall open, modify or close, and make available for use by the Administrator for the payment of amounts to be paid by the Administrator hereunder one or more bank accounts of the Company and check stock of the Company. The Administrator shall maintain such account(s) and pay all applicable bank fees and check stock costs. The Company shall adopt such resolutions and execute such documents as required to designate senior officers of the Administrator (by title) as signatories on such account(s) and authorize the Administrator to certify to such bank(s), from time to time, the names of such officers. The Company shall also make available to the Administrator, at the sole expense of the Administrator, such letterhead, printed forms and other documents of the Company as may be reasonably required by the Administrator in performing services hereunder. Upon termination of this Agreement, the Administrator shall promptly return to the Company all such unused check stock, letterhead, printed forms and other documents held by it in connection with this Agreement as provided under this Article XVI.

ARTICLE XVII

INDEMNIFICATION

Any claim for or with respect to indemnification arising out of, or relating to, this Agreement or the Administrative Services hereunder shall be permitted under and governed by the provisions of Article V of the Master Agreement, dated as of [ ], 2004, among General Electric Company, General Electric Capital Corporation, GEI, Inc., GE Financial Assurance Holdings, Inc. and Genworth Financial, Inc (the "Master Agreement"), to the extent such provisions are applicable, as if this Agreement were a Transaction Document under the Master Agreement.

ARTICLE XVIII

DURATION; TERMINATION

18.1. Duration. This Agreement shall commence on the Effective Date and continue with respect to each Reinsured Contract until no further Administrative Services in respect of such Reinsured Contract is required, unless this Agreement is earlier terminated under Section 18.2.

18.2. Termination. (a) This Agreement is subject to immediate termination at the option of the Company, upon written notice to the Administrator, on the occurrence of any of the following events:

- (i) A voluntary or involuntary proceeding is commenced in any jurisdiction by or against the Administrator for the purpose of conserving, rehabilitating or liquidating the Administrator;
- (ii) There is a material breach by the Administrator of any material term or condition of this Agreement that is not cured by the Administrator within thirty (30) days after receipt of written notice from the Company of such breach or act (provided that the Company shall not have the right to terminate this Agreement (A) for so long as the Administrator is making a good faith effort to cure such breach, not to exceed an additional one hundred eighty (180) days or (B) during the pendency of any dispute resolution proceedings as set forth in Article XIX regarding an alleged material breach); or
- (iii) The Administrator is unable to perform the services required under this Agreement for a period of thirty (30) consecutive days for any reason other than as a result of a Force Majeure, it being understood that nothing in this 18.2(a)(iii) shall relieve the

Administrator from its administrative responsibilities under this Agreement. For purposes of this Agreement, "Force Majeure" means any acts or omissions of any civil or military authority, acts of God, acts or omissions of the Company, fires, strikes or other labor disturbances, equipment failures, fluctuations or non-availability of electrical power, heat, light, air conditioning or telecommunications equipment, or any other act, omission or occurrence beyond the Administrator's reasonable control, irrespective of whether similar to the foregoing enumerated acts, omissions or occurrences.

(b) This Agreement may be terminated at any time upon the mutual written consent of the parties hereto, which writing shall state the effective date of termination.

(c) In the event that this Agreement is terminated under any of the provisions of 18.2(a), the Administrator shall select a third-party administrator to perform the services required by this Agreement. The Company shall have the right to approve any such administrator selected by the Administrator, but such approval will not unreasonably be

12

withheld or delayed. If the Administrator fails to select an administrator pursuant to this 18.2(c), the Company shall select such an administrator. In either case, the Administrator shall pay all fees and charges imposed by the selected administrator and shall bear all transition costs associated with the transition of the performance of the services required under this Agreement to such administrator, including the expense of sending contractholder notices as provided in Article V.

#### ARTICLE XIX

##### DISPUTE RESOLUTION

19.1. General Provisions. (a) Any dispute, controversy or claim arising out of or relating to this Agreement or the validity, interpretation, breach or termination thereof (a "Dispute"), shall be resolved in accordance with the procedures set forth in this Article XIX, which shall be the sole and exclusive procedures for the resolution of any such Dispute unless otherwise specified below.

(b) Commencing with the request contemplated by 19.2, all communications between the parties or their representatives in connection with the attempted resolution of any Dispute, including any mediator's evaluation referred to in 19.3, shall be deemed to have been delivered in furtherance of a Dispute settlement and shall be exempt from discovery and production, and shall not be admissible in evidence for any reason (whether as an admission or otherwise), in any arbitral or other proceeding for the resolution of the Dispute.

(c) In connection with any Dispute, the parties expressly waive and forego any right to (i) punitive, exemplary, statutorily-enhanced or similar damages in excess of compensatory damages (provided that any such liability with respect to a Third Party claim (as defined in the Master Agreement) shall be considered direct damages), and (ii) trial by jury.

(d) The specific procedures set forth below, including but not limited to the time limits referenced therein, may be modified by agreement of the parties in writing.

(e) All applicable statutes of limitations and defenses based upon the passage of time shall be tolled while the procedures specified in this Article XIX are pending. The parties will take such action, if any, required to effectuate such tolling.

19.2. Consideration by Senior Executives. If a Dispute is not resolved in the normal course of business at the operational level, the parties shall attempt in good faith to resolve such Dispute by negotiation between executives who hold, at a minimum, the office of President and CEO of the respective business entities involved in such Dispute. Either party may initiate the executive negotiation process by providing a written notice to the other (the "Initial Notice"). Fifteen (15) days after delivery of the Initial Notice, the receiving party shall submit to the other a written response (the "Response"). The Initial Notice and the Response shall include (i) a statement of the Dispute and of each party's position, and (ii) the name and title of the executive who will represent that party and of any other person who will accompany the executive. Such executives will meet in person or by telephone within thirty (30) days of the date of the Initial Notice to seek a resolution of the Dispute.

13

19.3. Mediation. If a Dispute is not resolved by negotiation as provided in Section 19.2 within forty-five (45) days from the delivery of the Initial Notice, then either party may submit the Dispute for resolution by mediation pursuant to the CPR Institute for Dispute Resolution (the "CPR") Model Mediation Procedure as then in effect. The parties will select a mediator from the CPR Panels of Distinguished Neutrals, but such mediator must have prior U.S. reinsurance experience either as a lawyer or as a present or former officer or management employee of a reinsurance company, but not of the Company, or the Administrator, or any of their respective affiliates. Either party at commencement of the mediation may ask the mediator to provide an evaluation of the Dispute and the parties' relative positions.

19.4. Arbitration. (a) If a Dispute is not resolved by mediation as provided in 19.3 within thirty (30) days of the selection of a mediator (unless the mediator chooses to withdraw sooner), either party may submit the Dispute to be finally resolved by arbitration pursuant to the CPR Rules for Non-Administered Arbitration as then in effect (the "CPR Arbitration Rules"). The parties consent to a single, consolidated arbitration for all known Disputes existing at the time of the arbitration and for which arbitration is permitted.

(b) The neutral organization for purposes of the CPR Arbitration Rules will be the CPR. The arbitral tribunal shall be composed of three arbitrators who are each experienced in the U.S. reinsurance business, of whom each party shall appoint one in accordance with the "screened" appointment procedure provided in Rule 5.4 of the CPR Arbitration Rules. The non-party appointed arbitrator must have prior U.S. reinsurance experience as a present or former officer or management employee of a reinsurance company, but not of the Company, or the Administrator, or any of their respective affiliates. The arbitration shall be conducted in New York City. Each party shall be permitted to present its case, witnesses and evidence, if any, in the presence of the other party. A written transcript of the proceedings shall be made and furnished to the parties. The arbitrators shall determine the Dispute in accordance with the law of Virginia, without giving effect to any conflict of law rules or other rules that might render such law inapplicable or unavailable, and shall apply this Agreement according to its terms, provided that the provisions relating to arbitration shall be governed by the Federal Arbitration Act, 9 U.S.C. §§ 1 et seq. The arbitral tribunal shall endeavor to render its award or order resulting from any arbitration within forty-five (45) days following the termination of the arbitration proceedings.

(c) The parties agree to be bound by any award or order resulting from any arbitration conducted hereunder and further agree that judgment on any award or order resulting from an arbitration conducted under this 19.4 may be entered and enforced in any court having jurisdiction thereof.

(d) Except as expressly permitted by this Agreement, no party will commence or voluntarily participate in any court action or proceeding concerning a Dispute, except (i) for enforcement as contemplated by 19.4(c) above, (ii) to restrict or vacate an arbitral decision based on the grounds specified under applicable law, or (iii) for interim relief as provided in paragraph (e) below. For purposes of the foregoing the parties hereto submit to the non-exclusive jurisdiction of the courts of the State of New York.

14

(e) In addition to the authority otherwise conferred on the arbitral tribunal, the tribunal shall have the authority to make such orders for interim relief, including injunctive relief, as it may deem just and equitable. Notwithstanding paragraph (d) above, each party acknowledges that in the event of any actual or threatened breach of certain of the provisions of this Agreement, the remedy at law would not be adequate, and therefore injunctive or other interim relief may be sought immediately to restrain such breach. If the tribunal shall not have been appointed, either party may seek interim relief from a court having jurisdiction if the award to which the applicant may be entitled may be rendered ineffectual without such interim relief. Upon appointment of the tribunal following any grant of interim relief by a court, the tribunal may affirm or disaffirm such relief, and the parties will seek modification or rescission of the court action as necessary to accord with the tribunal's decision.

(f) Each party will bear its own attorneys' fees and costs incurred in connection with the resolution of any Dispute in accordance with this Article XIX.

#### ARTICLE XX

##### MISCELLANEOUS PROVISIONS

20.1. Headings and Schedules. Headings used herein are not a part of this Agreement and shall not affect the terms hereof. The attached Schedules are a part of this Agreement.

20.2. Notices. All notices, requests, demands and other communications under this Agreement must be in writing and will be deemed to have been duly given or made as follows: (a) if sent by registered or certified mail in the United States return receipt requested, upon receipt; (b) if sent by reputable overnight air courier, two business days after mailing; (c) if sent by facsimile transmission, with a copy mailed on the same day in the manner provided in (a) or (b) above, when transmitted and receipt is confirmed by telephone; or (d) if otherwise actually personally delivered, when delivered, and shall be delivered as follows:

If to the Company:

GE Life and Annuity Assurance Company  
6610 West Broad Street  
Richmond, VA 23230  
Facsimile: (804) 281-6165  
Attention: Chief Executive Officer

With a copy to:

GE Life and Annuity Assurance Company  
6620 West Broad Street  
Richmond, VA 23230  
Facsimile: (804) 281-6005  
Attention: General Counsel

15

If to the Administrator:

Union Fidelity Life Insurance Company  
200 North Martingale Road  
Schaumburg, IL 60173-2096  
Facsimile: (847) 330-3404  
Attention: Chief Financial Officer

With a copy to:

or to such other address or to such other Person as either party may have last designated by notice to the other party.

- 20.3. **Successors and Assigns.** This Agreement shall be binding upon and inure to the benefit of the parties hereto and their respective successors, permitted assigns and legal representatives. Neither this Agreement, nor any right or obligation hereunder, may be assigned by any party without the prior written consent of the other party hereto. Any assignment in violation of this 20.3 shall be void and shall have no force and effect.
- 20.4. **Execution in Counterpart.** This Agreement may be executed by the parties hereto in any number of counterparts, and by each of the parties hereto in separate counterparts, each of which counterparts, when so executed and delivered, shall be deemed to be an original, but all such counterparts shall together constitute but one and the same instrument.
- 20.5. **Currency.** Whenever the word "Dollars" or the "\$" sign appear in this Agreement, they shall be construed to mean United States Dollars, and all transactions under this Agreement shall be in United States Dollars.
- 20.6. **Amendments.** This Agreement may not be changed, altered or modified unless the same shall be in writing executed by the Company and the Administrator.
- 20.7. **Governing Law.** This Agreement will be construed, performed and enforced in accordance with the laws of the Commonwealth of Virginia without giving effect to its principles or rules of conflict of laws thereof to the extent such principles or rules would require or permit the application of the laws of another jurisdiction.
- 20.8. **Entire Agreement; Severability.** (a) This Agreement constitutes the entire agreement between the parties hereto relating to the subject matter hereof and supersedes all prior and contemporaneous agreements, understandings, statements, representations and warranties, negotiations and discussions, whether oral or written, of the parties and there are no general or specific warranties, representations or other agreements by or among the parties in

16

connection with the entering into of this Agreement or the subject matter hereof except as specifically set forth or contemplated herein.

- (b) If any provision of this Agreement is held to be void or unenforceable, in whole or in part, (i) such holding or provision shall not affect the validity and enforceability of the remainder of this Agreement, including any other provision, paragraph or subparagraph, and (ii) the parties agree to attempt in good faith to reform such void, unenforceable or violative provision to the extent necessary to render such provision enforceable and to carry out its original intent.
- 20.9. **No Waiver; Preservation of Remedies.** No consent or waiver, express or implied, by any party to or of any breach or default by any other party in the performance by such other party of its obligations hereunder shall be deemed or construed to be a consent or waiver to or of any other breach or default in the performance of obligations hereunder by such other party hereunder. Failure on the part of any party to complain of any act or failure to act of any other party or to declare any other party in default, irrespective of how long such failure continues, shall not constitute a waiver by such first party of any of its rights hereunder. The rights and remedies provided are cumulative and are not exclusive of any rights or remedies that any party may otherwise have at law or equity.
- 20.10. **Third Party Beneficiary.** Nothing in this Agreement will confer any rights upon any Person that is not a party or a successor or permitted assignee of a party to this Agreement.
- 20.11. **Tax Exception to Any Confidentiality.** Notwithstanding anything to the contrary set forth herein or in any other agreement to which the parties hereto are parties or by which they are bound, any obligations of confidentiality contained herein and therein, as they relate to the transactions, shall not apply to the federal tax structure or federal tax treatment of the transactions, and each party hereto (and any employee, representative, or agent of any party hereto) may disclose to any and all persons, without limitation of any kind, the federal tax structure and federal tax treatment of the transactions. The preceding sentence is intended to cause the transactions to be treated as not having been offered under conditions of confidentiality for purposes of Section 1.6011-4(b)(3) (or any successor provision) of the Treasury Regulations promulgated under Section 6011 of the Internal Revenue Code of 1986, as amended, and shall be construed in a manner consistent with such purpose. In addition, each party hereto acknowledges that it has no proprietary or exclusive rights to the federal tax structure of the transactions or any federal tax matter or federal tax idea related to the transactions.
- 20.12. **Interpretation.** Wherever the words "include," "includes" or "including" are used in this Agreement, they shall be deemed to be followed by the words "without limitation."
- 20.13. **Survival.** Article XIX and Article XX shall survive the termination of this Agreement.

17

IN WITNESS WHEREOF, the Company and the Administrator have executed this Agreement as of the date first above written.

GE LIFE AND ANNUITY ASSURANCE  
COMPANY

By: \_\_\_\_\_  
Name:  
Title:

UNION FIDELITY LIFE INSURANCE  
COMPANY

By: \_\_\_\_\_  
Name:  
Title:

18

#### SCHEDULE A

#### SEPARATE ACCOUNT SERVICES

The Administrator shall provide the following additional services to the Company relating to the Separate Accounts:

- Premium Collection.** The Administrator shall promptly invest in the Separate Accounts deposits collected which relate to the Separate Account portions of Reinsured Contracts (including transfers from fixed options under the Reinsured Contracts), and promptly forward funds and required information to the underlying investment management companies, in each case in accordance with the Reinsured Contracts and any applicable agreements provided by the Company to the Administrator.
- Records Maintenance.** The Administrator shall maintain and preserve records with respect to the Separate Accounts as required by Rules 31a-1 and 31a-2 under the Investment Company Act of 1940, as amended, the Securities Exchange Act of 1934, as amended, and the rules promulgated by the National Association of Securities Dealers (the "NASD"). Upon request of the Company or any state or federal regulatory authorities, the Administrator shall forward a complete copy of any record promptly to the requesting party and in a format appropriate to the request. The Administrator shall file with the Securities and Exchange Commission ("SEC") the undertaking required by Rule 17a-4(i) under the Exchange Act with respect to any records that it maintains and that are required to be maintained under the provisions of the Exchange Act by any broker-dealers that are authorized to sell the Reinsured Contracts.
- Performance of Obligations.** The Administrator shall perform, in the name and on behalf of the Company, all of the Company's obligations under (i) the participation agreements between the Company and the mutual fund organizations in which assets of the Separate Accounts are invested (the "Participation Agreements"), (ii) the underwriting agreements between the Company and the principal underwriters for the Separate Account portions of the Reinsured Contracts, and (iii) any other agreements related to the distribution of the Separate Account portions of the Reinsured Contracts; provided in each case that the Company has provided complete copies of such agreements (including any amendments thereto) to the Administrator
- Contractholder Services.** The Administrator shall provide the Company with the following additional contractholder services:
  - Issuing timely reports, statements, and confirmations as required by the Reinsured Contracts or the Company's practices in effect immediately prior to the Effective Date and communicated by the Company to the Administrator in writing;
  - Issuing tax reporting forms and other information as required by applicable regulatory rules, including without limitation 1099-R, W-4P,

A-1

and 5498 for contractholders and beneficiaries as required and distributing the same to contractholders and beneficiaries and appropriate authorities;

- Responding to any requests from plan administrators or trustees for policy information affecting the plan or participants for qualified plans;
- Responding to contractholder requests for calculations applicable to annuity payments under the Reinsured Contracts as may be necessary for tax withholding calculations;
- Processing and recording transfer requests (i.e., from one subaccount to another) in all cases within time intervals necessary to meet SEC, NASD and other legal and regulatory requirements;
- Calculating (on a daily basis) the net asset value and the accumulation unit value of each subaccount of the Separate Accounts that are funding options for the Reinsured Contracts, in accordance with the provisions of the Reinsured Contracts, as well as with the prospectus and statement of additional information disclosure on any day when such calculation is required by the Investment Company Act of 1940, as amended, and the rules and regulations thereunder;
- Calculating (on a daily basis) the mortality and expense charges, and any administrative charges in accordance with the provisions of the Reinsured Contracts, as well as with the applicable prospectus and statement of additional information disclosure; and
- Transmitting orders pursuant to the Participation Agreements for the purchase or redemption of shares in the investment companies in which the assets of the Separate Account are invested to such investment companies or their authorized agents and paying and receiving funds in connection with such purchases or redemptions as required by any applicable agreement.

5. **Actuarial Services.** The Administrator shall provide the formal actuarial opinions and related reports required by the SEC and the NASD.
6. **Compliance Services.** The Administrator shall provide the Company with the following additional compliance services:
- (a) Preparation and submission of (and provision of financial data required for) all reports required by the SEC (including without limitation forms N-SAR, 485(b) registration statement updates, fund and separate account annual reports and 24f-2 Notices), the NASD (including, without limitation, compilation of information, if any, related to the Reinsured Policies that would be reflected in any quarterly FOCUS II/IIA reports, annual FOCUS schedule 1 or Customer Complaints Rule 3070 Report), and the states (in each case only after review and approval thereof by the

A-2

---

Company), with all of the foregoing to be accomplished within such time periods as are necessary to comply with Applicable Law after giving allowance, in the cases of information relevant to reports of filings of the Company that are not specific to the Reinsured Policies, for time periods reasonably specified by the Company to permit integration of the subject information related to the Reinsured Policies;

- (b) Notwithstanding anything in this Agreement to the contrary, all complaints and other grievances shall be handled by the Administrator in accordance with NASD requirements (including any response time requirements applicable thereto);
- (c) Review and comment on registration statements and other SEC related documents prepared by the Company, and assist the Company in meeting SEC requirements with respect to any of the Reinsured Contracts. In addition, the Administrator shall distribute at its expense to contractholders all required information provided by the Company to the Administrator (which the Company hereby agrees to provide on a timely basis), including prospectuses, post-effective amendments or supplements to the registration statements of the Separate Account or of any underlying funds as well as annual and semi-annual reports;
- (d) Make all filings and obtain all regulatory approvals required with regard to advertising of the Reinsured Contracts, including without limitation all filings and approvals required by Applicable Laws and NASD requirements (except to the extent that such services are performed by other entities pursuant to written agreements with the Company);
- (e) Ensure SEC and NASD compliance for variable contracts, prospectuses, and registration statements including the submission of any required information, conducting annual compliance audits, quarterly complaint reporting, registering and terminating representatives and monitoring continuing education requirements;
- (f) Monitor the federal securities statutes and the rules, regulations, orders, and interpretations thereunder and the securities statutes and rules, regulations, orders, and interpretations thereunder of the various states in which contractholders or Reinsured Contracts are located to ensure compliance therewith and to ensure that any actions or communications required thereby are properly made;
- (g) Process information relating to proxy voting, including receiving record date information and proxy solicitation from underlying investment vehicle(s); preparing proxy ballots; mailing solicitation and resolicitations, if necessary; and maintaining all proxy registers and other required proxy material;

A-3

- 
- (h) Provide the Company with all information reasonably requested and necessary for the Company to meet any requirements arising out of the Sarbanes-Oxley Act of 2002, as amended; and
- (i) Ensure compliance with the Office of Foreign Assets Control ("OFAC") of the US Department of the Treasury and money "laundering" restrictions, including but not limited to those adopted under the Uniting and Strengthening America By Providing Appropriate Tools Required to Intercept and Obstruct Terrorism (USA PATRIOT) Act of 2001.

7. **General.** The Administrator agrees to comply with all applicable federal securities laws and requirements of applicable self regulatory organization, including the NASD, as they apply to the Separate Account portions of Reinsured Contracts in connection with the performance of the Administrator's obligations under this Agreement. The Administrator hereby agrees to provide all necessary information to the Company in order to meet all regulatory requirements as may be necessary for the Company to fulfill its obligations under federal and state law as is deemed reasonably necessary by the Company under applicable federal and state laws as they relate to the Reinsured Contracts.

A-4

---

#### BUSINESS ASSOCIATE ADDENDUM

- I. **Purpose.**
- In order to disclose certain information to the party providing a service under this Agreement ("Provider") under this Addendum, some of which may constitute Protected Health Information (defined below), the party to whom a service under this Agreement is being provided ("Recipient") and Provider mutually agree to comply with the terms of this Addendum for the purpose of satisfying the requirements of the Health Insurance Portability and Accountability Act of 1996 ("HIPAA") and its implementing privacy regulations at 45 C.F.R. Parts 160-164 ("HIPAA Privacy Rule"). These provisions shall apply to Provider to the extent that Provider is considered a "Business Associate" under the HIPAA Privacy Rule and all references in this section to Business Associates shall refer to Provider. Capitalized terms not otherwise defined herein shall have the meaning assigned in the Agreement. Notwithstanding anything else to the contrary in the Agreement, in the event of a conflict between this Addendum and the Agreement, the terms of this Addendum shall prevail.
- II. **Permitted Uses and Disclosures.**
- A. Business Associate agrees to use or disclose Protected Health Information ("PHI") that it creates for or receives from Recipient or its Subsidiaries only as follows. The capitalized term "Protected Health Information or PHI" has the meaning set forth in 45 Code of Federal Regulations Section 164.501, as amended from time to time. Generally, this term means individually identifiable health information including, without limitation, all information, data and materials, including without limitation, demographic, medical and financial information, that relates to the past, present, or future physical or mental health or condition of an individual; the provision of health care to an individual; or the past present, or future payment for the provision of health care to an individual; and that identifies the individual or with respect to which there is a reasonable basis to believe the information can be used to identify the individual. This definition shall include any demographic information concerning members and participants in, and applicants for, Recipient's or its Subsidiaries' health benefit plans. All other terms used in this Addendum shall have the meanings set forth in the applicable definitions under the HIPAA Privacy Rule.
- B. **Functions and Activities on Company's Behalf.** Business Associate is permitted to use and disclose PHI it creates for or receives from Recipient or its Subsidiaries only for the purposes described in this Addendum or the Agreement that are not inconsistent with the provisions of this Addendum, or as required by law, or following receipt of prior written approval from whichever of the Recipient or its Subsidiary for which the relevant PHI was created or from which the relevant PHI was received. In addition to these specific requirements below, Business Associate may use or disclose PHI only in a manner that would not violate the HIPAA Privacy Rule if done by the Recipient or its Subsidiaries.
- C. **Business Associate's Operations.** Business Associate is permitted by this Agreement to use PHI it creates for or receives from Recipient or its Subsidiaries: (i) if such use is reasonably necessary for Business Associate's proper management and administration; and (ii) as reasonably necessary to carry out Business Associate's legal responsibilities. Business

A-1

---

Associate is permitted to disclose PHI it creates for or receives from Recipient or its Subsidiaries for the purposes identified in this Section only if the following conditions are met:

- (1) The disclosure is required by law; or

(2) The disclosure is reasonably necessary to Business Associate's proper management and administration, and Business Associate obtains reasonable assurances in writing from any person or organization to which Business Associate will disclose such PHI that the person or organization will:

a. Hold such PHI as confidential and use or further disclose it only for the purpose for which Business Associate disclosed it to the person or organization or as required by law; and

b. Notify Business Associate (who will in turn promptly notify whichever of the Recipient or its Subsidiary for which the relevant PHI was created or from which the relevant PHI was received) of any instance of which the person or organization becomes aware in which the confidentiality of such PHI was breached.

D. **Minimum Necessary Standard.** In performing the functions and activities on Recipient's or its Subsidiaries' behalf pursuant to the Agreement, Business Associate agrees to use, disclose or request only the minimum necessary PHI to accomplish the purpose of the use, disclosure or request. Business Associate must have in place policies and procedures that limit the PHI disclosed to meet this minimum necessary standard.

E. **Prohibition on Unauthorized Use or Disclosure.** Business Associate will neither use nor disclose PHI it creates or receives for or from Recipient, its Subsidiaries, or from another business associate of Recipient or its Subsidiaries, except as permitted or required by this Addendum or the Agreement that are not inconsistent with the provisions of this Addendum, or as required by law, or following receipt of prior written approval from whichever of the Recipient or its Subsidiary for which the relevant PHI was created or from which the relevant PHI was received.

F. **De-identification of Information.** Business Associate agrees neither to de-identify PHI it creates for or receives from Recipient or its Subsidiaries or from another business associate of Recipient or its Subsidiaries, nor use or disclose such de-identified PHI, unless such de-identification is expressly permitted under the terms and conditions of this Addendum or the Agreement and related to Recipient's or its Subsidiaries' activities for purposes of "treatment", "payment" or "health care operations", as those terms are defined under the HIPAA Privacy Rule. De-identification of PHI, other than as expressly permitted under the terms and conditions of the Addendum for Business Associate to perform services for Recipient or its Subsidiaries, is not a permitted use of PHI under this Addendum. Business Associate further agrees that it will not create a "Limited Data Set" as defined by the HIPAA Privacy Rule using PHI it creates or receives, or receives from another business associate of Recipient or its Subsidiaries, nor use or disclose such Limited Data Set unless: (i) such creation, use or disclosure is expressly permitted under the terms and conditions of this Addendum or the Agreement that are not inconsistent with

A-2

---

the provisions of this Addendum; and such creation, use or disclosure is for services provided by Business Associate that relate to Recipient's or its Subsidiaries' activities for purposes of "treatment", "payment" or "health care operations", as those terms are defined under the HIPAA Privacy Rule.

G. **Information Safeguards.** Business Associate will develop, document, implement, maintain and use appropriate administrative, technical and physical safeguards to preserve the integrity and confidentiality of and to prevent non-permitted use or disclosure of PHI created for or received from Recipient or its Subsidiaries. These safeguards must be appropriate to the size and complexity of Business Associate's operations and the nature and scope of its activities. Business Associate agrees that these safeguards will meet any applicable

requirements set forth by the U.S. Department of Health and Human Services, including (as of the effective date or as of the compliance date, whichever is applicable) any requirements set forth in the final HIPAA security regulations. Business Associate agrees to mitigate, to the extent practicable, any harmful effect that is known to Business Associate resulting from a use or disclosure of PHI by Business Associate in violation of the requirements of this Addendum.

III. Conducting Standard Transactions. In the course of performing services for Recipient or its Subsidiaries, to the extent that Business Associate will conduct Standard Transactions for or on behalf of Recipient or its Subsidiaries, Business Associate will comply, and will require any subcontractor or agent involved with the conduct of such Standard Transactions to comply, with each applicable requirement of 45 C.F.R. Part 162. "Standard Transaction(s)" shall mean a transaction that complies with the standards set forth at 45 C.F.R. parts 160 and 162. Further, Business Associate will not enter into, or permit its subcontractors or agents to enter into, any trading partner agreement in connection with the conduct of Standard Transactions for or on behalf of the Recipient or its Subsidiaries that:

- a. Changes the definition, data condition, or use of a data element or segment in a Standard Transaction;
- b. Adds any data element or segment to the maximum defined data set;
- c. Uses any code or data element that is marked "not used" in the Standard Transaction's implementation specification or is not in the Standard Transaction's implementation specification; or
- d. Changes the meaning or intent of the Standard Transaction's implementation specification.

IV. Sub-Contractors, Agents or Other Representatives. Business Associate will require any of its subcontractors, agents or other representatives to which Business Associate is permitted by this Addendum or the Agreement (or is otherwise given Recipient's or the relevant Subsidiary's prior written approval) to disclose any of the PHI Business Associate creates or receives for or from Recipient or its Subsidiaries, to provide reasonable assurances in writing that subcontractor or agent will comply with the same restrictions and conditions that apply to the Business Associate under the terms and conditions of this Addendum with respect to such PHI.

A-3

V. Protected Health Information Access, Amendment and Disclosure Accounting.

A. Access. Business Associate will promptly upon Recipient's or its Subsidiary's request make available to Recipient, its Subsidiary, or, at Recipient's or such Subsidiary's direction, to the individual (or the individual's personal representative) for inspection and obtaining copies any PHI about the individual which Business Associate created for or received from Recipient or its Subsidiary and that is in Business Associate's custody or control, so that Recipient or its Subsidiary may meet its access obligations under 45 Code of Federal Regulations § 164.524.

B. Amendment. Upon Recipient's or its Subsidiary's request Business Associate will promptly amend or permit Recipient or its Subsidiary access to amend any portion of the PHI which Business Associate created for or received from Recipient or its Subsidiary, and incorporate any amendments to such PHI, so that Recipient or its Subsidiary may meet its amendment obligations under 45 Code of Federal Regulations § 164.526.

C. Disclosure Accounting. So that Recipient or its Subsidiaries may meet their disclosure accounting obligations under 45 Code of Federal Regulations § 164.528:

1. Disclosure Tracking. Business Associate will record for each disclosure, not excepted from disclosure accounting under Section V.C.2 below, that Business Associate makes to Recipient or its Subsidiaries of PHI that Business Associate creates for or receives from Recipient or its Subsidiaries, (i) the disclosure date, (ii) the name and member or other policy identification number of the person about whom the disclosure is made, (iii) the name and (if known) address of the person or entity to whom Business Associate made the disclosure, (iv) a brief description of the PHI disclosed, and (v) a brief statement of the purpose of the disclosure (items i-v, collectively, the "disclosure information"). For repetitive disclosures Business Associate makes to the same person or entity (including Recipient or its Subsidiaries) for a single purpose, Business Associate may provide a) the disclosure information for the first of these repetitive disclosures, (b) the frequency, periodicity or number of these repetitive disclosures and (c) the date of the last of these repetitive disclosures. Business Associate will make this disclosure information available to Recipient or its Subsidiaries promptly upon Recipient's or its Subsidiaries' request.

2. Exceptions from Disclosure Tracking. Business Associate need not record disclosure information or otherwise account for disclosures of PHI that this Addendum or Recipient or the relevant Subsidiary in writing permits or requires (i) for the purpose of Recipient's or its Subsidiaries' treatment activities, payment activities, or health care operations, (ii) to the individual who is the subject of the PHI disclosed or to that individual's personal representative; (iii) to persons involved in that individual's health care or payment for health care; (iv) for notification for disaster relief purposes, (v) for national security or intelligence purposes, (vi) to law enforcement officials or correctional institutions regarding inmates; or (vii) pursuant to an authorization; (viii) for disclosures of certain PHI made as part of a Limited Data Set; (ix) for certain incidental disclosures that may occur where reasonable safeguards have been implemented; and (x) for disclosures prior to April 14, 2003.

A-4

3. Disclosure Tracking Time Periods. Business Associate must have available for Recipient and its Subsidiaries the disclosure information required by this section for the 6 years preceding Recipient's or its Subsidiaries' request for the disclosure information (except Business Associate need have no disclosure information for disclosures occurring before April 14, 2003).

VI. Additional Business Associate Provisions

A. Reporting of Breach of Privacy Obligations. Business Associate will provide written notice to whichever of the Recipient or its Subsidiary for which the relevant PHI was created or from which the relevant PHI was received of any use or disclosure of PHI that is neither permitted by this Addendum nor given prior written approval by Recipient or the relevant Subsidiary promptly after Business Associate learns of such non-permitted use or disclosure. Business Associate's report will at least:

- (i) Identify the nature of the non-permitted use or disclosure;
- (ii) Identify the PHI used or disclosed;
- (iii) Identify who made the non-permitted use or received the non-permitted disclosure;
- (iv) Identify what corrective action Business Associate took or will take to prevent further non-permitted uses or disclosures;
- (v) Identify what Business Associate did or will do to mitigate any deleterious effect of the non-permitted use or disclosure; and
- (vi) Provide such other information, including a written report, as Recipient or the relevant Subsidiary may reasonably request.

B. Amendment. Upon the effective date of any final regulation or amendment to final regulations promulgated by the U.S. Department of Health and Human Services with respect to PHI, including, but not limited to the HIPAA privacy and security regulations, this Addendum and the Agreement will automatically be amended so that the obligations they impose on Business Associate remain in compliance with these regulations.

In addition, to the extent that new state or federal law requires changes to Business Associate's obligations under this Addendum, this Addendum shall automatically be amended to include such additional obligations, upon notice by Recipient or its Subsidiaries to Business Associate of such obligations. Business Associate's continued performance of services under the Agreement shall be deemed acceptance of these additional obligations.

C. Audit and Review of Policies and Procedures. Business Associate agrees to provide, upon Recipient request, access to and copies of any policies and procedures developed or utilized by Business Associate regarding the protection of PHI. Business Associate agrees to provide, upon Recipient's request, access to Business Associate's internal practices, books, and records, as they relate to Business Associate's services, duties and obligations set forth in this Addendum and the Agreement(s) under which Business Associate provides services and/or

A-5

products to or on behalf of Recipient or its Subsidiaries, for purposes of Recipient's or its Subsidiaries' review of such internal practices, books, and records.

A-6

#### SCHEDULE D

##### CEDING COMMISSION

The Ceding Commission shall be the sum of the following:

1. an amount equal to the excess of (i) the General Account Reserves as of the Inception Date over (ii) the net reserves of the Company with respect to the General Account Liabilities (net after deduction for Ceded Reinsurance) as of the Inception Date, determined in accordance with GAAP (which amount may be negative);
2. an amount equal to the unamortized PVFP intangible asset balance of the Company (excluding any related mark to market adjustments for SFAS 115 requirement) with respect to the Reinsured Contracts as measured as of the close of business on the day immediately preceding the Inception Date, determined in accordance with GAAP;
3. an amount equal to the unamortized deferred acquisition costs of the Company (excluding any related mark to market adjustments for SFAS 115 requirement) with respect to the Reinsured Contracts as measured as of the close of business on the day immediately preceding the Inception Date, determined in accordance with GAAP; and
4. an amount equal to the excess of the GAAP book value of the Assets (excluding any related mark to market adjustments for SFAS 115 requirement) over the SAP book value of the Assets measured as of the close of business on the day immediately preceding the Inception Date (which amount may be negative).

A-1

SCHEDULE E

Assets

Transfer Document	From	To	Nature of Transfer	Cash Map Cross-Reference	Schedule
GELAAC VA Reinsurance	GELAAC	UFLIC	Treaty	(86)	Schedule E

Called Securities*	Parent Name	Issuer Name	1Q04 Cusip	1Q04 Tax lot	12/31/03 Local Par	12/31/03 GAAP BV (incl attached derivative)	12/31/03 Accrued Interest
[Individual Asset Details Omitted]							
<b>Asset Sub Total</b>						<b>1,755,072,464.02</b>	<b>12,907,831.78</b>
Cash							
<b>Total</b>							

\* These Securities will not be transferred. The "Call Amount" will be settled in cash

SCHEDULE F

EXPENSE ALLOWANCES

The "Annual Expense Reimbursement Factor" used to calculate the Expense Allowance is as follows:

Policy Maintenance Factor \$59.73 per Policy less \$64.69 per Policy of fund company administrative expense service shares.

Such Annual Expense Reimbursement Factor will be adjusted (i) for the year beginning January 1, 2005 and, thereafter, every three (3) years during the term of this Agreement based on a triennial cost/time study prepared in accordance with the methodology set forth below (the "Triennial Study") and (ii) for the years between the Triennial Studies based on a report setting forth the Annual Expense Reimbursement Factor prepared in accordance with the methodology set forth below (the "Annual Expense Reimbursement Factor Report").

(a) Triennial Study. As soon as practicable (and in any event within sixty (60) days) prior to January 1, 2005 and prior to the beginning of every third calendar year thereafter during the term of this Agreement, the Company shall cause to be prepared and delivered to the Reinsurer the Annual Expense Reimbursement Factor Report, together with all supporting data used in preparing the Triennial Study and work papers, in reasonable detail, setting forth the determination of such Annual Expense Reimbursement Factors based on such Triennial Study (such documents, together with the Triennial Study, the "Triennial Study Documents").

(b) Annual Expense Reimbursement Factor Report. As soon as practicable (and in any event within thirty (30) days) prior to January 1, 2006 and prior to the beginning of each calendar year thereafter in which no Triennial Study is prepared, the Company shall cause to be prepared and delivered to the Reinsurer the Annual Expense Reimbursement Factor Report, together with all supporting data used in preparing the Annual Expense Reimbursement Factor Report and work papers, in reasonable detail, setting forth the determination of such Annual Expense Reimbursement Factor for the next calendar year (such documents, together with the Annual Expense Reimbursement Factor Report, the "Annual Expense Reimbursement Factor Documents").

(c) Methodology. At the time of the Triennial Study, historical costs (to include costs directly related to maintaining and administering policies, processing claims and reporting results) will be determined for the Policy Maintenance Factor identified above. For a given Annual Expense Reimbursement Factor the identified costs will be divided by the total historical number of units of measure for both the Reinsured Contracts and the retained block of business to derive an historical cost per unit. The historical cost per unit will be used as a prospective cost per unit for the next calendar year.

For the two succeeding years in the period between the Triennial Studies the historical dollar amount by Policy Maintenance Factor will be adjusted (rolled forward) for current year cost changes agreed to by the Reinsurer and the Company (in accordance with the procedures set forth below). This rolled forward historical cost will then be divided by the total historical

A-2

number of units for the current period to determine a prospective cost per unit for the next calendar year.

An additional adjustment, positive or negative, to the prospective cost per unit determined by either the Triennial Study or the two succeeding years may be negotiated between the parties. The additional adjustment is for special projected costs or benefits of productivity, process improvements, inflation, loss of scale, and any other cost variation which was not included in the prior Triennial Study or the succeeding roll forward.

The credit for Fund Company Administrative Expense Service Shares will be redetermined annually to reflect historical amounts of reimbursement relating to Reinsured Contracts, current period number of units, and changes in contractual arrangements with Fund Companies.

The combined prospective unit cost, additional adjustment and Fund Company Administrative Expense Service Shares credit is the Annual Expense Reimbursement Factor. The Expense Allowance will be determined quarterly and billed to the Reinsurer in three equal installments during the quarter at the end of the month. Each installment will be determined by multiplying the actual number of units at the beginning of the quarter covered by this Agreement times the Annual Expense Reimbursement Factor (divided by twelve).

(d) Review of Documents. Following the delivery of the Annual Expense Reimbursement Factor Documents or the Triennial Study Documents, as applicable, the Company shall (i) provide to the Reinsurer or its designated representative copies of such additional work papers and other documents relating to its preparation of the Annual Expense Reimbursement Factor Report or Triennial Study, as applicable, as the Reinsurer or its designated representative may reasonably request, including, without limitation, claims files and practices and (ii) cooperate with, and make its personnel and facilities reasonably available to, the Reinsurer and the Reinsurer's designated representative for the purpose of providing such other information as the Reinsurer or the Reinsurer's designated representative may reasonably request concerning Annual Expense Reimbursement Factor Documents or the Triennial Study Documents, as applicable, and the calculation of the Annual Expense Reimbursement Factor.

(e) Notice of Disagreement. In the event that the Reinsurer has any disagreement with any of the Annual Expense Reimbursement Factor Documents or the Triennial Study Documents, as applicable, the Reinsurer shall give written notice of all such disagreements (a "Notice of Disagreement") to the Company within thirty (30) days after the Annual Expense Reimbursement Factor Documents or the Triennial Study Documents, as applicable, are delivered to the Reinsurer. Any Notice of Disagreement shall set forth each item in disagreement and shall provide reasonable specificity as to the basis for each disagreement and shall specify the total adjustment to the Annual Expense Reimbursement Factor, as proposed by the Company as a result of such items in disagreement.

(f) Dispute Resolution. If the Reinsurer does not deliver a Notice of Disagreement to the Company within such thirty (30) day period, the Annual Expense Reimbursement Factor Documents and the Triennial Study Documents, as applicable, shall be final and binding upon the parties hereto and shall constitute the final calculation of the Annual Expense

Reimbursement Factor for the next calendar year. If the Reinsurer delivers a Notice of Disagreement to the Company within such thirty (30) day period, the parties shall (and shall cause their respective designated representatives to) negotiate in good faith to resolve all disagreements as promptly as practicable. Any changes in the Annual Expense Reimbursement Factor, if any, that are agreed to by the Company and the Reinsurer within sixty (60) days of the aforementioned delivery of the Annual Expense Reimbursement Factor Documents or the Triennial Study Documents, as applicable, shall be incorporated into a final calculation of the Annual Expense Reimbursement Factor. If the parties and their respective designated representatives are unable to resolve all disagreements within sixty (60) days of delivery of the Annual Expense Reimbursement Factor Documents or the Triennial Study Documents, as applicable, then all unresolved disagreements will be submitted within ten (10) days after the end of such sixty (60) day period for resolution in accordance herewith to an independent certified public accounting firm of national standing and reputation (the "Accounting Firm") mutually acceptable to the Company and the Reinsurer. The parties shall cooperate in good faith with the Accounting Firm and shall give the Accounting Firm access to all data and other information requested by the Accounting Firm for purposes of such resolution. The Accounting Firm shall, within thirty (30) days after its engagement, deliver to the Company and the Reinsurer a definitive calculation of the Annual Expense Reimbursement Factor, which shall be final and binding upon the parties hereto and shall be so reflected in the calculation of the Annual Expense Reimbursement Factor. The Company and the Reinsurer shall each pay one-half of the fees and expenses of the Accounting Firm.

(g) Expense Allowance Pending Resolution. In the event of a dispute with respect to any Annual Expense Reimbursement Factor for the next succeeding Calendar year, the Company and the Reinsurer agree that the Annual Expense Reimbursement Factor then in effect under this Agreement shall remain in effect pending resolution of such dispute and adjustment, if any, in accordance with the dispute resolution procedure set forth in paragraph (f) above.

SCHEDULE G - PART I

INITIAL REPORT

1. SAP General Account Reserves	\$ _____
2. Ceding Commission:	
A. Excess SAP General Account Reserves over GAAP net reserves for General Account Liabilities:	
1) Total SAP General Account Reserves	\$ _____
2) Total GAAP net reserves for General Account Liabilities	\$ _____
<b>Excess SAP Reserves over GAAP Reserves (A1-A2)</b>	<b>\$ _____</b>
B. Present Value of Future Profits (PVFP)	\$ _____
C. Deferred Acquisition Costs (DAC)	\$ _____
D. Asset Book Value Difference —Measured as of close of business the day preceding the Inception Date	
1) Asset Book Value (GAAP basis)	\$ _____
2) Asset Book Value (SAP basis)	\$ _____
<b>Excess Asset Book Value (D1-D2)</b>	<b>\$ _____</b>
<b>Total Ceding Commission (A+B+C+D)</b>	<b>\$ _____</b>
3. Accrued Interest on Assets as of the day before Inception Date	\$ _____
4. Investment Cash Flows on the Assets from the Inception Date through the Closing Date	\$ _____
Net Due Reinsurer (1-2-+4)	\$ _____

SCHEDULE G - PART II

DAILY SETTLEMENT REPORT

Settlement Amount

	Current Day	Quarter-To-Date
1. Premium/Deposits Received from Contractholders	\$ _____	\$ _____
2. Net Sales/Redemptions of UIT Shares	\$ _____	\$ _____
3. Net Purchases of UIT Shares	\$ _____	\$ _____
4. Payments to Contractholders from Policy Owner Services	\$ _____	\$ _____
5. Payment to Contractholder Beneficiaries for claims	\$ _____	\$ _____
 [1+2-3-4-5]	\$ _____	\$ _____

SCHEDULE G - PART III

MONTHLY SETTLEMENT REPORT

	Settlement Amount	Current Month Estimate	Quarter-To-Date
1. Mortality and Expense Charges	\$ _____	\$ _____	\$ _____
2. Premium Taxes	\$ _____	\$ _____	\$ _____
3. Expense Factor	\$ _____	\$ _____	\$ _____
4. Ceded Reinsurance Premiums	\$ _____	\$ _____	\$ _____
5. Ceded Reinsurance Benefits/Recoverables	\$ _____	\$ _____	\$ _____
6. Commissions and Other Fees or Compensation Paid: Trail and Add On (See Schedule J)	\$ _____	\$ _____	\$ _____
7. Insolvency Fund or Similar Assessments Paid		\$ _____	\$ _____
8. Other		\$ _____	\$ _____
[1-2-3-4+5-6-7-8]		\$ _____	\$ _____

SCHEDULE G - PART IV

QUARTERLY SETTLEMENT REPORT

		Previously Reported	Actual Quarter Results	True Up
<b>Daily Settlement Reconciliation</b>				
1	Premiums	_____	_____	_____
2	UIT Sales and Purchases	_____	_____	_____
3	Customer Transfers (Net)	_____	_____	_____
4	Redemption of Shares for Surrender Charges	_____	_____	_____
5	Redemption of Shares for Rider Fees and Loads	_____	_____	_____
	Corrections and Gain/Loss	_____	_____	_____
6	Payments to Contractholders and Beneficiaries	_____	_____	_____
7	Surrenders and Withdrawals	_____	_____	_____
8	Return of Premium-Freelooks	_____	_____	_____
	Death Benefits (Standard and Enhanced)	_____	_____	_____
9	Net (+1 +/-2 +3+4+/-5-6-7-8)	_____	_____	_____
<b>Monthly Settlement Reconciliation</b>				
10	Mortality & Expense Charges	_____	_____	_____
11	Premium Taxes	_____	_____	_____
12	Expense Factor	_____	_____	_____
13	Ceded Reinsurance Premium	_____	_____	_____
14	Ceded Reinsurance Benefits/Recoverables	_____	_____	_____
15	Commissions and other Fees or Compensation Paid	_____	_____	_____
16	Insolvency Fund or Similar Assessments Paid	_____	_____	_____
17	Extra Contractual Liabilities Paid	_____	_____	_____
18	Other	_____	_____	_____
19	Net (+10-11-12-13+14-15-16-17+/-18)	_____	_____	_____
20	<b>Quarterly Settlement (9+19)</b>	_____	_____	_____
<b>MODCO Adjustment Reconciliation</b>				
21	Beginning Separate Account Reserves	_____	_____	_____
22	UIT Sales and Purchases (+/-2 +3+4+/-5)	_____	_____	_____
23	Mortality & Expense Charges (10)	_____	_____	_____
24	UIT Appreciation	_____	_____	_____
25	Ending Separate Account Reserves (+21-22-23+/-24)	_____	_____	_____

SCHEDULE G - PART V

ANNUAL REPORT

The following in the same level of detail as the quarterly settlements:		
1. Premiums		
2. UIT Sales and Purchases		
3. Payments to Contractholders and Beneficiaries		
4. Premium Taxes		

5. Commissions and Other Fees or Compensation Paid		
Other information required to complete accounting and reporting:		
6. Expense allowance accrual at year end		
7. DAC and PVFP, as applicable		
8. Modco reserve to support completion of Schedule S and RBC		

SCHEDULE H  
FORM OF TRUST AGREEMENT

SCHEDULE I  
ELIGIBLE SECURITIES

Assets of the types for which an Illinois-domiciled life insurance company could obtain full statutory reserve credit under statutory accounting practices prescribed or permitted by the Director of Insurance of the State of Illinois.

SCHEDULE J  
COMMISSIONS

PRODUCT	MAXIMUM STANDARD COMMISSION*	MAXIMUM TRAIL COMMISSION**
CVA 90	5%	0.020833%
CVA Mitchell		
CVA Plus	6%	0.020833%
Extra	5.5%	0.020833%
Freedom	1.4%	0.08333%
Savvy Investor	1.4%	
Choice	7.0%	0.08333%
Selections	6.0%	0.08333%

\*Each percentage listed is an aggregate percentage of purchase payments made by the contract owner.

\*\*Trail commissions shown are monthly rates.

Wholesaling Variable Compensation

PRODUCT	RSG	IAN	GFA	IBG
CVA 90	60bps	0	390bps	0
CVA Plus	60bps	0	390bps	0
Extra	70bps	120bps	325bps	50bps
Freedom	45bps	100bps	70bps	50bps
Savvy Investor	0	0	0	0
Choice	70bps	130bps	360bps	50bps
Selections	45bps	130bps	360bps	50bps

Firm Marketing Related Expense Reimbursements

Firm	Expense Reimbursement for Add On Premium	Expense Reimbursement on Inforce (annual rates)
ABN AMRO	25bps on Choice & Selections	
AG EDWARDS	10bps on VA's > 1 year old	
BANK OF AMERICA	25bps on Choice & Extra	0bps on VA's — Yrs 0-2; 5bps on Choice, Extra, Selections — Yrs 3-5; 10bps on Choice, Extra, Selections — Yrs 6+.

CHASE	15bps on Foundation	5bps on Choice, Extra, Selections > 2 Yrs old.
FLEET QUICK & REILLY		8bps on Choice, Choice NY, Extra, Selections > 1 Yr old.
RAYMOND JAMES	15bps on Choice & Extra	
SALOMON SMITH BARNEY	50bps Excess Comp on Choice; 25bps Excess Comp on Extra & Selections	4bps on VA's > 1 Yr old
WACHOVIA SECURITIES LLC	20bps on Choice, Extra, & Selections; 10bps on Freedom	5bps on Choice, Extra, Selections > 1 Yr old
ESSEX	25bps on Choice, Extra, Freedom	
COMERICA	5bps on Choice & Extra	
FIRST ALLIED SECURITIES	15bps on Choice, Extra, Selections	
FIRST TENNESSEE BANK	25bps on Choice & Extra	
H&R BLOCK	5bps on Choice & Extra	
HSBC	10bps on Choice, Extra, Freedom, Selections	
LEGG MASON	25bps on Choice & Extra	
LINSCO PRIVATE LEDGER	40bps on Choice, Extra, Freedom	
MCDONALD/KEY	25bps on Choice & Extra	
PRIMEVEST	20bps on Choice & Extra	
RBC DAIN RAUSCHER INC	25bps on Choice & Extra	
UBS PAINWEBBER	20bps on Choice, Extra, Freedom	5bps on VA's — 4/1/97 — 9/30/00 Block
USB PIPER JAFFRAY	25bps on Choice, Extra, Selections	
UVEST	25bps on Choice & Extra	
FINTEGRA	15bps on Choice & Extra	
IFMIG	25bps on Choice, Extra, Selections	
STANFORD GROUP	15bps on Choice & Extra	
WASHINGTON MUTUAL	25bps on Choice	

Ceding Company Marketing Allowance on Add-On Premiums: 78bps



---

**REINSURANCE AGREEMENT**

between

**GE CAPITAL LIFE ASSURANCE COMPANY OF NEW YORK**

and

**UNION FIDELITY LIFE INSURANCE COMPANY**

**Dated as of April 15, 2004**

---

TABLE OF CONTENTS

<a href="#">ARTICLE I</a>	<a href="#">DEFINITIONS</a>
<a href="#">ARTICLE II</a>	<a href="#">COVERAGE</a>
<a href="#">ARTICLE III</a>	<a href="#">ADMINISTRATION; GENERAL PROVISIONS</a>
<a href="#">ARTICLE IV</a>	<a href="#">GENERAL ACCOUNT ASSET TRANSFER; CEDING COMMISSION; INITIAL MODCO RESERVE</a>
	<a href="#">ADJUSTMENT</a>
<a href="#">ARTICLE V</a>	<a href="#">EXPENSE ALLOWANCES</a>
<a href="#">ARTICLE VI</a>	<a href="#">ACCOUNTING AND SETTLEMENT; MODCO ADJUSTMENT</a>
<a href="#">ARTICLE VII</a>	<a href="#">DURATION AND TERMINATION</a>
<a href="#">ARTICLE VIII</a>	<a href="#">INSOLVENCY</a>
<a href="#">ARTICLE IX</a>	<a href="#">CREDIT FOR REINSURANCE</a>
<a href="#">ARTICLE X</a>	<a href="#">REINSURANCE SECURITY</a>
<a href="#">ARTICLE XI</a>	<a href="#">DEFERRED ACQUISITION COSTS</a>
<a href="#">ARTICLE XII</a>	<a href="#">DISPUTE RESOLUTION</a>
<a href="#">ARTICLE XIII</a>	<a href="#">MISCELLANEOUS PROVISIONS</a>
<u>SCHEDULES</u>	
<a href="#">SCHEDULE A</a>	— <a href="#">POLICY FORMS</a>
<a href="#">SCHEDULE B</a>	— <a href="#">SEPARATE ACCOUNTS</a>
<a href="#">SCHEDULE C</a>	— <a href="#">FORM OF ADMINISTRATIVE SERVICES AGREEMENT</a>
<a href="#">SCHEDULE D</a>	— <a href="#">CEDING COMMISSION</a>
<a href="#">SCHEDULE E</a>	— <a href="#">ASSETS</a>
<a href="#">SCHEDULE F</a>	— <a href="#">EXPENSE ALLOWANCES</a>
<a href="#">SCHEDULE G</a>	— <a href="#">Part I - INITIAL REPORT</a>
<a href="#">SCHEDULE G</a>	— <a href="#">Part II - DAILY SETTLEMENT REPORT</a>
<a href="#">SCHEDULE G</a>	— <a href="#">Part III - MONTHLY SETTLEMENT REPORT</a>
<a href="#">SCHEDULE G</a>	— <a href="#">Part IV - QUARTERLY SETTLEMENT REPORT</a>
<a href="#">SCHEDULE G</a>	— <a href="#">Part V - ANNUAL REPORT</a>
<a href="#">SCHEDULE H</a>	— <a href="#">FORM OF TRUST AGREEMENT</a>
<a href="#">SCHEDULE I</a>	— <a href="#">ELIGIBLE SECURITIES</a>
<a href="#">SCHEDULE J</a>	— <a href="#">COMMISSIONS</a>

REINSURANCE AGREEMENT

This Reinsurance Agreement, dated as of April 15, 2004 (this "Agreement"), is made and entered into by and between GE Capital Life Assurance Company of New York, an insurance company organized under the laws of the State of New York (the "Company"), and Union Fidelity Life Insurance Company, an insurance company organized under the laws of the State of Illinois (the "Reinsurer"). Defined terms used herein are defined below.

The Company and the Reinsurer mutually agree to reinsure the risks described in this Agreement under the terms and conditions stated herein. This Agreement is an indemnity coinsurance and modified coinsurance agreement solely between the Company and the Reinsurer, and the performance of the obligations of each party under this Agreement shall be rendered solely to the other party. In no instance shall anyone other than the Company or the Reinsurer have any rights under this Agreement. The Company shall be and shall remain the only party hereunder that is liable to any insured, Contractholder, policyholder, claimant or beneficiary under any

insurance policy or contract reinsured hereunder.

This Agreement is entered into in connection with an intercompany reorganization among the Company, the Reinsurer and certain of their Affiliates.

## ARTICLE I

### DEFINITIONS

1.1. Definitions. As used in this Agreement, the following terms shall have the following meanings (definitions are applicable to both the singular and the plural forms of each term defined in this Article):

“Affiliate” means any other Person that directly or indirectly controls, is controlled by, or is under common control with, the first Person. “Control” (including the terms, “controlled by” and “under common control with”) means the possession, directly or indirectly, of the power to direct or cause the direction of the management and policies of a Person, whether through the ownership of voting securities, by contract or credit arrangement, as trustee or executor, or otherwise.

“Agreement” shall have the meaning specified in the first paragraph of this Agreement.

“Annual Report” shall have the meaning specified in Section 6.6.

“Applicable Law” means any federal, state, local or foreign law (including common law), statute, ordinance, rule, regulation, order, writ, injunction, judgment, permit, governmental agreement or decree applicable to a Person or any of such Person’s subsidiaries, properties, assets, or to such Person’s officers, directors, managing directors, employees or agents in their capacity as such.

“Assets” shall have the meaning specified in Section 4.4(a).

---

“Assignment Letter Agreement” means the letter agreement dated the date hereof among General Electric Capital Corporation, a Delaware corporation, the Reinsurer, the Company and certain affiliates of the Company relating to the assignment by General Electric Capital Corporation of the Capital Maintenance Agreement.

“Business Day” means any day other than a Saturday, Sunday or other day on which the New York Stock Exchange is closed for trading.

“Capital Maintenance Agreement” means the Capital Maintenance Agreement between General Electric Capital Corporation, a Delaware corporation, and the Reinsurer.

“Ceded Reinsurance” means all reinsurance ceded by the Company pursuant to contracts, binders, certificates, treaties or other evidence of reinsurance relating to the Reinsured Risks in effect on or prior to the Inception Date, except the reinsurance provided pursuant to this Agreement.

“Ceded Reinsurance Agreements” means all of the contracts, binders, certificates, treaties or other evidence for Ceded Reinsurance.

“Ceding Commission” shall have the meaning specified in Section 4.2.

“Closing Date” means April 15, 2004.

“Code” means the Internal Revenue Code of 1986, as amended.

“Commutation” means, with respect to any portion of the Ceded Reinsurance, a commutation or other similar transaction that results in the termination of such Ceded Reinsurance with respect to the Reinsured Contracts.

“Company Account” shall have the meaning specified in Section 10.1(e).

“Contractholder” shall mean the holder of any Reinsured Contract.

“CPR” shall have the meaning specified in Section 12.3.

“CPR Arbitration Rules” shall have the meaning specified in Section 12.4(a).

“Daily Settlement Account” shall have the meaning specified in Section 6.2(a).

“Daily Settlement Amount” means, with respect to a particular Business Day, the results of the calculation set forth on Schedule G - Part II for such day.

“Daily Settlement Report” shall have the meaning specified in Section 6.2(b).

“Dispute” shall have the meaning specified in Section 12.1(a).

“Eligible Securities” shall have the meaning specified in Section 10.1(c).

“Expense Allowance” shall have the meaning specified in Section 5.1.

“Extra Contractual Liabilities” means all liabilities for damages (including compensatory, consequential, exemplary, punitive, bad faith or similar or other damages) which relate to the marketing, sale, underwriting, issuance, delivery, cancellation or administration of the Reinsured Contracts, including liability arising out of or

relating to any alleged or actual acts, errors or omissions by the Company or its agents, whether intentional or otherwise, with respect to any of the Reinsured Contracts, including (A) any alleged or actual reckless conduct or bad faith in connection with the handling of any claim arising out of or under Reinsured Contracts, or (B) the marketing, sale, underwriting, issuance, delivery, cancellation or administration of any of the Reinsured Contracts.

“Force Majeure” shall have the meaning specified in Section 3.10(b)(iii).

“Funding Requirement” shall have the meaning specified in Section 10.1(e).

“GAAP” means U.S. generally accepted accounting principles consistently applied.

“General Account Liabilities” means all net retained general account insurance liabilities and obligations arising under the Reinsured Contracts, including, without limitation (i) benefits, surrender amounts and other amounts payable to Contractholders under the terms of the Reinsured Contracts, (ii) premium taxes due in respect of premiums and other consideration paid on or after the Inception Date with respect to the Reinsured Contracts, (iii) Insolvency Fund or other premium based assessments, net of any premium tax credits of the Company arising out of any such assessments, based on premiums and other consideration paid on or after the Inception Date with respect to the Reinsured Contracts, (iv) all amounts payable on or after the Inception Date for returns or refunds of premiums under the Reinsured Contracts, (v) all liability for commission payments and other fees or compensation payable with respect to the Reinsured Contracts in respect of premiums and other consideration paid on or after the Inception Date and (vi) all Extra Contractual Liabilities resulting from actions of the Company or its agents to the extent reinsurance of such liabilities is permitted by state law; but in all cases excluding: (w) the Separate Account Liabilities; (x) Post-Inception Date Extra Contractual Liabilities; (y) any general account liabilities which relate to (A) amounts transferred from the Separate Accounts to the general account of the Company pending distribution to holders of the Reinsured Contracts, and (B) amounts held in the general account of the Company pending transfer to the Separate Accounts; and (z) compensation agreements, arrangements and practices (A) that exceed the broker commission rates as shown for each product on Schedule J, (B) that exceed the wholesale expense rates as shown for each product on Schedule J, (C) that exceed the firm marketing related expense reimbursement rates as shown for each firm on Schedule J, (D) that exceed the marketing allowance as shown on Schedule J, or (E) that result from changes to compensation plans for any sales organization on or after the Inception Date, unless otherwise agreed to in writing by the Reinsurer or to the extent such excess costs are offset by an increase in the fund company administrative expense service share referred to in Schedule F.

“General Account Reserves” means the general account statutory reserves of the Company (without regard to the transactions contemplated by this Agreement) with respect to the General Account Liabilities determined pursuant to SAP, as such reserves would have been

included in lines 1 and 13 of the Liabilities, Surplus and Other Funds page of the NAIC Annual Statement Blank (2003 Format).

“Governmental Authority” means any foreign or national government, any state or other political subdivision thereof or any self regulatory authority, and any entity exercising executive, legislative, judicial, regulatory or administrative functions of or pertaining to government.

“Inception Date” shall have the meaning specified in Section 2.1(a).

“Initial MODCO Reserve Adjustment” means the amount specified in Section 4.3.

“Initial Notice” shall have the meaning specified in Section 12.2.

“Initial Reinsurance Premium” shall have the meaning specified in Section 4.1(a).

“Initial Report” shall have the meaning specified in Section 6.1.

“Insolvency Fund” means any guarantee fund, insolvency fund, plan, pool, association, fund or other arrangement, however denominated, established or governed, which provides for any assessment of or payment or assumption by the Company of part or all of any claim, debt, charge, fee or other obligation of an insurer or reinsurer, or its successors or assigns, which has been declared by any competent authority to be insolvent, or which is otherwise deemed unable to meet any claim, debt, charge, fee or other obligation in whole or in part.

“Monthly Accounting Period” means each calendar month, except that the last Monthly Accounting Period shall be the period commencing with the first day of the calendar month in which the Termination Date falls and ending with the Termination Date.

“Monthly Settlement” shall have the meaning specified in Section 4.4(a).

“Monthly Settlement Report” shall have the meaning specified in Section 6.3.

“NAIC” means the National Association of Insurance Commissioners.

“Non-Guaranteed Elements” shall have the meaning specified in Section 3.3.

“Person” means any natural person, firm, limited liability company, general partnership, limited partnership, joint venture, association, corporation, trust, Governmental Authority or other entity.

“Post-Inception Date Extra Contractual Liabilities” means Extra Contractual Liabilities attributable to the conduct of the Company on or after the Inception Date in connection with the Company’s administration of the Reinsured Contracts, other than actions taken by the Company at the written request or direction of the Reinsurer or in connection with the Company’s marketing activities with respect to the Reinsured Contracts.

“Quarterly Accounting Period” means each calendar quarter, except that the last Quarterly Accounting Period shall be the period commencing with the first day of the calendar quarter in which the Termination Date falls and ending with the Termination Date.

“Quarterly Accounting Period MODCO Adjustment” shall have the meaning set forth in Section 6.7.

“Quarterly Settlement” shall have the meaning specified in Section 4.4(a).

“Quarterly Settlement Report” shall have the meaning specified in Section 6.4.

“RBC Reporting Letter Agreement” means the letter agreement dated the date hereof among the Company, the Reinsurer and certain affiliates of the Company relating to the Reinsurer’s requirement to provide periodic certifications and reports regarding the Reinsurer’s risk based capital ratio.

“Reinsurance Recoverables” means the amount of reinsurance recoverables that are actually collected under Ceded Reinsurance.

“Reinsured Contracts” means the variable annuity contracts issued by the Company and recorded in the Company’s administration system on or prior to December 4, 2003 and written on the policy forms described in Schedule A, including any contract riders or endorsements issued with respect thereto after the Inception Date with the prior written consent of the Reinsurer.

“Reinsured Risks” shall have the meaning specified in Section 2.1(a).

“Response” shall have the meaning specified in Section 12.2.

“SAP” means statutory accounting practices prescribed or permitted by the Insurance Department of the State of New York.

“Separate Account Charges” shall have the meaning specified in Section 4.1(b).

“Separate Account Liabilities” means those insurance liabilities that are reflected in the Separate Accounts and that relate to the Reinsured Contracts, including (i) amounts transferred from the Separate Accounts to the general account of the Company pending distribution to holders of the Reinsured Contracts, and (ii) amounts held in the general account of the Company pending transfer to the Separate Accounts.

“Separate Account Reserves” means the separate account statutory reserves of the Separate Accounts (without regard to the transactions contemplated by this Agreement) with respect to the Reinsured Contracts determined pursuant to SAP, as such reserves would have been included in line 27 of the Liabilities, Surplus and Other Funds page of the NAIC Annual Statement Blank (2003 Format).

“Separate Accounts” means the separate accounts of the Company described on Schedule B hereto.

“Tax DAC” means specified policy acquisition expenses capitalized and amortized under section 848 of the Code.

“Termination Date” means the effective date of any termination of this Agreement as provided in Article VII.

“Termination Letter Agreement” means the letter agreement dated the date hereof among the Company, the Reinsurer and certain affiliates of the Company relating to the rescission of this Agreement upon the failure of certain events to occur after the date hereof.

“Trust Account” shall have the meaning specified in Section 10.1(a).

“Trust Agreement” shall have the meaning specified in Section 10.1(a).

“Trustee” shall have the meaning specified in Section 10.1(a).

## ARTICLE II

### COVERAGE

2.1. Coverage. (a) Upon the terms and subject to the conditions and other provisions of this Agreement, as of 12:01 a.m. Eastern Time on January 1, 2004 (the “Inception Date”), the Company hereby cedes to the Reinsurer, and the Reinsurer hereby agrees to indemnify the Company (i) on a coinsurance basis, for one hundred percent (100%) of the General Account Liabilities and (ii) on a modified coinsurance basis, for 100% of the Separate Account Liabilities, in each case, payable by the Company under the Reinsured Contracts on or after the Inception Date (the “Reinsured Risks”). For the avoidance of doubt, the Reinsurer shall assume the risk for all uncollectible or uncollected reinsurance recoverables under the Ceded Reinsurance.

(b) Upon the annuitization of a Reinsured Contract, such Reinsured Contract will be considered surrendered and the Reinsurer will pay to the Company an amount equal to the general account value applied to the annuitization. In such event, no further obligation or liability will exist for the Reinsurer with respect to such annuitized Reinsured Contract.

2.2. Conditions. (a) If the Company’s liability under any of the Reinsured Contracts is changed because of changes made on or after the Inception Date in the terms and conditions of the Reinsured Contracts (including to any contract riders or endorsements thereto) that are required due to changes in Applicable Law, the Reinsurer will share in the change proportionately to the coinsurance share hereunder and the Company and the Reinsurer will make all appropriate adjustments to amounts due each other under this Agreement.

(b) Except as otherwise set forth or contemplated herein, including in paragraph (a) above, no changes, amendments or modifications made on or after the Inception Date in the terms and conditions of the Reinsured Contracts (including to any contract riders or endorsements thereto) which adversely affect the liability of the Reinsurer hereunder shall be covered hereunder without the prior written approval of such changes, amendments or

any Reinsured Contract without the prior written approval of the Reinsurer, this Agreement will cover Reinsured Risks incurred by the Company under such Reinsured Contract as if the non-approved changes, amendments or modifications had not been made.

(c) The Company will not change fund options for the Separate Accounts from and after the Inception Date unless such changes are made: (a) with the prior written consent of the Reinsurer, in its sole discretion, (b) in fulfillment of the fiduciary obligations of the Company after consultation with the Reinsurer or (c) by the Board of Trustees of an unaffiliated fund (trust) to liquidate, merge or remove a fund pursuant to the terms of the then existing fund participation agreements or through a regulatory process.

2.3. Territory. The territorial limits of this Agreement shall be identical with those of the Reinsured Contracts.

2.4. Commutation of Ceded Reinsurance. (a) The Company shall not, without the Reinsurer's prior written approval in its sole discretion, take any action to amend, waive or terminate, in whole or in part, any Ceded Reinsurance under any Ceded Reinsurance Agreement or enter into any Commutation of Ceded Reinsurance.

(b) Subsequent to the Inception Date, the Company will not enter into any reinsurance arrangements with respect to the Reinsured Contracts without the prior written consent of the Reinsurer, in its sole discretion.

### ARTICLE III

#### ADMINISTRATION: GENERAL PROVISIONS

3.1. Contract Administration. (a) Subject to Section 3.10, the Company shall provide policyholder and claims servicing with respect to the Reinsured Contracts and administer the Separate Accounts in accordance with the terms hereof including, but not limited to, the collection of premiums and other amounts due from Contractholders, the payment of all General Account Liabilities and Separate Account Liabilities and the administration of claims and disbursements, which disbursements shall be made (i) directly by the Company with respect to such disbursements relating to the General Account Liabilities and (ii) from the Separate Accounts with respect to such disbursements relating to the Separate Account Liabilities. The Company shall provide policyholder and claims servicing with respect to the Reinsured Contracts and administer the Separate Accounts in good faith and with the care, skill, prudence and diligence of a person experienced in administering variable annuity business. The Company shall provide policyholder and claims servicing with respect to the Reinsured Contracts and administer the Separate Accounts, (i) in accordance with the terms of the Reinsured Contracts, (ii) in accordance with the applicable terms of this Agreement, (iii) in compliance with Applicable Law and, subject to the foregoing, (iv) in the same manner as it conducts its own business not subject to this Agreement and (v) in accordance with the Company's administrative performance standards in effect on the date hereof, with such revisions to such standards as are

7

---

no less favorable to the Reinsurer than such standards. Notwithstanding the foregoing, the parties may, from time to time, mutually develop specific and/or different standards for providing such services with respect to the Reinsured Contracts and the Separate Accounts.

(b) The Company may subcontract for the performance of any policyholder or claims servicing service or services with respect to the Reinsured Contracts or any services the Company is to provide in the administration of the Separate Accounts to (i) an Affiliate or (ii) any other Person with the prior written consent of the Reinsurer, such consent not to be unreasonably withheld; provided, that the Company also subcontracts for such service or services for its own variable annuities business not subject to this Agreement to such subcontractor; and provided, further, that no such subcontracting shall relieve the Company from any of its obligations or liabilities hereunder, and the Company shall remain responsible for all obligations or liabilities of such subcontractor with regards to the providing of such service or services as if provided by the Company.

3.2. Ceded Reinsurance Agreements. The Company shall manage and administer the Ceded Reinsurance Agreements, including providing all reports and notices required with regard to the Ceded Reinsurance Agreements to the reinsurers within the time required by the applicable reinsurance agreement and doing all other things necessary to comply with the terms and conditions of the Ceded Reinsurance Agreements. Without limiting the foregoing, the Company shall timely pay all reinsurance premiums due to reinsurers under the Ceded Reinsurance Agreements and diligently collect from such reinsurers all reinsurance recoverables due thereunder.

3.3. Non-Guaranteed Elements. The Company shall set all rider charges, interest rates to be credited on the Reinsured Contracts and other non-guaranteed elements of the Reinsured Contracts ("Non-Guaranteed Elements") from and after the Inception Date. The Company shall allow the Reinsurer to participate in all decisions made by the Company with respect to setting Non-Guaranteed Elements.

3.4. Policy Exchanges. Unless otherwise agreed by the parties, the Company will not make any targeted exchange offers with regards to the Reinsured Contracts or otherwise target the Reinsured Contracts for replacement.

3.5. Claims Settlements. The Company agrees that it will provide prompt notice to the Reinsurer of its intention to contest, compromise or litigate a claim with respect to a Reinsured Contract, along with copies of all pleadings and reports of investigation with respect thereto. The Reinsurer shall have the right, at its own expense, to participate jointly with the Company in the investigation, adjustment or defense of such claims. In addition, in the event that litigation arises against the Company in connection with a claim which seeks damages in excess of \$1 million or other remedies deemed material to the Reinsurer, the Reinsurer may, upon written notice to the Company, assume the defense thereof with counsel selected by the Reinsurer and reasonably satisfactory to the Company. If the Reinsurer assumes such defense, the Company shall have the right, at its own expense, to participate jointly with the Reinsurer in the defense thereof. If the Reinsurer assumes the defense of litigation, the Reinsurer shall not settle such litigation without the Company's prior written consent (which consent shall not be unreasonably withheld or delayed) unless (i) there is no finding or admission of any violation of

8

---

law or any violation of the rights of any Person, (ii) such settlement would not reasonably be expected to have material adverse precedential consequences to the Company and (iii) the sole relief provided is monetary damages that are paid in full by the Reinsurer.

3.6. Inspection. The Company shall keep accurate and complete records, files and accounts of all transactions and matters with respect to the Reinsured Contracts and the Company's administration thereof in accordance with Applicable Law and its record management practices in effect from time to time for the Company's insurance business not covered by this Agreement. The Reinsurer and its designated representatives may upon reasonable notice inspect, at the offices of the Company where such records are located, the papers and any and all other books or documents of the Company reasonably relating to this Agreement, including the Reinsured Contracts and the administration thereof by the Company (including compliance with the provisions of Section 3.1), and shall have access to appropriate employees and representatives of the Company, in each case during normal business hours for such period as this Agreement is in effect or for as long thereafter as the Company seeks

performance by the Reinsurer pursuant to the terms of this Agreement or the Reinsurer reasonably needs access to such records for regulatory, tax or similar purposes. The information obtained shall be used only for purposes relating to the transactions contemplated under this Agreement.

3.7. Errors and Omissions. If any delay, omission, error or failure to pay amounts due or to perform any other act required by this Agreement is unintentional and caused by misunderstanding or oversight, the Company and the Reinsurer will adjust the situation to what it would have been had the misunderstanding or oversight not occurred. The party first discovering such misunderstanding or oversight, or an act resulting from such misunderstanding or oversight, will notify the other party in writing promptly upon discovery thereof, and the parties shall act to correct such misunderstanding or oversight within twenty (20) Business Days of such other party's receipt of such notice. However, this Section shall not be construed as a waiver by either party of its right to enforce strictly the terms of this Agreement.

3.8. Age, Sex and Other Adjustments. If the Company's liability under any of the Reinsured Contracts is changed because of a misstatement of age or sex or any other material fact, the Reinsurer will share in the change proportionately to the coinsurance share hereunder and the Company and the Reinsurer will make all appropriate adjustments to amounts due each other under this Agreement.

3.9. Setoff. Any debts or credits, matured or unmatured, in favor of or against either the Company or the Reinsurer with respect to this Agreement are deemed mutual debts or credits, as the case may be, and shall be setoff from any amounts due to the Company or the Reinsurer hereunder, as the case may be, and only the net balance shall be allowed or paid.

3.10. Administration by Reinsurer. (a) At any time from and after the fifteenth (15th) anniversary of the Inception Date, the Reinsurer shall have the right to assume from the Company the administration of the Reinsured Contracts, provided that the Reinsurer provides twelve (12) months prior written notice of such assumption, which notice may be given as early as the fourteenth (14th) anniversary of the Inception Date to take effect as of the fifteenth (15th) anniversary of the Inception Date. The Reinsurer shall bear all transition costs associated with

9

---

an assumption of the administration of the Reinsured Contracts pursuant to this paragraph (a) of this Section 3.10.

(b) In addition to the provisions of Section 3.10(a), the Reinsurer shall have the right, upon written notice to the Company, to assume from the Company, the administration of the Reinsured Contracts upon the occurrence of any of the following events:

- (i) A voluntary or involuntary proceeding is commenced in any jurisdiction by or against the Company for the purpose of conserving, rehabilitating or liquidating the Company;
- (ii) There is a material breach by the Company of any material term or condition of this Article III that is not cured by the Company within thirty (30) days after receipt of written notice from the Reinsurer of such breach or act (provided that the Reinsurer shall not have the right to assume such administration (A) for so long as the Company is making a good faith effort to cure such a breach, not to exceed an additional one hundred eighty (180) days or (B) during the pendency of any dispute resolution proceedings as set forth in Article XII regarding an alleged material breach); or
- (iii) The Company is unable to perform the services required under this Article III for a period of thirty (30) consecutive days for any reason, other than as a result of a Force Majeure, it being understood that nothing in this Section 3.10(b)(iii) shall relieve the Company from its administrative responsibilities under this Agreement. For purposes of this Agreement "Force Majeure" means any acts or omissions of any civil or military authority, acts of God, acts or omissions of the Reinsurer, fires, strikes or other labor disturbances, equipment failures, fluctuations or non-availability of electrical power, heat, light, air conditioning or telecommunications equipment, or any other act, omission or occurrence beyond the Company's reasonable control, irrespective of whether similar to the foregoing enumerated acts, omissions or occurrences.

(c) The Company shall bear all transition costs associated with an assumption of the administration of the Reinsured Contracts pursuant to Section 3.10(b).

(d) In the event of the Reinsurer's assumption of the administration of the Reinsured Contracts, the Reinsurer and the Company shall enter into an administrative services agreement in the form attached hereto as Schedule C and the provisions of Section 2.1(b) and Article V shall become inoperative.

(e) In the event that the Reinsurer is not properly licensed to administer the Reinsured Contracts at the time of a proposed transfer of administration under this Section 3.10, the Reinsurer may designate a properly licensed entity that has appropriately trained and licensed personnel reasonably acceptable to the Company to administer the Reinsured Contracts in its stead, and the administrative services agreement referred to in paragraph (d) above shall be

10

---

executed by such properly licensed entity in lieu of the Reinsurer. The designation and assumption of administration by such entity shall not relieve the Reinsurer from any of its obligations or liabilities hereunder (except as set forth in paragraph (d) above), and the Reinsurer shall remain responsible for all obligations or liabilities of such entity with regards to the providing of such administration as if provided by the Reinsurer. The parties shall take all actions reasonably necessary to effect the prompt transfer of administration provided in this Section 3.10.

(f) In the event of the assumption of the administration of the Reinsured Contracts under this Section 3.10, the Reinsurer and the Company shall take all actions necessary or appropriate to transfer administration of the Separate Account Liabilities to the Reinsurer or its permitted designee. Such actions shall include, without limitation, the establishment and maintenance of a new separate account of the Company solely for the Reinsured Contracts and the transfer of the assets of the Separate Account allocable to the Reinsured Contracts to such new separate account.

#### ARTICLE IV

##### GENERAL ACCOUNT ASSET TRANSFER; CEDING COMMISSION; INITIAL MODCO RESERVE ADJUSTMENT

4.1. Asset Transfer. (a) As consideration for the reinsurance by the Reinsurer of the General Account Liabilities under this Agreement, on the Closing Date, the Reinsurer shall be entitled to an amount equal to one hundred percent (100%) of the General Account Reserves as of the close of business on the day immediately preceding the Inception Date (the "Initial Reinsurance Premium").

(b) As additional consideration for the Reinsurer entering into this Agreement, the Reinsurer shall be entitled to 100% of all premiums and other considerations to the extent received on or after the Inception Date by the Company or the Reinsurer with respect to the General Account Liabilities, less an amount equal to

the reinsurance premium due under the Ceded Reinsurance Agreements to the extent such premium relates to coverage on or after the Inception Date with respect to the Reinsured Contracts. In addition, with respect to the Separate Account Liabilities, the Reinsurer shall be entitled to 100% of all (i) mortality and expense risk charges and administrative expense charges (collectively, "asset charges"), any rider charges (to the extent the riders are reinsured hereunder), and contract maintenance charges, back-end sales loads and other considerations billed separately for the Reinsured Contracts collected by the Company on or after the Inception Date, and (ii) any other charges, fees and similar amounts received by the Company from the Separate Accounts on or after the Inception Date (collectively, the "Separate Account Charges"). The Company hereby assigns to the Reinsurer all of its rights to such premiums and other considerations payable to the Company. For the avoidance of doubt, the Separate Account Charges shall not include any distribution fees received from underlying mutual funds pursuant to a plan adopted pursuant to Rule 12b-1 under the Investment Company Act of 1940.

4.2. Ceding Commission. On the Closing Date, the Company shall be entitled to a ceding commission (the "Ceding Commission") in an amount determined in accordance with Schedule D.

4.3. Initial MODCO Reserve Adjustment. As additional consideration for the reinsurance by the Reinsurer of the Separate Account Liabilities under this Agreement, on the Closing Date, the Company shall transfer to the Reinsurer an amount equal to the net of (a) minus (b) where (a) is an amount equal to the Separate Account Liabilities as of the Inception Date and (b) is the Initial MODCO Reserve Adjustment. The "Initial MODCO Reserve Adjustment" shall be an amount equal to the Separate Account Liabilities as of the Inception Date.

4.4. Amounts Due the Parties. (a) Except as otherwise specifically provided herein, all amounts due to be paid to the Company or the Reinsurer under this Agreement shall be determined on a net basis, giving full effect to Section 3.9. The net amount due the Reinsurer from the Company on the Closing Date under Section 4.1(a) and Section 4.2 shall consist of (i) the investment assets (the "Assets") set forth on Schedule E, which assets have a statutory book value as of the close of business on the day immediately preceding the Inception Date equal to (A) the Initial Reinsurance Premium, less (B) the Ceding Commission, less (C) an amount equal to accrued but unpaid interest on the Assets as of the close of business on the day immediately preceding the Inception Date, plus (ii) an amount equal to the investment cash flows received on the Assets between the Inception Date and the Closing Date. The Company shall pay such net amount concurrent with its delivery of the Initial Report. Each net amount subsequently due the Company or the Reinsurer with respect to each Monthly Accounting Period ending after the Inception Date as reflected on a Monthly Settlement Report (the "Monthly Settlement") shall be paid in cash by the owing party no later than thirty (30) days after delivery of the Monthly Settlement Report. Each net amount subsequently due the Company or the Reinsurer with respect to each Quarterly Accounting Period ending after the Inception Date as reflected on a Quarterly Settlement Report (the "Quarterly Settlement") shall be paid in cash by the owing party no later than thirty (30) days after delivery of the Quarterly Settlement Report. Each net amount subsequently due the Company or the Reinsurer with respect to each calendar year ending after the Inception Date as reflected on an Annual Report shall be paid in cash by the owing party no later than thirty (30) days after delivery of the Annual Report.

(b) The Company shall deliver to the Reinsurer possession of the Assets and such bills of sale, endorsements, assignments and other good and sufficient instruments of conveyance and transfer in form and substance reasonably acceptable to the parties as shall be effective to vest in the Reinsurer all of the right, title and interest of the Company in and to the Assets. Delivery of the Assets shall be a condition precedent of reinsurance coverage hereunder.

#### ARTICLE V

##### EXPENSE ALLOWANCES

5.1. Expense Allowance. As reimbursement for expenses incurred by the Company in the providing of policyholder and claims servicing services with respect to the

Reinsured Contracts, the Reinsurer shall pay to the Company with respect to each Monthly Accounting Period ending after the Inception Date, an expense allowance (each an "Expense Allowance") in an amount calculated in accordance with Schedule F, as subsequently adjusted in accordance with the methodology and procedures set forth on Schedule F; provided that if the amount calculated in accordance with Schedule F with respect to any Monthly Accounting Period should be negative, such negative amount shall be credited to the Reinsurer on the Monthly Settlement Report for such period.

#### ARTICLE VI

##### ACCOUNTING AND SETTLEMENT; MODCO ADJUSTMENT

6.1. Initial Report. A report shall be provided by the Company to the Reinsurer on the Closing Date providing the data required in Schedule G - Part I (the "Initial Report").

6.2. Daily Settlement Amounts. (a) On the Closing Date, the Reinsurer shall establish a separate bank account (the "Daily Settlement Account") in its own name for the payment of Daily Settlement Amounts and shall authorize at least two signatories who shall be representatives of the Company and approved by the Reinsurer to make deposits to, and withdrawals from, the Daily Settlement Account.

(b) By 10:00 a.m. Eastern Time each Business Day following the Closing Date during the term of this Agreement, the Company shall calculate the Daily Settlement Amount for the prior Business Day. Promptly following such calculation, the Company shall forward to the Reinsurer a report in the form of Schedule G - Part II that shall provide the details of such calculation (the "Daily Settlement Report"). Prior to 6:00 p.m. of such Business Day, the Company or the Reinsurer, as appropriate, shall deposit into the Daily Settlement Account an amount equal to such Daily Settlement Amount owed by such party to the other. The party to whom such Daily Settlement Amount is owed shall have a right to withdraw such deposited amount at any time following such deposit.

(c) The Company shall keep true and complete records, in accordance with Applicable Law and its record management practices in effect from time to time for the Company's insurance business not covered by this Agreement, clearly recording the deposits in and withdrawals from the Daily Settlement Account. The Company will make available to the Reinsurer or its designated representative, or shall furnish to the Reinsurer or its designated representative, upon request of the Reinsurer or its designated representative, copies of all such records. All copies furnished in the ordinary course of business shall be furnished by the Company at the Company's cost, which shall be included in the Expense Allowance. Any extraordinary costs reasonably incurred by the Company in response to requests from the Reinsurer shall be reimbursed by the Reinsurer.

(d) The parties agree to deliver to the depository bank such depository resolutions, signature cards and other documents as may be requested of them in order to use such accounts at the depository bank in accordance with the provisions of this Section 6.2.

(e) Upon a termination of this Agreement pursuant to Article VII, the Reinsurer shall close the Daily Settlement Account and any closing balance therein shall be the property of the Reinsurer.

6.3. Monthly Settlement Reports. As soon as practicable but not more than thirty (30) days following the end of each Monthly Accounting Period ending after the Closing Date (or more frequently as mutually agreed by the parties), the Company shall supply the Reinsurer with a report that shall provide the financial data for such Monthly Accounting Period required in Schedule G - Part III (the "Monthly Settlement Report").

6.4. Quarterly Settlement Reports. As soon as practicable but not more than forty (40) days following the end of each Quarterly Accounting Period ending after the Closing Date (or more frequently as mutually agreed by the parties), the Company shall supply the Reinsurer with a report that shall provide the financial data for such Quarterly Accounting Period required in Schedule G - Part IV (the "Quarterly Settlement Report"). The Company and the Reinsurer agree that the financial data set forth on the Monthly Settlement Reports used for purposes of the Monthly Settlements, shall be trued-up to actual amounts in the next Quarterly Settlement Report and the net amount, if any, subsequently due to the Company or the Reinsurer, as the case may be, as a result of such adjustments shall be paid to the Company or the Reinsurer, as applicable. For the avoidance of doubt, the first Quarterly Settlement Report will include all transactions with respect to the Reinsured Contracts occurring from the Inception Date through June 30, 2004.

6.5. Quarterly Financial Reports. As soon as practicable but not more than forty (40) days following the end of each Quarterly Accounting Period ending after the Closing Date (or more frequently as mutually agreed by the parties), the Company shall supply the Reinsurer with reports related to the Reinsured Contracts as may be reasonably requested for use in connection with the preparation of the Reinsurer's SAP financial statements or other reports prepared by the Reinsurer in compliance with its internal reporting requirements. The parties shall cooperate in good faith to establish the form for the providing of such reports.

6.6. Annual Reports. Within forty-five (45) days after the end of each calendar year during the term of this Agreement (or more frequently as mutually agreed by the parties), the Company shall supply the Reinsurer with a report that shall provide the financial data for such year required in Schedule G - Part V (the "Annual Report").

6.7. Accounting Period MODCO Reserve Adjustment. At the end of each Quarterly Accounting Period, the Company shall compute an amount equal to the absolute value of the increase or decrease in the Separate Account Reserves due to subaccount investment performance for the Quarterly Accounting Period just ended (the "Quarterly Accounting Period MODCO Adjustment"). The Quarterly Accounting Period MODCO Adjustment for each Quarterly Accounting Period shall be reflected in the Quarterly Settlement Report for such Quarterly Accounting Period.

6.8. Additional Reports and Updates. For so long as this Agreement remains in effect, each of the parties shall periodically furnish to the other such other reports and

information as may be reasonably requested by such other party for regulatory, tax or similar purposes and reasonably available to it.

6.9. Delayed Payments. In the event that all or any portion of any payment due either party pursuant to this Agreement becomes overdue, the portion of the amount overdue shall bear interest at an annual rate equal to the then current thirty (30) day U.S. Treasury Bill discount rate on the date that the payment becomes overdue plus 200 basis points, for the period that the amount is overdue.

## ARTICLE VII

### DURATION AND TERMINATION

7.1. Duration. Except as otherwise provided herein, this Agreement shall be unlimited in duration.

7.2. Reinsurer's Liability. The Reinsurer's liability with respect to the Reinsured Risks will terminate on the earliest of: (i) the date the Company's liability with respect to the Reinsured Risks is terminated and all amounts due the Company from the Reinsurer with respect to such Reinsured Risks are paid to the Company by or on behalf of the Reinsurer; and (ii) the date this Agreement is terminated upon the written agreement of the parties.

7.3. Notice of Termination. Upon the termination of the Reinsurer's liability with respect to the Reinsured Risks referred to in Section 7.2 above, the parties shall mutually give the Trustee written notice of their intention to terminate the Trust Account.

## ARTICLE VIII

### INSOLVENCY

8.1. Payments. In the event of the insolvency of the Company, all reinsurance made, ceded, renewed or otherwise becoming effective under this Agreement shall be payable by the Reinsurer directly to the Company or to its liquidator, receiver, or statutory successor on the basis of the liability of the Company under the contracts reinsured, without diminution because of the insolvency of the Company. It is agreed and understood, however, that (i) in the event of the insolvency of the Company, the Reinsurer shall be given written notice of the pendency of a claim against the insolvent Company on a Reinsured Contract within a reasonable time after such claim is filed in the insolvency proceeding and (ii) during the pendency of such claim the Reinsurer may investigate such claim and interpose, at its own expense, in the proceeding where such claim is to be adjudicated any defenses which it may deem available to the Company or its liquidator, receiver or statutory successor.

8.2. Expenses. It is further understood that any expense thus incurred by the Reinsurer pursuant to Section 8.1 shall be chargeable, subject to court approval, against the insolvent Company as part of the expense of liquidation to the extent of a proportionate share of



the benefit which may accrue to the Company solely as a result of the defense undertaken by the Reinsurer. Where two or more assuming reinsurers are involved in the same claim and a majority in interest elect to interpose defenses to such claim, the expense shall be apportioned in accordance with the terms of this Agreement as though such expense had been incurred by the Company.

#### ARTICLE IX

##### CREDIT FOR REINSURANCE

9.1. Reinsurance Credit. Notwithstanding any other provision of this Agreement to the contrary, if the Reinsurer becomes unauthorized or otherwise unaccredited as an insurer or reinsurer in any U.S. jurisdiction to which the Company must provide statutory statements of financial condition such that the Company will not obtain full statutory financial statement credit for reinsurance in such state for the reinsurance provided under this Agreement, the Reinsurer, upon the request of the Company, will establish, at the Reinsurer's sole cost and option, any trust accounts for the benefit of the Company, letters of credit, or other acceptable alternatives necessary to permit the Company to obtain such full statutory financial statement credit for such reinsurance in all applicable jurisdictions. The Company shall cooperate with the Reinsurer to take such steps. In addition, in such event, the Reinsurer agrees to amend this Agreement and the Trust Agreement to the extent required under Applicable Law in order to provide the Company with such full statutory financial statement credit.

#### ARTICLE X

##### REINSURANCE SECURITY

10.1. Trust. (a) On the Closing Date, the Reinsurer shall enter into a trust agreement in the form attached as Schedule H (the "Trust Agreement") and establish a trust account (the "Trust Account") for the benefit of the Company with respect to the Reinsured Risks with a bank (the "Trustee") designated as a Qualified United States Financial Institution by the Securities Valuation Office of the National Association of Insurance Commissioners or any successor organization or regulatory agency having similar duties.

(b) The Reinsurer agrees to deposit, and maintain in the Trust Account with respect to this Agreement, assets to be held in trust by the Trustee for the benefit of the Company as security for the payment of the Reinsurer's obligations to the Company under this Agreement.

(c) The parties agree that the assets so deposited with respect to this Agreement shall be valued according to their current statutory book value on the books of the Reinsurer and shall consist only of cash (United States legal tender), certificates of deposit (issued by a United States bank and payable in United States legal tender), and other assets of the type specified on Schedule I attached hereto ("Eligible Securities").

(d) The Reinsurer, prior to depositing assets with the Trustee, shall execute all assignments and endorsements in blank, or transfer legal title to the Trustee of all shares,

16

---

obligations or any other assets requiring assignments, in order that, to the extent practicable, the Company, or the Trustee upon direction of the Company, may whenever necessary negotiate any such assets without consent or signature from the Reinsurer or any other entity. The Company recognizes that certain assets in the Trust Account will not be readily negotiable and that certain notices, opinions of counsel, representations and/or consents will be required for the Company to obtain good and marketable title to such assets.

(e) The Reinsurer and the Company agree that the assets in the Trust Account with respect to this Agreement may be withdrawn for the following purposes only:

- (i) to pay or reimburse the Company for any amount due the Company pursuant to this Agreement to the extent not so paid or reimbursed by the Reinsurer;
- (ii) to pay to the Reinsurer, in accordance with paragraph (h) below, any amounts held in the Trust Account that exceed an amount (the "Funding Requirement") equal to the sum of General Account Reserves and any additional reserves attributable to the Reinsured Risks that arise as a result of regulatory asset adequacy analysis requirements of the Reinsurer; and
- (iii) in the event that General Electric Capital Corporation breaches its obligations under the Capital Maintenance Agreement, to fund an account with the Company (the "Company Account") in an amount at least equal to the deduction, for reinsurance ceded, from the Company's liabilities ceded under this Agreement. Such amount shall include, but not be limited to, amounts for policy reserves, reserves for claims and losses incurred (including losses incurred but not reported), loss and loss adjustment expenses, and unearned premiums.

(f) In the event that the Company withdraws assets from the Trust Account for the purposes set forth in Section 10.1(e)(i) above in excess of actual amounts required to meet the Reinsurer's obligations to the Company, the Company will promptly return such excess to the Reinsurer plus interest at an annual rate equal to the then current thirty (30) day U.S. Treasury Bill discount rate on the date of withdrawal plus 200 basis points for the period during which the amounts were held pursuant to Section 10.1(e)(i). In the event that the Company withdraws assets from the Trust Account for the purposes set forth in Section 10.1(e)(iii) above, (i) the Reinsurer shall be relieved of its obligation to maintain assets in the Trust Account pursuant to this Section 10.1 to the extent of the amount of funds held in the Company Account and (ii) the Company shall first apply the funds in the Company Account in satisfaction of the Reinsurer's liability under this Agreement until the funds in the Company Account are exhausted. In the event that the Company withdraws assets from the Trust Account for the purposes set forth in Section 10.1(e)(iii) above, promptly following the date the Reinsurer's liability with respect to the Reinsured Risks is terminated, the Company shall return to the Reinsurer any assets so withdrawn that, together with any and all interest, dividends and other earnings thereon from the date of withdrawal to the date of return, are in excess of actual amounts required to meet the Reinsurer's obligations to the Company under this Agreement.

17

---

(g) The initial deposit to the Trust Account with respect to this Agreement shall be made on the Closing Date and shall consist of assets with a statutory book value equal to the General Account Reserves as of the close of business on the day immediately preceding the Inception Date.

(h) The aggregate statutory book value of the assets held in the Trust Account with respect to this Agreement, shall at all times be at least equal to the Funding Requirement, and shall be adjusted on a quarterly basis so as to equal the Funding Requirement. On a quarterly basis, the Company shall promptly prepare and deliver to the Reinsurer a specific statement of the Funding Requirement and the Reinsurer shall promptly prepare and deliver to the Company a specific statement of the

statutory book value of the assets in the Trust Account, in each case as of the end of the quarter. If the statement shows that the Funding Requirement exceeds 100% of the balance of the Trust Account with respect to this Agreement as of the statement date, the Reinsurer shall, within ten (10) Business Days after receipt of such notice of excess, secure delivery to the Trustee of additional cash or Eligible Securities having a current statutory book value equal to such difference. If the statement shows that the Funding Requirement is less than 100% of the balance of the Trust Account with respect to this Agreement as of the statement date, the Company shall, within ten (10) Business Days after delivery of such statement to the Reinsurer, deliver a notice of withdrawal to the Trustee directing the Trustee to withdraw from the Trust Account and deliver to the Reinsurer assets from the Trust Account having a current statutory book value equal to such excess amount. In addition to the foregoing, the Reinsurer shall prepare and deliver to the Company on a quarterly basis a specific statement of the market value of the assets in the Trust Account as of the end of the quarter.

## ARTICLE XI

### DEFERRED ACQUISITION COSTS

11.1. Tax DAC Information Sharing. To ensure consistency in their respective Tax DAC calculations for tax purposes, the Company and the Reinsurer will exchange information pertaining to the amount of net consideration under this Agreement each year. The Company will submit a schedule to the Reinsurer by February 28 of each year presenting its calculation of the net consideration for the preceding taxable year. The Reinsurer may contest the calculation by providing to the Company an alternative calculation in writing within thirty (30) days of receipt of the Company's schedule. The Company and the Reinsurer will act in good faith to resolve any differences in the schedule of calculations within thirty (30) days of receipt of the alternative calculation to ensure consistent amounts are reported on the respective tax returns for the preceding tax year.

18

---

## ARTICLE XII

### DISPUTE RESOLUTION

12.1. General Provisions. (a) Any dispute, controversy or claim arising out of or relating to this Agreement or the validity, interpretation, breach or termination thereof (a "Dispute"), shall be resolved in accordance with the procedures set forth in this Article XII, which shall be the sole and exclusive procedures for the resolution of any such Dispute unless otherwise specified below.

(b) Commencing with the request contemplated by Section 12.2, all communications between the parties or their representatives in connection with the attempted resolution of any Dispute, including any mediator's evaluation referred to in Section 12.3, shall be deemed to have been delivered in furtherance of a Dispute settlement and shall be exempt from discovery and production, and shall not be admissible in evidence for any reason (whether as an admission or otherwise), in any arbitral or other proceeding for the resolution of the Dispute.

(c) In connection with any Dispute, the parties expressly waive and forego any right to (i) punitive, exemplary, statutorily-enhanced or similar damages in excess of compensatory damages, and (ii) trial by jury.

(d) The specific procedures set forth below, including but not limited to the time limits referenced therein, may be modified by agreement of the parties in writing.

(e) All applicable statutes of limitations and defenses based upon the passage of time shall be tolled while the procedures specified in this Article XII are pending. The parties will take such action, if any, required to effectuate such tolling.

12.2. Consideration by Senior Executives. If a Dispute is not resolved in the normal course of business at the operational level, the parties shall attempt in good faith to resolve such Dispute by negotiation between executives who hold, at a minimum, the office of President and CEO of the respective business entities involved in such Dispute. Either party may initiate the executive negotiation process by providing a written notice to the other (the "Initial Notice"). Fifteen (15) days after delivery of the Initial Notice, the receiving party shall submit to the other a written response (the "Response"). The Initial Notice and the Response shall include (i) a statement of the Dispute and of each party's position, and (ii) the name and title of the executive who will represent that party and of any other person who will accompany the executive. Such executives will meet in person or by telephone within thirty (30) days of the date of the Initial Notice to seek a resolution of the Dispute.

12.3. Mediation. If a Dispute is not resolved by negotiation as provided in Section 12.2 within forty-five (45) days from the delivery of the Initial Notice, then either party may submit the Dispute for resolution by mediation pursuant to the CPR Institute for Dispute Resolution (the "CPR") Model Mediation Procedure as then in effect. The parties will select a mediator from the CPR Panels of Distinguished Neutrals, but such mediator must have prior U.S. reinsurance experience either as a lawyer or as a present or former officer or management

19

---

employee of a reinsurance company, but not of the Company, or the Reinsurer, or any of their respective affiliates. Either party at commencement of the mediation may ask the mediator to provide an evaluation of the Dispute and the parties' relative positions.

12.4. Arbitration. (a) If a Dispute is not resolved by mediation as provided in Section 12.3 within thirty (30) days of the selection of a mediator (unless the mediator chooses to withdraw sooner), either party may submit the Dispute to be finally resolved by arbitration pursuant to the CPR Rules for Non-Administered Arbitration as then in effect (the "CPR Arbitration Rules"). The parties consent to a single, consolidated arbitration for all known Disputes existing at the time of the arbitration and for which arbitration is permitted.

(b) The neutral organization for purposes of the CPR Arbitration Rules will be the CPR. The arbitral tribunal shall be composed of three arbitrators who are each experienced in the U.S. reinsurance business, of whom each party shall appoint one in accordance with the "screened" appointment procedure provided in Rule 5.4 of the CPR Arbitration Rules. The non-party appointed arbitrator must have prior U.S. reinsurance experience as a present or former officer or management employee of a reinsurance company, but not of the Company, or the Reinsurer, or any of their respective affiliates. The arbitration shall be conducted in New York City. Each party shall be permitted to present its case, witnesses and evidence, if any, in the presence of the other party. A written transcript of the proceedings shall be made and furnished to the parties. The arbitrators shall determine the Dispute in accordance with the law of New York, without giving effect to any conflict of law rules or other rules that might render such law inapplicable or unavailable, and shall apply this Agreement according to its terms, provided that the provisions relating to arbitration shall be governed by the Federal Arbitration Act, 9 U.S.C. §§ 1 et seq. The arbitral tribunal shall endeavor to render its award or order resulting from any arbitration within forty-five (45) days following the termination of the arbitration proceedings.

(c) The parties agree to be bound by any award or order resulting from any arbitration conducted hereunder and further agree that judgment on any award or order resulting from an arbitration conducted under this Section may be entered and enforced in any court having jurisdiction thereof.

(d) Except as expressly permitted by this Agreement, no party will commence or voluntarily participate in any court action or proceeding concerning a Dispute, except (i) for enforcement as contemplated by Section 12.4(c) above, (ii) to restrict or vacate an arbitral decision based on the grounds specified under Applicable Law, or (iii) for interim relief as provided in paragraph (e) below. For purposes of the foregoing the parties hereto submit to the non-exclusive jurisdiction of the courts of the State of New York.

(e) In addition to the authority otherwise conferred on the arbitral tribunal, the tribunal shall have the authority to make such orders for interim relief, including injunctive relief, as it may deem just and equitable. Notwithstanding paragraph (d) above, each party acknowledges that in the event of any actual or threatened breach of certain of the provisions of this Agreement, the remedy at law would not be adequate, and therefore injunctive or other interim relief may be sought immediately to restrain such breach. If the tribunal shall not have been appointed, either party may seek interim relief from a court having jurisdiction if the award to which the applicant may be entitled may be rendered ineffectual without such interim relief.

20

---

Upon appointment of the tribunal following any grant of interim relief by a court, the tribunal may affirm or disaffirm such relief, and the parties will seek modification or rescission of the court action as necessary to accord with the tribunal's decision.

(f) Each party will bear its own attorneys' fees and costs incurred in connection with the resolution of any Dispute in accordance with this Article XII.

### ARTICLE XIII

#### MISCELLANEOUS PROVISIONS

13.1. Headings and Schedules. Headings used herein are not a part of this Agreement and shall not affect the terms hereof. The attached Schedules are a part of this Agreement.

13.2. Notices. All notices, requests, demands and other communications under this Agreement must be in writing and will be deemed to have been duly given or made as follows: (a) if sent by registered or certified mail in the United States return receipt requested, upon receipt; (b) if sent by reputable overnight air courier, two business days after mailing; (c) if sent by facsimile transmission, with a copy mailed on the same day in the manner provided in (a) or (b) above, when transmitted and receipt is confirmed by telephone; or (d) if otherwise actually personally delivered, when delivered, and shall be delivered as follows:

If to the Company:

GE Capital Life Assurance Company of New York  
6610 West Broad Street  
Richmond, VA 23230  
Facsimile: (804) 281-6165  
Attention: Chief Executive Officer

With a copy to:

GE Capital Life Assurance Company of New York  
6610 West Broad Street  
Richmond, VA 23230  
Facsimile: (804) 281-6005  
Attention: General Counsel

If to the Reinsurer:

Union Fidelity Life Insurance Company  
200 North Martingale Road  
Schaumburg, IL 60173-2096  
Facsimile: (847) 330-3404  
Attention: Chief Financial Officer

21

---

With a copy to:

Union Fidelity Life Insurance Company  
200 North Martingale Road  
Schaumburg, IL 60173-2096  
Facsimile: (847) 605-3044  
Attention: General Counsel

or to such other address or to such other Person as either party may have last designated by notice to the other party.

13.3. Successors and Assigns. This Agreement shall be binding upon and inure to the benefit of the parties hereto and their respective successors, permitted assigns and legal representatives. Neither this Agreement, nor any right or obligation hereunder, may be assigned by any party without the prior written consent of the other party hereto. Any assignment in violation of this Section 13.3 shall be void and shall have no force and effect. Nothing in this Section 13.3 shall be construed to prohibit the Reinsurer from retroceding all or any portion of the business reinsured hereunder.

13.4. Execution in Counterpart. This Agreement may be executed by the parties hereto in any number of counterparts, and by each of the parties hereto in separate counterparts, each of which counterparts, when so executed and delivered, shall be deemed to be an original, but all such counterparts shall together constitute but one and the same instrument.

13.5. Currency. Whenever the word “Dollars” or the “\$” sign appear in this Agreement, they shall be construed to mean United States Dollars, and all transactions under this Agreement shall be in United States Dollars.

13.6. Amendments. This Agreement may not be changed, altered or modified unless the same shall be in writing executed by the Company and the Reinsurer.

13.7. Governing Law. This Agreement will be construed, performed and enforced in accordance with the laws of the State of New York without giving effect to its principles or rules of conflict of laws thereof to the extent such principles or rules would require or permit the application of the laws of another jurisdiction.

13.8. Entire Agreement; Severability. (a) This Agreement and the Termination Letter Agreement constitute the entire agreement between the parties hereto relating to the subject matter hereof and supersede all prior and contemporaneous agreements, understandings, statements, representations and warranties, negotiations and discussions, whether oral or written, of the parties and there are no general or specific warranties, representations or other agreements by or among the parties in connection with the entering into of this Agreement or the subject matter hereof except as specifically set forth or contemplated herein or in the Termination Letter Agreement.

(b) If any provision of this Agreement is held to be void or unenforceable, in whole or in part, (i) such holding shall not affect the validity and enforceability of the remainder of this Agreement, including any other provision, paragraph or subparagraph, and (ii) the parties

22

---

agree to attempt in good faith to reform such void or unenforceable provision to the extent necessary to render such provision enforceable and to carry out its original intent.

13.9. Contemporaneous Agreements. Concurrent with the execution of this Agreement, the parties and/or their Affiliates are also entering into the Capital Maintenance Agreement, the RBC Reporting Letter Agreement and the Assignment Letter Agreement.

13.10. No Waiver; Preservation of Remedies. No consent or waiver, express or implied, by any party to or of any breach or default by any other party in the performance by such other party of its obligations hereunder shall be deemed or construed to be a consent or waiver to or of any other breach or default in the performance of obligations hereunder by such other party hereunder. Failure on the part of any party to complain of any act or failure to act of any other party or to declare any other party in default, irrespective of how long such failure continues, shall not constitute a waiver by such first party of any of its rights hereunder. The rights and remedies provided are cumulative and are not exclusive of any rights or remedies that any party may otherwise have at law or equity.

13.11. Cooperation. Each party hereto shall cooperate fully with the other in all reasonable respects in order to accomplish the objectives of this Agreement including making available to each their respective officers and employees for interviews and meetings with Governmental Authorities and furnishing any additional assistance, information and documents as may be reasonably requested by a party from time to time.

13.12. Third Party Beneficiary. Nothing in this Agreement will confer any rights upon any Person that is not a party or a successor or permitted assignee of a party to this Agreement.

13.13. Tax Exception to Any Confidentiality. Notwithstanding anything to the contrary set forth herein or in any other agreement to which the parties hereto are parties or by which they are bound, any obligations of confidentiality contained herein and therein, as they relate to the transactions, shall not apply to the federal tax structure or federal tax treatment of the transactions, and each party hereto (and any employee, representative, or agent of any party hereto) may disclose to any and all persons, without limitation of any kind, the federal tax structure and federal tax treatment of the transactions. The preceding sentence is intended to cause the transactions to be treated as not having been offered under conditions of confidentiality for purposes of Section 1.6011-4(b)(3) (or any successor provision) of the Treasury Regulations promulgated under Section 6011 of the Internal Revenue Code of 1986, as amended, and shall be construed in a manner consistent with such purpose. In addition, each party hereto acknowledges that it has no proprietary or exclusive rights to the federal tax structure of the transactions or any federal tax matter or federal tax idea related to the transactions.

13.14. Interpretation. Wherever the words “include,” “includes” or “including” are used in this Agreement, they shall be deemed to be followed by the words “without limitation.”

13.15. Survival. Article XII and Article XIII shall survive the termination of this Agreement.

23

---

IN WITNESS WHEREOF, the parties hereto have caused this Agreement to be executed by their duly authorized representatives.

GE CAPITAL LIFE ASSURANCE COMPANY  
OF NEW YORK

By /s/ VICTOR C. MOSES  
Name: Victor C. Moses  
Title: Senior Vice President

UNION FIDELITY LIFE INSURANCE COMPANY

By /s/ GLENN JOPPA  
Name: Glenn Joppa  
Title: Senior Vice President and Secretary

---

SCHEDULE A

POLICY FORMS

NY1066	CVA NY
NY1155	Choice NY
NY5237	— Annual Step Up Rider
NY5197	— Death Benefit Rider
NY5141	— Tax Rider
NY5066	— Trust Endorsement
NY 5068	— Joint Annuitant
NY5241	— Annuity Commencement Date
NY5071	— Annual Step Death Benefit
NY5136	— Bonus Ride
NY5236	— Death Benefit Endorsement
NY1157	Selections NY
NY5237	— Annual Step Up Rider
NY5197	— Death Benefit Rider
NY5141	— Tax Rider

SCHEDULE B

SEPARATE ACCOUNTS

GE Capital Life Separate Account II

SCHEDULE C

FORM OF ADMINISTRATIVE SERVICES AGREEMENT

VA UFLIC/GECLANY

ADMINISTRATIVE SERVICES AGREEMENT

by and between

GE CAPITAL LIFE ASSURANCE COMPANY OF NEW YORK

and

UNION FIDELITY LIFE INSURANCE COMPANY

Effective as of [       ]

ADMINISTRATIVE SERVICES AGREEMENT

This ADMINISTRATIVE SERVICES AGREEMENT (this “Agreement”), effective as of [       ] (the “Effective Date”), is entered into by and between GE CAPITAL LIFE ASSURANCE COMPANY OF NEW YORK, an insurance company organized under the laws of the State of New York (the “Company”), and UNION FIDELITY LIFE INSURANCE COMPANY, an insurance company organized under the laws of the State of Illinois (the “Administrator”).

RECITALS:

WHEREAS, the Company and the Administrator have entered into a Reinsurance Agreement dated as of April 15, 2004 (the "Reinsurance Agreement") which provides for the parties to enter into this Agreement;

WHEREAS, pursuant to the Reinsurance Agreement, the Administrator has agreed to indemnify the Company for, among other things, (i) on a coinsurance basis, 100% of the General Account Liabilities and (ii) on a modified coinsurance basis, 100% of the Separate Account Liabilities, in each case, payable by the Company under the Reinsured Contracts (capitalized terms used herein and not defined herein, unless otherwise indicated, have the respective meanings assigned to them in the Reinsurance Agreement); and

WHEREAS, the Company wishes to appoint the Administrator to provide contractholder and claim servicing with respect to the Reinsured Contracts as set forth herein, and the Separate Accounts, and the Administrator desires to provide such administrative services;

NOW, THEREFORE, in consideration of the covenants and agreements set forth herein, the parties hereto agree as follows:

## ARTICLE I

### AUTHORITY

As between the Company and the Administrator, the Company hereby appoints the Administrator, and the Administrator hereby accepts appointment, to provide as an independent contractor of the Company, from and after the Effective Date, all of the contractholder and claim servicing services necessary or appropriate with respect to the Reinsured Contracts and the Separate Accounts, including those set forth in this Agreement and on Schedule A hereto (the "Administrative Services"), all on the terms as set forth in this Agreement. In providing the contractholder and claim servicing with respect to the Reinsured Contracts, the Administrator shall handle all such matters, including but not limited to the billing and collection of premiums and the defense, adjustment, settlement and payment of all contractholder claims arising under the Reinsured Contracts, as more fully described below. Notwithstanding any other provision of this Agreement to the contrary, the Company shall have the final right to direct the Administrator in the performance of the Administrative Services in accordance with the standards for services set forth in Section 2.1, including the right to direct the Administrator to perform any action

---

necessary for the Reinsured Contracts or the contractholder and claim servicing thereof to comply with Applicable Law, or to cease performing any action that constitutes a violation of Applicable Law. All services hereunder shall be performed by the Administrator in the name of and on behalf of the Company. The Administrator shall maintain a toll-free number for use by policyholders, certificateholders and beneficiaries. Any and all correspondence with policyholders, certificateholders and beneficiaries and check stock utilized by the Administrator for payments under the Reinsured Contracts shall be in the name of the Company or in the name of the Administrator and disclosing that the Administrator is acting as the administrative agent of the Company.

## ARTICLE II

### STANDARD FOR SERVICES; FACILITIES; SUBCONTRACTING; POLICYHOLDER SERVICING

2.1. Standard for Services. The Administrator shall provide the contractholder and claims servicing with respect to the Reinsured Contracts and the Separate Accounts in good faith and with the care, skill, prudence and diligence of a person experienced in administering variable annuity business. Without limiting the generality of the foregoing, the Administrator shall provide contractholder and claims servicing with respect to the Reinsured Contracts and the Separate Accounts (i) in accordance with the terms of the Reinsured Contracts, (ii) in accordance with the applicable terms of this Agreement, (iii) in compliance with Applicable Law, (iv) in accordance with industry standards, (v) in accordance with standards of service as agreed to by the Administrator and the Company and, subject to the foregoing, (vi) to the extent applicable, in the same manner as it conducts its own business not subject to this Agreement.

2.2. Facilities and Personnel. To the extent not sub-contracted to a Subcontractor, the Administrator shall at all times maintain sufficient facilities and trained personnel of the kind necessary to perform its obligations under this Agreement in accordance with the performance standards set forth herein.

2.3. Subcontracting. The Administrator may subcontract for the performance of any contractholder or claims servicing service or services with respect to the Reinsured Contracts or any services the Administrator is to provide in the administration of the Separate Accounts to (i) an Affiliate or (ii) any other Person with the prior written consent of the Company, such consent not to be unreasonably withheld (in each case, the "Subcontractor"); provided, that, no such subcontracting shall relieve the Administrator from any of its obligations or liabilities hereunder, and the Administrator shall remain responsible for all obligations or liabilities of such Subcontractor with regards to the providing of such service or services as if provided by the Administrator.

2.4. Policyholder Servicing. The Administrator shall provide policyholder servicing with regards to the Reinsured Contracts, including changes of address, responding to policyholder inquiries and similar services.

---

## ARTICLE III

### CLAIMS HANDLING

The Administrative Services with respect to claims for benefits including claims outstanding on the Effective Date, shall include the following:

3.1. Claim Administration Services. The Administrator shall acknowledge, consider, review, investigate, deny, settle, pay or otherwise dispose of each claim for benefits and disbursements reported under each Reinsured Contract (each, a "Claim" and collectively the "Claims") in accordance with procedures and guidelines established by the Company, such procedures and guidelines to be in accordance with the standards of service set forth in Section 2.1.

3.2. Description of Claim Administration Services. Without limiting the foregoing, the Administrator shall:

- (i) provide claimants under the Reinsured Contract and their authorized representatives (collectively, "Claimants") with Claim forms and provide reasonable explanatory guidance to Claimants in connection therewith;

- (ii) establish, maintain and organize Claim files and maintain and organize other Claims-related records;
- (iii) review all Claims and determine whether the Claimant is eligible for benefits and if so, the nature and extent of such benefits;
- (iv) prepare and distribute to the appropriate recipients any reports required by Applicable Law;
- (v) respond to all written or oral Claims-related communications that the Administrator reasonably believes to require a response; and
- (vi) maintain a complaint log with respect to the Reinsured Contracts in accordance with applicable requirements of Governmental Authorities and provide a copy of such log, continuously updated through the last day of each calendar quarter during the term of this Agreement, to the Company on or before the tenth Business Day of each calendar quarter covering changes during the preceding calendar quarter.

#### ARTICLE IV

##### REGULATORY AND LEGAL PROCEEDINGS

4.1. Regulatory Complaints and Proceedings. The Administrator shall:

3

---

- (i) to the extent permitted by Applicable Law, respond to any Claims payment related complaints or inquiries made by any Governmental Authority within the Governmental Authority's requested time frame for response or, if no such time frame is provided, within the time frame as allowed by Applicable Law; and promptly provide a copy of such response to the Company;
- (ii) promptly notify the Company of any non-Claims payment related complaints or inquiries initiated by a Governmental Authority, and of any proceedings (either Claims or non-Claims related) initiated by a Governmental Authority, and, in either case, to the extent permitted by Applicable Law, prepare and send to the Governmental Authority, with a copy to the Company, a response within the Governmental Authority's requested time frame for response or, if no such time frame is provided, within the time frame as allowed by Applicable Law; provided, that, subject to meeting such time frames, the Administrator shall provide such response to the Company for its prior review and comment;
- (iii) subject to Section 4.4, supervise and control the investigation, contest, defense and/or settlement of all complaints, inquiries and proceedings by Governmental Authorities, at its own cost and expense, and in the name of the Company when necessary; and
- (iv) at the Company's request, provide to the Company a report in a form mutually agreed by the parties summarizing the nature of any complaints, inquiries or proceedings by Governmental Authorities, the alleged actions or omissions giving rise to such complaints, inquiries or proceedings and copies of any files or other documents that the Company may reasonably request in connection with its review of these matters.

Notwithstanding the foregoing, the Company shall retain final authority for the resolution of inquiries by Governmental Authorities and consumer complaints; provided, however, the Company agrees to act reasonably in the exercise of such authority.

4.2. Legal Proceedings. The Administrator shall:

- (i) notify the Company promptly of any lawsuit, action, arbitration or other dispute resolution proceedings that are instituted or threatened with respect to any matter relating to the Reinsured Contracts ("Legal Proceeding(s)"), and in no event more than five (5) Business Days after receipt of notice thereof;
- (ii) subject to Section 4.4, supervise and control the investigation, contest, defense and/or settlement of all Legal Proceedings at its own cost and expense, and in the name of the Company when necessary; and

4

---

- (iii) keep the Company fully informed of the progress of all Legal Proceedings handled by the Administrator in which the Company is named a party and, at the Company's request, provide to the Company a report summarizing the nature of such Legal Proceedings, the alleged actions or omissions giving rise to any Legal Proceedings and copies of any files or other documents that the Company may reasonably request in connection with its review of these matters in each case other than such files, documents and other information as would, in the judgment of counsel to the Administrator, lead to the loss or waiver of legal privilege.

4.3. Notice to Administrator. The Company shall give prompt notice to the Administrator of any Legal Proceeding made or brought against the Company after the Inception Date arising under or in connection with the Reinsured Contracts to the extent known to it and not made against or served on the Administrator or a Subcontractor as administrator hereunder, and in no event more than five (5) Business Days after receipt of notice thereof, and shall promptly furnish to the Administrator copies of all pleadings in connection therewith. The Administrator shall assume the defense of the Company.

4.4. Defense of Regulatory and Legal Proceedings. Notwithstanding anything in this Agreement to the contrary, the Company shall supervise and control the investigation, contest, defense and/or settlement of all complaints, inquiries and proceedings by Governmental Authorities to the extent required by Applicable Law. In addition, the Company shall have the right to engage in its own separate legal representation, at its own expense, and to otherwise participate fully in the defense of any Legal Proceedings or complaints, inquiries or proceedings by Governmental Authorities with respect to the Reinsured Contracts in which the Company is a named party, without the Company waiving any right to indemnification it may have under Article XVII hereof. The Administrator and the Company shall cooperate with each other with respect to the administration of any Legal Proceeding and any complaint, inquiry or proceeding by Governmental Authorities. The Administrator shall not settle any Legal Proceeding or any complaint, inquiry or proceeding by Governmental Authorities without the Company's prior written consent (which consent shall not be unreasonably withheld or delayed) unless (i) there is no finding or admission of any violation of law or any violation of the rights of any Person, (ii) such settlement would not reasonably be expected to have material adverse precedential consequences to the Company and (iii) the sole relief provided is monetary damages that are paid in full by the Administrator.

#### ARTICLE V

##### NOTIFICATION TO CONTRACTHOLDERS



The Administrator agrees to send to contractholders of the Reinsured Contracts a written notice prepared by the Administrator, reasonably acceptable to the Company and approved by the New York Insurance Department to the effect that the Administrator, or such other Person designated by the Administrator in accordance with the terms of this Agreement, has been appointed by the Company to provide Administrative Services. The Administrator shall send such notice by first class U.S. mail at a time reasonably acceptable to the Company and the

Administrator and in all events in accordance with Applicable Law. The parties intend to minimize the cost associated with any notification under this Article V, including by means of inclusion of the notice in a regularly scheduled mailing to contractholders in lieu of a separate mailing. The cost associated with such notification under this Article V (upon the initial assumption of the administration of the Reinsured Contracts under Section 3.10 of the Reinsurance Agreement) shall be a transition cost payable by the Administrator or the Company in accordance with Section 3.10(a) or 3.10(c) of the Reinsurance Agreement, as applicable.

#### ARTICLE VI

##### BILLINGS AND COLLECTIONS

6.1. Billing and Collection Services. The Administrator shall assume all responsibility for billing and collecting premiums and other amounts payable with respect to the Reinsured Contracts, including Separate Account Charges, from and after the Effective Date. The Company shall promptly remit to the Administrator any such amounts received by it with respect to the Reinsured Contracts.

#### ARTICLE VII

##### QUARTERLY PREMIUM TAX AND INSOLVENCY FUND ACCOUNTINGS

7.1. Quarterly Accountings. Within thirty (30) days after the end of each calendar quarter that this Agreement is in effect (or more frequently as mutually agreed by the parties), the Company shall submit to the Administrator a written statement of accounting in a form and containing such information to be agreed upon by the parties hereto (each, an "Insolvency Fund Quarterly Accounting") setting forth the Insolvency Fund amounts assessed or payable to the extent that such assessments constitute Reinsured Risks with respect to the Reinsured Contracts (collectively, the "Post-Effective Date Assessments"). Within thirty (30) days after the last day of each calendar quarter that this Agreement is in effect (or more frequently as mutually agreed by the parties), the Administrator shall submit to the Company a written statement of accounting in a form and containing such information to be agreed upon by the parties hereto (each, a "Quarterly Premium Tax Accounting", and together with the Insolvency Fund Quarterly Accountings, the "Quarterly Accountings") setting forth the estimated premium taxes due with respect to the Reinsured Contracts as a result of premiums collected during such quarter. Concurrent with the delivery of each Quarterly Premium Tax Accounting, the Administrator shall remit to the Company the amount set forth on such Quarterly Premium Tax Accounting with respect to such estimated premium taxes due and the amount set forth in such Insolvency Fund Quarterly Accounting with respect to the Post-Effective Date Assessments, and any other amounts owed to the Company pursuant to this Agreement; provided, however, that any Post-Effective Date Assessments set forth in an Insolvency Fund Quarterly Accounting received by the Administrator less than five (5) Business Days prior to the Administrator's delivery of such Quarterly Premium Tax Accounting will be paid within ten (10) Business Days of receipt by the Administrator of such Insolvency Fund

Quarterly Accounting. Each of the parties agrees to supply to the other a copy of all supporting data used in preparing the Quarterly Accountings prepared by such party.

7.2. Adjustments Regarding Quarterly Accountings. In the event that subsequent data or calculations require revision of any of the Quarterly Accountings, the required revision and appropriate payments thereunder shall be made within ten (10) Business Days after the parties hereto mutually agree as to the appropriate revision.

#### ARTICLE VIII

##### CERTAIN ACTIONS BY COMPANY

8.1. Filings. The Company shall prepare and timely file any filings required to be made with any Governmental Authority that relate to the Company generally and not just to the Reinsured Contracts, including filings with guaranty associations and filings and premium tax returns with taxing authorities. The Administrator shall, in a timely fashion in light of the dates such filings by the Company are required, provide to the Company all information in the possession of the Administrator with respect to the Reinsured Contracts that may be reasonably required for the Company to prepare such filings and tax returns. In order to enable the Administrator to perform the requirements as set forth in Item 6(c) of Schedule A hereto attached, the Company shall make available to the Administrator drafts of such documents sufficiently in advance of the proposed filings thereof.

8.2. Annual Adjustment. The Company shall pay or provide to the Administrator the benefit of any Post-Effective Date Assessments which have been or can be applied to reduce the Company's premium tax liability ("Premium Tax Credits"). The Company shall provide to the Administrator by March 15 of each year a statement of the amount (the "Annual Adjustment") of (i) premium taxes due with respect to premiums collected during the prior calendar year (to the extent that such premium taxes constitute Reinsured Risks with respect to the Reinsured Contracts), less (ii) estimated premium taxes paid by the Administrator to the Company with respect to such premiums under the provisions of Article VII, less (iii) Premium Tax Credits for the prior calendar year. By March 30 of each year the Administrator shall pay to the Company the Annual Adjustment, if a positive amount, and the Company will pay or credit to the Administrator the Annual Adjustment, if a negative amount.

#### ARTICLE IX

##### REGULATORY MATTERS AND AUDIT REPORTING

9.1. Regulatory Compliance and Reporting. The Administrator shall provide to the Company such information with respect to the Reinsured Contracts as is required to satisfy all current and future informational reporting, prior approval and any other requirements imposed by any Governmental Authority. Upon the reasonable request of the Company, the Administrator shall timely prepare such reports and summaries, including statistical summaries and certifications, as are necessary

---

addition, the Administrator, upon the reasonable request of the Company, shall promptly provide to the Company copies of all existing records relating to the Reinsured Contracts (including, with respect to records maintained in machine readable form, hard copies) that are necessary to satisfy such requirements. All copies of records furnished in the ordinary course of business shall be furnished by the Administrator at the Administrator's cost. Any extraordinary costs reasonably incurred by the Administrator in response to requests from the Company shall be reimbursed by the Company. Among other responsibilities:

- (i) The Administrator shall promptly prepare and furnish to Governmental Authorities all reports and related summaries (including, without limitation, statistical summaries), certificates of compliance and other reports required or requested by a Governmental Authority.
- (ii) The Administrator shall assist the Company and cooperate with the Company in doing all things necessary, proper or advisable, in the most expeditious manner practicable in connection with any and all market conduct or other Governmental Authority examinations relating to the Reinsured Contracts.

9.2. Reporting and Accountings. The Administrator shall assume the reporting and accounting obligations set forth below:

- (i) As soon as practicable but not more than thirty (30) days after the end of each Monthly Accounting Period (or more frequently as mutually agreed by the parties), the Administrator shall timely provide to the Company the Monthly Settlement Reports. As soon as practicable but not more than forty (40) days after the end of each Quarterly Accounting Period that this Agreement is in effect (or more frequently as mutually agreed by the parties), the Administrator shall timely provide to the Company the Quarterly Settlement Reports. As soon as practicable but not more than forty-five (45) days after the end of each calendar year that this Agreement is in effect, the Administrator shall timely provide to the Company the Annual Reports. In addition, as soon as practicable but not more than forty (40) days after the end of each calendar quarter that this Agreement is in effect (or more frequently as mutually agreed by the parties), the Administrator shall timely provide to the Company such other reports and summaries of transactions (and, upon request of the Company, detailed supporting records) related to the Reinsured Contracts as may be reasonably required for use in connection with the preparation of the Company's statutory and GAAP financial statements, tax returns and other required financial reports and to comply with the requirements of the regulatory authorities having jurisdiction over the Company, including all premiums received and all benefits paid. The parties shall cooperate in good faith to establish the manner for the providing of such reports.
- (ii) The Administrator shall provide to the Company such reports or summaries (and, upon the request of the Company, detailed supporting

---

records therefor) related to the payment of commissions under the Reinsured Contracts as agreed by the parties.

- (iii) As soon as practicable but not more than forty (40) days after the end of each calendar quarter that this Agreement is in effect (or more frequently as mutually agreed by the parties), the Administrator shall report to the Company the amount of statutory reserves that the Company is required to maintain in connection with the Reinsured Risks with respect to the Reinsured Contracts as of the quarter end.
- (iv) The Administrator shall promptly provide notice to the Company of any changes in the reserve methodology used by the Administrator in calculating statutory reserves for the Reinsured Contracts.
- (v) Within forty-five (45) days after each calendar year end (or such longer time as may be agreed by the parties) that this Agreement is in effect, the Administrator shall provide to the Company (a) an opinion of an actuary reasonably acceptable to the Company as to the adequacy of statutory reserves for the Reinsured Contracts, prepared according to accepted actuarial standards of practice, and as otherwise required for regulatory reporting purposes and (b) an analysis which reasonably supports such opinion.

9.3. Additional Reports and Updates. For so long as this Agreement remains in effect, each party shall periodically furnish to the other such other reports and information as may be reasonably required by such other party for regulatory, tax or similar purposes and reasonably available to it.

#### ARTICLE X

##### MISCELLANEOUS ADMINISTRATIVE SERVICES

The Administrator shall assume the obligations set forth below:

- (i) The Administrator shall timely pay to the contractholders, including any certificateholder thereunder, any refunds of any kind due under the Reinsured Contracts.
- (ii) The Administrator shall have the exclusive authority to manage and administer the Ceded Reinsurance Agreements, including providing all reports and notices required with regard to the Ceded Reinsurance Agreements to the reinsurers within the time required by the applicable reinsurance agreement and doing all other things necessary to comply with the terms and conditions of the Ceded Reinsurance Agreements. Without limiting the foregoing, the Administrator shall timely pay all reinsurance premiums due to reinsurers under the Ceded Reinsurance Agreements and shall use commercially reasonable efforts to collect from such reinsurers

---

all reinsurance recoverables due thereunder. The Administrator shall forward to the Company upon receipt any such reinsurance recoverables collected by the Administrator that are not the property of Administrator under the terms of the Reinsurance Agreement.

- (iii) The Administrator shall process all policy changes, lapses, cancellations, and reinstatements in accordance with the terms of this Agreement and the express terms of the Reinsured Contracts and shall assume responsibility for providing all other contractholder servicing in connection with the

Reinsured Contracts.

- (iv) The Administrator shall pay commissions due under the Reinsured Contracts.
- (v) The Administrator shall provide such Administrative Services as are not performed by or on behalf of Company on the date hereof but the need for which may arise due to changes or developments in Applicable Law.

ARTICLE XI

SEPARATE ACCOUNT ADMINISTRATIVE SERVICES

Without limiting the generality of any of the foregoing, in addition to the Administrative Services described in any Article of this Agreement, the contractholder and claim services with respect to, or as a result of, the Separate Accounts shall include those services set forth on Schedule A hereto.

ARTICLE XII

BOOKS AND RECORDS

The Administrator shall keep accurate and complete records, files and accounts of all transactions and matters with respect to the Reinsured Contracts and the administration thereof in accordance with Applicable Law, including New York Regulation 152, and its record management practices in effect from time to time for the Administrator's insurance business not covered by this Agreement, if any. All such records pertaining to the Reinsured Contracts shall be the property of the Company, provided that the Administrator shall at all times have the right to retain a copy of such books and records. The parties to this Agreement and their designated representatives may upon reasonable notice inspect, at the offices of the Administrator or the Company where such records are located, the papers and any and all other books or documents of the Administrator or the Company reasonably relating to this Agreement, including the Reinsured Contracts, and shall have access to appropriate employees and representatives of the other party, in each case during normal business hours for such period as this Agreement is in effect or for as long thereafter as any rights or obligations of any party survives or the Administrator or the Company reasonably need access to such records for regulatory, tax or

10

---

similar purposes. The information obtained shall be used only for purposes relating to the transactions contemplated under this Agreement.

ARTICLE XIII

COOPERATION

Each party hereto shall cooperate fully with the other in all reasonable respects in order to accomplish the objectives of this Agreement including making available to each their respective officers and employees for interviews and meetings with Governmental Authorities and furnishing any additional assistance, information and documents as may be reasonably requested by a party from time to time.

ARTICLE XIV

PRIVACY REQUIREMENTS

In providing the Administrative Services provided for under this Agreement, and in connection with maintaining, administering, handling and transferring the data of the contractholders and other recipients of benefits under the Reinsured Contracts, the Administrator shall, and shall cause its Affiliates and any permitted Subcontractors to, comply with all confidentiality and security obligations applicable to them in connection with the collection, use, disclosure, maintenance and transmission of personal, private, health or financial information about individual contractholders or benefit recipients, including the provisions of privacy policies under which such information was gathered, those laws currently in place and which may become effective during the term of this Agreement, including the Gramm-Leach-Bliley Act, the Health Insurance Portability and Accountability Act of 1996 and any other Applicable Laws. The Administrator shall entitle the Company and its agents and representatives, the Commissioner of Health and Human Services and such other Governmental Authorities, to the extent required by Applicable Law, to audit the Administrator's compliance herewith. The Administrator shall also enable individual subjects of personally identifiable information, upon request from such individuals, to review and correct information maintained by the Administrator about them, and to restrict use of such information. The Administrator shall promptly report to the Company any violation of this provision of which the Administrator becomes aware. Unless required by Applicable Law, the Administrator shall not during the term of this Agreement, modify the privacy policies under which information utilized by the Administrator in administering the Reinsured Contracts is gathered, without the Company's prior written consent, which consent shall not be unreasonably withheld. The parties agree to comply with the terms of the Business Associate Addendum attached hereto, if applicable, or such other written agreement as may be required by Applicable Law on the date hereof.

11

---

ARTICLE XV

CONSIDERATION FOR ADMINISTRATIVE SERVICES

Apart from the performance by the Company of its obligations under the Reinsurance Agreement, there shall be no fee or other consideration due to the Administrator for performance of the Administrative Services under this Agreement.

ARTICLE XVI

BANK ACCOUNT: USE OF COMPANY LETTERHEAD

When and on terms reasonably requested by the Administrator, the Company shall open, modify or close, and make available for use by the Administrator for the payment of amounts to be paid by the Administrator hereunder one or more bank accounts of the Company and check stock of the Company. The Administrator shall maintain such account(s) and pay all applicable bank fees and check stock costs. The Company shall adopt such resolutions and execute such documents as required to designate senior officers of the Administrator (by title) as signatories on such account(s) and authorize the Administrator to certify to such bank(s), from time to time, the names of such officers. The Company shall also make available to the Administrator, at the sole expense of the Administrator, such letterhead, printed forms and other documents of the Company as may be reasonably required by the Administrator in performing services hereunder. Upon termination of this Agreement, the Administrator shall promptly return to the Company all such unused check stock, letterhead, printed forms and other documents held by it in connection with this Agreement as provided under this Article XVI.

## ARTICLE XVII

### INDEMNIFICATION

Any claim for or with respect to indemnification arising out of, or relating to, this Agreement or the Administrative Services hereunder shall be permitted under and governed by the provisions of Article V of the Master Agreement, dated as of [ ], 2004, among General Electric Company, General Electric Capital Corporation, GEL, Inc., GE Financial Assurance Holdings, Inc. and Genworth Financial, Inc (the "Master Agreement"), to the extent such provisions are applicable, as if this Agreement were a Transaction Document under the Master Agreement.

## ARTICLE XVIII

### DURATION: TERMINATION

18.1. Duration. This Agreement shall commence on the Effective Date and continue with respect to each Reinsured Contract until no further Administrative Services in

12

---

respect of such Reinsured Contract is required, unless this Agreement is earlier terminated under Section 18.2.

18.2. Termination. (a) This Agreement is subject to immediate termination at the option of the Company, upon written notice to the Administrator, on the occurrence of any of the following events:

- (i) A voluntary or involuntary proceeding is commenced in any jurisdiction by or against the Administrator for the purpose of conserving, rehabilitating or liquidating the Administrator;
- (ii) There is a material breach by the Administrator of any material term or condition of this Agreement that is not cured by the Administrator within thirty (30) days after receipt of written notice from the Company of such breach or act (provided that the Company shall not have the right to terminate this Agreement (A) for so long as the Administrator is making a good faith effort to cure such breach, not to exceed an additional one hundred eighty (180) days or (B) during the pendency of any dispute resolution proceedings as set forth in Article XIX regarding an alleged material breach); or
- (iii) The Administrator is unable to perform the services required under this Agreement for a period of thirty (30) consecutive days for any reason other than as a result of a Force Majeure, it being understood that nothing in this 18.2(a)(iii) shall relieve the Administrator from its administrative responsibilities under this Agreement. For purposes of this Agreement, "Force Majeure" means any acts or omissions of any civil or military authority, acts of God, acts or omissions of the Company, fires, strikes or other labor disturbances, equipment failures, fluctuations or non-availability of electrical power, heat, light, air conditioning or telecommunications equipment, or any other act, omission or occurrence beyond the Administrator's reasonable control, irrespective of whether similar to the foregoing enumerated acts, omissions or occurrences.

(b) This Agreement may be terminated at any time upon the mutual written consent of the parties hereto, which writing shall state the effective date of termination.

(c) In the event that this Agreement is terminated under any of the provisions of 18.2(a), the Administrator shall select a third-party administrator to perform the services required by this Agreement. The Company shall have the right to approve any such administrator selected by the Administrator, but such approval will not unreasonably be withheld or delayed. If the Administrator fails to select an administrator pursuant to this 18.2(c), the Company shall select such an administrator. In either case, the Administrator shall pay all fees and charges imposed by the selected administrator and shall bear all transition costs associated with the transition of the performance of the services required under this Agreement to such administrator, including the expense of sending contractholder notices as provided in Article V.

13

---

## ARTICLE XIX

### DISPUTE RESOLUTION

19.1. General Provisions. (a) Any dispute, controversy or claim arising out of or relating to this Agreement or the validity, interpretation, breach or termination thereof (a "Dispute"), shall be resolved in accordance with the procedures set forth in this Article XIX, which shall be the sole and exclusive procedures for the resolution of any such Dispute unless otherwise specified below.

(b) Commencing with the request contemplated by 19.2, all communications between the parties or their representatives in connection with the attempted resolution of any Dispute, including any mediator's evaluation referred to in 19.3, shall be deemed to have been delivered in furtherance of a Dispute settlement and shall be exempt from discovery and production, and shall not be admissible in evidence for any reason (whether as an admission or otherwise), in any arbitral or other proceeding for the resolution of the Dispute.

(c) In connection with any Dispute, the parties expressly waive and forego any right to (i) punitive, exemplary, statutorily-enhanced or similar damages in excess of compensatory damages (provided that any such liability with respect to a Third Party claim (as defined in the Master Agreement) shall be considered direct damages), and (ii) trial by jury.

(d) The specific procedures set forth below, including but not limited to the time limits referenced therein, may be modified by agreement of the parties in writing.

(e) All applicable statutes of limitations and defenses based upon the passage of time shall be tolled while the procedures specified in this Article XIX are pending. The parties will take such action, if any, required to effectuate such tolling.

19.2. Consideration by Senior Executives. If a Dispute is not resolved in the normal course of business at the operational level, the parties shall attempt in good faith to resolve such Dispute by negotiation between executives who hold, at a minimum, the office of President and CEO of the respective business entities involved in such Dispute. Either party may initiate the executive negotiation process by providing a written notice to the other (the "Initial Notice"). Fifteen (15) days after delivery of the Initial Notice, the receiving party shall submit to the other a written response (the "Response"). The Initial Notice and the Response shall include (i) a statement of the Dispute and of each party's position, and (ii) the name and title of the executive who will represent that party and of any other person who will accompany the executive. Such executives will meet in person or by telephone within thirty (30) days of the date of the Initial Notice to seek a resolution of the Dispute.

19.3. Mediation. If a Dispute is not resolved by negotiation as provided in Section 19.2 within forty-five (45) days from the delivery of the Initial Notice, then either party may submit the Dispute for resolution by mediation pursuant to the CPR Institute for Dispute Resolution (the "CPR") Model Mediation Procedure as then in effect. The parties will select a mediator from the CPR Panels of Distinguished Neutrals, but such mediator must have prior U.S. reinsurance experience either as a lawyer or as a present or former officer or management

14

---

employee of a reinsurance company, but not of the Company, or the Administrator, or any of their respective affiliates. Either party at commencement of the mediation may ask the mediator to provide an evaluation of the Dispute and the parties' relative positions.

19.4. Arbitration. (a) If a Dispute is not resolved by mediation as provided in 19.3 within thirty (30) days of the selection of a mediator (unless the mediator chooses to withdraw sooner), either party may submit the Dispute to be finally resolved by arbitration pursuant to the CPR Rules for Non-Administered Arbitration as then in effect (the "CPR Arbitration Rules"). The parties consent to a single, consolidated arbitration for all known Disputes existing at the time of the arbitration and for which arbitration is permitted.

(b) The neutral organization for purposes of the CPR Arbitration Rules will be the CPR. The arbitral tribunal shall be composed of three arbitrators who are each experienced in the U.S. reinsurance business, of whom each party shall appoint one in accordance with the "screened" appointment procedure provided in Rule 5.4 of the CPR Arbitration Rules. The non-party appointed arbitrator must have prior U.S. reinsurance experience as a present or former officer or management employee of a reinsurance company, but not of the Company, or the Administrator, or any of their respective affiliates. The arbitration shall be conducted in New York City. Each party shall be permitted to present its case, witnesses and evidence, if any, in the presence of the other party. A written transcript of the proceedings shall be made and furnished to the parties. The arbitrators shall determine the Dispute in accordance with the law of New York, without giving effect to any conflict of law rules or other rules that might render such law inapplicable or unavailable, and shall apply this Agreement according to its terms, provided that the provisions relating to arbitration shall be governed by the Federal Arbitration Act, 9 U.S.C. §§ 1 et seq. The arbitral tribunal shall endeavor to render its award or order resulting from any arbitration within forty-five (45) days following the termination of the arbitration proceedings.

(c) The parties agree to be bound by any award or order resulting from any arbitration conducted hereunder and further agree that judgment on any award or order resulting from an arbitration conducted under this 19.4 may be entered and enforced in any court having jurisdiction thereof.

(d) Except as expressly permitted by this Agreement, no party will commence or voluntarily participate in any court action or proceeding concerning a Dispute, except (i) for enforcement as contemplated by 19.4(c) above, (ii) to restrict or vacate an arbitral decision based on the grounds specified under applicable law, or (iii) for interim relief as provided in paragraph (e) below. For purposes of the foregoing the parties hereto submit to the non-exclusive jurisdiction of the courts of the State of New York.

(e) In addition to the authority otherwise conferred on the arbitral tribunal, the tribunal shall have the authority to make such orders for interim relief, including injunctive relief, as it may deem just and equitable. Notwithstanding paragraph (d) above, each party acknowledges that in the event of any actual or threatened breach of certain of the provisions of this Agreement, the remedy at law would not be adequate, and therefore injunctive or other interim relief may be sought immediately to restrain such breach. If the tribunal shall not have been appointed, either party may seek interim relief from a court having jurisdiction if the award

15

---

to which the applicant may be entitled may be rendered ineffectual without such interim relief. Upon appointment of the tribunal following any grant of interim relief by a court, the tribunal may affirm or disaffirm such relief, and the parties will seek modification or rescission of the court action as necessary to accord with the tribunal's decision.

(f) Each party will bear its own attorneys' fees and costs incurred in connection with the resolution of any Dispute in accordance with this Article XIX.

## ARTICLE XX

### MISCELLANEOUS PROVISIONS

20.1. Headings and Schedules. Headings used herein are not a part of this Agreement and shall not affect the terms hereof. The attached Schedules are a part of this Agreement.

20.2. Notices. All notices, requests, demands and other communications under this Agreement must be in writing and will be deemed to have been duly given or made as follows: (a) if sent by registered or certified mail in the United States return receipt requested, upon receipt; (b) if sent by reputable overnight air courier, two business days after mailing; (c) if sent by facsimile transmission, with a copy mailed on the same day in the manner provided in (a) or (b) above, when transmitted and receipt is confirmed by telephone; or (d) if otherwise actually personally delivered, when delivered, and shall be delivered as follows:

If to the Company:

GE Capital Life Assurance Company of New York  
6610 West Broad Street  
Richmond, VA 23230  
Facsimile: (804) 281-6165  
Attention: Chief Executive Officer

With a copy to:

GE Capital Life Assurance Company of New York  
6610 West Broad Street  
Richmond, VA 23230  
Facsimile: (804) 281-6005  
Attention: General Counsel

16

---

If to the Administrator:

Union Fidelity Life Insurance Company  
200 North Martingale Road  
Schaumburg, IL 60173-2096  
Facsimile: (847) 330-3404  
Attention: Chief Financial Officer

With a copy to:

Union Fidelity Life Insurance Company  
200 North Martingale Road  
Schaumburg, IL 60173-2096  
Facsimile: (847) 605-3044  
Attention: General Counsel

or to such other address or to such other Person as either party may have last designated by notice to the other party.

20.3. Successors and Assigns. This Agreement shall be binding upon and inure to the benefit of the parties hereto and their respective successors, permitted assigns and legal representatives. Neither this Agreement, nor any right or obligation hereunder, may be assigned by any party without the prior written consent of the other party hereto and without the prior written consent of the New York Insurance Department and the Illinois Insurance Department. Any assignment in violation of this 20.3 shall be void and shall have no force and effect.

20.4. Execution in Counterpart. This Agreement may be executed by the parties hereto in any number of counterparts, and by each of the parties hereto in separate counterparts, each of which counterparts, when so executed and delivered, shall be deemed to be an original, but all such counterparts shall together constitute but one and the same instrument.

20.5. Safeguarding Customer Information. The Administrator shall implement and maintain appropriate measures designed to meet the objectives of New York Insurance Department Regulation No. 173, with respect to safeguarding the Company's customer information and customer information systems. The Administrator shall adjust its information security program at the reasonable request of the Company for any relevant changes indicated by the Company's assessment of risk around its customer information and customer information systems. Confirming evidence that the Administrator has satisfied its obligations under this Agreement shall be made available, during normal business hours, for inspection by the Company, representatives of the Company, and any governmental agency that has regulatory authority over the Company's business activities.

20.6. Currency. Whenever the word "Dollars" or the "\$" sign appear in this Agreement, they shall be construed to mean United States Dollars, and all transactions under this Agreement shall be in United States Dollars.

20.7. Amendments. This Agreement may not be changed, altered or modified unless the same shall be in writing executed by the Company and the Administrator.

17

---

20.8. Governing Law. This Agreement will be construed, performed and enforced in accordance with the laws of the State of New York without giving effect to its principles or rules of conflict of laws thereof to the extent such principles or rules would require or permit the application of the laws of another jurisdiction.

20.9. Entire Agreement; Severability. (a) This Agreement constitutes the entire agreement between the parties hereto relating to the subject matter hereof and supersedes all prior and contemporaneous agreements, understandings, statements, representations and warranties, negotiations and discussions, whether oral or written, of the parties and there are no general or specific warranties, representations or other agreements by or among the parties in connection with the entering into of this Agreement or the subject matter hereof except as specifically set forth or contemplated herein.

(b) If any provision of this Agreement is held to be void or unenforceable, in whole or in part, (i) such holding or provision shall not affect the validity and enforceability of the remainder of this Agreement, including any other provision, paragraph or subparagraph, and (ii) the parties agree to attempt in good faith to reform such void, unenforceable or violative provision to the extent necessary to render such provision enforceable and to carry out its original intent.

20.10. No Waiver; Preservation of Remedies. No consent or waiver, express or implied, by any party to or of any breach or default by any other party in the performance by such other party of its obligations hereunder shall be deemed or construed to be a consent or waiver to or of any other breach or default in the performance of obligations hereunder by such other party hereunder. Failure on the part of any party to complain of any act or failure to act of any other party or to declare any other party in default, irrespective of how long such failure continues, shall not constitute a waiver by such first party of any of its rights hereunder. The rights and remedies provided are cumulative and are not exclusive of any rights or remedies that any party may otherwise have at law or equity.

20.11. Third Party Beneficiary. Nothing in this Agreement will confer any rights upon any Person that is not a party or a successor or permitted assignee of a party to this Agreement.

20.12. Tax Exception to Any Confidentiality. Notwithstanding anything to the contrary set forth herein or in any other agreement to which the parties hereto are parties or by which they are bound, any obligations of confidentiality contained herein and therein, as they relate to the transactions, shall not apply to the federal tax structure or federal tax treatment of the transactions, and each party hereto (and any employee, representative, or agent of any party hereto) may disclose to any and all persons, without limitation of any kind, the federal tax structure and federal tax treatment of the transactions. The preceding sentence is intended to cause the transactions to be treated as not having been offered under conditions of confidentiality for purposes of Section 1.6011-4(b)(3) (or any successor provision) of the Treasury Regulations promulgated under Section 6011 of the Internal Revenue Code of 1986, as amended, and shall be construed in a manner consistent with such purpose. In addition, each party hereto acknowledges that it has no proprietary or exclusive rights to the federal tax structure of the transactions or any federal tax matter or federal tax idea related to the transactions.

18

---

20.13. Interpretation. Wherever the words “include,” “includes” or “including” are used in this Agreement, they shall be deemed to be followed by the words “without limitation.”

20.14. Survival. Article XIX and Article XX shall survive the termination of this Agreement.

20.15. Licensing. At all times during the term of this Agreement, the Administrator shall maintain in full force and effect all licenses required to be maintained by it under Applicable Law with respect to this Agreement, including, if applicable, an independent claims adjuster license.

19

---

IN WITNESS WHEREOF, the Company and the Administrator have executed this Agreement as of the date first above written.

GE CAPITAL LIFE ASSURANCE COMPANY  
OF NEW YORK

By: \_\_\_\_\_  
Name:  
Title:

UNION FIDELITY LIFE INSURANCE  
COMPANY

By: \_\_\_\_\_  
Name:  
Title:

20

---

## SCHEDULE A

### SEPARATE ACCOUNT SERVICES

The Administrator shall provide the following additional services to the Company relating to the Separate Accounts:

1. **Premium Collection.** The Administrator shall promptly invest in the Separate Accounts deposits collected which relate to the Separate Account portions of Reinsured Contracts (including transfers from fixed options under the Reinsured Contracts), and promptly forward funds and required information to the underlying investment management companies, in each case in accordance with the Reinsured Contracts and any applicable agreements provided by the Company to the Administrator.
2. **Records Maintenance.** The Administrator shall maintain and preserve records with respect to the Separate Accounts as required by Rules 31a-1 and 31a-2 under the Investment Company Act of 1940, as amended, the Securities Exchange Act of 1934, as amended, and the rules promulgated by the National Association of Securities Dealers (the “NASD”). Upon request of the Company or any state or federal regulatory authorities, the Administrator shall forward a complete copy of any record promptly to the requesting party and in a format appropriate to the request. The Administrator shall file with the Securities and Exchange Commission (“SEC”) the undertaking required by Rule 17a-4(i) under the Exchange Act with respect to any records that it maintains and that are required to be maintained under the provisions of the Exchange Act by any broker-dealers that are authorized to sell the Reinsured Contracts.
3. **Performance of Obligations.** The Administrator shall perform, in the name and on behalf of the Company, all of the Company’s obligations under (i) the participation agreements between the Company and the mutual fund organizations in which assets of the Separate Accounts are invested (the “Participation Agreements”), (ii) the underwriting agreements between the Company and the principal underwriters for the Separate Account portions of the Reinsured Contracts, and (iii) any other agreements related to the distribution of the Separate Account portions of the Reinsured Contracts; provided in each case that the Company has provided complete copies of such agreements (including any amendments thereto) to the Administrator.
4. **Contractholder Services.** The Administrator shall provide the Company with the following additional contractholder services:
  - (a) Issuing timely reports, statements, and confirmations as required by the Reinsured Contracts or the Company’s practices in effect immediately prior to the Effective Date and communicated by the Company to the Administrator in writing;

- (b) Issuing tax reporting forms and other information as required by applicable regulatory rules, including without limitation 1099-R, W-4P,

A-1

---

- and 5498 for contractholders and beneficiaries as required and distributing the same to contractholders and beneficiaries and appropriate authorities;
- (c) Responding to any requests from plan administrators or trustees for policy information affecting the plan or participants for qualified plans;
- (d) Responding to contractholder requests for calculations applicable to annuity payments under the Reinsured Contracts as may be necessary for tax withholding calculations;
- (e) Processing and recording transfer requests (i.e., from one subaccount to another) in all cases within time intervals necessary to meet SEC, NASD and other legal and regulatory requirements;
- (f) Calculating (on a daily basis) the net asset value and the accumulation unit value of each subaccount of the Separate Accounts that are funding options for the Reinsured Contracts, in accordance with the provisions of the Reinsured Contracts, as well as with the prospectus and statement of additional information disclosure on any day when such calculation is required by the Investment Company Act of 1940, as amended, and the rules and regulations thereunder;
- (g) Calculating (on a daily basis) the mortality and expense charges, and any administrative charges in accordance with the provisions of the Reinsured Contracts, as well as with the applicable prospectus and statement of additional information disclosure; and
- (h) Transmitting orders pursuant to the Participation Agreements for the purchase or redemption of shares in the investment companies in which the assets of the Separate Account are invested to such investment companies or their authorized agents and paying and receiving funds in connection with such purchases or redemptions as required by any applicable agreement.
5. **Actuarial Services.** The Administrator shall provide the formal actuarial opinions and related reports required by the SEC and the NASD.
6. **Compliance Services.** The Administrator shall provide the Company with the following additional compliance services:
- (a) Preparation and submission of (and provision of financial data required for) all reports required by the SEC (including without limitation forms N-SAR, 485(b) registration statement updates, fund and separate account annual reports and 24F-2 Notices), the NASD (including, without limitation, compilation of information, if any, related to the Reinsured Policies that would be reflected in any quarterly FOCUS II/IIA reports, annual FOCUS schedule 1 or Customer Complaints Rule 3070 Report), and the states (in each case only after review and approval thereof by the

A-2

---

- Company), with all of the foregoing to be accomplished within such time periods as are necessary to comply with Applicable Law after giving allowance, in the cases of information relevant to reports of filings of the Company that are not specific to the Reinsured Policies, for time periods reasonably specified by the Company to permit integration of the subject information related to the Reinsured Policies;
- (b) Notwithstanding anything in this Agreement to the contrary, all complaints and other grievances shall be handled by the Administrator in accordance with NASD requirements (including any response time requirements applicable thereto);
- (c) Review and comment on registration statements and other SEC related documents prepared by the Company, and assist the Company in meeting SEC requirements with respect to any of the Reinsured Contracts. In addition, the Administrator shall distribute at its expense to contractholders all required information provided by the Company to the Administrator (which the Company hereby agrees to provide on a timely basis), including prospectuses, post-effective amendments or supplements to the registration statements of the Separate Account or of any underlying funds as well as annual and semi-annual reports;
- (d) Make all filings and obtain all regulatory approvals required with regard to advertising of the Reinsured Contracts, including without limitation all filings and approvals required by Applicable Laws and NASD requirements (except to the extent that such services are performed by other entities pursuant to written agreements with the Company);
- (e) Ensure SEC and NASD compliance for variable contracts, prospectuses, and registration statements including the submission of any required information, conducting annual compliance audits, quarterly complaint reporting, registering and terminating representatives and monitoring continuing education requirements;
- (f) Monitor the federal securities statutes and the rules, regulations, orders, and interpretations thereunder and the securities statutes and rules, regulations, orders, and interpretations thereunder of the various states in which contractholders or Reinsured Contracts are located to ensure compliance therewith and to ensure that any actions or communications required thereby are properly made;
- (g) Process information relating to proxy voting, including receiving record date information and proxy solicitation from underlying investment vehicle(s); preparing proxy ballots; mailing solicitation and resolicitations, if necessary; and maintaining all proxy registers and other required proxy material;

A-3

---

- (h) Provide the Company with all information reasonably requested and necessary for the Company to meet any requirements arising out of the Sarbanes-Oxley Act of 2002, as amended; and
- (i) Ensure compliance with the Office of Foreign Assets Control (“OFAC”) of the US Department of the Treasury and money “laundering” restrictions, including but not limited to those adopted under the Uniting and Strengthening America By Providing Appropriate Tools Required to Intercept and



7. **General.** The Administrator agrees to comply with all applicable federal securities laws and requirements of applicable self regulatory organization, including the NASD, as they apply to the Separate Account portions of Reinsured Contracts in connection with the performance of the Administrator's obligations under this Agreement. The Administrator hereby agrees to provide all necessary information to the Company in order to meet all regulatory requirements as may be necessary for the Company to fulfill its obligations under federal and state law as is deemed reasonably necessary by the Company under applicable federal and state laws as they relate to the Reinsured Contracts.

A-4

---

## BUSINESS ASSOCIATE ADDENDUM

### I. Purpose.

In order to disclose certain information to the party providing a service under this Agreement ("Provider") under this Addendum, some of which may constitute Protected Health Information (defined below), the party to whom a service under this Agreement is being provided ("Recipient") and Provider mutually agree to comply with the terms of this Addendum for the purpose of satisfying the requirements of the Health Insurance Portability and Accountability Act of 1996 ("HIPAA") and its implementing privacy regulations at 45 C.F.R. Parts 160-164 ("HIPAA Privacy Rule"). These provisions shall apply to Provider to the extent that Provider is considered a "Business Associate" under the HIPAA Privacy Rule and all references in this section to Business Associates shall refer to Provider. Capitalized terms not otherwise defined herein shall have the meaning assigned in the Agreement. Notwithstanding anything else to the contrary in the Agreement, in the event of a conflict between this Addendum and the Agreement, the terms of this Addendum shall prevail.

### II. Permitted Uses and Disclosures.

A. Business Associate agrees to use or disclose Protected Health Information ("PHI") that it creates for or receives from Recipient or its Subsidiaries only as follows. The capitalized term "Protected Health Information or PHI" has the meaning set forth in 45 Code of Federal Regulations Section 164.501, as amended from time to time. Generally, this term means individually identifiable health information including, without limitation, all information, data and materials, including without limitation, demographic, medical and financial information, that relates to the past, present, or future physical or mental health or condition of an individual; the provision of health care to an individual; or the past present, or future payment for the provision of health care to an individual; and that identifies the individual or with respect to which there is a reasonable basis to believe the information can be used to identify the individual. This definition shall include any demographic information concerning members and participants in, and applicants for, Recipient's or its Subsidiaries' health benefit plans. All other terms used in this Addendum shall have the meanings set forth in the applicable definitions under the HIPAA Privacy Rule.

B. Functions and Activities on Company's Behalf. Business Associate is permitted to use and disclose PHI it creates for or receives from Recipient or its Subsidiaries only for the purposes described in this Addendum or the Agreement that are not inconsistent with the provisions of this Addendum, or as required by law, or following receipt of prior written approval from whichever of the Recipient or its Subsidiary for which the relevant PHI was created or from which the relevant PHI was received. In addition to these specific requirements below, Business Associate may use or disclose PHI only in a manner that would not violate the HIPAA Privacy Rule if done by the Recipient or its Subsidiaries.

C. Business Associate's Operations. Business Associate is permitted by this Agreement to use PHI it creates for or receives from Recipient or its Subsidiaries: (i) if such use is reasonably necessary for Business Associate's proper management and administration; and (ii) as reasonably necessary to carry out Business Associate's legal responsibilities. Business

---

Associate is permitted to disclose PHI it creates for or receives from Recipient or its Subsidiaries for the purposes identified in this Section only if the following conditions are met:

- (1) The disclosure is required by law; or
- (2) The disclosure is reasonably necessary to Business Associate's proper management and administration, and Business Associate obtains reasonable assurances in writing from any person or organization to which Business Associate will disclose such PHI that the person or organization will:
  - a. Hold such PHI as confidential and use or further disclose it only for the purpose for which Business Associate disclosed it to the person or organization or as required by law; and
  - b. Notify Business Associate (who will in turn promptly notify whichever of the Recipient or its Subsidiary for which the relevant PHI was created or from which the relevant PHI was received) of any instance of which the person or organization becomes aware in which the confidentiality of such PHI was breached.

D. Minimum Necessary Standard. In performing the functions and activities on Recipient's or its Subsidiaries' behalf pursuant to the Agreement, Business Associate agrees to use, disclose or request only the minimum necessary PHI to accomplish the purpose of the use, disclosure or request. Business Associate must have in place policies and procedures that limit the PHI disclosed to meet this minimum necessary standard.

E. Prohibition on Unauthorized Use or Disclosure. Business Associate will neither use nor disclose PHI it creates or receives for or from Recipient, its Subsidiaries, or from another business associate of Recipient or its Subsidiaries, except as permitted or required by this Addendum or the Agreement that are not inconsistent with the provisions of this Addendum, or as required by law, or following receipt of prior written approval from whichever of the Recipient or its Subsidiary for which the relevant PHI was created or from which the relevant PHI was received.

F. De-identification of Information. Business Associate agrees neither to de-identify PHI it creates for or receives from Recipient or its Subsidiaries or from another business associate of Recipient or its Subsidiaries, nor use or disclose such de-identified PHI, unless such de-identification is expressly permitted under the terms and conditions of this Addendum or the Agreement and related to Recipient's or its Subsidiaries' activities for purposes of "treatment", "payment" or "health care operations", as those terms are defined under the HIPAA Privacy Rule. De-identification of PHI, other than as expressly permitted under the terms and conditions of the Addendum for Business Associate to perform services for Recipient or its Subsidiaries, is not a permitted use of PHI under this Addendum. Business Associate further agrees that it will not create a "Limited Data Set" as defined by the HIPAA Privacy Rule using PHI it creates or receives, or receives from another business associate of Recipient or its Subsidiaries, nor use or disclose such Limited Data Set unless: (i) such creation, use or disclosure is expressly permitted under the terms and conditions of this Addendum or the Agreement that are not inconsistent with

---

the provisions of this Addendum; and such creation, use or disclosure is for services provided by Business Associate that relate to Recipient's or its Subsidiaries' activities for purposes of "treatment", "payment" or "health care operations", as those terms are defined under the HIPAA Privacy Rule.

G. Information Safeguards. Business Associate will develop, document, implement, maintain and use appropriate administrative, technical and physical safeguards to preserve the integrity and confidentiality of and to prevent non-permitted use or disclosure of PHI created for or received from Recipient or its Subsidiaries. These safeguards must be appropriate to the size and complexity of Business Associate's operations and the nature and scope of its activities. Business Associate agrees that these safeguards will meet any applicable requirements set forth by the U.S. Department of Health and Human Services, including (as of the effective date or as of the compliance date, whichever is applicable) any requirements set forth in the final HIPAA security regulations. Business Associate agrees to mitigate, to the extent practicable, any harmful effect that is known to Business Associate resulting from a use or disclosure of PHI by Business Associate in violation of the requirements of this Addendum.

III. Conducting Standard Transactions. In the course of performing services for Recipient or its Subsidiaries, to the extent that Business Associate will conduct Standard Transactions for or on behalf of Recipient or its Subsidiaries, Business Associate will comply, and will require any subcontractor or agent involved with the conduct of such Standard Transactions to comply, with each applicable requirement of 45 C.F.R. Part 162. "Standard Transaction(s)" shall mean a transaction that complies with the standards set forth at 45 C.F.R. parts 160 and 162. Further, Business Associate will not enter into, or permit its subcontractors or agents to enter into, any trading partner agreement in connection with the conduct of Standard Transactions for or on behalf of the Recipient or its Subsidiaries that:

- a. Changes the definition, data condition, or use of a data element or segment in a Standard Transaction;
- b. Adds any data element or segment to the maximum defined data set;
- c. Uses any code or data element that is marked "not used" in the Standard Transaction's implementation specification or is not in the Standard Transaction's implementation specification; or
- d. Changes the meaning or intent of the Standard Transaction's implementation specification.

IV. Sub-Contractors, Agents or Other Representatives. Business Associate will require any of its subcontractors, agents or other representatives to which Business Associate is permitted by this Addendum or the Agreement (or is otherwise given Recipient's or the relevant Subsidiary's prior written approval) to disclose any of the PHI Business Associate creates or receives for or from Recipient or its Subsidiaries, to provide reasonable assurances in writing that subcontractor or agent will comply with the same restrictions and conditions that apply to the Business Associate under the terms and conditions of this Addendum with respect to such PHI.

---

V. Protected Health Information Access, Amendment and Disclosure Accounting.

A. Access. Business Associate will promptly upon Recipient's or its Subsidiary's request make available to Recipient, its Subsidiary, or, at Recipient's or such Subsidiary's direction, to the individual (or the individual's personal representative) for inspection and obtaining copies any PHI about the individual which Business Associate created for or received from Recipient or its Subsidiary and that is in Business Associate's custody or control, so that Recipient or its Subsidiary may meet its access obligations under 45 Code of Federal Regulations § 164.524.

B. Amendment. Upon Recipient's or its Subsidiary's request Business Associate will promptly amend or permit Recipient or its Subsidiary access to amend any portion of the PHI which Business Associate created for or received from Recipient or its Subsidiary, and incorporate any amendments to such PHI, so that Recipient or its Subsidiary may meet its amendment obligations under 45 Code of Federal Regulations § 164.526.

C. Disclosure Accounting. So that Recipient or its Subsidiaries may meet their disclosure accounting obligations under 45 Code of Federal Regulations § 164.528:

1. Disclosure Tracking. Business Associate will record for each disclosure, not excepted from disclosure accounting under Section V.C.2 below, that Business Associate makes to Recipient or its Subsidiaries of PHI that Business Associate creates for or receives from Recipient or its Subsidiaries, (i) the disclosure date, (ii) the name and member or other policy identification number of the person about whom the disclosure is made, (iii) the name and (if known) address of the person or entity to whom Business Associate made the disclosure, (iv) a brief description of the PHI disclosed, and (v) a brief statement of the purpose of the disclosure (items i-v, collectively, the "disclosure information"). For repetitive disclosures Business Associate makes to the same person or entity (including Recipient or its Subsidiaries) for a single purpose, Business Associate may provide a) the disclosure information for the first of these repetitive disclosures, (b) the frequency, periodicity or number of these repetitive disclosures and (c) the date of the last of these repetitive disclosures. Business Associate will make this disclosure information available to Recipient or its Subsidiaries promptly upon Recipient's or its Subsidiaries' request.

2. Exceptions from Disclosure Tracking. Business Associate need not record disclosure information or otherwise account for disclosures of PHI that this Addendum or Recipient or the relevant Subsidiary in writing permits or requires (i) for the purpose of Recipient's or its Subsidiaries' treatment activities, payment activities, or health care operations, (ii) to the individual who is the subject of the PHI disclosed or to that individual's personal representative; (iii) to persons involved in that individual's health care or payment for health care; (iv) for notification for disaster relief purposes, (v) for national security or intelligence purposes, (vi) to law enforcement officials or correctional institutions regarding inmates; or (vii) pursuant to an authorization; (viii) for disclosures of certain PHI made as part of a Limited Data Set; (ix) for certain incidental disclosures that may occur where reasonable safeguards have been implemented; and (x) for disclosures prior to April 14, 2003.

3. Disclosure Tracking Time Periods. Business Associate must have available for Recipient and its Subsidiaries the disclosure information required by this section for the 6 years preceding Recipient's or its Subsidiaries' request for the disclosure information (except Business Associate need have no disclosure information for disclosures occurring before April 14, 2003).

VI. Additional Business Associate Provisions

A. Reporting of Breach of Privacy Obligations. Business Associate will provide written notice to whichever of the Recipient or its Subsidiary for which the relevant PHI was created or from which the relevant PHI was received of any use or disclosure of PHI that is neither permitted by this Addendum nor given prior written approval by Recipient or the relevant Subsidiary promptly after Business Associate learns of such non-permitted use or disclosure. Business Associate's report will at least:

- (i) Identify the nature of the non-permitted use or disclosure;

- (ii) Identify the PHI used or disclosed;
- (iii) Identify who made the non-permitted use or received the non-permitted disclosure;
- (iv) Identify what corrective action Business Associate took or will take to prevent further non-permitted uses or disclosures;
- (v) Identify what Business Associate did or will do to mitigate any deleterious effect of the non-permitted use or disclosure; and
- (vi) Provide such other information, including a written report, as Recipient or the relevant Subsidiary may reasonably request.

B. Amendment. Upon the effective date of any final regulation or amendment to final regulations promulgated by the U.S. Department of Health and Human Services with respect to PHI, including, but not limited to the HIPAA privacy and security regulations, this Addendum and the Agreement will automatically be amended so that the obligations they impose on Business Associate remain in compliance with these regulations.

In addition, to the extent that new state or federal law requires changes to Business Associate's obligations under this Addendum, this Addendum shall automatically be amended to include such additional obligations, upon notice by Recipient or its Subsidiaries to Business Associate of such obligations. Business Associate's continued performance of services under the Agreement shall be deemed acceptance of these additional obligations.

C. Audit and Review of Policies and Procedures. Business Associate agrees to provide, upon Recipient request, access to and copies of any policies and procedures developed or utilized by Business Associate regarding the protection of PHI. Business Associate agrees to provide, upon Recipient's request, access to Business Associate's internal practices, books, and records, as they relate to Business Associate's services, duties and obligations set forth in this Addendum and the Agreement(s) under which Business Associate provides services and / or

products to or on behalf of Recipient or its Subsidiaries, for purposes of Recipient's or its Subsidiaries' review of such internal practices, books, and records.

#### SCHEDULE D

##### CEDING COMMISSION

The Ceding Commission shall be the sum of the following:

1. an amount equal to the excess of (i) the General Account Reserves as of the Inception Date over (ii) the net reserves of the Company with respect to the General Account Liabilities (net after deduction for Ceded Reinsurance) as of the Inception Date, determined in accordance with GAAP (which amount may be negative);
2. an amount equal to the unamortized PVFP intangible asset balance of the Company (excluding any related mark to market adjustments for SFAS 115 requirement) with respect to the Reinsured Contracts as measured as of the close of business on the day immediately preceding the Inception Date, determined in accordance with GAAP;
3. an amount equal to the unamortized deferred acquisition costs of the Company (excluding any related mark to market adjustments for SFAS 115 requirement) with respect to the Reinsured Contracts as measured as of the close of business on the day immediately preceding the Inception Date, determined in accordance with GAAP; and
4. an amount equal to the excess of the GAAP book value of the Assets (excluding any related mark to market adjustments for SFAS 115 requirement) over the SAP book value of the Assets measured as of the close of business on the day immediately preceding the Inception Date (which amount may be negative).

#### SCHEDULE E

##### ASSETS

Transfer Document		From		To		Nature of Transfer		Cash Map Cross-Reference		Schedule	
GECLANY VA Reinsurance		GECLANY		UFLIC		Treaty		(88)		Schedule E	
Called Securities*	Parent Name	Issuer Name	1Q04 Cusip	1Q04 Tax lot	12/31/03 Local Par	12/31/03 GAAP BV (incl attached derivative)	12/31/03 Accrued Interest	12/31/03 GAAP BV + Accrued Interest	12/31/03 STAT BV (incl attached derivative)	12/31/03 Accrued Interest	12/31/03 STAT BV + Accrued Interest
[Individual Asset Details Omitted]											
Asset Sub Total						241,003,458.24	3,471,887.35	244,475,345.59	241,003,458.24	3,471,887.35	244,475,345.59
Cash									702,048.88		702,048.88

---

\* These Securities will not be transferred. The "Call Amount" will be settled in cash

---

## SCHEDULE F

### EXPENSE ALLOWANCES

The "Annual Expense Reimbursement Factor" used to calculate the Expense Allowance is as follows:

Policy Maintenance Factor            \$59.73 per Policy less \$64.69 per Policy of fund company administrative expense service shares.

Such Annual Expense Reimbursement Factor will be adjusted (i) for the year beginning January 1, 2005 and, thereafter, every three (3) years during the term of this Agreement based on a triennial cost/time study prepared in accordance with the methodology set forth below (the "Triennial Study") and (ii) for the years between the Triennial Studies based on a report setting forth the Annual Expense Reimbursement Factor prepared in accordance with the methodology set forth below (the "Annual Expense Reimbursement Factor Report").

(a) Triennial Study. As soon as practicable (and in any event within sixty (60) days) prior to January 1, 2005 and prior to the beginning of every third calendar year thereafter during the term of this Agreement, the Company shall cause to be prepared and delivered to the Reinsurer the Triennial Study which sets forth the Annual Expense Reimbursement Factor for the next calendar year, together with all supporting data used in preparing the Triennial Study and work papers, in reasonable detail, setting forth the determination of such Annual Expense Reimbursement Factors based on such Triennial Study (such documents, together with the Triennial Study, the "Triennial Study Documents").

(b) Annual Expense Reimbursement Factor Report. As soon as practicable (and in any event within thirty (30) days) prior to January 1, 2006 and prior to the beginning of each calendar year thereafter in which no Triennial Study is prepared, the Company shall cause to be prepared and delivered to the Reinsurer the Annual Expense Reimbursement Factor Report, together with all supporting data used in preparing the Annual Expense Reimbursement Factor Report and work papers, in reasonable detail, setting forth the determination of such Annual Expense Reimbursement Factor for the next calendar year (such documents, together with the Annual Expense Reimbursement Factor Report, the "Annual Expense Reimbursement Factor Documents").

(c) Methodology. At the time of the Triennial Study, historical costs (to include costs directly related to maintaining and administering policies, processing claims and reporting results) will be determined for the Policy Maintenance Factor identified above. For a given Annual Expense Reimbursement Factor the identified costs will be divided by the total historical number of units of measure for both the Reinsured Contracts and the retained block of business to derive an historical cost per unit. The historical cost per unit will be used as a prospective cost per unit for the next calendar year.

For the two succeeding years in the period between the Triennial Studies the historical dollar amounts by Policy Maintenance Factor will be adjusted (rolled forward) for current year cost changes agreed to by the Reinsurer and the Company (in accordance with the procedures set forth below). This rolled forward historical cost will then be divided by the total historical number of units for the current period to determine a prospective cost per unit for the next calendar year.

An additional adjustment, positive or negative, to the prospective cost per unit determined by either the Triennial Study or the two succeeding years may be negotiated between the parties. The additional adjustment is for special projected costs or benefits of productivity,

---

process improvements, inflation, loss of scale, and any other cost variation which was not included in the prior Triennial Study or the succeeding roll forward.

The credit for Fund Company Administrative Expense Service Shares will be redetermined annually to reflect historical amounts of reimbursement relating to Reinsured Contracts, current period number of units, and changes in contractual arrangements with Fund Companies.

The combined prospective unit cost, additional adjustment and Fund Company Administrative Expense Service Shares credit is the Annual Expense Reimbursement Factor. The Expense Allowance will be determined quarterly and billed to the Reinsurer in three equal installments during the quarter at the end of the month. Each installment will be determined by multiplying the actual number of units at the beginning of the quarter covered by this Agreement times the Annual Expense Reimbursement Factor (divided by twelve).

(d) Review of Documents. Following the delivery of the Annual Expense Reimbursement Factor Documents or the Triennial Study Documents, as applicable, the Company shall (i) provide to the Reinsurer or its designated representative copies of such additional work papers and other documents relating to its preparation of the Annual Expense Reimbursement Factor Report or Triennial Study, as applicable, as the Reinsurer or its designated representative may reasonably request, including, without limitation, claims files and practices and (ii) cooperate with, and make its personnel and facilities reasonably available to, the Reinsurer and the Reinsurer's designated representative for the purpose of providing such other information as the Reinsurer or the Reinsurer's designated representative may reasonably request concerning Annual Expense Reimbursement Factor Documents or the Triennial Study Documents, as applicable, and the calculation of the Annual Expense Reimbursement Factor.

(e) Notice of Disagreement. In the event that the Reinsurer has any disagreement with any of the Annual Expense Reimbursement Factor Documents or the Triennial Study Documents, as applicable, the Reinsurer shall give written notice of all such disagreements (a "Notice of Disagreement") to the Company within thirty (30) days after the Annual Expense Reimbursement Factor Documents or the Triennial Study Documents, as applicable, are delivered to the Reinsurer. Any Notice of Disagreement shall set forth each item in disagreement and shall provide reasonable specificity as to the basis for each disagreement and shall specify the total adjustment to the Annual Expense Reimbursement Factor, as proposed by the Company as a result of such items in disagreement.

(f) Dispute Resolution. If the Reinsurer does not deliver a Notice of Disagreement to the Company within such thirty (30) day period, the Annual Expense Reimbursement Factor Documents and the Triennial Study Documents, as applicable, shall be final and binding upon the parties hereto and shall constitute the final calculation of the Annual Expense Reimbursement Factor for the next calendar year. If the Reinsurer delivers a Notice of Disagreement to the Company within such thirty (30) day period, the parties shall (and shall cause their respective designated representatives to) negotiate in good faith to resolve all disagreements as promptly as practicable. Any changes in the Annual Expense Reimbursement Factor, if any, that are agreed to by the Company and the Reinsurer within sixty (60) days of the aforementioned delivery of the Annual Expense Reimbursement Factor Documents or the

Triennial Study Documents, as applicable, shall be incorporated into a final calculation of the Annual Expense Reimbursement Factor. If the parties and their respective designated representatives are unable to resolve all disagreements within sixty (60) days of delivery of the Annual Expense Reimbursement Factor Documents or the Triennial Study Documents, as applicable, then all unresolved disagreements will be submitted within ten (10) days after the end of such sixty (60) day period for resolution in accordance herewith to an independent certified public accounting firm of national standing and reputation (the "Accounting Firm") mutually acceptable to the Company and the Reinsurer. The parties shall cooperate in good faith with the Accounting Firm and shall give the Accounting Firm access to all data and other information requested by the Accounting Firm for purposes of such resolution. The Accounting Firm shall, within thirty (30) days after its engagement, deliver to the Company and the Reinsurer a definitive calculation of the Annual Expense Reimbursement Factor, which shall be final and binding upon the parties hereto and shall be so reflected in the calculation of the Annual Expense Reimbursement Factor. The Company and the Reinsurer shall each pay one-half of the fees and expenses of the Accounting Firm.

(g) Expense Allowance Pending Resolution. In the event of a dispute with respect to any Annual Expense Reimbursement Factor for the next succeeding Calendar year, the Company and the Reinsurer agree that the Annual Expense Reimbursement Factor then in effect under this Agreement shall remain in effect pending resolution of such dispute and adjustment, if any, in accordance with the dispute resolution procedure set forth in paragraph (f) above.

SCHEDULE G - PART I

INITIAL REPORT

<b>1.SAP General Account Reserves</b>		\$
<b>2.Ceding Commission:</b>		
A.Excess SAP General Account Reserves over GAAP net reserves for General Account Liabilities:		
1)Total SAP General Account Reserves	\$	
2)Total GAAP net reserves for General Account Liabilities	\$	
<b>Excess SAP Reserves over GAAP Reserves (A1-A2)</b>		\$
B.Present Value of Future Profits (PVFP)		\$
C.Deferred Acquisition Costs (DAC)		\$
D.Asset Book Value Difference —Measured as of close of business the day preceding the Inception Date		
1)Asset Book Value (GAAP basis)	\$	
2)Asset Book Value (SAP basis)	\$	
<b>Excess Asset Book Value (D1-D2)</b>		\$
<b>Total Ceding Commission (A+B+C+D)</b>		\$
<b>3.Accrued Interest on Assets as of the day before Inception Date</b>		\$
<b>4.Investment Cash Flows on the Assets from the Inception Date through the Closing Date</b>		\$
<b>Net Due Reinsurer (1-2-3+4)</b>		\$

SCHEDULE G - PART II

DAILY SETTLEMENT REPORT

Settlement Amount

	<u>Current Day</u>	<u>Quarter-To-Date</u>
1.Premium/Deposits Received from Contractholders	\$	\$
2.Net Sales/Redemptions of UIT Shares	\$	\$
3.Net Purchases of UIT Shares	\$	\$
4.Payments to Contractholders from Policy Owner Services	\$	\$
5.Payment to Contractholder Beneficiaries for claims	\$	\$
[1+2-3-4-5]	\$	\$

SCHEDULE G - PART III

MONTHLY SETTLEMENT REPORT

	<u>Settlement Amount</u>	<u>Current Month Estimate</u>	<u>Quarter-To-Date</u>
1.Mortality and Expense Charges	\$	\$	\$
2.Premium Taxes	\$	\$	\$

3. Expense Factor	\$	\$
4. Ceded Reinsurance Premiums	\$	\$
5. Ceded Reinsurance Benefits/Recoverables	\$	\$
6. Commissions and Other Fees or Compensation Paid: Trail and Add On (See Schedule J)	\$	\$
7. Insolvency Fund or Similar Assessments Paid	\$	\$
8. Other	\$	\$
[1-2-3-4+5-6-7-8]	\$	\$

SCHEDULE G - PART IV  
QUARTERLY SETTLEMENT REPORT

			Previously Reported	Actual Quarter Results	True Up
<b>Daily Settlement Reconciliation</b>					
1	1	Premiums			
		UIT Sales and Purchases			
2	2	Customer Transfers (Net)			
3	3	Redemption of Shares for Surrender Charges			
4	3	Redemption of Shares for Rider Fees and Loads			
5	5	Corrections and Gain/Loss			
		Payments to Contractholders and Beneficiaries			
6	6	Surrenders and Withdrawals			
7	7	Return of Premium-Freelooks			
8	8	Death Benefits (Standard and Enhanced)			
9	9	Net (+1 +/-2 +3+4+/-5-6-7-8)			
<b>Monthly Settlement Reconciliation</b>					
10	10	Mortality & Expense Charges			
11	11	Premium Taxes			
12	12	Expense Factor			
13	13	Ceded Reinsurance Premium			
14	14	Ceded Reinsurance Benefits/Recoverables			
15	15	Commissions and other Fees or Compensation Paid			
16	16	Insolvency Fund or Similar Assessments Paid			
17	17	Extra Contractual Liabilities Paid			
18	18	Other			
19	19	Net (+10-11-12-13+14-15-16-17+/-18)			
20	20	<b>Quarterly Settlement (9+19)</b>			
<b>MODCO Adjustment Reconciliation</b>					
21	21	Beginning Separate Account Reserves			
22	22	UIT Sales and Purchases (+/-2 +3+4+/-5)			
23	23	Mortality & Expense Charges (10)			
24	24	UIT Appreciation			
25	25	Ending Separate Account Reserves (+21-22-23+/-24)			

SCHEDULE G - PART V  
ANNUAL REPORT

The following in the same level of detail as the quarterly settlements:

1. Premiums
2. UIT Sales and Purchases
3. Payments to Contractholders and Beneficiaries
4. Premiums Taxes
5. Commissions and Other Fees or Compensation Paid

**Other information required to complete accounting and reporting:**

6. Expense allowance accrual at year end

7. DAC and PVFP, as applicable

8. Modco reserve to support completion of Schedule S and RBC

## SCHEDULE H

FORM OF TRUST AGREEMENT

## SCHEDULE I

ELIGIBLE SECURITIES

Assets of the types for which an Illinois-domiciled life insurance company could obtain full statutory reserve credit under statutory accounting practices prescribed or permitted by the Director of Insurance of the State of Illinois.

## SCHEDULE J

COMMISSIONS

PRODUCT	MAXIMUM STANDARD COMMISSION*	MAXIMUM TRAIL COMMISSION**
CVA NY	6.0%	0.01666%
Choice NY	7.0%	0.08333%
Selections NY	6.0%	0.08333%

\*Each percentage listed is an aggregate percentage of purchase payments made by the contract owner.

\*\*Trail commissions shown are monthly rates.

**Wholesaling Variable Compensation**

PRODUCT	RSG	IAN	GFA	IBG
CVA NY	60bps	0	390bps	50bps
Choice NY	70bps	130bps	360bps	50bps
Selections NY	45bps	130bps	360bps	50bps

**Firm Marketing Related Expense Reimbursements**

Firm	Expense Reimbursement for Add On Premium	Expense Reimbursement on Inforce (annual rates)
ABN AMRO	25bps on Choice & Selections	
AG EDWARDS		10bps on VA's > 1 year old
BANK OF AMERICA	25bps on Choice & Extra	0bps on VA's — Yrs 0-2; 5bps on Choice, Extra, Selections — Yrs 3-5; 10bps on Choice, Extra, Selections — Yrs 6+.
CHASE	15bps on Foundation	5bps on Choice, Extra, Selections > 2 Yrs old.
FLEET QUICK & REILLY		8bps on Choice, Choice NY, Extra, Selections > 1 Yr old.
RAYMOND JAMES	15bps on Choice & Extra	
SALOMON SMITH BARNEY	50bps Excess Comp on Choice; 25bps Excess Comp on Extra & Selections	4bps on VA's > 1 Yr old

WACHOVIA SECURITIES LLC	20bps on Choice, Extra, & Selections; 10bps on Freedom	5bps on Choice, Extra, Selections > 1 Yr old
ESSEX	25bps on Choice, Extra, Freedom	
COMERICA	5bps on Choice & Extra	
FIRST ALLIED SECURITIES	15bps on Choice, Extra, Selections	
FIRST TENNESSEE BANK	25bps on Choice & Extra	
H&R BLOCK	5bps on Choice & Extra	
HSBC	10bps on Choice, Extra, Freedom, Selections	
LEGG MASON	25bps on Choice & Extra	
LINSCO PRIVATE LEDGER	40bps on Choice, Extra, Freedom	
MCDONALD/KEY	25bps on Choice & Extra	
PRIMEVEST	20bps on Choice & Extra	

<b>RBC DAIN RAUSCHER INC</b>	25bps on Choice & Extra	
<b>UBS PAINWEBBER</b>	20bps on Choice, Extra, Freedom	5bps on VA's — 4/1/97 — 9/30/00 Block
<b>USB PIPER JAFFRAY</b>	25bps on Choice, Extra, Selections	
<b>UVEST</b>	25bps on Choice & Extra	
<b>FINTEGRA</b>	15bps on Choice & Extra	
<b>IFMG</b>	25bps on Choice, Extra, Selections	
<b>STANFORD GROUP</b>	15bps on Choice & Extra	
<b>WASHINGTON MUTUAL</b>	25bps on Choice	

Ceding Company Marketing Allowance on Add-On Premiums: 78bps

---



**COINSURANCE AGREEMENT**  
**between**  
**UNION FIDELITY LIFE INSURANCE COMPANY**  
**and**  
**FEDERAL HOME LIFE INSURANCE COMPANY**  
**Dated as of April 15, 2004**

TABLE OF CONTENTS

<a href="#">ARTICLE I</a>	<a href="#">DEFINITIONS</a>
<a href="#">ARTICLE II</a>	<a href="#">COVERAGE</a>
<a href="#">ARTICLE III</a>	<a href="#">ADMINISTRATION; GENERAL PROVISIONS</a>
<a href="#">ARTICLE IV</a>	<a href="#">REINSURANCE ASSET TRANSFER; CEDING COMMISSION</a>
<a href="#">ARTICLE V</a>	<a href="#">QUARTERLY INSOLVENCY FUND AND PREMIUM TAX ACCOUNTING</a>
<a href="#">ARTICLE VI</a>	<a href="#">CERTAIN ACTIONS BY THE COMPANY</a>
<a href="#">ARTICLE VII</a>	<a href="#">REGULATORY MATTERS AND REPORTING</a>
<a href="#">ARTICLE VIII</a>	<a href="#">DURATION AND TERMINATION</a>
<a href="#">ARTICLE IX</a>	<a href="#">INSOLVENCY</a>
<a href="#">ARTICLE X</a>	<a href="#">SECURITY AND REINSURANCE CREDIT</a>
<a href="#">ARTICLE XI</a>	<a href="#">DEFERRED ACQUISITION COSTS</a>
<a href="#">ARTICLE XII</a>	<a href="#">DISPUTE RESOLUTION</a>
<a href="#">ARTICLE XIII</a>	<a href="#">PRIVACY REQUIREMENTS</a>
<a href="#">ARTICLE XIV</a>	<a href="#">MISCELLANEOUS PROVISIONS</a>

SCHEDULES

<a href="#">SCHEDULE A</a>	<a href="#">= POLICY FORMS</a>
<a href="#">SCHEDULE B</a>	<a href="#">= CEDING COMMISSION</a>
<a href="#">SCHEDULE C</a>	<a href="#">= ASSETS</a>
<a href="#">SCHEDULE D</a>	<a href="#">= INITIAL REPORT</a>
<a href="#">SCHEDULE E</a>	<a href="#">= FORM OF TRUST AGREEMENT</a>

COINSURANCE AGREEMENT

This Coinsurance Agreement, dated as of April 15, 2004 (this "Agreement"), is made and entered into by and between Union Fidelity Life Insurance Company, an insurance company organized under the laws of the State of Illinois (the "Company"), and Federal Home Life Insurance Company, an insurance company organized under the laws of the Commonwealth of Virginia (the "Reinsurer"). Defined terms used herein are defined below.

The Company and the Reinsurer mutually agree to reinsure the risks described in this Agreement under the terms and conditions stated herein. This Agreement is an indemnity coinsurance agreement solely between the Company and the Reinsurer, and the performance of the obligations of each party under this Agreement shall be rendered solely to the other party. In no instance shall anyone other than the Company or the Reinsurer have any rights under this Agreement. The Company shall be and shall remain the only party hereunder that is liable to any insured, contract holder, policyholder, claimant or beneficiary under any insurance policy or contract reinsured hereunder.

This Agreement is entered into in connection with an intercompany reorganization among the Company, the Reinsurer and certain of their Affiliates.

## DEFINITIONS

1.1. Definitions. As used in this Agreement, the following terms shall have the following meanings (definitions are applicable to both the singular and the plural forms of each term defined in this Article):

“Affiliate” means any other Person that directly or indirectly controls, is controlled by, or is under common control with, the first Person. “Control” (including the terms, “controlled by” and “under common control with”) means the possession, directly or indirectly, of the power to direct or cause the direction of the management and policies of a Person, whether through the ownership of voting securities, by contract or credit arrangement, as trustee or executor, or otherwise.

“Agreement” shall have the meaning specified in the first paragraph of this Agreement.

“Allocated Loss Adjustment Expenses” means all costs, fees and expenses incurred by the Company or its Affiliates in the investigation, adjustment, settlement or defense of all claims or the monitoring, preservation or enforcement of rights, interests or benefits arising out of or relating to the Reinsured Policies (excluding office expenses and salaries of officials of the Company or its Affiliates or any other administrative or overhead expenses of the Company or of its Affiliates), and court costs, and interest on any judgment or award. Allocated Loss Adjustment Expenses shall also include expenses associated with an action by any entity for declaratory judgment filed in connection with the Reinsured Policies.

---

“Annual Adjustment” shall have the meaning specified in Section 6.2.

“Applicable Law” means any federal, state, local or foreign law (including common law), statute, ordinance, rule, regulation, order, writ, injunction, judgment, permit, governmental agreement or decree applicable to a Person or any of such Person’s subsidiaries, properties, assets, or to such Person’s officers, directors, managing directors, employees or agents in their capacity as such.

“Assets” shall have the meaning specified in Section 4.4(a).

“Business Day” means any day other than a Saturday, Sunday or other day on which commercial banks in the States of Illinois or Virginia are required or authorized by law to be closed.

“Ceding Commission” shall have the meaning specified in Section 4.3.

“Closing Date” means April 15, 2004.

“Code” means the Internal Revenue Code of 1986, as amended.

“CPR” shall have the meaning specified in Section 12.3.

“CPR Arbitration Rules” shall have the meaning specified in Section 12.4(a).

“Dispute” shall have the meaning specified in Section 12.1(a).

“Eligible Securities” shall have the meaning specified in Section 10.2(c).

“Extra Contractual Liabilities” means all liabilities for damages (including compensatory, consequential, exemplary, punitive, bad faith or similar or other damages) which relate to the marketing, sale, underwriting, issuance, delivery, cancellation or administration of the Reinsured Policies, including liability arising out of or relating to any alleged or actual acts, errors or omissions by the Company, the Reinsurer or any of their agents, whether intentional or otherwise, with respect to any of the Reinsured Policies, including (A) any alleged or actual reckless conduct or bad faith in connection with the handling of any claim arising out of or under the Reinsured Policies, or (B) the marketing, sale, underwriting, issuance, delivery, cancellation or administration of any of the Reinsured Policies.

“Force Majeure” shall have the meaning specified in Section 3.7(a)(iii).

“Funding Requirement” shall have the meaning specified in Section 10.2(j).

“GAAP” means U.S. generally accepted accounting principles consistently applied.

“Governmental Authority” means any foreign or national government, any state or other political subdivision thereof, and any entity exercising executive, legislative, judicial, regulatory or administrative functions of or pertaining to government.

“Inception Date” shall have the meaning specified in Section 2.1.

“Initial Notice” shall have the meaning specified in Section 12.2.

“Initial Reinsurance Premium” shall have the meaning specified in Section 4.1.

“Insolvency Fund” means any guarantee fund, insolvency fund, plan, pool, association, fund or other arrangement, however denominated, established or governed, which provides for any assessment of or payment or assumption by the Company of part or all of any claim, debt, charge, fee or other obligation of an insurer or reinsurer, or its successors or assigns, which has been declared by any competent authority to be insolvent, or which is otherwise deemed unable to meet any claim, debt, charge, fee or other obligation in whole or in part.

“Insolvency Fund Quarterly Accounting” shall have the meaning specified in Section 5.1.

“Loss” or “Losses” means the amount of liability paid or payable by the Company with respect to claims, losses, liabilities, damages, deficiencies, costs or

expenses, including without limitation, any settlements or compromises or disputed claims, arising under the Reinsured Policies.

“Manager” means Wakely and Associates, Incorporated.

“Market Value” shall have the meaning set forth in Section 10.2(j).

“Person” means any natural person, firm, limited liability company, general partnership, limited partnership, joint venture, association, corporation, trust, Governmental Authority or other entity.

“Post-Effective Date Assessments” shall have the meaning specified in Section 5.1.

“Premium Tax Credits” shall have the meaning specified in Section 6.2.

“Quarterly Accountings” shall have the meaning specified in Section 5.1.

“Quarterly Premium Tax Accounting” shall have the meaning specified in Section 5.1.

“Reinsured Policies” means the medicare supplement insurance policies issued by the Company prior to January 1, 2004 and written on the policy forms described in Schedule A or reinsured by the Company under reinsurance agreements in effect prior to January 1, 2004 (excluding reinsurance agreements with Affiliates), including renewals of any such policies.

“Reinsured Risks” shall have the meaning specified in Section 2.1.

“Response” shall have the meaning specified in Section 12.2.

3

---

“SAP” means statutory accounting practices prescribed or permitted by the Insurance Department of the State of Illinois.

“Subcontractor” shall have the meaning specified in Section 3.1(a).

“Tax DAC” means specified policy acquisition expenses capitalized and amortized under section 848 of the Code.

“Termination Date” means the effective date of any termination of this Agreement as provided in Article VIII.

“Termination Letter Agreement” means the letter agreement among the Company, the Reinsurer and certain affiliates of the Reinsurer relating to the rescission of this Agreement upon the failure of certain events to occur after the date hereof.

“Total SAP Ceded Reserves” means, as of any given date, the gross reserves of the Company calculated in accordance with SAP with respect to the Reinsured Risks, which shall consist of the sum of (A) (i) active life reserves, (ii) claim reserves (both case and incurred but not reported), (iii) unearned premium reserves, and (iv) advance premiums, less (B) due and unpaid premium receivable balances.

“Total GAAP Ceded Reserves” means, as of any given date, the gross reserves of the Company calculated in accordance with GAAP with respect to the Reinsured Risks, which shall consist of the sum of (A) (i) active life reserves (including related maintenance and loss expense reserves), (ii) claim reserves (both case and incurred but not reported), (iii) unearned premium reserves, and (iv) advance premiums, less (B) due and unpaid premium receivable balances.

“Trust Account” shall have the meaning set forth in Section 10.2(a).

“Trust Agreement” shall have the meaning set forth in Section 10.2(a).

“Trustee” shall have the meaning set forth in Section 10.2(a).

“Ultimate Net Loss” shall have the meaning specified in Section 2.3(a).

## ARTICLE II

### COVERAGE

2.1. Coverage. Upon the terms and subject to the conditions and other provisions of this Agreement, as of 12:01 a.m. Eastern Time on January 1, 2004 (the “Inception Date”), the Company hereby cedes to the Reinsurer, and the Reinsurer hereby agrees to indemnify the Company for, one hundred percent (100%) of Ultimate Net Loss incurred by the Company and unpaid as of the Inception Date (the “Reinsured Risks”).

4

---

2.2. Conditions. (a) If the Company’s liability under any of the Reinsured Policies is changed because of changes made on or after the Inception Date in the terms and conditions of the Reinsured Policies (including to any contract riders or endorsements thereto) that are required due to changes in Applicable Law, the Reinsurer will share in the change proportionately to the coinsurance share hereunder and the Company and the Reinsurer will make all appropriate adjustments to amounts due each other under this Agreement.

(b) Except as otherwise set forth in paragraph (a) above, no changes, amendments or modifications made by the Company on or after the Inception Date in the terms and conditions of the Reinsured Policies which adversely affect the liability of the Reinsurer hereunder shall be covered hereunder without the prior written approval of such changes, amendments or modifications by the Reinsurer. In the event that any such changes, amendments or modifications are made by the Company in any

Reinsured Policy without the prior written approval of the Reinsurer, this Agreement will cover Ultimate Net Loss incurred by the Company as if the non-approved changes, amendments or modifications had not been made.

2.3. Ultimate Net Loss. (a) Subject to the provisions of Sections 2.2 and 2.3(b) and the terms and conditions of this Agreement, "Ultimate Net Loss" shall mean (i) the actual Losses and Allocated Loss Adjustment Expenses payable by the Company after making deductions for all recoveries, salvage and subrogations actually recovered, (ii) premium taxes due in respect of premiums and other amounts paid on or after the Inception Date with respect to the Reinsured Policies, (iii) Insolvency Fund assessments, net of any premium tax credits of the Company arising out of any such assessments, in respect of premiums and other amounts paid on or after the Inception Date with respect to the Reinsured Policies, (iv) all amounts payable on or after the Inception Date for returns or refunds of premiums under the Reinsured Policies, (v) all liability for commission payments and other fees or compensation payable with respect to the Reinsured Policies in respect of premiums and other amounts paid on or after the Inception Date, (vi) unclaimed property liabilities and obligations arising under or related to the Reinsured Policies, and (vii) all liability for Extra Contractual Liabilities resulting from actions of the Company, the Reinsurer or any of their agents or reinsured by the Company under the Reinsured Policies, in each case only to the extent reinsurance of such liabilities is permitted by state law.

(b) All recoveries or payments received by the Company subsequent to a loss settlement under this Agreement shall be applied as if recovered or received prior to the aforesaid settlement and all necessary adjustments shall be made by the parties hereto; provided, that nothing in this Section 2.3(b) shall be construed to mean that the Reinsurer's share of the Losses and Allocated Loss Adjustment Expenses under this Agreement are not recoverable until the Company's Ultimate Net Loss has been ascertained.

2.4. Territory. The territorial limits of this Agreement shall be identical with those of the Reinsured Policies.

2.5. Ceded Reinsurance. Subsequent to the Inception Date, the Company will not enter into any reinsurance arrangements with respect to the Reinsured Policies without the prior written consent of the Reinsurer, in its sole discretion.

5

---

### ARTICLE III

#### ADMINISTRATION; GENERAL PROVISIONS

3.1. Contract Administration. (a) The Reinsurer shall provide policyholder and claims servicing with respect to the Reinsured Policies in accordance with the terms hereof. At its option, the Reinsurer may delegate such administrative duties and obligations to (i) the Manager, (ii) any other third party administrator utilized by the Company on the Closing Date, (iii) an Affiliate, or (iv) any other Person with the prior written consent of the Company, which consent shall not be unreasonably withheld (in each case, the "Subcontractor"); provided, that, except with respect to third party administrators utilized by the Company on the Closing Date, the Reinsurer also subcontracts for such service or services for its own medicare supplement business not subject to this Agreement to the Subcontractor; and provided, further, that no such subcontracting shall relieve the Reinsurer from any obligations or liabilities hereunder, and the Reinsurer shall remain responsible for all obligations or liabilities of such Subcontractor with regards to the providing of such service or services as if provided by the Reinsurer. In providing policyholder and claims servicing with respect to the Reinsured Policies, the Reinsurer (or the Subcontractor) shall handle all matters, including but not limited to the billing and collection of premiums and the defense, adjustment, settlement and payment of all claims arising under the Reinsured Policies.

(b) The Reinsurer shall provide policyholder and claims servicing with respect to the Reinsured Policies in good faith and with the care, skill, prudence and diligence of a person experienced in administering medicare supplement business. The Reinsurer shall provide policyholder and claims servicing with respect to the Reinsured Policies (i) in accordance with the terms of the Reinsured Policies, (ii) in accordance with the applicable terms of this Agreement, (iii) in compliance with Applicable Law and, subject to the foregoing, (iv) in the same manner as it conducts its own business not subject to this Agreement and (v) in accordance with the Reinsurer's administrative performance standards in effect on the date hereof, with such revisions to such standards as are no less favorable to the Company than the Reinsurer's standards in effect on the date hereof. Notwithstanding the foregoing, the parties may, from time to time, mutually develop specific and/or different standards for providing such services with respect to the Reinsured Policies.

(c) The Company shall give prompt notice to the Reinsurer of any claims, lawsuits or actions made or brought against the Company after the Inception Date arising under or in connection with the Reinsured Policies to the extent known to it and not made against or served on the Reinsurer or the Subcontractor as administrator hereunder, and shall promptly furnish to the Reinsurer copies of all pleadings in connection therewith. The Reinsurer shall assume the defense of the Company. The Reinsurer shall keep the Company fully informed of the progress of all litigation handled by the Reinsurer in which the Company is named a party. The Reinsurer shall indemnify the Company against, and hold it harmless from, all costs, expenses, and attorneys' fees incurred in connection with such defense and all damages, settlements, judgments, or awards of any kind whatsoever agreed to or assessed against the Company in connection therewith, including compensatory, consequential, exemplary, punitive, bad faith or similar or other damages, arising out of the Reinsurer's (and not the Company's)

6

---

handling of claims under the Reinsured Policies or the acts, errors, or omissions of the Reinsurer or the Subcontractor, as the case may be.

(d) In the event that, during the period of the Reinsurer's administration of the Reinsured Policies, the Reinsurer designates a new Person to administer the Reinsured Policies, the Reinsurer agrees to send to all policyholders of the Reinsured Policies a written notice prepared by the Reinsurer and reasonably acceptable to the Company to the effect that such Person has been appointed by the Company to provide administrative services. The Reinsurer shall send such notice by first class U.S. mail at a time reasonably acceptable to the Company and the Reinsurer.

3.2. Re-rating of Reinsured Policies. Subject to compliance with Applicable Law, the Reinsurer shall have the exclusive right, on behalf of the Company, to seek to increase or decrease the premium rates under the Reinsured Policies from and after the Inception Date. The Reinsurer shall bear, and shall indemnify the Company for, all costs and liabilities incurred in or arising out of seeking or effecting any premium rate changes.

3.3. Inspection. The Reinsurer shall keep accurate and complete records, files and accounts of all transactions and matters with respect to the Reinsured Policies and the administration thereof in accordance with Applicable Law and its record management practices in effect from time to time for the Reinsurer's insurance business not covered by this Agreement. The parties to this Agreement and their designated representatives may upon reasonable notice inspect, at the offices of the Reinsurer or the Company where such records are located, the papers and any and all other books or documents of the Reinsurer or the Company reasonably relating to this Agreement, including the Reinsured Policies, and shall have access to appropriate employees and representatives of the other party, in each case during normal business hours for such period as this Agreement is in effect or for as long thereafter as any rights or obligations of any party survives or the Reinsurer or the Company reasonably need access to such records for regulatory, tax or similar purposes. The information obtained shall be used only for purposes relating to the transactions contemplated under this Agreement.

3.4. Errors and Omissions. If any delay, omission, error or failure to pay amounts due or to perform any other act required by this Agreement is unintentional and caused by misunderstanding or oversight, the Company and the Reinsurer will adjust the situation to what it would have been had the misunderstanding or oversight not occurred. The party first discovering such misunderstanding or oversight, or an act resulting from such misunderstanding or oversight, will notify the other party in writing promptly upon discovery thereof, and the parties shall act to correct such misunderstanding or oversight within twenty (20) Business Days of such other party's receipt of such notice. However, this Section shall not be construed as a waiver by either party of its right to enforce strictly the terms of this Agreement.

3.5. Age, Sex and Other Adjustments. If the Company's liability under any of the Reinsured Policies is changed because of a misstatement of age or sex or any other material fact, the Reinsurer will share in the change proportionately to the coinsurance share hereunder and the Company and the Reinsurer will make all appropriate adjustments to amounts due each other under this Agreement.

7

---

3.6. Setoff. Any debts or credits, matured or unmatured, in favor of or against either the Company or the Reinsurer with respect to this Agreement or any other reinsurance agreement between the Company and the Reinsurer, are deemed mutual debts or credits, as the case may be, and shall be setoff from any amounts due to the Company or the Reinsurer hereunder, as the case may be, and only the net balance shall be allowed or paid.

3.7. Administration by Reinsurer. (a) The Company shall have the right, upon written notice to the Reinsurer, to assume from the Reinsurer the administration of the Reinsured Policies upon the occurrence of any of the following events:

- (i) A voluntary or involuntary proceeding is commenced in any jurisdiction by or against the Reinsurer for the purpose of conserving, rehabilitating or liquidating the Reinsurer;
- (ii) There is a material breach by the Reinsurer of any material term or condition of this Article III that is not cured by the Reinsurer within thirty (30) days after receipt of written notice from the Company of such breach or act (provided that the Company shall not have the right to assume such administration (A) for so long as the Reinsurer is making a good faith effort to cure such a breach, not to exceed an additional one hundred eighty (180) days or (B) during the pendency of any dispute resolution proceedings as set forth in Article XII regarding an alleged material breach); or
- (iii) The Reinsurer is unable to perform the services required under this Article III for a period of thirty (30) consecutive days for any reason, other than as a result of a Force Majeure, it being understood that nothing in this Section 3.7 shall relieve the Reinsurer from its administrative responsibilities under this Agreement. For purposes of this Agreement "Force Majeure" means any acts or omissions of any civil or military authority, acts of God, acts or omissions of the Company, fires, strikes or other labor disturbances, equipment failures, fluctuations or non-availability of electrical power, heat, light, air conditioning or telecommunications equipment, or any other act, omission or occurrence beyond the Reinsurer's reasonable control, irrespective of whether similar to the foregoing enumerated acts, omissions or occurrences.

(b) The Reinsurer shall bear all transition costs associated with an assumption of the administration of the Reinsured Policies pursuant to Section 3.7(a), including the expense of sending policyholder notices as provided in Section 3.10.

(c) In the event of the Company's assumption of the administration of the Reinsured Policies, Sections 3.8, 3.9, 3.10, 3.11 and 3.12 shall apply to the administration of the Reinsured Policies by the Company and the provisions of Article V, Article VII, Section 3.1 and the second sentence of Section 6.1 shall become inoperative.

8

---

3.8. Contract Administration. (a) In the event that the Company assumes the administration of the Reinsured Policies pursuant to Section 3.7, the Company shall provide policyholder and claims servicing with respect to the Reinsured Policies in accordance with the terms hereof including, but not limited to, the collection of premiums and other amounts due from policyholders, the payment of all Reinsured Risks and the administration of claims and disbursements, which disbursements shall be made directly by the Company. The Company shall provide policyholder and claims servicing with respect to the Reinsured Policies in good faith and with the care, skill, prudence and diligence of a person experienced in administering medicare supplement business. The Company shall provide policyholder and claims servicing with respect to the Reinsured Policies (i) in accordance with the terms of the Reinsured Policies, (ii) in accordance with the applicable terms of this Agreement, (iii) in compliance with Applicable Law and, subject to the foregoing, (iv) in the same manner as it conducts its own business not subject to this Agreement and (v) in accordance with the Company's administrative performance standards in effect on the date hereof, with such revisions to such standards as are no less favorable to the Reinsurer than such standards. Notwithstanding the foregoing, the parties may, from time to time, mutually develop specific and/or different standards for providing such services with respect to the Reinsured Policies.

(b) The Company may subcontract for the performance of any policyholder or claims servicing service or services with respect to the Reinsured Policies to (i) an Affiliate or (ii) any other Person with the prior written consent of the Reinsurer, such consent not to be unreasonably withheld; provided, that the Company also subcontracts for such service or services for its own medicare supplement business not subject to this Agreement to such subcontractor; and provided, further, that no such subcontracting shall relieve the Company from any of its obligations or liabilities hereunder, and the Company shall remain responsible for all obligations or liabilities of such subcontractor with regards to the providing of such service or services as if provided by the Company.

3.9. Claims Settlements. In the event that the Company assumes the administration of the Reinsured Policies pursuant to Section 3.7, the Company agrees that it will provide prompt notice to the Reinsurer of its intention to contest, compromise or litigate a claim with respect to a Reinsured Policy, along with copies of all pleadings and reports of investigation with respect thereto. The Reinsurer shall have the right, at its own expense, to participate jointly with the Company in the investigation, adjustment or defense of such claims. In addition, in the event that litigation arises against the Company in connection with a claim which seeks damages in excess of \$1 million or other remedies deemed material to the Reinsurer, the Reinsurer may, upon written notice to the Company, assume the defense thereof with counsel selected by the Reinsurer and reasonably satisfactory to the Company. If the Reinsurer assumes such defense, the Company shall have the right, at its own expense, to participate jointly with the Reinsurer in the defense thereof. If the Reinsurer assumes the defense of litigation, the Reinsurer shall not settle such litigation without the Company's prior written consent (which consent shall not be unreasonably withheld or delayed) unless (i) there is no finding or admission of any violation of law or any violation of the rights of any Person, (ii) such settlement would not reasonably be expected to have material adverse precedential consequences to the Company and (iii) the sole relief provided is monetary damages that are paid in full by the Reinsurer.

9

---

3.10. Notice to Policyholder. To the extent that the administration of the Reinsured Policies is assumed by the Company pursuant to Section 3.7 and the Person then administering the Reinsured Policies does not continue to administer the Reinsured Policies, the Company agrees to send to all policyholders of the Reinsured Policies a written notice to the effect that the Company will provide administrative services. The Company shall send such notice by first class U.S. mail at a time reasonably acceptable to the Company and the Reinsurer.

3.11. Expense Allowance. In the event the Company assumes the administration of the Reinsured Policies pursuant to Section 3.7, as reimbursement for expenses incurred by the Company in the providing of policyholder and claims servicing services with respect to the Reinsured Policies, the Reinsurer shall pay to the Company with respect to each calendar month ending after the Company's assumption of such administration, an expense allowance equal to the Company's actual cost of providing such administrative services plus reasonable provision for overhead expenses associated therewith.

3.12. Accounting and Settlement. (a) As soon as practicable but not more than forty (40) days following each calendar quarter ending after the Company's assumption of the administration of the Reinsured Policies pursuant to Section 3.7 (or more frequently as mutually agreed by the parties), the Company shall supply the Reinsurer with a report that shall provide financial data for such calendar quarter in the form as agreed between the parties.

(b) As soon as practicable but not more than forty (40) days following the end of each calendar quarter ending after the Company's assumption of the administration of the Reinsured Policies pursuant to Section 3.7 (or more frequently as mutually agreed by the parties), the Company shall supply the Reinsurer with reports related to the Reinsured Policies as may be reasonably requested for use in connection with the preparation of the Reinsurer's SAP financial statements or other reports prepared by the Reinsurer in compliance with its internal reporting requirements. The parties shall cooperate in good faith to establish the form for the providing of such reports.

(c) Within forty-five (45) days after the end of each calendar year ending after the Company's assumption of the administration of the Reinsured Policies pursuant to Section 3.7 (or more frequently as mutually agreed by the parties), the Company shall supply the Reinsurer with a report that shall provide financial data for such year in the form as agreed between the parties.

(d) Following any assumption by the Company of administration of the Reinsured Policies pursuant to Section 3.7, and for so long thereafter as this Agreement remains in effect, each of the parties shall periodically furnish to the other such other reports and information as may be reasonably requested by such other party for regulatory, tax or similar purposes and reasonably available to it.

(e) Following any assumption by the Company of administration of the Reinsured Policies pursuant to Section 3.7, in the event that all or any portion of any payment due either party pursuant to this Agreement becomes overdue, the portion of the amount overdue shall bear interest at an annual rate equal to the then current thirty (30) day U.S. Treasury Bill

10

---

discount rate on the date that the payment becomes overdue plus 200 basis points, for the period that the amount is overdue.

#### ARTICLE IV

##### REINSURANCE ASSET TRANSFER; CEDING COMMISSION

4.1. Initial Reinsurance Premium. As consideration for the reinsurance by the Reinsurer of the Reinsured Risks under this Agreement, on the Closing Date, the Reinsurer shall be entitled to an amount equal to one hundred percent (100%) of the Total SAP Ceded Reserves as of the close of business on the day immediately preceding the Inception Date (the "Initial Reinsurance Premium").

4.2. Additional Reinsurance Premium. As additional consideration for the Reinsurer entering into this Agreement, Reinsurer shall be entitled to 100% of all premiums and other considerations to the extent received on or after the Inception Date by the Company or the Reinsurer with respect to the Reinsured Policies, including premium receivables that were due and unpaid as of the Inception Date that were taken into account in the calculation of the Initial Reinsurance Premium.

4.3. Ceding Commission. On the Closing Date, the Company shall be entitled to a ceding commission (the "Ceding Commission") in an amount determined in accordance with Schedule B.

4.4. Amounts Due the Parties. (a) Except as otherwise specifically provided herein, all amounts due to be paid to the Company or the Reinsurer under this Agreement shall be determined on a net basis, giving full effect to Section 3.6. The net amount due the Reinsurer from the Company on the Closing Date under Section 4.1 and Section 4.3 shall consist of (i) the investment assets (the "Assets") set forth on Schedule C, which assets have a statutory book value as of the close of business on the day immediately preceding the Inception Date equal to (A) the Initial Reinsurance Premium, less (B) the Ceding Commission, less (C) an amount equal to accrued but unpaid interest on the Assets as of the close of business on the day immediately preceding the Inception Date, plus (ii) an amount equal to the investment cash flows received on the Assets between the Inception Date and the Closing Date. The Company shall pay such net amount due on the Closing Date concurrent with its delivery of the Initial Report.

(b) The Company shall deliver to the Reinsurer possession of the Assets and such bills of sale, endorsements, assignments and other good and sufficient instruments of conveyance and transfer in form and substance reasonably acceptable to the parties as shall be effective to vest in the Reinsurer all of the right, title and interest of the Company in and to the Assets. Delivery of the Assets shall be a condition precedent of reinsurance coverage hereunder.

(c) As soon as practicable but not more than forty (40) days following the end of the first calendar quarter ending after the Closing Date, the Company shall supply the Reinsurer with a report setting forth a calculation of the amount of premium and other consideration received on or after the Inception Date but prior to the Closing Date by the Company with respect to the Reinsured Policies, minus the amount of Reinsured Risks (other

11

---

than Insolvency Fund assessments and premium taxes) paid by the Company on or after the Inception Date but prior to the Closing Date. If the result of such calculation is positive, the Company shall pay to the Reinsurer, concurrent with the delivery of such report, an amount in cash equal to such positive amount. If the result of such calculation is negative, the Reinsurer shall pay to the Company, no later than thirty (30) days after receipt of the Company's report, an amount in cash equal to such negative amount.

4.5. Initial Report. A report shall be provided by the Company to the Reinsurer on the Closing Date providing the data required in Schedule D (the "Initial Report").

ARTICLE V

QUARTERLY INSOLVENCY FUND AND PREMIUM TAX ACCOUNTING

5.1. Quarterly Accountings. Within thirty (30) days after the end of each calendar quarter ending after the Closing Date (or more frequently as mutually agreed by the parties), the Company shall submit to the Reinsurer a written statement of accounting in a form and containing such information to be agreed upon by the parties hereto (each, an "Insolvency Fund Quarterly Accounting") setting forth the Insolvency Fund amounts assessed or payable to the extent that such assessments constitute Reinsured Risks (collectively, the "Post-Effective Date Assessments"). Within thirty (30) days after the last day of each calendar quarter ending after the Closing Date (or more frequently as mutually agreed by the parties), the Reinsurer shall submit to the Company a written statement of accounting in a form and containing such information to be agreed upon by the parties hereto (each, a "Quarterly Premium Tax Accounting", and together with the Insolvency Fund Quarterly Accountings, the "Quarterly Accountings") setting forth the estimated premium taxes due with respect to the Reinsured Policies as a result of premiums collected during such quarter. Concurrent with the delivery of each Quarterly Premium Tax Accounting, the Reinsurer shall remit to the Company the amount set forth on such Quarterly Premium Tax Accounting with respect to such estimated premium taxes due and the amount set forth in such Insolvency Fund Quarterly Accounting with respect to the Post-Effective Date Assessments, and any other amounts owed to the Company pursuant to this Agreement; provided, however, that any Post-Effective Date Assessments set forth in an Insolvency Fund Quarterly Accounting received by the Reinsurer less than five (5) Business Days prior to the Reinsurer's delivery of such Quarterly Premium Tax Accounting will be paid within ten (10) Business Days of receipt by the Reinsurer of such Insolvency Fund Quarterly Accounting. Each of the parties agrees to supply to the other a copy of all supporting data used in preparing the Quarterly Accountings prepared by such party. For the avoidance of doubt, the first Insolvency Fund Quarterly Accounting and Quarterly Premium Tax Accounting shall cover the period from the Inception Date through June 30, 2004.

5.2. Adjustments Regarding Quarterly Accountings. In the event that subsequent data or calculations require revision of any of the Quarterly Accountings, the required revision and appropriate payments thereunder shall be made within ten (10) Business Days after the parties hereto mutually agree as to the appropriate revision.

12

---

ARTICLE VI

CERTAIN ACTIONS BY THE COMPANY

6.1. Filings. The Company shall prepare and timely file any filings required to be made with any Governmental Authority that relate to the Company generally and not just to the Reinsured Policies, including filings with guaranty associations and filings and premium tax returns with taxing authorities. The Reinsurer shall, in a timely fashion in light of the dates such filings by the Company are required, provide to the Company all information in the possession of the Reinsurer with respect to the Reinsured Policies that may be reasonably required for the Company to prepare such filings and tax returns.

6.2. Annual Adjustment. The Company shall pay or provide to the Reinsurer the benefit of any Post-Effective Date Assessments which have been or can be applied to reduce the Company's premium tax liability ("Premium Tax Credits"). The Company shall provide to the Reinsurer by March 15 of each year a statement of the amount (the "Annual Adjustment") of (i) premium taxes due with respect to premiums collected during the prior calendar year (to the extent that such premium taxes constitute Reinsured Risks), less (ii) estimated premium taxes paid by the Reinsurer to the Company with respect to such premiums under the provisions of Article V, less (iii) Premium Tax Credits for the prior calendar year. By March 30 of each year the Reinsurer shall pay to the Company the Annual Adjustment, if a positive amount, and the Company will pay to or credit the Reinsurer the Annual Adjustment, if a negative amount.

ARTICLE VII

REGULATORY MATTERS AND REPORTING

7.1. Regulatory Compliance and Reporting. The Reinsurer shall provide to the Company such information with respect to the Reinsured Policies as is required to satisfy all current and future informational reporting, prior approval and any other requirements imposed by any Governmental Authority. Upon the reasonable request of the Company, the Reinsurer shall timely prepare such reports and summaries, including statistical summaries, as are necessary or useful to satisfy any requirements imposed by a Governmental Authority upon the Company with respect to the Reinsured Policies. In addition, the Reinsurer, upon the reasonable request of the Company shall promptly provide to the Company copies of all existing records relating to the Reinsured Policies (including, with respect to records maintained in machine readable form, hard copies) that are necessary to satisfy such requirements. All copies of records furnished in the ordinary course of business shall be furnished by the Reinsurer at the Reinsurer's cost. Any extraordinary costs reasonably incurred by the Reinsurer in response to requests from the Company shall be reimbursed by the Company. Among other responsibilities:

- (a) The Reinsurer shall promptly prepare and furnish to Governmental Authorities all reports and related summaries (including, without limitation, statistical summaries), certificates of compliance and other reports required or requested by a Governmental Authority.

13

- 
- (b) The Reinsurer shall assist the Company and cooperate with the Company in doing all things necessary, proper or advisable, in the most expeditious manner practicable in connection with any and all market conduct or other Governmental Authority examinations relating to the Reinsured Policies.

7.2. Reporting and Accounting. The Reinsurer shall assume the reporting and accounting obligations set forth below:

- (a) As soon as practicable but not more than forty (40) days after the end of each calendar quarter ending after the Closing Date (or more frequently as mutually agreed by the parties), the Reinsurer shall timely provide to the Company reports and summaries of transactions (and, upon request of the Company, detailed supporting records) related to the Reinsured Policies as may be reasonably required for use in connection with the preparation of the Company's statutory financial statements, tax returns and other required financial reports and to comply with the requirements of the regulatory authorities having jurisdiction over the Company, including all premium written and earned and all Losses and Allocated Loss Adjustment Expenses reserved, paid, and outstanding. The parties shall cooperate in good faith to establish the manner for the providing of such reports.
- (b) The Reinsurer shall timely provide to the Company reports or summaries (and, upon the request of the Company, detailed supporting records therefor) related to the payment of commissions under the Reinsured Policies.
- (c) As soon as practicable but not more than forty (40) days after the end of each calendar quarter ending after the Closing Date (or more frequently as mutually agreed by the parties), the Reinsurer shall report to the Company the amount of statutory reserves that the Company is required to maintain in connection with the Reinsured Risks as of the quarter end.

- (d) The Reinsurer shall timely provide notice to the Company of any changes in the reserve methodology used by the Reinsurer in calculating statutory reserves for the Reinsured Policies.
- (e) Within forty-five (45) days after each calendar year end (or such longer time as may be agreed by the parties) that this agreement is in effect, beginning with year end 2004, the Reinsurer shall cause its appointed actuary to provide to the Company (a) an opinion as to the adequacy of statutory reserves for the Reinsured Policies, prepared according to accepted actuarial standards of practice, and as otherwise required for regulatory reporting purposes and (b) an analysis which reasonably supports such opinion.

14

---

7.3. Additional Reports and Updates. For so long as this Agreement remains in effect, each party shall periodically furnish to the other such other reports and information as may be reasonably required by such other party for regulatory, tax or similar purposes and reasonably available to it.

## ARTICLE VIII

### DURATION AND TERMINATION

8.1. Duration. Except as otherwise provided herein, this Agreement shall be unlimited in duration.

8.2. Reinsurer's Liability. The Reinsurer's liability with respect to the Reinsured Risks will terminate on the earliest of: (i) the date the Company's liability with respect to the Reinsured Risks is terminated and all amounts due the Company from the Reinsurer with respect to such Reinsured Risks are paid to the Company by or on behalf of the Reinsurer; and (ii) the date this Agreement is terminated upon the written agreement of the parties.

8.3. Notice of Termination. Upon the termination of the Reinsurer's liability with respect to the Reinsured Risks referred to in Section 8.2 above, the parties shall mutually give the Trustee written notice of their intention to terminate the Trust Account.

## ARTICLE IX

### INSOLVENCY

9.1. Payments. In the event of the insolvency of the Company, the reinsurance payable by the Reinsurer hereunder shall be payable directly to the Company or to its domiciliary liquidator or receiver on the basis of the liability of the Reinsurer under the contract or contracts reinsured, without diminution because of the insolvency of the Company. It is agreed and understood, however, that (i) in the event of the insolvency of the Company, the Reinsurer shall be given written notice of the pendency of a claim against the insolvent Company on a Reinsured Policy within a reasonable time after such claim is filed in the insolvency proceeding and (ii) during the pendency of such claim the Reinsurer may investigate such claim and interpose, at its own expense, in the proceeding where such claim is to be adjudicated any defenses which it may deem available to the Company or its domiciliary liquidator, receiver or statutory successor.

9.2. Expenses. It is further understood that any expense thus incurred by the Reinsurer pursuant to Section 9.1 shall be chargeable, subject to court approval, against the insolvent Company as part of the expense of liquidation to the extent of a proportionate share of the benefit which may accrue to the Company solely as a result of the defense undertaken by the Reinsurer. Where two or more assuming reinsurers are involved in the same claim and a majority in interest elect to interpose defenses to such claim, the expense shall be apportioned in

15

---

accordance with the terms of this Agreement as though such expense had been incurred by the Company.

## ARTICLE X

### SECURITY AND REINSURANCE CREDIT

10.1. Reinsurance Credit. Notwithstanding any other provision of this Agreement to the contrary, if the Reinsurer becomes unauthorized or otherwise unaccredited as an insurer or reinsurer in any U.S. jurisdiction to which the Company must provide statutory statements of financial condition such that the Company will not obtain full statutory financial statement credit for reinsurance in such state for the reinsurance provided under this Agreement, the Reinsurer, upon the request of the Company, will establish, at the Reinsurer's sole cost and option, trust accounts for the benefit of the Company, letters of credit, or other acceptable alternatives necessary to permit the Company to obtain such full statutory financial statement credit for such reinsurance in all applicable jurisdictions. The Company shall cooperate with the Reinsurer to take such steps. In addition, in such event, the Reinsurer agrees to amend this Agreement to the extent required under Applicable Law in order to provide the Company with such full statutory financial statement credit.

10.2. Trust. (a) On the Closing Date, the Reinsurer shall enter into a trust agreement in the form attached as Schedule E (the "Trust Agreement") and establish a trust account (the "Trust Account") for the benefit of the Company with respect to the Reinsured Risks with a bank (the "Trustee") acceptable to the Director of Insurance of the State of Illinois, the Superintendent of Insurance of the State of New York and the Company.

(b) The Reinsurer agrees to deposit, and maintain in the Trust Account, assets to be held in trust by the Trustee for the benefit of the Company as security for the payment of the Reinsurer's obligations to the Company under this Agreement.

(c) The parties agree that the assets so deposited shall be valued according to their current fair market value and shall consist only of cash (United States legal tender), certificates of deposit (issued by a United States bank and payable in United States legal tender), and other admitted assets of a character, maturity, and value to fulfill the intent of this Agreement; provided that such investments are issued by an institution that is not the parent, subsidiary or affiliate of either the Company or the Reinsurer; and provided, further that such assets are of the type specified in paragraphs (1), (2), (3), (8) and (10) of Section 1404(a) of the New York Insurance Law ("Eligible Securities").

(d) The Reinsurer, prior to depositing assets with the Trustee, shall execute all assignments and endorsements in blank, or transfer legal title to the Trustee of all shares, obligations or any other assets requiring assignments, in order that the Company, or the Trustee upon direction of the Company, may whenever necessary negotiate any such assets without consent or signature from the Reinsurer or any other entity.

(e) All settlements of account under the Trust Agreement between the Company and the Reinsurer shall be made in cash or its equivalent.

16



---

(f) The Reinsurer and the Company agree that the assets in the Trust Account may be withdrawn by the Company at any time, notwithstanding any other provisions in this Agreement, and shall be applied and utilized by the Company (or any successor of the Company by operation of law, including, without limitation, any liquidator, rehabilitator, receiver or conservator of the Company), on the basis of the liability of the Company under the Reinsured Policies, without diminution because of the insolvency of the Company or the Reinsurer, only for the following purposes:

- (i) to reimburse the Company for the Reinsurer's share of premiums returned to owners of Reinsured Policies because of cancellation of the Reinsured Policies;
- (ii) to reimburse the Company for the Reinsurer's share of policy benefits or losses paid by the Company pursuant to the provisions of the Reinsured Policies;
- (iii) to fund an account with the Company in an amount at least equal to the deduction, for reinsurance ceded, from the Company's liabilities ceded under this Agreement. Such amount shall include, but not be limited to, amounts for policy reserves, reserves for claims and losses incurred (including losses incurred but not reported), loss and loss adjustment expenses, and unearned premiums; and
- (iv) to pay any other amounts which the Company claims are due under this Agreement.

(g) The Reinsurer shall have the right to seek the Company's approval to withdraw all or any part of the assets from the Trust Account and transfer such assets to the Reinsurer, provided that:

- (i) the Reinsurer shall, at the time of withdrawal, replace the withdrawn assets with other assets of a type permitted hereunder having a market value equal to the market value of the assets withdrawn, so as to maintain the Trust Account in the required amount, or
- (ii) after such withdrawal and transfer, the market value of the Trust Account is no less than 102% of the required amount.

In the event that the Reinsurer seeks the Company's approval hereunder, the Company shall not unreasonably or arbitrarily withhold its approval.

(h) In the event that the Company withdraws assets from the Trust Account for the purposes set forth in Section 10.2(f)(i), (ii) or (iii) above in excess of actual amounts required to meet the Reinsurer's obligations to the Company, or in excess of amounts determined pursuant to a final accounting between the Company and the Reinsurer to be due under Section 10.2(f)(iv) above, the Company will return such excess to the Reinsurer, plus interest at the average prime rate of interest applicable to the period during which the amounts were held pursuant to Section 10.2(f)(iii) above.

17

---

(i) The initial deposit to the Trust Account shall be made on the Closing Date and shall consist of the Assets plus an amount equal to the excess, if any, of the Total SAP Ceded Reserves as of the Inception Date over the Market Value of the Assets as of the Inception Date.

(j) The aggregate fair market value of the assets held in the Trust Account (the "Market Value") shall at all times be at least equal to an amount (the "Funding Requirement") equal to the sum of Total SAP Ceded Reserves and any additional reserves attributable to the Reinsured Risks that arise as a result of regulatory asset adequacy analysis requirements of the Reinsurer. The amount of the Trust Account shall be adjusted on a quarterly basis so as to equal the Funding Requirement. On a quarterly basis, the Reinsurer shall promptly prepare a specific statement of the Funding Requirement, together with a statement of the Market Value of the assets in the Trust Account, in each case as of the end of the quarter, and deliver such report to the Company. If the statement shows that the Funding Requirement exceeds 100% of the balance of the Trust Account as of the statement date, the Reinsurer shall, within ten (10) Business Days after delivery of such notice of excess, secure delivery to the Trustee of additional cash or Eligible Securities having a current fair market value equal to such difference. If the statement shows that the balance of the Trust Account as of the statement date exceeds an amount equal to 102% of the Funding Requirement as of such date, the Company shall, within ten (10) Business Days after receipt of such statement from the Reinsurer, deliver a notice of withdrawal to the Trustee directing the Trustee to withdraw from the Trust Account and deliver to the Reinsurer assets from the Trust Account having a current fair market value equal to such excess amount.

## ARTICLE XI

### DEFERRED ACQUISITION COSTS

11.1. Tax DAC Information Sharing. To ensure consistency in their respective Tax DAC calculations for tax purposes, the Company and the Reinsurer will exchange information pertaining to the amount of net consideration under this Agreement each year. The Company will submit a schedule to the Reinsurer by February 28 of each year presenting its calculation of the net consideration for the preceding taxable year. The Reinsurer may contest the calculation by providing to the Company and alternative calculation in writing within thirty (30) days of receipt of the Company's schedule. The Company and the Reinsurer will act in good faith to resolve any differences in the schedule of calculations within thirty (30) days of receipt of the alternative calculation to ensure consistent amounts are reported on the respective tax returns for the preceding tax year.

## ARTICLE XII

### DISPUTE RESOLUTION

12.1. General Provisions. (a) Any dispute, controversy or claim arising out of or relating to this Agreement or the validity, interpretation, breach or termination thereof (a

18

---

"Dispute"), shall be resolved in accordance with the procedures set forth in this Article XII, which shall be the sole and exclusive procedures for the resolution of any such Dispute unless otherwise specified below.

(b) Commencing with the request contemplated by Section 12.2, all communications between the parties or their representatives in connection with the attempted resolution of any Dispute, including any mediator's evaluation referred to in Section 12.3, shall be deemed to have been delivered in furtherance of a Dispute settlement and shall be exempt from discovery and production, and shall not be admissible in evidence for any reason (whether as an admission or otherwise), in any arbitral

or other proceeding for the resolution of the Dispute.

(c) In connection with any Dispute, the parties expressly waive and forego any right to (i) punitive, exemplary, statutorily-enhanced or similar damages in excess of compensatory damages, and (ii) trial by jury.

(d) The specific procedures set forth below, including but not limited to the time limits referenced therein, may be modified by agreement of the parties in writing.

(e) All applicable statutes of limitations and defenses based upon the passage of time shall be tolled while the procedures specified in this Article XII are pending. The parties will take such action, if any, required to effectuate such tolling.

12.2. Consideration by Senior Executives. If a Dispute is not resolved in the normal course of business at the operational level, the parties shall attempt in good faith to resolve such Dispute by negotiation between executives who hold, at a minimum, the office of President and CEO of the respective business entities involved in such Dispute. Either party may initiate the executive negotiation process by providing a written notice to the other (the "Initial Notice"). Fifteen (15) days after delivery of the Initial Notice, the receiving party shall submit to the other a written response (the "Response"). The Initial Notice and the Response shall include (i) a statement of the Dispute and of each party's position, and (ii) the name and title of the executive who will represent that party and of any other person who will accompany the executive. Such executives will meet in person or by telephone within thirty (30) days of the date of the Initial Notice to seek a resolution of the Dispute.

12.3. Mediation. If a Dispute is not resolved by negotiation as provided in Section 12.2 within forty-five (45) days from the delivery of the Initial Notice, then either party may submit the Dispute for resolution by mediation pursuant to the CPR Institute for Dispute Resolution (the "CPR") Model Mediation Procedure as then in effect. The parties will select a mediator from the CPR Panels of Distinguished Neutrals, but such mediator must have prior U.S. reinsurance experience either as a lawyer or as a present or former officer or management employee of a reinsurance company, but not of the Company, or the Reinsurer, or any of their respective affiliates. Either party at commencement of the mediation may ask the mediator to provide an evaluation of the Dispute and the parties' relative positions.

12.4. Arbitration. (a) If a Dispute is not resolved by mediation as provided in Section 12.3 within thirty (30) days of the selection of a mediator (unless the mediator chooses to

19

---

withdraw sooner), either party may submit the Dispute to be finally resolved by arbitration pursuant to the CPR Rules for Non-Administered Arbitration as then in effect (the "CPR Arbitration Rules"). The parties consent to a single, consolidated arbitration for all known Disputes existing at the time of the arbitration and for which arbitration is permitted.

(b) The neutral organization for purposes of the CPR Arbitration Rules will be the CPR. The arbitral tribunal shall be composed of three arbitrators who are each experienced in the U.S. reinsurance business, of whom each party shall appoint one in accordance with the "screened" appointment procedure provided in Rule 5.4 of the CPR Arbitration Rules. The non-party appointed arbitrator must have prior U.S. reinsurance experience as a present or former officer or management employee of a reinsurance company, but not of the Company, or the Reinsurer, or any of their respective affiliates. The arbitration shall be conducted in New York City. Each party shall be permitted to present its case, witnesses and evidence, if any, in the presence of the other party. A written transcript of the proceedings shall be made and furnished to the parties. The arbitrators shall determine the Dispute in accordance with the law of Illinois, without giving effect to any conflict of law rules or other rules that might render such law inapplicable or unavailable, and shall apply this Agreement according to its terms, provided that the provisions relating to arbitration shall be governed by the Federal Arbitration Act, 9 U.S.C. §§ 1 et seq. The arbitral tribunal shall endeavor to render its award or order resulting from any arbitration within forty-five (45) days following the termination of the arbitration proceedings.

(c) The parties agree to be bound by any award or order resulting from any arbitration conducted hereunder and further agree that judgment on any award or order resulting from an arbitration conducted under this Section may be entered and enforced in any court having jurisdiction thereof.

(d) Except as expressly permitted by this Agreement, no party will commence or voluntarily participate in any court action or proceeding concerning a Dispute, except (i) for enforcement as contemplated by Section 12.4(c) above, (ii) to restrict or vacate an arbitral decision based on the grounds specified under applicable law, or (iii) for interim relief as provided in paragraph (e) below. For purposes of the foregoing the parties hereto submit to the non-exclusive jurisdiction of the courts of the State of New York.

(e) In addition to the authority otherwise conferred on the arbitral tribunal, the tribunal shall have the authority to make such orders for interim relief, including injunctive relief, as it may deem just and equitable. Notwithstanding paragraph (d) above, each party acknowledges that in the event of any actual or threatened breach of certain of the provisions of this Agreement, the remedy at law would not be adequate, and therefore injunctive or other interim relief may be sought immediately to restrain such breach. If the tribunal shall not have been appointed, either party may seek interim relief from a court having jurisdiction if the award to which the applicant may be entitled may be rendered ineffectual without such interim relief. Upon appointment of the tribunal following any grant of interim relief by a court, the tribunal may affirm or disaffirm such relief, and the parties will seek modification or rescission of the court action as necessary to accord with the tribunal's decision.

(f) Each party will bear its own attorneys' fees and costs incurred in connection with the resolution of any Dispute in accordance with this Article XII.

20

---

## ARTICLE XIII

### PRIVACY REQUIREMENTS

13.1. Privacy Requirements. In providing the administrative services provided for under this Agreement, and in connection with maintaining, administering, handling and transferring the data of the policyholders and other recipients of benefits under the Reinsured Policies, the Reinsurer shall, and shall cause its Affiliates and any permitted Subcontractor to, comply with all confidentiality and security obligations applicable to them in connection with the collection, use, disclosure, maintenance and transmission of personal, private, health or financial information about individual policyholders or benefit recipients, including the provisions of privacy policies under which such information was gathered, those laws currently in place and which may become effective during the term of this Agreement, including the Gramm-Leach-Bliley Act, the Health Insurance Portability and Accountability Act of 1996 and any other Applicable Laws. The Reinsurer shall entitle the Company and its agents and representatives, the Commissioner of Health and Human Services and such other Governmental Authorities, to the extent required by Applicable Law, to audit the Reinsurer's compliance herewith. The Reinsurer shall also enable individual subjects of personally identifiable information, upon request from such individuals, to review and correct information maintained by the Reinsurer about them, and to restrict use of such information. The Reinsurer shall promptly report to the Company any violation of this provision of which the Reinsurer becomes aware. Unless required by Applicable Law, the Reinsurer shall not during the term of this Agreement, modify the privacy

policies under which information utilized by the Reinsurer in administering the Reinsured Policies is gathered, without the Company's prior written consent, which consent shall not be unreasonably withheld. The parties hereto agree to comply with the terms of the Business Associate Addendum attached hereto.

#### ARTICLE XIV

##### MISCELLANEOUS PROVISIONS

14.1. Headings and Schedules. Headings used herein are not a part of this Agreement and shall not affect the terms hereof. The attached Schedules are a part of this Agreement.

14.2. Notices. All notices, requests, demands and other communications under this Agreement must be in writing and will be deemed to have been duly given or made as follows: (a) if sent by registered or certified mail in the United States return receipt requested, upon receipt; (b) if sent by reputable overnight air courier, two business days after mailing; (c) if sent by facsimile transmission, with a copy mailed on the same day in the manner provided in (a) or (b) above, when transmitted and receipt is confirmed by telephone; or (d) if otherwise actually personally delivered, when delivered, and shall be delivered as follows:

21

---

If to the Company:

Union Fidelity Life Insurance Company  
200 North Martingale Road  
Schaumburg, IL 60173-2096  
Facsimile: (847) 330-3404  
Attention: Chief Financial Officer

With a copy to:

Union Fidelity Life Insurance Company  
200 North Martingale Road  
Schaumburg, IL 60173-2096  
Facsimile: (847) 605-3044  
Attention: General Counsel

If to the Reinsurer:

Federal Home Life Insurance Company  
6620 West Broad Street  
Richmond, VA 23230  
Facsimile: (804) 662-2414  
Attention: Chief Executive Officer

With a copy to:

Federal Home Life Insurance Company  
700 Main Street  
Lynchburg, VA 24504  
Facsimile: (434) 948-5819  
Attention: General Counsel

or to such other address or to such other Person as either party may have last designated by notice to the other party.

14.3. Successors and Assigns. This Agreement shall be binding upon and inure to the benefit of the parties hereto and their respective successors, permitted assigns and legal representatives. Neither this Agreement, nor any right or obligation hereunder, may be assigned by any party without the prior written consent of the other party hereto. Any assignment in violation of this Section 14.3 shall be void and shall have no force and effect. Nothing in this Section 14.3 shall be construed to prohibit the Reinsurer from retroceding all or any portion of the business reinsured hereunder.

14.4. Execution in Counterpart. This Agreement may be executed by the parties hereto in any number of counterparts, and by each of the parties hereto in separate counterparts, each of which counterparts, when so executed and delivered, shall be deemed to be an original, but all such counterparts shall together constitute but one and the same instrument.

22

---

14.5. Currency. Whenever the word "Dollars" or the "\$" sign appear in this Agreement, they shall be construed to mean United States Dollars, and all transactions under this Agreement shall be in United States Dollars.

14.6. Amendments. This Agreement may not be changed, altered or modified unless the same shall be in writing executed by the Company and the Reinsurer.

14.7. Governing Law. This Agreement will be construed, performed and enforced in accordance with the laws of the State of Illinois without giving effect to its principles or rules of conflict of laws thereof to the extent such principles or rules would require or permit the application of the laws of another jurisdiction.

14.8. Entire Agreement; Severability. (a) This Agreement and the Termination Letter Agreement constitute the entire agreement between the parties hereto relating to the subject matter hereof and supersede all prior and contemporaneous agreements, understandings, statements, representations and warranties, negotiations and discussions, whether oral or written, of the parties and there are no general or specific warranties, representations or other agreements by or among the parties in connection with the entering into of this Agreement or the subject matter hereof except as specifically set forth or contemplated herein or in the Termination Letter Agreement.

(b) If any provision of this Agreement is held to be void or unenforceable, in whole or in part, (i) such holding shall not affect the validity and enforceability of the remainder of this Agreement, including any other provision, paragraph or subparagraph, and (ii) the parties agree to attempt in good faith to reform such void or unenforceable provision to the extent necessary to render such provision enforceable and to carry out its original intent.

14.9. No Waiver: Preservation of Remedies. No consent or waiver, express or implied, by any party to or of any breach or default by any other party in the performance by such other party of its obligations hereunder shall be deemed or construed to be a consent or waiver to or of any other breach or default in the performance of obligations hereunder by such other party hereunder. Failure on the part of any party to complain of any act or failure to act of any other party or to declare any other party in default, irrespective of how long such failure continues, shall not constitute a waiver by such first party of any of its rights hereunder. The rights and remedies provided are cumulative and are not exclusive of any rights or remedies that any party may otherwise have at law or equity.

14.10. Cooperation. Each party hereto shall cooperate fully with the other in all reasonable respects in order to accomplish the objectives of this Agreement including making available to each their respective officers and employees for interviews and meetings with Governmental Authorities and furnishing any additional assistance, information and documents as may be reasonably requested by a party from time to time.

14.11. Third Party Beneficiary. Nothing in this Agreement will confer any rights upon any Person that is not a party or a successor or permitted assignee of a party to this Agreement.

23

14.12. Tax Exception to Any Confidentiality. Notwithstanding anything to the contrary set forth herein or in any other agreement to which the parties hereto are parties or by which they are bound, any obligations of confidentiality contained herein and therein, as they relate to the transactions, shall not apply to the federal tax structure or federal tax treatment of the transactions, and each party hereto (and any employee, representative, or agent of any party hereto) may disclose to any and all persons, without limitation of any kind, the federal tax structure and federal tax treatment of the transactions. The preceding sentence is intended to cause the transactions to be treated as not having been offered under conditions of confidentiality for purposes of Section 1.6011-4(b)(3) (or any successor provision) of the Treasury Regulations promulgated under Section 6011 of the Internal Revenue Code of 1986, as amended, and shall be construed in a manner consistent with such purpose. In addition, each party hereto acknowledges that it has no proprietary or exclusive rights to the federal tax structure of the transactions or any federal tax matter or federal tax idea related to the transactions.

14.13. Interpretation. Wherever the words “include,” “includes” or “including” are used in this Agreement, they shall be deemed to be followed by the words “without limitation.”

14.14. Survival. Article XII and XIV shall survive termination of this Agreement.

24

IN WITNESS WHEREOF, the parties hereto have caused this Agreement to be executed by their duly authorized representatives.

UNION FIDELITY LIFE INSURANCE COMPANY

By /s/ GLENN JOPPA  
Name: Glenn Joppa  
Title: Senior Vice President and Secretary

FEDERAL HOME LIFE INSURANCE COMPANY

By /s/ VICTOR C. MOSES  
Name: Victor C. Moses  
Title: Senior Vice President

25

SCHEDULE A

POLICY FORMS

FTW Block  
POLICY FORM

<b>FORM NUMBER</b>	<b>TITLE/DESCRIPTION</b>
1-0262-SC	Medicare — Standard Plan A
1-0362	Medicare — Standard Plan A (excluding policies issued in New York)
1-0363	Medicare — Standard Plan B (excluding policies issued in New York)
1-0364	Medicare — Standard Plan E (excluding policies issued in New York)
1-0365	Medicare Supplement-Standard Plan E
1-0373	Medicare SELECT — Plan C
108350-TX (Rev)	Medicare Supplement
109 REV. NJ	Monthly Cash Benefit Rider
1-0990	Medicare Supplement
1-1041 Cert.	Medicare Supplement Cert.
1-1042 Cert.	Medicare Supplement Cert.

1-1051 Cert.	Medicare Supplement Cert.
1-1053-Cert.	Medicare Supplement Cert.
1-1061 Cert.	Medicare Supplement Cert.
1-1062 Cert.	Medicare Supplement Cert.
1-107	Weekly Cash Benefit Rider
1-1081 Cert.	Medicare Supplement Cert.
1-1082 Cert.	Medicare Supplement Cert.
1-109 REV.	Monthly Cash Benefit Rider
1-110	Monthly Cash Benefit Rider
1-1101-Cert. Rev.	Group Medicare Supplement
1-117 REV.	Weekly Cash & Recuperation Rdr
1-119 Rev.	Weekly Cash & Recuperation Rdr
1-1251 Cert.	Medicare Supplement Rider
1-1263 Cert.	Medicare Part B Rider
1-1300 Cert.	Medicare Part A Rider
1-1301 Cert.	Hospital Indemnity Rider
1-1310 Cert.	Medicare Part B Increase Rider
1-1411 Cert.	Out of Hospital Expense Rider
1-1481 Cert.	Nurse At Home Rider
1-1550 Cert.	Doctor Visit Rider
1-1560 Cert. (REV.)	Skilled Nursing Care Rider
1-1571 Cert.	Skilled Nursing Facility Rider
1-1572 Cert. Rev.	Nursing Facility Rider
1-1580	Skilled Nursing Care Rider
1-1581 Cert.	Prescription Drug Rider
1-1582 Cert.	Prescription Drug Rider
1-1594 Cert.	Medicare Part B Rider
1-159-47 (Rev. 4/75)	Accidental D & D Rider

---

1-1602 Cert.	After Hospital Rider
1-1630 Cert. REV	Prescription Drug Rider
1-1711 Cert.	Medicare Supplement Cert.
1-1712 Cert.	Medicare Supplement Cert.
1-1890-00	Lifetime Hospital Indemnity
1-1970 Cert.	Prescription Drug Rider
1-2091 Cert.	Group Long Term Care
1-2271-MT	Medicare Supplement
1-2310	Elder Care Hospital & SNF Policy
1-2310-04 REV 878	Elder Care/SNF Med Supp
1-2310-09	Elder Care Hospital & SNF Policy
1-2310-12(Rev. 10/76)	Elder Care Hospital & SNF Policy
1-2310-22	Elder Care Hospital & SNF Policy
1-2310-49	Elder Care Hospital & SNF Policy
1-2540-09	Hospital Income/Medicare Supp
1-2540-17	Hospital Income/Medicare Supp
1-2550-24	Hospital Income/Medicare Supp
1-297	Surgical Benefit Rider
1-297-09 (REV. 2/75)	Surgical Benefit Rider
13700	In Hospital Medicare Supplement
1-3700	In Hospital Medicare Supplement
1-4021	Medicare Part A Rider
1-4261	Medicare Part B Rider
1-4263-MD	Medicare Part B Rider
1-4281 Rev.	Skilled Nursing Facility Rider
1-4291-CA	Prescription Drug Rider
1-4310	Part B Medicare Rider
1-4370-09	Cash Benefit Rider
1-4430-00	Intensive Care Unit Benefit Rider
1-4440 Cert.	Medicare Part B Rider
1-4450	Elder Care SNF Rider
1-4470	Cancer Increase Rider
1-454-47 (Rev. 4/75)	Weekly — After Hospital Cash Rdr
1-4560	Out Of Hospital Expense Rider
1-4690	Accidental D & D Rider
1-4700	Cash Benefit Rider
1-4730-AL/PX	Medical Surgical Rider
1-4810 Cert.	Accidental D & D Rider
1-4840 Cert. (Rev)	Hospital Indemnity Rider
1-4850 Cert.	Skilled Nursing Rider
1-4860 Cert. Rev.	Nursing Facility Rider
1-5081 Cert.	Nursing Facility Rider
1-5101 Cert.	In Hospital Medicare Part B Rider
1-5111 Cert.	Ambulance & Nursing Service Rdr
1-5131-Cert.	Outpatient Medicare Part B Rider

---

1-5141 Cert.	Prescription Drug rider
1-5151-Cert.	Nursing Facility Rider
1-5161-Cert.	Hospital Cash Rider
1-5171-Cert.	Ambulance & Nursing Service Rdr
1-5181-Cert.	Prescription Drug Rider
1-5191-Cert.	Nurse At Home Rider
1-5201-Cert.	Medicare Part B Rider
1-5501-Cert.	Accident Outpatient Rider
1-5502 Cert.	Prescription Drug Rider
1-5600 Cert.	Intensive Care Unit Rider
1-5640-99	Nurse At Home Rider
1-5720 Cert.	Ambulance & Nurse Rider
1-5730 Cert.	Prescription Drug Rider
1-5741 Cert.	Outpatient Rider
1-5751 Cert.	Hospital Benefit Rider
1-5771 Cert.	Medical Surgical Benefit Rider
1-5781 Cert. (REV)	Intensive Care & Ambulance Rdr
1-5791 Cert.	Prescription Drug Rider
1-5830-Cert.	Nurse At Home Rider
1-5831 Cert. (REV)	Nurse At Home Rider
1-5841-MD	Accident Hospital Indemnity Rdr
1-5880 Cert. (REV)	Out of Hospital Rider
159	Accidental D & D Rider
1-614 TX (REV. 1/73)	Elder Care I
1-615 (REV. 1/74)	Elder Care II
1-616 (REV. 1/73)	Elder Care III
1-618	In Hospital Medicare Supplement
1-619-TX	Medicare Supplement
1-6440 Cert.	In Hospital Medicare Supplement
1-6660-Cert.	Medicare Supplement Certificate
1-6811 CERT.	Group Medicare Supplement
1-6860 CERT	Medicare Supplement Certificate
1-8001-KS	Medicare Supplement
1-8032	Medicare Supplement One (1)
1-8033	Medicare Supplement Two (2)
1-8034	Medicare Supplement Three (3)
1-8101-OR	Medicare Supplement
1-8111 Cert.	Group Home Health Care
1-8260 Cert.	Group Medicare Supplement
1-8340	Medicare Supplement
1-8350	Medicare Supplement
1-8360	Medicare Supplement
1-8370-MI (Rev.)	Medicare Supplement
1-8470 Cert. (REV.)—R	Medical Surgical Rider
1-8480 Cert.—BR	Medical Surgical Rider
1-8541	Group Medicare Supplement

---

1-8550 Cert.	Group Medicare Supplement
1-8960-Cert.	Group Nursing Care
1-8991-AR (Rev.)	Nursing Care Insurance
1-9000-Cert	Group Medicare Supplement
1-9001 Cert.	Comprehensive Long Term Care
1-9010 Cert.	Skilled Nursing Facility
1-919 (Clf.) REV.	Elder Hospital Care
1-9260 Cert.	Medicare Supplement
1-9270 Cert.	Medicare Supplement
1-9280 Cert.	Medicare Supplement
1-9290 Cert.	Medicare Supplement
19362	Medicare — Standard Plan A
19363	Medicare — Standard Plan B
19364	Medicare — Standard Plan E
1-9940 Cert. (3/84)	Group Nursing Home
1-9960 Cert. Rev	Group Nursing Facility
3-1130	Medicare Supplement
3-4630	Nursing Home Rider
3-9080 Cert.	Medicare Supplement
3-9980 Cert.	Medicare Supplement
454-TX (Rev.)	Weekly — After Hospital Cash Rdr
455-48	Medical Surgical Rider
468	Comprehensive Health Policy
498	Medicare Benefit Endorsement
6-0940	Medicare — Standard Plan F
701 Cert.	Dividend Hospital Accident Cert
CAL-8201	Medicare Supplement

CAL-8221	Medicare Supplement
CAL-8311	Medicare Supplement
CAL-8321	Medicare Supplement
DR 1 2118	Medicare Supplement
DR 1-2162	Medicare Supplement
DR 1-2166	Medicare Supplement
DR 1-2970	Skilled Nursing Facility
DR 1-7920	Elder Care Hospital & SNF Policy
DR1-2101	Elder Care III
DR1-2111	Elder Care Hospital & SNF Policy
DR1-2701-FL	Medicare Supplement
DR1-2711-FL	Medicare Supplement
DR1-2960	Elder Care Hospital & SNF
DR1-4170	Skilled Nursing Facility Rider
DR1-4180	Hospital Cash Benefit Rider
DR1-4190	In Hospital Medicare Part B Rider
DR1-4195	In Hospital Medical Surgical Rider
DR1-4200	Ambulance & Nursing Service Rdr
DR1-4210	Nurse At Home Benefit Rider

---

DR1-4230	Outpatient Medicare Part B Rider
DR1-4235	Outpatient Expense Rider
DR1-4240	Prescription Drugs Rider
DR1-4551-MN	Medicare Part A Deductible Rider
DR1-5011 Rev.	Skilled Nursing Rider
DR1-5031-FL	In Hospital Medicare Part B Rider
DR1-5041	Outpatient Medicare Part B Rider
DR1-5271	In Hospital Medical Surgical Rider
DR1-7120-04	Travel & Pedestrian A D Rider
DR1-7150	Elder Care Hospital & SNF Policy
DR1-7160	Elder Care I
DR1-7160-04	Elder Hospital Care I
DR1-7160-22	Elder Care I
DR1-7160-40	Elder Care I
DR1-7420	Cancer Benefit Rider
DR1-7420-04	Cancer Benefit Rider
DR1-7420-09	Cancer Benefit Rider
DR1-7420-21	Cancer Benefit Rider
DR1-7420-30 (REV.1/78)	Cancer Benefit Rider
DR1-7420-39	Cancer Benefit Rider
DR1-7420-46	Cancer Benefit Rider
DR1-7440	Elder Care III
DR1-7760	Elder Care Hospital & SNF Policy
DR1-7760-04(Rev.878)	Elder Care Hospital & SNF Policy
DR1-7760-09	Elder Care Hospital & SNF Policy
DR1-7760-10	Hospital & SNF Policy
DR1-7760-12	Elder Care Hospital & SNF Policy
DR1-7760-13	Hospital & SNF Policy For 65 & Over
DR1-7760-14	Elder Care Hospital & SNF Policy
DR1-7760-15(179)	Elder Care Hospital & SNF Policy
DR1-7760-16	Elder Care Hospital & SNF Policy
DR1-7760-18	Elder Care Hospital & SNF Policy
DR1-7760-19	Elder Care Hospital & SNF Policy
DR1-7760-22	Elder Care Hospital & SNF Policy
DR1-7760-24	Elder Care Hospital & SNF Policy
DR1-7760-25	Elder Care Hospital & SNF Policy
DR1-7760-35	Elder Care Hospital & SNF Policy
DR1-7760-40	Elder Care Hospital & SNF Policy
DR1-7760-41	Elder Care Hospital & SNF Policy
DR1-7760-42 (Rev.)	Elder Care Hospital & SNF Policy
DR1-7760-47	Elder Care Hospital & SNF Policy
DR1-7760-48	Elder Care Hospital & SNF Policy
DR1-7760-49	Elder Care Hospital & SNF Policy
DR1-7790-04 (878)	Skilled Nursing Facility
DR1-7790-09	Elder Care Skilled Nursing

---

DR1-7790-14	Elder Care Skilled Nursing
DR1-7790-15	Elder Care Skilled Nursing
DR1-7790-18	Elder Care Skilled Nursing
DR1-7790-19	Elder Care Skilled Nursing
DR1-7790-22	Elder Care Skilled Nursing
DR1-7790-24	Elder Care Skilled Nursing
DR1-7790-25	Elder Care Skilled Nursing

DR1-7790-36	Elder Care Skilled Nursing
DR1-7790-37	Elder Care Skilled Nursing
DR1-7790-39	Elder Care Skilled Nursing
DR1-7790-40	Elder Care Skilled Nursing
DR1-7790-41	Elder Care Skilled Nursing
DR1-7790-42(Rev.)	Elder Care Skilled Nursing
DR1-7790-47 (Rev)	Elder Care Skilled Nursing
DR1-7790-47 (Rev.)	Elder Care Skilled Nursing
DR1-7800 Rev.	Skilled Nursing Facility
DR1-7810-42	Elder Care III
DR1-7980-MN	Elder Care III
DR1-8000-22	Elder Care Hospital & SNF Policy
DR1-8120	Medicare Supplement
DR1-8130	Medicare Supplement
DR1-8140	Medicare Supplement
DR1-8150	Medicare Supplement
DR1-8220	Skilled Nursing Facility
DR1-8230	Medicare Supplement
DR3-7600-13	Elder Care Hospital & SNF Policy
DR3-7800-VA	Skilled Nursing Facility
DR3-8140-FL	Medicare Supplement
DR5-7800-TN	Skilled Nursing Facility
GSC-1637C	Medicare Supplement Certificate
HI-201A	Medicare Part B Rider
HI-201A	Medicare Part B Rider
HI-211 2/81	Medicare Supplement
HJ-1—04) (DR1-7090-04)	Franchise Health Policy
HJ-1—10(DR1-7090-10)	Franchise Health
HJ-1—12 (DR1-7070-12)	Franchise Health Policy
HJ-2 (DR1-7070-12)	Comprehensive Health
HJ-2—09(DR1-7090-09)(676)	Comprehensive Health
HJ-2—21 (DR1-7090-21)	Health Benefit Policy
HJ-2—22 (DR1-7090-12)	Comprehensive Health
HJ-2—22 (DR1-7090-29)	Comprehensive Health
HJ-2—24 (DR1-7090-12)	Health Protection
HJ-2—32(DR-1—7090-NC(65)	Comprehensive Health

---

HJ-2—39(DR1-7090-39)	Comprehensive Health
HJ-2—42(DR17090-42)	Comprehensive Health
HJ-2—IL (Rev) DR1-7090-12)	Comprehensive Health
HJ-2—TN (R) (DR1-7090)	Comprehensive Health
HT-502	In Hospital & Medicare
HT-503	In Hospital & Medicare
HT-504	In Hospital & Medicare
LOV-8280-REPL	Medicare Supplement
NA 1085	Medicare Supplement
NA 1123	Companion 65+
NA 65C (1/90)	Medicare Supplement
P-5—1030-00	Senior Hospital Care Plan
Q0-53578-A	Nurse At Home Certificate
Q0-53578-A24	Nurse At Home Certificate
Q0-69767-A	Group Medicare Supplement
Q0-69768-B	Group Medicare Supplement
X0-53441-A	Group Nurse At Home Rider
X0-88942-A	Intensive Care Certificate Rider
X0-89443-A	Group Out Patient Expense Rider
X0-89997-A24	Group After Hospital Indemnity
1-6180 Cert.	Medicare Supplement Certificate
1-6640 Cert.	Medicare Supplement Certificate
6-0950	Medicare — Standard Plan G
LOV-8290	Medicare Supplement









AGLA Block Reserves  
POLICY FORM

737 Series	AGLA 74687	MED-1 Series
738 Series	AGLA 76789 Series	MED1-REV
740	AGLA 76989	MED-2 Series
73787 Series	AGLA 77089 Series	MED2-REV
74087 Series	AGLA 77889	MED-3
74687	AGLA 77989	OTHER
74887	AGLA 79090 Series	SUPP-1 Series
74987	AGLA 79190 Series	SUPP-1—A Series
75087 Series	AGLA 79390 Series	SUPP-2 Series
751087 Series	AGLA 82192	SUPP-2—A Series
75587 Series	AGLA 82292	SUPP-R Series
75687 Series	AGLA 82595	
75689 Series		
6001 M-1		
6001 M-2		
6002 M-3		
6001 M-4		

Site 17  
POLICY FORM

110137  
110370  
130305  
130360  
GSC-1310C  
GSC-1385C

SCHEDULE B

CEDING COMMISSION

The Ceding Commission shall be the sum of the following:

- an amount equal to the excess of Total SAP Ceded Reserves over Total GAAP Ceded Reserves measured as of the close of business on the day immediately preceding the Inception Date (which amount may be negative);
- an amount equal to the unamortized PVFP intangible asset balance of the Company with respect to the Reinsured Policies as measured as of the close of business on the day immediately preceding the Inception Date, determined in accordance with GAAP;
- an amount equal to the unamortized deferred acquisition costs of the Company with respect to the Reinsured Policies as measured as of the close of business on the day immediately preceding the Inception Date, determined in accordance with GAAP; and
- an amount equal to the excess of the GAAP book value of the Assets (excluding any related mark to market adjustments for SFAS 115 requirement) over the SAP book value of the Assets measured as of the close of business on the day immediately preceding the Inception Date (which amount may be negative).

SCHEDULE C

ASSETS

	<u>Transfer Document</u>	<u>From</u>	<u>To</u>	<u>Nature of Transfer</u>	<u>Cash Map Cross-Reference</u>	<u>Schedule</u>					
	UFLIC MS Coinsurance	UFLIC	FHL	Treaty	(83)	Schedule C					
<u>Called Securities *</u>	<u>Parent Name</u>	<u>Issuer Name</u>	<u>1Q04 Cusip</u>	<u>1Q04 Tax lot</u>	<u>12/31/03 Local Par</u>	<u>12/31/03 GAAP BV (incl attached derivative)</u>	<u>12/31/03 Accrued Interest</u>	<u>12/31/03 GAAP BV + Accrued Interest</u>	<u>12/31/03 STAT BV (incl attached derivative)</u>	<u>12/31/03 Accrued Interest</u>	<u>12/31/03 STAT BV + Accrued Interest</u>
[Individual Asset Details Omitted]											
<b>Asset Sub Total</b>						<b>9,832,601.43</b>	<b>94,536.36</b>	<b>9,927,137.79</b>	<b>9,832,601.43</b>	<b>94,536.36</b>	<b>9,927,137.79</b>
Cash									114,617.97		114,617.97
<b>Total</b>									<b>9,947,219.40</b>		<b>10,041,755.76</b>

\* These Securities will not be transferred. The "Call Amount" will be settled in cash

SCHEDULE D

INITIAL REPORT

1.	Total SAP Ceded Reserves:		
	A. Active Life Reserves	\$	
	B. Claim Reserves	\$	
	C. Unearned Premium Reserves	\$	
	D. Advanced Premium	\$	
	E. Less: Due and Unpaid Premium	\$	
	Total SAP Ceded Reserves (A+B+C+D-E)		\$
2.	Ceding Commission:		
	A. Excess SAP Ceded Reserves over GAAP Ceded Reserves:		
	1) Total SAP Ceded Reserves	\$	
	2) Total GAAP Ceded Reserves:		
	a. Active Life Reserves	\$	
	b. Maintenance Reserves	\$	
	c. Loss Expense Reserves	\$	
	d. Claim Reserves	\$	
	e. Unearned Premium Reserves	\$	
	f. Advanced Premium	\$	
	g. Less: Due and Unpaid Premium	\$	
	Total GAAP Ceded Reserves (a+b+c+d+e+f-g)	\$	
	Excess SAP Reserves over GAAP Reserves (A1-A2)		\$
	B. Present Value of Future Profits (PVFP)		\$
	C. Deferred Acquisition Costs (DAC)		\$
	D. Asset Book Value Difference -		
	1) Asset Book Value (GAAP basis)	\$	
	2) Asset Book Value (SAP basis)	\$	
	Excess Asset Book Value (D1-D2)		\$
	Total Ceding Commission (A+B+C+D)		\$
3.	Accrued Interest on Assets as of the day before Inception Date		\$
4.	Investment Cash Flows on the Assets from the Inception Date through the Closing Date		\$
	Net Due Reinsurer (1-2-3+4)		\$

SCHEDULE E

FORM OF TRUST AGREEMENT

**TRUST AGREEMENT**

This TRUST AGREEMENT, dated as of \_\_\_\_\_, 2004 (this "Trust Agreement"), among Federal Home Life Insurance Company, an insurance company organized under the laws of the Commonwealth of Virginia (the "Grantor"), Union Fidelity Life Insurance Company, an insurance company organized under the laws of the State of Illinois (the "Beneficiary"), and The Bank of New York, a New York corporation (the "Trustee") (the Grantor, the Beneficiary and the Trustee are hereinafter each sometimes referred to individually as a "Party" and collectively as the "Parties").

RECITALS:

WHEREAS, the Grantor and the Beneficiary desire to create a trust account (the "Trust Account") for the benefit of the Beneficiary; and

WHEREAS, the Trustee has agreed to act as Trustee hereunder, and to hold assets in the Trust Account for the sole and exclusive use and benefit of the Beneficiary in accordance with the terms and conditions of this Trust Agreement; and

NOW, THEREFORE, for and in consideration of the premises and the promises and the mutual agreements hereinafter set forth, the Parties, intending to be legally bound, covenant and agree as follows:

**Section 1. Deposit of Assets into the Trust Account.**

(a) The Grantor hereby establishes the Trust Account with the Trustee for the sole use and benefit of the Beneficiary, under the terms set forth herein. The Trustee shall administer the Trust Account in its name as Trustee for the sole use and benefit of the Beneficiary. The Trust Account shall be subject to withdrawal by the Beneficiary solely as provided herein. The Trustee hereby accepts the Trust Account upon the terms set forth in this Trust Agreement.

(b) The Grantor shall transfer to the Trustee, for deposit into the Trust Account, the assets listed on Exhibit A hereto, and may transfer to the Trustee, for deposit into the Trust Account, such other assets as it may from time to time desire to transfer or be required to transfer (all such assets actually received in the Trust Account are herein referred to individually as an "Asset" and collectively as the "Assets"). The Trustee is authorized and shall have power to receive the Assets from the Grantor and to hold, invest, reinvest and dispose of the same for the uses and purposes of and according to the provisions herein set forth. All Assets shall be maintained by the Trustee in the Trust Account separate and distinct from all other assets on the books of the Trustee and shall be continuously kept in a safe place at the Trustee's office within the United States of America. The Assets shall be valued according to their current fair market value and shall consist only of cash (United States legal tender) and Eligible Securities (as hereinafter defined). In the event of any payment default as to any Asset in the Trust Account or in the event that any Asset no longer is an Eligible Security, the Grantor shall, within five (5) business days after receiving notice from the Trustee pursuant to Section 17 or the Grantor having knowledge of such default or ineligibility, substitute other Assets which meet the requirements of an Eligible Security and having a current fair market value equal to the current

---

fair market value of such Asset, which has a payment default or no longer meets the requirements for an Eligible Security, on the last statement provided by the Trustee.

(c) The Grantor hereby represents and warrants (i) that any Assets transferred by the Grantor to the Trustee for deposit to the Trust Account will be in such form that the Beneficiary whenever necessary may, and the Trustee upon direction by the Beneficiary will, negotiate any such Assets without consent or signature from the Grantor or any other person or entity in accordance with the terms of this Trust Agreement, (ii) that all Assets transferred by the Grantor to the Trustee for deposit into the Trust Account consist only of cash and Eligible Securities, and (iii) that Grantor has at the time of transfer into this Trust Account good and marketable title to the Assets to be so transferred and each such Asset shall be at the time of transfer free and clear of all claims, liens, interests and encumbrances (other than those arising under this Trust Agreement).

(d) Prior to depositing the Assets into the Trust Account, and from time to time thereafter as required, the Grantor shall execute assignments, endorsement in blank, or transfer legal title to the Trustee of all shares, obligations or other Assets requiring assignments, so that the Beneficiary, whenever necessary may, and the Trustee upon the direction by the Beneficiary will, negotiate any such Assets without the consent or signature from the Grantor or any other person or entity. Any Assets received by the Trustee which are not in such proper negotiable form shall not be accepted by the Trustee and shall be returned to the Grantor as unacceptable. The Grantor shall give all notices and take all actions as the Trustee deems appropriate in order to cause payments due or that become due on any Asset within the Trust Account to be paid to the Trustee. The Grantor shall not make or consent to any waiver, amendment or restriction on transfer with respect to any Asset in the Trust Account, in each case, without the Beneficiary's prior written consent. In connection with the deposit of Assets into the Trust Account, the Grantor shall furnish to the Trustee all original documentation evidencing the Grantor's ownership thereto.

## **Section 2. Withdrawal of Assets from the Trust Account**

(a) Without notice to the Grantor, the Beneficiary shall have the right, at any time and from time to time, to withdraw from the Trust Account, subject only to written notice from the Beneficiary to the Trustee (the "Withdrawal Notice"), such Assets as are specified in such Withdrawal Notice. The Withdrawal Notice may designate a third party (the "Beneficiary Designee") to whom Assets specified therein shall be delivered. The Beneficiary shall not be required to present any other statement or document in addition to a Withdrawal Notice in order to withdraw any Assets, except that the Beneficiary shall acknowledge receipt of any such Assets withdrawn upon request by the Trustee; nor is said right of withdrawal or any other provision of this Trust Agreement subject to any conditions or qualifications not contained in this Trust Agreement.

(b) Upon receipt of a Withdrawal Notice, the Trustee shall immediately take any and all steps necessary to transfer absolutely and unequivocally all right, title and interest in the Assets specified in such Withdrawal Notice and shall deliver physical custody (or such other form as is necessary to complete the transfer) of such Assets to or for the account of the Beneficiary or such Beneficiary Designee, as specified in such Withdrawal Notice. The Trustee

---

shall notify the Grantor and Beneficiary within ten (10) days following each withdrawal from the Trust Account.

(c) Subject to Section 3, in the absence of a Withdrawal Notice, the Trustee shall allow no substitution or withdrawal of any Asset from the Trust Account.

## **Section 3. Redemption, Investment and Substitution of Assets**

(a) The Trustee shall surrender for payment all maturing Assets and all Assets called for redemption, and deposit the principal amount of the proceeds of any such payment to the Trust Account.

(b) The Grantor, subject to the prior written approval of the Beneficiary, may retain (and pay the service fees of) a professional asset manager (the "Asset Manager") to manage and make investment decisions with regard to the Assets held by the Trustee in the Trust Account. From time to time, at the written order and direction of the Grantor or the Asset Manager, the Trustee shall invest Assets in the Trust Account in Eligible Securities.

(c) From time to time, subject to the prior written approval of the Beneficiary, the Grantor or the Asset Manager may direct the Trustee to substitute Assets of equal current fair market value for other Assets presently held in the Trust Account. The Trustee shall have no responsibility whatsoever to determine the value of such substituted Assets or that such substituted Assets constitute Eligible Securities.

(d) All investments and substitutions of securities referred to in Sections 3(b) and 3(c) above shall be in compliance with the definition of "Eligible Securities" in Section 10 of this Trust Agreement. Any instruction or order concerning such investments or substitutions of securities shall be referred to herein as an "Investment Order". The Trustee shall execute Investment Orders and settle securities transactions by itself or by means of an agent or broker. The Trustee shall not be responsible for any act or omission, or for the solvency, of any such agent or broker, except as set forth in Section 6.

(e) From time to time, upon notice to the Beneficiary, the Trustee may withdraw any Asset in the Trust Account upon the call or maturity of such Asset provided that the proceeds from such call or maturity are deposited into the Trust Account.

(f) When the Trustee is directed to deliver Assets against payment, delivery will be made in accordance with generally accepted market practice.

(g) Any loss incurred from any investment pursuant to the terms of this Section 3 shall be borne exclusively by the Trust Account.

## **Section 4. The Income Account**

All payments of interest, dividends and other income in respect to Assets in the Trust Account shall be the property of the Grantor and shall be deposited by the Trustee, subject to deduction of the Trustee's compensation and expenses as provided in Section 7 of this Agreement, in a separate account (the "Income Account") established and maintained by the

---

Grantor at an office of the Trustee. Any interest, dividend or other income automatically posted and credited on the payment date to the Income Account which is not subsequently received by the Trustee shall be reimbursed by the Grantor to the Trustee and the Trustee may debit the Income Account for this purpose. The Grantor may withdraw amounts from the Income Account at any time and from time to time.

## **Section 5. Right to Vote Assets**

The Trustee shall forward all annual and interim stockholder reports and all proxies and proxy materials relating to the Assets in the Trust Account to the Grantor within a reasonable period of time following the Trustee's receipt thereof. The Grantor shall have the full and unqualified right to vote any shares of stock in the Trust Account.

**Section 6. Additional Rights and Duties of the Trustee**

- (a) The Trustee shall be a bank which is a member of the Federal Reserve System of the United States of America or a New York State chartered bank or trust company and shall not be a parent, subsidiary or affiliate of the Grantor or the Beneficiary.
- (b) Notwithstanding any provision of this Agreement to the contrary, the Trustee shall not be liable except for its own negligence, willful misconduct or lack of good faith arising out of or in connection with the performance of its obligations in accordance with this Trust Agreement.
- (c) The Trustee shall have no responsibility whatsoever to determine that any Assets in the Trust Account are or continue to be Eligible Securities.
- (d) The Trustee shall notify the Grantor and the Beneficiary in writing within ten (10) days following each deposit into, or withdrawal from, the Trust Account and shall notify the Grantor promptly of the receipt by the Trustee of any Withdrawal Notice.
- (e) Before accepting any Asset for deposit to the Trust Account, the Trustee shall determine that such Asset is in such form that the Beneficiary whenever necessary may, or the Trustee upon direction by the Beneficiary will, negotiate such Asset without consent or signature from the Grantor or any person or entity other than the Trustee in accordance with the terms of this Trust Agreement.
- (f) The Trustee shall be under no obligation to determine whether or not any instructions given by the Grantor and Beneficiary are contrary to any provision of law. It is understood and agreed that the Trustee's duties are solely those set forth herein and that the Trustee shall have no duty to take any other action unless specifically agreed to by the Trustee in writing. Without limiting the generality of the foregoing, the Trustee shall not have any duty to advise, manage, supervise or make recommendations with respect to the purchase, retention or sale of Assets with respect to any Assets in the Trust Account as to which a default in the payment of principal or interest has occurred or to be responsible for the consequences of insolvency or the legal inability of any broker, dealer, bank or other agent employed by the Grantor or Trustee with respect to the Assets except to the extent that the Trustee was negligent, engaged in misconduct or acted in bad faith in the selection of any such person or entity.
- 
- (g) The Trustee shall accept and open all mail directed to the Grantor or the Beneficiary in care of the Trustee.
- (h) The Trustee shall furnish to the Grantor and the Beneficiary a statement of all Assets in the Trust Account upon the inception of the Trust Account and at the end of each quarter thereafter. The statement shall include a description of the Assets in the Trust Account and the then current market value of the Assets and shall be delivered within five (5) business days following the end of such quarter.
- (i) The Trustee shall keep full and complete records of the administration of the Trust Account in accordance with all applicable law. Upon the request of the Grantor or the Beneficiary, the Trustee shall promptly permit the Grantor or the Beneficiary, their respective agents, employees, independent auditors and regulatory authorities to examine, audit, excerpt, transcribe and copy, during the Trustee's normal business hours, any books, documents, papers and records relating to the Trust Account or the Assets.
- (j) Unless otherwise provided in this Trust Agreement, the Trustee is authorized to follow and rely upon all instructions given by officers of the Grantor or the Beneficiary and by attorneys-in-fact acting under written authority furnished to the Trustee by the Grantor or the Beneficiary, including, without limitation, instructions given by letter, facsimile transmission or electronic media, if the Trustee believes such instructions to be genuine and to have been signed, sent or presented by the proper party or parties. In the absence of negligence, the Trustee shall not incur any liability to anyone resulting from actions taken by the Trustee in reliance in good faith on such instructions. The Trustee shall not incur any liability in executing instructions (i) from any attorney-in-fact prior to receipt by it of notice of the revocation of the written authority of the attorney-in-fact or (ii) from any officer of the Grantor or the Beneficiary.
- (k) The duties and obligations of the Trustee shall only be such as are specifically set forth in this Trust Agreement, as it may from time to time be amended, and no implied duties or obligations shall be read into this Trust Agreement against the Trustee.
- (l) No provision of this Trust Agreement shall require the Trustee to take any action which, in the Trustee's reasonable judgment, would result in any violation of this Trust Agreement or any provision of law.
- (m) The Trustee may confer with counsel of its own choice in relation to matters arising under this Trust Agreement and shall have full and complete authorization from the other Parties for any action taken or suffered by it under this Trust Agreement or in respect of any transaction contemplated hereby in good faith and in accordance with the opinion of such counsel.
- (n) The Trustee shall notify the Grantor and Beneficiary in writing of any payment default occurring as to any Asset within three (3) business days after Trustee receives notice of such default. In the event of a delinquency of a timely payment in regard to any of the Assets, the Trustee shall inform the Grantor and the Beneficiary immediately upon Trustee's receipt of notice of such delinquency (which shall be confirmed in writing by the Trustee within two (2) business days thereof).

---

(o) The Trustee shall be liable for (i) the safekeeping of the Assets and administering the Trust Account in accordance with the provisions of this Trust Agreement and (ii) its own negligence, willful misconduct or lack of good faith in performing its duties under this Trust Agreement. The Trustee shall exercise the standard of care with respect to the Assets that a professional trustee, engaged in the banking or trust company industry, having professional expertise in financial and securities processing transactions and custody would observe in such affairs. The Trustee shall be responsible for physical loss of or damage to Assets under its care, custody, possession or control, including but not limited to loss due to fire, burglary, robbery, theft or mysterious disappearance. In the event of loss or damage to the Assets under the care, custody, possession or control of Trustee, Trustee shall, upon demand of the Grantor or Beneficiary, promptly replace such Assets with like kind and quality together with, all rights and privileges pertaining to the Assets (by among other methods, posting appropriate security or bond with the issuer of the Assets to obtain reissue of such Assets, or, if acceptable to the Grantor, deliver cash equivalent to the market value of the Assets as of the date of the discovery of the loss or damage). Nothing contained in any contract between Trustee and any entity authorized to hold Assets, as defined herein, shall diminish or otherwise alter the liability of Trustee to the Grantor or Beneficiary. The provisions of this paragraph shall not affect the burden of proof under applicable law with respect to the assertions of liability in any claim, action or dispute alleging any breach of or failure to observe such standard of care.

**Section 7. The Trustee's Compensation; Expenses**

(a) The Grantor shall pay the Trustee, as compensation for its services under this Trust Agreement, a fee computed at rates determined by the Trustee from time to time and communicated in writing to the Grantor. The Grantor shall pay or reimburse the Trustee for all of the Trustee's expenses and disbursements in connection with its duties under this Trust Agreement (including reasonable attorney's fees and expenses), except any such expense or disbursement as may arise from the Trustee's negligence, willful misconduct, lack of good faith or failure to administer the Trust Account in accordance with the terms of this Trust Agreement. The Trustee shall be entitled to deduct its compensation and expenses from payments of dividends, interest and other income in respect of the Assets held in the Trust Account prior to the deposit thereof to the Income Account as provided in Section 4 of this Agreement. The Grantor also hereby indemnifies the Trustee for, and holds it harmless against, any loss, liability, costs or expenses (including reasonable attorney's fees and expenses) incurred or made without negligence, willful misconduct or lack of good faith on the part of the Trustee, arising out of or in connection with the performance of its obligations in accordance with the provisions of this Trust Agreement (which shall be the sole obligation of the Trustee), including any loss, liability, costs or expenses arising out of or in connection with the status of the Trustee and its nominee as the holder of record of the Assets. The Grantor

hereby acknowledges that the foregoing indemnities shall survive the resignation of the Trustee or the termination of this Trust Agreement and hereby grants the Trustee a lien, right of set-off and security interest in the funds in the Income Account for the payment of any claim for compensation, reimbursement or indemnity hereunder.

(b) No Assets shall be withdrawn from the Trust Account or used in any manner for paying compensation to, or reimbursement or indemnification of, the Trustee.

---

**Section 8. Resignation or Removal of the Trustee.**

(a) The Trustee may resign at any time upon delivery of a written notice thereof to the Beneficiary and to the Grantor effective not less than ninety (90) days after receipt by the Beneficiary and the Grantor of such notice. The Trustee may be removed by the Grantor's delivery to the Trustee and the Beneficiary of a written notice of removal, effective not less than ninety (90) days after receipt by the Trustee and the Beneficiary of such notice. The Trustee may also be removed by prior written notice executed by the Grantor and the Beneficiary. No such resignation or removal shall become effective until a successor Trustee has been appointed and approved by the Beneficiary and the Grantor and all Assets in the Trust Account have been duly transferred to the successor Trustee in accordance with paragraph (b) of this Section 8.

(b) Upon receipt by the proper Parties of the Trustee's notice of resignation or the Grantor's or the Grantor's and the Beneficiary's notice of removal, as applicable, the Grantor and the Beneficiary shall appoint a successor Trustee. Any successor Trustee shall be a bank that is a member of the Federal Reserve System of the United States of America or a New York State chartered bank or trust company and must not be a parent, a subsidiary or an affiliate of the Grantor or the Beneficiary. Upon the acceptance of the appointment as Trustee hereunder by a successor Trustee and the transfer to such successor Trustee of all Assets in the Trust Account, the resignation or removal of the Trustee shall become effective. Thereupon, such successor Trustee shall succeed to and become vested with all the rights, powers, privileges and duties of the resigning or removed Trustee, and the resigning or removed Trustee shall be discharged from any future duties and obligations under this Trust Agreement, but the resigning or removed Trustee shall continue after such resignation or removal to be entitled to the benefits of the indemnities provided herein for the Trustee.

**Section 9. Termination of the Trust Account.**

The Trust Account and this Trust Agreement shall be effective until terminated by sixty (60) days' advance written notice sent to the Trustee by the Grantor. Written notice of termination shall be delivered by the Trustee to the Beneficiary at least thirty (30) but not more than forty-five (45) days prior to termination. Upon the termination of the Trust Account, the Trustee shall, with the Beneficiary's prior written consent, transfer to the Grantor all of the Assets of the Trust Account and Income Account not previously withdrawn by the Beneficiary.

**Section 10. Definitions.**

Except as the context shall otherwise require, the following terms shall have the following meanings for purposes of this Trust Agreement (the definitions to be applicable to both the singular and the plural forms of each term defined if both forms of such term are used in this Trust Agreement):

The term "Beneficiary" shall include any successor of the Beneficiary by operation of law, including, without limitation, any liquidator, rehabilitator, receiver or conservator.

The term "Eligible Securities" shall mean and include certificates of deposit (issued by a United States bank and payable in United States legal tender) and investments of the types specified in paragraphs (1), (2), (3), (8) and (10) of Section 1404(a) of the New York Insurance

---

Law; provided, however, that such investments are issued by an institution that is not the parent, a subsidiary or an affiliate of either the Grantor or the Beneficiary.

The terms "Person" shall mean and include an individual, a corporation, a partnership, an association, a trust, an unincorporated organization or a government or political subdivision thereof.

**Section 11. Governing Law.**

This Trust Agreement shall be subject to and governed by the laws of the State of New York, without regard to its conflict of laws provision and the Trust Account created hereunder shall be administered in accordance with the laws of said state.

**Section 12. WAIVER OF JURY TRIAL.**

**EACH PARTY HERETO HEREBY WAIVES TRIAL BY JURY IN ANY JUDICIAL PROCEEDING INVOLVING, DIRECTLY OR INDIRECTLY, ANY MATTER (WHETHER SOUNDING IN TORT, CONTRACT OR OTHERWISE) IN ANY WAY ARISING OUT OF OR RELATED TO THIS AGREEMENT OR THE RELATIONSHIP ESTABLISHED HEREUNDER. THIS PROVISION IS A MATERIAL INDUCEMENT FOR THE PARTIES TO ENTER INTO THIS AGREEMENT.**

**Section 13. Successors and Assigns.**

This Trust Agreement shall be binding upon and inure to the benefit of the Parties and their respective successors, permitted assigns and legal representatives. Neither this Trust Agreement, nor any right or obligation hereunder, may be assigned by any Party without the prior written consent of the other Parties hereto. Any assignment in violation of this Section 13 shall be void and shall have no force and effect.

**Section 14. Severability.**

If any provision of this Trust Agreement is held to be void or unenforceable, in whole or in part, (i) such holding shall not affect the validity and enforceability of the remainder of this Trust Agreement, including any other provision, paragraph or subparagraph, and (ii) the Parties agree in good faith to reform such void or unenforceable provision to the extent necessary to render such provision enforceable and to carry out its original intent.

**Section 15. Entire Agreement.**

This Trust Agreement constitutes the entire agreement among the Parties with respect to the subject matter hereof, and there are no understandings or agreements, conditions or qualifications relative to this Trust Agreement which are not fully expressed in this Trust Agreement.

---

**Section 16. Amendments.**



This Trust Agreement may be modified or otherwise amended, and the observance of any term of this Trust Agreement may be waived, only if such modification, amendment or waiver is in writing and signed by the Parties.

**Section 17. Notices.**

All notices, requests, demands and other communications under this Trust Agreement must be in writing and will be deemed to have been duly given or made as follows: (a) if sent by registered or certified mail in the United States return receipt requested, upon receipt; (b) if sent by reputable overnight air courier, two business days after mailing; (c) if sent by facsimile transmission, with a copy mailed on the same day in the manner provided in (a) or (b) above, when transmitted and receipt is confirmed by telephone; or (d) if otherwise actually personally delivered, when delivered, and shall be delivered as follows:

If to the Grantor:

Federal Home Life Insurance Company  
6620 West Broad Street  
Richmond, VA 23230  
Facsimile: (804) 662-2414  
Attention: Chief Executive Officer

With a copy to:

Federal Home Life Insurance Company  
700 Main Street  
Lynchburg, VA 24504  
Facsimile: (434) 948-5819  
Attention: General Counsel

If to the Beneficiary:

Union Fidelity Life Insurance Company  
200 North Martingale Road  
Schaumburg, IL 60173-2096  
Facsimile: (847) 330-3404  
Attention: Chief Financial Officer

With a copy to:

Union Fidelity Life Insurance Company  
200 North Martingale Road  
Schaumburg, IL 60173-2096  
Facsimile: (847) 605-3044  
Attention: General Counsel

---

If to the Trustee:

The Bank of New York  
101 Barclay Street - 8W  
New York, NY 10283  
Facsimile: (212) 815-5875  
Attention: Insurance Trust and Escrow Unit

or to such other address or to such other Person as a Party may have last designated by notice to the other Parties.

**Section 18. Headings.**

The headings of the Sections have been inserted for convenience of reference only and shall not be deemed to constitute a part of this Trust Agreement.

**Section 19. Counterparts.**

This Trust Agreement may be executed in any number of counterparts, each of which when so executed and delivered shall constitute an original, but such counterparts together shall constitute but one and the same Trust Agreement.

---

**IN WITNESS WHEREOF**, the parties hereto have caused this Trust Agreement to be executed and delivered by their respective officers thereunto duly authorized as of the date first above written.

FEDERAL HOME LIFE INSURANCE  
COMPANY, as Grantor

By: \_\_\_\_\_  
Name:  
Title:

UNION FIDELITY LIFE INSURANCE  
COMPANY, as Beneficiary

By: \_\_\_\_\_

Name:  
Title:

THE BANK OF NEW YORK, as Trustee

By: \_\_\_\_\_  
Name:  
Title:

---

**EXHIBIT A**

**Assets**

---

**BUSINESS ASSOCIATE ADDENDUM**

I. Purpose.

In order to disclose certain information to the party providing a service under this Agreement (“Provider”) under this Addendum, some of which may constitute Protected Health Information (defined below), the party to whom a service under this Agreement is being provided (“Recipient”) and Provider mutually agree to comply with the terms of this Addendum for the purpose of satisfying the requirements of the Health Insurance Portability and Accountability Act of 1996 (“HIPAA”) and its implementing privacy regulations at 45 C.F.R. Parts 160-164 (“HIPAA Privacy Rule”). These provisions shall apply to Provider to the extent that Provider is considered a “Business Associate” under the HIPAA Privacy Rule and all references in this section to Business Associates shall refer to Provider. Capitalized terms not otherwise defined herein shall have the meaning assigned in the Agreement. Notwithstanding anything else to the contrary in the Agreement, in the event of a conflict between this Addendum and the Agreement, the terms of this Addendum shall prevail.

II. Permitted Uses and Disclosures.

A. Business Associate agrees to use or disclose Protected Health Information (“PHI”) that it creates for or receives from Recipient or its Subsidiaries only as follows. The capitalized term “Protected Health Information or PHI” has the meaning set forth in 45 Code of Federal Regulations Section 164.501, as amended from time to time. Generally, this term means individually identifiable health information including, without limitation, all information, data and materials, including without limitation, demographic, medical and financial information, that relates to the past, present, or future physical or mental health or condition of an individual; the provision of health care to an individual; or the past present, or future payment for the provision of health care to an individual; and that identifies the individual or with respect to which there is a reasonable basis to believe the information can be used to identify the individual. This definition shall include any demographic information concerning members and participants in, and applicants for, Recipient’s or its Subsidiaries’ health benefit plans. All other terms used in this Addendum shall have the meanings set forth in the applicable definitions under the HIPAA Privacy Rule.

B. Functions and Activities on Company’s Behalf. Business Associate is permitted to use and disclose PHI it creates for or receives from Recipient or its Subsidiaries only for the purposes described in this Addendum or the Agreement that are not inconsistent with the provisions of this Addendum, or as required by law, or following receipt of prior written approval from whichever of the Recipient or its Subsidiary for which the relevant PHI was created or from which the relevant PHI was received. In addition to these specific requirements below, Business Associate may use or disclose PHI only in a manner that would not violate the HIPAA Privacy Rule if done by the Recipient or its Subsidiaries.

C. Business Associate’s Operations. Business Associate is permitted by this Agreement to use PHI it creates for or receives from Recipient or its Subsidiaries: (i) if such

---

use is reasonably necessary for Business Associate’s proper management and administration; and (ii) as reasonably necessary to carry out Business Associate’s legal responsibilities. Business Associate is permitted to disclose PHI it creates for or receives from Recipient or its Subsidiaries for the purposes identified in this Section only if the following conditions are met:

(1) The disclosure is required by law; or

(2) The disclosure is reasonably necessary to Business Associate’s proper management and administration, and Business Associate obtains reasonable assurances in writing from any person or organization to which Business Associate will disclose such PHI that the person or organization will:

a. Hold such PHI as confidential and use or further disclose it only for the purpose for which Business Associate disclosed it to the person or organization or as required by law; and

b. Notify Business Associate (who will in turn promptly notify whichever of the Recipient or its Subsidiary for which the relevant PHI was created or from which the relevant PHI was received) of any instance of which the person or organization becomes aware in which the confidentiality of such PHI was breached.

D. Minimum Necessary Standard. In performing the functions and activities on Recipient’s or its Subsidiaries’ behalf pursuant to the Agreement, Business Associate agrees to use, disclose or request only the minimum necessary PHI to accomplish the purpose of the use, disclosure or request. Business Associate must have in place policies and procedures that limit the PHI disclosed to meet this minimum necessary standard.

E. Prohibition on Unauthorized Use or Disclosure. Business Associate will neither use nor disclose PHI it creates or receives for or from Recipient, its Subsidiaries, or from another business associate of Recipient or its Subsidiaries, except as permitted or required by this Addendum or the Agreement that are not inconsistent with the provisions of this Addendum, or as required by law, or following receipt of prior written approval from whichever of the Recipient or its Subsidiary for which the relevant PHI was created or from which the relevant PHI was received.

F. De-identification of Information. Business Associate agrees neither to de-identify PHI it creates for or receives from Recipient or its Subsidiaries or from another business associate of Recipient or its Subsidiaries, nor use or disclose such de-identified PHI, unless such de-identification is expressly permitted under the terms and conditions of this Addendum or the Agreement and related to Recipient’s or its Subsidiaries’ activities for purposes of “treatment”, “payment” or “health care operations”, as those terms are defined under the HIPAA Privacy Rule. De-identification of PHI, other than as expressly permitted under the terms and conditions of the

associate of Recipient or its Subsidiaries, nor use or disclose such Limited Data Set unless: (i) such creation, use or disclosure is expressly permitted under the terms and conditions of this Addendum or the Agreement that are not inconsistent with the provisions of this Addendum; and such creation, use or disclosure is for services provided by Business Associate that relate to Recipient's or its Subsidiaries' activities for purposes of "treatment", "payment" or "health care operations", as those terms are defined under the HIPAA Privacy Rule.

G. Information Safeguards. Business Associate will develop, document, implement, maintain and use appropriate administrative, technical and physical safeguards to preserve the integrity and confidentiality of and to prevent non-permitted use or disclosure of PHI created for or received from Recipient or its Subsidiaries. These safeguards must be appropriate to the size and complexity of Business Associate's operations and the nature and scope of its activities. Business Associate agrees that these safeguards will meet any applicable requirements set forth by the U.S. Department of Health and Human Services, including (as of the effective date or as of the compliance date, whichever is applicable) any requirements set forth in the final HIPAA security regulations. Business Associate agrees to mitigate, to the extent practicable, any harmful effect that is known to Business Associate resulting from a use or disclosure of PHI by Business Associate in violation of the requirements of this Addendum.

III. Conducting Standard Transactions. In the course of performing services for Recipient or its Subsidiaries, to the extent that Business Associate will conduct Standard Transactions for or on behalf of Recipient or its Subsidiaries, Business Associate will comply, and will require any subcontractor or agent involved with the conduct of such Standard Transactions to comply, with each applicable requirement of 45 C.F.R. Part 162. "Standard Transaction(s)" shall mean a transaction that complies with the standards set forth at 45 C.F.R. parts 160 and 162. Further, Business Associate will not enter into, or permit its subcontractors or agents to enter into, any trading partner agreement in connection with the conduct of Standard Transactions for or on behalf of the Recipient or its Subsidiaries that:

- a. Changes the definition, data condition, or use of a data element or segment in a Standard Transaction;
- b. Adds any data element or segment to the maximum defined data set;
- c. Uses any code or data element that is marked "not used" in the Standard Transaction's implementation specification or is not in the Standard Transaction's implementation specification; or
- d. Changes the meaning or intent of the Standard Transaction's implementation specification.

IV. Sub-Contractors, Agents or Other Representatives. Business Associate will require any of its subcontractors, agents or other representatives to which Business Associate is permitted by this Addendum or the Agreement (or is otherwise given Recipient's or the relevant Subsidiary's prior written approval) to disclose any of the PHI Business Associate creates or receives for or

---

from Recipient or its Subsidiaries, to provide reasonable assurances in writing that subcontractor or agent will comply with the same restrictions and conditions that apply to the Business Associate under the terms and conditions of this Addendum with respect to such PHI.

V. Protected Health Information Access, Amendment and Disclosure Accounting.

A. Access. Business Associate will promptly upon Recipient's or its Subsidiary's request make available to Recipient, its Subsidiary, or, at Recipient's or such Subsidiary's direction, to the individual (or the individual's personal representative) for inspection and obtaining copies any PHI about the individual which Business Associate created for or received from Recipient or its Subsidiary and that is in Business Associate's custody or control, so that Recipient or its Subsidiary may meet its access obligations under 45 Code of Federal Regulations § 164.524.

B. Amendment. Upon Recipient's or its Subsidiary's request Business Associate will promptly amend or permit Recipient or its Subsidiary access to amend any portion of the PHI which Business Associate created for or received from Recipient or its Subsidiary, and incorporate any amendments to such PHI, so that Recipient or its Subsidiary may meet its amendment obligations under 45 Code of Federal Regulations § 164.526.

C. Disclosure Accounting. So that Recipient or its Subsidiaries may meet their disclosure accounting obligations under 45 Code of Federal Regulations § 164.528:

1. Disclosure Tracking. Business Associate will record for each disclosure, not excepted from disclosure accounting under Section V.C.2 below, that Business Associate makes to Recipient or its Subsidiaries of PHI that Business Associate creates for or receives from Recipient or its Subsidiaries, (i) the disclosure date, (ii) the name and member or other policy identification number of the person about whom the disclosure is made, (iii) the name and (if known) address of the person or entity to whom Business Associate made the disclosure, (iv) a brief description of the PHI disclosed, and (v) a brief statement of the purpose of the disclosure (items i-v, collectively, the "disclosure information"). For repetitive disclosures Business Associate makes to the same person or entity (including Recipient or its Subsidiaries) for a single purpose, Business Associate may provide a) the disclosure information for the first of these repetitive disclosures, (b) the frequency, periodicity or number of these repetitive disclosures and (c) the date of the last of these repetitive disclosures. Business Associate will make this disclosure information available to Recipient or its Subsidiaries promptly upon Recipient's or its Subsidiaries' request.

2. Exceptions from Disclosure Tracking. Business Associate need not record disclosure information or otherwise account for disclosures of PHI that this Addendum or Recipient or the relevant Subsidiary in writing permits or requires (i) for the purpose of Recipient's or its Subsidiaries' treatment activities, payment activities, or health care operations, (ii) to the individual who is the subject of the PHI disclosed or to that individual's personal representative; (iii) to persons involved in that individual's health care or payment for health care; (iv) for notification for disaster relief purposes, (v) for national security or intelligence purposes, (vi) to law enforcement officials or correctional

---

institutions regarding inmates; or (vii) pursuant to an authorization; (viii) for disclosures of certain PHI made as part of a Limited Data Set; (ix) for certain incidental disclosures that may occur where reasonable safeguards have been implemented; and (x) for disclosures prior to April 14, 2003.

3. Disclosure Tracking Time Periods. Business Associate must have available for Recipient and its Subsidiaries the disclosure information required by this section for the 6 years preceding Recipient's or its Subsidiaries' request for the disclosure information (except Business Associate need have no disclosure information for disclosures occurring before April 14, 2003).

VI. Additional Business Associate Provisions

A. Reporting of Breach of Privacy Obligations. Business Associate will provide written notice to whichever of the Recipient or its Subsidiary for which the relevant PHI was created or from which the relevant PHI was received of any use or disclosure of PHI that is neither permitted by this Addendum nor given prior written approval by Recipient or the relevant Subsidiary promptly after Business Associate learns of such non-permitted use or disclosure. Business Associate's report will at least:

- (ii) Identify the nature of the non-permitted use or disclosure;
- (iii) Identify the PHI used or disclosed;
- (iv) Identify who made the non-permitted use or received the non-permitted disclosure;
- (v) Identify what corrective action Business Associate took or will take to prevent further non-permitted uses or disclosures;
- (vi) Identify what Business Associate did or will do to mitigate any deleterious effect of the non-permitted use or disclosure; and
- (vii) Provide such other information, including a written report, as Recipient or the relevant Subsidiary may reasonably request.

B. Amendment. Upon the effective date of any final regulation or amendment to final regulations promulgated by the U.S. Department of Health and Human Services with respect to PHI, including, but not limited to the HIPAA privacy and security regulations, this Addendum and the Agreement will automatically be amended so that the obligations they impose on Business Associate remain in compliance with these regulations.

In addition, to the extent that new state or federal law requires changes to Business Associate's obligations under this Addendum, this Addendum shall automatically be amended to include such additional obligations, upon notice by Recipient or its Subsidiaries to Business Associate of such obligations. Business Associate's continued performance of services under the Agreement shall be deemed acceptance of these additional obligations.

C. Audit and Review of Policies and Procedures. Business Associate agrees to provide, upon Recipient request, access to and copies of any policies and procedures developed or utilized by Business Associate regarding the protection of PHI. Business Associate agrees to provide, upon Recipient's request, access to Business Associate's internal practices, books, and records, as they relate to Business Associate's services, duties and obligations set forth in this Addendum and the Agreement(s) under which Business Associate provides services and / or products to or on behalf of Recipient or its Subsidiaries, for purposes of Recipient's or its Subsidiaries' review of such internal practices, books, and records.

SCHEDULE D

INITIAL REPORT

1.	Total SAP Ceded Reserves:		
	A. Active Life Reserves	\$	
	B. Claim Reserves	\$	
	C. Unearned Premium Reserves	\$	
	D. Advanced Premium	\$	
	E. Less: Due and Unpaid Premium	\$	
	Total SAP Ceded Reserves (A+B+C+D-E)		\$
2.	Ceding Commission:		
	A. Excess SAP Ceded Reserves over GAAP Ceded Reserves:		
	1) Total SAP Ceded Reserves	\$	
	2) Total GAAP Ceded Reserves:		
	a. Active Life Reserves	\$	
	b. Maintenance Reserves	\$	
	c. Loss Expense Reserves	\$	
	d. Claim Reserves	\$	
	e. Unearned Premium Reserves	\$	
	f. Advanced Premium	\$	
	g. Less: Due and Unpaid Premium	\$	
	Total GAAP Ceded Reserves (a+b+c+d+e+f-g)	\$	
	Excess SAP Reserves over GAAP Reserves (A1-A2)		\$
	B. Present Value of Future Profits (PVFP)		\$
	C. Deferred Acquisition Costs (DAC)		\$
	D. Asset Book Value Difference —		
	1) Asset Book Value (GAAP basis)	\$	
	2) Asset Book Value (SAP basis)	\$	
	Excess Asset Book Value (D1-D2)		\$
	Total Ceding Commission (A+B+C+D)		\$
3.	Accrued Interest on Assets as of the day before Inception Date		\$
4.	Investment Cash Flows on the Assets from the Inception Date through the Closing Date		\$
	Net Due Reinsurer (1-2—3+4)		\$

---

## TRUST AGREEMENT

This TRUST AGREEMENT, dated as of \_\_\_\_\_, 2004 (this "Trust Agreement"), among Federal Home Life Insurance Company, an insurance company organized under the laws of the Commonwealth of Virginia (the "Grantor"), Union Fidelity Life Insurance Company, an insurance company organized under the laws of the State of Illinois (the "Beneficiary"), and The Bank of New York, a New York corporation (the "Trustee") (the Grantor, the Beneficiary and the Trustee are hereinafter each sometimes referred to individually as a "Party" and collectively as the "Parties").

### RECITALS:

WHEREAS, the Grantor and the Beneficiary desire to create a trust account (the "Trust Account") for the benefit of the Beneficiary; and

WHEREAS, the Trustee has agreed to act as Trustee hereunder, and to hold assets in the Trust Account for the sole and exclusive use and benefit of the Beneficiary in accordance with the terms and conditions of this Trust Agreement; and

NOW, THEREFORE, for and in consideration of the premises and the promises and the mutual agreements hereinafter set forth, the Parties, intending to be legally bound, covenant and agree as follows:

### **Section 1. Deposit of Assets into the Trust Account.**

(a) The Grantor hereby establishes the Trust Account with the Trustee for the sole use and benefit of the Beneficiary, under the terms set forth herein. The Trustee shall administer the Trust Account in its name as Trustee for the sole use and benefit of the Beneficiary. The Trust Account shall be subject to withdrawal by the Beneficiary solely as provided herein. The Trustee hereby accepts the Trust Account upon the terms set forth in this Trust Agreement.

(b) The Grantor shall transfer to the Trustee, for deposit into the Trust Account, the assets listed on Exhibit A hereto, and may transfer to the Trustee, for deposit into the Trust Account, such other assets as it may from time to time desire to transfer or be required to transfer (all such assets actually received in the Trust Account are herein referred to individually as an "Asset" and collectively as the "Assets"). The Trustee is authorized and shall have power to receive the Assets from the Grantor and to hold, invest, reinvest and dispose of the same for the uses and purposes of and according to the provisions herein set forth. All Assets shall be maintained by the Trustee in the Trust Account separate and distinct from all other assets on the books of the Trustee and shall be continuously kept in a safe place at the Trustee's office within the United States of America. The Assets shall be valued according to their current fair market value and shall consist only of cash (United States legal tender) and Eligible Securities (as hereinafter defined). In the event of any payment default as to any Asset in the Trust Account or in the event that any Asset no longer is an Eligible Security, the Grantor shall, within five (5) business days after receiving notice from the Trustee pursuant to Section 17 or the Grantor having knowledge of such default or ineligibility, substitute other Assets which meet the requirements of an Eligible Security and having a current fair market value equal to the current

---

fair market value of such Asset, which has a payment default or no longer meets the requirements for an Eligible Security, on the last statement provided by the Trustee.

(c) The Grantor hereby represents and warrants (i) that any Assets transferred by the Grantor to the Trustee for deposit to the Trust Account will be in such form that the Beneficiary whenever necessary may, and the Trustee upon direction by the Beneficiary will, negotiate any such Assets without consent or signature from the Grantor or any other person or entity in accordance with the terms of this Trust Agreement, (ii) that all Assets transferred by the Grantor to the Trustee for deposit into the Trust Account consist only of cash and Eligible Securities, and (iii) that Grantor has at the time of transfer into this Trust Account good and marketable title to the Assets to be so transferred and each such Asset shall be at the time of transfer free and clear of all claims, liens, interests and encumbrances (other than those arising under this Trust Agreement).

(d) Prior to depositing the Assets into the Trust Account, and from time to time thereafter as required, the Grantor shall execute assignments, endorsement in blank, or transfer legal title to the Trustee of all shares, obligations or other Assets requiring assignments, so that the Beneficiary, whenever necessary may, and the Trustee upon the direction by the Beneficiary will, negotiate any such Assets without the consent or signature from the Grantor or any other person or entity. Any Assets received by the Trustee which are not in such proper negotiable form shall not be accepted by the Trustee and shall be returned to the Grantor as unacceptable. The Grantor shall give all notices and take all actions as the Trustee deems appropriate in order to cause payments due or that become due on any Asset within the Trust Account to be paid to the Trustee. The Grantor shall not make or consent to any waiver, amendment or restriction on transfer with respect to any Asset in the Trust Account, in each case, without the Beneficiary's prior written consent. In connection with the deposit of Assets into the Trust Account, the Grantor shall furnish to the Trustee all original documentation evidencing the Grantor's ownership thereto.

### **Section 2. Withdrawal of Assets from the Trust Account**

(a) Without notice to the Grantor, the Beneficiary shall have the right, at any time and from time to time, to withdraw from the Trust Account, subject only to written notice from the Beneficiary to the Trustee (the "Withdrawal Notice"), such Assets as are specified in such Withdrawal Notice. The Withdrawal Notice may designate a third party (the "Beneficiary Designee") to whom Assets specified therein shall be delivered. The Beneficiary shall not be required to present any other statement or document in addition to a Withdrawal Notice in order to withdraw any Assets, except that the Beneficiary shall acknowledge receipt of any such Assets withdrawn upon request by the Trustee; nor is said right of withdrawal or any other provision of this Trust Agreement subject to any conditions or qualifications not contained in this Trust Agreement.

(b) Upon receipt of a Withdrawal Notice, the Trustee shall immediately take any and all steps necessary to transfer absolutely and unequivocally all right, title and interest in the Assets specified in such Withdrawal Notice and shall deliver physical custody (or such other form as is necessary to complete the transfer) of such Assets to or for the account of the Beneficiary or such Beneficiary Designee, as specified in such Withdrawal Notice. The Trustee

---

shall notify the Grantor and Beneficiary within ten (10) days following each withdrawal from the Trust Account.

(c) Subject to Section 3, in the absence of a Withdrawal Notice, the Trustee shall allow no substitution or withdrawal of any Asset from the Trust Account.

**Section 3. Redemption, Investment and Substitution of Assets.**

(a) The Trustee shall surrender for payment all maturing Assets and all Assets called for redemption, and deposit the principal amount of the proceeds of any such payment to the Trust Account.

(b) The Grantor, subject to the prior written approval of the Beneficiary, may retain (and pay the service fees of) a professional asset manager (the "Asset Manager") to manage and make investment decisions with regard to the Assets held by the Trustee in the Trust Account. From time to time, at the written order and direction of the Grantor or the Asset Manager, the Trustee shall invest Assets in the Trust Account in Eligible Securities.

(c) From time to time, subject to the prior written approval of the Beneficiary, the Grantor or the Asset Manager may direct the Trustee to substitute Assets of equal current fair market value for other Assets presently held in the Trust Account. The Trustee shall have no responsibility whatsoever to determine the value of such substituted Assets or that such substituted Assets constitute Eligible Securities.

(d) All investments and substitutions of securities referred to in Sections 3(b) and 3(c) above shall be in compliance with the definition of "Eligible Securities" in Section 10 of this Trust Agreement. Any instruction or order concerning such investments or substitutions of securities shall be referred to herein as an "Investment Order". The Trustee shall execute Investment Orders and settle securities transactions by itself or by means of an agent or broker. The Trustee shall not be responsible for any act or omission, or for the solvency, of any such agent or broker, except as set forth in Section 6.

(e) From time to time, upon notice to the Beneficiary, the Trustee may withdraw any Asset in the Trust Account upon the call or maturity of such Asset provided that the proceeds from such call or maturity are deposited into the Trust Account.

(f) When the Trustee is directed to deliver Assets against payment, delivery will be made in accordance with generally accepted market practice.

(g) Any loss incurred from any investment pursuant to the terms of this Section 3 shall be borne exclusively by the Trust Account.

**Section 4. The Income Account.**

All payments of interest, dividends and other income in respect to Assets in the Trust Account shall be the property of the Grantor and shall be deposited by the Trustee, subject to deduction of the Trustee's compensation and expenses as provided in Section 7 of this Agreement, in a separate account (the "Income Account") established and maintained by the

---

Grantor at an office of the Trustee. Any interest, dividend or other income automatically posted and credited on the payment date to the Income Account which is not subsequently received by the Trustee shall be reimbursed by the Grantor to the Trustee and the Trustee may debit the Income Account for this purpose. The Grantor may withdraw amounts from the Income Account at any time and from time to time.

**Section 5. Right to Vote Assets.**

The Trustee shall forward all annual and interim stockholder reports and all proxies and proxy materials relating to the Assets in the Trust Account to the Grantor within a reasonable period of time following the Trustee's receipt thereof. The Grantor shall have the full and unqualified right to vote any shares of stock in the Trust Account.

**Section 6. Additional Rights and Duties of the Trustee**

(a) The Trustee shall be a bank which is a member of the Federal Reserve System of the United States of America or a New York State chartered bank or trust company and shall not be a parent, subsidiary or affiliate of the Grantor or the Beneficiary.

(b) Notwithstanding any provision of this Agreement to the contrary, the Trustee shall not be liable except for its own negligence, willful misconduct or lack of good faith arising out of or in connection with the performance of its obligations in accordance with this Trust Agreement.

(c) The Trustee shall have no responsibility whatsoever to determine that any Assets in the Trust Account are or continue to be Eligible Securities.

(d) The Trustee shall notify the Grantor and the Beneficiary in writing within ten (10) days following each deposit into, or withdrawal from, the Trust Account and shall notify the Grantor promptly of the receipt by the Trustee of any Withdrawal Notice.

(e) Before accepting any Asset for deposit to the Trust Account, the Trustee shall determine that such Asset is in such form that the Beneficiary whenever necessary may, or the Trustee upon direction by the Beneficiary will, negotiate such Asset without consent or signature from the Grantor or any person or entity other than the Trustee in accordance with the terms of this Trust Agreement.

(f) The Trustee shall be under no obligation to determine whether or not any instructions given by the Grantor and Beneficiary are contrary to any provision of law. It is understood and agreed that the Trustee's duties are solely those set forth herein and that the Trustee shall have no duty to take any other action unless specifically agreed to by the Trustee in writing. Without limiting the generality of the foregoing, the Trustee shall not have any duty to advise, manage, supervise or make recommendations with respect to the purchase, retention or sale of Assets with respect to any Assets in the Trust Account as to which a default in the payment of principal or interest has occurred or to be responsible for the consequences of insolvency or the legal inability of any broker, dealer, bank or other agent employed by the Grantor or Trustee with respect to the Assets except to the extent that the Trustee was negligent, engaged in misconduct or acted in bad faith in the selection of any such person or entity.

---

(g) The Trustee shall accept and open all mail directed to the Grantor or the Beneficiary in care of the Trustee.

(h) The Trustee shall furnish to the Grantor and the Beneficiary a statement of all Assets in the Trust Account upon the inception of the Trust Account and at the end of each quarter thereafter. The statement shall include a description of the Assets in the Trust Account and the then current market value of the Assets and shall be delivered within five (5) business days following the end of such quarter.

(i) The Trustee shall keep full and complete records of the administration of the Trust Account in accordance with all applicable law. Upon the request of the Grantor or the Beneficiary, the Trustee shall promptly permit the Grantor or the Beneficiary, their respective agents, employees, independent auditors and regulatory authorities to examine, audit, excerpt, transcribe and copy, during the Trustee's normal business hours, any books, documents, papers and records relating to the Trust Account or the Assets.

(j) Unless otherwise provided in this Trust Agreement, the Trustee is authorized to follow and rely upon all instructions given by officers of the Grantor or the Beneficiary and by attorneys-in-fact acting under written authority furnished to the Trustee by the Grantor or the Beneficiary, including, without limitation, instructions given by letter, facsimile transmission or electronic media, if the Trustee believes such instructions to be genuine and to have been signed, sent or presented by the proper party or parties. In the absence of negligence, the Trustee shall not incur any liability to anyone resulting from actions taken by the Trustee in reliance in good faith on such instructions. The Trustee shall not incur any liability in executing instructions (i) from any attorney-in-fact prior to receipt by it of notice of the revocation of the written authority of the attorney-in-fact or (ii) from any officer of the Grantor or the Beneficiary.

(k) The duties and obligations of the Trustee shall only be such as are specifically set forth in this Trust Agreement, as it may from time to time be amended, and no implied duties or obligations shall be read into this Trust Agreement against the Trustee.

(l) No provision of this Trust Agreement shall require the Trustee to take any action which, in the Trustee's reasonable judgment, would result in any violation of this Trust Agreement or any provision of law.

(m) The Trustee may confer with counsel of its own choice in relation to matters arising under this Trust Agreement and shall have full and complete authorization from the other Parties for any action taken or suffered by it under this Trust Agreement or in respect of any transaction contemplated hereby in good faith and in accordance with the opinion of such counsel.

(n) The Trustee shall notify the Grantor and Beneficiary in writing of any payment default occurring as to any Asset within three (3) business days after Trustee receives notice of such default. In the event of a delinquency of a timely payment in regard to any of the Assets, the Trustee shall inform the Grantor and the Beneficiary immediately upon Trustee's receipt of notice of such delinquency (which shall be confirmed in writing by the Trustee within two (2) business days thereof).

---

(o) The Trustee shall be liable for (i) the safekeeping of the Assets and administering the Trust Account in accordance with the provisions of this Trust Agreement and (ii) its own negligence, willful misconduct or lack of good faith in performing its duties under this Trust Agreement. The Trustee shall exercise the standard of care with respect to the Assets that a professional trustee, engaged in the banking or trust company industry, having professional expertise in financial and securities processing transactions and custody would observe in such affairs. The Trustee shall be responsible for physical loss of or damage to Assets under its care, custody, possession or control, including but not limited to loss due to fire, burglary, robbery, theft or mysterious disappearance. In the event of loss or damage to the Assets under the care, custody, possession or control of Trustee, Trustee shall, upon demand of the Grantor or Beneficiary, promptly replace such Assets with like kind and quality together with, all rights and privileges pertaining to the Assets (by among other methods, posting appropriate security or bond with the issuer of the Assets to obtain reissue of such Assets, or, if acceptable to the Grantor, deliver cash equivalent to the market value of the Assets as of the date of the discovery of the loss or damage). Nothing contained in any contract between Trustee and any entity authorized to hold Assets, as defined herein, shall diminish or otherwise alter the liability of Trustee to the Grantor or Beneficiary. The provisions of this paragraph shall not affect the burden of proof under applicable law with respect to the assertions of liability in any claim, action or dispute alleging any breach of or failure to observe such standard of care.

#### **Section 7. The Trustee's Compensation; Expenses.**

(a) The Grantor shall pay the Trustee, as compensation for its services under this Trust Agreement, a fee computed at rates determined by the Trustee from time to time and communicated in writing to the Grantor. The Grantor shall pay or reimburse the Trustee for all of the Trustee's expenses and disbursements in connection with its duties under this Trust Agreement (including reasonable attorney's fees and expenses), except any such expense or disbursement as may arise from the Trustee's negligence, willful misconduct, lack of good faith or failure to administer the Trust Account in accordance with the terms of this Trust Agreement. The Trustee shall be entitled to deduct its compensation and expenses from payments of dividends, interest and other income in respect of the Assets held in the Trust Account prior to the deposit thereof to the Income Account as provided in Section 4 of this Agreement. The Grantor also hereby indemnifies the Trustee for, and holds it harmless against, any loss, liability, costs or expenses (including reasonable attorney's fees and expenses) incurred or made without negligence, willful misconduct or lack of good faith on the part of the Trustee, arising out of or in connection with the performance of its obligations in accordance with the provisions of this Trust Agreement (which shall be the sole obligation of the Trustee), including any loss, liability, costs or expenses arising out of or in connection with the status of the Trustee and its nominee as the holder of record of the Assets. The Grantor hereby acknowledges that the foregoing indemnities shall survive the resignation of the Trustee or the termination of this Trust Agreement and hereby grants the Trustee a lien, right of set-off and security interest in the funds in the Income Account for the payment of any claim for compensation, reimbursement or indemnity hereunder.

(b) No Assets shall be withdrawn from the Trust Account or used in any manner for paying compensation to, or reimbursement or indemnification of, the Trustee.

---

#### **Section 8. Resignation or Removal of the Trustee.**

(a) The Trustee may resign at any time upon delivery of a written notice thereof to the Beneficiary and to the Grantor effective not less than ninety (90) days after receipt by the Beneficiary and the Grantor of such notice. The Trustee may be removed by the Grantor's delivery to the Trustee and the Beneficiary of a written notice of removal, effective not less than ninety (90) days after receipt by the Trustee and the Beneficiary of such notice. The Trustee may also be removed by prior written notice executed by the Grantor and the Beneficiary. No such resignation or removal shall become effective until a successor Trustee has been appointed and approved by the Beneficiary and the Grantor and all Assets in the Trust Account have been duly transferred to the successor Trustee in accordance with paragraph (b) of this Section 8.

(b) Upon receipt by the proper Parties of the Trustee's notice of resignation or the Grantor's or the Grantor's and the Beneficiary's notice of removal, as applicable, the Grantor and the Beneficiary shall appoint a successor Trustee. Any successor Trustee shall be a bank that is a member of the Federal Reserve System of the United States of America or a New York State chartered bank or trust company and must not be a parent, a subsidiary or an affiliate of the Grantor or the Beneficiary. Upon the acceptance of the appointment as Trustee hereunder by a successor Trustee and the transfer to such successor Trustee of all Assets in the Trust Account, the resignation or removal of the Trustee shall become effective. Thereupon, such successor Trustee shall succeed to and become vested with all the rights, powers, privileges and duties of the resigning or removed Trustee, and the resigning or removed Trustee shall be discharged from any future duties and obligations under this Trust Agreement, but the resigning or removed Trustee shall continue after such resignation or removal to be entitled to the benefits of the indemnities provided herein for the Trustee.

#### **Section 9. Termination of the Trust Account.**

The Trust Account and this Trust Agreement shall be effective until terminated by sixty (60) days' advance written notice sent to the Trustee by the Grantor. Written notice of termination shall be delivered by the Trustee to the Beneficiary at least thirty (30) but not more than forty-five (45) days prior to termination. Upon the termination

of the Trust Account, the Trustee shall, with the Beneficiary's prior written consent, transfer to the Grantor all of the Assets of the Trust Account and Income Account not previously withdrawn by the Beneficiary.

**Section 10. Definitions.**

Except as the context shall otherwise require, the following terms shall have the following meanings for purposes of this Trust Agreement (the definitions to be applicable to both the singular and the plural forms of each term defined if both forms of such term are used in this Trust Agreement):

The term "Beneficiary" shall include any successor of the Beneficiary by operation of law, including, without limitation, any liquidator, rehabilitator, receiver or conservator.

The term "Eligible Securities" shall mean and include certificates of deposit (issued by a United States bank and payable in United States legal tender) and investments of the types specified in paragraphs (1), (2), (3), (8) and (10) of Section 1404(a) of the New York Insurance

---

Law; provided, however, that such investments are issued by an institution that is not the parent, a subsidiary or an affiliate of either the Grantor or the Beneficiary.

The terms "Person" shall mean and include an individual, a corporation, a partnership, an association, a trust, an unincorporated organization or a government or political subdivision thereof.

**Section 11. Governing Law.**

This Trust Agreement shall be subject to and governed by the laws of the State of New York, without regard to its conflict of laws provision and the Trust Account created hereunder shall be administered in accordance with the laws of said state.

**Section 12. WAIVER OF JURY TRIAL.**

**EACH PARTY HERETO HEREBY WAIVES TRIAL BY JURY IN ANY JUDICIAL PROCEEDING INVOLVING, DIRECTLY OR INDIRECTLY, ANY MATTER (WHETHER SOUNDING IN TORT, CONTRACT OR OTHERWISE) IN ANY WAY ARISING OUT OF OR RELATED TO THIS AGREEMENT OR THE RELATIONSHIP ESTABLISHED HEREUNDER. THIS PROVISION IS A MATERIAL INDUCEMENT FOR THE PARTIES TO ENTER INTO THIS AGREEMENT.**

**Section 13. Successors and Assigns.**

This Trust Agreement shall be binding upon and inure to the benefit of the Parties and their respective successors, permitted assigns and legal representatives. Neither this Trust Agreement, nor any right or obligation hereunder, may be assigned by any Party without the prior written consent of the other Parties hereto. Any assignment in violation of this Section 13 shall be void and shall have no force and effect.

**Section 14. Severability.**

If any provision of this Trust Agreement is held to be void or unenforceable, in whole or in part, (i) such holding shall not affect the validity and enforceability of the remainder of this Trust Agreement, including any other provision, paragraph or subparagraph, and (ii) the Parties agree to attempt in good faith to reform such void or unenforceable provision to the extent necessary to render such provision enforceable and to carry out its original intent.

**Section 15. Entire Agreement.**

This Trust Agreement constitutes the entire agreement among the Parties with respect to the subject matter hereof, and there are no understandings or agreements, conditions or qualifications relative to this Trust Agreement which are not fully expressed in this Trust Agreement.

---

**Section 16. Amendments.**

This Trust Agreement may be modified or otherwise amended, and the observance of any term of this Trust Agreement may be waived, only if such modification, amendment or waiver is in writing and signed by the Parties.

**Section 17. Notices.**

All notices, requests, demands and other communications under this Trust Agreement must be in writing and will be deemed to have been duly given or made as follows: (a) if sent by registered or certified mail in the United States return receipt requested, upon receipt; (b) if sent by reputable overnight air courier, two business days after mailing; (c) if sent by facsimile transmission, with a copy mailed on the same day in the manner provided in (a) or (b) above, when transmitted and receipt is confirmed by telephone; or (d) if otherwise actually personally delivered, when delivered, and shall be delivered as follows:

If to the Grantor:

Federal Home Life Insurance Company  
6620 West Broad Street  
Richmond, VA 23230  
Facsimile: (804) 662-2414  
Attention: Chief Executive Officer

With a copy to:

Federal Home Life Insurance Company  
700 Main Street  
Lynchburg, VA 24504  
Facsimile: (434) 948-5819  
Attention: General Counsel



If to the Beneficiary:

Union Fidelity Life Insurance Company  
200 North Martingale Road  
Schaumburg, IL 60173-2096  
Facsimile: (847) 330-3404  
Attention: Chief Financial Officer

With a copy to:

Union Fidelity Life Insurance Company  
200 North Martingale Road  
Schaumburg, IL 60173-2096  
Facsimile: (847) 605-3044  
Attention: General Counsel

---

If to the Trustee:

The Bank of New York  
101 Barclay Street - 8W  
New York, NY 10283  
Facsimile: (212) 815-5875  
Attention: Insurance Trust and Escrow Unit

or to such other address or to such other Person as a Party may have last designated by notice to the other Parties.

**Section 18. Headings.**

The headings of the Sections have been inserted for convenience of reference only and shall not be deemed to constitute a part of this Trust Agreement.

**Section 19. Counterparts.**

This Trust Agreement may be executed in any number of counterparts, each of which when so executed and delivered shall constitute an original, but such counterparts together shall constitute but one and the same Trust Agreement.

---

**IN WITNESS WHEREOF**, the parties hereto have caused this Trust Agreement to be executed and delivered by their respective officers thereunto duly authorized as of the date first above written.

FEDERAL HOME LIFE INSURANCE  
COMPANY, as Grantor

By: \_\_\_\_\_  
Name:  
Title:

UNION FIDELITY LIFE INSURANCE  
COMPANY, as Beneficiary

By: \_\_\_\_\_  
Name:  
Title:

THE BANK OF NEW YORK, as Trustee

By: \_\_\_\_\_  
Name:  
Title:

---

**EXHIBIT A**

**Assets**

---

## BUSINESS ASSOCIATE ADDENDUM

### I. Purpose.

In order to disclose certain information to the party providing a service under this Agreement (“Provider”) under this Addendum, some of which may constitute Protected Health Information (defined below), the party to whom a service under this Agreement is being provided (“Recipient”) and Provider mutually agree to comply with the terms of this Addendum for the purpose of satisfying the requirements of the Health Insurance Portability and Accountability Act of 1996 (“HIPAA”) and its implementing privacy regulations at 45 C.F.R. Parts 160-164 (“HIPAA Privacy Rule”). These provisions shall apply to Provider to the extent that Provider is considered a “Business Associate” under the HIPAA Privacy Rule and all references in this section to Business Associates shall refer to Provider. Capitalized terms not otherwise defined herein shall have the meaning assigned in the Agreement. Notwithstanding anything else to the contrary in the Agreement, in the event of a conflict between this Addendum and the Agreement, the terms of this Addendum shall prevail.

### II. Permitted Uses and Disclosures.

A. Business Associate agrees to use or disclose Protected Health Information (“PHI”) that it creates for or receives from Recipient or its Subsidiaries only as follows. The capitalized term “Protected Health Information or PHI” has the meaning set forth in 45 Code of Federal Regulations Section 164.501, as amended from time to time. Generally, this term means individually identifiable health information including, without limitation, all information, data and materials, including without limitation, demographic, medical and financial information, that relates to the past, present, or future physical or mental health or condition of an individual; the provision of health care to an individual; or the past present, or future payment for the provision of health care to an individual; and that identifies the individual or with respect to which there is a reasonable basis to believe the information can be used to identify the individual. This definition shall include any demographic information concerning members and participants in, and applicants for, Recipient’s or its Subsidiaries’ health benefit plans. All other terms used in this Addendum shall have the meanings set forth in the applicable definitions under the HIPAA Privacy Rule.

B. Functions and Activities on Company’s Behalf. Business Associate is permitted to use and disclose PHI it creates for or receives from Recipient or its Subsidiaries only for the purposes described in this Addendum or the Agreement that are not inconsistent with the provisions of this Addendum, or as required by law, or following receipt of prior written approval from whichever of the Recipient or its Subsidiary for which the relevant PHI was created or from which the relevant PHI was received. In addition to these specific requirements below, Business Associate may use or disclose PHI only in a manner that would not violate the HIPAA Privacy Rule if done by the Recipient or its Subsidiaries.

C. Business Associate’s Operations. Business Associate is permitted by this Agreement to use PHI it creates for or receives from Recipient or its Subsidiaries: (i) if such

---

use is reasonably necessary for Business Associate’s proper management and administration; and (ii) as reasonably necessary to carry out Business Associate’s legal responsibilities. Business Associate is permitted to disclose PHI it creates for or receives from Recipient or its Subsidiaries for the purposes identified in this Section only if the following conditions are met:

- (1) The disclosure is required by law; or
- (2) The disclosure is reasonably necessary to Business Associate’s proper management and administration, and Business Associate obtains reasonable assurances in writing from any person or organization to which Business Associate will disclose such PHI that the person or organization will:
  - a. Hold such PHI as confidential and use or further disclose it only for the purpose for which Business Associate disclosed it to the person or organization or as required by law; and
  - b. Notify Business Associate (who will in turn promptly notify whichever of the Recipient or its Subsidiary for which the relevant PHI was created or from which the relevant PHI was received) of any instance of which the person or organization becomes aware in which the confidentiality of such PHI was breached.

D. Minimum Necessary Standard. In performing the functions and activities on Recipient’s or its Subsidiaries’ behalf pursuant to the Agreement, Business Associate agrees to use, disclose or request only the minimum necessary PHI to accomplish the purpose of the use, disclosure or request. Business Associate must have in place policies and procedures that limit the PHI disclosed to meet this minimum necessary standard.

E. Prohibition on Unauthorized Use or Disclosure. Business Associate will neither use nor disclose PHI it creates or receives for or from Recipient, its Subsidiaries, or from another business associate of Recipient or its Subsidiaries, except as permitted or required by this Addendum or the Agreement that are not inconsistent with the provisions of this Addendum, or as required by law, or following receipt of prior written approval from whichever of the Recipient or its Subsidiary for which the relevant PHI was created or from which the relevant PHI was received.

F. De-identification of Information. Business Associate agrees neither to de-identify PHI it creates for or receives from Recipient or its Subsidiaries or from another business associate of Recipient or its Subsidiaries, nor use or disclose such de-identified PHI, unless such de-identification is expressly permitted under the terms and conditions of this Addendum or the Agreement and related to Recipient’s or its Subsidiaries’ activities for purposes of “treatment”, “payment” or “health care operations”, as those terms are defined under the HIPAA Privacy Rule. De-identification of PHI, other than as expressly permitted under the terms and conditions of the Addendum for Business Associate to perform services for Recipient or its Subsidiaries, is not a permitted use of PHI under this Addendum. Business Associate further

associate of Recipient or its Subsidiaries, nor use or disclose such Limited Data Set unless: (i) such creation, use or disclosure is expressly permitted under the terms and conditions of this Addendum or the Agreement that are not inconsistent with the provisions of this Addendum; and such creation, use or disclosure is for services provided by Business Associate that relate to Recipient's or its Subsidiaries' activities for purposes of "treatment", "payment" or "health care operations", as those terms are defined under the HIPAA Privacy Rule.

G. Information Safeguards. Business Associate will develop, document, implement, maintain and use appropriate administrative, technical and physical safeguards to preserve the integrity and confidentiality of and to prevent non-permitted use or disclosure of PHI created for or received from Recipient or its Subsidiaries. These safeguards must be appropriate to the size and complexity of Business Associate's operations and the nature and scope of its activities. Business Associate agrees that these safeguards will meet any applicable requirements set forth by the U.S. Department of Health and Human Services, including (as of the effective date or as of the compliance date, whichever is applicable) any requirements set forth in the final HIPAA security regulations. Business Associate agrees to mitigate, to the extent practicable, any harmful effect that is known to Business Associate resulting from a use or disclosure of PHI by Business Associate in violation of the requirements of this Addendum.

III. Conducting Standard Transactions. In the course of performing services for Recipient or its Subsidiaries, to the extent that Business Associate will conduct Standard Transactions for or on behalf of Recipient or its Subsidiaries, Business Associate will comply, and will require any subcontractor or agent involved with the conduct of such Standard Transactions to comply, with each applicable requirement of 45 C.F.R. Part 162. "Standard Transaction(s)" shall mean a transaction that complies with the standards set forth at 45 C.F.R. parts 160 and 162. Further, Business Associate will not enter into, or permit its subcontractors or agents to enter into, any trading partner agreement in connection with the conduct of Standard Transactions for or on behalf of the Recipient or its Subsidiaries that:

- a. Changes the definition, data condition, or use of a data element or segment in a Standard Transaction;
- b. Adds any data element or segment to the maximum defined data set;
- c. Uses any code or data element that is marked "not used" in the Standard Transaction's implementation specification or is not in the Standard Transaction's implementation specification; or
- d. Changes the meaning or intent of the Standard Transaction's implementation specification.

IV. Sub-Contractors, Agents or Other Representatives. Business Associate will require any of its subcontractors, agents or other representatives to which Business Associate is permitted by this Addendum or the Agreement (or is otherwise given Recipient's or the relevant Subsidiary's prior written approval) to disclose any of the PHI Business Associate creates or receives for or

---

from Recipient or its Subsidiaries, to provide reasonable assurances in writing that subcontractor or agent will comply with the same restrictions and conditions that apply to the Business Associate under the terms and conditions of this Addendum with respect to such PHI.

V. Protected Health Information Access, Amendment and Disclosure Accounting.

A. Access. Business Associate will promptly upon Recipient's or its Subsidiary's request make available to Recipient, its Subsidiary, or, at Recipient's or such Subsidiary's direction, to the individual (or the individual's personal representative) for inspection and obtaining copies any PHI about the individual which Business Associate created for or received from Recipient or its Subsidiary and that is in Business Associate's custody or control, so that Recipient or its Subsidiary may meet its access obligations under 45 Code of Federal Regulations § 164.524.

B. Amendment. Upon Recipient's or its Subsidiary's request Business Associate will promptly amend or permit Recipient or its Subsidiary access to amend any portion of the PHI which Business Associate created for or received from Recipient or its Subsidiary, and incorporate any amendments to such PHI, so that Recipient or its Subsidiary may meet its amendment obligations under 45 Code of Federal Regulations § 164.526.

C. Disclosure Accounting. So that Recipient or its Subsidiaries may meet their disclosure accounting obligations under 45 Code of Federal Regulations § 164.528:

1. Disclosure Tracking. Business Associate will record for each disclosure, not excepted from disclosure accounting under Section V.C.2 below, that Business Associate makes to Recipient or its Subsidiaries of PHI that Business Associate creates for or receives from Recipient or its Subsidiaries, (i) the disclosure date, (ii) the name and member or other policy identification number of the person about whom the disclosure is made, (iii) the name and (if known) address of the person or entity to whom Business Associate made the disclosure, (iv) a brief description of the PHI disclosed, and (v) a brief statement of the purpose of the disclosure (items i-v, collectively, the "disclosure information"). For repetitive disclosures Business Associate makes to the same person or entity (including Recipient or its Subsidiaries) for a single purpose, Business Associate may provide a) the disclosure information for the first of these repetitive disclosures, (b) the frequency, periodicity or number of these repetitive disclosures and (c) the date of the last of these repetitive disclosures. Business Associate will make this disclosure information available to Recipient or its Subsidiaries promptly upon Recipient's or its Subsidiaries' request.

2. Exceptions from Disclosure Tracking. Business Associate need not record disclosure information or otherwise account for disclosures of PHI that this Addendum or Recipient or the relevant Subsidiary in writing permits or requires (i) for the purpose of Recipient's or its Subsidiaries' treatment activities, payment activities, or health care operations, (ii) to the individual who is the subject of the PHI disclosed or to that individual's personal representative; (iii) to persons involved in that individual's health care or payment for health care; (iv) for notification for disaster relief purposes, (v) for national security or intelligence purposes, (vi) to law enforcement officials or correctional

---

institutions regarding inmates; or (vii) pursuant to an authorization; (viii) for disclosures of certain PHI made as part of a Limited Data Set; (ix) for certain incidental disclosures that may occur where reasonable safeguards have been implemented; and (x) for disclosures prior to April 14, 2003.

3. Disclosure Tracking Time Periods. Business Associate must have available for Recipient and its Subsidiaries the disclosure information required by this section for the 6 years preceding Recipient's or its Subsidiaries' request for the disclosure information (except Business Associate need have no disclosure

information for disclosures occurring before April 14, 2003).

VI. Additional Business Associate Provisions

A. Reporting of Breach of Privacy Obligations. Business Associate will provide written notice to whichever of the Recipient or its Subsidiary for which the relevant PHI was created or from which the relevant PHI was received of any use or disclosure of PHI that is neither permitted by this Addendum nor given prior written approval by Recipient or the relevant Subsidiary promptly after Business Associate learns of such non-permitted use or disclosure. Business Associate's report will at least:

- (ii) Identify the nature of the non-permitted use or disclosure;
- (iii) Identify the PHI used or disclosed;
- (iv) Identify who made the non-permitted use or received the non-permitted disclosure;
- (v) Identify what corrective action Business Associate took or will take to prevent further non-permitted uses or disclosures;
- (vi) Identify what Business Associate did or will do to mitigate any deleterious effect of the non-permitted use or disclosure; and
- (vii) Provide such other information, including a written report, as Recipient or the relevant Subsidiary may reasonably request.

B. Amendment. Upon the effective date of any final regulation or amendment to final regulations promulgated by the U.S. Department of Health and Human Services with respect to PHI, including, but not limited to the HIPAA privacy and security regulations, this Addendum and the Agreement will automatically be amended so that the obligations they impose on Business Associate remain in compliance with these regulations.

In addition, to the extent that new state or federal law requires changes to Business Associate's obligations under this Addendum, this Addendum shall automatically be amended to include such additional obligations, upon notice by Recipient or its Subsidiaries to Business Associate of such obligations. Business Associate's continued performance of services under the Agreement shall be deemed acceptance of these additional obligations.

---

C. Audit and Review of Policies and Procedures. Business Associate agrees to provide, upon Recipient request, access to and copies of any policies and procedures developed or utilized by Business Associate regarding the protection of PHI. Business Associate agrees to provide, upon Recipient's request, access to Business Associate's internal practices, books, and records, as they relate to Business Associate's services, duties and obligations set forth in this Addendum and the Agreement(s) under which Business Associate provides services and / or products to or on behalf of Recipient or its Subsidiaries, for purposes of Recipient's or its Subsidiaries' review of such internal practices, books, and records.

---

**CAPITAL MAINTENANCE AGREEMENT**

Capital Maintenance Agreement (this "AGREEMENT") dated as of January 1, 2004 (the "Effective Date") between General Electric Capital Corporation, a Delaware corporation ("GECC"), and Union Fidelity Life Insurance Company, an Illinois-domiciled stock life insurance company ("UFLIC").

WHEREAS, GECC is an indirect intermediate parent company of UFLIC;

WHEREAS, pursuant to the reinsurance agreements set forth on Exhibit A hereto (as such agreements may be amended from time to time hereafter, the "Reinsurance Agreements"), UFLIC has reinsured certain books of insurance and reinsurance written by American Mayflower Life Insurance Company of New York, a New York-domiciled stock life insurance company ("AML"), Federal Home Life Insurance Company, a Virginia-domiciled stock life insurance company ("FHL"), First Colony Life Insurance Company, a Virginia-domiciled stock life insurance company ("FCL"), GE Capital Life Assurance Company of New York, a New York-domiciled stock life insurance company ("GECLANY"), GE Life and Annuity Assurance Company, a Virginia-domiciled stock life insurance company ("GELAAC"), and General Electric Capital Assurance Company, a Delaware-domiciled stock life insurance company ("GECA") (AML, FHL, FCL, GECLANY, GELAAC and GECA are referred to collectively as the "Ceding Companies"); and

WHEREAS, GECC has determined that its corporate interests will be furthered by its entering into this Agreement.

NOW, THEREFORE, in consideration of the material covenants and undertakings set forth in this Agreement, and other good and valuable consideration, the parties hereto agree as follows.

1. Maintenance of Capital. (a) During the term of this Agreement, GECC agrees to maintain sufficient capital in UFLIC to ensure that UFLIC is able to maintain a minimum capital level at the end of each calendar quarter in the amount of 150% of the Company Action Level risk based capital requirements as defined from time to time by the National Association of Insurance Commissioners (together with any successor organization or regulatory agency having similar duties, the "NAIC") (as may be modified by the last sentence of this paragraph, the "Capital Threshold"). In the event that, at the end of any calendar quarter during the term of this Agreement, UFLIC's capital level is below the Capital Threshold, GECC shall restore UFLIC's capital level to the Capital Threshold within 65 days of the end of such calendar quarter. In the event that, at any time during the term of this Agreement, GECC or UFLIC has reason to believe that UFLIC's capital level has fallen below the Capital Threshold, GECC shall take actions reasonably designed to restore UFLIC's capital level to the Capital Threshold, it being understood that a precise determination of the amount of capital required by UFLIC to meet the Capital Threshold as of a date other than a quarter end is not practicable and that GECC's obligations under this sentence shall be on the basis of estimates thereof prepared in good faith by UFLIC. For purposes of this Agreement: (i) if the NAIC ceases to use the term "Company

---

Action Level" in its risk based capital requirements, then "Company Action Level" as used in this Section 1 shall mean the comparable term then used by the NAIC; (ii) if the NAIC modifies the method of calculating risk based capital, then GECC shall maintain UFLIC's capital at 150% of the Company Action Level determined in accordance with the risk based capital requirements as so modified and (iii) if the NAIC ceases to establish risk based capital requirements, then GECC shall maintain UFLIC's capital at 150% of the Company Action Level risk based capital requirements as such requirements were last established by the NAIC.

(b) For purposes of this Agreement, UFLIC's risk based capital levels will be calculated as follows: quarterly risk-based capital will be calculated consistent with procedures applied for the NAIC risk-based capital calculation for UFLIC's Annual Statement filing. For calculations as of a date other than the end of the year, the C3 component of the risk based capital calculation will be adjusted by the ratio from stochastic testing at the end of the prior year. In 2004, this stochastic adjustment will be set at the maximum possible level. Also in 2004, the income statement amounts (including, but not limited to, premiums and expenses) required for the calculation will be annualized as follows in the quarterly calculation: 1st quarter/three months multiplied by 4, 2nd quarter/six months multiplied by 2, 3rd quarter/nine months multiplied by 1.333. In 2005 and thereafter, income statement amounts (including, but not limited to, premiums and expenses) required for the calculation will utilize the prior 12 months result.

2. Nature of Obligation. GECC expressly agrees that its undertaking provided herein shall be an absolute, unconditional, present and continuing obligation during the term of this Agreement.

3. Representations and Warranties. GECC represents and warrants that: (i) it is a corporation duly organized, validly existing and in good standing under the laws of the State of Delaware; (ii) it has all requisite corporate or other power and authority and has taken all corporate or other action necessary in order to execute, deliver and perform this Agreement and to perform its obligations hereunder; (iii) this Agreement has been duly executed and delivered by it and constitutes a valid and binding agreement of GECC enforceable in accordance with the terms hereof; and (iv) the execution, delivery and performance by GECC of this Agreement do not and will not conflict with, or result in any breach or violation of, its articles of incorporation or by-laws, any order, decree, statute, law, ordinance, rule or regulation applicable to it, or any agreement to which it is a party or by which it or any of its assets is bound.

4. Termination. This Agreement shall terminate (i) on the date as of which all of the obligations of UFLIC under the Reinsurance Agreements are fully and finally discharged or (ii) by agreement of the parties hereto with prior written consent of the Ceding Companies and the insurance regulatory authorities of Delaware, Illinois, New York and Virginia (collectively, together with any successor regulatory agencies having similar powers, the "Domestic Regulators").

5. No Third Party Beneficiaries. Except for the rights of the Ceding Companies set forth in Sections 4, 11, 12 and 13 or as otherwise expressly provided in this Agreement, the obligations of GECC herein are intended for the sole benefit of UFLIC and nothing in this Agreement shall be deemed to create rights or interests in any third party, including without

limitation any payee, contract holder, third party or beneficiary under any insurance policy issued by UFLIC.

6. Governing Law. This Agreement shall be governed by and construed and interpreted in accordance with the laws of the State of Illinois, irrespective of the choice of law principles of the State of Illinois. Any proceeding to resolve a dispute arising out of or related to this Agreement may be brought in any Federal or state court in Delaware, Illinois, New York or Virginia. The parties consent to service and jurisdiction of such courts.

7. Remedies. Without limiting the rights of UFLIC to pursue any and all other legal and equitable rights available to UFLIC for GECC's failure to perform its obligations under this Agreement, GECC acknowledges and agrees that remedies at law for any failure to perform its obligations hereunder would be inadequate and that UFLIC shall be entitled to specific performance, injunctive relief or other equitable remedies in the event of any such failure.

8. Notices. All notices, requests, claims, demands and other communications under this Agreement shall be in writing and shall be given or made (and shall be deemed to have been duly given or made upon receipt) by delivery in person, by overnight courier service, by facsimile with receipt confirmed (followed by delivery of an original via overnight courier service) or by registered or certified mail (postage prepaid, return receipt requested) to the respective parties at the following addresses (or at such other address for a party as shall be specified in a notice given in accordance with this Section 8):

If to UFLIC to:

Union Fidelity Life Insurance Company  
200 North Martingale Road  
Schaumburg, IL 60173-2096  
Fax: (847) 330-3404  
Attn: Chief Financial Officer

With a copy to:  
Union Fidelity Life Insurance Company  
200 North Martingale Road  
Schaumburg, IL 60173-2096  
Fax: (847) 605-3044  
Attn: General Counsel

If to GECC to:

General Electric Capital Corporation  
201 High Ridge Road  
Stamford, CT 06927  
Fax: (203) 357-4975  
Attn: Senior Vice President

3

---

With a copy to:  
General Electric Capital Corporation  
201 High Ridge Road  
Stamford, CT 06927  
Fax: (203) 357-3490  
Attn: General Counsel

9. Severability. If any term or other provision of this Agreement is invalid, illegal or incapable of being enforced under any law or as a matter of public policy, all other conditions and provisions of this Agreement shall nevertheless remain in full force and effect. Upon such determination that any term or other provision is invalid, illegal or incapable of being enforced, the parties to this Agreement shall negotiate in good faith to modify this Agreement so as to effect the original intent of the parties as closely as possible in a mutually acceptable manner in order that the transactions contemplated by this Agreement be consummated as originally contemplated to the greatest extent possible. Any such modification shall be subject to the provisions of Section 12.

10. Entire Agreement. This Agreement constitutes the entire agreement of the parties hereto with respect to the subject matter of this Agreement and supercedes all prior agreements and understandings, both written and oral, between or on behalf of the parties hereto with respect to the subject matter of this Agreement.

11. Successors and Assigns. This Agreement shall bind and inure to the benefit of the parties hereto and each and all of their respective successors and permitted assigns. This Agreement may not be assigned by the parties hereto except that GECC shall be permitted to assign this Agreement, and upon such assignment shall be released from all obligations hereunder, if each of UFLIC, the Domestic Regulators and the Ceding Companies provide prior consent to such assignment in writing; provided, however, that the Ceding Companies shall not unreasonably withhold such consent.

12. Amendment. No provision of this Agreement may be amended or modified except by a written instrument signed by the parties hereto; provided, however, that no such amendment or modification shall be effective unless the Domestic Regulators and the Ceding Companies provide prior consent to such amendment or modification in writing; and provided, further, that the Ceding Companies shall not unreasonably withhold such consent.

13. Enforcement. UFLIC, any of the Domestic Regulators and any of the Ceding Companies (including any conservator, liquidator, receiver or statutory successor of UFLIC or any of the Ceding Companies) may enforce UFLIC's rights hereunder notwithstanding any waiver by UFLIC; provided, however, that GECC shall reimburse the Domestic Regulators for their reasonable costs (including reasonable fees and disbursement of legal counsel) incurred in enforcing UFLIC's rights under this Agreement in the event that UFLIC fails to enforce such rights reasonably promptly hereunder and such Domestic Regulators have provided GECC with prior notice of their intent to proceed at GECC's cost. Failure on the part of any party to act or

4

---

declare any other party in default shall not constitute a waiver by such party of any of its rights hereunder where such default has occurred and is continuing.

14. Rules of Construction. Interpretation of this Agreement shall be governed by the following rules of construction: (i) words in the singular shall be held to include the plural and vice versa and words of one gender shall be held to include the other gender as the context requires; (ii) references to the terms Section and Exhibit are references to the Sections and Exhibits to this Agreement unless otherwise specified; (iii) the word "including" and words of similar import shall mean "including, without limitation;" (iv) the headings contained herein are for reference purposes only and shall not affect in any way the meaning or interpretation of this Agreement; and (v) this Agreement shall be construed without regard to any presumption or rule requiring construction or interpretation against the party drafting or causing any instrument to be drafted.

5

---

IN WITNESS WHEREOF, the parties hereto have caused this Agreement to be executed and delivered as of the day and year first written above by their respective duly authorized officers.

GENERAL ELECTRIC CAPITAL CORPORATION

By: /s/ JAMES A. PARKE  
Name: James A. Parke  
Title: Vice Chairman and Chief Financial Officer

By: /s/ GLENN JOPPA  
Name: Glenn Joppa  
Title: Senior Vice President and Secretary

Acknowledged and Accepted  
with respect to Sections 11 and 12:

AMERICAN MAYFLOWER LIFE INSURANCE COMPANY OF NEW YORK

By: /s/ VICTOR C. MOSES  
Name: Victor C. Moses  
Title: Senior Vice President and Chief Actuary

FEDERAL HOME LIFE INSURANCE COMPANY

By: /s/ VICTOR C. MOSES  
Name: Victor C. Moses  
Title: Senior Vice President

FIRST COLONY LIFE INSURANCE COMPANY

By: /s/ WARD BOBITZ  
Name: Ward Bobitz  
Title: Vice President

GE CAPITAL LIFE ASSURANCE COMPANY OF NEW YORK

By: /s/ VICTOR C. MOSES  
Name: Victor C. Moses  
Title: Senior Vice President

GE LIFE AND ANNUITY ASSURANCE COMPANY

By: /s/ VICTOR C. MOSES  
Name: Victor C. Moses  
Title: Vice President

GENERAL ELECTRIC CAPITAL ASSURANCE COMPANY

By: /s/ VICTOR C. MOSES  
Name: Victor C. Moses  
Title: Senior Vice President and Chief Actuary

**Exhibit A**

**Reinsurance Agreements**

1. Retrocession Agreement between GE Capital Life Assurance Company of New York and Union Fidelity Life Insurance Company, effective as of January 1, 2004 (Long Term Care)
2. Retrocession Agreement between General Electric Capital Assurance Company and Union Fidelity Life Insurance Company, effective as of January 1, 2004 (Long Term Care)
3. Coinsurance Agreement between GE Capital Life Assurance Company of New York and Union Fidelity Life Insurance Company, effective as of January 1, 2004 (Structured Settlement Annuities)
4. Coinsurance Agreement between General Electric Capital Assurance Company and Union Fidelity Life Insurance Company, effective as of January 1, 2004 (Structured Settlement Annuities)
5. Coinsurance Agreement between GE Life and Annuity Assurance Company and Union Fidelity Life Insurance Company, effective as of January 1, 2004 (Structured Settlement Annuities)
6. Coinsurance Agreement between Federal Home Life Insurance Company and Union Fidelity Life Insurance Company, effective as of January 1, 2004 (Structured Settlement Annuities)
7. Coinsurance Agreement between First Colony Life Insurance Company and Union Fidelity Life Insurance Company, effective as of January 1, 2004 (Structured Settlement Annuities)
8. Coinsurance Agreement between American Mayflower Life Insurance Company of New York and Union Fidelity Life Insurance Company, effective as of January 1, 2004 (Structured Settlement Annuities)
9. Reinsurance Agreement between GE Capital Life Assurance Company of New York and Union Fidelity Life Insurance Company, effective as of January 1, 2004 (Variable Annuities)
10. Reinsurance Agreement between GE Life and Annuity Assurance Company and Union Fidelity Life Insurance Company, effective as of January 1, 2004 (Variable Annuities)





## REINSURANCE AGREEMENT

between

FINANCIAL INSURANCE COMPANY LIMITED

and

VIKING INSURANCE COMPANY, LIMITED

Dated as of [ ] 2004

TABLE OF CONTENTS[ARTICLE I DEFINITIONS](#)[ARTICLE II COVERAGE](#)[ARTICLE III ADMINISTRATION: GENERAL PROVISIONS](#)[ARTICLE IV CEDING COMMISSION](#)[ARTICLE V ACCOUNTING AND SETTLEMENT: RESERVE ADJUSTMENT](#)[ARTICLE VI DURATION AND TERMINATION](#)[ARTICLE VII INSOLVENCY](#)[ARTICLE VIII DISPUTE RESOLUTION](#)[ARTICLE IX MISCELLANEOUS PROVISIONS](#)[SCHEDULE A – Part I CEDING COMMISSION](#)[SCHEDULE A– Part II ESTIMATED CEDING COMMISSION](#)[SCHEDULE A - PART III ESTIMATED CEDING COMMISSION FOR FIRST 12 ACCOUNTING PERIODS](#)[SCHEDULE B ACCOUNTING PERIOD REPORTS](#)[SCHEDULE C LIST OF REINSURANCE ARRANGEMENTS](#)REINSURANCE AGREEMENT

This Agreement, dated as of [ ], 2004 (this “Agreement”) is made and entered into by and between Financial Insurance Company Limited, an insurance company organised under the laws of England (the “Company”), and Viking Insurance Company, Limited, an insurance company organised under the laws of Bermuda (the “Reinsurer”). Defined terms used herein are defined below.

The Company and the Reinsurer mutually agree to reinsure under the terms and conditions stated herein. This Agreement is solely between the Company and the Reinsurer, and the performance of the obligations of each party under this Agreement shall be rendered solely to the other party. In no instance, except as set forth in Article VII of this Agreement, shall anyone other than the Company or the Reinsurer have any rights under this Agreement. The Company shall be and shall remain the only party that is liable to any insured, policyholder, claimant or beneficiary under any insurance policy or contract reinsured hereunder.

## ARTICLE I

DEFINITIONS

1.1 Definitions. As used in this Agreement, the following terms shall have the following meanings (definitions are applicable to both the singular and the plural forms of each term defined in this Article):

“Accounting Period” means each period of a calendar month the first such period commencing at 00.01 Bermuda local time (Atlantic Standard Time) on 1 January 2004 and the last such period commencing on the first day of the calendar month in which the Termination Date falls and ending on the Termination Date.

“Affiliate” means any other Person that directly or indirectly controls, is controlled by, or is under common control with, the first Person. “Control” (including the terms, “controlled by” and “under common control with”) means the possession, directly or indirectly, of the power to direct or cause the direction of the management and policies of a Person, whether through the ownership of voting securities, by contract or credit arrangement, as trustee or executor, or otherwise.

“Agreement” shall have the meaning specified in the first paragraph of this Agreement.

“Applicable Law” means any law (including common law), statute, ordinance, rule, regulation, order, writ, injunction, judgment, permit, governmental agreement or decree applicable to a Person or any of such Person’s subsidiaries, properties, assets, or to such Person’s officers, directors, managing directors, employees or agents in

their capacity as such.

---

“Business Day” means any day other than a Saturday, Sunday or other day on which banks in London are closed for trading.

“Ceded Reinsurance” means all reinsurance ceded by the Company pursuant to contracts, binders, certificates, treaties or other evidence of reinsurance relating to the Relevant Risks in effect on or prior to the Inception Date, or, in accordance with Section 2.5, following the Inception Date, except the reinsurance provided pursuant to this Agreement.

“Ceded Reinsurance Agreements” means all of the contracts, binders, certificates, treaties or other evidence for Ceded Reinsurance.

“Ceding Commissions” shall have the meaning specified in Schedule A – Part I.

“Commutation” means, with respect to any portion of the Ceded Reinsurance, a commutation or other similar transaction that results in the termination of such Ceded Reinsurance with respect to the Relevant Risks.

“Distributor Agreements” means all distributor, agency or profit sharing agreements or arrangements with third parties (each, a “Distributor”) relating to the Relevant Risks whether entered into before, on or after the Inception Date.

“Estimated Ceding Commission” shall have the meaning specified in Section 4.1.

“Extra Contractual Liabilities” means all liabilities of the Company for damages (including compensatory, consequential, exemplary, punitive, bad faith or similar or other damages) which relate to the marketing, sale, underwriting, issuance, delivery, cancellation or administration of contracts under which the Company assumes Relevant Risks, including liability arising out of or relating to any alleged or actual act, error or omission by the Company or its agents, whether intentional or otherwise, with respect to any of such contracts, including (A) any alleged or actual reckless conduct or bad faith in connection with the handling of any claim arising out of or under such contracts, or (B) the marketing, sale, underwriting, issuance, delivery, cancellation or administration of any of such contracts.

“FSA” means the Financial Services Authority of the United Kingdom.

“Governmental Authority” means any national government, any state or other political subdivision thereof or any self-regulatory authority, and any entity exercising executive, legislative, judicial, regulatory or administrative functions of or pertaining to government.

“Inception Date” shall have the meaning specified in Section 2.1.

“Insolvency Fund” means any guarantee fund, insolvency fund, plan, pool, association, or other arrangement, however denominated, established or governed, which provides for the payment by the Company of any levy, amount or charge in respect of, or assumption by the Company of part or all of any claims, debts, charges, fees or other

2

---

obligations of an insurer or reinsurer, or its successors or assigns, as a result of its having been declared by any competent authority to be insolvent, or as a result of its having otherwise been deemed unable to meet any such claims, debts, charges, fees or other obligations in whole or in part.

“Monthly Report” shall have the meaning specified in Section 5.1.

“Negative Settlement Amount” means, with respect to each Accounting Period, the amount of any net deficit set forth in Line 11 of the Monthly Report for such Accounting Period as calculated in accordance with Section 5.3(a).

“Person” means any natural person, firm, limited liability company, general partnership, limited partnership, joint venture, association, corporation, trust, Governmental Authority or other entity.

“Positive Settlement Amount” means, with respect to each Accounting Period, the amount of any net surplus set forth in Line 11 of the Monthly Report for such Accounting Period as calculated in accordance with Section 5.3(a).

“Relevant Liabilities” means all insurance liabilities and obligations arising under the Relevant Risks including, without limitation (i) benefits, surrender amounts and other amounts payable to policyholders under the terms of the Relevant Risks, (ii) other consideration paid on or after the Inception Date with respect to the Relevant Risks, (iii) Insolvency Fund or premium based assessments based on premiums and other consideration paid on or after the Inception Date with respect to the Relevant Risks, (iv) all amounts payable on or after the Inception Date for returns or refunds of premiums under the Relevant Risks, (v) all liability for commission or profit sharing payments and other fees or compensation payable, including under Distributor Agreements, with respect to the Relevant Risks in respect of premiums and other consideration paid on or after the Inception Date, (vi) all Extra Contractual Liabilities and (vii) compensation paid in respect of, or in relation to changes to, Distributor Agreements on or after the Inception Date, unless otherwise agreed to in writing by the Reinsurer.

“Relevant Risks” means the whole or, as the case may be, such part of the insurance or reinsurance risks as are assumed or borne by the Company under or in connection with any and all insurance and reinsurance policies and contracts to which it is a party and which are in force at any time on or prior to the Termination Date. Where the Company is a co-insurer with any other company or companies under any such insurance or reinsurance policy or contract, the insurance or reinsurance risks which are to be treated as assumed or borne by the Company for these purposes are:-

- (i) those risks which the Company has agreed with its co-insurer or co-insurers are to be assumed or borne by the Company; and
- (ii) those other risks (if any) which the Company has agreed with its co-insurer or co-insurers are to be assumed or borne by such co-insurer or co-insurers, but only to the extent that such co-insurer or co-insurers shall have defaulted in

3

---

meeting its or their obligations in respect of those risks and the Company incurs a liability in respect of those risks as a result.

“RIR” means the investment return in respect of an Accounting Period calculated in accordance with Section 5.3(c).

“Statutory Format” means the profit and loss account format set out in Chapter I of Part I of Schedule 9A of the Companies Act 1985.

“Technical Provisions” means, as of any given date, the technical provisions of the Company calculated in accordance with the Valuation and Accounting Principles.

“Termination Date” means the effective date of any termination of this Agreement as provided in Article VI.

“Valuation and Accounting Principles” means the valuation rules for determining the amount of the assets and liabilities of the Company in accordance with the Interim Prudential Sourcebook for Insurers issued by the FSA (as amended or replaced from time to time) under the powers conferred on the FSA pursuant to the Financial Services and Markets Act 2000, as such rules are required to be applied by the Company in the preparation of its annual returns to the FSA (taking into account any waivers or modifications of such valuation rules as are approved by the FSA from time to time in respect of the Company) and, to the extent not inconsistent therewith, the accounting principles and practices hitherto adopted by the Company in preparing its annual audited accounts.

“3 Month LIBOR” means the British Bankers Association Interest Settlement Rate for sterling quoted for a three month period as displayed on the appropriate Telerate screen page at 11.00 a.m. (London time) on the day on which such Interest Settlement Rate is required to be computed pursuant to this Agreement.

## ARTICLE II

### COVERAGE

- 2.1 Coverage. Upon the terms and subject to the conditions and other provisions of this Agreement, as of 00.01. Bermuda local time (Atlantic Standard Time) on 1 January 2004 (the “Inception Date”), the Reinsurer agrees to reinsure the Relevant Liabilities by way of the Reinsurer indemnifying the Company in respect of each Negative Settlement Amount. As consideration for the reinsurance by the Reinsurer under this Agreement, the Company shall pay to the Reinsurer each Positive Settlement Amount. The parties shall also pay Ceding Commission and Estimated Ceding Commission in accordance with the provisions of this Agreement.
- 2.2 Conditions. Except as otherwise set forth or contemplated herein, no changes, amendments or modifications made on or after the Inception Date in the terms and conditions of the Relevant Risks in-force as of the Inception Date which adversely affect

4

---

the liability of the Reinsurer hereunder shall be covered hereunder without the prior written approval of such changes, amendments or modifications by the Reinsurer, which approval shall not be unreasonably withheld or delayed. In the event that any such changes, amendments or modifications are made in any such Relevant Risk without the prior written approval of the Reinsurer, this Agreement will cover liability incurred by the Company for Relevant Risks as if the unapproved changes, amendments or modifications had not been made.

- 2.3 Territory. The territorial limits of the Agreement shall be identical to those of the Relevant Liabilities.
- 2.4 Commutation of Ceded Reinsurance. The Company shall not, without the Reinsurer’s prior written approval, in its sole discretion, take any action to amend or terminate any Ceded Reinsurance under any Ceded Reinsurance Agreement or enter into any Commutation of Ceded Reinsurance.
- 2.5 New Reinsurance Covers. Subsequent to the Inception Date, the Company shall not enter into any reinsurance arrangements with respect to the Relevant Liabilities without the prior written consent of the Reinsurer, in its sole discretion. For these purposes, the Reinsurer consents to the Company having entered into the reinsurance arrangements specified in Schedule C.

## ARTICLE III

### ADMINISTRATION: GENERAL PROVISIONS

- 3.1 Contract Administration. The Company shall procure that the Relevant Risks are administered in accordance with their terms and the terms of any applicable Distributor Agreement, including, but not limited to, the collection of premiums and other amounts due from policyholders, the payment of all Relevant Liabilities and the administration of claims and disbursements. All benefits under the contracts and policies constituting the Relevant Risks paid by the Company shall be binding upon the Reinsurer, provided, however, that such payments are within the terms, conditions and limitations of the contracts and policies constituting the Relevant Risks. The Company shall procure that the Relevant Risks are administered in good faith and with the care, skill, prudence, and diligence of a person experienced in administering payment protection insurance business, personal accident insurance business and travel insurance business. The Company shall procure that the Relevant Risks are administered in compliance with Applicable Law and the current service provider’s administrative performance standards in effect on the date hereof, with such revisions to such standards as are no less favourable to the Reinsurer than such standards. Notwithstanding the foregoing, the parties may, from time to time, mutually develop specific and/or different standards for the administration of the Relevant Risks.
- 3.2 Sub-contracting of Contract Administration. The Company may subcontract the performance of any service or services which the Company is required to procure in connection with the administration of the Relevant Risks to (i) an Affiliate, (ii) a service

5

---

provider utilised by the Company with respect to the Relevant Risks or its other business as of the date hereof, (iii) any Person to whom such subcontracting is required to be effected under the terms of any Distributor Agreement or (iv) with the prior written consent of the Reinsurer, any other Person, such consent not to be unreasonably withheld; provided, that no such subcontracting shall relieve the Company from any of its obligations or liabilities hereunder, and the Company shall remain responsible for all obligations or liabilities of such subcontractor with regard to the provision of such advice or services as if provided by the Company.

- 3.3 Ceded Reinsurance Agreements and Distributor Agreements. The Company shall manage and administer the Ceded Reinsurance Agreements and the Distributor Agreements, including:-
- (i) providing all reports and notices required with regard to the Ceded Reinsurance Agreements and the Distributor Agreements to the reinsurers or other third parties, as applicable, within the time required by the applicable Ceded Reinsurance Agreement or Distributor Agreements; and
  - (ii) doing all other things necessary to comply with the terms and conditions of the Ceded Reinsurance Agreements and the Distributor Agreements.

Without limiting the foregoing, the Company shall:-

- (i) promptly pay when due all reinsurance premiums due to reinsurers under the Ceded Reinsurance Agreements and use all commercially reasonable efforts to collect from such reinsurers all amounts due under Ceded Reinsurance; and
- (ii) promptly pay when due all profit sharing, commissions or other compensation due to third parties under the Distributor Agreement and use all commercially reasonable efforts to collect from such third parties all amounts due thereunder. Notwithstanding the obligation of the Company under this Section 3.3 to use

all commercially reasonable efforts to collect such reinsurance recoverables, the risk of the Company not collecting or being unable to collect (for whatever reason) any amount due under Ceded Reinsurance shall be borne by the Reinsurer in accordance with Line 2 of Schedule B of this Agreement.

- 3.4 Reinsured Policy Terms. The Company shall set all insurance rates and underwriting criteria in respect of the Relevant Risks from and after the Inception Date consistently with the manner in which it has done so in the past, consulting with the Reinsurer on any issue which is expected to have a material adverse impact on any amounts which the Reinsurer reasonably expects to become payable to it under the terms of this Agreement.
- 3.5 Claims Settlements. The Company agrees that if so requested by the Reinsurer it will provide notice to the Reinsurer as soon as is reasonably practicable of its intention to commence litigation proceedings in respect of a claim in excess of £100,000 with respect to a Reinsured Policy along with (if requested by the Reinsurer) copies of all

6

---

pleadings and reports of investigation with respect to that claim. The Reinsurer shall have the right, at its own expense, to participate jointly with the Company in the investigation, adjustment or defence of such claims.

- 3.6 Inspection. The Company shall keep accurate and complete records, files and accounts of all transactions and matters with respect to the Relevant Risks in accordance with its record management practices in effect from time to time. The Reinsurer or its designated representative (or Person appointed or charged with the duty to examine or investigate the Reinsurer under Applicable Law) may upon reasonable notice inspect and copy (and take away such copies), at the offices of the Company where such records are located, the papers and any and all other books or documents of the Company reasonably relating to the Relevant Risks and the administration thereof (including compliance with the provisions of Section 3.1), during normal business hours for such period as this Agreement is in effect or for as long thereafter as the Company seeks performance by the Reinsurer pursuant to the terms of this Agreement or the Reinsurer reasonably needs access to such records for regulatory, tax or similar purposes. Where any papers, books or documents relating to the Relevant Risks and the administration thereof are those of any sub-contractor of the Company, the Company shall procure at the Reinsurer's expense, to the extent that the Company is entitled and able to do so, that the Reinsurer may upon reasonable notice inspect and copy such papers, books or documents (and take away such copies) at the office of the sub-contractor where such papers, books or documents are located. The information obtained shall be used only for purposes relating to reinsurance under this agreement and as permitted under Section 3.7.
- 3.7 Co-operation. Each party hereto shall co-operate fully with the other in all reasonable respects in order to accomplish the objectives of this Agreement including making available to each their respective officers and employees for interview and meetings with Governmental Authorities and furnishing any additional assistance, information and documents as may be reasonably requested by either party from time to time. Each party is permitted to furnish such documents and information concerning this Agreement, the reinsurance under this Agreement and the objectives of this Agreement (i) to its advisors, insurance managers and auditors as may be desirable in connection with servicing the business of the party concerned or such party complying with Applicable Law and (ii) as required under Applicable Law.
- 3.8 Errors and Omissions. If any delay, omission, error or failure to pay amounts due or to perform any other act required by this Agreement is unintentional and caused by misunderstanding or oversight, the Company and the Reinsurer will adjust the situation to what it would have been had the misunderstanding or oversight not occurred. The party first discovering such misunderstanding or oversight, or an act resulting from such misunderstanding or oversight, will notify the other party in writing promptly upon discovery thereof, and the parties shall act to correct such misunderstanding or oversight within twenty (20) Business Days of such other party's receipt of such notice. However, this Section shall not be construed as a waiver by either party of its right to enforce strictly the terms of this Agreement.

7

- 
- 3.9 Age, Sex and Other Adjustments. The liability of the Reinsurer shall follow that of the Company including in circumstances where the Company's liability under any of the Relevant Risks is changed because of a misstatement of age or sex or any other material fact, and the Company and the Reinsurer will make all appropriate adjustments to amounts due to each other under this Agreement in such circumstances.
- 3.10 Setoff. Any debts or credits, matured or unmatured, liquidated or unliquidated, regardless of when they arose or were incurred, in favour of or against either the Company or the Reinsurer with respect to this Agreement are deemed mutual debts or credits, as the case may be, and shall be setoff from any amounts due to the Company or the Reinsurer hereunder, as the case may be, and only the net balance shall be allowed or paid.

#### ARTICLE IV

##### CEDING COMMISSION

- 4.1 Ceding Commission. On and subject to the terms of this Agreement, the Reinsurer shall pay to the Company (or, as the case may be, the Company shall pay to the Reinsurer), an estimate of the Ceding Commission (the "Estimated Ceding Commission") payable in respect of that Accounting Period in an amount determined in accordance with Schedule A Part II. The amount of the Estimated Ceding Commission in respect of each Accounting Period shall, subject to Section 4.2 below, be calculated by the Reinsurer in good faith on the basis of information provided by the Company and shall be paid, by the Reinsurer or the Company as the case may be, at the same time as any Negative or Positive Settlement Amount required to be paid in respect of the previous Accounting Period becomes due in accordance with the arrangements set out in Section 5.4 below. The Estimated Ceding Commission in respect of any Accounting Period is, for the avoidance of doubt, an estimate of the actual Ceding Commission due in respect of that Accounting Period and the adjustment to such estimate shall be effected through the Ceding Commission Adjustments referred to in Schedule B and Section 5.5.
- 4.2 Estimated Ceding Commission initially due. Notwithstanding Section 4.1, the amounts of the Estimated Ceding Commission in respect of each of the first 12 Accounting Periods shall be in the respective amounts set out in Schedule A Part III. The Reinsurer shall pay to the Company an amount equal to the Estimated Ceding Commission amounts in respect of all Accounting Periods commencing prior to the execution and delivery of this Agreement as set out in Schedule A Part III and, for the avoidance of doubt, the Company shall take account of such amount payable when producing the First Monthly Report in accordance with section 5.4(b) below. Subsequent amounts due as Estimated Ceding Commission under Schedule A Part III shall be paid in accordance with Section 5.4 below.

8

---

#### ARTICLE V

##### ACCOUNTING AND SETTLEMENT: RESERVE ADJUSTMENT

- 5.1 Monthly Reports. Subject as set out in Section 5.4(b), no later than 3 Business Days before the end of each Accounting Period (or more frequently as mutually agreed by the parties) the Company shall supply the Reinsurer with a report that shall provide an estimate of the financial data for such Accounting Period required in Schedule B together with details of the Ceding Commission estimated to be payable in respect of the following Accounting Period (the "Monthly Report").
- 5.2 Computations. At the end of each Accounting Period the Company shall compute:

- (i) the amount (being “X” in the formula set out in Section 5.3 below) shown in Line 3 in the table contained in Schedule B; and
- (ii) the amount (being “Y” in the formula set out in Section 5.3 below) shown in Line 7 in the table contained in Schedule B,

in each case in accordance with the notes set out in Schedule B and insofar as not inconsistent with such notes otherwise in accordance with the Valuation and Accounting Principles.

### 5.3 Positive and Negative Settlement Amounts.

- (a) In respect of each Accounting Period, if the formula:

$$(X - Y + RIR - A + B)$$

shall produce a positive amount, that shall be the Positive Settlement Amount for that Accounting Period, and if it shall produce a negative amount, that shall be the Negative Settlement Amount for that Accounting Period, and that Positive Settlement Amount or Negative Settlement Amount, as the case may be, shall be the amount set out in Line 11 of Schedule B.

- (b) For the purposes of the formula set out in Section 5.3(a):

- (i) “A” shall be the Reinsurer’s Ceding Commission Adjustment shown in Line 9 in the table contained in Schedule B; and
- (ii) “B” shall be the Company’s Ceding Commission Adjustment shown in Line 10 in the table contained in Schedule B.

- (c) The amount of RIR in respect of any Accounting Period shall be determined by multiplying an amount equal to:

- (i) the Technical Provisions as at the opening of business on the first day of the Accounting Period; less
- (ii) the amount of the Company’s provision for deferred acquisition costs as at the opening of business on the first day of the Accounting Period,

9

---

by a rate equal to:

$$\frac{C}{D}$$

where:

- (A) “C” is the amount of investment income receivable by the Company in respect of the Accounting Period; and
- (B) “D” is the total market value of the Company’s investments (other than any investment of the Company in its subsidiary undertakings) as at the opening of business on the first day of the Accounting Period.

For the purposes of this Section 5.3(c), “investment income” shall mean all amounts derived from the holding of investments (other than any investment of the Company in its subsidiary undertakings) which are treated, in accordance with the Company’s normal accounting policies, as being of an income nature, including any gains on the realisation of those investments and having taken account of any losses on the realisation of those investments. For the avoidance of doubt, “investment income” shall not include any unrealised gains or unrealised losses attributable to such investments.

### 5.4 Payments.

- (a) Subject as provided in Section 5.4(b) below:-

- (i) For each Accounting Period in respect of which there is a Negative Settlement Amount, the Reinsurer shall pay to the Company by telegraphic transfer within 5 Business Days of the delivery of the Monthly Report by the Company an amount equal to the absolute value of such Negative Settlement Amount together with the Estimated Ceding Commission (if any) payable by the Reinsurer to the Company in respect of the following Accounting Period.
- (ii) For each Accounting Period in respect of which there is a Positive Settlement Amount the Company shall pay to the Reinsurer by telegraphic transfer within 5 Business Days of the delivery of the Monthly Report by the Company an amount equal to the absolute value of such Positive Settlement Amount together with the Estimated Ceding Commission (if any) payable by the Company to the Reinsurer in respect of the following Accounting Period.
- (iii) If there is a Negative Settlement Amount for any Accounting Period and the Company is required to pay the Estimated Ceding Commission to the Reinsurer in respect of the following Accounting Period, a net

10

---

payment shall be made by the Company or the Reinsurer as appropriate.

- (iv) If there is a Positive Settlement Amount for any Accounting Period and the Reinsurer is required to pay the Estimated Ceding Commission to the Company in respect of the following Accounting Period, a net payment shall be made by the Company or the Reinsurer as appropriate.
- (b) In relation to all Accounting Periods commencing prior to the execution and delivery of this Agreement, the Company shall calculate and deliver a report (“the First Monthly Report”) to the Reinsurer as to the total aggregate net amount payable by the Company (or as the case may be the Reinsurer) to place the Company and the Reinsurer in the respective financial positions in which they would have been under this Agreement on the date of such payment, disregarding for this purpose the time cost of money, had this Agreement been executed and delivered at the commencement of the first Accounting Period. Such payment shall be made by telegraphic transfer within 5 Business Days of the delivery of the First Monthly Report.

### 5.5 Actual Data. In preparing all reports required under this Agreement, the Company shall use all commercially reasonable efforts to supply the actual data. If the actual data cannot be supplied with the appropriate report, the Company shall produce best estimates and shall provide amended reports based on actual data no more than ten

(10) Business Days after the actual data becomes available and the parties will settle any additional amounts due within five (5) Business Days thereafter, together with interest as provided in Section 5.7 hereof.

- 5.6 Additional Reports and Information. For so long as this Agreement remains in effect and for a period of 7 years after its termination, each of the parties shall periodically furnish to the other such other reports and information as is reasonably available to it and as may be reasonably requested by such other party for regulatory, tax or similar purposes.
- 5.7 Delayed Payments. In the event that all or any portion of any payment due to either party pursuant to this Agreement becomes overdue the portion of the amount overdue shall bear interest at an annual rate equal to 3 Month LIBOR on the date that the payment becomes overdue plus 200 basis points per annum, for the period that the amount is overdue.
- 5.8 Certificate of the Chief Financial Officer of the Company. The certificate of the Chief Financial Officer of the Company as to any matter arising in respect of the amount of any payment falling to be made under this Agreement shall, in the absence of manifest error, be final and binding on the parties.
- 5.10 Breach of Required Minimum Margin of Solvency. No payment required to be made by the Company to the Reinsurer at a relevant time under the terms of this Agreement shall

11

---

be required to be made at that time if that payment would cause the Company to breach the "Required Minimum Margin" required to be maintained by the Company in accordance with the FSA's Interim Prudential Sourcebook for Insurers (as amended or replaced from time to time). Any payment not made by the Company to the Reinsurer for this reason shall be paid by the Company to the Reinsurer as soon as the making of the payment would not cause that "Required Minimum Margin" to be breached.

## ARTICLE VI

### DURATION AND TERMINATION

- 6.1 Duration. Except as otherwise provided herein, this Agreement shall be unlimited in duration.
- 6.2 Reinsurer's Liability. The Reinsurer's liability with respect to the Relevant Liabilities will terminate on the date that termination takes effect as a result of any notice given at the option of the Reinsurer or the Company in accordance with Section 6.3 or Section 6.4 and otherwise on the date this Agreement is terminated upon the written agreement of the parties.
- 6.3 Termination on Insolvency. In the event of the insolvency of the Reinsurer, the Company shall have the right to terminate this Agreement and the reinsurance hereunder, such termination to be effective as soon as notice of the termination is given by the Company to the Reinsurer. With effect from the date that the notice of termination is given under this Section 6.3, any amounts which are or become owing by the Company to the Reinsurer under this Agreement, whether prior to, on or after the date of that notice of termination, shall cease to be payable by the Company to the Reinsurer.
- 6.4 Optional Termination. Either the Reinsurer or the Company may terminate this Agreement and the reinsurance hereunder upon prior written notice given at any time to expire on the last day of the Accounting Period in which such notice is given, at any time after the Reinsurer and the Company have both become wholly owned subsidiaries of Genworth Financial, Inc.

For the purposes of this Section, a company shall be a wholly owned subsidiary of Genworth Financial, Inc. if all of its ordinary shares are owned:-

- (i) by Genworth Financial, Inc., or
- (ii) by any other company the ordinary shares of which are owned directly by Genworth Financial, Inc. or by another wholly owned subsidiary of Genworth Financial, Inc.

12

---

- 6.5 Consequence of Termination
- (a) In the event that this Agreement is terminated pursuant to Section 6.4, this Agreement shall terminate as of the end of the applicable Accounting Period in which the notice of termination pursuant to Section 6.4 is received by the non-terminating party and a net accounting and settlement as to any balance due under this Agreement shall be undertaken by the parties for such Accounting Period and in respect of adjustments required for any earlier Accounting Period (the "Final Settlement").
  - (b) In the event that, subsequent to the Final Settlement, the Company receives any amount, or is required to pay any amount, or actual data becomes available to the Company, which in any such case was not taken into account in calculating any Positive or Negative Settlement Amount but which would have been so taken into account had it been received or paid or become available prior to the Termination Date or the Final Settlement, the Company or (as the case may be) the Reinsurer shall make such payment or payments to the other as is required to reflect as nearly as possible the position that would have prevailed had such amount or data been so taken into account, provided, however, that the obligations under this Section 6.5(b) to make any such payment shall terminate 18 months after the date on which any notice is served under Section 6.4.

## ARTICLE VII

### INSOLVENCY

- 7.1 Payments. In the event of the insolvency of the Company, payment due to the Company under this Agreement shall be payable by the Reinsurer directly to the Company or to its liquidator, receiver, or statutory successor on the basis of the liability of the Company under the contract or contracts reinsured, without diminution because of the insolvency of the Company. It is agreed and understood, however, that (i) in the event of the insolvency of the Company, the Company shall give to the Reinsurer written notice of the pendency of a claim against the insolvent Company on a Reinsured Policy within a reasonable time after such claim is filed in the insolvency proceeding and (ii) during the pendency of such claim the Reinsurer may investigate such claim and interpose, at its own expense, in the proceeding where such claim is to be adjudicated any defences which it may deem available to the Company or its liquidator, receiver or statutory successor.
- 7.2 Expenses. It is further understood that any expense thus incurred by the Reinsurer pursuant to Section 7.1 shall be chargeable, subject to court approval, against the insolvent Company as part of the expense of liquidation to the extent of a proportionate share of the benefit which may accrue to the Company solely as a result of the defence undertaken by the Reinsurer.

## ARTICLE VIII

DISPUTE RESOLUTION8.1 General Provisions.

- (a) Any dispute, controversy or claim arising out of or relating to this Agreement or the validity, interpretation, breach or termination thereof (a "Dispute"), shall be resolved in accordance with the procedures set forth in this Article VIII, which shall be the sole and exclusive procedure for the resolution of any such Dispute.
- (b) Commencing with the request contemplated by Section 8.2, all communications between the parties or their representatives in connection with the attempted resolution of any Dispute, including any mediator's evaluation referred to in Section 8.3, shall be deemed to be without prejudice communications and to have been delivered in furtherance of a Dispute settlement and shall be exempt from inspection, and shall not be admissible in evidence for any reason (whether as an admission or otherwise).
- (c) In connection with any Dispute, the parties expressly waive and forego any right to (i) punitive, exemplary, statutorily-enhanced or similar damages in excess of compensatory damages, and (ii) trial by jury.
- (d) The specific procedures set forth below, including but not limited to the time limits referenced therein, may be modified by agreement of the parties in writing.
- (e) The running of time shall be suspended in respect of any Dispute for the purposes of any defences based upon the passage of time (whether under the Limitation Act 1980 (in its present form or as subsequently amended or replaced) or otherwise) while the procedures specified in this Article VIII are pending. The parties will take such action, if any, required to effectuate this suspension.

- 8.2 Consideration by Senior Executives. If a Dispute is not resolved in the normal course of business at the operational level, the parties shall attempt in good faith to resolve any Dispute by negotiation between executives who hold, in respect of each of the business entities involved in the Dispute, at a minimum, the office of President, Chief Executive Officer or Chief Financial Officer. Either party may initiate the executive negotiation process by written notice to the other. Fifteen (15) days after delivery of the notice, the receiving party shall submit to the other a written response. The notice and response shall include (i) a statement of the Dispute and of each party's position, and (ii) the name and title of the executive who will represent that party and of any other person who will accompany the executive. Such executives will meet in person or by telephone within 30 days of the initial notice to seek a resolution.

- 8.3 Mediation. If a Dispute is not resolved by negotiation as provided in Section 8.2 within forty-five (45) days from the initial notice, then either party may submit the Dispute for resolution by mediation pursuant to the Center for Public Resources ("CPR") Model Mediation Procedure as then in effect. The parties will select a mediator from the CPR Panels of Distinguished Neutrals, but such mediator must have prior reinsurance experience either as a lawyer or as a present or former officer or management employee of a reinsurance company, but not of the Company, or the Reinsurer, or any of their respective affiliates. Either party at commencement of the mediation may ask the mediator to provide an evaluation of the Dispute and the parties' relative positions.

- 8.4 Arbitration. If a Dispute is not resolved by mediation as provided in Section 8.3 within thirty (30) days of the selection of a mediator (unless the mediator chooses to withdraw sooner), either party may submit the Dispute to be finally resolved by arbitration pursuant to the CPR Rules for Non-Administered Arbitration as then in effect. The parties consent to a single, consolidated arbitration for all known Disputes existing at the time of the arbitration and for which arbitration is permitted.

- (a) The neutral organisation for purposes of the CPR rules will be the CPR. the arbitral tribunal shall be composed of three arbitrators who are each experienced in the reinsurance business, of whom each party shall appoint one in accordance with the "screened" appointment procedure provided in Rule 5.4 of the CPR rules. The non-party appointed arbitrator must have prior U.S. reinsurance experience as a present or former officer or management employee of a reinsurance company, but not of the Company, or the Reinsurer, or any of their respective affiliates. The arbitration shall be conducted in New York. Each party shall be permitted to present its case, witnesses and evidence, if any, in the presence of the other party. A written transcript of the proceedings shall be made and furnished to the parties. The arbitrators shall determine the dispute in accordance with English law, without giving effect to any conflict of law rules or other rules that might render such law inapplicable or unavailable, and shall apply this Agreement according to its terms, provided that the provisions relating to arbitration shall be governed by the Federal Arbitration Act, 9 U.S.C. § 1 et seq.
- (b) The parties agree to be bound by any award or order resulting from any arbitration conducted hereunder and further agree that judgment on any award or order resulting from an arbitration conducted under this Section may be entered and enforced in any court having jurisdiction thereof.
- (c) Except as expressly permitted by this Agreement, no party will commence or voluntarily participate in any court action or proceeding concerning a Dispute, except (i) for enforcement as contemplated by Section 8.4(c) above, (ii) to restrict or vacate an arbitral decision based on the grounds specified under Applicable Law, or (iii) for interim relief as provided in paragraph (e) below. For the purposes of the foregoing the parties hereto submit to the non-exclusive jurisdiction of the courts of England.

- (d) In addition to the authority otherwise conferred on the arbitral tribunal, the tribunal shall have the authority to make such orders for interim relief, including injunctive relief, as it may deem just and equitable. Notwithstanding paragraph (d) above, each party acknowledges that in the event of any actual or threatened breach of certain of the provisions of this Agreement, the remedy at law may not be adequate, and therefore injunctive or other interim relief may be sought immediately to restrain such breach. If the tribunal shall not have been appointed, either party may seek interim relief from a court having jurisdiction if the award to which the applicant may be entitled may be rendered ineffectual without such interim relief. Upon appointment of the tribunal following any grant of interim relief by a court, the tribunal may affirm or disaffirm such relief, and the parties will seek modification or rescission of the court action as necessary to accord with the tribunal's decision.
- (e) Each of the parties will bear its own legal costs in relation to any arbitration proceedings considered under this Section.

- 8.5 Agreement to an alternative procedure. If the parties to this Agreement mutually agree that the alternate procedure set out in Section 8.6 and 8.7 below shall apply to a particular Dispute, then the parties shall resolve that Dispute in accordance with Sections 8.6 and 8.7 below rather than in accordance with Sections 8.3 and 8.4 above.

- 8.6 Alternative Mediation procedure. If the parties have mutually agreed under Section 8.5 that this section shall apply to a Dispute and such Dispute is not resolved by

negotiation as provided in Section 8.2 within 45 days from the initial notice (or such longer period as the parties may agree) then the parties will attempt to settle that Dispute by mediation in accordance with the Centre for Effective Dispute Resolution (CEDR Solve) Model Mediation Procedure (the "Model Procedure"). To initiate a mediation, either party shall give notice in writing ("ADR Notice") to the other party in accordance with the provisions of Section 9, requesting mediation in accordance with the provisions of the Model Procedure. A copy of the ADR Notice should also be sent to CEDR Solve.

- 8.7 Alternative Arbitration procedure. If the parties have mutually agreed under Section 8.5 that this section shall apply to a Dispute and such Dispute is not resolved within 42 days (or such longer period as the parties may agree) of the giving of the ADR Notice, or if one of the parties refuses to participate in mediation, the Dispute shall be referred to and finally resolved under the Rules of Arbitration of the International Chamber of Commerce (the "Rules") by 3 arbitrators appointed in accordance with the Rules, and so that:
- (a) The Tribunal shall consist of three arbitrators to be appointed in accordance with the Rules.
  - (b) The place of arbitration shall be London.
  - (c) The language to be used in the arbitral proceedings shall be English.

16

---

## ARTICLE IX

### MISCELLANEOUS PROVISIONS

- 9.1 Headings and Schedules. Headings used herein are not a part of this Agreement and shall not affect the terms hereof. The attached Schedules are a part of this Agreement.
- 9.2 Notices. All notices, requests, demands and other communications under this Agreement must be in writing and will be deemed to have been duly given or made as follows: (a) if sent by registered or certified mail with a return receipt requested, upon receipt; (b) if sent by reputable overnight air courier, four Business Days after mailing; (c) if sent by facsimile transmission, with a copy mailed on the same day in the manner provided in (a) or (b) above, when transmitted and receipt is confirmed by telephone; or (d) if otherwise actually personally delivered, when delivered, and shall be delivered as follows:
- If to the Company:
- Vantage West,  
Great West Road,  
Brentford,  
Middlesex TW8 9AG
- Facsimile: +44 (0) 20 8380 3065  
Attention: Company Secretary
- If to the Reinsurer:
- Craig Appin House,  
8 Wesley Street,  
Hamilton,  
Bermuda,
- Facsimile: +441 292 4910  
Attention: Iain Lever (Aon Insurance Managers (Bermuda) Limited),
- or to such other address or to such other Person as either party may have last designated by notice to the other party.
- 9.3 Successors and Assigns. This Agreement shall be binding upon and inure to the benefit of the parties hereto and their respective successors, permitted assigns and legal representatives. Neither this Agreement, nor any right or obligation hereunder, may be assigned by any party without the prior written consent of the other party hereto. Any assignment in violation of this Section 9.3 shall be void and shall have no force and effect. Nothing in this Section 9.3 shall be construed to prohibit the Reinsurer from retroceding all or any portion of the business reinsured hereunder.

17

---

- 9.4 Execution in Counterpart. This Agreement may be executed by the parties hereto in any number of counterparts, and by each of the parties hereto in separate counterparts, each of which counterparts, when so executed and delivered, shall be deemed to be an original, but all such counterparts shall together constitute but one and the same instrument.
- 9.5 Currency. Whenever the acronym "GBP" or the "£" sign appears in this Agreement, they shall be construed to mean British Pounds Sterling and all transactions under this Agreement shall be in British Pounds Sterling.
- 9.6 Amendments. This Agreement may not be changed, altered or modified unless the same shall be in writing executed by the Company and the Reinsurer.
- 9.7 Governing Law. This Agreement will be construed, performed and enforced in accordance with the laws of England without giving effect to its principles or rules of conflict of laws thereof to the extent such principles or rules would require or permit the application of the laws of another jurisdiction.
- 9.8 Entire Agreement: Severability. This Agreement constitutes the entire agreement between the parties hereto relating to the subject matter hereof and supersedes all prior and contemporaneous agreements, undertakings, statements, representations and warranties, negotiations and discussions, whether oral or written of the parties and there are no general or specific warranties, representations or other agreements by or among the parties in connection with the entering into of this Agreement or the subject matter hereof except as specifically set forth or contemplated herein.
- 9.9 Enforceability. If any provision of this Agreement is held to be void or unenforceable, in whole or in part, (i) such holding shall not affect the validity and enforceability of the remainder of this Agreement, including any other provision, paragraph or subparagraph, and (ii) the parties agree to attempt in good faith to reform such void or unenforceable provision to the extent necessary to render such provision enforceable and to carry out its original intent.
- 9.10 No Waiver: Preservation of Remedies. No consent or waiver, express or implied, by any party to or of any breach or default by any other party in the performance by



such other party of its obligations hereunder shall be deemed or construed to be a consent or waiver to or of any other breach or default in the performance of obligations hereunder by such other party hereunder. Failure on the part of any party to complain of any act or failure to act of any other party or to declare any other party in default, irrespective of how long such failure continues, shall not constitute a waiver by such first party of any of its rights hereunder. The rights and remedies provided are cumulative and are not exclusive of any rights or remedies that any party may otherwise have at law or equity.

9.11 Third Party Beneficiary. Nothing in this Agreement shall confer any rights upon any Person that is not a party or a successor or permitted assignee of a party to this Agreement.

18

---

9.12 Interpretation. Whenever the words “include”, “includes” or “including” are used in this Agreement, they shall be deemed to be followed by the words “without limitation”.

9.13 Survival. Articles VIII and IX shall survive the termination of this Agreement and Section 6.5(b) shall remain in force for a period of 18 months after the date on which any notice is served under Section 6.4.

9.14 Negotiated Agreement. This Agreement has been negotiated by the parties and the fact that the initial and final draft will have been prepared by either party or an intermediary will not give rise to any presumption for or against any party to this Agreement or be used in any respect or forum in the construction or interpretation of this Agreement or any of its provisions.

19

---

IN WITNESS WHEREOF, the parties hereto have caused this Agreement to be executed by their duly authorised representatives.

FINANCIAL INSURANCE COMPANY LIMITED

By \_\_\_\_\_

Name:

Title:

VIKING INSURANCE COMPANY, LIMITED

By \_\_\_\_\_

Name:

Title:

20

---

SCHEDULE A – Part I

CEDING COMMISSION

The Company shall calculate in respect of each Accounting Period the amount by which the deferred acquisition costs of the Company shall have increased or decreased over such Accounting Period (the “Ceding Commission”). The Ceding Commission in respect of such Accounting Period for the purposes of Article IV of this Agreement:-

- (i) shall be payable by the Reinsurer to the Company in an amount equal to the amount, if any, by which the deferred acquisition costs of the Company shall have decreased over that Accounting Period; and
- (ii) shall be payable by the Company to the Reinsurer in an amount equal to the amount, if any, by which the deferred acquisition costs of the Company shall have increased over that Accounting Period.

For the avoidance of doubt, the amount of deferred acquisition costs at any relevant time shall be calculated in accordance with the Valuation and Accounting Principles.

In calculating the Ceding Commission for the first Accounting Period, the deferred acquisition costs of the Company shall at the commencement of such Accounting Period be taken as £152,210,000.

21

---

SCHEDULE A – Part II

ESTIMATED CEDING COMMISSION

Subject as provided in Schedule A - Part III below, the Reinsurer shall produce at the end of each Accounting Period on the basis of information provided by the Company a best estimate of the Ceding Commission for the next following Accounting Period.

SCHEDULE A - PART III

ESTIMATED CEDING COMMISSION FOR FIRST 12 ACCOUNTING PERIODS

For the first 12 Accounting Periods the Estimated Ceding Commission shall, in the case of each amount, be payable by the Reinsurer and shall be as follows, provided that the parties acknowledge that such amounts are estimates only and shall be the subject of the Reinsurer’s Ceding Commission Adjustment and the Company’s Ceding Commission Adjustment, as appropriate, in accordance with Lines 9 and 10 of Schedule B of this Agreement and Section 5.5:-

Accounting Period ending on:- \_\_\_\_\_

Amount of Ceding Commission:- \_\_\_\_\_

31st January 2004	£	3,167,000
29th February 2004	£	3,167,000
31st March 2004	£	3,167,000
30th April 2004	£	3,167,000
31st May 2004	£	3,167,000
30th June 2004	£	3,167,000
31st July 2004	£	3,167,000
31st August 2004	£	3,167,000
30th September 2004	£	3,167,000
31st October 2004	£	3,167,000
30th November 2004	£	3,167,000
31st December 2004	£	3,167,000

22

SCHEDULE B

ACCOUNTING PERIOD REPORTS

Note: All amounts paid or payable by the Company in respect of insurance premium tax or any other tax assessed by reference to the premium payable under any policy are to be netted off all amounts paid or payable to the Company in respect of such insurance premium tax or other tax in calculating any of the items listed below. No account shall be taken in any of the items listed below of any amount payable or receivable under this Agreement or of any change in the Company's provision for deferred acquisition costs provided that this shall not affect the requirement to include the Reinsurer's Ceding Commission Adjustment or the Company's Ceding Commission Adjustment as the case may be.

Line no.	Item	£
1.	Earned Premiums	£
2.	Other Income	£
3.	<b>Total Income (Lines 1 to 2)</b>	£
4.	Claims Incurred	£
5.	Expenses Payable	£
6.	Other Changes In Technical Provisions	£
7.	<b>Total Expenditure (Lines 4 to 6)</b>	£
8.	RIR	£
9.	Reinsurer's Ceding Commission Adjustment	£
10.	Company's Ceding Commission Adjustment	£
11.	<b>Positive / (Negative) Settlement Amount (Line 3 – Line 7 + Line 8 – Line 9 + Line 10)</b>	£

where, in respect of each Accounting Period:

Line 1: "Earned Premiums" shall mean gross premiums written in such Accounting Period plus any decrease or minus any increase in the provision for unearned premiums over such Accounting Period, as described in item I.1 of the Statutory Format and the notes thereto. In calculating the gross premiums written in any Accounting Period there shall be deducted the outward reinsurance premiums paid in such Accounting Period. To the amount of any increase in the provision for unearned premiums over such Accounting Period there shall be added any decrease or there shall be subtracted any increase, over such Accounting Period, in the amount of the unearned reinsurance premiums paid by the Company. To the amount of any decrease in the provision for unearned premiums over such Accounting Period, there shall be added any increase, or there shall be subtracted any decrease, over such Accounting Period, in the amount of the unearned reinsurance premiums paid by the Company. In calculating the gross premiums written, full account shall be taken of

the effect of cancellations notified in such Accounting Period and of any other arrangement under which a policy is terminated in such Accounting Period;

Line 2: "Other Income" shall mean all other income becoming due to the Company in the relevant Accounting Period, excluding any income from investments and any realised or unrealised gains on investments and excluding any amount received or becoming due under Ceded Reinsurance;

Line 3: "Total Income" shall mean the sum of Earned Premiums and Other Income;

Line 4: "Claims Incurred" shall mean claims paid in respect of the Relevant Liabilities less reinsurance recoveries received in respect of the Relevant Liabilities in the relevant Accounting Period plus any increase (or minus any decrease) over such Accounting Period in the provision for claims. For these purposes, such provision for claims shall be calculated, at the beginning and end of each Accounting Period, net of any available credit for reinsurance, not being a credit in respect of any reinsurance claim which is due but unpaid, and otherwise in accordance with the manner in which such provision for claims would be calculated for the purposes of item I.4(b) of the Statutory Format;

Line 5: "Expenses Payable" shall mean operating expenses incurred in the relevant Accounting Period including without limitation:-

- (a) bonuses and rebates, net of reinsurance, as described in item I.6 of the Statutory Format;
- (b) acquisition costs, administrative expenses, reinsurance commissions and profit participation, as described in item I.7 of the Statutory Format and the notes thereto; and
- (c) the charges described in items I.8 and III.8 of the Statutory Format,

but, for the avoidance of doubt, shall exclude investment expenses and charges, realised or unrealised losses on investments, and income and corporation tax;

Line 6: "Other Changes in Technical Provisions" shall mean the increase in technical provisions (or the decrease in technical provisions in which event such decrease shall be expressed as a negative amount) not accounted for in any other line of this Schedule B, as described in item I.5 and I.9 of the Statutory Format and any other increases in reserves (or decreases in reserves, in which event such decreases shall be expressed as negative amounts) required to be taken into account for the purposes of the returns made to the FSA but not required to be so taken into account under Schedule 9A of the Companies Act 1985 in respect of the Company including any change required as a result of the Company not having received any amount due in respect of Ceded Reinsurance;

23

- 
- Line 7: "Total Expenditure" shall mean the sum of Claims Incurred, Expenses Payable and Other Changes in Technical Provisions;
- Line 8: "RIR" shall mean the amount calculated pursuant to Section 5.3(c) of this Agreement; and
- Line 9: "Reinsurer's Ceding Commission Adjustment" shall mean the amount (if any) due from the Reinsurer as a result of the actual Ceding Commission for such Accounting Period calculated in accordance with Schedule A - Part I being different from the Estimated Ceding Commission for that Accounting Period;
- Line 10: "Company's Ceding Commission Adjustment" shall mean any amount due from the Company as a result of the actual Ceding Commission for such Accounting Period calculated in accordance with Schedule A - Part I being different from the Estimated Ceding Commission for that Accounting Period;
- Line 11: the "Positive Settlement Amount" and the "Negative Settlement Amount" shall mean the amounts calculated pursuant to Section 5.3(a) of this Agreement.

Any amounts included in any of the items listed above shall be included in the calculation set out in this Schedule B only to the extent that such amounts have not been accounted for in any Monthly Report relating to any previous Accounting Period. Any amount specifically excluded from any line item shall be treated as though it were excluded from all other line items unless the context shall expressly require otherwise. No amount shall be included in more than one line item. In the event of any conflict between the application of any express provision in these notes or this Agreement, and the application of any statutory or regulatory rule under this Schedule, in each case for the purposes of determining the amount of any line item in this Schedule, the express provisions in these notes and this Agreement shall prevail.

In calculating the Positive or Negative Settlement Amount (as the case may be) for the first Accounting Period:-

- (i) the provision for unearned premiums shall at the commencement of such Accounting Period be taken as £316,410,000;
- (ii) the amount of the unearned reinsurance premiums shall at the commencement of such Accounting Period be taken as £16,059,000;
- (iii) the claims provision net of any available credit for reinsurance, not being a credit in respect of any reinsurance claim which is due but unpaid at the commencement of such Accounting Period shall at such commencement be taken as £73,222,000; and
- (iv) the technical provisions and reserves referred to in Line 6 above shall at the commencement of such Accounting Period be taken as £0.

#### SCHEDULE C

##### LIST OF REINSURANCE ARRANGEMENTS

1. An agreement to extend (to 31 December 2004) a 95% quota share agreement with Financial Insurance Guernsey PCC Limited relating to the Company's travel insurance business.
  2. An agreement to renew (to 31 December 2004) travel catastrophe cover with a syndicate including Everest Reinsurance Company (UK branch), Odyssey America Re, Brit Insurance Limited, Sirius International Insurance Corporation (UK branch), Transatlantic Reinsurance Company, Converium Limited, Lloyds Syndicates No. 510, 557 and 570, relating to the Company's travel insurance business.
-

**REINSURANCE AGREEMENT**

**between**

**FINANCIAL ASSURANCE COMPANY LIMITED**

**and**

**VIKING INSURANCE COMPANY, LIMITED**

**Dated as of [ ] 2004**

---

**TABLE OF CONTENTS**

[ARTICLE I DEFINITIONS](#)

[ARTICLE II COVERAGE](#)

[ARTICLE III ADMINISTRATION: GENERAL PROVISIONS](#)

[ARTICLE IV CEDING COMMISSION](#)

[ARTICLE V ACCOUNTING AND SETTLEMENT: RESERVE ADJUSTMENT](#)

[ARTICLE VI DURATION AND TERMINATION](#)

[ARTICLE VII INSOLVENCY](#)

[ARTICLE VIII DISPUTE RESOLUTION](#)

[ARTICLE IX MISCELLANEOUS PROVISIONS](#)

[SCHEDULE A – Part I CEDING COMMISSION](#)

[SCHEDULE A – Part II ESTIMATED CEDING COMMISSION](#)

[SCHEDULE A - PART III ESTIMATED CEDING COMMISSION FOR FIRST 12 ACCOUNTING PERIODS](#)

[SCHEDULE B ACCOUNTING PERIOD REPORTS](#)

[SCHEDULE C THE BONDS](#)

[SCHEDULE D LIST OF REINSURANCE ARRANGEMENTS](#)

---

**REINSURANCE AGREEMENT**

This Agreement, dated as of \_\_\_\_\_, 2004 (this “Agreement”) is made and entered into by and between Financial Assurance Company Limited, an insurance company organised under the laws of England (the “Company”), and Viking Insurance Company, Limited, an insurance company organised under the laws of Bermuda (the “Reinsurer”). Defined terms used herein are defined below.

The Company and the Reinsurer mutually agree to reinsure under the terms and conditions stated herein. This Agreement is solely between the Company and the Reinsurer, and the performance of the obligations of each party under this Agreement shall be rendered solely to the other party. In no instance, except as set forth in Article VII of this Agreement, shall anyone other than the Company or the Reinsurer have any rights under this Agreement. The Company shall be and shall remain the only party that is liable to any insured, policyholder, claimant or beneficiary under any insurance policy or contract reinsured hereunder.

ARTICLE I

**DEFINITIONS**

1.1 **Definitions.** As used in this Agreement, the following terms shall have the following meanings (definitions are applicable to both the singular and the plural forms of each term defined in this Article):

“**Accounting Period**” means each period of a calendar month the first such period commencing at 00.01 Bermuda local time (Atlantic Standard Time) on 1 January 2004 and the last such period commencing on the first day of the calendar month in which the Termination Date falls and ending on the Termination Date.

“**Affiliate**” means any other Person that directly or indirectly controls, is controlled by, or is under common control with, the first Person. “**Control**” (including the terms, “**controlled by**” and “**under common control with**”) means the possession, directly or indirectly, of the power to direct or cause the direction of the management and policies of a Person, whether through the ownership of voting securities, by contract or credit arrangement, as trustee or executor, or otherwise.

“Agreement” shall have the meaning specified in the first paragraph of this Agreement.

“Applicable Law” means any law (including common law), statute, ordinance, rule, regulation, order, writ, injunction, judgment, permit, governmental agreement or decree applicable to a Person or any of such Person’s subsidiaries, properties, assets, or to such Person’s officers, directors, managing directors, employees or agents in their capacity as such.

---

“Bonds” means the categories of products written by the Company, whether before, on or after the Inception Date, which are listed in Schedule C.

“Business Day” means any day other than a Saturday, Sunday or other day on which banks in London are closed for trading.

“Ceded Reinsurance” means all reinsurance ceded by the Company pursuant to contracts, binders, certificates, treaties or other evidence of reinsurance relating to the Relevant Risks in effect on or prior to the Inception Date, or, in accordance with Section 2.5, following the Inception Date, except the reinsurance provided pursuant to this Agreement.

“Ceded Reinsurance Agreements” means all of the contracts, binders, certificates, treaties or other evidence for Ceded Reinsurance.

“Ceding Commissions” shall have the meaning specified in Schedule A Part I.

“Commutation” means, with respect to any portion of the Ceded Reinsurance, a commutation or other similar transaction that results in the termination of such Ceded Reinsurance with respect to the Relevant Risks.

“Distributor Agreements” means all distributor, agency or profit sharing agreements or arrangements with third parties (each, a “Distributor”) relating to the Relevant Risks whether entered into before, on or after the Inception Date.

“Estimated Ceding Commission” shall have the meaning specified in Section 4.1.

“Extra Contractual Liabilities” means all liabilities of the Company for damages (including compensatory, consequential, exemplary, punitive, bad faith or similar or other damages) which relate to the marketing, sale, underwriting, issuance, delivery, cancellation or administration of contracts under which the Company assumes Relevant Risks, including liability arising out of or relating to any alleged or actual act, error or omission by the Company or its agents, whether intentional or otherwise, with respect to any of such contracts, including (A) any alleged or actual reckless conduct or bad faith in connection with the handling of any claim arising out of or under such contracts, or (B) the marketing, sale, underwriting, issuance, delivery, cancellation or administration of any of such contracts.

“FINCL” shall mean Financial New Life Company Limited, a company incorporated in England and Wales with registered number 4873014 and whose registered office is at Vantage West Great West Road, Brentford, Middlesex TW8 9AG.

“FSA” means the Financial Services Authority of the United Kingdom.

“Governmental Authority” means any national government, any state or other political subdivision thereof or any self-regulatory authority, and any entity exercising executive, legislative, judicial, regulatory or administrative functions of or pertaining to government.

2

---

“Inception Date” shall have the meaning specified in Section 2.1.

“Insolvency Fund” means any guarantee fund, insolvency fund, plan, pool, association, or other arrangement, however denominated, established or governed, which provides for the payment by the Company of any levy, amount or charge in respect of, or assumption by the Company of part or all of any claims, debts, charges, fees or other obligations of an insurer or reinsurer, or its successors or assigns, as a result of its having been declared by any competent authority to be insolvent, or as a result of its having otherwise been deemed unable to meet any such claims, debts, charges, fees or other obligations in whole or in part.

“Mathematical Reserves” means, as of any given date, the mathematical reserves of the Company calculated in accordance with the Valuation and Accounting Principles but excluding any mathematical reserves attributable to the Bonds.

“Monthly Report” shall have the meaning specified in Section 5.1.

“Negative Settlement Amount” means, with respect to each Accounting Period, the amount of any net deficit set forth in Line 11 of the Monthly Report for such Accounting Period as calculated in accordance with Section 5.3(a).

“Person” means any natural person, firm, limited liability company, general partnership, limited partnership, joint venture, association, corporation, trust, Governmental Authority or other entity.

“Positive Settlement Amount” means, with respect to each Accounting Period, the amount of any net surplus set forth in Line 11 of the Monthly Report for such Accounting Period as calculated in accordance with Section 5.3(a).

“Relevant Liabilities” means all insurance liabilities and obligations arising under the Relevant Risks including, without limitation (i) benefits, surrender amounts and other amounts payable to policyholders under the terms of the Relevant Risks, (ii) other consideration paid on or after the Inception Date with respect to the Relevant Risks, (iii) Insolvency Fund or premium based assessments based on premiums and other consideration paid on or after the Inception Date with respect to the Relevant Risks, (iv) all amounts payable on or after the Inception Date for returns or refunds of premiums under the Relevant Risks, (v) all liability for commission or profit sharing payments and other fees or compensation payable, including under Distributor Agreements, with respect to the Relevant Risks in respect of premiums and other consideration paid on or after the Inception Date, (vi) all Extra Contractual Liabilities and (vii) compensation paid in respect of, or in relation to changes to, Distributor Agreements on or after the Inception Date, unless otherwise agreed to in writing by the Reinsurer.

“Relevant Risks” means the whole or, as the case may be, such part of the insurance or reinsurance risks as are assumed or borne by the Company under or in connection with any and all insurance and reinsurance policies and contracts to which it is a party and which are in force at any time on or prior to the Termination Date (with the exception of

3

---

the Bonds). Where the Company is a co-insurer with any other company or companies under any such insurance or reinsurance policy or contract, the insurance or

reinsurance risks which are to be treated as assumed or borne by the Company for these purposes are:-

- (i) those risks which the Company has agreed with its co-insurer or co-insurers are to be assumed or borne by the Company; and
- (ii) those other risks (if any) which the Company has agreed with its co-insurer or co-insurers are to be assumed or borne by such co-insurer or co-insurers, but only to the extent that such co-insurer or co-insurers shall have defaulted in meeting its or their obligations in respect of those risks and the Company incurs a liability in respect of those risks as a result.

For the avoidance of doubt, in the event that the rights and obligations of the Company under this Agreement are transferred to FINCL under the Scheme, the "Relevant Risks" hereunder shall include any reinsurance risks assumed by FINCL under the Scheme in respect of any Retained Insurances (as defined in the Scheme).

"RIR" means the investment return in respect of an Accounting Period calculated in accordance with Section 5.3(c).

"Scheme" means the scheme for the transfer of the business of the Company to FINCL pursuant to section 105 of the Financial Services and Markets Act 2000.

"Statutory Format" means the profit and loss account format set out in Chapter I of Part I of Schedule 9A of the Companies Act 1985.

"Termination Date" means the effective date of any termination of this Agreement as provided in Article VI.

"Valuation and Accounting Principles" means the valuation rules for determining the amount of the assets and liabilities of the Company in accordance with the Interim Prudential Sourcebook for Insurers issued by the FSA (as amended or replaced from time to time) under the powers conferred on the FSA pursuant to the Financial Services and Markets Act 2000, as such rules are required to be applied by the Company in the preparation of its annual returns to the FSA (taking into account any waivers or modifications of such valuation rules as are approved by the FSA from time to time in respect of the Company) and, to the extent not inconsistent therewith, the accounting principles and practices hitherto adopted by the Company in preparing its annual audited accounts.

"3 Month LIBOR" means the British Bankers Association Interest Settlement Rate for sterling quoted for a three month period as displayed on the appropriate Telerate screen page at 11.00 a.m. (London time) on the day on which such Interest Settlement Rate is required to be computed pursuant to this Agreement.

4

---

## ARTICLE II

### COVERAGE

- 2.1 Coverage. Upon the terms and subject to the conditions and other provisions of this Agreement, as of 00.01. Bermuda local time (Atlantic Standard Time) on 1 January 2004 (the "Inception Date"), the Reinsurer agrees to reinsure the Relevant Liabilities by way of the Reinsurer indemnifying the Company in respect of each Negative Settlement Amount. As consideration for the reinsurance by the Reinsurer under this Agreement, the Company shall pay to the Reinsurer each Positive Settlement Amount. The parties shall also pay Ceding Commission and Estimated Ceding Commission in accordance with the provisions of this Agreement.
- 2.2 Conditions. Except as otherwise set forth or contemplated herein, no changes, amendments or modifications made on or after the Inception Date in the terms and conditions of the Relevant Risks in-force as of the Inception Date which adversely affect the liability of the Reinsurer hereunder shall be covered hereunder without the prior written approval of such changes, amendments or modifications by the Reinsurer, which approval shall not be unreasonably withheld or delayed. In the event that any such changes, amendments or modifications are made in any such Relevant Risk without the prior written approval of the Reinsurer, this Agreement will cover liability incurred by the Company for Relevant Risks as if the unapproved changes, amendments or modifications had not been made.
- 2.3 Territory. The territorial limits of the Agreement shall be identical to those of the Relevant Liabilities.
- 2.4 Commutation of Ceded Reinsurance. The Company shall not, without the Reinsurer's prior written approval, in its sole discretion, take any action to amend or terminate any Ceded Reinsurance under any Ceded Reinsurance Agreement or enter into any Commutation of Ceded Reinsurance.
- 2.5 New Reinsurance Covers. Subsequent to the Inception Date, the Company shall not enter into any reinsurance arrangements with respect to the Relevant Liabilities without the prior written consent of the Reinsurer, in its sole discretion. For these purposes, the Reinsurer consents to the Company having entered into the reinsurance arrangements specified in Schedule D.

## ARTICLE III

### ADMINISTRATION: GENERAL PROVISIONS

- 3.1 Contract Administration. The Company shall procure that the Relevant Risks are administered in accordance with their terms and the terms of any applicable Distributor Agreement, including, but not limited to, the collection of premiums and other amounts due from policyholders, the payment of all Relevant Liabilities and the administration of claims and disbursements. All benefits under the contracts and policies constituting the

5

---

Relevant Risks paid by the Company shall be binding upon the Reinsurer, provided, however, that such payments are within the terms, conditions and limitations of the contracts and policies constituting the Relevant Risks. The Company shall procure that the Relevant Risks are administered in good faith and with the care, skill, prudence, and diligence of a person experienced in administering payment protection insurance business. The Company shall procure that the Relevant Risks are administered in compliance with Applicable Law and the current service provider's administrative performance standards in effect on the date hereof, with such revisions to such standards as are no less favourable to the Reinsurer than such standards. Notwithstanding the foregoing, the parties may, from time to time, mutually develop specific and/or different standards for the administration of the Relevant Risks.

- 3.2 Sub-contracting of Contract Administration. The Company may subcontract the performance of any service or services which the Company is required to procure in connection with the administration of the Relevant Risks to (i) an Affiliate, (ii) a service provider utilised by the Company with respect to the Relevant Risks or its other business as of the date hereof, (iii) any Person to whom such subcontracting is required to be effected under the terms of any Distributor Agreement or (iv) with the prior written consent of the Reinsurer, any other Person, such consent not to be unreasonably withheld; provided, that no such subcontracting shall relieve the Company from any of its obligations or liabilities hereunder, and the Company shall remain responsible for all obligations or liabilities of such subcontractor with regard to the provision of such advice or services as if provided by the Company.
- 3.3 Ceded Reinsurance Agreements and Distributor Agreements. The Company shall manage and administer the Ceded Reinsurance Agreements and the Distributor Agreements, including:-

- (i) providing all reports and notices required with regard to the Ceded Reinsurance Agreements and the Distributor Agreements to the reinsurers or other third parties, as applicable, within the time required by the applicable Ceded Reinsurance Agreement or Distributor Agreements; and
- (ii) doing all other things necessary to comply with the terms and conditions of the Ceded Reinsurance Agreements and the Distributor Agreements.

Without limiting the foregoing, the Company shall:-

- (i) promptly pay when due all reinsurance premiums due to reinsurers under the Ceded Reinsurance Agreements and use all commercially reasonable efforts to collect from such reinsurers all amounts due under Ceded Reinsurance; and
- (ii) promptly pay when due all profit sharing, commissions or other compensation due to third parties under the Distributor Agreement and use all commercially reasonable efforts to collect from such third parties all amounts due thereunder. Notwithstanding the obligation of the Company under this Section 3.3 to use all commercially reasonable efforts to collect such reinsurance recoverables, the

6

---

risk of the Company not collecting or being unable to collect (for whatever reason) any amount due under Ceded Reinsurance shall be borne by the Reinsurer in accordance with Line 2 of Schedule B of this Agreement.

- 3.4 Reinsured Policy Terms. The Company shall set all insurance rates and underwriting criteria in respect of the Relevant Risks from and after the Inception Date consistently with the manner in which it has done so in the past, consulting with the Reinsurer on any issue which is expected to have a material adverse impact on any amounts which the Reinsurer reasonably expects to become payable to it under the terms of this Agreement.
- 3.5 Claims Settlements. The Company agrees that if so requested by the Reinsurer it will provide notice to the Reinsurer as soon as is reasonably practicable of its intention to commence litigation proceedings in respect of a claim in excess of £100,000 with respect to a Reinsured Policy along with (if requested by the Reinsurer) copies of all pleadings and reports of investigation with respect to that claim. The Reinsurer shall have the right, at its own expense, to participate jointly with the Company in the investigation, adjustment or defence of such claims.
- 3.6 Inspection. The Company shall keep accurate and complete records, files and accounts of all transactions and matters with respect to the Relevant Risks in accordance with its record management practices in effect from time to time. The Reinsurer or its designated representative (or Person appointed or charged with the duty to examine or investigate the Reinsurer under Applicable Law) may upon reasonable notice inspect and copy (and take away such copies), at the offices of the Company where such records are located, the papers and any and all other books or documents of the Company reasonably relating to the Relevant Risks and the administration thereof (including compliance with the provisions of Section 3.1), during normal business hours for such period as this Agreement is in effect or for as long thereafter as the Company seeks performance by the Reinsurer pursuant to the terms of this Agreement or the Reinsurer reasonably needs access to such records for regulatory, tax or similar purposes. Where any papers, books or documents relating to the Relevant Risks and the administration thereof are those of any sub-contractor of the Company, the Company shall procure at the Reinsurer's expense, to the extent that the Company is entitled and able to do so, that the Reinsurer may upon reasonable notice inspect and copy such papers, books or documents (and take away such copies) at the office of the sub-contractor where such papers, books or documents are located. The information obtained shall be used only for purposes relating to reinsurance under this agreement and as permitted under Section 3.7.
- 3.7 Co-operation. Each party hereto shall co-operate fully with the other in all reasonable respects in order to accomplish the objectives of this Agreement including making available to each their respective officers and employees for interview and meetings with Governmental Authorities and furnishing any additional assistance, information and documents as may be reasonably requested by either party from time to time. Each party is permitted to furnish such documents and information concerning this Agreement, the reinsurance under this Agreement and the objectives of this Agreement

7

---

(i) to its advisors, insurance managers and auditors as may be desirable in connection with servicing the business of the party concerned or such party complying with Applicable Law and (ii) as required under Applicable Law.

- 3.8 Errors and Omissions. If any delay, omission, error or failure to pay amounts due or to perform any other act required by this Agreement is unintentional and caused by misunderstanding or oversight, the Company and the Reinsurer will adjust the situation to what it would have been had the misunderstanding or oversight not occurred. The party first discovering such misunderstanding or oversight, or an act resulting from such misunderstanding or oversight, will notify the other party in writing promptly upon discovery thereof, and the parties shall act to correct such misunderstanding or oversight within twenty (20) Business Days of such other party's receipt of such notice. However, this Section shall not be construed as a waiver by either party of its right to enforce strictly the terms of this Agreement.
- 3.9 Age, Sex and Other Adjustments. The liability of the Reinsurer shall follow that of the Company including in circumstances where the Company's liability under any of the Relevant Risks is changed because of a misstatement of age or sex or any other material fact, and the Company and the Reinsurer will make all appropriate adjustments to amounts due to each other under this Agreement in such circumstances.
- 3.10 Setoff. Any debts or credits, matured or unmatured, liquidated or unliquidated, regardless of when they arose or were incurred, in favour of or against either the Company or the Reinsurer with respect to this Agreement are deemed mutual debts or credits, as the case may be, and shall be setoff from any amounts due to the Company or the Reinsurer hereunder, as the case may be, and only the net balance shall be allowed or paid.

#### ARTICLE IV

##### CEDING COMMISSION

- 4.1 Ceding Commission. On and subject to the terms of this Agreement, the Reinsurer shall pay to the Company (or, as the case may be, the Company shall pay to the Reinsurer), an estimate of the Ceding Commission (the "Estimated Ceding Commission") payable in respect of that Accounting Period in an amount determined in accordance with Schedule A Part II. The amount of the Estimated Ceding Commission in respect of each Accounting Period shall, subject to Section 4.2 below, be calculated by the Reinsurer in good faith on the basis of information provided by the Company and shall be paid, by the Reinsurer or the Company as the case may be, at the same time as any Negative or Positive Settlement Amount required to be paid in respect of the previous Accounting Period becomes due in accordance with the arrangements set out in Section 5.4 below. The Estimated Ceding Commission in respect of any Accounting Period is, for the avoidance of doubt, an estimate of the actual Ceding Commission due in respect of that Accounting Period and the adjustment to such estimate shall be effected through the Ceding Commission Adjustments referred to in Schedule B and Section 5.5.

8

- 
- 4.2 Estimated Ceding Commission initially due. Notwithstanding Section 4.1, the amounts of the Estimated Ceding Commission in respect of each of the first 12

Accounting Periods shall be in the respective amounts set out in Schedule A Part III. The Reinsurer shall pay to the Company an amount equal to the Estimated Ceding Commission amounts in respect of all Accounting Periods commencing prior to the execution and delivery of this Agreement as set out in Schedule A Part III and, for the avoidance of doubt, the Company shall take account of such amount payable when producing the First Monthly Report in accordance with section 5.4(b) below. Subsequent amounts due as Estimated Ceding Commission under Schedule A Part III shall be paid in accordance with Section 5.4 below.

## ARTICLE V

### ACCOUNTING AND SETTLEMENT: RESERVE ADJUSTMENT

5.1 Monthly Reports. Subject as set out in Section 5.4(b), no later than 3 Business Days before the end of each Accounting Period (or more frequently as mutually agreed by the parties) the Company shall supply the Reinsurer with a report that shall provide an estimate of the financial data for such Accounting Period required in Schedule B together with details of the Ceding Commission estimated to be payable in respect of the following Accounting Period (the "Monthly Report").

5.2 Computations. At the end of each Accounting Period the Company shall compute:

- (i) the amount (being "X" in the formula set out in Section 5.3 below) shown in Line 3 in the table contained in Schedule B; and
- (ii) the amount (being "Y" in the formula set out in Section 5.3 below) shown in Line 7 in the table contained in Schedule B,

in each case in accordance with the notes set out in Schedule B and insofar as not inconsistent with such notes otherwise in accordance with the Valuation and Accounting Principles.

5.3 Positive and Negative Settlement Amounts.

(a) In respect of each Accounting Period, if the formula:

$$(X - Y + RIR - A + B)$$

shall produce a positive amount, that shall be the Positive Settlement Amount for that Accounting Period, and if it shall produce a negative amount, that shall be the Negative Settlement Amount for that Accounting Period, and that Positive Settlement Amount or Negative Settlement Amount, as the case may be, shall be the amount set out in Line 11 of Schedule B.

(b) For the purposes of the formula set out in Section 5.3(a):

9

---

(i) "A" shall be the Reinsurer's Ceding Commission Adjustment shown in Line 9 in the table contained in Schedule B; and

(ii) "B" shall be the Company's Ceding Commission Adjustment shown in Line 10 in the table contained in Schedule B.

(c) The amount of RIR in respect of any Accounting Period shall be determined by multiplying an amount equal to:

- (i) the Mathematical Reserves as at the opening of business on the first day of the Accounting Period; less
- (ii) the amount of the Company's provision for deferred acquisition costs (excluding any provision for deferred acquisition costs attributable to the Bonds) as at the opening of business on the first day of the Accounting Period,

by a rate equal to:

$$\frac{C}{D}$$

where:

(A) "C" is the amount of investment income receivable by the Company in respect of the Accounting Period; and

(B) "D" is the total market value of the Company's investments (other than any investments acquired in connection with the Bonds or to which the Bonds are linked in any way and other than any investment of the Company in its subsidiary undertakings) as at the opening of business on the first day of the Accounting Period.

For the purposes of this Section 5.3(c), "investment income" shall mean all amounts derived from the holding of investments (other than any investments acquired in connection with the Bonds or to which the Bonds are linked in any way and other than any investment of the Company in its subsidiary undertakings) which are treated, in accordance with the Company's normal accounting policies, as being of an income nature, including any gains on the realisation of those investments and having taken account of any losses on the realisation of those investments. For the avoidance of doubt, "investment income" shall not include any unrealised gains or unrealised losses attributable to such investments.

5.4 Payments.

(a) Subject as provided in Section 5.4(b) below:

10

---

(i) For each Accounting Period in respect of which there is a Negative Settlement Amount, the Reinsurer shall pay to the Company by telegraphic transfer within 5 Business Days of the delivery of the Monthly Report by the Company an amount equal to the absolute value of such Negative Settlement Amount together with the Estimated Ceding Commission (if any) payable by the Reinsurer to the Company in respect of the following Accounting Period.

(ii) For each Accounting Period in respect of which there is a Positive Settlement Amount, the Company shall pay to the Reinsurer by telegraphic transfer within 5 Business Days of the delivery of the Monthly Report by the Company an amount equal to the absolute value of such Positive Settlement Amount together with the Estimated Ceding Commission (if any) payable by the Company to the Reinsurer in respect of the following Accounting Period.



- (iii) If there is a Negative Settlement Amount for any Accounting Period and the Company is required to pay the Estimated Ceding Commission to the Reinsurer in respect of the following Accounting Period, a net payment shall be made by the Company or the Reinsurer as appropriate.
  - (iv) If there is a Positive Settlement Amount for any Accounting Period and the Reinsurer is required to pay the Estimated Ceding Commission to the Company in respect of the following Accounting Period, a net payment shall be made by the Company or the Reinsurer as appropriate.
- (b) In relation to all Accounting Periods commencing prior to the execution and delivery of this Agreement, the Company shall calculate and deliver a report (“the First Monthly Report”) to the Reinsurer as to the total aggregate net amount payable by the Company (or as the case may be the Reinsurer) to place the Company and the Reinsurer in the respective financial positions in which they would have been under this Agreement on the date of such payment, disregarding for this purpose the time cost of money, had this Agreement been executed and delivered at the commencement of the first Accounting Period. Such payment shall be made by telegraphic transfer within 5 Business Days of the delivery of the First Monthly Report.
- 5.5 Actual Data. In preparing all reports required under this Agreement, the Company shall use all commercially reasonable efforts to supply the actual data. If the actual data cannot be supplied with the appropriate report, the Company shall produce best estimates and shall provide amended reports based on actual data no more than ten (10) Business Days after the actual data becomes available and the parties will settle any additional amounts due within five (5) Business Days thereafter, together with interest as provided in Section 5.7 hereof.

- 
- 5.6 Additional Reports and Information. For so long as this Agreement remains in effect and for a period of 7 years after its termination, each of the parties shall periodically furnish to the other such other reports and information as is reasonably available to it and as may be reasonably requested by such other party for regulatory, tax or similar purposes. Nothing in this Agreement shall restrict the Company from being entitled to apply to the Court for its dissolution at any time during such 7 year period but it shall first make arrangements for all data in its possession which may be requested by the Reinsurer to be handed over to a successor company which shall have undertaken, mutatis mutandis, to the Reinsurer in the terms of this Section 5.6.
- 5.7 Delayed Payments. In the event that all or any portion of any payment due to either party pursuant to this Agreement becomes overdue the portion of the amount overdue shall bear interest at an annual rate equal to 3 Month LIBOR on the date that the payment becomes overdue plus 200 basis points per annum, for the period that the amount is overdue.
- 5.8 Certificate of the Chief Financial Officer of the Company. The certificate of the Chief Financial Officer of the Company as to any matter arising in respect of the amount of any payment falling to be made under this Agreement shall, in the absence of manifest error, be final and binding on the parties.
- 5.10 Breach of Required Minimum Margin of Solvency. No payment required to be made by the Company to the Reinsurer at a relevant time under the terms of this Agreement shall be required to be made at that time if that payment would cause the Company to breach the “Required Minimum Margin” required to be maintained by the Company in accordance with the FSA’s Interim Prudential Sourcebook for Insurers (as amended or replaced from time to time). Any payment not made by the Company to the Reinsurer for this reason shall be paid by the Company to the Reinsurer as soon as the making of the payment would not cause that “Required Minimum Margin” to be breached.

## ARTICLE VI

### DURATION AND TERMINATION

- 6.1 Duration. Except as otherwise provided herein, this Agreement shall be unlimited in duration.
- 6.2 Reinsurer’s Liability. The Reinsurer’s liability with respect to the Relevant Liabilities will terminate on the date that termination takes effect as a result of any notice given at the option of the Reinsurer or the Company in accordance with Section 6.3 or Section 6.4 and otherwise on the date this Agreement is terminated upon the written agreement of the parties.
- 6.3 Termination on Insolvency. In the event of the insolvency of the Reinsurer, the Company shall have the right to terminate this Agreement and the reinsurance hereunder, such termination to be effective as soon as notice of the termination is given by the Company to the Reinsurer. With effect from the date that the notice of

---

termination is given under this Section 6.3, any amounts which are or become owing by the Company to the Reinsurer under this Agreement, whether prior to, on or after the date of that notice of termination, shall cease to be payable by the Company to the Reinsurer.

- 6.4 Optional Termination. Either the Reinsurer or the Company may terminate this Agreement and the reinsurance hereunder upon prior written notice given at any time to expire on the last day of the Accounting Period in which such notice is given, (i) at any time after the Reinsurer and the Company have both become wholly owned subsidiaries of Genworth Financial, Inc. or (ii) at any time after the Scheme becomes effective (with such amendments, deletions or additions to the Scheme as the parties to it may approve).

For the purposes of this Section, a company shall be a wholly owned subsidiary of Genworth Financial, Inc. if all of its ordinary shares are owned:-

- (i) by Genworth Financial, Inc., or
- (ii) by any other company the ordinary shares of which are owned directly by Genworth Financial, Inc. or by another wholly owned subsidiary of Genworth Financial, Inc.

6.5 Consequence of Termination

- (a) In the event that this Agreement is terminated pursuant to Section 6.4, this Agreement shall terminate as of the end of the applicable Accounting Period in which the notice of termination pursuant to Section 6.4 is received by the non-terminating party and a net accounting and settlement as to any balance due under this Agreement shall be undertaken by the parties for such Accounting Period and in respect of adjustments required for any earlier Accounting Period (the “Final Settlement”).
- (b) In the event that, subsequent to the Final Settlement, the Company receives any amount, or is required to pay any amount, or actual data becomes available to the Company, which in any such case was not taken into account in calculating any Positive or Negative Settlement Amount but which would have been so taken into account had it been received or paid or become available prior to the Termination Date or the Final Settlement, the Company or (as the case may be) the Reinsurer shall make such payment or payments to the other as is required to reflect as nearly as possible the position that would have prevailed had such amount or data been so taken into account, provided, however, that the obligations under this Section 6.5(b) to make any such payment shall terminate 18

---

ARTICLE VII

INSOLVENCY

- 7.1 Payments. In the event of the insolvency of the Company, payment due to the Company under this Agreement shall be payable by the Reinsurer directly to the Company or to its liquidator, receiver, or statutory successor on the basis of the liability of the Company under the contract or contracts reinsured, without diminution because of the insolvency of the Company. It is agreed and understood, however, that (i) in the event of the insolvency of the Company, the Company shall give to the Reinsurer written notice of the pendency of a claim against the insolvent Company on a Reinsured Policy within a reasonable time after such claim is filed in the insolvency proceeding and (ii) during the pendency of such claim the Reinsurer may investigate such claim and interpose, at its own expense, in the proceeding where such claim is to be adjudicated any defences which it may deem available to the Company or its liquidator, receiver or statutory successor.
- 7.2 Expenses. It is further understood that any expense thus incurred by the Reinsurer pursuant to Section 7.1 shall be chargeable, subject to court approval, against the insolvent Company as part of the expense of liquidation to the extent of a proportionate share of the benefit which may accrue to the Company solely as a result of the defence undertaken by the Reinsurer.

ARTICLE VIII

DISPUTE RESOLUTION

8.1 General Provisions.

- (a) Any dispute, controversy or claim arising out of or relating to this Agreement or the validity, interpretation, breach or termination thereof (a "Dispute"), shall be resolved in accordance with the procedures set forth in this Article VIII, which shall be the sole and exclusive procedure for the resolution of any such Dispute.
- (b) Commencing with the request contemplated by Section 8.2, all communications between the parties or their representatives in connection with the attempted resolution of any Dispute, including any mediator's evaluation referred to in Section 8.3, shall be deemed to be without prejudice communications and to have been delivered in furtherance of a Dispute settlement and shall be exempt from inspection, and shall not be admissible in evidence for any reason (whether as an admission or otherwise).
- (c) In connection with any Dispute, the parties expressly waive and forego any right to (i) punitive, exemplary, statutorily-enhanced or similar damages in excess of compensatory damages, and (ii) trial by jury.

- (d) The specific procedures set forth below, including but not limited to the time limits referenced therein, may be modified by agreement of the parties in writing.
- (e) The running of time shall be suspended in respect of any Dispute for the purposes of any defences based upon the passage of time (whether under the Limitation Act 1980 (in its present form or as subsequently amended or replaced) or otherwise) while the procedures specified in this Article VIII are pending. The parties will take such action, if any, required to effectuate this suspension.

8.2 Consideration by Senior Executives. If a Dispute is not resolved in the normal course of business at the operational level, the parties shall attempt in good faith to resolve any Dispute by negotiation between executives who hold, in respect of each of the business entities involved in the Dispute, at a minimum, the office of President, Chief Executive Officer or Chief Financial Officer. Either party may initiate the executive negotiation process by written notice to the other. Fifteen (15) days after delivery of the notice, the receiving party shall submit to the other a written response. The notice and response shall include (i) a statement of the Dispute and of each party's position, and (ii) the name and title of the executive who will represent that party and of any other person who will accompany the executive. Such executives will meet in person or by telephone within 30 days of the initial notice to seek a resolution.

8.3 Mediation. If a Dispute is not resolved by negotiation as provided in Section 8.2 within forty-five (45) days from the initial notice, then either party may submit the Dispute for resolution by mediation pursuant to the Center for Public Resources ("CPR") Model Mediation Procedure as then in effect. The parties will select a mediator from the CPR Panels of Distinguished Neutrals, but such mediator must have prior reinsurance experience either as a lawyer or as a present or former officer or management employee of a reinsurance company, but not of the Company, or the Reinsurer, or any of their respective affiliates. Either party at commencement of the mediation may ask the mediator to provide an evaluation of the Dispute and the parties' relative positions.

8.4 Arbitration. If a Dispute is not resolved by mediation as provided in Section 8.3 within thirty (30) days of the selection of a mediator (unless the mediator chooses to withdraw sooner), either party may submit the Dispute to be finally resolved by arbitration pursuant to the CPR Rules for Non-Administered Arbitration as then in effect. The parties consent to a single, consolidated arbitration for all known Disputes existing at the time of the arbitration and for which arbitration is permitted.

- (a) The neutral organisation for purposes of the CPR rules will be the CPR. the arbitral tribunal shall be composed of three arbitrators who are each experienced in the reinsurance business, of whom each party shall appoint one in accordance with the "screened" appointment procedure provided in Rule 5.4 of the CPR rules. The non-party appointed arbitrator must have prior U.S. reinsurance experience as a present or former officer or management employee of a reinsurance company, but not of the Company, or the Reinsurer, or any of

---

their respective affiliates. The arbitration shall be conducted in New York. Each party shall be permitted to present its case, witnesses and evidence, if any, in the presence of the other party. A written transcript of the proceedings shall be made and furnished to the parties. The arbitrators shall determine the dispute in accordance with English law, without giving effect to any conflict of law rules or other rules that might render such law inapplicable or unavailable, and shall apply this Agreement according to its terms, provided that the provisions relating to arbitration shall be governed by the Federal Arbitration Act, 9 U.S.C. § 1 et seq.

- (b) The parties agree to be bound by any award or order resulting from any arbitration conducted hereunder and further agree that judgment on any award or order resulting from an arbitration conducted under this Section may be entered and enforced in any court having jurisdiction thereof.

- (c) Except as expressly permitted by this Agreement, no party will commence or voluntarily participate in any court action or proceeding concerning a Dispute, except (i) for enforcement as contemplated by Section 8.4(c) above, (ii) to restrict or vacate an arbitral decision based on the grounds specified under Applicable Law, or (iii) for interim relief as provided in paragraph (e) below. For the purposes of the foregoing the parties hereto submit to the non-exclusive jurisdiction of the courts of England.
- (d) In addition to the authority otherwise conferred on the arbitral tribunal, the tribunal shall have the authority to make such orders for interim relief, including injunctive relief, as it may deem just and equitable. Notwithstanding paragraph (d) above, each party acknowledges that in the event of any actual or threatened breach of certain of the provisions of this Agreement, the remedy at law may not be adequate, and therefore injunctive or other interim relief may be sought immediately to restrain such breach. If the tribunal shall not have been appointed, either party may seek interim relief from a court having jurisdiction if the award to which the applicant may be entitled may be rendered ineffectual without such interim relief. Upon appointment of the tribunal following any grant of interim relief by a court, the tribunal may affirm or disaffirm such relief, and the parties will seek modification or rescission of the court action as necessary to accord with the tribunal's decision.
- (e) Each of the parties will bear its own legal costs in relation to any arbitration proceedings considered under this Section.
- 8.5 Agreement to an alternative procedure. If the parties to this Agreement mutually agree that the alternate procedure set out in Section 8.6 and 8.7 below shall apply to a particular Dispute, then the parties shall resolve that Dispute in accordance with Sections 8.6 and 8.7 below rather than in accordance with Sections 8.3 and 8.4 above.
- 8.6 Alternative Mediation procedure. If the parties have mutually agreed under Section 8.5 that this section shall apply to a Dispute and such Dispute is not resolved by negotiation

16

---

as provided in Section 8.2 within 45 days from the initial notice (or such longer period as the parties may agree) then the parties will attempt to settle that Dispute by mediation in accordance with the Centre for Effective Dispute Resolution (CEDR Solve) Model Mediation Procedure (the "Model Procedure"). To initiate a mediation, either party shall give notice in writing ("ADR Notice") to the other party in accordance with the provisions of Section 9, requesting mediation in accordance with the provisions of the Model Procedure. A copy of the ADR Notice should also be sent to CEDR Solve.

- 8.7 Alternative Arbitration procedure. If the parties have mutually agreed under Section 8.5 that this section shall apply to a Dispute and such Dispute is not resolved within 42 days (or such longer period as the parties may agree) of the giving of the ADR Notice, or if one of the parties refuses to participate in mediation, the Dispute shall be referred to and finally resolved under the Rules of Arbitration of the International Chamber of Commerce (the "Rules") by 3 arbitrators appointed in accordance with the Rules, and so that:
- (a) The Tribunal shall consist of three arbitrators to be appointed in accordance with the Rules.
- (b) The place of arbitration shall be London.
- (c) The language to be used in the arbitral proceedings shall be English.

#### ARTICLE IX

##### MISCELLANEOUS PROVISIONS

- 9.1 Headings and Schedules. Headings used herein are not a part of this Agreement and shall not affect the terms hereof. The attached Schedules are a part of this Agreement.
- 9.2 Notices. All notices, requests, demands and other communications under this Agreement must be in writing and will be deemed to have been duly given or made as follows: (a) if sent by registered or certified mail with a return receipt requested, upon receipt; (b) if sent by reputable overnight air courier, four Business Days after mailing; (c) if sent by facsimile transmission, with a copy mailed on the same day in the manner provided in (a) or (b) above, when transmitted and receipt is confirmed by telephone; or (d) if otherwise actually personally delivered, when delivered, and shall be delivered as follows.

If to the Company:

Vantage West,  
Great West Road,  
Brentford,  
Middlesex TW8 9AG

17

---

Facsimile: +44 (0) 20 8380 3065  
Attention: Company Secretary

If to the Reinsurer:

Craig Appin House,  
8 Wesley Street,  
Hamilton,  
Bermuda,

Facsimile: +441 292 4910  
Attention: Iain Lever (Aon Insurance Managers (Bermuda) Limited),

or to such other address or to such other Person as either party may have last designated by notice to the other party.

- 9.3 Successors and Assigns. This Agreement shall be binding upon and inure to the benefit of the parties hereto and their respective successors, permitted assigns and legal representatives. Neither this Agreement, nor any right or obligation hereunder, may be assigned by any party without the prior written consent of the other party hereto save that all of the rights and obligations of the Company under this Agreement shall automatically transfer to FINCL upon the Scheme becoming effective (with such amendments, deletions or additions to the Scheme as the parties to it may approve). Any assignment in violation of this Section 9.3 shall be void and shall have no force and effect. Nothing in this Section 9.3 shall be construed to prohibit the Reinsurer from retroceding all or any portion of the business reinsured hereunder.

- 9.4 Execution in Counterpart. This Agreement may be executed by the parties hereto in any number of counterparts, and by each of the parties hereto in separate counterparts, each of which counterparts, when so executed and delivered, shall be deemed to be an original, but all such counterparts shall together constitute but one and the same instrument.
- 9.5 Currency. Whenever the acronym “GBP” or the “£” sign appears in this Agreement, they shall be construed to mean British Pounds Sterling and all transactions under this Agreement shall be in British Pounds Sterling.
- 9.6 Amendments. This Agreement may not be changed, altered or modified unless the same shall be in writing executed by the Company and the Reinsurer.
- 9.7 Governing Law. This Agreement will be construed, performed and enforced in accordance with the laws of England without giving effect to its principles or rules of conflict of laws thereof to the extent such principles or rules would require or permit the application of the laws of another jurisdiction.
- 9.8 Entire Agreement: Severability. This Agreement constitutes the entire agreement between the parties hereto relating to the subject matter hereof and supersedes all prior

18

---

and contemporaneous agreements, undertakings, statements, representations and warranties, negotiations and discussions, whether oral or written of the parties and there are no general or specific warranties, representations or other agreements by or among the parties in connection with the entering into of this Agreement or the subject matter hereof except as specifically set forth or contemplated herein.

- 9.9 Enforceability. If any provision of this Agreement is held to be void or unenforceable, in whole or in part, (i) such holding shall not affect the validity and enforceability of the remainder of this Agreement, including any other provision, paragraph or subparagraph, and (ii) the parties agree to attempt in good faith to reform such void or unenforceable provision to the extent necessary to render such provision enforceable and to carry out its original intent.
- 9.10 No Waiver: Preservation of Remedies. No consent or waiver, express or implied, by any party to or of any breach or default by any other party in the performance by such other party of its obligations hereunder shall be deemed or construed to be a consent or waiver to or of any other breach or default in the performance of obligations hereunder by such other party hereunder. Failure on the part of any party to complain of any act or failure to act of any other party or to declare any other party in default, irrespective of how long such failure continues, shall not constitute a waiver by such first party of any of its rights hereunder. The rights and remedies provided are cumulative and are not exclusive of any rights or remedies that any party may otherwise have at law or equity.
- 9.11 Third Party Beneficiary. Nothing in this Agreement shall confer any rights upon any Person that is not a party or a successor or permitted assignee of a party to this Agreement.
- 9.12 Interpretation. Whenever the words “include”, “includes” or “including” are used in this Agreement, they shall be deemed to be followed by the words “without limitation”.
- 9.13 Survival. Articles VIII and IX shall survive the termination of this Agreement and Section 6.5(b) shall remain in force for a period of 18 months after the date on which any notice is served under Section 6.4.
- 9.14 Negotiated Agreement. This Agreement has been negotiated by the parties and the fact that the initial and final draft will have been prepared by either party or an intermediary will not give rise to any presumption for or against any party to this Agreement or be used in any respect or forum in the construction or interpretation of this Agreement or any of its provisions.

19

---

IN WITNESS WHEREOF, the parties hereto have caused this Agreement to be executed by their duly authorised representatives.

FINANCIAL ASSURANCE COMPANY LIMITED

By \_\_\_\_\_

Name:  
Title:

VIKING INSURANCE COMPANY, LIMITED

By \_\_\_\_\_

Name:  
Title:

20

---

SCHEDULE A – Part I

CEDING COMMISSION

The Company shall calculate in respect of each Accounting Period the amount by which the deferred acquisition costs of the Company (excluding the deferred acquisition costs attributable to the Bonds) shall have increased or decreased over such Accounting Period (the “Ceding Commission”). The Ceding Commission in respect of such Accounting Period for the purposes of Article IV of this Agreement:

- (i) shall be payable by the Reinsurer to the Company in an amount equal to the amount, if any, by which the deferred acquisition costs of the Company (excluding the deferred acquisition costs attributable to the Bonds) shall have decreased over that Accounting Period; and
- (ii) shall be payable by the Company to the Reinsurer in an amount equal to the amount, if any, by which the deferred acquisition costs of the Company (excluding the deferred acquisition costs attributable to the Bonds) shall have increased over that Accounting Period.

For the avoidance of doubt, the amount of deferred acquisition costs at any relevant time shall be calculated in accordance with the Valuation and Accounting Principles.

In calculating the Ceding Commission for the first Accounting Period, the deferred acquisition costs of the Company (excluding the deferred acquisition costs attributable to the Bonds) shall at the commencement of such Accounting Period be taken as £423,938,000.

SCHEDULE A – Part II

ESTIMATED CEDING COMMISSION

Subject as provided in Schedule A Part III below, the Reinsurer shall produce at the end of each Accounting Period on the basis of information provided by the Company a best estimate of the Ceding Commission for the next following Accounting Period.

SCHEDULE A - PART III

ESTIMATED CEDING COMMISSION FOR FIRST 12 ACCOUNTING PERIODS

For the first 12 Accounting Periods the Estimated Ceding Commission shall, in the case of each amount, be payable by the Reinsurer and shall be as follows, provided that the parties acknowledge that such amounts are estimates only and shall be the subject of the Reinsurer's Ceding Commission Adjustment and the Company's Ceding Commission Adjustment, as appropriate, in accordance with Lines 9 and 10 of Schedule B of this Agreement and Section 5.5:

<u>Accounting Period ending on:</u>	<u>Amount of Ceding Commission:</u>
31st January 2004	£ 26,007,000
29th February 2004	£ 24,848,000
31st March 2004	£ 23,028,000
30th April 2004	£ 19,476,000
31st May 2004	£ 19,532,000
30th June 2004	£ 17,194,000
31st July 2004	£ 16,968,000
31st August 2004	£ 15,205,000
30th September 2004	£ 14,074,000
31st October 2004	£ 13,715,000
30th November 2004	£ 12,007,000
31st December 2004	£ 11,850,000

SCHEDULE B

ACCOUNTING PERIOD REPORTS

Note: All amounts paid or payable or received or receivable by the Company in respect of the Bonds are to be excluded in any of the items listed below. No account shall be taken in any of the items listed below of any amount payable or receivable under this Agreement or of any change in the Company's provision for deferred acquisition costs provided that this shall not affect the requirement to include the Reinsurer's Ceding Commission Adjustment or the Company's Ceding Commission Adjustment as the case may be.

<u>Line no.</u>	<u>Item</u>	
1.	Earned Premiums	£
2.	Other Income	£
3.	<b>Total Income (Lines 1 to 2)</b>	£
4.	Claims Incurred	£
5.	Expenses Payable	£
6.	Other Changes In Technical Provisions	£
7.	<b>Total Expenditure (Lines 4 to 6)</b>	£
8.	RIR	£
9.	Reinsurer's Ceding Commission Adjustment	£
10.	Company's Ceding Commission Adjustment	£
11.	<b>Positive / (Negative) Settlement Amount (Line 3 - Line 7 + Line 8 - Line 9 + Line 10)</b>	£

where, in respect of each Accounting Period:

Line 1: "Earned Premiums" shall mean gross premiums written in such Accounting Period plus any decrease or minus any increase in the provision for unearned premiums over such Accounting Period, as described in item II.1 of the Statutory Format and the notes thereto. In calculating the gross premiums written in any Accounting Period there shall be deducted the outward reinsurance premiums paid in such Accounting Period. To the amount of any increase in the provision for unearned premiums over such Accounting Period there shall be added any decrease or there shall be subtracted any increase, over such Accounting Period, in the amount of the unearned reinsurance premiums paid by the Company. To the amount of any decrease in the provision for unearned premiums over such Accounting Period, there shall be added any increase, or there shall be subtracted any decrease, over such Accounting Period, in the amount of the unearned reinsurance premiums paid by the Company. In calculating the gross premiums written, full account shall be taken of

the effect of cancellations notified in such Accounting Period and of any other arrangement under which a policy is terminated in such Accounting Period;

Line 2: "Other Income" shall mean all other income becoming due to the Company in the relevant Accounting Period, excluding any income from investments and any realised or unrealised gains on investments and excluding any amount received or becoming due under Ceded Reinsurance;

Line 3: "Total Income" shall mean the sum of Earned Premiums and Other Income;

- Line 4: "Claims Incurred" shall mean claims paid in respect of the Relevant Liabilities less reinsurance recoveries received in respect of the Relevant Liabilities in the relevant Accounting Period plus any increase (or minus any decrease) over such Accounting Period in the provision for claims. For these purposes, such provision for claims shall be calculated, at the beginning and end of each Accounting Period, net of any available credit for reinsurance, not being a credit in respect of any reinsurance claim which is due but unpaid, and otherwise in accordance with the manner in which such provision for claims would be calculated for the purposes of item II.5(b) of the Statutory Format;
- Line 5: "Expenses Payable" shall mean operating expenses incurred in the relevant Accounting Period including without limitation:-
- (a) bonuses and rebates, net of reinsurance, as described in item II.7 of the Statutory Format;
  - (b) acquisition costs, administrative expenses, reinsurance commissions and profit participation, as described in item II.8 of the Statutory Format and the notes thereto; and
  - (c) the charges described in items II.11 and III.8 of the Statutory Format,
- but, for the avoidance of doubt, shall exclude investment expenses and charges, realised or unrealised losses on investments, and income and corporation tax;
- Line 6: "Other Changes in Technical Provisions" shall mean the increase in technical provisions (or the decrease in technical provisions in which event such decrease shall be expressed as a negative amount) not accounted for in any other line of this Schedule B, as described in item II.6 of the Statutory Format and any other increases in reserves (or decreases in reserves, in which event such decreases shall be expressed as negative amounts) required to be taken into account for the purposes of the returns made to the FSA but not required to be so taken into account under Schedule 9A of the Companies Act 1985 in respect of the Company including any change required as a result of the Company not having received any amount due in respect of Ceded Reinsurance;

23

---

- Line 7: "Total Expenditure" shall mean the sum of Claims Incurred, Expenses Payable and Other Changes in Technical Provisions;
- Line 8: "RIR" shall mean the amount calculated pursuant to Section 5.3(c) of this Agreement; and
- Line 9: "Reinsurer's Ceding Commission Adjustment" shall mean the amount (if any) due from the Reinsurer as a result of the actual Ceding Commission for such Accounting Period calculated in accordance with Schedule A Part I being different from the Estimated Ceding Commission for that Accounting Period;
- Line 10: "Company's Ceding Commission Adjustment" shall mean any amount due from the Company as a result of the actual Ceding Commission for such Accounting Period calculated in accordance with Schedule A Part I being different from the Estimated Ceding Commission for that Accounting Period;
- Line 11: the "Positive Settlement Amount" and the "Negative Settlement Amount" shall mean the amounts calculated pursuant to Section 5.3(a) of this Agreement.

Any amounts included in any of the items listed above shall be included in the calculation set out in this Schedule B only to the extent that such amounts have not been accounted for in any Monthly Report relating to any previous Accounting Period. Any amount specifically excluded from any line item shall be treated as though it were excluded from all other line items unless the context shall expressly require otherwise. No amount shall be included in more than one line item. In the event of any conflict between the application of any express provision in these notes or this Agreement, and the application of any statutory or regulatory rule under this Schedule, in each case for the purposes of determining the amount of any line item in this Schedule, the express provisions in these notes and this Agreement shall prevail.

In calculating the Positive or Negative Settlement Amount (as the case may be) for the first Accounting Period:-

- (i) the provision for unearned premiums shall at the commencement of such Accounting Period be taken as £785,731,000;
- (ii) the amount of the unearned reinsurance premiums shall at the commencement of such Accounting Period be taken as £16,897,000;
- (iii) the claims provision net of any available credit for reinsurance, not being a credit in respect of any reinsurance claim which is due but unpaid at the commencement of such Accounting Period shall at such commencement be taken as £89,517,000; and
- (iv) the technical provisions and reserves referred to in Line 6 above shall at the commencement of such Accounting Period be taken as £3,000,000.

24

---

## SCHEDULE C

### THE BONDS

1. Guaranteed Equity Bonds - single premium life endowment products with a fixed term of five to six years.
  2. Guaranteed Bonds - single premium life endowment products with a fixed term of up to seven years.
  3. Flexible Term Guaranteed Bonds - single premium whole life guaranteed bonds on an annually renewable basis.
  4. Investment Bonds - single premium unit linked whole life policies, the benefits of which are linked to one of three internal linked funds, equity, international or managed.
  5. Flexible Access Bonds - single premium unit linked whole life policies with the benefits linked to an internal deposit fund.
  6. Structured Settlements - whole life purchased life annuities generally written as the result of a court settlement. The payment stream is predefined but may be monthly, annual or even five yearly. Payments are either fixed or linked to the Retail Price Index.
  7. Individual Term Assurance – non-creditor regular premium temporary assurances providing life or long-term disability cover.
-

SCHEDULE D

LIST OF REINSURANCE ARRANGEMENTS

1. Stop loss treaty between the Company and White Rock Insurance Company PCC Limited which became effective as of 31 March 2004 for a period of 12 months from that date.





“Reinsured Risks” means the whole or, as the case may be, such part of the insurance risks related to payment protection insurance business as are assumed or borne by the Company under or in connection with any and all insurance policies and contracts to which it is a party and which are in force at any time on or prior to the Termination Date.

“Reinsurance Recoverables” means the amount of reinsurance recoverables that is actually collected under Ceded Reinsurance.

“Reserves” means the sum of all reserves and liabilities required to be maintained by the Company for the Reinsured Liabilities including any reserve for any Extra Contractual Liability, calculated consistent with the reserve requirements, statutory accounting rules and actuarial principles under the French laws.

“Termination Date” means the effective date of any termination of this Agreement as provided in Article 8.

3

---

## **ARTICLE 2 - COVERAGE**

Coverage. Upon the terms and subject to the conditions and other provisions of this Agreement, as of the Inception Date, the Reinsurer agrees to reinsure the Reinsured Liabilities by way of the Reinsurer indemnifying the Company in respect of each Negative Settlement Amount. As consideration for the reinsurance by the Reinsurer under this Agreement, the Company shall pay to the Reinsurer each Positive Settlement Amount.

Conditions. Except as otherwise set forth or contemplated herein, no changes, amendments or modifications made on or after the Inception Date to the terms and conditions of the Reinsured Risks in-force as of the Inception Date which adversely affect the liability of the Reinsurer hereunder shall be covered hereunder without the prior written approval of such changes, amendments or modifications by the Reinsurer, which approval shall not be unreasonably withheld or delayed. In the event that any such changes, amendments or modifications are made in any such Reinsured Risk without the prior written approval of the Reinsurer, this Agreement will cover liability incurred by the Company for Reinsured Risks as if the unapproved changes, amendments or modifications had not been made.

Territory. The territorial limits of the Agreement shall be identical to those of the Reinsured Risks.

Commutation of Ceded Reinsurance. The Company shall not, without the Reinsurer’s prior written approval, in its sole discretion, take any action to amend or terminate any Ceded Reinsurance under any Ceded Reinsurance Agreement or enter into any Commutation of Ceded Reinsurance.

New reinsurance covers. Subsequent to the Inception Date, the Company will not enter into any reinsurance arrangements with respect to the Reinsured Risks without the prior written consent of the Reinsurer, in its sole discretion.

## **ARTICLE 3 - ADMINISTRATION - GENERAL PROVISIONS**

Contract Administration. The Company shall procure that the Reinsured Risks are administered in accordance with their terms, in good faith and with the care, skill, prudence, and diligence of a person experienced in administering insurance business.

Sub-contracting of Contract Administration. The Company may subcontract the performance of any service or services which the Company is required to procure in connection with the administration of the Reinsured Risks to (i) an Affiliate, (ii) a service provider utilized by the Company with respect to the Reinsured Risks or its other business as of the date hereof, (iii) any Person to whom such subcontracting is required to be effected under the terms of any distribution agreement or (iv) with the prior written consent of the Reinsurer, any other Person, such consent not to be unreasonably withheld; provided, that no such subcontracting shall relieve the Company from any of its obligations or liabilities hereunder, and the Company shall remain responsible for all obligations or liabilities of such subcontractor with regard to the provision of such advice or services as if provided by the Company.

4

---

Ceded Reinsurance Agreements. The Company shall manage and administer the Ceded Reinsurance Agreements. Without limiting the forgoing, the Company shall promptly pay when due all reinsurance premiums due to reinsurers under the Ceded Reinsurance Agreements and use all commercially reasonable efforts to collect from such reinsurers all Reinsurance Recoverables due thereunder, it being understood that the Reinsurer will bear the risk of collectability of any Reinsurance Recoverable.

Reinsured Policy Terms. The Company shall set all insurance rates and underwriting criteria in respect of the Reinsured Risks from and after the Inception Date consistently with the manner in which it has done so in the past, consulting with the Reinsurer on any issue which is expected to have a material adverse impact on any amounts which the Reinsurer reasonably expects to become payable to it under the terms of this Agreement.

Claims Settlements. The Company agrees that if so requested by the Reinsurer it will provide notice to the Reinsurer as soon as is reasonably practicable of its intention to commence litigation proceedings in respect of a claim in excess of €100,000 with respect to a Reinsured Policy along with (if requested by the Reinsurer) copies of all pleadings and reports of investigation with respect to that claim. The Reinsurer shall have the right, at its own expense, to participate jointly with the Company in the investigation, adjustment or defence of such claims.

Inspection. The Company shall keep accurate and complete records, files and accounts of all transactions and matters with respect to the Reinsured Risks in accordance with its record management practices in effect from time to time. The Reinsurer or its designated representative may upon reasonable notice inspect and copy, at the offices of the Company where such records are located, the papers and any and all other books or documents of the Company reasonably relating to the Reinsured Risks and the administration thereof, during normal business hours for such period as this Agreement is in effect or for as long thereafter as the Company seeks performance by the Reinsurer pursuant to the terms of this Agreement or the Reinsurer reasonably needs access to such records for regulatory, tax or similar purposes. The information obtained shall be used only for purposes relating to reinsurance under this agreement.

Co-operation. Each party hereto shall co-operate fully with the other in all reasonable respects in order to accomplish the objectives of this Agreement including making available to each their respective officers and employees for interview and meetings with governmental authorities and furnishing any additional assistance, information and documents as may be reasonably requested by either party from time to time.

Errors and Omissions. If any delay, omission, error or failure to pay amounts due or to perform any other act required by this Agreement is unintentional and caused by misunderstanding or oversight, the Company and the Reinsurer will adjust the situation to what it would have been had the misunderstanding or oversight not occurred. The party first discovering such misunderstanding or oversight, or an act resulting from such misunderstanding or oversight, will notify the other party in writing promptly upon discovery thereof, and the parties shall act to correct such misunderstanding or oversight within twenty (20) business days of such other party’s receipt of such notice. However, this section shall not be construed as a waiver by either party of its right to enforce strictly the terms of this Agreement.

5

---

Age, Sex and Other Adjustments. The liability of the Reinsurer shall follow that of the Company including in circumstances where the Company's liability under any of the Reinsured Risks is changed because of a misstatement of age or sex or any other material fact, and the Company and the Reinsurer will make all appropriate adjustments to amounts due to each other under this Agreement in such circumstances.

Setoff. Any debts or credits, matured or unmatured, liquidated or unliquidated, regardless of when they arose or were incurred, in favour of or against either the Company or the Reinsurer with respect to this Agreement between the Company and the Reinsurer, are deemed mutual debts or credits, as the case may be, and shall be set off from any amounts due to the Company or the Reinsurer hereunder, as the case may be, and only the net balance shall be allowed or paid.

#### **ARTICLE 4 - - REINSURANCE PREMIUM**

The reinsurance premium due as of the day the parties enter into this Agreement by the Company to the Reinsurer shall be equal to the Reserves as of December 31, 2003 (the "Reinsurance Premium").

The amount of the Reinsurance Premium and the amount of the Deposit referred to in article 5 hereafter being equal as of the day the parties enter into this Agreement, the Company shall not make any payment in cash of the Reinsurance Premium and shall retain such Reinsurance Premium to constitute the Reinsurer's Deposit as of the day the parties enter into this Agreement.

#### **ARTICLE 5 - DEPOSIT**

In order to allow the Company to take credit in its balance sheet of this quota share reinsurance, the Reinsurer will deposit in the Company's accounts as of the day the parties enter into this Agreement an amount equal to the Reserves as of December 31, 2003 in accordance with article R332.17 of the French Insurance Code (the "Deposit").

The amount of the Deposit will be increased or decreased every quarter, in the framework of the Quarterly Settlements until the Termination of this Agreement, such adjustment(s) being equal to the increase or decrease in the Reserves referred to in Article 7.

The Deposit will bear an interest equal to five point two per cent (5.2%) per annum that will be computed every quarter through the Quarterly Settlements.

#### **ARTICLE 6 - - CEDING COMMISSION**

The Reinsurer shall pay a ceding commission (the "Ceding Commission") to the Company for each Accounting Period in an amount equal to four point four per cent (4.4%) of the earned premiums that will be paid through the Quarterly Settlements.

6

---

#### **ARTICLE 7 - ACCOUNTING AND SETTLEMENT**

##### (a) Quarterly Settlement

As soon as feasible but no more than fifteen (15) days after the end of each Accounting Period, the Company shall supply the Reinsurer with a report that shall compute the following financial data for such Accounting Period:

- The earned premiums plus other income excluding any investment income and realized and/or unrealised capital gains, related to the Reinsured Risks net of any insurance taxes and of any guarantee fund contribution related to these premiums and net of any reinsurance cost related to the Ceded Reinsurance;
- Minus the claims paid on the Reinsured Liabilities, net of any reinsurance received under the Ceded Reinsurance;
- Minus the Direct Commission net of any portion thereof actually paid under Ceded Reinsurance;
- Minus any increase in the Reserves;
- Plus any decrease of the Reserves;
- Plus interest on the Deposit calculated in reference to Article 5 hereof;
- Minus the Ceding Commission.

##### Payments.

For each Accounting Period as to which there is a Negative Settlement Amount, the Reinsurer shall pay to the Company an amount equal to such Negative Settlement Amount within ten (10) days of the delivery of the Quarterly Report by the Company.

For each Accounting Period as to which there is a Positive Settlement Amount the Company shall pay to the Reinsurer an amount equal to such Positive Settlement Amount within ten (10) days of the delivery of the Quarterly Report by the Company.

Delayed Payments. In the event that all or any portion of any payment due to either party pursuant to this Agreement becomes overdue the portion of the amount overdue shall bear interest at an annual rate equal to 3 Month EURIBOR on the date that the payment becomes overdue plus 200 basis points per annum, for the period that the amount is overdue.

##### (b) Other Report

Annual Reports. Within forty-five (45) days after the end of each calendar year the Company shall supply the Reinsurer with a report that shall provide the financial data specified in the previous section for such calendar year.

Additional Reports and Updates. For so long as this Agreement remains in effect, each of the parties shall periodically furnish to the other such other reports and information as is reasonably available to it and as may be reasonably requested by such other party for regulatory, tax or similar purposes.

7

---

(c) Actual Data

In preparing all reports required under this Agreement, the Company shall use all commercially reasonable efforts to supply the actual data. If the actual data cannot be supplied with the appropriate report, the Company shall produce best estimates and shall provide amended reports based on actual data no more than ten (10) days after the actual data becomes available and the parties will settle any additional amounts due within five (5) days thereafter, together with interest as provided in the last paragraph of Article 7 (a) hereof.

**ARTICLE 8 - DURATION AND TERMINATION**

- 8.1 Duration. Except as otherwise provided herein, this Agreement shall be unlimited in duration.
- 8.2 Reinsurer's Liability. The Reinsurer's liability with respect to the Reinsured Risks under this Agreement will terminate on the earlier of: (i) the date that all amounts due under this Agreement have been paid; (ii) the date this Agreement is terminated at the option of the Reinsurer or the Company in accordance with Article 8.3 hereof; and (iii) the date this Agreement is terminated upon the written agreement of the parties.
- 8.3 Optional Termination: Final Payment Obligations. Either the Reinsurer or the Company may terminate this Agreement and the reinsurance hereunder upon at least 3 business days prior written notice of its intent to terminate this Agreement upon the execution of the Portfolio Transfer by the Company of the Reinsured Risks.
- 8.4 Consequence of Termination
- a) In the event that this Agreement is terminated pursuant to section 8.3, this Agreement shall terminate as of the end of the quarter in which the notice of termination pursuant to the previous section is received by the non-terminating party and a net accounting and settlement as to any balance due under this Agreement shall be undertaken by the parties for such Accounting Period (the "Final Settlement").
- b) In the event that, subsequent to the Final Settlement but not later than eighteen (18) months after the Termination Date, the Company receives any amount, or is required to pay any amount, which was not taken into account in calculating any Positive or Negative Settlement Amount but which would have been so taken into account had it been received or paid prior to the Termination Date or the Final Settlement, the Company or (as the case may be) the Reinsurer shall make such payment or payments to the other as is required to reflect as nearly as possible the position that would have prevailed had such amount been so taken into account.

**ARTICLE 9 - DISPUTE RESOLUTION**

- 9.1 General Provisions.
- (a) Any dispute, controversy or claim arising out of or relating to this Agreement or the validity, interpretation, breach or termination thereof (a "Dispute"), shall be resolved

8

---

in accordance with the procedures set forth in this Article 9, which shall be the sole and exclusive procedure for the resolution of any such Dispute.

- (b) Commencing with the request contemplated by Section 9.2, all communications between the parties or their representatives in connection with the attempted resolution of any Dispute, including any mediator's evaluation referred to in Section 9.3, shall be deemed to have been delivered in furtherance of a Dispute settlement and shall not be admissible in evidence for any reason (whether as an admission or otherwise), in any arbitral or other proceeding for the resolution of the Dispute.
- (c) The present arbitration clause does not exclude the right of recourse to the courts in respect of any measure which the Code of Civil Procedure permits to be taken by court order ("ordonnance"), including, without limitation, any measure ordered in proceedings "en référé", where such order does not prejudice the legal determination of the substance of any issue submitted to arbitration.
- (d) The specific procedures set forth below, including but not limited to the time limits referenced therein, may be modified by agreement of the parties in writing.
- (e) The parties agree and accept that the commencement of arbitration proceedings hereunder will interrupt any prescription which may at the relevant time be running in respect of any right which is the object of, or is otherwise affected by, such proceedings.
- 9.2 Consideration by Senior Executives. If a Dispute is not resolved in the normal course of business at the operational level, the parties shall attempt in good faith to resolve any Dispute by negotiation between executives who hold, in respect of each of the business entities involved in the Dispute, at a minimum, the office of President, Chief Executive Officer or Chief Financial Officer. Either party may initiate the executive negotiation process by written notice to the other. Fifteen (15) days after delivery of the notice, the receiving party shall submit to the other a written response. The notice and response shall include (i) a statement of the Dispute and of each party's position, and (ii) the name and title of the executive who will represent that party and of any other person who will accompany the executive. Such executives will meet in person or by telephone within 30 days of the initial notice to seek a resolution.
- 9.3 Mediation. If a Dispute is not resolved by negotiation as provided in Section 9.2 within forty-five (45) days from the initial notice, then either party may submit the Dispute for resolution by mediation pursuant to the Center for Public Resources ("CPR") Model Mediation Procedure as then in effect. The parties will select a mediator from the CPR Panels of Distinguished Neutrals, but such mediator must have prior reinsurance experience either as a lawyer or as a present or former officer or management employee of a reinsurance company, but not of the Company, or the Reinsurer, or any of their respective affiliates. Either party at commencement of the mediation may ask the mediator to provide an evaluation of the Dispute and the parties' relative positions.
- 9.4 Arbitration. If a Dispute is not resolved by mediation as provided in Section 9.3 within thirty (30) days of the selection of a mediator (unless the mediator chooses to withdraw sooner), either party may submit the Dispute to be finally resolved by arbitration pursuant to the CPR Rules for Non-Administered Arbitration as then in

9

---

effect. The parties consent to a single, consolidated arbitration for all known Disputes existing at the time of the arbitration and for which arbitration is permitted.

- (a) The neutral organisation for purposes of the CPR rules will be the CPR. the arbitral tribunal shall be composed of three arbitrators who are each experienced in the reinsurance business, of whom each party shall appoint one in accordance with the "screened" appointment procedure provided in Rule 5.4 of the CPR rules. The non-party appointed arbitrator must have prior French reinsurance experience as a present or former officer or management employee of a reinsurance company, but not of the Company, or the Reinsurer, or any of their respective affiliates. The arbitration shall be conducted in Paris. Each party shall be permitted to present its case, witnesses and evidence, if any, in the presence of the other party. A written transcript of the proceedings shall be made and furnished to the parties. The arbitrators shall determine the dispute in accordance with French law, without giving effect to any conflict of law rules or other rules that might render such law inapplicable or

unavailable, and shall apply this Agreement according to its terms.

- (b) The parties agree to be bound by any award or order resulting from any arbitration conducted hereunder and further agree that judgment on any award or order resulting from an arbitration conducted under this Section may be entered and enforced in any court having jurisdiction thereof.
- (c) Except as expressly permitted by this Agreement, no party will commence or voluntarily participate in any court action or proceeding concerning a Dispute, except (i) for enforcement as contemplated by Section 9.4(b) above, (ii) to restrict or vacate an arbitral decision based on the grounds specified under French Law, or (iii) for interim relief as provided in paragraph (e) below. For the purposes of the foregoing the parties hereto submit to the non-exclusive jurisdiction of the French courts.
- (d) Each party will bear its own attorneys' fees and costs.

**ARTICLE 10 - MISCELLANEOUS PROVISIONS**

Notices. All notices, requests, demands and other communications under this Agreement must be in writing and will be deemed to have been duly given or made as follows: (a) if sent by registered or certified mail in France with return receipt requested, upon receipt; (b) if sent by reputable overnight air courier, four business days after mailing; (c) if sent by facsimile transmission, with a copy mailed on the same day in the manner provided in (a) or (b) above, when transmitted and receipt is confirmed by telephone; or (d) if otherwise actually personally delivered, when delivered, and shall be delivered as follows.

If to the Company:

To the Reinsurer:

or to such other address or to such other person as either party may have last designated by notice to the other party.

Successors and Assigns. This Agreement shall be binding upon and inure to the benefit of the parties hereto and their respective successors, permitted assigns and legal representatives. Neither this Agreement, nor any right or obligation hereunder, may be assigned by any party without the prior written consent of the other party hereto. Any assignment in violation of this section shall be void and shall have no force and effect. Nothing in this section shall be construed to prohibit the Reinsurer from retroceding all or any portion of the business reinsured hereunder.

Amendments. This Agreement may not be changed, altered or modified unless the same shall be in writing executed by the Company and the Reinsurer.

Governing Law. This Agreement will be construed, performed and enforced in accordance with the French laws without giving effect to its principles or rules of conflict of laws thereof to the extent such principles or rules would require or permit the application of the laws of another jurisdiction.

Entire Agreement: Severability. This Agreement constitutes the entire agreement between the parties hereto relating to the subject matter hereof and supersedes all prior and contemporaneous agreements, undertakings, statements, representations and warranties, negotiations and discussions, whether oral or written of the parties and there are no general or specific warranties, representations or other agreements by or among the parties in connection with the entering into of this Agreement or the subject matter hereof except as specifically set forth or contemplated herein.

Survival. Section 8.4(b) and Articles 9 and 10 shall survive the termination of this Agreement but shall, in the case of Section 8.4(b), terminate no later than eighteen (18) months after the Termination Date.

IN WITNESS WHEREOF, the parties hereto have caused this Agreement to be executed by their duly authorized representatives.

VIE PLUS  
By

\_\_\_\_\_  
Name:  
Title:

R.D PLUS  
By

\_\_\_\_\_  
Name:  
Title:

## MORTGAGE SERVICES AGREEMENT

dated as of \_\_\_\_\_, 2004

by and among

GE MORTGAGE SERVICES, LLC,

GENERAL ELECTRIC MORTGAGE  
HOLDINGS LLC,

GE MORTGAGE CONTRACT SERVICES INC.

and

GENWORTH FINANCIAL, INC.

ARTICLE IDEFINITIONS

Section 1.01. Certain Defined Terms  
Section 1.02. Other Terms

ARTICLE IISERVICES AND TERMS

Section 2.01. GEMH Services: Scope  
Section 2.02. Transition Employees Services  
Section 2.03. Management of Held Loans  
Section 2.04. Reporting; Transition; MSR Sale  
Section 2.05. Performance and Receipt of Services

ARTICLE IIIOTHER ARRANGEMENTS

Section 3.01. Computer-Based Resources  
Section 3.02. Access; Leased Premises

ARTICLE IVCOSTS AND DISBURSEMENTS; PERSONNEL COSTS; PAYMENTS

Section 4.01. Costs and Disbursements  
Section 4.02. Personnel Costs; Right to Hire; Severance  
Section 4.03. Loan Acquisition and Disposition Costs  
Section 4.04. Payments of Service Charges and Employment Costs

ARTICLE VSTANDARDS; COMPLIANCE WITH LAWS

Section 5.01. Standards  
Section 5.02. Compliance with Laws

ARTICLE VIPURCHASE OF NEW LOANS AND SALE OF LOANS AND LOAN ASSETS

Section 6.01. Loan Schedule  
Section 6.02. Loan Purchase Agreement  
Section 6.03. Agreement to Sell and Purchase the New Loans; Assignment of Claims  
Section 6.04. Loan Purchase Price  
Section 6.05. Conditions Precedent  
Section 6.06. Right of First Refusal  
Section 6.07. Repurchase of Loans  
Section 6.08. Transition Assistance  
Section 6.09. Further Assurances

i

ARTICLE VIIREPRESENTATIONS AND WARRANTIES

Section 7.01. Representations and Warranties of Mortgage Services  
Section 7.02. Representation and Warranties of GEMH Parties  
Section 7.03. Survival

ARTICLE VIIIINDEMNIFICATION; LIMITATION ON LIABILITY

Section 8.01. Limited Liability  
Section 8.02. Indemnification by GEMH  
Section 8.03. Indemnification by Mortgage Services  
Section 8.04. Loans and Loan Assets Indemnification  
Section 8.05. Indemnification Procedures.  
Section 8.06. Limitation on Liability  
Section 8.07. Liability for Payment Obligations

ARTICLE IX

DISPUTE RESOLUTION

Section 9.01.  
Section 9.02.

Applicable Law  
Dispute Resolution

ARTICLE X

TERMINATION

Section 10.01.  
Section 10.02.  
Section 10.03.  
Section 10.04.

Termination  
Effect of Termination  
Survival  
Business Continuity; Force Majeure

ARTICLE XI

GUARANTY

Section 11.01.  
Section 11.02.  
Section 11.03.

Guaranty  
Guaranty Absolute  
Waiver

ARTICLE XII

GENERAL PROVISIONS

Section 12.01.  
Section 12.02.  
Section 12.03.  
Section 12.04.  
Section 12.05.  
Section 12.06.  
Section 12.07.  
Section 12.08.  
Section 12.09.

GEMH Manager  
Mortgage Services Manager; Functional Leaders  
Independent Contractors  
Subcontractors  
Additional Services; Books and Records; Mortgage Services Property  
Confidential Information  
Notices  
Taxes.  
Regulatory Approval and Compliance

Section 12.10.  
Section 12.11.  
Section 12.12.  
Section 12.13.  
Section 12.14.  
Section 12.15.  
Section 12.16.  
Section 12.17.  
Section 12.18.

Severability  
Entire Agreement  
Assignment; No Third-Party Beneficiaries  
Amendment  
Rules of Construction  
Counterparts  
No Right to Set-Off  
Existing Agreements  
Further Assurances

SCHEDULES AND EXHIBITS

Schedule A  
Schedule B  
Schedule C-1  
Schedule C-2  
Schedule D

GEMH Services  
Scheduled Loans  
Fully Dedicated Transition Employees  
Partially Allocated Transition Employees  
Cost Allocation

Exhibit A

Form of Loan Purchase Agreement

THIS MORTGAGE SERVICES AGREEMENT, dated as of \_\_\_\_\_, 2004, is made by and among GE MORTGAGE SERVICES, LLC, a North Carolina limited liability company ("Mortgage Services"), GENERAL ELECTRIC MORTGAGE HOLDINGS LLC, a North Carolina limited liability company ("GEMH"), GE MORTGAGE CONTRACT SERVICES INC., a Delaware corporation ("Contract Services") and GENWORTH FINANCIAL, INC., a Delaware corporation ("Genworth"), and together with Mortgage Services, GEMH and Contract Services, the "Parties").

RECITALS

WHEREAS, Affiliates of the Parties, General Electric Company ("General Electric"), General Electric Capital Corporation ("GE Capital"), GEI, Inc. ("GEI"), GE Financial Assurance Holdings, Inc. ("GEFAHI"), GNA Corporation ("GNA") and Genworth entered into that certain Master Agreement, dated as of \_\_\_\_\_, 2004 (the "Master Agreement");

WHEREAS, pursuant to the terms of the Master Agreement, General Electric, GE Capital, GEI, GNA, GEMH and Genworth entered into that certain Transitional Services Agreement dated as of \_\_\_\_\_, 2004;

WHEREAS, GE Capital Mortgage Services, Inc., a predecessor in interest to Mortgage Services, and General Electric Mortgage Insurance Corporation ("GEMICO") entered into that certain Service Agreement dated as of January 1, 2001 (the "Existing Servicing Agreement");

WHEREAS, Mortgage Services and GEMICO entered into that certain Shared Services Agreement dated as of January 1, 2002 (the "Existing Shared Services Agreement");

WHEREAS, Mortgage Services and GEMICO desire to terminate the Existing Servicing Agreement and the Existing Shared Services Agreement;

WHEREAS, pursuant to the terms of the Master Agreement, it is contemplated that GEMH will provide, or cause to provide, certain services to Mortgage Services and its Subsidiaries, including services previously provided by GEMICO and its Affiliates pursuant to the Existing Servicing Agreement and Existing Shared Services Agreement;

WHEREAS, Mortgage Services and GEMICO entered into that certain Lease Agreement (the "Lease Agreement"), effective as of October 1, 2002, with respect to approximately 1,100 square feet of office space located at 6601 Six Forks Road, Raleigh, North Carolina 27615 (the "Leased Premises");

WHEREAS, Mortgage Services and GEMICO desire to terminate the Lease Agreement and Mortgage Services desires to continue to use the Leased Premises on the terms set forth herein;

WHEREAS, GE Capital Residential Connection Corporation and Mortgage Services entered into that certain Indemnification Agreement dated as of May 1, 2003 (as assigned to Contract Services effective as of January 1, 2004, the "Indemnification Agreement");

---

WHEREAS, Mortgage Services and Contract Services desire to terminate the Indemnification Agreement and Mortgage Services desires for Contract Services to indemnify Mortgage Entities with respect to any and all Liabilities incurred by Mortgage Services with respect to the Scheduled Loans (as defined below);

WHEREAS, Contract Services has requested that, from time to time, Mortgage Services purchase certain New Loans and the related Loan Assets (as defined below) and Mortgage Services has agreed to (i) make such purchases on the terms and conditions set forth herein and (ii) account for such New Loans and related Loan Assets on its financial statements; and

WHEREAS, Mortgage Services desires that Genworth guarantee the obligations of Contract Services under this Agreement and Genworth has agreed to provide such guaranty;

NOW, THEREFORE, in consideration of the foregoing and the mutual agreements contained herein and for other good and valuable consideration, the receipt and adequacy of which are hereby acknowledged, the Parties hereby agree as follows:

## ARTICLE I

### DEFINITIONS

#### SECTION 1.01. Certain Defined Terms.

The following capitalized terms used in this Agreement shall have the meanings set forth below:

"Affiliate" means Affiliate as defined in the Master Agreement; provided however, that for the purposes of this Agreement the Closing Date as used in such definition shall be deemed to have occurred.

"Agreement" means this Mortgage Services Agreement, including all schedules and exhibits hereto, as amended, restated, supplemented or otherwise modified from time to time in accordance with the terms hereof.

"Bona Fide Offer" means, with respect to any Held Loan, a written offer made by any Person, other than Mortgage Services, Contract Services or any of their respective Affiliates, in good faith to purchase such Held Loan, coupled with evidence reasonably satisfactory to Contract Services that (i) the offeror has the present financial ability to pay the offered price or has available financing to enable it to pay the offered price and (ii) the offered price is consistent with the sale price Mortgage Services would seek to obtain for a loan of substantially similar type held by Mortgage Services for its own account.

"Credit Enhancement" means any (i) security deposit, (ii) investment certificate, certificate of deposit, authorization to hold funds, hypothecation of account or like instrument, (iii) letter of credit, repurchase agreement, agreement of indemnity, guarantee or postponement agreement, (iv) recourse agreement, (v) security agreement, (vi) all property and assets of whatever nature, including personal property, whether tangible or intangible, and claims, rights

2

---

and choses in action, (vii) certificate representing shares or the right to purchase capital of or interests in, any Person, or (viii) bond or debenture, or (ix) any and all insurance policies (including mortgage and title insurance), in each case pledged, assigned, mortgaged, made, delivered or transferred as security for the performance of any obligation under or with respect to any Loan by an obligor thereunder.

"Deficiency Amount" means, with respect to any Loan, in the event that the amount set forth in clause (ii) below is less than the amount set forth in clause (i) below, an amount that equals the absolute value of the difference between (i) the amount paid by Mortgage Services as purchase price with respect to such Loan minus the amount of all payments of principal received by Mortgage Services with respect to such Loan and (ii) the Disposition Purchase Price.

"Disposition Purchase Price" means, with respect to any Loan, the amount of proceeds (with respect to principal payable under such Loan) received by Mortgage Services from the disposition of such Loan and the related Loan REO (including pursuant to Sections 6.06 and 6.07) after the date hereof.

"Employee Matters Agreement" means that certain Employee Matters Agreement dated as of the date of the Master Agreement by and among General Electric, GEFAHI, GEI and Genworth.

"Employment Costs" means costs and expenses described in Section 4.02(b)(i) and 4.02(d)(i).

"Environmental Law" means any domestic or foreign, federal, state or local statute, rule, regulation or ordinance pertaining to the protection of human health and safety or the environment, including but not limited to the Comprehensive Environmental Response, Compensation, and Liability Act ("CERCLA") (42 U.S.C. § 9601 *et seq.*), the Hazardous Material Transportation Act (49 U.S.C. § 1801 *et seq.*), the Federal Water Pollution Control Act (33 U.S.C. § 1251 *et seq.*), the Resource Conservation and Recovery Act (42 U.S.C. § 6901 *et seq.*), the Clean Air Act (42 U.S.C. § 7401 *et seq.*), the Toxic Substances Control Act (15 U.S.C. § 2601 *et seq.*) and the Occupational Safety and Health Act (29 U.S.C. § 651 *et seq.*), all as now or hereafter amended or supplemented, and the regulations promulgated pursuant thereto, and judicial interpretations thereof, as well as common law rights of action under theories of nuisance, trespass and strict liability.

"Fair Market Value" means, with respect to any Loan, the fair market value of such Loan determined, by Contract Services, on the basis that such Loan is sold on an arm's length basis between a willing seller and a willing buyer.

"Finance Laws" means the U.S.A. Patriot Act, the Truth in Lending Act, Laws prohibiting deceptive, misleading and unfair acts and practices, the Gramm-Leach-Bliley Act, the Real Estate Settlement Procedures Act, the Home Mortgage Disclosure Act, the Consumer Credit Protection Act, the Right to Financial Privacy Act, the Equal Credit Opportunity Act, the Fair Credit Reporting Act, the Homeowners Ownership and Equity Protection Act, the Federal

3

Trade Commission Act, the Fair Debt Collection Practices Act and other state or federal Laws regulating lending and all rules and regulations promulgated pursuant to any of the foregoing.

“GEMH Parties” means, collectively, GEMH, Contract Services and Genworth.

“GE Services” means any and all services provided by General Electric and its Affiliates to Mortgage Entities prior to the date hereof through the corporate functions of General Electric, including tax, treasury, capital markets, legal, finance and information technology services but excluding any services provided by GEMH or its Affiliates to Mortgage Entities at any time prior to the date hereof after General Electric has terminated the provision of such services to Mortgage Entities.

“Held Loan” means any Loan that has not been sold, transferred or assigned by Mortgage Services to any Person (other than another Mortgage Entity).

“Information Systems” means computing telecommunications or other digital operating or processing systems or environments, including, without limitation, computer programs, data, databases, computers, computer libraries, communications equipment, networks and systems. When referenced in connection with GEMH Services, Information Systems shall mean the Information Systems accessed and/or used in connection with the GEMH Services.

“Intellectual Property” means all of the following, whether protected, created or arising under the laws of the United States or any other foreign jurisdiction: (i) patents, patent applications and statutory invention registrations, including divisions, continuations, continuations-in-part, substitute application of the foregoing and any extensions, reissues, restorations and reexaminations thereof, and all rights therein provided by international treaties or conventions, (ii) copyrights and mask work rights, whether or not registered, published or unpublished, and registrations and applications for registration thereof, and all rights therein whether provided by international treaties or conventions or otherwise, (iii) trademarks, service marks, trade dress, logos and other identifiers of source, including all goodwill associated therewith and all common law rights, registrations and applications for registration thereof, and all rights therein provided by international treaties or conventions, and all reissues, extensions and renewals of any of the foregoing, (iv) intellectual property rights arising from or in respect of domain names, domain name registrations and reservations, (v) trade secrets, (vi) intellectual property rights arising from or in respect of Technology, and (vii) all other applications and registrations related to any of the intellectual property rights set forth in the foregoing clauses (i) – (vi) above.

“Lender” means with respect to a Loan, a lender under such Loan.

“Liens” means any title defect, conflicting or adverse claim of ownership, mortgage, security interest, lien, pledge, claim, right of first refusal, option, charge, covenant, restriction, reservation, lease, order, decree, judgment, stipulation, settlement, attachment, restriction, objection or any other encumbrance of any nature whatsoever, whether or not perfected.

“Loans” means, collectively, Scheduled Loans and New Loans.

4

---

“Loan Agreement” means with respect to any Loan, any agreement or instrument evidencing the obligations of an obligor with respect to such Loan, including any loan agreement or note, and all amendments, addenda, riders and modifications thereto and thereof.

“Loan Assets” means with respect to any Loan, (i) any agreement or instrument evidencing the obligation of an obligor with respect to such Loan, including any loan agreement, note or other evidence of indebtedness of an obligor, any and all amendments, addenda, riders and modifications thereto and thereof and any and all documents executed in connection therewith (including (A) any and all mortgages, deeds of trust and other instruments or agreements including any and all amendments, addenda, riders, modifications thereto and thereof, in each case of this clause (i)(A) securing the obligations of the obligor under such Loan, and (B) any and all assignments of the instruments and agreements set forth in clause (i)(A) above, notices of transfer and equivalent instruments), (ii) any and all Credit Enhancements related to such Loan, (iii) any and all rights, interest and title of the applicable Lender with respect to such Loan including any and all rights to service such Loan and any and all other rights, benefits and proceeds arising from or in connection with such Loan, and (iv) any and all correspondence and documents of Contract Services and its Affiliates to the extent related to such Loan and other books and records, documents and agreements related to such Loan that the applicable Lender and Mortgage Services agree, pursuant to the applicable Loan Purchase Agreement, are to be sold, transferred and assigned to Mortgage Services pursuant to such Loan Purchase Agreement.

“Loan Closing” means the consummation of the sale and purchase transactions contemplated by Sections 6.03(a)(i), 6.04 and 6.05.

“Loan Closing Date” means the date on which the applicable Loan Closing occurs.

“Loan File” means, with respect to any Loan, any agreements, instruments, documents and correspondence described in clauses (i), (ii) and (iv) of the definition of the Loan Assets.

“Loan Purchase Agreement” means (i) with respect to any New Loan, an industry standard purchase and sale agreement between Mortgage Services and the applicable Lender substantially in the form of Exhibit A and otherwise in form and substance reasonably satisfactory to Mortgage Services and (ii) with respect to any Scheduled Loan, a purchase and sale agreement entered into by Mortgage Services and the applicable Lender with respect to the sale by such Lender and the purchase by Mortgage Services of such Scheduled Loan.

“Loan Purchase Price” means, with respect to a New Loan, the purchase price agreed upon by Mortgage Services and the applicable Lender.

“Loan REO” means any Mortgaged Property that Mortgage Services has acquired as a result of a foreclosure in connection with the applicable Loan.

“Loan Schedule” means a written schedule delivered from time to time by Contract Services to Mortgage Services setting forth all of the New Loans which Contract Services wishes to present to Mortgage Services for purchase pursuant to the terms of this

5

---

Agreement on a Loan Closing Date, which schedule sets forth the following information for each Loan: name of obligor, name of Lender, account number and the outstanding principal balance as of the most recent reporting period.

“Mortgage Entities” means Mortgage Services and its Subsidiaries.

“Mortgaged Property” means any real property that secures the obligations of the obligor under a Loan.

“Mortgage Servicing Rights” means assets designated as Mortgage Servicing Rights on the books and records of Mortgage Entities.

“MS Services” means the services provided by Mortgage Services pursuant to Section 2.03.



“MS Servicing Costs” means costs and expenses incurred by Mortgage Services in the ordinary course of business in connection with the management and servicing of the Held Loans pursuant to Section 2.03, (i) including fees and other costs payable by Mortgage Services pursuant to the Wells Fargo Agreement or any other similar subservicing agreement in connection with such Held Loans but (ii) excluding in all events any out-of-pocket costs and expenses (other than the Loan Purchase Price and the purchase price paid by Mortgage Services with respect to Scheduled Loans and any and all interest expenses incurred by Mortgage Services in connection with the funding of any Loan) incurred by Mortgage Services in connection with the acquisition or disposition of any Loan (including any loan boarding costs payable by Mortgage Services pursuant to the Wells Fargo Agreement or any other subservicing agreement, attorney costs and expenses, custodian fees, recording and filing fees and other costs and expenses customarily incurred in connection with an acquisition or disposition of residential mortgage loans).

“Net Amount” means, as of any date, an amount equal to the difference between (i) the sum of: (A) the aggregate Loan Purchase Price of the applicable Purchased Loans, (B) the aggregate purchase price paid by Mortgage Services with respect to the Scheduled Loans held by Mortgage Services as of such date and (C) the aggregate purchase price paid by Mortgage Services with respect to the REOs held by Mortgage Services as of such date minus (ii) the aggregate amount of principal payments received by Mortgage Services as of such date with respect to the Loans set forth in clauses (i)(A) and (i)(B).

“New Loan” means any one- to four-family residential mortgage loan that has been underwritten by an Affiliate of GEMH. For the avoidance of doubt, “New Loan” shall exclude any and all Scheduled Loans.

“Permitted Lien” means (i) any Lien for taxes not yet due and payable, (ii) any mechanic’s or materialmen’s lien, which an obligor under a Loan is required to remove and (iii) any other Lien on the obligor’s interest in any Mortgaged Property which is specifically permitted in accordance with the terms of the related Loan Agreement or other documents, agreements or instruments that constitute Loan Assets and which does not materially affect the value of the Mortgaged Property subject to such Lien.

6

“Purchased Loan” means any New Loan purchased by Mortgage Services as required by this Agreement that has not been sold, transferred or assigned by Mortgage Services to GEMH or any other Person (other than another Mortgage Entity).

“Representative(s)” of a Person means any director, officer, employee, agent, consultant, accountant, auditor, financing source, attorney, investment banker or other representative of such Person.

“REO Agreement” means that certain Agreement for the Purchase and Sale of Property, dated as of October 3, 1994, among GE Capital Asset Management Corporation (“GECAMC”), GEMICO, GE Residential Mortgage Insurance Corporation of North Carolina, General Electric Mortgage Corporation of North Carolina and Verex Assurance, Inc., as assigned by GECAMC to Mortgage Services pursuant to that certain Assignment, Assumption and Recognition Agreement dated as of May 1, 1995 and as modified by that certain Corrective – Restated Amendment to the Purchase and Sale of Property dated as of September 11, 1998.

“REO” means any Property (as defined in the REO Agreement) purchased by Mortgage Services pursuant to the REO Agreement.

“Scheduled Loans” means loans set forth on Schedule B.

“Service Termination Date” shall have the meaning specified in Schedule A hereto, in respect of any GEMH Service, or such earlier date as provided hereunder.

“Software” means the object and source code versions of computer programs and any associated documentation therefore.

“Technology” means, collectively, all designs, formulas, algorithms, procedures, techniques, ideas, know-how, software, programs, models, routines, confidential and proprietary information, databases, tools, inventions, invention disclosures, creations, improvements, works of authorship, and all recordings, graphs, drawings, reports, analyses, other writings, and any other embodiment of the above, in any form, whether or not specifically listed herein.

“Transition Employees” means, collectively, the Fully Dedicated Transition Employees and Partially Allocated Transition Employees.

“Underwriting/Insurance Agreement” means an agreement or an insurance policy entered into between an Affiliate of GEMH and a Lender pursuant to which such Affiliate of GEMH has an option to purchase a Loan from the Lender upon occurrence of certain events specified in such agreement or insurance policy.

“Virus” shall mean any computer instructions (i) that adversely affect the operation, security or integrity of a computing telecommunications or other digital operating or processing system or environment, including without limitation, other programs, data, databases, computer libraries and computer and communications equipment, by altering, destroying, disrupting or inhibiting such operation, security or integrity; (ii) that without functional purpose, self-replicate without manual intervention; and/or (iii) that purport to perform a useful function

7

but which actually perform either a destructive or harmful function, or perform no useful function and utilize substantial computer, telecommunications or memory resources.

“WARN Act” means the Workers Adjustment and Retraining Notification Act and any state and local “plant closing” or “mass layoff” law.

“Wells Fargo” means Wells Fargo Home Mortgage, Inc.

“Wells Fargo Agreement” shall mean that certain Subservicing Agreement, dated September 30, 2000, by and between Wells Fargo and GE Capital Mortgage Services, Inc., presently known as Mortgage Services, as such Subservicing Agreement may be amended, restated and otherwise modified from time to time in accordance with the terms thereof.

“Wells Fargo Proceeds” means, with respect to any Liability, any proceeds payable by Wells Fargo to Mortgage Services pursuant to Section 7.2 of the Wells Fargo Agreement with respect to such Liability.

SECTION 1.02. Other Terms. For purposes of this Agreement, the following terms have the meanings set forth in the sections or agreements indicated.

<u>Term</u>	<u>Section</u>
Affiliate	Master Agreement
Bona Fide Purchase Price	Section 6.06
Breaching Party	Section 10.01(a)
Business Day	Master Agreement
Claims	Section 6.03(a)(ii)
Closing	Master Agreement

Closing Date	Master Agreement
Facilities Fee	Section 4.01(b)
Force Majeure	Master Agreement
Fully Dedicated Transition Employee	Section 2.02
GE	Recitals
GE Capital	Recitals
GE Confidential Information	Master Agreement
GEFAHI	Recitals
GEI	Recitals
GEMH Indemnified Party	Section 8.01(a)
GEMH Manager	Section 12.01
GEMH Services	Section 2.01(a)
GEMH Substitute Service	Section 2.01(a)
General Electric	Recitals
Genworth	Preamble
Genworth Confidential Information	Master Agreement
Governmental Approval	Master Agreement
Guaranteed Obligations	Section 11.01
Guaranty	Section 11.01
Indemnification Agreement	Recitals
Indemnified Party	Master Agreement

<u>Term</u>	<u>Section</u>
Indemnifying Party	Master Agreement
Indemnity Payment	Master Agreement
Identified Costs	Section 4.01(b)
Law	Master Agreement
Leased Premises	Recitals
Liabilities	Master Agreement
Loan Closing Documents	Section 6.05(b)
Master Agreement	Recitals
Mortgage Services Indemnified Party	Section 8.01(b)
Mortgage Services Manager	Section 12.02
MS Standard	Section 5.01(b)
Non-Breaching Party	Section 10.01(a)
Operating Plan	Schedule A
Partially Allocated Transition Employee	Section 2.02
Parties	Preamble
Person	Master Agreement
Service Charges	Section 4.01(b)
Standard for Services	Section 5.01(a)
Subsidiary	Master Agreement
Tax Returns	Master Agreement
Term	Section 10.01(a)
Transactions	Master Agreement
Trigger Date	Master Agreement

## ARTICLE II

### SERVICES AND TERMS

#### SECTION 2.01. GEMH Services; Scope

(a) During the period commencing on the date hereof and ending on the relevant Service Termination Date, subject to the terms and conditions set forth in this Agreement, GEMH shall provide or cause to be provided to Mortgage Entities all services provided to any and all Mortgage Entities by GEMH and/or its Affiliates prior to the date hereof, including the services listed in Schedule A hereto (the “GEMH Service(s)”). The “GEMH Services” also shall include (1) any services to be provided or cause to be provided by GEMH to Mortgage Entities as agreed pursuant to Sections 2.02, 2.04, 3.02 and 12.05(a) and (2) any GEMH Substitute Service; provided, however, that (i) except as set forth in Section 2.04(b), the scope of each GEMH Service shall be substantially the same as the scope of such service provided by GEMH and its Affiliates to Mortgage Services, the predecessor of Mortgage Services or any other Mortgage Entity, as applicable, on the last day prior to the date hereof and that such service was provided by GEMH and its Affiliates to Mortgage Services, the predecessor of Mortgage Services or any other Mortgage Entity, as applicable, in the ordinary course, (ii) the use of each GEMH Service by Mortgage Entities shall include use of such GEMH Service contractors by Mortgage Services and/or of any other Mortgage Entity in substantially

the same manner as used by the contractors of Mortgage Services, predecessor of Mortgage Services and other Mortgage Entities, as applicable, prior to the date hereof (including use by Wells Fargo pursuant to the Wells Fargo Agreement). The preceding sentence shall not be deemed to restrict or otherwise limit the volume or quantity of the GEMH Services. If, for any reason, GEMH is unable to provide, or cause to be provided, any GEMH Service to any Mortgage Entity pursuant to the terms of this Agreement, GEMH shall provide or cause to be provided to Mortgage Entities a substantially equivalent service (a “GEMH Substitute Service”) at or below the cost for the substituted GEMH Service and otherwise in accordance with the terms of this Agreement, including, the Standard for Services.

(b) The GEMH Services shall include such maintenance, support, error correction, training, updates and enhancements normally and customarily provided by GEMH to its Subsidiaries that receive such services. If Mortgage Services requests that GEMH provide a custom modification in connection with any GEMH Service, Mortgage Services shall be responsible for the cost of such custom modification, and to the extent such custom modification constitutes Software, and such Software and all Intellectual Property therein is owned by Mortgage Services, GEMH hereby assigns such Software and all Intellectual Property therein to Mortgage Services and Mortgage Services hereby grants GEMH a perpetual, worldwide, fully paid up, irrevocable, transferable, royalty-free, non-exclusive license, with the right to sublicense, to use and modify such Software. The GEMH Services shall include all functions, responsibilities, activities and tasks, and the materials, documentation, resources, rights and licenses to be used, granted or provided by GEMH that are not specifically described in this Agreement as a part of the GEMH Services, but are incidental to, and would

normally be considered an inherent part of, or necessary subpart included within, the GEMH Services or are otherwise necessary for GEMH to provide, or Mortgage Entities to receive, the GEMH Services.

(c) For the avoidance of doubt, GEMH shall have no liability for any variance between the actual results of operations of Mortgage Services and the estimated results of operations set forth in the Operating Plan, unless and to the extent such variance is due to the gross negligence or willful misconduct of GEMH.

(d) Notwithstanding any provision to the contrary in this Agreement, GEMH shall not be obligated to provide any of the GE Services.

(e) During the Term, GEMH and Mortgage Services shall cooperate with one another and use their good faith, commercially reasonable efforts to effect the efficient, timely and seamless provision and receipt of GEMH Services.

SECTION 2.02. Transition Employees Services. GEMH agrees that during the Term it shall provide, or cause to be provided, to Mortgage Entities the services of (a) employees of Affiliates of GEMH set forth on Schedule C-1, or any employees with equivalent or greater skills who replace such employees in the positions set forth on Schedule C-1, in each case on a full-time basis (each such employee who performs GEMH Services on a full-time basis, a "Fully Dedicated Transition Employee") and (b) employees of Affiliates of GEMH set forth on Schedule C-2, or any employees with equivalent or greater skills who replace such employees in the positions set forth on Schedule C-2, in each case on a part-time basis as set

10

---

forth on Schedule C-2 (each such employee who performs GEMH Services on a part-time basis as set forth on Schedule C-2, a "Partially Allocated Employee").

SECTION 2.03. Management of Held Loans.

(a) During the Term, Mortgage Services shall manage and service the Held Loans in accordance with the MS Standard. For the avoidance of doubt, such management and servicing shall include restructuring, modification and disposition of the Held Loans and the related Loan Assets as well as other loss mitigation activities, such as foreclosure on the Mortgaged Property that secures the Held Loans, in each case in accordance with the MS Standard. In managing and servicing the Held Loans, Mortgage Services shall utilize the Wells Fargo Agreement, to the extent permitted by the terms thereof, or a substantially similar subservicing agreement.

(b) Mortgage Services shall maintain all licenses and other authorizations, in each case issued by a Governmental Authority, necessary to manage the Held Loans (including its status as an approved Fannie Mae/Freddie Mac seller/servicer).

SECTION 2.04. Reporting; Transition; MSR Sale.

(a) During the Term, GEMH shall provide, or cause to be provided, the following support, which support shall be in addition to the GEMH Services described in Schedule A:

(i) GEMH shall provide, or cause to be provided, current and reasonably available historical data related to the GEMH Services and predecessor services thereto as reasonably required by Mortgage Services in a manner and within a time period as mutually agreed upon by the parties; and

(ii) GEMH shall make reasonably available to Mortgage Entities the employees and contractors of GEMH and its Affiliates whose assistance, expertise or presence is necessary to (A) assist the transition team of Mortgage Services in establishing a fully functioning stand-alone environment and the timely assumption by Mortgage Services, or by a supplier to Mortgage Services, of the GEMH Services and (B) facilitate the implementation of the Operating Plan.

(b) During the Term, upon request by Mortgage Services, GEMH shall provide, or cause to be provided, assistance, expertise or presence necessary to assist Mortgage Services in the sale of Mortgage Servicing Rights, which assistance, expertise or presence shall be in addition to GEMH Services described in Schedule A; provided, however, that such services shall be provided to the extent that provision of such services shall not impose undue burden on the operations of GEMH and its Affiliates. Mortgage Services shall pay for all incremental direct costs and expenses incurred by GEMH and its Affiliates in connection with the provision of such services, which costs and expenses would not have been otherwise incurred as a result of the provision by GEMH and its Affiliates of other GEMH Services; provided that such costs and expenses have been authorized in writing in advance by the Mortgage Services Manager (or another authorized representative of Mortgage Services or its Affiliates). Notwithstanding the foregoing, GEMH shall have no obligation to provide the above mentioned services to the extent

11

---

that Mortgage Services fails to authorize costs and expenses necessary for GEMH and its Affiliates to incur in order to provide such services. Notwithstanding the foregoing, this Section 2.04(b) shall not be applicable to the sale of any servicing rights pursuant to Section 6.07.

SECTION 2.05. Performance and Receipt of Services.

(a) Security. Each of Mortgage Services and GEMH shall at all times comply with its own then in-force security guidelines and policies applicable to the performance, access and/or use of the GEMH Services and Information Systems.

(b) No Viruses. Each of Mortgage Services and GEMH shall take commercially reasonable measures to ensure that no Viruses or similar items are coded or introduced into the GEMH Services or the Information Systems of Mortgage Services, GEMH or any of their respective Affiliates. If a Virus is found to have been introduced into the GEMH Services or any Information Systems of any Party or its Affiliates, Mortgage Services and GEMH shall use their commercially reasonable efforts to cooperate and to diligently work together to eliminate the effects of such Virus.

(c) Reasonable Care. Each of Mortgage Services and GEMH shall exercise reasonable care in providing and receiving the GEMH Services and the MS Services to (i) prevent access to the Information Systems by unauthorized Persons and (ii) not damage, disrupt or interrupt the GEMH Services, the MS Services or Information Systems of any Party.

ARTICLE III

OTHER ARRANGEMENTS

SECTION 3.01. Computer-Based Resources.

(a) Prior to the Trigger Date, Mortgage Entities shall continue to have access to the Information Systems of GEMH and its Subsidiaries. On and after the Trigger Date, Mortgage Entities shall not have any right to access all or any part of the Information Systems of GEMH or any of its Subsidiaries, except to the extent necessary for any Mortgage Entity to receive the GEMH Services or implement the Operating Plan (in addition and not in limitation of Section 2.05, subject to Mortgage Services complying with all reasonable security measures implemented by GEMH as deemed necessary by GEMH to protect its Information Systems and the Information Systems of its Subsidiaries, provided, that Mortgage Entities have had a commercially reasonable period of time to comply with such security measures).

(b) Prior to the Trigger Date, GEMH and its Subsidiaries shall continue to have access to the Information Systems of the Mortgage Entities. On and after the Trigger Date neither GEMH nor its Subsidiaries shall have any right to access all or any part of the Information Systems of Mortgage Entities, except to the extent necessary for GEMH and its Subsidiaries to perform the GEMH Services (in addition and not in limitation of Section 2.05, subject to GEMH and its Subsidiaries complying with all reasonable security measures implemented by the applicable Mortgage Entity as deemed necessary by Mortgage Entities to protect their respective Information Systems; provided, that GEMH and its Subsidiaries have had a commercially reasonable period of time to comply with such security measures).

12

(c) In addition but not in limitation of Section 12.06, notwithstanding the foregoing, Mortgage Services and GEMH acknowledge and agree that any information received by Mortgage Services, GEMH or any of their respective Subsidiaries through the access by such Party or by any of its Subsidiaries shall not be used by such Party and such Party shall cause its Subsidiaries not to use such information, for purposes other than provisions of GEMH Services hereunder, in case of GEMH and its Subsidiaries, and receipt of the GEMH Services and provision of MS Services, in case of Mortgage Entities.

SECTION 3.02. Access; Leased Premises.

(a) Mortgage Services will allow GEMH and its Representatives reasonable access to the facilities of Mortgage Services necessary for the performance by GEMH and its Representatives of the GEMH Services and for GEMH to fulfill its obligations under this Agreement.

(b) GEMH will allow Mortgage Services and its Representatives reasonable access to the facilities of GEMH necessary for Mortgage Services to fulfill its obligations under this Agreement, to implement the Operating Plan and to transition GEMH Services to Mortgage Entities or to a supplier designated by Mortgage Services.

(c) During the Term, GEMH shall allow, and shall cause to allow, Mortgage Entities and its Representatives to access and use the Leased Premises or equivalent premises, reasonably acceptable to Mortgage Services, in the same manner as such Leased Premises were used by Representatives of Mortgage Entities prior to the date hereof.

ARTICLE IV

COSTS AND DISBURSEMENTS; PERSONNEL COSTS; PAYMENTS

SECTION 4.01. Costs and Disbursements.

(a) Subject to Section 4.02, all ordinary costs and expenses incurred by Mortgage Services in connection with performance of its obligations under this Agreement (including personnel costs and expenses with respect to Mortgage Services' employees, any amounts payable directly or indirectly by Mortgage Services to General Electric or its Affiliates with respect to GE Services and the MS Servicing Costs) shall be payable by Mortgage Services and GEMH shall have no Liability to Mortgage Services with respect to such costs and expenses.

(b) Mortgage Services shall reimburse GEMH for:

(i) all reasonable costs and expenses incurred by GEMH in connection with GEMH Services actually provided pursuant to this Agreement and that can be identified as incurred for the sole benefit of Mortgage Entities or allocated by GEMH to Mortgage Entities consistent with the basis on which such costs were allocated by GEMH and its Affiliates immediately prior to the date hereof as reflected on Schedule D ("Identified Costs"); provided, however, that (A) any out-of-pocket costs and expenses in the aggregate in excess of \$10,000 per any calendar month or in excess of \$5,000 per provider per any calendar month shall only be payable by Mortgage Services, if such Identified Costs have been authorized in writing

13

by the Mortgage Services Manager (or another authorized representative of Mortgage Services or its Affiliates) prior to having been incurred by GEMH, (B) Mortgage Services receives from GEMH reasonably detailed data and other documentation sufficient to support the calculation of amounts due to GEMH as a result of Identified Costs and (C) Identified Costs shall not include (x) any costs or expenses described in Section 4.02, which shall be payable pursuant to Section 4.02, (y) any costs or expenses incurred by GEMH or any of its Subsidiaries in connection with providing Mortgage Entities access and use of facilities described in Section 3.02 and (z) any costs or expenses incurred by GEMH or any of its Subsidiaries in connection with providing GEMH Services set forth in paragraph (j) of Schedule A; and

(ii) \$10,000 per annum (payable in quarterly installments as set forth in Section 4.04) with respect to access and use by Mortgage Entities and their respective Representatives of facilities described in Section 3.02 and provision by GEMH and its Subsidiaries of GEMH Services set forth in paragraph (j) of Schedule A ("Facilities Fee", and together with Identified Costs, the "Service Charges").

SECTION 4.02. Personnel Costs; Right to Hire; Severance

(a) Mortgage Services shall pay all actual personnel costs and expenses incurred by Mortgage Services with respect to its employees providing services under this Agreement. All severance and employee costs, if any, related to the termination of any Mortgage Services employees (including any amounts payable pursuant to the WARN Act) will be paid entirely by Mortgage Services. Mortgage Services will be responsible for any and all costs and expenses associated with the transfer of Mortgage Services employees to any Mortgage Services' Affiliates, including for any wind down/shut down costs and expenses associated with a wind down or shut down of one or more of Mortgage Services' facilities.

(b) Subject to Article IX of the Employee Matters Agreement:

(i) During the Term, Mortgage Services will reimburse GEMH for all compensation and benefit costs and expenses incurred by GEMH and its Affiliates for all Fully Dedicated Transition Employees who are providing GEMH Services on full time basis. For the avoidance of doubt, at any one time, Mortgage Services shall not be liable for such costs and expenses for more than six (6) persons who hold positions set forth on Schedule C-1.

(ii) Mortgage Services will have the right to hire Fully Dedicated Transition Employees at the Trigger Date, provided that such Fully Dedicated Transition Employees continue to provide GEMH Services to the extent necessary through the expiration of this Agreement consistent with GEMH Services provided prior to the Trigger Date.

(iii) To the extent that Mortgage Services does not offer employment to such Fully Dedicated Transition Employees effective as of the Trigger Date, then GEMH and its Affiliates will retain such Fully Dedicated Transition Employees to continue to provide GEMH Services to Mortgage Services to the extent necessary through the earlier of the expiration or termination of this Agreement. GEMH will make a decision on or prior to the earlier of the expiration or termination of this Agreement as to whether GEMH or any of its Affiliates wants to

offer such Fully Dedicated Transition Employees continued employment with GEMH or any of its Affiliates.

(iv) If neither GEMH, Mortgage Services nor any of their respective Affiliates offers employment to such Fully Dedicated Transition Employees which is comparable to the terms of their employment immediately prior to the end of the Term, Mortgage Services will reimburse GEMH for all severance and employee costs, if any, related to the termination of such Fully Dedicated Transition Employees. For the avoidance of doubt, Mortgage Services shall not be liable for such costs and expenses for more than six (6) persons who hold positions set forth on Schedule C-1. If such comparable employment is offered by either GEMH, Mortgage Services or any of their respective Affiliates and is declined by such employees, the employee would not be entitled to any severance benefits. For purposes of this Section 4.02(b), "comparable" shall be as defined in the applicable employee benefit plan of GEMH with respect to severance benefits.

(c) Neither GEMH nor any of its Affiliates shall terminate employment of any Transition Employee who is 60% or more allocated to Mortgage Entities or provision of GEMH Services without prior written consent of Mortgage Services.

(d) (i) During the Term, Mortgage Services will reimburse GEMH for (A) the pro-rata portion of compensation and benefit costs and expenses incurred by GEMH and its Affiliates for the Partially Allocated Transition Employees who are less than 100% allocated to Mortgage Services based on actual hours worked by such Partially Allocated Transition Employees providing GEMH Services and (B) an amount of \$500,000 per annum with respect to management oversight of employees of GEMH's Affiliates providing GEMH Services hereunder, allocated on pro-rata basis based on the number of calendar days GEMH Services were actually provided.

(ii) At the earlier of the expiration or termination of this Agreement, Mortgage Services will pay to GEMH an amount of \$641,700 and Mortgage Services shall not be responsible for any severance costs with respect to any Partially Allocated Transition Employee.

(e) During the Term, Mortgage Services shall be responsible for all costs and expenses incurred by GEMH, Mortgage Services and their respective Affiliates in connection with any retention program instituted with respect to any Transition Employee; provided that any such retention program has been authorized in writing by the Mortgage Services Manager (or another authorized representative of Mortgage Services or its Affiliates).

SECTION 4.03. Loan Acquisition and Disposition Costs. Subject to receipt by Contract Services of reasonably detailed data and other documentation sufficient to support the calculation of amounts due to Mortgage Services, Contract Services shall promptly upon receipt of an invoice from Mortgage Services (but in no event later than within seventy-five (75) days of the date of such invoice) reimburse Mortgage Services for all out-of-pocket costs and expenses incurred by Mortgage Services in connection with an acquisition of any Loan and/or a disposition of any Loan by Mortgage Services. For the avoidance of doubt, such out-of-pocket costs and expenses (i) shall not include the Loan Purchase Price, any purchase price paid by

Mortgage Services with respect to any Scheduled Loan, any interest expense incurred by Mortgage Services in connection with the funding of Loans or any MS Servicing Costs but (ii) shall include loan boarding fees payable by Mortgage Services pursuant to the Wells Fargo Agreement or any other subservicing agreement pursuant to which such Loan is serviced, attorneys' fees and expenses, custodian fees, recording and filing fees and other fees and expenses customarily incurred in connection with an acquisition or disposition of residential mortgage loans. If Contract Services fails to pay any amount payable pursuant to this Section 4.03 (excluding any amount contested in good faith) by the date specified above, Contract Services shall be obligated to pay to Mortgage Services, in addition to the amount due, interest on such amount at the lesser of (i) the three (3) month London Interbank Offered Rate (LIBOR) plus 100 basis points or (ii) the maximum rate of interest allowed by applicable Law, from the date the payment was due through the date of payment. Any and all disputes with respect to this Section 4.03 shall be resolved pursuant to Section 9.02.

SECTION 4.04. Payments of Service Charges and Employment Costs.

(a) Subject to Section 4.04(iii):

(i) all Service Charges and Employment Costs shall be invoiced by GEMH on a quarterly basis in arrears.

(ii) Together with each invoice submitted to Mortgage Services for payment pursuant to this Section 4.04(a), GEMH shall provide Mortgage Services with reasonably detailed data and documentation sufficient to support the calculation of any amount due to GEMH under this Agreement for the purposes of verifying the accuracy of such calculations.

(iii) The parties acknowledge and agree that in the event GEMH does not provide, or cause to be provided, GEMH Services specified in Section 3.02 and paragraph (j) of Schedule A during the entire calendar quarter, the amount of the Facilities Fee payable with respect to such quarterly period shall be pro-rated such that Mortgage Services shall pay the portion of a quarterly payment that is allocable to the number of days in such calendar quarter during which such GEMH Services were actually provided.

(b) (i) Prior to the Trigger Date, Mortgage Services and GEMH shall arrange for the payment of all Service Charges and Employment Costs through the GE Internal Billing System ("IBS"). Mortgage Services shall have the right to dispute any Service Charges and Employment Costs settled through the IBS during any calendar quarter by delivering written notice of such dispute, setting forth in reasonable detail the basis therefor, to GEMH within, and no later than, 60 days after the end of such quarter. If the Parties do not promptly resolve such dispute, the dispute shall be resolved pursuant to Section 9.02.

(ii) From and after Trigger Date, Mortgage Services shall pay the amount of any invoice submitted to Mortgage Services by GEMH pursuant to Section 4.04(a) in U.S. dollars within seventy-five (75) days of the date of such invoice. If Mortgage Services fails to pay such amount (excluding any amount contested in good faith) by such date, Mortgage Services shall be obligated to pay to GEMH, in addition to the amount due, interest on such

amount at the lesser of (i) the three (3) month London Interbank Offered Rate (LIBOR) plus 100 basis points or (ii) the maximum rate of interest allowed by applicable Law, from the date the payment was due through the date of payment. If Mortgage Services disputes GEMH's calculation of any amount due to GEMH, then the dispute shall be resolved pursuant to Section 9.02.

ARTICLE V

STANDARDS; COMPLIANCE WITH LAWS

SECTION 5.01. Standards.

(a) GEMH agrees to perform, and cause to perform, the GEMH Services such that the nature, quality, standard of care and the service levels at which

such GEMH Services are performed are no less than the nature, quality, standard of care and service levels at which the substantially same services were performed by or on behalf of GEMH during the most recent service period prior to the date hereof in which such services were performed by or on behalf of GEMH in the ordinary course (the “Standard for Services”).

(b) Mortgage Services agrees to manage and service and, to cause to manage and service the Held Loans, such that the nature, quality, standard of care and service levels at which Mortgage Services manages and services such Held Loans are no less than the nature, quality, standard of care and service levels at which Mortgage Services manages and services other loans of similar type held by Mortgage Services for its own account (the “MS Standard”).

SECTION 5.02. Compliance with Laws. Each of GEMH and Mortgage Services shall comply, and shall cause to comply, with all applicable Laws (including all Finance Laws) when providing or receiving the GEMH Services, managing or servicing the Loans (in case of Mortgage Services) and when performing other obligations under this Agreement.

## ARTICLE VI

### PURCHASE OF NEW LOANS AND SALE OF LOANS AND LOAN ASSETS

SECTION 6.01. Loan Schedule. Contract Services shall, from time to time during the Term, provide to Mortgage Services a Loan Schedule setting forth all of the New Loans that Contract Services desires for Mortgage Services to purchase.

SECTION 6.02. Loan Purchase Agreement.

(a) On or prior to the date Contract Services delivers a Loan Schedule to Mortgage Services, Contract Services shall designate, or cause to be designated, Mortgage Services as a designee for the purchase of New Loans and related Loan Assets under the applicable Underwriting/Insurance Agreement.

(b) Mortgage Services shall use its commercially reasonable efforts to enter into a Loan Purchase Agreement. Contract Services shall use its commercially reasonable efforts to assist Mortgage Services in the negotiations of such Loan Purchase Agreement, pursuant to

17

---

which the Lender agrees to sell, transfer and assign to Mortgage Services the applicable New Loans and the related Loan Assets and Mortgage Services agrees to purchase and accept such Loans and the related Loan Assets on the terms and conditions set forth therein. The Loan Purchase Agreement shall include (i) representations and warranties, in form and substance reasonably satisfactory to Mortgage Services, to the effect that the applicable New Loan and related Loan Assets comply with and do not violate applicable Laws (including Finance Laws) and (ii) an obligation on the part of the applicable Lender to repurchase the applicable New Loan from Mortgage Services in the event that the Lender, inter alia, has breached the representation and warranty described in clause (i) above with respect to such New Loan and the related Loan Assets.

SECTION 6.03. Agreement to Sell and Purchase the New Loans; Assignment of Claims

(a) (i) Subject to the terms and provisions of this Agreement, Mortgage Services agrees to purchase and accept on a Loan Closing Date from a Lender, the New Loans and the related Loan Assets set forth on the applicable Loan Schedule and with respect to which the conditions set forth in Section 6.05 have been satisfied or waived by Mortgage Services in accordance therewith; provided that the applicable Lender sells, transfers and assigns to Mortgage Services such Loans and the related Loan Assets free and clear of all Liens.

(ii) Mortgage Services agrees that upon request of Contract Services on or prior to the applicable Loan Closing Date, Mortgage Services shall assign, on the Loan Closing Date, its rights and claims pursuant to the applicable Loan Agreement (the “Claims”), if any, against any Person other than any Mortgage Entity, Contract Services or any of their respective Affiliates, solely with respect to any event, occurrence or circumstance that gave rise to the exercise by Contract Services of its option to purchase the applicable Loan from the applicable Lender; provided, however, (A) for the avoidance of doubt, the Claims shall not include any rights, title or interest of any Person in any document, agreement, instrument or property that secures the obligations of the borrower or any guarantor with respect to the Loan or evidences such security; and (B) Mortgage Services shall not be required to assign any Claims, the assignment of which to Contract Services, in the reasonable judgment of Mortgage Services, would violate any applicable Law (including any Finance Law); (C) during the period that any such Loan is a Held Loan, (1) Contract Services shall comply with all applicable Laws (including Finance Laws) in enforcing or pursuing any of its Claims against the applicable Person, (2) in the event Mortgage Services determines that Contract Services actions or omissions, with respect to any Claim including enforcement and exercise thereof do not comply with or violate any applicable Law (including any Finance Law), upon notice from Mortgage Services, Contract Services shall cease and desist, or cause to cease and desist, such action or undertake such action as necessary to comply with applicable Law, (3) Contract Services shall not undertake any foreclosure action with respect to any borrower or guarantor under such Loan or Loan Assets; (4) Contract Services shall not enforce or pursue any of its Claims to any detriment of any Mortgage Entity or any of its Affiliates, and (5) such Claims shall not be transferred or assigned by Contract Services to any Person; and (D) in addition but not in limitation of Section 8.04, Contract Services shall indemnify, defend and hold harmless Mortgage Services Indemnified Parties from and against any and all Liabilities incurred or suffered by any Mortgage Services Indemnified Party relating to, arising out of, or resulting from

18

---

the assignment of the Claims to Contract Services and any action or omission of Contract Services or any of its Representatives, including in connection with enforcement and/or exercise of any such assigned Claims.

(iii) Contract Services acknowledges that Mortgage Services would be irreparably harmed by any breach of Section 6.03(a)(ii) and that there would be no adequate remedy at law or in damages to compensate Mortgage Services for any such breach. Contract Services agrees that Mortgage Services shall be entitled to seek injunctive relief requiring specific performance by Contract Services of its obligations under Section 6.03(a)(ii).

(b) Notwithstanding any provision of Section 6.03(a) to the contrary, Mortgage Services shall have no obligation pursuant to this Agreement to purchase:

(i) at a Loan Closing, any New Loan or any Loan Assets other than the New Loans set forth on the applicable Loan Schedule and the Loan Assets related to such New Loans, in all cases with respect to which the conditions set forth in Section 6.05 have been satisfied or waived by Mortgage Services in accordance therewith.

(ii) any New Loan or any related Loan Asset, which New Loan or Loan Asset in the reasonable judgment of Mortgage Services does not comply with or violates applicable Law (including any Finance Law);

(iii) any New Loan or any related Loan Asset if, after giving effect to such purchase, Mortgage Services would hold Held Loans and REOs with respect to which the Net Amount exceeds \$100,000,000;

(iv) any loan other than the New Loans; and

(v) any New Loan or any related Loan Assets in the event Mortgage Services and the applicable Lender are unable to enter into the Loan Purchase Agreement within 90 Business Days of receipt by Mortgage Services of the applicable Loan Schedule (or such other period as the parties thereto may mutually agree).

(c) Contract Services hereby acknowledges and agrees that any and all amounts payable by any Person (other than Mortgage Services) with respect to, in connection with or pursuant to the New Loans and the related Loan Assets acquired by Mortgage Services pursuant to this Agreement (other than amounts payable with respect to the Claims assigned to Contract Services pursuant to Section 6.03(a)(ii)) with respect to any period after the applicable Loan Closing and any and all disposition proceeds with respect to such New Loans and the related Loan Assets shall be the property of Mortgage Services.

(d) All amounts which are received by Contract Services or any of its Affiliates in respect of the New Loans and the related Loan Assets (other than with respect to any amounts received with respect to the Claims assigned to Contract Services pursuant to Section 6.03(a)(ii)) acquired pursuant to this Agreement from and after the applicable Loan Closing which are properly allocable to periods after the applicable Loan Closing shall be received by such Person as agent, in trust for and on behalf of Mortgage Services, and following the applicable Loan Closing, on a weekly basis, Contract Services shall transfer, or cause to be

---

19

transferred, by wire transfer of immediately available funds, and remit (or cause to be remitted) to Mortgage Services all such amounts received by or paid to Contract Services or any of its Affiliates as of such date and shall provide Mortgage Services information as to the nature and source of such payments, including any invoice related thereto.

SECTION 6.04. Loan Purchase Price. On the Loan Closing Date, Mortgage Services shall pay to the Lender the aggregate amount of the Loan Purchase Price set forth in the Loan Purchase Agreement with respect to the New Loans being purchased at such Loan Closing.

SECTION 6.05. Conditions Precedent. With respect to any Loan Closing, the obligations of Mortgage Services under Sections 6.03 and 6.04 shall be subject to the satisfaction or waiver in writing by Mortgage Services, on or prior to such Loan Closing of the following conditions:

(a) The obligations of Contract Services required to be performed by it at or prior to a Loan Closing pursuant to the terms of this Article VI shall have been duly performed and complied with and all representations and warranties of Contract Services under this Agreement and all representations and warranties of the Lender under the Loan Purchase Agreement shall be true and correct as of the applicable Loan Closing Date with the same force and effect as though such representations and warranties had been made as of such date.

(b) Mortgage Services shall have received, all of the following documents and instruments (the "Loan Closing Documents"), duly executed by all signatories other than Mortgage Services as required pursuant to the respective terms thereof:

- (i) Loan Schedule;
- (ii) Loan Purchase Agreement; and
- (iii) Loan File.

SECTION 6.06. Right of First Refusal. If at any time during the Term, Mortgage Services presents to Contract Services a Bona Fide Offer with respect to any Loan or Loan REO, Contract Services may, by written notice to Mortgage Services within five (5) Business Days of receipt of such Bona-Fide Offer, elect to purchase such Loan or Loan REO, as the case may be at the purchase price offered by the offeror of such Bona Fide Offer ("Bona Fide Purchase Price") and (a) upon receipt of the amount equal to the Bona Fide Purchase Price, Mortgage Services shall sell, transfer and assign to Contract Services or its designee (i) such Loan and the related Loan Assets or Loan REO, as the case may be, on "AS-IS, WHERE IS" basis without any representations or warranties (except for a representation and warranty that such Loans and the related Loan Assets or Loan REO, as applicable, are being sold, transferred and assigned free and clear of Liens that have been created by Mortgage Entities (other than the Permitted Liens)) and (ii) any and all rights of Mortgage Services under the applicable Loan Purchase Agreement to the extent such rights are assignable and (b) Contract Services or its designee shall (i) purchase and accept such Loans and the related Loan Assets or Loan REOs, as the case may be, and (ii) assume all Liabilities with respect to such Loans and related Loan Assets or Loan REOs, as the case may be arising from and after such sale, transfer and assignment.

---

20

SECTION 6.07. Repurchase of Loans. Upon expiration or early termination of this Agreement or of Article VI pursuant to Section 10.01, (a) subject to receipt of the payment set forth in clause (b)(iii) below, Mortgage Services shall sell, transfer and assign, or shall cause its Subsidiaries to sell, transfer and assign to Contract Services or its designee, (i) any and all Held Loans and the related Loan Assets and Loan REOs, on "AS-IS, WHERE IS" basis without any representations or warranties (except for a representation and warranty that such Loans, related Loan Assets and Loan REOs are being sold, transferred and assigned free and clear of Liens that have been created by Mortgage Entities other than the Permitted Liens)) and (ii) any and all rights of Mortgage Services under the applicable Loan Purchase Agreement to the extent such rights are assignable and (b) Contract Services or such designee shall (i) purchase and accept such Loans, related Loan Assets and Loan REOs, (ii) assume all Liabilities with respect to such Loans, the related Loan Assets and Loan REOs arising from and after such sale, transfer and assignment and (iii) pay Mortgage Services an amount equal to the Fair Market Value of such Held Loans and Loan REOs in immediately available funds to the account designated in writing by Mortgage Services at least two Business Days prior to such sale, transfer and assignment. For the avoidance of doubt, in connection with any sale, transfer or assignment of any Loan or Loan REOs, pursuant to this Section 6.07, Mortgage Services shall sell, transfer and assign any and all rights of Mortgage Services to service such Loans and Loan REOs.

SECTION 6.08. Transition Assistance. Upon request of Contract Services, Mortgage Services shall provide, or cause to be provided, reasonable assistance to Contract Services to transition the management and servicing of the Loans, the related Loan Assets and Loan REOs that are being purchased by Contract Services from Mortgage Services pursuant to Sections 6.06 and 6.07; provided, however, that the provision of such assistance shall not impose undue burden on the operations of Mortgage Entities. Contract Services shall pay for all out-of-pocket costs and expenses incurred by Mortgage Entities and its Affiliates as a result of the provision by Mortgage Entities and its Affiliates of such assistance; provided that such costs and expenses have been authorized in writing in advance by the GEMH Manager (or an authorized representative of Contract Services). Notwithstanding the foregoing, Mortgage Services shall have no obligation to provide, or cause to be provided, the above mentioned assistance to the extent that GEMH or an authorized representative of Contract Services fails to authorize such costs and expenses necessary for Mortgage Entities and its Affiliates to incur in order to provide such assistance.

SECTION 6.09. Further Assurances. In addition to the foregoing, Contract Services shall, and shall cause its Subsidiaries and designees to, whenever and as often as reasonably requested to do so by Mortgage Services, do, execute, acknowledge and deliver any and all such other and further acts, assignments, transfers and any instruments of further assurance, approvals and consents as are necessary or proper in order to complete, ensure and perfect the sale, transfer and assignment to Mortgage Services contemplated hereby of the applicable Loans and the related Loan Assets and the consummation of the other transactions contemplated hereby.

---

21

## ARTICLE VII

### REPRESENTATIONS AND WARRANTIES

SECTION 7.01. Representations and Warranties of Mortgage Services. Mortgage Services represents and warrants to GEMH Parties that (a) Mortgage Services has the full corporate power and authority required to enter into, execute, deliver, and fully perform under, this Agreement and that to do so will not violate or conflict with any material term or provisions of any agreement, instrument, order or decree to which it is a party or by which it is bound and (b) Mortgage Services has obtained all Governmental Approvals and consents from other Persons, if any, necessary for Mortgage Services to perform its obligations under this Agreement.

SECTION 7.02. Representation and Warranties of GEMH Parties. Each GEMH Party represents and warrants to Mortgage Services that (a) such GEMH Party has the full corporate power and authority required to enter into, execute, deliver, and fully perform under, this Agreement and that to do so will not violate or conflict with any material term or provisions of any agreement, instrument, order or decree to which it is a party or by which it is bound and (b) such GEMH Party and its Affiliates (as applicable) have obtained all Governmental Approvals and consents from other Persons, if any, necessary or required for such GEMH Party or its Affiliates to perform its obligations under this Agreement.

SECTION 7.03. Survival. The representations and warranties set forth in this Article VII shall survive for a period of eighteen (18) months after the date hereof.

## ARTICLE VIII

### INDEMNIFICATION; LIMITATION ON LIABILITY

#### SECTION 8.01. Limited Liability.

(a) Notwithstanding the provisions of Section 5.01, neither GEMH nor any of its Affiliates, any of their respective directors, officers or employees, nor any of the heirs, executors, successors nor assigns of any of the foregoing (each, a "GEMH Indemnified Party") shall have any liability in contract, tort or otherwise to any Mortgage Services Indemnified Party or its Representatives for or in connection with (i) any GEMH Services rendered or to be rendered by any GEMH Indemnified Party pursuant to this Agreement, (ii) the transactions contemplated by this Agreement or (iii) any GEMH Indemnified Party's actions or inactions in connection with any such GEMH Services or such transactions; provided, however, that such limitation on liability shall not extend to or otherwise limit any Liabilities that have resulted directly from such GEMH Indemnified Party's (A) gross negligence or willful misconduct, (B) improper use or disclosure of information of, or regarding, a customer or potential customer of a Mortgage Services Indemnified Party (defined below) or (C) violation of applicable Law. Notwithstanding the foregoing, this Section 8.01(a) shall not be applicable to any indemnification obligation of GEMH and Contract Services pursuant to Section 6.03(a)(ii) and Section 8.04 and any payment obligations of any GEMH Parties pursuant to this Agreement, including pursuant to Sections 4.03, 6.03(a)(ii), 6.06, 6.07, 6.08 and Article XI.

22

(b) Notwithstanding the provisions of Section 5.01, neither Mortgage Services nor any of its Affiliates, any of their respective directors, officers or employees, nor any of the heirs, executors, successors nor assigns of any of the foregoing (each, a "Mortgage Services Indemnified Party") shall have any liability in contract, tort or otherwise to any GEMH Indemnified Party or its Representatives for or in connection with (i) the MS Services, (ii) the transactions contemplated by this Agreement or (iii) any Mortgage Services Indemnified Party's actions or inactions in connection with any such MS Services or such transactions; provided, however, that such limitation on liability shall not extend to or otherwise limit any Liabilities that have resulted directly from such Mortgage Services Indemnified Party's (A) gross negligence or willful misconduct, (B) improper use or disclosure of information of, or regarding, a customer or potential customer of a GEMH Indemnified Party or (C) violation of applicable Law. Notwithstanding the foregoing, this Section 8.01(b) shall not be applicable to any payment obligations of Mortgage Services pursuant to this Agreement, including pursuant to Article IV.

#### SECTION 8.02. Indemnification by GEMH. In addition and not in limitation of Section 8.04:

(a) GEMH shall indemnify, defend and hold harmless each Mortgage Services Indemnified Party from and against any and all Liabilities incurred or suffered by any Mortgage Services Indemnified Party relating to, arising out of, or resulting from (i) the gross negligence or willful misconduct of a GEMH Indemnified Party in connection with the transactions contemplated by this Agreement or such GEMH Indemnified Party's provision of the GEMH Services, (ii) the improper use or disclosure of information of, or regarding, a customer or potential customer of a Mortgage Services Indemnified Party in connection with the transactions contemplated by this Agreement or such GEMH Indemnified Party's provision of the GEMH Services, or (iii) any violation of applicable Law by a GEMH Indemnified Party in connection with the transactions contemplated by this Agreement or such GEMH Indemnified Party's provision of the GEMH Services.

(b) GEMH shall indemnify, defend and hold harmless each Mortgage Services Indemnified Party from and against any and all Liabilities incurred or suffered by any Mortgage Services Indemnified Party relating to, arising out of, or resulting from the provision of the MS Services by Mortgage Services or any of its Subsidiaries, except for (A) any Liabilities that result from a Mortgage Services Indemnified Party's negligence in connection with the provision of the MS Services, (B) any Liabilities that result from a Mortgage Services Indemnified Party's breach of this Agreement or (C) any Liabilities for which Mortgage Services is required to indemnify a GEMH Indemnified Party pursuant to Section 8.03.

(c) Notwithstanding the foregoing, the aggregate liability of GEMH pursuant to this Section 8.02 shall in no event exceed the aggregate amount of \$10,000,000.

#### SECTION 8.03. Indemnification by Mortgage Services.

(a) Mortgage Services shall indemnify, defend and hold harmless each GEMH Indemnified Party from and against any and all Liabilities incurred or suffered by any GEMH Indemnified Party relating to, arising out of, or resulting from (i) the gross negligence or willful misconduct of a Mortgage Services Indemnified Party or any of its Representatives in

23

connection with the transactions contemplated by this Agreement or such Mortgage Indemnified Party's provision of the MS Services, (ii) the improper use or disclosure of information of, or regarding, a customer or potential customer of a GEMH Indemnified Party in connection with the transactions contemplated by this Agreement or such Mortgage Services Indemnified Party's provision of the MS Services, or (iii) any violation of applicable Law by a Mortgage Services Indemnified Party in connection with the transactions contemplated by this Agreement or such Mortgage Services Indemnified Party's provision of the MS Services.

(b) Mortgage Services shall indemnify, defend and hold harmless each GEMH Indemnified Party from and against any and all Liabilities incurred or suffered by any GEMH Indemnified Party relating to, arising out of, or resulting from the provision of the GEMH Services by GEMH or any of its Subsidiaries, except for (A) any Liabilities that result from a GEMH Indemnified Party's negligence in connection with the provision of the GEMH Services, (B) any Liabilities that result from a GEMH Indemnified Party's breach of this Agreement or (C) any Liabilities for which GEMH is required to indemnify a Mortgage Services Indemnified Party pursuant to Section



(c) Notwithstanding the foregoing, the aggregate liability of Mortgage Services pursuant to this Section 8.03 shall in no event exceed the aggregate amount of \$10,000,000.

**SECTION 8.04. Loans and Loan Assets Indemnification.**

(a) Notwithstanding any provision to the contrary in this Agreement (including Section 8.01), Contract Services shall indemnify, defend and hold harmless each Mortgage Services Indemnified Party from and against any and all Liabilities incurred or suffered by any Mortgage Services Indemnified Party relating to, arising out of, or resulting from or in connection with the Loans, the Loan Assets or any Mortgaged Property (including arising out of or resulting from any noncompliance or violation of Environmental Laws of any applicable Mortgaged Property) or any matters set forth in Section 4.03 and Article VI; provided, however, that GEMH shall not have any liability under this Section 8.04 with respect to Liabilities that have resulted directly from Mortgage Services Indemnified Party's (A) gross negligence or willful misconduct, (B) improper use or disclosure of information of, or regarding, a customer or potential customer of Mortgage Services Indemnified Party or (C) violation of applicable Law. For the avoidance of doubt, (i) Liabilities for which Contract Services shall indemnify, defend and hold harmless pursuant to this Section 8.04 shall include (x) any and all Liabilities resulting from the failure of Mortgage Services to receive any amounts (including interest and late fees) payable with respect to any Loan and/or Loan Asset pursuant to the applicable documents, agreements and instruments that constitute Loan Assets, including failure resulting from any breach of representation or warranty or covenant made by Contract Services in this Agreement and/or by the applicable Lender in the applicable Loan Purchase Agreement, (y) the Deficiency Amount and (z) any and all Liabilities that would have been payable to Mortgage Services pursuant to the Indemnification Agreement had such Indemnification not been terminated, except to the extent Mortgage Services has previously been indemnified for such Liabilities pursuant to the Indemnification Agreement and (ii) shall exclude any and all MS Servicing Costs, the Loan Purchase Price, the amounts paid as purchase price with respect to any

Scheduled Loan and any and all interest expense incurred by Mortgage Services in connection with the funding of any of the Loans.

**SECTION 8.05. Indemnification Procedures.**

(a) The matters set forth in Sections 5.6 through 5.9 of the Master Agreement shall be deemed incorporated into, and a made a part of, this Agreement.

(b)(i) Notwithstanding any provision to the contrary in this Agreement or in the Master Agreement, any Liability subject to indemnification or contribution pursuant to this Article VIII will be net of Wells Fargo Proceeds that actually reduce the amount of such Liability. Accordingly, the amount which any Indemnifying Party is required to pay to any Indemnified Party will be reduced by any Wells Fargo Proceeds theretofore actually recovered by or on behalf of the Indemnified Party in respect of the related Liability. If an Indemnified Party receives an Indemnity Payment required by this Agreement from an Indemnifying Party in respect of any Liability and subsequently receives Wells Fargo Proceeds with respect to such Liability, then the Indemnified Party will pay to the Indemnifying Party an amount equal to the excess of the Indemnity Payment received over the amount of the Indemnity Payment that would have been due if such Wells Fargo Proceeds had been received, realized or recovered before the Indemnity Payment was made.

(ii) The Indemnified Party shall use its commercially reasonable efforts to seek to collect or recover from Wells Fargo the amounts due to such Indemnified Party pursuant to Section 7.2 of the Wells Fargo Agreement to which the Indemnified Party is entitled in connection with any Liability for which the Indemnified Party seeks indemnification pursuant to this Article VIII; provided that the Indemnified Party's inability to collect or recover any such amounts shall not limit the Indemnifying Party's obligations hereunder.

**SECTION 8.06. Limitation on Liability.** Notwithstanding any other provision contained in this Agreement, neither GEMH Parties, on the one hand, nor Mortgage Services, on the other hand, shall be liable to the other for any special, indirect, punitive, incidental or consequential losses, damages or expenses of the other, including loss of profits, arising from any claim relating to breach of this Agreement or otherwise relating to any of the GEMH Services or MS Services provided hereunder. For clarification purposes only, the Parties agree that the limitation on liability contained in this Section 8.06 shall not apply to (a) damages awarded to a third party pursuant to a third party claim for which GEMH is required to indemnify, defend and hold harmless any Mortgage Services Indemnified Party under Section 8.02, (b) damages awarded to a third party pursuant to a third party claim for which Mortgage Services is required to indemnify, defend and hold harmless any GEMH Indemnified Party under Section 8.03, (c) damages awarded to a third party pursuant to a third party claim for which Contract Services is required to indemnify, defend and hold harmless any Mortgage Services Indemnified Party under Section 8.04 or that are payable by Genworth pursuant to Article XI, (d) any and all Liabilities resulting from the failure of Mortgage Services to receive any amounts (including interest and late fees) payable with respect to any Loan and/or Loan Asset pursuant to any document, agreement or instrument that constitutes a Loan Asset, including the failure resulting from any breach of representation or warranty or covenant made by GEMH Party in

this Agreement and/or by the applicable Lender in the applicable Loan Purchase Agreement and (e) any Deficiency Amount.

**SECTION 8.07. Liability for Payment Obligations.** Nothing in this Article VIII shall be deemed to eliminate or limit, in any respect, any Party's payment obligations as expressly set forth in this Agreement.

**ARTICLE IX**

**DISPUTE RESOLUTION**

**SECTION 9.01. Applicable Law.** This Agreement shall be governed by and construed and interpreted in accordance with the Laws of the State of New York irrespective of the choice of Laws principles of the State of New York other than Section 5-1401 of the General Obligations Law of the State of New York.

**SECTION 9.02. Dispute Resolution.** To the extent not resolved through discussions between the GEMH Manager and the Mortgage Services Manager, any dispute, controversy or claim arising out of, or relating to, the transactions contemplated by this Agreement, or the validity, interpretation, breach or termination of any provision of this Agreement, or the calculation or allocation of the costs of any GEMH Service, shall be resolved in accordance with Article VII of the Master Agreement.

**ARTICLE X**

**TERMINATION**

**SECTION 10.01. Termination.**

(a) The term of this Agreement shall commence on the date hereof and, unless earlier terminated pursuant to this Section 10.01(a), expire on December 31, 2005 (the "Term"). This Agreement shall terminate with respect to each GEMH Service on the applicable Service Termination Date or other termination date specified in this Agreement or the Schedules hereto. In addition, (i) Mortgage Services may from time to time terminate any GEMH Service, in whole or in part, upon giving

at least sixty (60) days' (or such shorter period of time as is mutually agreed upon in writing by the parties) prior written notice to GEMH specifying which GEMH Service is being so terminated (such termination will not in any way affect the obligations of the party terminating this Agreement with respect to such GEMH Service to continue to receive all other GEMH Services not so terminated and to continue to provide such other GEMH Services as required by this Agreement); (ii) either party (the "Non-Breaching Party") may terminate this Agreement with respect to any GEMH Service, in whole or in part, at any time upon prior written notice by the Non-Breaching Party to the other party (the "Breaching Party") if the Breaching Party has failed to perform any of its material obligations under this Agreement relating to such GEMH Service, and such failure shall have continued without cure for a period of sixty (60) days after receipt by the Breaching Party of a written notice of such failure from the Non-Breaching Party seeking to terminate such GEMH Service and (iii) Mortgage Services may terminate this Agreement with respect to its obligations pursuant to Section 2.03 and Article VI,

26

---

in whole but not in part, at any time upon prior written notice to Contract Services if Contract Services has failed to perform any of its material obligations pursuant to Article VI or Section 8.04 or any of its other material obligations pursuant to this Agreement, in each case relating to the Loans and the related Loan Assets purchased by Mortgage Services pursuant to this Agreement and Loan REOs, and such failure shall have continued without cure for a period of sixty (60) days after receipt by Contract Services of a written notice of such failure from Mortgage Services seeking to terminate its obligations pursuant to Section 2.03 and Article VI; provided, however, that (x) no GEMH Service may be terminated pursuant to Section 10.01(a)(ii) and (y) no obligations of Mortgage Services pursuant to Section 2.03 and Article VI may be terminated pursuant to Section 10.01(a)(iii), until the parties have completed the dispute resolution process set forth in Section 7.2 of the Master Agreement.

(b) In addition to and not in limitation of the rights and obligations set forth in Section 2.01(e), upon the request of Mortgage Services, (i) GEMH will, during the Term cooperate with Mortgage Services and use its good faith, commercially reasonable efforts to assist the transition of such GEMH Service to Mortgage Services (or Affiliate of Mortgage Services or such third-party vendor designated by the Mortgage Services) by the Service Termination Date for such GEMH Service and (ii) GEMH will, for a reasonable period of time after the effective date of any termination (which shall not exceed six months after the effective date of termination) of any such GEMH Service pursuant to Section 10.01(a)(ii) above, (A) at the written request of Mortgage Services, continue to provide the terminated GEMH Service (subject to the timely payment, when due and payable, by Mortgage Services of all Service Charges and Employment Costs related to such terminated GEMH Service) and (B) cooperate with Mortgage Services and use its good faith, commercially reasonable efforts to assist the transition of such GEMH Service to Mortgage Services (or Affiliate of Mortgage Services or such third-party vendor designated by Mortgage Services) as soon as reasonably practicable. The Service Charges and Employment Costs for a terminated GEMH Service that is continuing to be provided pursuant to clause (ii)(A) of the preceding sentence shall be calculated consistent with the basis on which such Service Charges and Employment Costs were calculated prior to the termination of such GEMH Service.

#### SECTION 10.02. Effect of Termination.

(a) Except with respect to any GEMH Service that is continuing to be provided pursuant to Section 10.01(b)(ii)(A) above after the termination of such GEMH Service, upon termination or expiration of any GEMH Service pursuant to this Agreement, GEMH will have no further obligation to provide the terminated GEMH Service, and Mortgage Services will have no obligation to pay any future Service Charges and Employment Costs relating to any such GEMH Service (other than for GEMH Services provided in accordance with the terms of this Agreement and received by Mortgage Services prior to such termination).

(b) Upon termination of this Agreement with respect to the obligations of Mortgage Services pursuant to Section 2.03 and Article VI, Mortgage Services shall have no further obligation to undertake the undertaking set forth in Section 2.03 and Article VI, except for the sale, transfer and assignment of the Loans and Loan REOs as set forth in Section 6.07. Upon payment of the amounts set forth in Section 6.07, Contract Services shall have no further obligation under Article VI (other than the obligation pursuant Section 6.03(a)(ii)).

27

---

SECTION 10.03. Survival. Section 3.01 (Computer-Based Resources), Article IV (Costs and Disbursements), Section 6.03(a)(ii) (Claims), Section 6.07 (Repurchase of Loans), Article VIII (Indemnification; Limitation on Liability), Article IX (Dispute Resolution), Section 10.01(b) (Termination), Section 10.02 (Effect of Termination), this Section 10.03 (Survival), Article XI (Guaranty), and Article XII (General Provisions) shall survive the expiration or other termination of this Agreement and remain in full force and effect.

#### SECTION 10.04. Business Continuity; Force Majeure.

(a) GEMH shall maintain and comply with reasonable disaster recovery, crisis management and business continuity plans and procedures designed to help ensure that it can continue to provide the GEMH Services in accordance with this Agreement in the event of a disaster or other significant event that might otherwise impact its operations. Upon the written request of Mortgage Services, GEMH shall (i) disclose to Mortgage Services GEMH's disaster recovery, crisis management and business continuity plans and procedures applicable to a GEMH Service and (ii) permit Mortgage Services to participate in testing of such disaster recovery, crisis management and business continuity plans and procedures, in each case so that Mortgage Services may assess such plans and procedures and develop or modify its own such plans and procedures in connection with the GEMH Service as Mortgage Services reasonably deems necessary.

(b) No Party (or any Person acting on its behalf) shall have any liability or responsibility for failure to fulfill any obligation (other than a payment obligation) under this Agreement so long as and to the extent to which the fulfillment of such obligation is prevented, frustrated, hindered or delayed as a consequence of circumstances of Force Majeure; provided that such party shall have exhausted the procedures described in its disaster recovery, crisis management, and business continuity plan. A party claiming the benefit of this provision shall, as soon as reasonably practicable after the occurrence of any such event: (i) notify the other party of the nature and extent of any such Force Majeure condition and (ii) use commercially reasonable efforts to remove any such causes and resume performance under this Agreement as soon as feasible.

### ARTICLE XI

#### GUARANTY

SECTION 11.01. Guaranty. Genworth hereby unconditionally and irrevocably guarantees the full and prompt satisfaction, payment and performance of all liabilities and obligations of Contract Services pursuant to this Agreement, including Section 8.04, to any and all of the Mortgage Services Indemnified Parties, in each case whether such liabilities or obligations are now or hereafter existing, and any and all reasonable costs and expenses (including fees and expenses of counsel) incurred by the Mortgage Services Indemnified Parties in enforcing any of their respective rights under this Agreement with respect to obligations of Contract Services and Genworth (including in enforcing any rights under this Article XI) (the "Guaranteed Obligations"). The guaranty set forth in this Article XI (the "Guaranty") is an absolute, present and continuing guaranty of payment and performance and not

28

---

a guaranty of collection only and is in no way conditional or contingent upon any attempt to collect from Contract Services or any other guarantor in respect of the Guaranteed Obligations.

SECTION 11.02. Guaranty Absolute. Genworth guaranties that the Guaranteed Obligations will be satisfied strictly in accordance with the terms of this Agreement, regardless of any law, regulation or order now or hereafter in effect in any jurisdiction affecting any of such terms or the rights of the Mortgage Services Indemnified Parties with respect thereto. Genworth's undertakings and obligations hereunder are a derivative of, and not in excess of the Guaranteed Obligations. The liability of Genworth under this Guaranty shall be absolute and unconditional irrespective of:

- (a) any lack of validity or enforceability of any provision of this Agreement, any other agreement or instrument relating to this Agreement, or avoidance or subordination of any of the Guaranteed Obligations;
- (b) any change in or any other amendment or waiver of any term of, or any consent to departure from any requirement of, this Agreement (other than this Article XI);
- (c) any release or amendment or waiver of any term of any other guaranty of, or any consent to departure from any requirement of any other guaranty of, all or any of the Guaranteed Obligations;
- (d) the absence of any attempt to collect any of the Guaranteed Obligations from Contract Services or from any other guarantor or any other action to enforce the same or the election of any remedy by any of Mortgage Services Indemnified Parties;
- (e) any waiver, consent, extension, forbearance or granting of any indulgence by any of Mortgage Services Indemnified Parties with respect to any provision of this Agreement (other than this Article XI);
- (f) the election by any of Mortgage Services Indemnified Parties in any proceeding under chapter 11 of Title 11 of the United States Code (together with any successor thereto, the "Bankruptcy Code") of the application of section 1111(b)(2) of the Bankruptcy Code;
- (g) the disallowance, under section 502 of the Bankruptcy Code, of all or any portion of the claims of any of the Mortgage Services Indemnified Parties for payment or performance of any of the Guaranteed Obligations; or
- (h) any other circumstance which might otherwise constitute a legal or equitable discharge or defense of a guarantor.

SECTION 11.03. Waiver.

(a) Genworth hereby (i) waives (A) promptness, diligence, notice of acceptance and any and all other notices with respect to any of the Guaranteed Obligations or this Article XI, (B) any requirement that any of the Mortgage Services Indemnified Parties exhaust any right or take any action against Contract Services or any other Person, (C) the filing

29

---

of any claim with a court in the event of receivership or bankruptcy of Contract Services, (D) protest or notice of protest with respect to nonpayment or non-performance of all or any of the Guaranteed Obligations, and (E) all demands whatsoever (and any requirement that same be made on any Person as a condition precedent to Genworth's obligations hereunder); and (ii) covenants and agrees that, this Guaranty will not be discharged except by complete performance of the Guaranteed Obligations and any other obligations of Genworth contained herein.

(b) If, in the exercise of any of its rights and remedies, any of the Mortgage Services Indemnified Parties shall forfeit any of its rights or remedies, including its right to enter a deficiency judgment against Contract Seller or any other Person, whether because of any applicable law pertaining to "election of remedies" or similar doctrine, Genworth hereby consents to such action by such Mortgage Services Indemnified Party and waives any claim based upon such action. Any election of remedies which results in the denial or impairment of the right of such Mortgage Services Indemnified Party to seek a deficiency judgment against Contract Services shall not impair the obligation of Genworth to pay the full amount of the Guaranteed Obligations or any other obligation of Genworth contained herein.

(c) Genworth consents and agrees that the Guaranteed Parties shall be under no obligation to marshal any assets in favor of the Guarantor or otherwise in connection with obtaining payment of any or all of the Guaranteed Obligations from any Person or source.

Until the indefeasible payment in full in cash and the full performance of all of the Guaranteed Obligations, Genworth waives and relinquishes any and all rights which it may acquire against Contract Services by way of subrogation, contribution or reimbursement by reason of this Guaranty or by any payment made hereunder.

**ARTICLE XII**

**GENERAL PROVISIONS**

SECTION 12.01. GEMH Manager. Promptly after the date hereof, GEMH will designate a dedicated services account manager (the "GEMH Manager") who will be directly responsible for coordinating and managing the delivery of the GEMH Services and will have authority to act on GEMH Party's behalf with respect to the GEMH Services and other obligations of GEMH under this Agreement. The GEMH Manager will work with Mortgage Services Manager to address the Mortgage Services' issues and the Parties' relationship under this Agreement.

SECTION 12.02. Mortgage Services Manager: Functional Leaders.

(a) Promptly after the date hereof, Mortgage Services will identify an employee of Mortgage Services or of its Affiliates (the "Mortgage Services Manager") who will be the transition leader and have authority to act on Mortgage Services behalf with respect to the GEMH Services and obligations of Mortgage Services under this Agreement. The Mortgage Services Manager will work with the GEMH Manager to address GEMH's issues and the Parties' relationship under this Agreement.

30

---

(b) On or prior to June 30, 2005, Mortgage Services shall identify functional leaders who will commence the transition of GEMH Services from GEMH to Mortgage Services or a supplier designated by Mortgage Services.

SECTION 12.03. Independent Contractors. Each Party shall act solely as independent contractor and nothing in this Agreement shall constitute or be construed to be or create a partnership, joint venture, or principal/agent relationship between GEMH Parties, on the one hand, and Mortgage Services, on the other. Except as set forth in Section 4.02, all Persons employed by GEMH or any of its Affiliates in the performance of its obligations under this Agreement shall be the sole responsibility of GEMH and all Persons employed by Mortgage Services in performance of its obligations under this Agreement shall be the sole responsibility of Mortgage Services.

SECTION 12.04. Subcontractors. Any Party may hire or engage one or more subcontractors to perform any or all of its obligations under this Agreement; provided that (a) GEMH shall in all cases remain liable for all its obligations under this Agreement, including with respect to the scope of the GEMH Services, the Standard

for Services and the content of the GEMH Services provided to Mortgage Services and (b) Mortgage Services shall in all cases remain liable for all its obligations under this Agreement, including with respect to the scope and content of its management and servicing of the Loans and the MS Standard. Under no circumstances shall Mortgage Services be responsible for making any payments directly to any subcontractor engaged by any GEMH Party or any GEMH Party be responsible for making any payments directly to any subcontractor engaged by Mortgage Services.

SECTION 12.05. Additional Services; Books and Records; Mortgage Services Property.

(a) If, during the Term, Mortgage Services identifies a need for additional or other services to be provided by or on behalf of GEMH, the Parties agree to negotiate in good faith to provide such requested services (provided that such services are of a type generally provided by GEMH or any of its Affiliates at such time) and the applicable service fees, payment procedures, and other rights and obligations with respect thereto. To the extent practicable, such additional or other services shall be provided on terms substantially similar to those applicable to GEMH Services of similar types and otherwise on terms consistent with those contained in this Agreement.

(b) All books, records and data maintained by GEMH for Mortgage Services with respect to the provision of a GEMH Service to Mortgage Services shall be the exclusive property of Mortgage Services. Mortgage Services, at its sole cost and expense, shall have the right to inspect, and make copies of, any such books, records and data during regular business hours upon reasonable advance notice to GEMH. At the sole cost and expense of GEMH, upon termination of the provision of any GEMH Service, the relevant books, records and data relating to such terminated Service shall be delivered by GEMH to Mortgage Services in a mutually agreed upon format to the address of Mortgage Services set forth in Section 12.07 or any other mutually agreed upon location; provided, however, that GEMH shall be entitled to retain one copy of all such books, records and data relating to such terminated GEMH Service for archival purposes and for purposes of responding to any dispute that may arise with respect thereto.

31

---

Upon the termination of this Agreement, at the sole cost and expense of GEMH, GEMH shall deliver to Mortgage Services any and all other property of Mortgage Services or any other Mortgage Entity in GEMH's possession to Mortgage Services.

SECTION 12.06. Confidential Information. Each Party agrees that Section 6.2 of the Master Agreement is hereby incorporated by reference into, and a made a part of, this Agreement; provided, however, that for the purposes of this Agreement (i) references in Section 6.2 of the Master Agreement to "GE Parties" shall be deemed to refer to "Mortgage Entities", (ii) references in Section 6.2 of the Master Agreement to "Genworth" shall be deemed to refer to "GEMH Parties", and (iii) references in Section 6.2 of the Master Agreement to "Genworth Business" shall be deemed to refer to "the business of GEMH Parties".

SECTION 12.07. Notices. All notices, requests, claims, demands and other communications under this Agreement shall be in writing and shall be given or made (and shall be deemed to have been duly given or made upon receipt) by delivery in person, by overnight courier service, by facsimile with receipt confirmed (followed by delivery of an original via overnight courier service) or by registered or certified mail (postage prepaid, return receipt requested) to the respective parties at the following addresses (or at such other address for a party as shall be specified in a notice given in accordance with this Section 12.07):

32

---

if to Mortgage Services:

GE Mortgage Services, LLC  
6601 Six Forks Road  
Raleigh, North Carolina 27615  
Attention: General Manager

with a copy to:

Weil, Gotshal & Manges LLP  
767 Fifth Avenue  
New York, NY 10153  
Attention: Howard Chatzinoff, Esq.

if to GEMH Parties

General Electric Mortgage Holdings LLC  
6601 Six Forks Road  
Raleigh, North Carolina 27615  
Attention: President

with a copy to

General Electric Mortgage Holdings LLC  
6601 Six Forks Road  
Raleigh, North Carolina 27615  
Attention: General Counsel

and

Hunton & Williams LLP  
Riverfront Plaza, East Tower  
951 E Byrd Street  
Richmond, VA 23219-4074  
Attention: Allen C. Goolsby, Esq.

SECTION 12.08. Taxes.

(a) Each Party shall be responsible for any personal property taxes on property it owns or leases, for franchise and privilege taxes on its business, and for taxes based on its net income or gross receipts.

(b) Each of the parties agrees that if reasonably requested by the other party, it will cooperate with such other party to enable the accurate determination of such other party's tax liability and assist such other party in minimizing its tax liability to the extent legally permissible. GEMH invoices shall separately state the amounts of any taxes the GEMH is proposing to collect from Mortgage Services.

SECTION 12.09. Regulatory Approval and Compliance. Each of Mortgage Services and each GEMH Party shall be responsible for its own compliance with any and all Laws applicable to its performance under this Agreement; provided, however, that each of Mortgage Services and GEMH shall, subject to reimbursement of out-of-pocket expenses by the requesting party, cooperate and provide one another with all reasonably requested assistance (including, the execution of documents and the provision of relevant information) required by the requesting party to ensure compliance with all applicable Laws in connection with any regulatory action, requirement, inquiry or examination related to this Agreement, the GEMH Services or the MS Services.

SECTION 12.10. Severability. If any term or other provision of this Agreement is invalid, illegal or incapable of being enforced under any Law or as a matter of public policy, all other conditions and provisions of this Agreement shall nevertheless remain in full force and effect. Upon such determination that any term or other provision is invalid, illegal or incapable of being enforced, the parties to this Agreement shall negotiate in good faith to modify this Agreement so as to effect the original intent of the parties as closely as possible in a mutually acceptable manner in order that the transactions contemplated by this Agreement be consummated as originally contemplated to the greatest extent possible.

SECTION 12.11. Entire Agreement. Except as otherwise expressly provided in this Agreement, this Agreement (including the Schedules and Exhibits hereto) constitutes the entire agreement of the Parties with respect to the subject matter of this Agreement and supersedes all prior agreements and undertakings, both written and oral, between or on behalf of the Parties with respect to the subject matter of this Agreement.

SECTION 12.12. Assignment; No Third-Party Beneficiaries. This Agreement shall not be assigned by any Party without the prior written consent of the other party. Except as provided in Article VIII with respect to GEMH Indemnified Parties and Mortgage Services Indemnified Parties, this Agreement is for the sole benefit of the parties to this Agreement and their permitted successors and assigns and nothing in this Agreement, express or implied, is intended to or shall confer upon any other Person any legal or equitable right, benefit or remedy of any nature whatsoever under or by reason of this Agreement.

SECTION 12.13. Amendment. No provision of this Agreement may be amended or modified except by a written instrument signed by all the parties to such agreement. No waiver by any party of any provision hereof shall be effective unless explicitly set forth in writing and executed by the party so waiving. The waiver by either Party of a breach of any provision of this Agreement shall not operate or be construed as a waiver of any other subsequent breach.

SECTION 12.14. Rules of Construction. Interpretation of this Agreement shall be governed by the following rules of construction: (a) words in the singular shall be held to include the plural and vice versa and words of one gender shall be held to include the other gender as the context requires, (b) references to the terms Article, Section, Exhibit, paragraph, and Schedule are references to the Articles, Sections, Exhibits, paragraphs, and Schedules to this Agreement unless otherwise specified, (c) the word "including" and words of similar import shall mean "including, without limitation," (d) provisions shall apply, when appropriate, to

successive events and transactions, (e) the headings contained herein are for reference purposes only and shall not affect in any way the meaning or interpretation of this Agreement and (f) this Agreement shall be construed without regard to any presumption or rule requiring construction or interpretation against the party drafting or causing any instrument to be drafted. Unless specifically stated in the Master Agreement that a particular provision of the Master Agreement should be given effect in lieu of a conflicting provision in this Agreement, to the extent that any provision contained in this Agreement conflicts with, or cannot logically be read in accordance with, any provision of the Master Agreement, the provision contained in this Agreement shall prevail.

SECTION 12.15. Counterparts. This Agreement may be executed in one or more counterparts, and by the different parties to each such agreement in separate counterparts, each of which when executed shall be deemed to be an original but all of which taken together shall constitute one and the same agreement. Delivery of an executed counterpart of a signature page to this Agreement by facsimile shall be as effective as delivery of a manually executed counterpart of any such Agreement.

SECTION 12.16. No Right to Set-Off. No Party shall set-off, counterclaim or otherwise withhold any amount owed by such Party to another Party on account of any obligation owed to such Party by another Party.

SECTION 12.17. Existing Agreements.

(a) The Parties acknowledge and agree that from and after the date hereof the Existing Servicing Agreement and the Existing Shared Services Agreement shall be deemed terminated and shall be of no further force and effect.

(b) The Lease Agreement is hereby terminated and shall be of no further force and effect; provided, however, that the indemnification provisions set forth in Sections 6 and 7 of the Indemnification Agreement shall survive such termination.

(c) The Indemnification Agreement is hereby terminated and shall be of no further force and effect.

SECTION 12.18. Further Assurances. Each Party agrees that upon request of another Party, at any time after the date hereof such first Party will forthwith execute and deliver to the requesting Party or its designee such further instruments of assignment, transfer, conveyance, endorsement, direction or authorization and other documents as the requesting Party or its counsel may reasonably request in order to effectuate the purposes of this Agreement.

[SIGNATURE PAGE FOLLOWS]

IN WITNESS WHEREOF, the parties have caused this Agreement to be executed on the date first written above by their respective duly authorized officers.

GE MORTGAGE SERVICES, LLC

By: \_\_\_\_\_  
Name:  
Title:

GENERAL ELECTRIC MORTGAGE  
HOLDINGS LLC

By: \_\_\_\_\_  
Name:  
Title:

GE MORTGAGE CONTRACT SERVICES INC.

By: \_\_\_\_\_  
Name:  
Title:

GENWORTH FINANCIAL, INC.

By: \_\_\_\_\_  
Name:  
Title:

*Acknowledged and agreed:*  
GENERAL ELECTRIC MORTGAGE  
INSURANCE CORPORATION,  
solely with respect to Section 12.17

By: \_\_\_\_\_  
Name: \_\_\_\_\_  
Title: \_\_\_\_\_

---

**Schedule A**

**GEMH Services**

<b><u>GEMH Services</u></b>	<b><u>Service Termination Date</u></b>
(a) Finance, including Accounting, Financial Planning and Analysis, Cash Management/Treasury Services	December 31, 2005
(b) Legal	December 31, 2005
(c) Information Technology and Data Processing	December 31, 2005
(d) Risk	December 31, 2005
(e) Vendor Management	December 31, 2005
(f) Quality	December 31, 2005
(g) Loss Mitigation, including restructuring of loans and foreclosure	December 31, 2005
(h) Asset Management	December 31, 2005
(i) Operating Plan.	December 31, 2005
<p>GEMH shall use its best efforts to assist in the execution of an operating plan of Mortgage Entities (the "<u>Operating Plan</u>") with respect to mortgage loan sales and purchases by Mortgage Entities. For the avoidance of doubt, the Operating Plan shall not include any income/loss, incremental time, effort or expenses associated with the sale of Mortgage Servicing Rights.</p>	
(j) Facilities, including access to and management of facilities described in Section 3.02.	December 31, 2005
(k) Tax Services	December 31, 2004

For the avoidance of doubt, GEMH shall prepare and file, subject to prior review and approval by Mortgage Services, all Tax Returns with respect to Mortgage Entities and their respective assets required to be filed in 2004. Mortgage Services shall prepare and file all Tax Returns with respect to Mortgage Entities and their respective assets required to be filed on or after January 1, 2005 and complete all audit examinations in process as of January 1, 2005.

---

CONFIDENTIAL TREATMENT REQUESTED: INFORMATION FOR WHICH CONFIDENTIAL TREATMENT HAS BEEN REQUESTED IS OMITTED AND NOTED WITH “\*\*\*”. AN UNREDACTED VERSION OF THIS DOCUMENT HAS ALSO BEEN PROVIDED TO THE SECURITIES AND EXCHANGE COMMISSION.

Dated 2004

GEFA International Holdings, Inc.

and

GE Capital Corporation

Framework Agreement

**Linklaters**

One Silk Street  
London EC2Y 8HQ

Telephone (44-20) 7456 2000

---

**TABLE OF CONTENTS**

1	<a href="#">Definitions And Interpretation</a>
2	<a href="#">Local Agreements</a>
3	<a href="#">Exclusive Appointment</a>
4	<a href="#">Regulatory Requirements</a>
5	<a href="#">Financial Terms</a>
6	<a href="#">Pricing - Profit Share and Financial Performance</a>
7	<a href="#">Marketing</a>
8	<a href="#">Non Solicit</a>
9	<a href="#">Service Levels, Service Credits, Product Development and Good Industry Practice</a>
10	<a href="#">Intellectual Property, Data and Data Protection</a>
11	<a href="#">Data Protection</a>
12	<a href="#">Gross Written Premiums and Collection</a>
13	<a href="#">Cancellations and Cancellation Fees</a>
14	<a href="#">Default Interest</a>
15	<a href="#">Relationship Managers, and Informal Dispute Resolution and Arbitration</a>
16	<a href="#">Performance Meetings And Report Outs</a>
17	<a href="#">Accounts, Records and Access to Information</a>
18	<a href="#">Assignment, Agents and Sub-Contracting</a>
19	<a href="#">Warranty of Authority</a>
20	<a href="#">Commencement, Term and Termination</a>
21	<a href="#">Consequences of Termination</a>
22	<a href="#">Force Majeure</a>
23	<a href="#">Confidential Information</a>
24	<a href="#">Waiver</a>
25	<a href="#">Entire Agreement</a>

<a href="#">26</a>	<a href="#">Costs and Expenses</a>
<a href="#">27</a>	<a href="#">No Partnership</a>
<a href="#">28</a>	<a href="#">Notices</a>
<a href="#">29</a>	<a href="#">Invalidity and Severability</a>

<a href="#">30</a>	<a href="#">Governing Law and Jurisdiction and Appointment of Process Agent</a>
<a href="#">31</a>	<a href="#">Exclusion of Third Party Rights</a>
	<a href="#">Schedule 1 Existing Business</a>
	<a href="#">Schedule 2 GE Financial Insurance Service Level Standards</a>
	<a href="#">Schedule 3 New Local Agreement Profit Share Provisions</a>
	<a href="#">Schedule 4 Product Performance Monitoring</a>
	<a href="#">Schedule 5 Potential New Business and Payment Protection Products Set-up Process</a>
	<a href="#">Schedule 6 Part A: Framework Agreement Performance Meetings</a>
	<a href="#">Schedule 7 Supplemental Sales Commission</a>
	<a href="#">Schedule 8 Local Agreements</a>
	<a href="#">Schedule 9 GEFA Group Companies</a>
	<a href="#">Schedule 10 EXCHANGE RATES</a>
	<a href="#">Schedule 11 Form of Local Addendum</a>
	<a href="#">Schedule 12 Form of New Local Agreement</a>
	<a href="#">Schedule 13 APPROVED SUBCONTRACTORS</a>
	<a href="#">Schedule 14 Benchmarking</a>
	<a href="#">Schedule 15 Potential Substitute Business</a>
	<a href="#">Schedule 16 Business Proposal Pricing Process</a>

Facsimile (44-20) 7456 2222

Ref

**THIS AGREEMENT** is made the 2004

**BETWEEN:**

- (1) **GEFA INTERNATIONAL HOLDINGS, INC.** whose registered office is at 6604 West Broad Street, Richmond, VA 23230, USA (“**GEFA**”); and
- (2) **GE CAPITAL CORPORATION** whose registered office is at Corporation Trust Center, 1209 Orange Street, Wilmington, Delaware (“**GECC**”).

Collectively GEFA and GECC shall be referred to as “**the Parties**” and each as a “**Party**”.

**RECITALS:**

- (A) GEFA is or will become the holding company of each GEFA Company.
- (B) GECF is the holding company of each GECF Group Company who is party to existing insurance arrangements with GEFA Companies.
- (C) As at the date of this agreement certain GEFA Companies provide Existing Payment Protection Products to certain GECF Group Companies under the Existing Local Agreements.
- (D) GECC intends to appoint the GEFA Companies as the exclusive provider of Payment Protection Products to the GECF Group Companies in the Territories subject to the terms and conditions of this agreement and in return GEFA has agreed to provide market leading products and services and to deliver its services hereunder to a world class standard.
- (E) The Parties have entered into this agreement to give effect to their intention in relation to the Existing Local Agreements and in relation to New Local Agreements and New Territories.



THE PARTIES AGREE AS FOLLOWS:

**1 Definitions And Interpretation**

**1.1 Definitions**

The following words and expressions shall, unless the context otherwise requires, have the following meanings:

“**Acquired GECF Business**” has the meaning given to it in Clause 3.2.6;

“**Amended New Business Proposal**” has the meaning given to it in paragraph 8.1 of Part A of Schedule 5;

“**Applicable Laws**” means any of the following in force from time to time in any of the Territories: any common law, statute, statutory instrument, treaty, rule, regulation,

---

directive, guideline, guidance, decision, bylaw, code, order, notice, demand, decree, resolution or judgement or licence conditions, or anything similar to any of the above in each case of a Governmental Authority and which is binding on GECC or any GECF Group Company or GEFA or any GEFA Company;

“**Approved Subcontractor**” means any of (i) the existing sub-contractors used by GEFA or a GEFA Company in connection with the provision of services to GECC or a GECF Group Company at the Commencement Date; (ii) the persons, from time to time, listed on the General Electric Group’s list of approved subcontractors; or (iii) any other person who in the reasonable opinion of the parties meets the due diligence requirements set out in Schedule 13 of this agreement;

“**Benchmarking Pool**” means any company or organisation that offers Payment Protection Products to consumers in one or more Territories;

“**Best in Class**” means service levels, product development and related services that are in the top 10 per cent. of Payment Protection Product providers in the relevant Territory;

“**Business**” means the provision, selling or distribution of Payment Protection Products by the GECF Group Companies provided by the GEFA Companies under this agreement;

“**Business Day**” means a day (other than a Saturday, Sunday or public holiday) on which banks are open for business in London and, in relation to a GEFA Company or GECF Group Company, a day (other than a Saturday, Sunday or public holiday) on which banks are open for business in the place of business of that GEFA Company or GECF Group Company;

“**Claims Frequency**” means number of claims with a date of loss in the period under investigation divided by Earned Exposure in the same period;

“**Claims Incurred**” means claim payments plus Claims Reserves at the end of the period under investigation minus Claims Reserves at the beginning of the period under investigation;

“**Claims Performance Statement**” means the statement to be prepared by GEFA in accordance with clause 6.2 and Schedule 4;

“**Claims Reserves**” means the provisions held in GEFA’s US GAAP balance sheet in respect of all future payments on claims with a date of loss before the balance date;

“**Commencement Date**” means 1 January, 2004;

“**Committed Payments Product**” means any of the following:

- (a) a product which protects regular financial commitments due to a third party including gas, electricity, water and telecommunications companies; and

2

- 
- (b) an extension of or variation to any other Payment Protection Product distributed by GECF to protect payment obligations due to persons other than GECF Group Companies;

“**Comparable GWP**” means the aggregate GWP accruing to GEFA and the GEFA Companies during the Previous Relevant Period in respect of all Policies in all Territories sold during the Previous Relevant Period (excluding GWP which accrued to GEFA and the GEFA Companies in relation to any Local Agreements which were terminated pursuant to clause 20.4 during the course of the Previous Relevant Period);

“**Confidential Information**” means:

- (a) in relation to GEFA, all information relating to GEFA’s or to any GEFA Company’s business, customers or financial or other affairs which is not publicly known including information relating to:
  - (i) customer and supplier names and other details of customers and suppliers, sales targets, sales statistics, market share statistics, prices, market research reports and surveys; and
  - (ii) future projects, business development or planning, commercial relationships and negotiations or any insurance product concepts, ideas or proposals of GEFA or any GEFA Company; and
  - (iii) designs, formulae, inventions or improvements relating to products or prospective products designed or sold by GEFA or any GEFA Company or any other trade secrets or know-how or financial information in relation to the businesses, finances, dealings or affairs of GEFA or any GEFA Company;
- (b) in relation to GECC, all information relating to any GECF Group Company’s business or financial or other affairs which is not publicly known including information relating to:
  - (i) customer and supplier names and other details of customers and suppliers, sales targets, sales statistics, market share statistics, prices, market research reports and surveys; and

- (ii) future projects, business development or planning, commercial relationships and negotiations or any insurance product concepts, ideas or proposals of any GECF Group Company; and
- (iii) designs, formulae, inventions or improvements relating to products or prospective products designed or sold by any GECF Group Company or any other trade secrets or know-how or financial information in relation to the businesses or finances of any GECF Group Company;

“**Contract Year**” means each consecutive 12 month period from the Commencement Date or its anniversary (as the case may be) until the next anniversary;

“**Control**” means:

- (a) in relation to a body corporate, the ability of a person (either alone or in conjunction with another person pursuant to some agreement, arrangement or understanding) to ensure that the activities and business of that body corporate are conducted in accordance with the wishes of that person, and, without limitation, a person shall be deemed to have “**Control**” of a body corporate if:
  - (i) that person (either alone or in conjunction with another person pursuant to some agreement, arrangement or understanding) is entitled to exercise 50 per cent. or more of the voting rights which are ordinarily exercisable in a general meeting of that body corporate;
  - (ii) that person (either alone or in conjunction with another person pursuant to some agreement, arrangement or understanding) is entitled to appoint a majority of the board of directors of the body corporate;
  - (iii) in the case of a body corporate whose shares are not listed, quoted or dealt in on any securities or investment exchange or quotation system that person (either alone or in conjunction with another person pursuant to some agreement, arrangement or understanding) has the right to receive the majority of the income of that body corporate on any distribution by it of all of its income or the majority of its assets on a winding-up; or
- (b) in relation to an entity not being a body corporate, the power (either alone or in conjunction with another person pursuant to some agreement, arrangement or understanding) to direct the management or policies of such person, whether by operation of law, by contract or otherwise;

“**Data Protection Legislation**” means the Data Protection Act 1998 (UK), all applicable legislation implementing European Community Directives 95/46 and 97/66 for EU countries and all applicable data protection legislation in any of the Territories;

“**Dispute**” has the meaning given to it in clause 15.3;

“**Earned Claims Fund**” means Gross Earned Premium less Sales Commission incurred less Earned Retention;

“**Earned Exposure**” means the number of equivalent annual Policies in the period under investigation;

“**Eligible GWP**” means the aggregate GWP accruing to GEFA and the GEFA Companies during the Relevant Period in respect of all Policies in all Territories sold during the Relevant Period;

“**Earned Retention**” means an amount withheld by GEFA to cover the cost of underwriting the Business expressed as a percentage of Gross Earned Premium (the “Retention Rate”) to be subtracted from the Gross Earned Premium when calculating the underwriting profit;

“**Existing Business**” means the Existing Direct Business and Existing Reinsured Business at the rates in existence at the Commencement Date to include any renaming, rebranding, product change or variation thereto (including any Substitute Business);

“**Existing Direct Business**” means the Schemes in existence at the Commencement Date as identified in Schedule 1 Part A;

“**Existing Local Agreements**” means the agreements in place in each Existing Territory at the Commencement Date, including any addendum thereto, and as listed in Schedule 8;

“**Existing Payment Protection Products**” means the payment protection insurance policies and schemes in the Existing Territories as set out in parts A and B of Schedule 1;

“**Existing Reinsured Business**” means the Schemes in existence at the Commencement Date as identified in Schedule 1 Part B;

“**Existing Territories**” means Italy, Spain, Portugal, Norway, Denmark, Sweden, United Kingdom, Ireland, Switzerland, Germany and France;

“**Exit Phase**” means:

- (a) in the context of expiry of this agreement or a Local Agreement, the period of 12 months prior to the date on which this agreement or the relevant Local Agreement (as the case may be) expires; and
- (b) in any other case, the period (with a minimum of 90 days) stipulated in the relevant notice of termination of this agreement or the relevant Local Agreement (as the case may be);

“**Exit Plan**” has the meaning given to that term in clause 21.3.1;

“**Financial Services Regulator**” means the Financial Services Authority in the United Kingdom or any successor or replacement thereof or, in the case of a Territory other than the United Kingdom, its equivalent;

“**GECF Captive**” means a captive insurance company to be established by GECC;

“**GECF Group**” means any subsidiary of GECC from time to time (other than Acquired GECF Business or GEFA Companies) who, from time to time, distributes Payment Protection Products in conjunction with entering into consumer financing agreements or arrangements where the relevant GECF Group Company (or a member of its Group) acts as the provider of finance. “**GECF Group Company**” shall be construed accordingly; Where GECF is successful in procuring that Acquired GECF Business appoints a GEFA

Company as its exclusive provider of Payment Protection Products pursuant to Clause 3.2.3, then this definition shall automatically include such Acquired GECE Business;

“**GECE Marks**” means the marks owned by the GECE Group or another member of the General Electric Group which are used by the GEFA Group as at the Commencement Date to fulfil their obligations under this agreement or any Local Agreement and any additional marks agreed in writing between the Parties from time to time;

“**GEFA Company**” means each of the companies listed in Schedule 9 and any additional company as notified in writing to GECE by GEFA from time to time;

“**GEFA Group**” means GEFA and each of the GEFA Companies;

“**GEFA Marks**” means the marks owned by Genworth Financial, Inc. or a member of its Group which are used by the GECE Group as at the Commencement Date to fulfil their obligations under this agreement or any Local Agreement and any additional marks agreed in writing between the parties from time to time;

“**GEFI Guernsey**” means Financial Insurance Guernsey PCC Limited;

“**Good Industry Practice**” means, in relation to any particular circumstances, the degree of skill, diligence, prudence, foresight and operating practice which would reasonably and ordinarily be expected from a reasonably skilled and experienced provider of Payment Protection Products and related services of a similar type to the Payment Protection Products and related services provided pursuant to this agreement under the same or similar circumstances;

“**Governmental Authority**” means any court, government, regulatory agency or regulatory authority (in each case whether international, national or local and in any jurisdiction), including the Financial Services Regulator;

“**Group**” means, in relation to any person, that person, its holding companies and the subsidiaries and subsidiary undertakings from time to time of such holding companies, all of them and each of them as the context admits including any joint venture companies, business relationships or any other business relationship;

“**Gross Earned Premium**” means the earning of the Gross Written Premium according to the GEFA balance sheet for US GAAP results reporting purposes;

“**Gross Loss Ratio**” means Ultimate Claims Cost divided by Gross Earned Premium;

“**Gross Written Premium**” (or “**GWP**”) means, in relation to any Policy, the total premium payable by an Insured Customer in respect thereof less any Tax/levy and cancellations/refunds;

“**Identified New Business**” means the Schemes as identified in Schedule 1 Part C;

“**Incentive Threshold**” has the meaning given to it in clause 5.3;

“**Insolvent**” means in the case of any party the appointment of, the application for the appointment of or any step taken with a view to the appointment of, a liquidator, provisional liquidator, administrator, administrative receiver or receiver or equivalent officer, the entering into or the taking of any step with a view to the entering into of a scheme of arrangement or composition for the benefit of creditors generally (including a voluntary arrangement under Part 1 of the Insolvency Act 1986), any re-organisation, moratorium or other administration involving its creditors or any class of its creditors, the proposal or passing of a resolution or the convening of a meeting to consider a proposal to wind it up (other than a voluntary winding-up as part of a reorganisation) or the company becoming unable or being deemed to be unable to pay its debts as and when they fall due within the meaning of section 123 of the Insolvency Act 1986 or anything equivalent or analogous to any of the foregoing occurring in any jurisdiction;

“**Insured**” and “**Insured Customer**” means any GECE Group Company customer who has entered into a Policy provided:

- (i) by GEFA or a GEFA Company as the primary insurer; or
- (ii) by a primary insurer for which GEFA or a GEFA Company acts as a reinsurer;

“**Key Service Levels**” means the Service Levels specified in Table B of Schedule 2;

“**Key Territories**” means United Kingdom, Germany and France and any other Territory which accounts for more than 21,900,000 Euros of GWP in a Relevant Period;

“**Local Addendum**” means the addendum in the form set out in Schedule 11 to be entered into by the relevant GECE Group Companies with the relevant GEFA Companies in accordance with clause 2.1 or 5.4.3 (as the case may be);

“**Local Agreements**” means the Existing Local Agreements and the New Local Agreements;

“**Local Comparable GWP**” means the aggregate GWP accruing to a GEFA Company during the Previous Relevant Period in respect of all Policies sold during the Previous Relevant Period which relate to a particular Local Agreement the “**Relevant Local Agreement**”;

“**Local Eligible GWP**” means the aggregate GWP accruing to a GEFA Company during the Relevant Period in respect of all Policies sold during the Relevant Period which relate to the Relevant Local Agreement;

“**Local Material Change**” has the meaning given to it in clause 20.4.4;

“**Loss Ratio**” means either Claims Incurred divided by the Earned Claims Fund as calculated from the Profit Share Account or Ultimate Claims Cost divided by Earned Claims Fund, as calculated in the Claims Performance Statement;

“**Material Change**” has the meaning given to it in clause 20.2.3;

“**Net Premium**” means Gross Written Premium less any Sales Commission;

“**New Business**” has the meaning given to it in clause 3.2.2 and, for the avoidance of doubt, shall exclude Substitute Business;

“**New Business Proposal**” has the meaning given to it in paragraph 5 of Part A of Schedule 5;

“**New Captive**” means any entity forming part of an Acquired GECF Business which is the captive insurer of the Acquired GECF Business;

“**New Direct Business**” means all New Business that is not New Reinsurance Business and as agreed from time to time between the parties pursuant to clause 5.4.1;

“**New Local Agreement**” has the meaning given to it in clause 5.4.2;

“**New Payment Protection Products**” means products within the definition of Payment Protection Products but which are not Existing Payment Protection Products;

“**New Reinsurance Business**” means any New Business as agreed to be New Reinsurance Business from time to time between the parties pursuant to clause 5;

“**New Territories**” means \*\*, and such other countries as may be agreed in writing between the Parties from time to time;

“**Payment Protection Products**” means any of the following:

- (a) any insurance, guarantee or waiver style product (howsoever described) which assists consumers in meeting some or all of their payment obligations under financial commitments (including without limitation mortgages, personal and car loans and credit cards) which is linked to, or forms part of or is financed under any underlying financing or credit agreement or is a Committed Payments Product but excluding mortgage indemnity insurance, GAP insurance, long term care insurance and free-standing term life products and investment products, warranty, auto insurance covering damage to car or property, personal accident, travel insurance, and health cash plan; or
- (b) any product (howsoever described) which provides for the suspension or forgiveness either temporarily or permanently of any sort of debt owing by a consumer,

in each case including any derivatives or variations of any such products and/or the administration and management of any such products.

“**Policies**” means the Payment Protection Products provided by GEFA Companies as either the primary insurer or provider or the reinsurer (including the existing product details set out in Schedule 1) and such Payment Protection Products which GECF Group Companies are authorised to market and sell and which are brought within the scope of

this agreement from time to time by the execution of an addendum and “**Policy**” shall be construed accordingly;

“**Potential New Business**” has the meaning given to it in clause 3.2.1;

“**Potential Substitute Business**” means any Potential New Business which falls within the criteria set out in Schedule 15 Substitute Business Criteria;

“**Previous Relevant Period**” means the period of 12 calendar months immediately preceding the Relevant Period;

“**Profit Share**” means the share (if any) of Underwriting Profits payable to or by a GECF Group Company in accordance with clause 6.1;

“**Profit Share Account**” has the meaning given to it in paragraph 1 of Schedule 3;

“**Quarterly Performance Meeting**” has the meaning given to it in Paragraph 1 of Part A of Schedule 6;

“**Regulatory Event**” means the receipt by a GEFA Company (the “**Affected GEFA Company**”) of a notice, from the Financial Services Regulator of the Territory in which the relevant GEFA Company operates, in which the Financial Services Regulator gives notice that it intends to revoke or suspend any authorisation required by the relevant GEFA Company to perform any of its obligations under this agreement or any Local Agreement to which it is a party;

“**Relevant Period**” means any period of 12 months during the Term starting on the first day of a calendar month and ending on the last day of the calendar month 12 months later;

“**Replacement Supplier**” means any entity succeeding a GEFA Company in the provision of Payment Protection Products substantially similar to those provided under this agreement;

“**Risk Loss Ratio**” means Ultimate Claims Cost divided by Earned Claims Fund;

“**Risk Rate**” means that part of a premium which covers the expected costs of claims;

“**Run-Off Period**” means the period commencing on the effective date of termination or expiration of this agreement and ending when GEFA certifies to GECF in writing that all risks under all Policies have expired and all valid claims under all Policies have been finalised, and no further Claims Reserves are required;

“**Sales Commission**” means in relation to:

- (a) Existing Business and Identified New Business, the proportion of Gross Written Premium payable by GEFA or a GEFA Company to GECC as shown in Schedule 1; and

- (b) New Direct Business and New Reinsurance Business, the proportion of Gross Written Premium as agreed between the relevant GECF Group Companies and the relevant GEFA Companies from time to time;

“**Scheme**” means a type or category of Policy marketed and sold by a GECF Group Company pursuant to this agreement and/or any Local Agreement;

“**Service Credits**” means the credits payable to the GEFCF Group in accordance with Schedule 2;

“**Service Levels**” means the service levels described in Schedule 2 as amended or varied in accordance with this agreement;

“**Substitute Business**” means Potential Substitute Business which following the procedure set out in Clause 9 and Schedule 16 becomes Substitute Business.

“**Supplemental Sales Commission**” shall have the meaning given to it in clause 5.3 and shall be calculated in accordance with Schedule 7;

“**Tax/levy**” means any tax, levy or stamp duty or any charge payable in respect of insurance premiums levied by any tax authority in any jurisdiction covered by this agreement to be charged to Insured Customers at the applicable rate from time to time including any similar, equivalent, additional or replacement tax, levy or charge which may be imposed on or in relation to insurers or insurance transactions from time to time;

“**Term**” means the period of 5 (five) years following the Commencement Date;

“**Territories**” means the countries comprising the Existing Territories and the New Territories, and the term “Territory” shall mean any one of these;

“**Ultimate Claims Cost**” means claims payments plus Claims Reserves for future claims payments under the relevant Policies as at the date the Claims Performance Statement described in Schedule 4 is calculated; and

“**Underwriting Profits**” shall have the meaning given to it in Schedule 3, paragraph 3(c).

## 1.2 Interpretation

The following rules apply unless the context requires otherwise:

1.2.1 “holding company” and “subsidiary” shall be construed in accordance with section 736 of the Companies Act 1985, “subsidiary undertaking” shall be construed in accordance with section 258 of the Companies Act 1985 and “associated company” shall be construed in accordance with section 416 of the Income and Corporation Taxes Act 1988;

1.2.2 the Interpretation Act 1978 shall apply to this agreement in the same way as it applies to an enactment;

10

---

1.2.3 the words “including”, “include” and “includes” shall mean “including without limitation”, “include without limitation” and “includes without limitation”, as the case may be;

1.2.4 a “person” includes any person, individual, company, firm, corporation, government, state or agency of a state or any undertaking or organisation (whether or not having separate legal personality and irrespective of the jurisdiction in or under the law of which it was incorporated or exists);

1.2.5 any reference to a party to this agreement includes its successors in title and permitted assignees;

1.2.6 words denoting the singular shall include the plural and vice versa and words denoting any gender shall include all genders;

1.2.7 references to any statute or statutory provision shall be construed as a reference to the same as it may have been, or may from time to time be, amended, modified or re-enacted;

1.2.8 references to recitals, clauses, paragraphs or schedules are to recitals, clauses and paragraphs of and schedules to this agreement. The schedules form part of the operative provisions of this agreement and references to this agreement shall, unless the context otherwise requires, include references to the recitals and the schedules;

1.2.9 references to any agreement shall be construed as a reference to that agreement as amended, varied, supplemented or assigned from time to time;

1.2.10 if there is any inconsistency between the schedules or any Addendum and the main body of this agreement, then to the extent necessary to resolve such inconsistency the main body of this agreement shall prevail;

1.2.11 the index to and the headings in this agreement are for information only and are to be ignored for the purposes of construing the same;

1.2.12 references to a statutory provision include any subordinate legislation made from time to time under that provision; and

1.2.13 if a word or phrase is defined, its other grammatical forms have a corresponding meaning.

### General Procurement Obligation

1.2.14 GECC shall procure that the GEFCF Group Companies fulfil their obligations under this agreement and comply with its terms.

11

---

## 2 Local Agreements

### 2.1 Local Addendums

The GEFCF Group Companies party to an Existing Local Agreement shall, and GEFA shall procure that the relevant GEFA Companies party to an Existing Local Agreement shall, promptly enter into a Local Addendum to amend their Existing Local Agreement to give effect to the provisions of this agreement mutatis mutandis (subject only to including amendments or further provisions necessary to ensure compliance with Applicable Laws), including:

2.1.1 clause 2.3;

2.1.2 clause 3.1 and 3.2 (in respect of Existing Business, Substitute Business and Potential Substitute Business);

2.1.3 clause 4;

- 2.1.4 clause 6.1.1;
- 2.1.5 clause 8;
- 2.1.6 clause 9.1, 9.2, 9.4 and Schedule 2;
- 2.1.7 clause 10.2;
- 2.1.8 clause 11;
- 2.1.9 clause 12.1;
- 2.1.10 clause 13;
- 2.1.11 clause 15;
- 2.1.12 clause 16.2 and Schedule 6 Part B;
- 2.1.13 clause 17;
- 2.1.14 clause 18;
- 2.1.15 clause 20.4;
- 2.1.16 clause 21.3;
- 2.1.17 clause 22;
- 2.1.18 clause 23; and
- 2.1.19 clause 24.

- 2.1.20 In respect of each Local Addendum, the assignment and subcontracting provisions incorporated by virtue of clause 2.1.14 above shall be supplemented by the addition of the following sub-clause:

*“Notwithstanding anything in this Clause [Assignment Clause], all of the rights and obligations of the Financial Assurance Company Limited under this Agreement shall automatically transfer to Financial New Life Company Limited upon the transfer scheme for the transfer of all or substantially all of Financial Assurance Company Limited’s business to Financial New Life Company Limited pursuant to section 105 Financial Services and Markets Act 2000 becoming effective (with such amendments, deletions or additions to the scheme as the parties to the scheme may approve).”*

- 2.1.21 GECC and GEFA shall procure that each Existing Local Agreement shall be amended to delete any provision which confers on any GECF Group Company which is a party to such Local Agreement any right to terminate such Local Agreement on a sale or disposal affecting the whole of or any part of any party to that Local Agreement (in either case, whether such sale or disposal is effected by way of an asset or business sale or a share sale or otherwise (including by the sale of a portfolio or by a change of the identity of the financing provider)).

## 2.2 Inconsistency between this Agreement and Local Agreements

Without prejudice to Clause 2.1, where there is a conflict or inconsistency between this agreement and a Local Agreement, the terms of this agreement shall prevail, except in relation to:

- (a) provisions in Local Agreements that are necessary to ensure compliance with Applicable Laws; and
- (b) provisions in Existing Local Agreements relating to sales commission, Retention Rates and the calculation of Profit Share,

and accordingly, GEFA will procure that each GEFA Company shall, to the extent relevant, comply with the provisions of this agreement and GECF will procure that each GECF Group Company shall, to the extent relevant, comply with the provisions of this agreement.

## 2.3 Term of Local Agreements

The Parties hereby agree and shall procure that notwithstanding the expiry dates specified in the Local Agreements, the term of each Local Agreement will be extended until close of business on the day preceding the fifth anniversary of the Commencement Date and shall not be varied during the Term unless both Parties agree otherwise.

## 3 Exclusive Appointment

### 3.1 Exclusive Appointment in respect of Existing Business

With effect from no later than the Commencement Date the GECF Group Companies shall appoint GEFA or the relevant GEFA Companies as their exclusive provider of Existing Payment Protection Products in the Existing Territories.

### 3.2 Exclusive Appointment in respect of Identified New Business and New Business and Substitute Business

- 3.2.1 Potential New Business shall consist of a GECF Group Company’s requirements for, in the case of an Existing Territory or New Territory:

- (a) New Payment Protection Products;

(b) Payment Protection Products to be provided to an Acquired GECF Business; or

(c) Identified New Business,

and any related services.

**3.2.2** Potential New Business shall become New Business in accordance with and subject to the provisions of Clauses 9.4 and Schedule 5. Potential Substitute Business shall become Substitute Business in accordance with and subject to the provisions of Clauses 9.4 and Schedule 16.

**3.2.3** Subject to clause 3.2.6, 20.4.1 and Schedule 5 and Schedule 15 (Potential Substitute Business), the relevant GECF Group Company shall appoint GEFA or the relevant GEFA Company as its exclusive provider of Payment Protection Products in the Territories in respect of New Business and Substitute Business.

**3.2.4** During the Term and in respect of Territories covered by a Local Agreement, GECC will ensure that no GECF Group Company other than in accordance with this agreement will offer to any third party or GECF Group Company customer any Payment Protection Product in any Territory which is in competition with, or interferes with or restricts the sale or provision of any Payment Protection Product provided by GEFA or any GEFA Company pursuant to the relevant Local Agreement;

provided that nothing in this Clause 3.2.4 shall prevent:

(i) the GECF Captive from providing Payment Protection Products in the Territory provided that it does so in accordance with the terms of clause 5.2 of this agreement;

14

---

(ii) any New Captive from providing on an ongoing basis Payment Protection Products in the relevant Territory to third parties and customers of the Acquired GECF Business of which it forms part. Save as provided in this agreement, the New Captive shall not supply Payment Protection Products to GECF Group Companies other than the Acquired GECF Business of which it forms part; and

(iii) GECF Group Companies from concluding arrangements pursuant to Clause 9.4.6.

**3.2.5** Schedule 1C sets out in respect of all Identified New Business production estimates and whether premiums are single or monthly \*\*.

(i) In respect of Potential New Business (where an addendum to a Local Agreement or a New Local Agreement in respect of such Potential New Business has been agreed pursuant to Schedule 5):

(a) The GECF Group Companies shall not \*\* relating to the provision of Payment Protection Products (where such \*\* would be in breach of an addendum to a Local Agreement or a New Local Agreement as agreed pursuant to Schedule 5); and

(b) The GECF Group Companies shall not unless GEFA requests be required to \*\* any \*\* the \*\* of their \*\*. If GEFA requests a relevant GECF Group Company to \*\* relating to the provision of Payment Protection Products other than upon \*\*, such relevant GECF Group Company shall do so in accordance with the terms of the relevant arrangement and on condition that:

(I) if such \*\* relates to Identified New Business, GEFA \*\* the relevant GECF Group Company for \*\* of which GEFA was aware at the Commencement Date \*\* by the relevant GECF Group Company specifically in relation to such \*\*; or

(II) if such \*\* relates to New Business (not being Identified New Business), GEFA \*\* the relevant GECF Group Company for \*\* incurred by the relevant GECF Group Company as a consequence of \*\* and any \*\* pursuant to the relevant agreement.

(ii) In respect of Potential New Business (where an addendum to a Local Agreement or a New Local Agreement in respect of such Potential New Business has been agreed pursuant to Schedule 5), the relevant GECF Group Company agrees that subject to Clause 3.2.5(i)(b), where expressly permitted in the relevant arrangement, it shall use all

15

---

reasonable endeavours to \*\*, and the GECF Group Companies shall use all reasonable endeavours to \*\*, any and all \*\* relating to the provision of Payment Protection Products.

**3.2.6** Where GECC or a GECF Group Company acquires a business or establishes any joint venture or partnership or any other business relationship in a Territory (an “**Acquired GECF Business**”) GECC shall, and GECC or the relevant GECF Group Company shall, use its reasonable efforts to ensure that the terms of the acquisition or establishment of the Acquired GECF Business neither \*\*:

(a) GECC from \*\* that the Acquired GECF Business appoint a \*\* as its \*\*; and

(b) the Acquired GECF Business from \*\* as its \*\*.

In the event that GECC or the relevant GECF Group Company is, notwithstanding their reasonable efforts, unable to negotiate the terms of the acquisition or establishment of the Acquired GECF Business without the inclusion of \*\* which fall within paragraphs (a) and/or (b) above, GECC shall, and shall procure that the relevant GECF Group Company shall, use its reasonable efforts to procure that the terms of the acquisition or establishment \*\* as closely as reasonably possible \*\* as set out in this agreement that \*\* shall be appointed \*\* to the \*\*. Such efforts shall include \*\* to the maximum extent reasonably possible the terms of the acquisition or establishment which relate to:

(i) the \*\* to which such arrangements apply;

(ii) the \*\* of such arrangements; and

(iii) the \*\* of such arrangements.

**3.2.7** GECC undertakes that it shall not acquire an interest in or establish, or take any steps to acquire an interest in or establish, any joint venture or partnership or any other business relationship (or permit any GECF Group Company to do any such thing) with the intention of avoiding any of its obligations under this agreement.

- 3.2.8 GECC represents and warrants to GEFA that all Identified New Business is owned as to 100 per cent. by GECC or the relevant GECF Group Company.
- 3.2.9 In the event of a termination of a Local Agreement, the relevant GECF Group Company which was party to such Local Agreement shall no longer be required to appoint, a GEFA Company as its exclusive provider of Payment Protection Products provided under that Local Agreement in a Territory. Where as a result of such termination there are no Local Agreements in the Territory then the requirements of this Clause 3 on GECC and the GECF Group Companies shall no longer apply in respect of that Territory.

#### 4 Regulatory Requirements

- 4.1 GEFA shall, and shall procure that each GEFA Company shall, and each GECF Group Company shall, have in place appropriate policies and procedures to ensure observation of and compliance with all Applicable Laws (including, all current and any future regulatory requirements, all applicable accounting rules and all codes of practice applicable to its Business activities in each relevant Territory) in the performance of their respective obligations, or the exercise of its rights, under or in connection with this agreement or Local Agreement, as the case may be, from time to time.
- 4.2 In the event that there are any changes to an applicable regulatory regime within a Territory which will impact on the sale or distribution of Payment Protection Products under this agreement or the ability of GEFA or a GEFA Company to meet its Service Level obligations, GEFA shall inform GECC, as soon as reasonably practicable after such change, and the Parties shall work together to agree a plan to enable the Parties to continue to perform their obligations under this agreement (the "Remediation Plan"). If the parties cannot agree a Remediation Plan within 10 Business Days of notice by GEFA, then the matter will be referred to the dispute resolution procedure in Clause 15.
- 4.3 The Parties agree that if as a result of any changes in applicable law, regulation or regulatory requirements or GECC re-organisation:
- (a) the Tax/ levy in a Territory increases, any such increase shall be absorbed by the relevant GECF Group Company in that Territory; and/or
  - (b) any GEFA Company is required to vary the level of regulatory capital maintained by it in respect of any Payment Protection Products underwritten and/or provided by GEFA pursuant to this agreement or any Local Agreement then GECC shall send to GEFA a written proposal setting out the steps to be taken so as to ensure that the relevant GEFA Company's regulatory capital requirement is the same as it was before any such changes. Within 5 Business Days of the date of issue of such proposal, the Parties shall commence working together with each using its best efforts to implement the proposal unless, before the expiry of such period of 5 Business Days, GEFA informs GECC in writing that, in its reasonable opinion, GEFA considers that the proposal will not have the effect of ensuring that the relevant GEFA Company's regulatory capital requirement is the same as it was before such changes, in which case the Parties shall negotiate in good faith such amendments to the proposal as are necessary to achieve this effect. If the Parties fail to agree the necessary amendments to the proposal within 30 Business Days of the date of commencement of the negotiations, the changes to pricing shall be effected by the application of the provisions of Schedule 4.

#### 4.4 Benefits of Changes

If the parties jointly devise a method (whether under clause 4.3 above or otherwise) which improves GEFA's and/or a GEFA Company's regulatory capital requirement as regards Payment Production Products provided pursuant to this agreement, GECC shall be entitled to the financial benefit of such improvement in regulatory capital requirement.

#### 5 Financial Terms

##### 5.1 Existing Direct Business and Substitute Business

Subject to clause 2, the Parties agree that all Existing Direct Business and Substitute Business shall continue to be underwritten on the terms set out in the Existing Local Agreements, as detailed in Part A of Schedule 1.

##### 5.2 Existing Reinsured Business

5.2.1 Subject to clauses 2 and 5.2.2 the Parties agree that the Existing Reinsured Business shall continue on the terms set out in Part B of Schedule 1.

5.2.2 When GECC has established the GECF Captive and the necessary arrangements are in place to allow the primary reinsurer to cede to GEFI Guernsey, the Existing Reinsured Business shall be migrated to become New Reinsurance Business (in accordance with Clause 5.6). Each Scheme to be migrated, and the timetable for such migration, shall take effect according to the terms of proposals which shall be issued in writing from GECC to GEFA promptly upon the necessary arrangements being put in place, unless GEFA within 10 Business Days of the issue of any such proposal sends notice in writing to GECC that it, in its reasonable opinion, considers the terms or timetable for the relevant migration to be impractical, in which case the Parties shall negotiate in good faith such amendments to the relevant proposal as are necessary to allow the relevant Existing Reinsured Business to be migrated to the New Reinsurance Business to the satisfaction of the Parties, such Schemes continuing on the terms of Existing Business until the Parties reach agreement. Those Schemes that are not migrated will continue on the terms of Existing Reinsured Business in Schedule 1. For the avoidance of doubt, once any Existing Reinsured Business has been migrated it will still form part of the volume incentive calculations referred to in clause 5.3 below.

5.2.3 The Parties agree and acknowledge that, in some of the Existing Business, GEFA or a GEFA Company acts as either the direct insurer or as a reinsurer to a primary insurer selected by GECC (the "**Existing Reinsurance Arrangements**"). GECC agrees that following termination of the Existing Reinsurance Arrangements with the primary insurer in accordance with clause 5.2.1, it will ensure that GEFA's or a GEFA Company's quota share is the same as that which existed under the previous primary insurer arrangements.

##### 5.3 Volume Incentive

If the aggregate of the Gross Written Premium attributable to the Existing Direct Business, the Gross Written Premium for the Existing Reinsured Business and the Gross Written Premium attributable to any Substitute Business is in excess of Euro \*\* million (the "**Incentive Threshold**") per calendar year as calculated in accordance with Schedule 7, then GEFA shall pay, or procure payment by the relevant GEFA Company, to GECC or its nominee as notified by GECC to GEFA from time to time a supplemental sales commission calculated on the amount of Gross Written Premium attributable to the Existing Direct Business in excess of the Incentive Threshold in accordance with Schedule 7 (the "**Supplemental Sales Commission**"). Any Supplemental Sales Commission due to GECC under this



clause shall be paid annually in arrears within 100 days of the calendar year-end, with the first such payment being due to GECC within 100 days of 31st December 2004. For the avoidance of doubt, no Supplemental Sales Commission shall be payable in respect of Gross Written Premium for the calendar year ending 31st December 2003.

#### 5.4 New Business

5.4.1 New Business may be New Direct Business or New Reinsurance Business as determined in accordance with Schedule 5.

5.4.2 Any New Local Agreement entered into relating to New Business in a Territory where there is no Local Agreement shall be in the form set out in Schedule 12 and shall give effect to the following provisions of this agreement, subject to the Applicable Laws:

- (a) the term of the New Local Agreement shall be from the date of the New Local Agreement and expire on 31 December 2008;
- (b) clause 3.2;
- (c) clause 4;
- (d) clause 5.5 or 5.6 (as applicable);
- (e) clause 6.1.2 and Schedule 3;
- (f) clause 8;
- (g) clause 9.1, 9.2, 9.4 and Schedule 2;
- (h) clause 10.2;
- (i) clause 11;
- (j) clause 12.2;

19

---

- (k) clause 13;
- (l) clause 15;
- (m) clause 16.2 and Schedule 6 Part B;
- (n) clause 17;
- (o) clause 18;
- (p) clause 20.4;
- (q) clause 21.3;
- (r) clause 22;
- (s) clause 23; and
- (t) clause 24.

(u) In respect of each New Local Agreement, the assignment and subcontracting provisions incorporated by virtue of clause 5.4.2(q) above shall be supplemented by the addition of the following sub-clause:

*"Notwithstanding anything in this Clause [Assignment Clause], all of the rights and obligations of the Financial Assurance Company Limited under this Agreement shall automatically transfer to Financial New Life Company Limited upon the transfer scheme for the transfer of all or substantially all of Financial Assurance Company Limited's business to Financial New Life Company Limited pursuant to section 105 Financial Services and Markets Act 2000 becoming effective (with such amendments, deletions or additions to the scheme as the parties to the scheme may approve)."*

(v) For the avoidance of doubt, no New Local Agreement shall contain any provision which confers on the GECF Group Company which is a party to such Local Agreement any right to terminate such Local Agreement on a sale or disposal affecting the whole of or any part of any party to that Local Agreement (in either case, whether such sale or disposal is effected by way of an asset or business sale or a share sale or otherwise (including by the sale of a portfolio or by a change of the identity of the financing provider)).

Once executed, this shall become a "**New Local Agreement**".

5.4.3 The Parties agree that in respect of Identified New Business and New Business in Territories subject to a Local Agreement, the relevant GECF Group Company shall, and GEFA shall procure that the relevant GEFA Company shall, either:

20

---

- (i) enter into an addendum or variation to the Local Agreement and that, subject to Clauses 5.5 and 5.6 below, such Identified New Business or New Business shall be subject to the terms of that Local Agreement; or
- (ii) enter into a New Local Agreement.

#### 5.5 New Direct Business

Subject to Paragraph 5.2.2 of Part A of Schedule 5, New Direct Business will be subject to a GEFA Retention Rate of \*\* per cent. of Gross Written Premium and a \*\*

**5.6** New Reinsurance Business

**5.6.1**

- (a) Subject to Paragraph 5.2.2 of Part A of Schedule 5, when all necessary arrangements are in place with the primary reinsurer GECC will ensure that all Net Premium is duly ceded to GEFI Guernsey and that GEFI Guernsey receives a Retention Rate of \*\*% of Gross Written Premium.
- (b) In respect of all New Reinsurance Business, GEFA will pay the primary reinsurer \*\*\* Profit Share. It is GECC's responsibility to ensure that all necessary arrangements are in place with the primary reinsurer to ensure GECC receives any monies owing to GECC from the primary reinsurer under any arrangement or agreement between the primary reinsurer and GECC. Neither GEFA or any GEFA Company shall have any liability or responsibility in respect of any monies owing between the primary reinsurer and GECC or to ensure any payments are made to GECC.
- (c) In the event that the New Reinsurance Business arrangements are not capable of being established in accordance with this clause 5.6 or cease to be effective for any reason during the Term, including for legal or regulatory prohibitions, then all New Reinsurance Business shall revert to either the Existing Business terms or New Direct Business terms, at the discretion of GECC which shall be communicated in writing to GEFA promptly following any such failure and which decision shall be binding upon GEFA unless, within 20 Business Days of the notice from GECC, GEFA (acting reasonably) objects in writing to the decision of GECC, in which case the matter shall be referred to the next Quarterly Performance Meeting for good faith negotiations between the Parties. Where, in the process of any good faith negotiations, the Parties agree a structure substantially similar to the current structure whereby the relevant GEFA Company acts as a reinsurer (whether primary, secondary or other), the Retention Rate will be that referred to in Clause 5.6.1(a). If any other structure is proposed then the Parties will enter into good faith negotiations to agree the pricing structure, taking into account all relevant

---

factors including any capital adequacy requirements of the relevant GEFA Company and GECF Group Company.

**6 Pricing - Profit Share and Financial Performance**

**6.1** Profit Share - calculation and payment

- 6.1.1** The Parties agree that in respect of Existing Business, the calculation, payment and treatment of Profit Share during the term of and after termination or expiry of the Local Agreement shall continue in accordance with the terms of the relevant Local Agreement.
- 6.1.2** The Parties agree that in respect of New Business, the relevant GECF Group Companies shall and GEFA shall procure that the relevant GEFA Companies shall incorporate terms for the calculation, payment and treatment of Profit Share in respect of the New Business in the relevant New Local Agreements in accordance with Schedule 3.

**6.2** Financial Performance

The Parties agree to monitor the performance of the Payment Protection Products provided under this agreement in each Territory in accordance with the procedures set out in Schedule 4.

**7 Marketing**

Any marketing expenditure shall be determined between the Parties at a Territory level based on a cost / benefit analysis.

**8 Non Solicit**

During the Term, GEFA will ensure that no GEFA Company or member of Genworth Financial Inc.'s Group (with the exception of any GECF Group Companies) will directly canvass or solicit the custom of any customer of a GECF Group Company in any Territory in respect of any Payment Protection Product without the express written consent of GECC. GECC accepts that GEFA and any GEFA Company may notwithstanding this Clause 8 or any other provision of this agreement indirectly provide Payment Protection Products to a customer of a GECF Group Company via GEFA or a GEFA Company client or customer.

**9 Service Levels, Service Credits, Product Development and Good Industry Practice**

**9.1** Service Levels and Service Credits

- 9.1.1** The Parties hereby agree that GEFA shall procure that the GEFA Companies comply with the Service Levels in accordance with Schedule 2.

- 
- 9.1.2** Without prejudice to GECC's or any GECF Group Company's other rights or remedies under this agreement, GEFA shall procure that if a GEFA Company fails to meet the Key Service Levels, Service Credits shall be applied in accordance with Schedule 2.

- 9.1.3** The provisions of clause 9.1.2 shall not apply in respect of breaches of Key Service Levels that occur within the first 6 months of the Term.

**9.2** Good Industry Practice

- 9.2.1** GEFA shall, and shall procure that the GEFA Companies shall, carry out their respective obligations under this agreement and the Local Agreements in accordance with Good Industry Practice.

- 9.2.2** GEFA shall, and shall procure that the GEFA Companies shall, ensure that in the performance of their obligations they remain Best in Class throughout the Term. Any productivity gains or costs associated with remaining Best In Class shall be for the account of GEFA or the relevant GEFA Company.

**9.3** Service Level Review

- 9.3.1** Without limiting any other obligations under this agreement, on or before 90 days prior to each anniversary of the Commencement Date, the Parties shall review the Service Levels and shall amend them to ensure the Service Levels are and remain Best in Class. Where such amendments are required, they shall be implemented by GEFA with effect from the anniversary of the Commencement Date.

- 9.3.2 GECC may engage a third party for the purposes of conducting a review of the kind described in Clause 9.3.1. GECC shall procure that the third party (the “**Independent Consultant**”) executes a confidentiality agreement in a form reasonably acceptable to GEFA.
- 9.3.3 GEFA must make available a suitably qualified and experienced employee for up to ten days per annum to provide all necessary data and other information to GECC and any Independent Consultant engaged by GECC for the purposes of completing the review under Clause 9.3.1.
- 9.3.4 If the Parties are not able to reach agreement on amendments required to the Service Levels in accordance with Clause 9.3.1, then that issue may be referred by either party to the Dispute procedure set out in Clause 15 for resolution.

#### 9.4 Product Development and Marketing

9.4.1 GEFA shall, or shall procure that the GEFA Companies shall, offer to the GECF Group Companies all:

- (a) Payment Protection Products;

23

- (b) features of such Payment Protection Products; and

- (c) related marketing services,

that are offered to consumers in the relevant Territory.

9.4.2 GEFA shall, or shall procure that the GEFA Companies shall, produce a quarterly report advising the GECF Group Companies on the latest market developments in respect of Payment Protection Products and advising the GECF Group Companies on new products, new product features and new marketing channels and methods that GECF Group Companies should consider adopting in order to be a market leading provider of Payment Protection Products.

9.4.3 Any GECF Group Company may at any time request that GEFA or a GEFA Company provide any Payment Protection Products, features of Payment Protection Products (provided that such features are not mutually exclusive) and/or related marketing services whether or not contained in the reports prepared by any GEFA Company pursuant to Clause 9.4.2 (together “**Offering(s)**”) that any GECF Group Companies wish GEFA or any GEFA Company to provide.

9.4.4 In respect of each Offering(s) requested by any GECF Group Company, GEFA will as soon as reasonably practicable and in any event not later than 20 Business Days after receiving the request either:

- (a) provide the relevant GECF Group Company with a product development plan (“**Product Development Plan**”) for the creation and delivery of the relevant Offering(s). The Product Development Plan will:
- (i) identify (with an explanation and reference to Schedule 15) whether the Offering will be considered as Potential New Business or Potential Substitute Business for the purpose of this agreement;
  - (ii) include a detailed specification of the Payment Protection Product, the features of the Payment Protection Product and/or related marketing services (as the case may be) that the relevant GECF Group Company wants included in the Offering and/or GEFA would be prepared to develop (the “**GEFA Proposal**”);
  - (iii) provide a reasonable timeframe for the creation and delivery of the Offering and/or the GEFA Proposal as the case may be, taking into consideration the complexity of the products and services, the regulatory environment in the relevant Territory, and the need for the GECF Group Companies to maintain their position as a market leading provider of Payment Protection Products. The relevant GECF Group Company shall not unreasonably withhold or delay its agreement to such timeframe; or

24

- (b) decline to develop the Offering in which case they will also provide detailed written reasons for declining to develop the Offering.

The relevant GECF Group Company shall provide such information as the relevant GEFA Group Company shall reasonably request in order for the relevant GEFA Company to formulate its response pursuant to this Clause 9.4.4. Such information shall be deemed to form part of the Offering.

9.4.5 If GEFA provides the relevant GECF Group Company with a Product Development Plan which includes a GEFA Proposal pursuant to Clause 9.4.4(a)(ii) then:

- (i) the relevant GECF Group Company may accept the GEFA Proposal in which case it shall then notify GEFA that it intends to substitute the GEFA Proposal for the relevant Offering(s) and proceed in accordance with Clause 9.4.9; or
- (ii) the relevant GECF Group Company may reject the GEFA Proposal and then proceed in accordance with Clause 9.4.6.

9.4.6 Where the relevant GECF Group Company rejects the GEFA Proposal or GEFA declines to develop any Offering(s), subject to 9.4.14, GECC and the relevant GECF Group Company shall have no obligation to appoint GEFA or any GEFA Company as its exclusive provider in respect of the relevant Local Agreement in respect of the Offering(s) and GECC and the relevant GECF Group Company shall be free to enter into discussions, tenders, negotiations, arrangements and agreements with third parties and/or other GECF Group Companies in respect of the relevant Offering(s). The relevant GECF Group Company shall invite GEFA to take part in any subsequent tender process conducted by the relevant GECF Group Company in respect of the Offering(s) provided that GEFA agrees and shall procure that the relevant GEFA Company agrees that the provisions for determining the Retention Rate and the Risk Rate for the Offering as set out in Part II or Part III (as the case may be) of Schedule 16 (Business Proposal Pricing Process) shall apply to their submission save that, if an Actuary were to determine the Risk Rate pursuant to Paragraphs 5 or 9.2 of Schedule 16 (as the case may be), then the relevant GECF Group Company or the relevant GEFA Company would be entitled to reject the proposed Risk Rate. In either case, the relevant GECF Group Company would be entitled to award the tender to any third party.

9.4.7 GEFA’s submission in accordance with Clause 9.4.4 shall be considered to be the creation of a “Product Development Plan” for the purpose of GEFA’s compliance with Paragraph 6.3 of Part A of Schedule 5;

9.4.8 If the Parties cannot agree whether the Offering constitutes Potential New Business or Potential Substitute Business then the Parties shall refer the matter to

- 9.4.9 The relevant GECF Group Company will then review the Product Development Plan and where the Offering constitutes:
- (a) Potential New Business the Parties will initiate the process set out in Schedule 5 (for New Business); or
  - (b) Potential Substitute Business, the Parties will initiate the process set out in Schedule 16 (for Substitute Business).
- 9.4.10 Where Potential Substitute Business is determined through the Schedule 16 process to be Substitute Business or Potential New Business is determined pursuant to the process in Schedule 5 to be New Business (as the case may be) GEFA shall, or shall procure that the relevant GEFA Company shall, make the Offering (including any amendments thereto agreed between the Parties) available to the relevant GECF Group Company in accordance with the terms of the Local Addendum or New Local Agreement agreed between the Parties.
- 9.4.11 Where the relevant GEFA Company and GECF Group Company are unable to agree on whether the timetable set out in the Product Development Plan is reasonable, having regard to the factors set out in Clause 9.4.4(a)(iii), either Party may refer the matter to the dispute resolution procedure set out in Clause 15.
- 9.4.12 Where the Offering is (i) Potential Substitute Business and is determined not to be Substitute Business pursuant to Schedule 16; or (ii) Potential New Business and is determined not to be New Business pursuant to the process set out in Schedule 5 then (subject to Clause 9.4.13 and 9.4.14) GECC and the relevant GECF Group Company shall have no obligation to appoint GEFA or any GEFA Company as its provider, whether exclusive or otherwise, in respect of the relevant Local Agreement in respect of the Offering and GECC shall be free to enter into discussions, tenders, negotiations, arrangements and agreements with third parties and/or other companies in the GECF Group in respect of the relevant Offering.
- 9.4.13 If GEFA or a GEFA Company make a GEFA Proposal in accordance with Clause 9.4.4 and the relevant GECF Group Company at any time during the Term of the relevant Local Agreement pursuant to which the GEFA Proposal was made decides to implement the GEFA Proposal with a third party, then the relevant GECF Group Company shall be required to make a request pursuant to Clause 9.4.3 of the agreement.
- 9.4.14 Where a tender process results pursuant to Clause 9.4.6 or 9.4.12, if:
- (i) a change is proposed to the Offering(s) during the tender process; and
  - (ii) the result of such change is that the reason GEFA declined to develop the Offering no longer applies,
- then the relevant GECF Group Company shall notify the relevant GEFA Company and both Parties shall be obliged to follow the procedure in Clause 9.4.3,

save that Clause 9.4.4(b) shall not apply and the GEFA Company shall not have the option of providing a GEFA Proposal pursuant to Clause 9.4.4(a)(ii). For the avoidance of doubt, the tender process shall not be reactivated until such time as the GECF Group Company would be entitled to proceed to tender pursuant to Schedule 5 or Schedule 16.

- 9.4.15 The Parties shall from time to time throughout the term of this agreement conduct a benchmarking exercise in respect of the Payment Protection Products and related marketing services provided pursuant to this agreement and GEFA's obligations pursuant to Clauses 9.4.1 and 9.4.2.
- 9.4.16 Any benchmarking exercise must be initiated and conducted in accordance with Schedule 14.
- 9.4.17 The first benchmarking exercise shall be completed by 30 September 2004 and subsequent benchmarking exercises shall be carried out at six month intervals thereafter.
- 9.5 In the event that GECC or a GECF Group Company considers that GEFA or a GEFA Company is failing to comply with its obligations under clauses 9.2, 9.4.1 and 9.4.2, the Parties shall discuss the issue at the next following monthly meeting held in the relevant Territory pursuant to paragraph 2 of part B of Schedule 6. If the relevant representatives attending such meeting are unable to agree the action to be taken to resolve the issue, the matter shall, within 10 Business Days of such failure to agree, be referred to the Relationship Managers of GECC and GEFA who shall negotiate in good faith to resolve the matter.

## 10 Intellectual Property, Data and Data Protection

### 10.1 Licence of Intellectual Property

- 10.1.1 GECC licenses the GECF Marks to GEFA and the GEFA Companies for the Term and during the Run-Off Period for the purposes of this agreement in the Territories. All use of GECF Marks pursuant to this clause shall be subject to and in accordance with any trade mark use guidelines notified to GEFA by GECC in writing from time to time.
- 10.1.2 GEFA licenses the GEFA Marks to GECC and the GECF Group Companies for the Term and during the Run-Off Period for the purposes of this agreement in the Territories. All use of the GEFA Marks pursuant to this clause shall be subject to and in accordance with any trade mark use guidelines notified to GECF by GEFA from time to time in writing. For the avoidance of doubt, GECC has no obligation to use the GEFA Marks.
- 10.1.3 GECC shall indemnify GEFA and each member of the GEFA Group (each an "Indemnified Person") in respect of any loss, cost, damage, liability or expense (including reasonable legal fees) suffered or incurred by an Indemnified Person in connection with any claim or action brought against that Indemnified Person to

the effect that the use of the GECF Marks infringes the intellectual property rights of any third party, provided that (i) notice is given of any such claim or action so as to permit the person who owns the GECF Marks to assume and control the defence thereof and (ii) the person seeking to be indemnified under this clause does not enter into any settlement with respect to or compromise any such claim or action without the indemnifying party's prior written consent.

- 10.1.4 GEFA shall indemnify GECC and each member of the GECF Group (each an "Indemnified Person") in respect of any loss, cost, damage, liability or

expense (including reasonable legal fees) suffered or incurred by an Indemnified Person in connection with any claim or action brought against that Indemnified Person to the effect that the use of the GEFA Marks infringes the intellectual property rights of any third party, provided that (i) notice is given of any such claim or action so as to permit the person who owns the GEFA Marks to assume and control the defence thereof and (ii) the person seeking to be indemnified under this clause does not enter into any settlement with respect to or compromise any such claim or action without the indemnifying party's prior written consent.

- 10.1.5** Each Party (each individually a “Using Party”) acknowledges that all goodwill associated with the use by it of each of the GECF Marks or the GEFA Marks (as applicable) vests and shall vest in the owner of such mark and that the Using Party has no, and shall not by virtue of this agreement obtain any, rights in any of the GECF Marks or the GEFA Marks (as applicable) other than (to the extent owned by or licensed to the Using Party) as is necessary to fulfil its obligations hereunder. The Using Party undertakes that it shall make no claim to such goodwill and shall make no use of any of the GECF Marks or the GEFA Marks (as applicable) save as necessary to fulfil its obligations hereunder.
- 10.1.6** Without prejudice to clause 10.1.5, if any goodwill or proprietary right in relation to any of the GECF Marks or the GEFA Marks (as applicable) vests in the Using Party, the Using Party shall, immediately upon becoming aware of the vesting of such goodwill or right, assign, or procure the assignment of, such goodwill or right to the owner of such mark.
- 10.1.7** The Using Party shall within a reasonable time notify the other party (such notification to be accompanied by all relevant information which is in its possession) if at any time during the term of this agreement the Using Party is aware that any passing-off, infringement or act of unfair competition in relation to, or challenge to the validity of or proceedings for rectification in respect of, any of the GECF Marks or GEFA Marks (as applicable) is occurring, threatened or likely. The Using Party shall not have any right to take proceedings in respect of any infringement of the GECF Marks or GEFA Marks (as applicable) and neither shall the owner of any of the relevant marks be obliged to bring such proceedings.

---

28

## **10.2 Ownership of Intellectual Property Rights**

- 10.2.1** GEFA acknowledges and shall procure that the GEFA Companies acknowledge that intellectual property rights arising in materials created by a GEFA Company specifically for a GECF Group Company in connection with the provision of the Payment Protection Products pursuant to this agreement shall vest in the relevant GECF Group Company. GEFA shall assign and shall procure that the GEFA Companies shall assign all rights in and to such intellectual property rights to the relevant GECF Group Company.
- 10.2.2** On the relevant GECF Group Company's request, GEFA shall and shall procure that the GEFA Companies shall execute any formal assignment or document required to give effect to Clause 10.2.1 and shall provide all reasonable assistance required by the relevant GECF Group Company to perfect, protect, defend or assert its interests in such intellectual property rights.

## **10.3 Ownership of Data**

- 10.3.1** Save where expressly agreed otherwise in this agreement, all intellectual property rights (including database rights) and any other rights of whatever nature in the personal data and proprietary information of GEFA or any member of the GEFA Group (whether or not personal data as defined in the applicable data protection legislation in each Territory) disclosed by GEFA or any member of the GEFA Group to GECC or any member of the GECF Group under or in relation to this agreement shall remain at all times the property of GEFA or the relevant member of the GEFA Group.
- 10.3.2** Save where expressly otherwise agreed, all intellectual property rights (including database rights) and any other rights of whatever nature in the personal data and proprietary information of GECC or any member of the GECF Group (whether or not personal data as defined in the applicable data protection legislation in each Territory) disclosed by GECC or any member of the GECC Group to GEFA or any member of the GEFA Group under or in relation to this agreement shall remain at all times the property of GECC or the relevant member of the GECF Group.
- 10.3.3** During the Term and following termination or expiry of this agreement, GEFA undertakes and shall procure that the GEFA Companies undertake not to use data or information supplied by a GECF Group Company or received under the terms of this agreement or a Local Agreement other than for the purposes of performing their obligations under this agreement or the relevant Local Agreement (as the case may be) and for risk modelling and profiling purposes. GEFA shall not, and shall procure that the GEFA Companies shall not, use any data or information supplied by a GECF Group Company or received under the terms of this agreement or a Local Agreement:

---

29

- (a) for marketing purposes including, without limitation, producing marketing information containing information concerning GECF Group Company clients (even if anonymised); or
- (b) for the purposes of directly or indirectly canvassing or soliciting the custom of any customer of the GECF Group.

## **11 Data Protection**

- 11.1** For the purposes of this clause 11, where terms and expressions used are not defined in this agreement they shall have the meaning assigned to them in the Data Protection Act 1998.
- 11.2** GEFA shall, and shall procure that the GEFA Companies shall and GECC and the GECF Group Companies shall, in performing their obligations under this agreement, comply in all respects with the Data Protection Legislation and otherwise in accordance with this clause 11.
- 11.3** Where either a GEFA Company or a GECF Group Company Processes Personal Data under this agreement GEFA or GECF, as appropriate, shall procure that the relevant GEFA Company or GECF Group Company shall:
- (i) take appropriate technical and organisational measures against the unauthorised or unlawful processing of the Personal Data and against actual loss or destruction of, or damage to, the Personal Data, having regard to the state of technological development and the cost of implementing any measures, the measures must ensure a level of security appropriate to the harm that might result from unauthorised or unlawful processing or accidental loss, destruction or damage and the nature of the Personal Data;
  - (ii) process the Personal Data only in accordance with this agreement, the relevant GECF Group Company's or GEFA Company's instructions and having regard to the provisions of the Data Protection Legislation, or as is required by law or any relevant regulatory body in each Territory;
  - (iii) notify the relevant GECF Group Company or GEFA Company if it breaches its obligations under the Data Protection Legislation in connection with this agreement or a Local Agreement and such breach is investigated by the data protection regulator in the relevant Territory; and

- (iv) refrain from disclosing the Personal Data in respect of individuals with the EEA to any third party or transferring the Personal Data obtained or processed within the EEA, outside the EEA (other than to such jurisdiction as GEFC or GEFA may agree, such agreement not to be unreasonably withheld or delayed, or as otherwise required by Applicable Law) except in accordance with the written instructions of the relevant GEFC Group Company or GEFA Company.

11.4 The relevant GEFA Company or GEFC Group Company may disclose the Personal Data to those of its employees and others (including contractors) as it reasonably considers necessary for the performance of its obligations under this agreement. The relevant GEFA Company or GEFC Group Company shall take reasonable steps to ensure the reliability of employees who have access to the Personal Data and ensure that such employees and contractors are aware of the relevant GEFA Company's or GEFC Group Company's obligations under this agreement and the Data Protection Legislation.

## 12 Gross Written Premiums and Collection

### 12.1 Existing Business

The Parties agree that the determination of and collection of Gross Written Premiums in respect of the Policies sold in the Existing Business shall continue in accordance with the terms of the relevant Existing Local Agreement.

### 12.2 New Business

The Parties agree that, in respect of Identified New Business and New Business, the relevant GEFC Group Companies shall, and GEFA shall procure that the relevant GEFA Companies shall, agree and incorporate terms in the relevant New Local Agreement for the determination and collection of Gross Written Premiums in respect of the Policies sold in the New Business. Such terms shall include a provision to the effect that, where the GEFC Group Company collects Gross Written Premiums, it shall collect from the Insured Customers the Tax/levy element thereof.

## 13 Cancellations and Cancellation Fees

13.1 The Party responsible for calculating and making refunds to Insured Customers in respect of each sales channel shall be specified in the Local Agreements.

13.2 The relevant GEFC Group Companies shall, and GEFA shall procure that the relevant GEFA Companies shall, have good faith discussions to agree a cancellation fee (other than any cancellation fees due in the event of re-financing) to be charged to Insured Customers in the event of a cancellation of their Policy by the Insured Customer (provided cancellation fees are not prohibited by the Applicable Laws of the relevant Territory) in order to reflect the increased administration charges incurred by both the relevant GEFC Group Company and the relevant GEFA Company and the cancellation terms on which they will share such cancellation fee (subject to local Applicable Laws).

## 14 Default Interest

If any Party fails to pay any amount payable by it under this agreement, the other shall be entitled to interest on the overdue amount, payable forthwith upon demand from the due date until the date of actual payment, both before and after judgment, at the rate of 2 per cent. per annum above the base rate from time to time of Barclays Bank plc. Such interest shall accrue on a daily basis and shall be compounded quarterly. All sums payable under this agreement shall be paid in Euros.

## 15 Relationship Managers, and Informal Dispute Resolution and Arbitration

15.1 GEFA on the one hand and GECC on the other shall each appoint a representative (the "Relationship Managers") who shall be primarily responsible for the day to day co-ordination and management of this agreement and the Business relationship between the Parties. Each Party shall notify the other in writing of the identity of its Relationship Manager. The Relationship Managers may delegate any and all of their responsibilities to appropriate representatives. Each Party shall procure that its Relationship Manager and/or representative shall devote sufficient time and attention to his or her duties and responsibilities and shall be available to the other at all reasonable times.

15.2 It is the intention of the Parties that any Dispute (as defined below), shall be settled amicably between the Parties as quickly as possible and accordingly:

15.2.1 where a Dispute arises in relation to a Local Agreement, the relevant GEFC Group Company shall, and GEFA shall procure that the relevant GEFA Company shall, first refer such Dispute to the respective representatives of the relevant GEFC Group Company and the relevant GEFA Company. If such Dispute cannot be settled amicably within 5 Business Days, it shall be referred to the Relationship Managers of GECC and GEFA; and

15.2.2 where a Dispute arises in relation to this agreement which cannot be settled amicably within 3 Business Days, such Dispute shall first be referred to the respective Relationship Managers of the Parties or such other appropriate persons as the Relationships Managers shall nominate.

If the Relationship Managers (or their nominees) are unable to resolve a Dispute within 5 Business Days after such referral, the Dispute shall be referred (upon the application of either Party or its Relationship Manager) for resolution to the respective Managing Director or Chief Executive Officer (or the person of equivalent seniority) of each of the Parties.

15.3 For the purposes of this clause 15, "Dispute" means a difference or dispute of whatever nature between the Parties (or the parties to a Local Agreement) arising under, out of or in connection with this agreement or a Local Agreement (including any question of interpretation of this agreement or a Local Agreement).

15.4 Save as otherwise provided in this agreement, any Dispute which is not resolved pursuant to Clause 15.2 within 5 Business Days of referral to the Parties' respective Managing Directors or Chief Executives (or such other period as is specified in this agreement) shall be resolved by arbitration in London conducted in the English language by a single arbitrator pursuant to the rules of the London Court of International Arbitration ("LCIA"). The appointing authority shall be the LCIA. For the avoidance of doubt, the terms of the Arbitration Act 1996 shall apply to such arbitration and neither Party shall be prevented from exercising any rights available to the Parties under the Arbitration Act 1996 including, without limitation, the right to apply for injunctive relief.

## 16 Performance Meetings And Report Outs

#### 16.1 Framework Agreement Performance Meetings

The Parties shall hold performance meetings in accordance with the terms of Part A of Schedule 6 and each Party shall ensure that the meetings are attended by its appropriate relevant personnel, to include the Relationship Managers and/or their representatives, and appropriate members of their respective finance, risk and operations teams.

#### 16.2 Local performance meetings

The relevant GECF Group Companies shall, and GEFA shall procure that the relevant GEFA Companies shall, hold performance meetings in accordance with Part B of Schedule 6.

### 17 Accounts, Records and Access to Information

17.1 The Parties will keep, and shall procure that the GECF Group Companies and the GEFA Companies (as the case may be) will keep, true and accurate accounts and records in connection with this agreement, such accounts and records to comply with all Applicable Laws including any applicable requirements of the relevant Financial Services Regulator or any other applicable regulator.

17.2 Subject to Applicable Laws and the confidentiality provisions of Clause 23, the Parties shall and shall procure that the GEFA Companies, in the case of GEFA, and the GECF Group Companies, in the case of GECF, shall permit (but not more often than twice in any Contract Year in a Territory unless required by the relevant Governmental Authority) authorised representatives, officers or employees of the other (at the cost of the requesting party) at all reasonable times on ten Business Days notice to carry out an audit of the GECF Group Company's obligations in relation to Profit Share [or any regulatory requirements or dependencies on the relevant GECF Group Company] under any Local Agreements, or any provision of services by GEFA or a GEFA Company, or GEFA's or a GEFA Company's pricing methodology for Schemes and claims reserving policy, including when relevant those accounts and records and any papers which can legally be disclosed relating in whole or in part to the subject matter of this agreement or any Local Agreement.

17.3 Without prejudice to any other right of either Party under this agreement and subject to Applicable Laws and the confidentiality provisions of clause 23, if any material complaint, claim or allegation is made (whether to or by any regulatory authority or by any Insured Customer or to any ombudsman or otherwise) or any proceedings (whether civil, criminal, investigative or administrative) shall be instituted against a Party or, any GEFA Company or any GECF Group Company (the "Affected Party") or any of their agents or sub-contractors which in any way relates to any Payment Protection Product comprising the Business or the marketing, sale, administration and fulfilment thereof or to any Insured Customer or prospective Insured Customer (or if a Party reasonably believes that any such claim or allegation may be made or such proceedings instituted), the other Party shall promptly make available (on the written request of the Affected

---

Party or its legal advisers), and procure that any relevant GEFA Company or GECF Group Company (as the case may be) shall promptly make available, such documentation, information, files and papers and copies thereof as shall be in the possession of the other Party, GEFA Company or GECF Group Company (as the case may be) or any of its agents or sub-contractors which may relate in any way to the subject matter of such complaint, claim, allegation or proceedings and which it is not prevented from disclosing by virtue of any Applicable Law or any obligation of confidentiality.

### 18 Assignment, Agents and Sub-Contracting

18.1 GECC shall not be entitled to and shall not, in each case without the prior written consent of GEFA (such consent not to be unreasonably withheld or delayed), assign, novate or otherwise transfer this agreement in whole or in part.

18.2 GEFA may at any time assign all or any part of the benefit of, or its rights or benefits under, this agreement to a purchaser of all or a substantial part of the business of the GEFA Group but shall otherwise not be entitled to and shall not, in each case without the prior written consent of GECC (such consent not to be unreasonably withheld or delayed), assign, novate or otherwise transfer this agreement in whole or in part.

18.3 Notwithstanding clauses 18.1 and 18.2 above, both Parties shall be entitled to assign, novate or otherwise transfer this agreement in whole or in part without the consent of the other Party to another Group company in the context of a solvent restructuring.

18.4 Notwithstanding anything contained in this Clause 18, GEFA shall not assign all or any part of the benefit of, or its rights or benefits under, this agreement without the written consent of GECC to all or any of Citibank, HSBC, Cetelem or any other entity engaged in a multinational consumer lending business which is a competitor of the GECF Group.

18.5 In respect of Existing Business, Substitute Business, Identified New Business and New Business in an Existing Territory:

- (i) GEFA and the GEFA Companies shall have the right to sub-contract any of their rights or obligations under this agreement or the relevant Local Agreement to an Approved Subcontractor; and
- (ii) if GEFA or any of the GEFA Companies wishes to sub-contract any of its rights or obligations under this agreement or the relevant Local Agreement to a third party which does not fall within paragraph (i) above, GEFA shall seek the prior written consent of GECC (such consent not to be unreasonably withheld or delayed).

18.6 In respect of New Business in a New Territory GEFA and the GEFA Companies shall not, without GECC's prior written consent (such consent not to be unreasonably withheld or delayed), sub-contract any of their rights or obligations under this agreement other than to an Approved Subcontractor.

---

18.7 For the purposes of this agreement, any act or omission or failure to carry out any obligation under this agreement of any third party or GECF Group Company or GEFA Company (as the case may be) to whom a Party to this agreement has sub-contracted or otherwise delegated its obligations shall be deemed to be an act or omission or failure of the Party which appointed that third party or delegated to such Group company. The appointing Party shall not be relieved from its liability for any failure by that Party or any of its appointees to perform any obligation which it sub-contracts or otherwise delegates to any third party or Group company and shall remain liable for such failures, acts or omissions.

18.8 Without prejudice to clause 18.5, each Party shall act prudently in relation to the outsourcing of any functions under or relating to this agreement and shall comply with any Financial Services Regulator's provisions or any Territory-specific provisions relating to the outsourcing of any functions, duties or responsibilities under or in connection with this agreement.

### 19 Warranty of Authority

Each Party warrants to the other that it has full authority and power to execute this agreement and to perform all of its duties and obligations under this agreement and any document to be executed pursuant hereto. Each Party shall provide evidence of such authority if and when required by the other.

## 20 Commencement, Term and Termination

### 20.1 Commencement and Term

**20.1.1** This agreement shall commence on the Commencement Date and, subject to clauses 20.2 and 20.3, shall continue in force until 31 December 2008.

**20.1.2** Any terms for extension of this agreement shall be agreed on or by 30 June 2008 failing which this agreement shall expire on 31 December 2008.

### 20.2 Termination Rights of GECC

**20.2.1** GECC may terminate this agreement at any time by written notice to GEFA if:

- (a) GEFA becomes Insolvent;
- (b) GEFA commits an irremediable material breach of this agreement;
- (c) GEFA commits a material breach of this agreement and fails to remedy such breach within 30 days of being required to do so by written notice given by GECC;
- (d) subject to Clause 20.2.2, GEFA commits a series of persistent breaches which when taken together constitute a material breach of this agreement;

35

---

- (e) the number of Local Agreements which have been terminated pursuant to clause 20.4 or its equivalent in the Local Agreement represents 50 per cent. or more of the total number of Local Agreements in existence from time to time;
- (f) Genworth Financial, Inc. ceases to have a financial strength rating of BBB or better according to Standard & Poor's;
- (g) a Material Change has occurred and paragraph 12 of the procedure set out in Part C of Schedule 5 applies (such procedure having been initiated pursuant to Clause 20.2.3);
- (h) 50 per cent. or more of the maximum available Service Credits in a month have been accumulated for each of nine months or more in any Relevant Period;
- (i) any one of Citibank, HSBC, Cetelem or any other entity engaged in a multi-national consumer lending business which is a competitor of the GECF Group has acquired Control of GEFA or any holding company of GEFA,

such notice shall set out the length of any required Exit Phase and the date the termination takes effect.

**20.2.2** GECC shall not provide a notice to terminate pursuant to Clause 20.2.1(d) without first referring the matter to the dispute resolution procedure referred to in Clause 15. If the dispute resolution procedure: (i) does not lead to the parties agreeing a remediation plan in respect of the breaches then GECF may terminate this agreement in accordance with Clause 20.2.1(d) or (ii) produces an agreed resolution plan but GEFA fails to comply with such plan, then the persistent breaches shall be deemed to be a material breach and GECC may terminate this agreement in accordance with Clause 20.2.1(c).

**20.2.3** If in any Relevant Period Eligible GWP is in excess of 20 per cent. lower than Comparable GWP in two or more Territories (a **"Material Change"**), GECC shall, have the right, by notice in writing to GEFA, within 10 Business Days of the occurrence of such Material Change, to initiate the procedure set out in Part C of Schedule 5. For the avoidance of doubt, if a Material Change results or may be reasonably said to result from a general reduction in the amount of financing or other activity or a reduction due to any specific management decision of GECC or a GECF Group Company which results in a reduction in production in the relevant Territories, then the procedure in Part C of Schedule 5 shall not be initiated and a Material Change shall be deemed not to have occurred.

### 20.3 Termination Rights of GEFA

GEFA may terminate this agreement at any time by written notice to GECC if GECC becomes Insolvent.

36

---

### 20.4 Termination Rights under Local Agreements

**20.4.1** The Parties agree that the relevant GECF Group Companies shall, and GEFA shall procure that the relevant GEFA Companies shall, in respect of Existing Business, amend the terms of their Existing Local Agreements, or in respect of Identified New Business and New Business, enter into New Local Agreements, which grant the relevant GECF Group Company and the relevant GEFA Company as applicable the right to terminate such Local Agreement by written notice to the relevant counterparty if (and only if):

- (i) the relevant GECF Group Company or GEFA Company is Insolvent;
- (ii) the relevant GEFA Company commits an irremediable material breach of the Local Agreement;
- (iii) the relevant GEFA Company commits a material breach of the Local Agreement and fails to remedy such breach within 30 days of being required to do so by written notice given by GECC;
- (iv) subject to Clause 20.4.3, the relevant GEFA Company commits a series of persistent breaches which when taken together constitute a material breach of the Local Agreement;
- (v) a Local Material Change has occurred and paragraph 12 of the procedure set out in part C of Schedule 5 applies (such procedure having been initiated pursuant to Clause 20.4.4);
- (vi) subject to 20.4.2 if, in respect of the relevant Local Agreement, GEFA accumulates at least 27.5 per cent. of the maximum available Service Credits



in any four consecutive months or for any nine months in a Relevant Period provided that if such period ends after 31 December 2005 the reference to 27.5 per cent. above shall be replaced by a reference to 25 per cent. ; or

(vii) a Regulatory Event has occurred and sub-paragraph (ix) of the procedure set out in clause 20.4.5 applies,

such notice shall set out the length of any required Exit Phase and the date the termination takes effect.

**20.4.2** GECC shall not exercise its right to terminate any Local Agreement pursuant to Clause 20.4.1(vi) at any time (i) within 12 calendar months from the Commencement Date and (ii) in respect of a New Local Agreement within 6 calendar months from the commencement date of the relevant Local Agreement.

**20.4.3** GECC shall not provide a notice to terminate pursuant to Clause 20.4.1(iv) without first referring the matter to the dispute resolution procedure referred to in Clause 15. If the dispute resolution procedure: (i) does not lead to the Parties

37

---

agreeing a remediation plan in respect of the breaches then GECC may terminate this agreement pursuant to Clause 20.4.1(iv) or (ii) produces an agreed resolution plan but GEFA fails to comply with such plan, then the breach(es) shall be deemed to be material and GECC may terminate the Local Agreement in accordance with Clause 20.4.1(iii).

**20.4.4** If in any Relevant Period, Local Eligible GWP is in excess of 50 per cent. lower than Local Comparable GWP (a “**Local Material Change**”) GECC shall within 10 Business Days of the occurrence of such Local Material Change have the right, by notice in writing to GEFA, to initiate the procedure set out in Part C of Schedule 5 with respect to the Local Agreement in question, provided that in respect of each Local Agreement in a Key Territory the figure of 50 per cent. above shall be replaced with 20 per cent. For the avoidance of doubt, if a Local Material Change results or may be reasonably said to result from a general reduction in the amount of financing activity or a reduction due to any specific management decision of GECF Group Companies which results in a reduction in production in the relevant Territory, then the procedure in Part C of Schedule 5 shall not be initiated and a Local Material Change shall be deemed not to have occurred.

**20.4.5** The Parties agree that following the occurrence of a Regulatory Event, the following shall apply.

- (i) Within 5 Business Days of the occurrence of a Regulatory Event, the Affected GEFA Company shall give notice in writing of the Regulatory Event to each counterparty of each Local Agreement to which it is a party. Such notice shall include:
  - (a) details of the matter which gave rise to the Regulatory Event;
  - (b) details of any remedial action stipulated by the Financial Services Regulator which may be taken in order to avoid the threatened revocation or suspension of authorisation; and
  - (c) details of any deadlines by which such action must be taken.
- (ii) Upon receipt of the notice referred to in clause (i) above the relevant GECF Group Company may begin contingency planning to change to a Replacement Supplier in respect of those Payment Protection Products which the Affected GEFA Company will be unable to provide in the event that its authorisation is revoked or suspended. Such contingency planning may include contacting potential replacement suppliers for the purposes of agreeing terms of supply but, for the avoidance of doubt, any such agreement shall be conditional on the revocation or suspension of the Affected GEFA Company’s authorisation.
- (iii) Within 15 Business Days of the occurrence of the Regulatory Event, the Affected GEFA Company shall produce and provide to the relevant GECF

38

---

Group Company a proposal updated from time to time as appropriate setting out the action which the Affected GEFA Company intends to take in order to comply with the terms of the notice from the Financial Services Regulator and the timetable within which such action shall be taken.

- (iv) Promptly after the provision of the proposal pursuant to clause (iii) above, the Affected GEFA Company and the relevant GECF Group Company shall discuss the adequacy of the proposed action and timetable.
- (v) If the Affected GEFA Company and the relevant GECF Group Company, each acting reasonably, agree that the steps set out in the proposal will be sufficient to resolve the problem, the Affected Company shall implement the proposal in accordance with the agreed timetable. The Affected GEFA Company shall keep the relevant GECF Group Company regularly informed as to progress and shall promptly inform the relevant GECF Group Company of any further relevant communications from the Financial Services Regulator.
- (vi) If the relevant GECF Group Company, acting reasonably, considers that the proposal will not adequately address the problem identified by the Financial Services Regulator, the parties shall negotiate in good faith to make such amendments as they agree are necessary to resolve the problem.
- (vii) If at any time the Affected GEFA Company, in its reasonable opinion, considers that it will be unable to take the necessary action to avoid the revocation or suspension of its authorisation, it shall immediately inform the relevant GECF Group Company and the provisions of clause (ix) shall apply.
- (viii) If at any time the Financial Services Regulator notifies the Affected GEFA Company that its authorisation has been revoked or suspended, the provisions of clause (ix) shall apply.
- (ix) In the event that this clause (ix) applies, the relevant GECF Group Company shall have the right to terminate the relevant Local Agreement to the extent that it relates to Payment Protection Products in respect of which the Affected GEFA Company is or shall be unable to meet its obligations and shall have the right to enter arrangements for the supply of such Payment Protection Products with a Replacement Supplier.

## **21 Consequences of Termination**

### **21.1 Termination of this Agreement**

**21.1.1** Upon the termination or expiration of this agreement pursuant to clauses 20.1, 20.2 or 20.3 the Local Agreements shall automatically terminate.

39

---

21.1.2 GECC and each GECF Group Company shall not during the Term or during the Run-Off Period, by way of any act or omission, encourage, induce or persuade any Insured Customer to terminate any Payment Protection Product which such Insured Customer has entered into with GEFA or a GEFA Company.

## 21.2 Surviving Clauses

21.2.1 Termination or expiry of this agreement for whatever reason shall be without prejudice to the rights, obligations and liabilities of either Party then accrued due and shall not affect the coming into force or the continuation in force of this clause 21.2.1 or of any provision of this agreement which is expressly stated to continue in force at or after termination or expiry including , 10.3, 11, 15, 17, 21.3, 23, 30 and 31.

21.2.2 During the Run-Off Period the following additional clauses shall remain in force: 5.3, 6, 9.1, 9.2, 12, 13, 14, 16, 18.

## 21.3 Exit Plan and Termination Assistance

21.3.1 If GECC so requests promptly following the commencement of an Exit Phase, GEFA shall and shall procure that the GEFA Companies shall as soon as reasonably practicable submit to GECC and the relevant GECF Companies a plan (the “**Exit Plan**”) which shall describe the activities and tasks to be performed by the Parties in order to facilitate the smooth transfer of the responsibility for the provision of Payment Protection Products to a Replacement Supplier.

21.3.2 During the Exit Phase, the Parties shall perform their respective obligations as stated in the Exit Plan.

21.3.3 Subject to the provisions of the Exit Plan, each Party shall and shall procure that the GEFA Companies or the GECF Group Companies (as applicable) shall during the Exit Phase provide to the other Party any assistance reasonably requested to allow the provision of Payment Protection Products to continue without material interruption or material adverse effect and to facilitate the transfer of, responsibility for and conduct of the provision of Payment Protection Products to a Replacement Supplier in accordance with the provisions of the Exit Plan. GEFA shall be responsible for any reasonable additional costs incurred by GEFA as a result of the provision of termination assistance services to GECC or GECF Group Companies.

21.3.4 Except as otherwise stated in the Exit Plan, the obligations stated in Clauses 21.3.2 and 21.3.3 above shall be in addition to and not in substitution for the provision of the Payment Protection Products during the Exit Phase on the terms and conditions of this agreement.

40

---

## 22 Force Majeure

22.1 “Event of Force Majeure” means, in relation to any Party or a GECF Group Company or a GEFA Company (as the case may be), an event or circumstance beyond the reasonable control of that person (the “Claiming Party”) including, without limitation, strikes, lock-outs and other industrial disputes (in each case, whether or not relating to the Claiming Party’s workforce) but excluding any event under clause 4.

22.2 The Claiming Party shall not be deemed to be in breach of this agreement or otherwise liable to any other party (the “Non-claiming Party”) for any delay in performance or any non-performance of any obligations under or pursuant to this agreement (and the time for performance shall be extended accordingly) if and to the extent that the delay or non-performance is due to an Event of Force Majeure provided that:

- (i) the Claiming Party could not have avoided the effect of the Event of Force Majeure by taking precautions, including disaster recovery arrangements, which, having regard to all matters known to it before the occurrence of the Event of Force Majeure and all relevant factors, it ought reasonably to have taken but did not take; and
- (ii) the Claiming Party has used reasonable endeavours to mitigate the effect of the Event of Force Majeure and to carry out its obligations under this agreement in any other way that is reasonably practicable.

22.3 The Claiming Party shall promptly notify the Non-claiming Party of the nature and extent of the circumstances giving rise to the Event of Force Majeure.

22.4 If the Event of Force Majeure in question prevails for a continuous period in excess of two months after the date on which it began, the Non-claiming Party may require that the issue be included on the agenda of the next local performance meeting held pursuant to clause 16.2. At such meeting the Parties shall discuss in good faith the continued provision of the affected service or obligation and any necessary amendments to this agreement or the relevant Local Agreement.

## 23 Confidential Information

23.1 Each Party undertakes to each other and each member of the other party’s Group that it will not, and will ensure that its directors, officers, employees and agents do not, without the prior written consent of the other Party:

23.1.1 make available or disclose any Confidential Information of the other party which is provided to it by that other Party pursuant to this agreement to any person other than those of its directors, officers or employees or other persons (including subcontractors) who are necessarily required in the course of their duties to receive and consider the same for the purposes of performing its obligations or exercising its rights under this agreement and for risk modelling and profiling purposes, but not for marketing purposes or for the purposes of directly or indirectly canvassing or soliciting the custom of any customer of the GECF Group

41

---

(including for the avoidance of doubt using anonymised information on clients of GECF Group Companies) (the “**Permitted Purposes**”); or

23.1.2 use any Confidential Information of that other Party which is provided to it by the other Party pursuant to this agreement other than for the Permitted Purposes.

23.2 The provisions of clause 23.1 shall not apply to the extent that any Confidential Information:

23.2.1 is at the date of this agreement or any time thereafter becomes publicly known, other than as a result of any breach of this agreement or any other duty of confidence;

23.2.2 can be shown by the receiving Party to the disclosing Party’s reasonable satisfaction to have been known by the receiving Party before disclosure by the

disclosing Party, other than as a result of any breach of this agreement or any other duty of confidence;

23.2.3 is required to be disclosed by any court or governmental, administrative or regulatory authority competent to require such disclosure; or

23.2.4 is required to be disclosed by any Applicable Law.

**23.3 Notwithstanding clause 23.1:**

23.3.1 a Party may disclose Confidential Information relating to another to its professional advisers for the purposes of obtaining professional advice provided that the disclosing Party shall advise any such person to whom such information is disclosed of the confidentiality obligations contained in this agreement and shall procure that such person complies with such obligations as if it were a party to this agreement; and

23.3.2 no Party shall be prevented from using or disclosing any information which is independently developed without reference to or which does not refer to any Confidential Information of the other Party.

23.4 Each Party shall, forthwith upon termination or expiry of this agreement for any reason or upon the receipt by it of written demand from the other, return all written Confidential Information provided to it by the other Party.

**24 Waiver**

24.1 A waiver of any term, provision or condition of this agreement shall be effective only if given in writing and signed by the waiving Party and then only in the instance and for the purpose for which it is given.

24.2 No failure or delay on the part of any Party in exercising any right, power or privilege under this agreement shall operate as a waiver thereof, nor shall any single or partial

42

---

exercise of any such right, power or privilege preclude any other or further exercise thereof or the exercise of any other right, power or privilege.

24.3 No breach of any provision of this agreement shall be waived or discharged except with the express written consent of the Parties.

**25 Entire Agreement**

25.1 This agreement constitutes the entire and only agreement between the Parties relating to the subject matter of this agreement and (to the extent permissible by law) supersedes and extinguishes any and all prior drafts, agreements, writings, negotiations, understandings, undertakings, representations, warranties and arrangements of any nature whatsoever, whether or not in writing, relating to or in connection with the subject matter of this agreement provided that neither Party is attempting to exclude any liability for fraudulent statements (including fraudulent pre-contractual misrepresentations) on which the other Party can be shown to have relied. All terms, conditions and warranties not stated expressly in this agreement, and which would in the absence of this provision be implied into this agreement by statute, common law, equity, trade, custom or usage or otherwise, are excluded to the maximum extent permitted by law.

25.2 Each Party acknowledges that it has not been induced to enter into this agreement in reliance upon, nor has it been given, any warranty, representation, statement, assurance, covenant, agreement, undertaking, indemnity or commitment of any nature whatsoever other than as expressly set out in this agreement and, to the extent it has been, it unconditionally and irrevocably waives any claims, rights and remedies which it might otherwise have had in relation thereto.

25.3 The provisions of this clause shall not exclude any liability which a Party would otherwise have to the other or any right which either of them may have to rescind this agreement in respect of any statements made fraudulently by the other prior to the execution of this agreement or any rights which either of them may have in respect of fraudulent concealment by the other.

25.4 This agreement may be varied only by a document signed by both Parties.

25.5 Any claim brought by either Party in respect of a breach by the other Party of the terms of this agreement may include a claim for actual or potential loss of profits.

**26 Costs and Expenses**

26.1 Except as expressly provided in this agreement each of the Parties shall bear its own legal, accountancy and other costs, charges and expenses connected with the negotiation, preparation and implementation of this agreement and any other agreement incidental to or referred to in this agreement.

26.2 Except as expressly provided in this agreement, GECC shall not be entitled to any other remuneration or to be reimbursed for any cost, charge or expense incurred by it in each case in connection with this agreement or the performance of its obligations hereunder.

43

---

For the avoidance of doubt, this clause shall not operate to exclude or limit any liability of GEFA for breach of contract or its negligence.

**27 No Partnership**

Nothing in this agreement and no action taken by the Parties pursuant to this agreement shall constitute, or be deemed to constitute, a partnership, association, joint venture or other co-operative entity.

**28 Notices**

28.1 Any notice, demand or other communication given or made under or in connection with the matters contemplated by this agreement shall be in writing and shall be delivered personally or sent by fax or prepaid first class post (air mail if posted to or from a place outside the United Kingdom):

In the case of GEFA to:

Address: Vantage West, Great West Road, Brentford, Middlesex TW8 9AG  
Fax: 44 20 8380 3300  
Attention: European Legal Director

In the case of GECC to:

GE Consumer Finance, Malvern House, Croxley Green Business Park, Watford, Herts, WD18 8YF

Fax: 44 1923 426871

Attention: General Counsel, Europe

and shall be deemed to have been duly given or made as follows:

- 28.1.1** personally delivered, upon delivery at the address of the relevant Party;
- 28.1.2** if sent by first class post, two Business Days after the date of posting;
- 28.1.3** if sent by air mail, five Business Days after the date of posting; and
- 28.1.4** if sent by fax, when sent provided that the sender receives a satisfactory transmission confirmations,

provided that if, in accordance with the above provision, any such notice, demand or other communication would otherwise be deemed to be given or made after 5.00 p.m., such notice, demand or other communication shall be deemed to be given or made at 9.00 a.m. on the next Business Day.

44

---

**28.2** A Party may notify the other party to this agreement of a change to its name, relevant addressee and address for the purposes of clause 28.1 provided that such notification shall only be effective on:

- (i) the date specified in the notification as the date on which the change is to take place; or
- (ii) if no date is specified or the date specified is less than five Business Days after the date on which notice is given, the date falling five Business Days after notice of any such change has been given.

## **29 Invalidation and Severability**

**29.1** If any provision of this agreement is or becomes (whether or not pursuant to any judgement or otherwise) invalid, illegal or unenforceable in any respect under the law of any jurisdiction:

- 29.1.1** the validity, legality and enforceability under the law of that jurisdiction of any other provision; and
- 29.1.2** the validity, legality and enforceability under the law of any other jurisdiction of that or any other provision,

shall not be affected or impaired in any way thereby.

**29.2** If any provision of this agreement shall be held to be void or declared illegal, invalid or unenforceable for any reason whatsoever, such provision shall be divisible from this agreement and shall be deemed to be deleted from this agreement and the validity of the remaining provisions shall not be affected. In the event that any such deletion materially affects the interpretation of this agreement then the Parties shall negotiate in good faith with a view to agreeing a substitute provision which as closely as possible reflects the commercial intention of the Parties.

## **30 Governing Law and Jurisdiction and Appointment of Process Agent**

### **30.1 Governing Law and Jurisdiction**

This agreement (and any dispute, controversy, proceedings or claim of whatever nature arising out of or in any way relating to this agreement or its formation) shall be governed by and construed in accordance with English law.

### **30.2 Appointment of Process Agent**

**30.2.1** GEFA hereby irrevocably appoints (Marked for the attention of Company Secretary) Financial Insurance Company Limited, [Vantage West, Great West Road, Brentford, Middlesex TW8 9AG], as its agent to accept service of process in England in any legal action or proceedings arising out of this agreement,

45

---

service upon whom shall be deemed completed whether or not forwarded to or received by GEFA.

**30.2.2** GEFA agrees to inform GECC in writing of any change of address of such process agent within 28 days of such change.

**30.2.3** If such process agent ceases to be able to act as such or to have an address in England, GEFA irrevocably agrees to appoint a new process agent in England acceptable to GECC and to deliver to GECC within 14 days a copy of a written acceptance of appointment by the process agent.

**30.2.4** GECC hereby irrevocably appoints (Marked for the attention of General Counsel, Europe) GE Capital Bank, [GE Consumer Finance, Malvern House, Croxley Green Business Park, Watford, Herts WD18 8YF], as its agent to accept service of process in England in any legal action or proceedings arising out of this agreement, service upon whom shall be deemed completed whether or not forwarded to or received by GECC.

**30.2.5** GECC agrees to inform GEFA in writing of any change of address of such process agent within 28 days of such change.

**30.2.6** If such process agent ceases to be able to act as such or to have an address in England, GECC irrevocably agrees to appoint a new process agent in England acceptable to GEFA and to deliver to GEFA within 14 days a copy of a written acceptance of appointment by the process agent.

**30.2.7** Nothing in this agreement shall affect the right to serve process in any other manner permitted by law or the right to bring proceedings in any other jurisdiction for the purposes of the enforcement or execution of any judgment or other settlement in any other courts.

## **31 Exclusion of Third Party Rights**

The Parties to this agreement do not intend that any term of this agreement should be enforceable, by virtue of the Contracts (Rights of Third Parties) Act 1999, by any person who is not a Party to this agreement.

IN WITNESS whereof this agreement has been executed on the date first above written.

Signed by )

for and on behalf of )

GEFA INTERNATIONAL HOLDINGS, INC. )

in the presence of:

Signed by )

for and on behalf of )

GE CAPITAL CORPORATION )

in the presence of:

**Schedule 1  
Existing Business**

**Part A – Existing Direct Business**

<b>Territory</b>	<b>Product</b>	<b>**</b>	<b>**</b>	<b>**</b>
UK (GCF)	Bank Card Account Cover 3	**%	**%	**%
UK (GCF)	Bank Card Account Cover 3 over 70's	**%	**%	**%
UK (GCF)	Store Card Account Cover 3	**%	**%	**%
UK (GCF)	Store Card Account Cover 3 over 70's	**%	**%	**%
UK (GCF)	Monsoon Account Cover 3	**%	**%	**%
UK (GCF)	Monsoon Account Cover 3 over 70's	**%	**%	**%
UK (GCF)	3335 Comet, B&Q Revolving	**%	**%	**%
UK (GCF)	3334 Comet, B&Q fixed	**%	**%	**%
UK (GCF)	3303 Toys R Us	**%	**%	**%
UK (GCF)	3358 DFS	**%	**%	**%
UK (GCF)	3644 Kwik Fit	**%	**%	**%
UK (GCF)	Store Credit Card Beagle	**%	**%	**%
UK (GCF)	Matrix	**%	**%	**%
Sweden	NA0	**%	**%	**%
Sweden	NA1	**%	**%	**%
Sweden	RD1	**%	**%	**%
Sweden	RD2	**%	**%	**%
Sweden	RR1	**%	**%	**%
Sweden	GC1-6	**%	**%	**%
Sweden	GD9	**%	**%	**%
Sweden	RD3	**%	**%	**%
Denmark	G36	**%	**%	**%
Denmark	G37	**%	**%	**%
Denmark	G38	**%	**%	**%
Denmark	G39	**%	**%	**%
Denmark	G35 Compulsory Life	**%	**%	**%
Denmark	G34 Compulsory Life	**%	**%	**%
Denmark	G29 Compulsory Life	**%	**%	**%
Denmark	G2B Compulsory Life	**%	**%	**%
Denmark	G40 Compulsory Life	**%	**%	**%
Denmark	G41 Compulsory Life	**%	**%	**%
Denmark	G56 Xtra Tryghed	**%	**%	**%
Denmark	G57 Xtra Tryghed	**%	**%	**%
Denmark	G58 Xtra Tryghed	**%	**%	**%
Denmark	G59 Xtra Tryghed	**%	**%	**%
Denmark	AC1 AcceptCard	**%	**%	**%
Norway	6604	**%	**%	**%
Norway	6602	**%	**%	**%
Norway	6612	**%	**%	**%
Norway	6701, 6801, 6702, 6802, 6901, 6902, 6712	**%	**%	**%
Norway	6812	**%	**%	**%
Norway	6703, 6803, 6903	**%	**%	**%

Norway	6603	**%	**%	**%
Norway	6613	**%	**%	**%
Norway	6913, 6914, 6915	**%	**%	**%
Norway	6813	**%	**%	**%
Norway	6601	**%	**%	**%
Norway	6611	**%	**%	**%
Norway	6811	**%	**%	**%
Norway	6504a, 6504b	**	**	**
Switzerland	GC4 ProKredit	**%	**%	**%
Switzerland	GC5 Prolimit	**%	**%	**%
Switzerland	GC6 Unileasing	**%	**%	**%
Switzerland	GC7 Sales Finance	**%	**%	**%
Italy	GE4 Finanziamento Sereno	**%	**%	**%
Italy	GE5 Finanziamento Sereno Plus	**%	**%	**%
Italy	GE6 Lease & Life	**%	**%	**%
Italy	GE7 Lease & Life Plus	**%	**%	**%
Italy	GEB Resolicitation	**%	**%	**%
France	Auto	**%	**%	**%
France	Vie 3011	**%	**%	**%
France	Vie 0007	**%	**%	**%
France	Vie 0011	**%	**%	**%
France	Vie 0029	**%	**%	**%
France	Vie 0039	**%	**%	**%
France	Vie 0052	**%	**%	**%
France	Vie 0091	**%	**%	**%
France	RD 0022	**%	**%	**%
France	RD 0029	**%	**%	**%
France	RD 0074	**%	**%	**%
France	RD 0116	**%	**%	**%
France	RD 0045	**%	**%	**%
France	RD 0057	**%	**%	**%
France	RD 0075	**%	**%	**%
France	RD 0120	**%	**%	**%
France	Mortgage	**%	**%	**%
France	0001	**%	**%	**%
France	0022	**%	**%	**%
France	0019	**%	**%	**%
France	1995	**%	**%	**%
France	0024	**%	**%	**%
France	0054	**%	**%	**%
France	0055	**%	**%	**%
France	0089	**%	**%	**%
France	0090	**%	**%	**%
France	0030	**%	**%	**%
France	3595	**%	**%	**%
France	0003	**%	**%	**%

Territory	Product	**	**	**
France	0087	**%	**%	**%
France	0088	**%	**%	**%
France	0118	**%	**%	**%
France	0119	**%	**%	**%
France	0069	**%	**%	**%
France	0056	**%	**%	**%
France	GE branded	**%	**%	**%
France	Co-branded	**%	**%	**%
Germany	SG1-2	**%	**%	**%

**Part B – Existing Reinsured Business**

Territory	Product	**	**	**
UK (Woodchester)	BU, BU2 Cap care Premier HP	**%	**%	**%
UK (Woodchester)	BUR, 2BU Cap care Premier PCP	**%	**%	**%
UK (Woodchester)	CUB, 2CB Custom Finance	**%	**%	**%
UK (Woodchester)	K1B, K2B Keyman Basic	**%	**%	**%
UK (Woodchester)	K3B, K4B Keyman Standard	**%	**%	**%
UK (Woodchester)	K5B, K6B Keyman Premier	**%	**%	**%
UK (Woodchester)	BA, BA2 Cap Care Standard	**%	**%	**%
UK (Woodchester)	BL, BL2 Cap Care Basic HP	**%	**%	**%
UK (Woodchester)	BLR 2BL Cap care Basic PCP	**%	**%	**%
UK (Woodchester)	BAR, 2BA Cap care Standard PCP	**%	**%	**%
Ireland	PA – PN, TA – TR Auto business	**%	**%	**%
Ireland	WB – WY, XB – XY Consumer business	**%	**%	**%
Ireland	KA – KF Equipment business	**%	**%	**%
Germany	SPA-B	**%	**%	**%
Germany	SPG-J	**%	**%	**%
Germany	SPC-F	**%	**%	**%
Spain	BF20	**%	**%	**%
Spain	BF22	**%	**%	**%
Spain	Super PPI	**%	**%	**%
Spain	resolicitation	**%	**%	**%

Portugal	WAA, WNA, WFA	**%	**%	**%
Portugal	WAB – WAM, WNB – WNM, WFB - WFM	**%	**%	**%

50

**Part C**

\*\*

51

**Schedule 2  
GE Financial Insurance Service Level Standards**

**1 Glossary**

**Business Day** – means, for the purposes of this Schedule 2 only, a day (other than a Saturday, Sunday or public holiday) on which banks are open for business in the relevant Territory;

**Confirmed/Confirmation** – New business and cancellation records accepted and made live on to the GEFA administration system.

**Decision Accuracy** – Accuracy of the decision to pay/reject a claim based on the terms and conditions of the policy against the detail put forth in the claim. The measure of the accuracy is Yes or No.

**Notification of Insurance Processing** – Electronic files, or other medium agreed between the Parties, in agreed format containing new business, cancellations, mid-term adjustments, premium payments and customer details for bulk premium, periodic premium, single premium and reinsurance products. Notification of Insurance Processing also includes correction of errors passed back to GECC for resolution.

**Processing Month End** – The period within the GEFA Group for which Insurance Processing is Confirmed. This follows a predefined accounting schedule of month ends, normally occurring on the last or second to last Friday in the calendar month, which GEFA will notify to GECC annually at the beginning of the year for the whole year.

**Pending** – Unconfirmed new business and cancellation records, which suffer validation errors and warning messages.

**Pending List** – A list of Notification of Insurance Processing that was not confirmed and put live on the GEFA administration system as at the Processing Month End.

**Processed** – The Notification of Insurance Processing has been Confirmed or Rejected or is Pending and Pending and Rejected data have been passed to GECC for correction.

**Processing Month** – The month GEFA has received the Notification of Insurance Processing from GECC to process.

**Reconciled/Reconciliation** – Notification of Insurance Processing which is allocated to one of the following categories (and communicated back to the client within agreed Service Levels) – Confirmed, Pending and Rejected –and reconciled with cash received.

**Rejected** – New business and cancellation records which result in a severe error as part of the interface validation process.

52

**Selling Month** – The month in which GECC sells the insurance to the customer.

**2 Hours Of Service**

Hours of service availability will be no less than 8 hours per day Monday to Friday excluding public holidays. Hours of service will vary in line with local working practices.

**3 Notification and Reconciliation of Insurance Processing**

GEFA will process bulk premium, periodic premium, single premium and reinsurance premium in respect of which collection is effected either by GECC or by GEFA.

The Service Levels in paragraph 3 are dependent on paragraph 12 and the dependencies set out in Table A in paragraph 17 below.

**3.1** Chart 1 (Operating Reconciliation Process) outlines the process flow for processing the insurance records notified. The process includes the processing of all new business records, cancellation records and the Pending and Rejected records that arise from the process.

**Operating Reconciliation Process (Chart 1)**

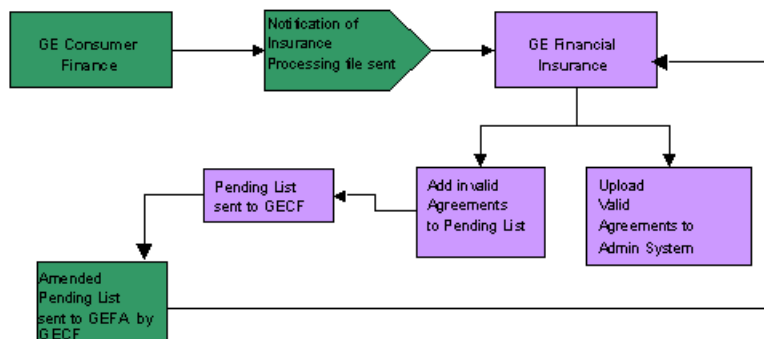

The Service Levels that apply are:

- (i) 100% of Notifications of Insurance Processing notified to GEFA shall be Processed by GEFA within 5 Business Days of file receipt;
- (ii) Notifications of Insurance Processing notified by GECC to GEFA at least 5 Business Days prior to the end of the Processing Month will be Processed by GEFA in the month in which the notification occurred unless the terms of an Existing Local Agreement provide otherwise;

- (iii) subject to paragraph 3.1(ii), reasonable efforts will be made to Process Notifications of Insurance Processing received fewer than 5 Business Days before Processing Month End, but for the avoidance of doubt this is not guaranteed within the terms of the Service Levels;
- (iv) reconciliation between the number of Notifications of Insurance Processing received by GEFA and the number of Notifications of Insurance Processing Processed will be completed by the tenth Business Day following the Processing Month End; and
- (v) provided that GECC has complied with its obligations to respond within five Business Days to all Pending Notifications of Insurance Processing,
  - (a) at the end of a Processing Month, Notifications of Insurance Processing classified as Pending shall not exceed 1% of total Notifications of Insurance Processing notified to GEFA in that Processing Month (excluding Notifications of Insurance Processing notified to GEFA fewer than 5 Business Days from the end of the relevant Processing Month); and
  - (b) by the end of the next Processing Month there shall be no Pending Notifications of Insurance Processing which were notified to GEFA in the preceding Processing Month (excluding Notifications of Insurance Processing notified to GEFA fewer than 5 Business Days from the end of the previous Processing Month).

### 3.2 Financial Control Reconciliation Process

- (i) The financial control reconciliation process begins when the operating reconciliation process set out in paragraph 3.1 ends. The Reconciliation can only happen once all the policies have been Processed. The procedure for invoicing and settlement shall be as follows:
  - (a) **Premium Invoiced** - GEFA shall supply to GECC invoice and Pending List 10 Business Days after Processing Month End.
  - (b) **Premium & Cash** - GEFA shall supply to GECC statement, commission settlement (where applicable) and Pending List 10 Business Days after Processing Month End.
  - (c) **Cancellations** - GEFA shall supply to GECC credit note or cheque 10 Business Days after Processing Month End (if cancellation amount owed exceeds premium in the relevant Processing Month).
  - (d) **Payment of Invoices/Statements** - Each party shall make payment within 7 Business Days of the issue of an invoice in respect of premium by the other Party unless the terms of an Existing Local Agreement provide otherwise.

- (ii) The Service Level for Financial Control Reconciliation is: 100% of all Notifications of Insurance Processing to be Reconciled by GEFA each month by the 10<sup>th</sup> Business Day following the Processing Month End. For the avoidance of doubt, the cash reconciliation shall occur by the tenth Business Day following the end of the subsequent Processing Month.

### 4 Management Information associated with Processing

- (i) Dashboards by Local Agreement will be created monthly by GEFA and reviewed at the monthly joint management meetings that will show clearly the percentage of data Confirmed, Pending and Rejected for a given month.
- (ii) Dashboards by Local Agreement will be created monthly by GEFA reflecting the age of Notifications of Processing which are classified as Pending or Rejected.
- (iii) Dashboards by Local Agreement will be created monthly by GEFA in respect of cancellation data including number of policies cancelled, value of refunds, average expired term and average remaining term, in each case by policy year.
- (iv) Dashboards will be delivered by GEFA within 10 Business Days of the Processing Month End.

### 5 New Policy Fulfilment



Where GEFA is responsible for new policy fulfilment, policy certificates and/or policy documentation as applicable will be issued by GEFA within 3 Business Days of the date of Confirmation unless an Existing Local Agreement or Applicable Law provides otherwise.

## **6 Telephony**

### **6.1 In-Bound**

- (i) A dedicated GECC line will be in place in respect of each Local Agreement.
- (ii) All calls shall be answered in the locally agreed format.
- (iii) 80% of calls will be answered within 20 seconds in any Processing Month. Where the required technology is not in place to provide metrics, an audit will be carried out by GEFA in respect of an appropriate number of calls relative to the volume normally received in respect of the relevant Local Agreement.
- (iv) In respect of calls to a GECC dedicated line and where the required telephony systems are in place for the purposes of measurement, the abandonment rate will not exceed 5% during any Processing Month.
- (v) Dashboards will be created monthly by GEFA and reviewed at the Monthly Performance Meetings. Such dashboards will show clearly the volume of calls,

55

---

the percentage answered within the Service Level, the average response time and the abandon rate where applicable.

- (vi) GECC will monitor the average response time and, if it trends towards 20 seconds, the Parties will discuss at the next Monthly Performance Meeting the implementation of an improvement plan.

### **6.2 Out-Bound**

- (i) In the event of an out-bound call being required and where the initial attempt fails, two further attempts will be scheduled prior to falling back on written communication. The second attempt will be within 24 hours. The third attempt will be the next Business Day.
- (ii) Addressing the customer - the manner and format of the customer interaction (including greeting & company name) will be agreed at a local level.

## **7 General Queries & Correspondence**

- (i) GEFA shall date stamp 100% of incoming correspondence on the day of receipt or, if such day is not a Business Day (or if received after the end of the hours of service on a Business Day), on the next Business Day. In the event of uncertainty as to the date of receipt, the date of receipt shall be deemed to be the fourth Business Day after the mean date on which the envelopes containing such correspondence (including claims) were franked.
- (ii) GEFA will respond to 100% of correspondence within 5 Business Days of receipt by GEFA.
- (iii) Unless otherwise stated in this agreement, GEFA will answer 100% of requests from GECC received by telephone, e-mail or post by the end of the next Business Day.

### **7.2 Claims Queries and Notification**

#### **7.2.1 Telephone Requests**

- (i) GEFA will respond to requests received by telephone for information regarding individual policies or claims during the call or by the end of the next Business Day if further investigation is required.
- (ii) If the attempt to contact the customer is unsuccessful, 2 further attempts will be made. If these are unsuccessful, the response will be sent by post.
- (iii) Claim forms requested by telephone will be dispatched by the end of the next Business Day unless printing of name and address is required, in which case the claim form shall be dispatched within 3 Business Days of the request.

56

---

### **7.3 Claim Notification by Mail**

- (i) GEFA shall respond within 3 Business Days to 100% of all incoming new claim form requests received by mail.
- (ii) GEFA shall respond within 3 Business Days to 100% of all incoming continuing claim form requests received by mail.

### **7.4 Claim Handling**

- (i) 95% of all claims registration forms and continuing claims forms received will be assessed and the proper response issued by GEFA within 5 Business Days of receipt. 100% of all claims registration forms and continuing claims forms received will be assessed and the proper response issued by GEFA within 10 Business Days of receipt.
- (ii) The average elapsed time for assessing and responding to claims registration forms and continuing claims forms will be not more than 3 Business Days from receipt.
- (iii) At the end of a Processing Month, no more than 5% of claims which have not been assessed shall be claims which were received by GEFA more than 10 Business Days prior to the end of that Processing Month.
- (iv) GEFA will respond to 100% of all incoming claims correspondence within 5 Business Days of receipt.
- (v) Claims assessment shall result in one of the following:
  - (a) decision to decline;

- (b) decision to accept/pay; or
- (c) decision to request further information from a customer/third party,

and, where appropriate, GEFA shall generate any documentation associated with the assessment.

(vi) Decline process:

A system generated letter is issued explaining the decision as part of the assessment process.

(vii) Decision to accept/pay process:

- (a) A letter will be sent to the customer confirming the acceptance of the claim and the payment to be made, clarifying any continuing duty on the customer (e.g. monthly provision of evidence) and including a continuing claim form.

57

---

- (b) A payment run will be executed at least weekly, unless otherwise stated in an Existing Local Agreement.

(viii) Further information required:

- (a) Where further information is required from a third party it will be notified to that third party by mail with a pre-paid business reply envelope. A letter informing the customer of this action will be issued at the same time.
- (b) Where further information is required from a customer he/she will be notified by mail with a pre-paid business reply envelope.
- (c) 21-day follow up will occur if there is no response received back from the third party.

## 8. Management Information associated with managing claims

### 8.1 The monthly dashboard for claims will show as a minimum:

- (i) the claims activity for the month comprising new claims registered, continuing claims, claims accepted, claims declined and pending duration (comprising number of claims pending and maximum, median and mean number of days pending);
- (ii) number and percentage of claims processed within the Service Level criteria for the period and average claim resolution time;
- (iii) number of outstanding claims to be assessed and outlook for following month;
- (vi) percentage of correspondence responded to within the Service Level; and
- (v) report on the results of the Claims Accuracy Audit.

The monthly dashboard will be delivered to GECC within 10 Business Days of Processing Month End.

## 9 Claims Accuracy Audit

### 9.1 Claims accuracy will be measured through an audit mechanism operated by GEFA and on an ad-hoc basis by GECC. Claims Decision Accuracy is based on the decision to pay/reject the claim based on the terms and conditions of the policy against the criteria set out in the claim form.

### 9.2 The Service Levels for Claims Decision Accuracy shall be:

- (i) GEFA shall allocate 100% of claims with a classification code (Redundancy/Disability/Critical illness etc).
- (ii) Accuracy of classification code allocated by GEFA shall exceed 99%.

58

---

(iii) Decision Accuracy shall be:

- (a) 97% or greater in calendar year 2004;
- (b) 98% or greater in calendar year 2005; and
- (c) 99% or greater in calendar year 2006,

on all GECC claims audited within the monthly audit period,

provided that, in respect of New Territories, Decision Accuracy shall be 97% or greater on all GECC claims audited within each monthly audit period in the 12 months following launch and thereafter shall be 99% or greater on all GECC claims audited within the monthly audit period.

## 10 Customer Satisfaction Surveys

### 10.1 Twice in every 12 months GECC will have the right to commission or carry out customer surveys in order to gauge the overall customer satisfaction level of the customer base. The aspirational target will be 80% satisfaction. GECC and GEFA shall run base line surveys in respect of all Local Agreements in the first 12 months after the Commencement Date. The costs of such surveys shall be shared equally by the Parties. A mutually agreed action plan will be implemented and shall include a target for surveys conducted in the next period on the basis of the results of the base line surveys.

### 10.2 Each Party, at the request of the other, shall on an ad hoc basis (but, save as otherwise provided below, in any event no more frequently than once in any 12 month period) conduct a satisfaction survey on the basis of a mutually agreed set of questions which shall seek to establish the degree to which the requesting party is satisfied

with the performance by the other party of its obligations under this schedule. On the basis of such survey the Parties shall implement a mutually agreed action plan which shall include a target for the next survey. If the requesting Party is unhappy with the results of any survey, a further survey shall be conducted within six months of the results of the previous survey or such other period of time as the Parties shall agree.

## **11 Complaints Handling Process**

**11.1** The definition of a complaint is “any expression of dissatisfaction whether justified or not”. Complaints shall, for the avoidance of doubt, include disputes in relation to claims decisions.

**11.2** A complaint must be dealt with to the customer’s satisfaction upon receipt of the phone call or the letter. If this is not possible, GEFA shall endeavour to provide the customer with a solution by close of business on next Business Day following receipt. Within 5 Business Days of receipt by GEFA of the complaint, the customer must be sent an acknowledgement letter advising them of a specific timeframe in which GEFA expects to resolve the problem. This should be recorded on a complaints log.

59

---

**11.3** If the complaint remains unresolved by the end of the 10th Business Day following receipt by GEFA of the claim, GEFA must escalate the complaint to Level 2, escalate to the Claims Manager or equivalent and reflect this on the log. If the complaint is still not resolved by Business Day 19, the complaint must be passed to Level 3.

**11.4** In Level 3 the complaint shall be escalated to the Operations Manager or equivalent. GEFA will endeavour to resolve the complaint within 8 weeks following initial receipt. If this is not achieved, the team will issue a holding response. If a solution is still not reached, the complaint handler will issue a final response. This will confirm to the customer that GEFA’s complaints procedure has been exhausted, and advise the complainant that he or she may refer the complaint to the Financial Ombudsman Service within 6 months of the date of the issue of this response.

**11.5** Where the Financial Ombudsman Service (or its equivalent in a Territory outside the UK) adheres to different guidelines than those outlined above at a local level then the local guidelines will be the service standard.

**11.6** GEFA shall notify to GECC all complaints on reaching Level 3 and in the case of complaints which are sensitive or controversial GEFA shall notify GECC immediately.

**11.7** Dashboard of Complaints showing volume, status and escalation level by type of complaint to be discussed at Monthly Performance Meetings with focus on root cause analysis.

## **12 IT Services**

**12.1** New scheme launches in Existing Territories, re-pricing, rate changes and interface programme amendments shall be in place in time for GECC deadline. Such deadline will always be at least 5 Business Days after GECC has notified GEFA.

**12.2** Performance of the obligation at paragraph 12.1 above shall be dependent on the following:

- (i) final product specifications including rates shall be provided as part of notification and at least 45 Business Days before implementation deadline;
- (ii) mutually agreed file format for new Scheme launches in all Territories shall be agreed and finalised at least 45 Business Days before implementation deadline; and
- (iii) representative and accurate test data which reflects the ‘to be’ file, in the previously agreed file format and with a sufficient level of detail to enable testing shall be provided by GECC 20 Business Days prior to commencement.

**12.3** Ad hoc requests for IT work will be assessed on their merits.

60

---

## **13 Pricing Requests**

**13.1** GEFA will deliver a response to pricing requests within 7 Business Days of receipt of a full product specification.

**13.2** The full product specification supplied by GECC shall comprise the information set out at paragraph 4 of Part A of Schedule 5, to the extent applicable and, in addition, clarification of any change in the customer base characteristics and miscellaneous detail when compared with other products in the appropriate Territory, if available.

## **14 Finance Requests**

**14.1** GEFA shall achieve 100% accuracy on profit share statements. Accuracy shall be measured by reference to the data used in GEFA’s US GAAP accounts and subsequently entered into the GECC profit share accounts and the structure of such profit share accounts.

**14.2** GEFA shall deliver profit share statements within 90 days of the end of each quarter.

**14.3** In the event of a financial query arising, GEFA will communicate to GECC a proposed course of action (including proposed timescales for resolution) by the end of the following Business Day

## **15 Legal Requests**

**15.1** Representatives of the Parties’ legal and compliance teams shall meet at appropriate intervals to discuss the prioritisation and targets for delivery of the work to be performed by the Parties’ legal and compliance teams pursuant to this agreement.

**15.2** GEFA shall, subject to paragraphs 15.1, 15.3, 15.4 and 15.5, deliver:

- (i) initial comments on new policy documents or proposed changes to existing policy documents (in each case relating to Payment Protection Products provided pursuant to Existing Direct Business) by the later of:

- (a) 10 Business Days after receipt by the GEFA legal and compliance team of the request to provide such comments and all of the relevant draft documents and information requested in relation thereto (including documents and/or information requested from GECC or any GECF Group Company); and

61

---

- (b) the date by which the relevant GECF Group Company requests such comments to be provided;
- (ii) initial comments on new fulfilment and marketing documents or proposed changes to existing fulfilment and marketing documents (in each case relating to Payment Protection Products provided pursuant to Existing Direct Business) by the later of:
  - (a) 10 Business Days after receipt by the GEFA legal and compliance team of the request to provide such comments and all of the relevant draft documents and information requested in relation thereto (including documents and/or information requested from GECC or any GECF Group Company); and
  - (b) the date by which the relevant GECF Group Company requests such comments to be provided;
- (iii) subject to acceptance by GECC or the relevant GECF Group Company of a New Business Proposal (or Amended New Business Proposal) pursuant to paragraph 10 of Part A of Schedule 5 (if applicable), a first draft of a Local Addendum by the later of:
  - (a) 15 Business Days after receipt by the GEFA legal and compliance team of the request to provide such first draft and all of the relevant information requested in relation thereto (including information requested from GECC or any GECF Group Company); and
  - (b) the date by which the relevant GECF Group Company requests such draft to be provided,

subject in each case, to such Local Addendum being substantially in the form set out in Schedule 11; and

- (iv) subject to acceptance by GECC or the relevant GECF Group Company of a New Business Proposal (or Amended New Business Proposal) pursuant to paragraph 10 of Part A of Schedule 5, a first draft of a New Local Agreement by the later of:
  - (a) 20 Business Days after receipt by the GEFA legal and compliance team of the request to provide such first draft and all of the relevant information requested in relation thereto (including information requested from GECC or any GECF Group Company); and
  - (b) the date by which the relevant GECF Group Company requests such draft to be provided,

subject in each case, to such New Local Agreement being substantially in the form set out in Schedule 12.

- 15.3** GECC agrees and acknowledges that if any of the documents requested or provided from or to the GEFA legal and compliance team pursuant to paragraph 15.2 are not, or not required to be in English, the timescales set out in paragraph 15.2 for delivery of comments or draft documents (as the case may be) will, in each such case, be increased by 10 Business Days or such longer period as is reasonably required to obtain an English translation of all relevant documents.

62

---

- 15.4** If changes are required to any Local Agreement or any documents relating to the Payment Protection Products provided by GEFA pursuant to this Agreement as a result of any proposed changes to any Applicable Law, GEFA will provide GECC with details of the proposed changes to the relevant documents at least 90 days before the implementation date of the proposed change to the relevant Applicable Law unless otherwise agreed by the parties (each acting in good faith), subject to receipt by the GEFA legal and compliance team of all of the relevant information requested in relation thereto (including information requested from GECC or any GECF Group Company).

- 15.5** The period for the production or review of documents by the GEFA legal and compliance team for a GECF Group Company in all other circumstances not contemplated in sub-paragraphs 15.2-15.4 above will be agreed by the parties at the time (each acting in good faith).

## **16 Business Continuity**

- 16.1** GEFA shall maintain a business recovery plan to make provision for the prompt and efficient handling of any incident which impairs GEFA's ability to perform the obligations required of it by this schedule.

- (i) GECC shall be made aware of the details of the business recovery plan and be kept advised of any significant changes to those details.
- (ii) The business recovery plan shall be subject to testing and review for effectiveness once a year.

- 16.2** A major disruption in service that impairs GEFA's ability to achieve a Service Level shall be notified to the agreed GECC escalation point if reasonably practicable on the Business Day on which the event occurs and otherwise within one Business Day of such event.

## **17 Dependencies**

GEFA shall not be liable for, and Service Credits shall not accrue in respect of, any failure by GEFA to meet its obligations in relation to Service Levels, where such failure results in whole or in part from:

- (i) any failure by GECC to perform its obligations under this schedule, including those obligations set out in the third column of Table A below; or
- (ii) any other act or omission of GECC.

63

---

## **Table A**

### **GECF Dependencies**

GEFA Key Service Levels	MEASUREMENT	GEFC DEPENDENCY
<b>Paragraphs 3.1(v) and 3.2(ii) of this Schedule</b>	Monthly Dashboards of NIP - Confirmed, Pending and Rejected.	NIP file must be received in the agreed format by GEFA at least 5 Business Days prior to Processing Month End and be relevant to the previous selling month. Any files received less than 5 Business Days prior to Processing Month End will be included in the following processing month. Pending list sent by GEFA to GECC must be reviewed, amended and sent back to GEFA within 5 Business Days of initial receipt by GECC. NIP which is missing information or information which is contrary to agreed parameters will be rejected and fall back in to the Pending process loop.
<b>Paragraph 3.2(ii) of this Schedule</b>	[ ]	The cash reconciliation is subject to receipt by GEFA of all relevant cash amounts payable by GECC pursuant to paragraph 3.2(i) by the end of the Processing Month subsequent to the Processing Month in respect of which the Reconciliation is performed.
<b>Paragraph 3 of this Schedule</b>	[ ]	GEFA's Service Level obligations under paragraph 3 of this schedule shall commence on or shall be suspended until (as the case may be) the later of: (i)(a) in respect of New Scheme launches in Existing Territories, the expiry of 45 Business Days from the date on which the file format is agreed pursuant to paragraph 12.2(ii) above or, if later, the expiry of 45

GEFA Key Service Levels	MEASUREMENT	GEFC DEPENDENCY
<b>Paragraphs 7.3(i) and 7.3(iii) of this Schedule</b>	Monthly Dashboards/ Sampling as required.	Business Days from the date on which GECC notifies GEFA of the final product specification pursuant to paragraph 12.2(i) above; or (i)(b) in respect of re-pricing, rate changes and interface amendments, the expiry of 45 Business Days from the date on which GECC notifies GEFA of the final product specification pursuant to paragraph 12.2(i) above; and (ii) the expiry of 20 Business Days from the date on which GECC complies with its obligation in paragraph 12.2(iii) above. GECC response required within one Business Day for claims against bulk business where input from GECC will be required.

**18 Key Service Levels**

Service Credits shall be weighted to the Key Service Levels as set out in Table B below:

**Table B**

**19 Primary Operational Metrics and Service Credits**

Primary Operational Metrics - Service Standards	
**	**
**	**
**	**
**	**
**	**
**	**
**	**

**20 Service Credit regime**

- 20.1** If GEFA fails to deliver the service as indicated by any of the above Key Service Level metrics in respect of a Local Agreement then GEFA shall reimburse GECC for the Service Credits.
- 20.2** Service Credits are applied to the specific Local Agreement that is in breach of Key Service Level.
- 20.3** One Service Credit equals \*\*% of the Retention Fee in respect of the relevant Local Agreement in that month:
- 20.4** Service Credits start accumulating in the same Processing Month in which a Key Service Level miss occurs.
- 20.5** Service Credits shall be paid in respect of a Key Service Level until such Key Service Level returns to agreed Service Levels.
- 20.6** No Service Credits shall accrue or be payable in respect of failures to meet Key Service Levels in the first six months of the Term.
- 20.7** Service Credits relate to new business going forward and not retrospectively to feeds received prior to the expiry of the period referred to in paragraph 19.6 above.
- 20.8** For the avoidance of doubt, clause 15 of the agreement shall apply to this schedule.

**Schedule 3**  
**New Local Agreement Profit Share Provisions**

- 1 GEFA shall draw up a profit and loss account in accordance with this Schedule and GEFA's standard US GAAP accounting policies and practices from time to time (the "Profit Share Account") including all Schemes grouped as agreed by the Parties in each Local Agreement separately (or, if only one Scheme has been in operation since the Commencement Date, for that Scheme only):
- as at the last day of each quarter of the term of the Local Agreement and annually during the Run-Off Period; or
  - as at the end of the Run-Off Period,
- (each a "Relevant Date").
- 2 GEFA shall deliver a copy of the Profit Share Account to GECC within 90 days (or as otherwise agreed between the Parties pursuant to Schedule 2) of the last day of each quarter of the term of this agreement and annually during the Run-Off Period and within 90 days of the last day of the Run-Off Period (as the case may be).
- 3 The Profit Share Account will be prepared to include all Business written since inception to date in each Scheme in each Territory as follows:
1. For each individual Scheme, GEFA shall calculate the Gross Earned Premiums
  2. From the total calculated under paragraph (a) above, the following shall be deducted:
    1. the Sales Commission incurred;
    2. Earned Retention;
    3. all claims payments made under the relevant Policies and related expenses incurred;
    4. Claims Reserves as held on the GEFA balance sheet for future claims payments under the relevant Policies as at the date to which Profit Share is being calculated;
    5. all applicable Tax/levies;
    6. all statutory, governmental or regulatory fees arising from or relating to a complaint made by an Insured Customer; and
    7. agreed extraordinary expenses incurred.

67

---

3. The resultant figure shall be the underwriting profits (the "Underwriting Profits") for the individual Scheme concerned. The Underwriting Profits for any individual Scheme may be positive or negative.
  4. Subject to this Schedule 3, the Profit Share for the individual Scheme concerned shall be calculated by multiplying the Underwriting Profits for that Scheme by the relevant GECC Profit Share Percentage pursuant to Clause 5. The Profit Share for any individual Scheme may also be positive or negative.
  5. If more than one Scheme qualifying for Profit Share calculation purposes has been in operation, GEFA shall calculate the consolidated profit or loss for all such Schemes within each Local Agreement by aggregating together all and any positive and negative Profit Shares for all relevant individual Schemes calculated under paragraphs (a) to (d) above.
  6. The Profit Share calculated as at the relevant date (which may be positive or negative) shall be the amount calculated under paragraphs (a) to (d) above (or, if more than one Scheme has been in operation, paragraphs (a) to (e) above):
    1. less an amount equal to any payments made by GEFA to GECC under paragraph 4 below in respect of previous Profit Share calculations;
    2. plus an amount equal to any payments made by GECC to GEFA under paragraph 5 below in respect of previous Profit Share calculations;
    3. less an amount equal to any previous Profit Share payments made by GEFA to GECC which GECC has repaid or is due to repay to GEFA for any reason.
- 4 If the Profit Share calculation is \*\* then GEFA shall \*\* thereof to GECC within 30 Business Days of delivery of the Profit Share Account (which for the avoidance of doubt shall include the Profit Share Account at the end of the Run-Off Period).
- 5 If the Profit Share calculation in respect of any Local Agreement in any calendar year is \*\* then the \*\* amount shall be \*\* years. If at the termination of this agreement the Profit Share Calculation is \*\*, then \*\* shall be made and the \*\* amount shall be \*\* the end of the Run-Off Period. If at the end of the Run-Off Period the Profit Share calculation is still \*\* then GECC shall \*\* amount thereof to GEFA within 30 Business Days of delivery of the Profit Share Account. In no event will this sum \*\* Profit Share payment has been made.
- 6 For the avoidance of doubt, \*\* shall be \*\* to GECC or to GEFA in respect of any period ending after the end of the last day of the Run-Off Period.

68

---

**Schedule 4**  
**Product Performance Monitoring**

**1. The Claims Performance Statement**

GEFA will provide to GECC a Claims Performance Statement on a quarterly basis to show the following information for each Scheme, product and cover type in respect of each Local Agreement. The following information will be shown for each quarter for the last two years (the most recent quarter to be included will be that

which ended six months prior to the date of the quarterly Profit Share Account):

- Earned Exposure in the quarter;
- Gross Earned Premium;
- Earned Claims Fund;
- Number of claims (including an estimate for claims which have occurred in that quarter but have not yet been reported);
- Claims paid;
- Claims reserved by type;
- Claims Frequency;
- Average duration of claims where relevant (e.g. for Accident and Sickness and Involuntary Unemployment claims);
- Gross Loss Ratio; and
- Risk Loss Ratio.

GEFA will include the data from the two quarters immediately preceding the end of the quarterly Profit Share Account, but the Parties acknowledge that the performance reflected by such data will not be mature because the development of reported claims takes two quarters and the detailed analysis will not yet be available.

Each claim will be allocated to a quarter in accordance with the date in which the claim occurred.

GEFA shall provide the first Claims Performance Statement to GECC based on data as at 3<sup>1st</sup> December 2003 on or by 3<sup>1st</sup> March 2004.

GECC and GEFA hereby agree that discussions relating to individual Schemes shall be restricted to those Schemes which are agreed to be of a size where the claims performance has stabilised but in determining whether or not such stabilisation has

occurred the Parties shall have regard to the performance of the relevant Schemes before they become subject to a Local Agreement as well as after.

In respect of Existing Business, GECC hereby agrees that if a Local Agreement, product or individual Scheme is identified at the Quarterly Performance Meeting as running at Loss Ratio greater than \*\* per cent., the Parties shall as soon as reasonably practicable hold good faith discussions to attempt to agree a plan and timetable for actions to bring any such Scheme or product to a Loss Ratio of \*\* per cent. Such plan shall include one or more of the following:

- Make changes to the amount of premium allocated to a particular cover;
- Increase the Claims Fund as a percentage of the Gross Written Premium;
- Make a change to the terms and conditions of the Policies in a particular scheme; or
- Such other mechanism as agreed between the Parties.

In respect of New Business, GEFA hereby agrees that if a Local Agreement or individual Scheme is identified at the Quarterly Performance Meeting as running at a Loss Ratio less than \*\* per cent or more than \*\* per cent, the Parties shall as soon as reasonably practicable hold good faith discussions to attempt to agree a plan and timetable for actions to bring any such Scheme or product or cover to a Loss Ratio of \*\* per cent. Such plan shall include one or more of the following:

- Make changes to the amount of premium allocated to a particular cover;
- Decrease the Claims Fund as a percentage of the Gross Written Premium;
- Make a change to the terms and conditions of the Policies in a particular scheme; or
- Such other mechanism as agreed between the Parties.

Any losses not previously notified by the date of this agreement or in the relevant quarter will not be carried forward and shall be borne \*\* per cent. by the relevant GEFA Company.

If a Loss Ratio in respect of a Local Agreement is greater than \*\*\*% and Parties agree such plan and if GECC fails to implement the plan in accordance with the timetable agreed at the Quarterly Performance Meeting, the current profit share split and arrangements shall continue to apply in accordance with the relevant Local Agreement but GECC will carry forward GEFA's \*\*\*% share of such underwriting loss.

**Schedule 5**  
**Potential New Business and Payment Protection**  
**Products Set-up Process**

The processes for determining whether Potential New Business shall be New Business and the set-up of New Business in a Territory are set out below in Parts A and B. The processes for addressing Material Change and Local Material Change referred to in Clauses 20.2.3 and 20.4.4 are set out in Part C below.

## PART A Potential New Business in New Territories where there is no Local Agreement

In relation to Potential New Business in New Territories where a Local Agreement is not in place (the following shall also apply to Potential New Business in Existing Territories or in Territories in which a Local Agreement is in place, subject to the provisions of Part B of this Schedule 5):

### 1 Notification

- (i) GECC shall, or shall procure that the relevant GECF Group Company shall, notify in writing the relevant Country Manager, relevant Regional Manager and GECC Relationship Manager, as soon as reasonably practicable of any Potential New Business required, with details of the Payment Protection Product or package of Payment Protection Products required and related services together with details of the proposed implementation timetable (which is to be reasonable and have regard to all circumstances). Notification shall be deemed to be given upon receipt of the notice by GEFA.
- (ii) If GEFA or a GEFA Company shall advise GECC or the relevant GECF Group Company in writing of its intention to submit a New Business Proposal to GECC in respect of Potential New Business, this will initiate the process described from paragraph 4 below onwards.

2 GEFA will then undertake basic fact finding on the insurance market, legal and regulatory systems in the prospective New Territory.

3 Within 7 Business Days of notification pursuant to paragraph 1 by GECC, or the relevant GECF Group Company, to GEFA, or the relevant GEFA Company, the relevant GEFA Company may provide in writing to the relevant GECF Group Company an expression of interest in providing the Potential New Business.

4 If the relevant GEFA Company has provided the expression of interest within 7 Business Days in accordance with paragraph 3 above, the relevant GECF Group Company will provide the relevant GEFA Company as soon as reasonably practicable with the following information in its or any GECF Group Company's possession or control on the Payment Protection Products and related services as set out in the notification given

71

---

pursuant to paragraph 1, subject to Applicable Laws and any confidentiality obligations on it:

- Size, age, statistics, male/female split, average term (actual and written) and interest charged on loans
- Description of the required Payment Protection Products which is as complete as is possible or a copy of the existing policy wording(s)
- Projected finance volumes and the projected insurance penetration rates over 3 years
- Historic gross premium volumes or historic finance volumes and insurance penetration rates
- Existing gross premium rates
- Location of GECC, GECF Group Company or Acquired GECF Business offices in country
- Existing method of reporting (i.e. paper application, electronic file)
- Method of premium collection
- Number of insured customers
- Method of policy fulfilment (GECC or Insurer)
- Staffing levels and facilities costs per associate to locate in existing GECC or Acquired GECF Business offices per country and general GECC Human Resources support/advice (if available)
- Historic loss ratios and definition of loss ratios
- Any other pertinent information (including any renewal, termination or expiry dates of agreements with third parties)

Upon providing the above information to the relevant GEFA Company, the relevant GECF Group Company shall certify that, subject to confidentiality obligations and Applicable Laws, it has provided all such information.

5 Within 20 Business Days of the date of certification provided by the relevant GECF Group Company pursuant to paragraph 4 above, GEFA shall procure that the relevant GEFA Company shall prepare and submit to the relevant GECF Group Company a written proposal (the "**New Business Proposal**") setting out its proposed terms and conditions for the provision of Payment Protection Products and related services for the Potential New Business, which shall include the following:

72

---

- 5.1 confirmation that the New Business Proposal is for the provision of the totality of the required Payment Protection Products and related services required for the relevant GECF Group Company or Acquired GECF Business as notified by GECC pursuant to paragraph 1;
- 5.2 the commercial terms for the provision of the Potential New Business which shall be:
  - 5.2.1 in accordance with clause 5 of this agreement (for the avoidance of doubt, if the Potential New Business involves a New Channel, the Retention Rate may be altered pursuant to Paragraphs 7.1-7.3 of Part III of Schedule 16); and
  - 5.2.2 in relation to Potential New Business required for an \*\* (provided that the terms disclosed to GEFA pursuant to paragraph 4 above are the bona fide terms);
- 5.3 confirmation that, where the relevant GECF Group Company or Acquired GECF Business has existing arrangements or agreements with a third party or



another company in its Group, the relevant GEFA Company will \*\* the relevant GECF Group Company or Acquired GECF Business in accordance with the terms of clause 3.2.5(i)(b) for \*\* (which have been disclosed pursuant to paragraph 4 by GECC or a GECF Group Company and which would be incurred in \*\*;

- 5.4 the proposed implementation timetable for providing the Payment Protection Products and related services;
- 5.5 confirmation that the relevant GEFA Company has obtained the required regulatory or other licences to provide the required Payment Protection Products and related services in the Territory to the relevant GECF Group Company or Acquired GECF Business or, if the relevant GEFA Company does not hold the required regulatory or other licences, the proposed steps and timetable for obtaining such licences;
- 5.6 details of:
  - 5.6.1 a plan setting out the various steps, tasks and resources required to implement the Potential New Business with a timetable and responsibilities;
  - 5.6.2 any (i) branch set up with GEFA office & administration in the Territory; or (ii) office & administration set up in a neighbouring Territory; or (iii) partnership with local companies to provide administration and related services;
  - 5.6.3 GEFA IT & Operations support;

73

---

- 5.6.4 GEFA Legal support on legal and regulatory issues in the Territory in relation to the provision of Payment Protection Products and related services;
  - 5.6.5 GEFA Finance and Risk support in relation to finance and risk issues in the Territory in relation to the provision of Payment Protection Products and related services;
  - 5.6.6 confirmation of applicable GEFA internal risk approval; and
  - 5.6.7 GECC HR support/advice required; and
  - 5.7 whether it wishes the relevant GECF Group Company or Acquired GECF Business to host GEFA start up offices within their premises at a cost equivalent to GECF Group Companies or Acquired GECF Business \*\* from the Commencement Date of the relevant Local Agreement and the terms of such arrangement.
- 6 Upon receipt of the New Business Proposal, the relevant GECF Group Company shall assess the New Business Proposal according to the requirements of the Potential New Business and whether the following criteria have, in its reasonable opinion, in all material respects been met:
- 6.1 the New Business Proposal covers all of the Payment Protection Products and related services as set out in the notification made pursuant to paragraph 1 above;
  - 6.2 the New Business Proposal will be able to operate within the Loss Ratio target of \*\* per cent.;
  - 6.3 Subject to Clause 9.4.7, GEFA is in compliance with its obligations in respect of the Product Development Plan set out in Clause 9.4.4 in the relevant Territory and, where GECC has informed GEFA that GECC intends to provide the relevant Offering in an Existing Territory, GEFA must have created and be implementing a Product Development Plan in respect of the Existing Territory. Where GECC has informed GEFA that it intends to provide the Offering in a New Territory as well as Existing Territories, GEFA must have:
    - 6.3.1 created a Product Development Plan in respect of the New Territory; and
    - 6.3.2 created and be implementing a Product Development Plan in respect of \*\* per cent. of the Existing Territories in which GECC has informed GEFA that it intends to provide the Offering;
  - 6.4 the relevant GEFA Company will be able to provide all of the Payment Protection Products and related services as set out in the notification made pursuant to paragraph 1 above in compliance with the Service Levels;

74

---

- 6.5 the relevant GEFA Company will be able to commence provision of the Payment Protection Products and related services within the timetable set out in the notification made pursuant to paragraph 1 above;
- 6.6 the relevant GEFA Company has obtained or will have obtained the required regulatory or other licensing to provide the required Payment Protection Products and related services in the Territory in accordance with paragraph 5.5;
- 6.7 in relation to an Existing Territory or a Territory where a Local Agreement is in place, the relevant GEFA Company has a system and infrastructure in place which will be able to administer and support the Potential New Business;
- 6.8 in relation to a New Territory where there is no Local Agreement in place:
  - 6.8.1 the relevant GEFA Company will have a system and infrastructure in place which will be able to administer and support the Potential New Business within the timetable set out in the notification made pursuant to paragraph 1 above; and
  - 6.8.2 in at least one of the previous two months from the date of GEFA's proposal the relevant GEFA Companies shall either:
    - (i) not have accrued Service Credits; or
    - (ii) (in the first six months of the Term) are and have been complying with the Key Service Levels,  
in at least 75 per cent. of the Territories where a Local Agreement is in place including all of the Key Territories; and
- 6.9 in relation to an Existing Territory, in at least one of the previous two months, the relevant GEFA Company shall either (i) not have accrued Service Credits or (ii) (in the first six months of the Term) is and has been complying with all the Key Service Levels; and

**6.10** the New Business Proposal has been priced in accordance with the provisions of Paragraph 3 of Part II of Schedule 16 (if the New Business Proposal does not involve a New Channel) and Paragraphs 7.1-7.3 of Part III of Schedule 16 (if the New Business Proposal does involve a New Channel).

7

**7.1** If the New Business Proposal satisfies the criteria set out in paragraph 6 above, the relevant GECF Group Company shall within 10 Business Days of receipt of such New Business Proposal, give written notice to the relevant GEFA Company of its acceptance of the New Business Proposal, subject to the relevant GEFA Company obtaining all necessary regulatory approvals.

75

---

**7.2** If the relevant GECF Group Company rejects the New Business Proposal, it shall provide detailed written reasons for such rejection setting out the criteria that have not been satisfied. Where the relevant GECF Group Company rejects the New Business Proposal, the relevant GEFA Company shall have the right within 5 Business Days of receipt of notification of such rejection to:

- (i) propose amendments to the New Business Proposal, in which case paragraph 8.2 shall apply; and/or
- (ii) refer the matter to the dispute resolution procedure set out in clause 15.2, in which case the Parties shall resolve the Dispute within 5 Business Days of the date of receipt by the relevant GEFA Company of the notice rejecting the New Business Proposal (or such longer period as the Parties may agree).

**7.3** If the requirements of paragraph 6 have not been satisfied the relevant GECF Group Company may propose to accept the New Business Proposal, subject to such amendments as it sees fit, in which case it shall inform the relevant GEFA Company in writing of such amendments together with the reasons for such amendments, and paragraph 8 shall apply.

**8** If the relevant GECF Group Company proposes amendments to the New Business Proposal:

**8.1** the relevant GEFA Company may, within 5 Business Days of the date of the notice of such proposed amendments, resubmit an amended proposal in writing (the "Amended New Business Proposal"); and

**8.2** upon receipt of the Amended New Business Proposal, the relevant GECF Group Company shall assess such Amended New Business Proposal according to the criteria set out in paragraph 6 above and shall provide detailed written notice to the relevant GEFA Company of its decision to accept or reject the Amended New Business Proposal (in the case of rejection, with detailed written reasons) within 5 Business Days .

9

**9.1** Where the relevant GECF Group Company rejects a New Business Proposal or Amended New Business Proposal according to the criteria set out in paragraphs 6 above (other than on the basis of the Risk Rate), GECC and the relevant GECF Group Company shall have no obligation to appoint GEFA or any GEFA Company as its provider, whether exclusive or otherwise, in the relevant Territory in respect of the New Business Proposal and GECC shall be free to enter into discussions, tenders, negotiations, arrangements and agreements with third parties and/or other GECF Group Companies in respect of the relevant New Business Proposal. The relevant GECF Group Company shall invite GEFA to take part in any subsequent tender process conducted by the relevant GECF Group Company in respect of the New Business Proposal provided that the relevant GEFA

76

---

Company agrees that the provisions for determining the Retention Rate and the Risk Rate for the New Business Proposal as set out in Parts II and Part III (as the case may be) of Schedule 16 (Business Proposal Pricing Process) shall apply to their submission save that, if an Actuary were to determine the Risk Rate pursuant to Paragraphs 5 or 9.2 of Schedule 16 (as the case may be), then the relevant GECF Group Company or the relevant GEFA Company would be entitled to reject the proposed Risk Rate. In either case, the relevant GECF Group Company would be entitled to award the tender to any third party.

**9.2** Where the relevant GECF Group Company rejects a New Business Proposal or Amended New Business Proposal on the basis of the proposed Risk Rate, then the procedure commencing in Paragraph 5 of Part II of Schedule 16 (if the Business Proposal does not involve a New Channel) or the procedure commencing in paragraph 9.2 of Part III of Schedule 16 (if the Business Proposal does involve a New Channel) shall be implemented.

**10** If pursuant to paragraph 7 or 8 or 9.2 above the relevant GECF Group Company and the relevant GEFA Company agree the terms of the New Business Proposal (or the Amended New Business Proposal), the relevant GECF Group Company and the relevant GEFA Company shall finalise the terms of the addendum to the Local Agreement or, where relevant, the terms of a New Local Agreement, provided that:

- (i) in relation to single premium Potential New Business, whether such Potential New Business shall be \*\* shall be determined by the relevant GECF Group Company in its absolute discretion provided that Identified New Business shall be determined in accordance with Schedule 1C; and
- (ii) in relation to monthly premium Potential New Business, such Potential New Business shall be \*\* unless the relevant GEFA Company, in its absolute discretion, consents to it being New \*\*.

The parties shall make available suitably senior representatives to finalise such terms.

**11** Once the Local Addendum or New Local Agreement (as the case may be) has been finalised pursuant to paragraph 10 above then, subject to the relevant GEFA Company having obtained and providing written evidence to the relevant GECF Group Company that it has obtained the required regulatory or other licences to provide the required Payment Protection Products and related services in the relevant Territory, the relevant GECF Group Company and the relevant GEFA Company shall promptly enter into the addendum to the Local Agreement or New Local Agreement (as the case may be) at which point the Potential New Business shall be New Business for the purposes of this agreement.

**12** If:

**12.1** the relevant GEFA Company has not provided written notification of its expression of interest to the relevant GECF Group Company within the 7 Business Day period in accordance with paragraph 3 above;

77

---

- 12.2 the relevant GEFA Company has not provided the New Business Proposal to the relevant GECF Group Company within the 20 Business Day period in accordance with paragraph 5 above;
- 12.3 where applicable, the relevant GEFA Company has not provided the Amended New Business Proposal to the relevant GECF Group Company within the 5 Business Day period in accordance with paragraph 8.1 above; or
- 12.4 where applicable, the relevant GECF Group Company has rejected the Amended New Business Proposal in accordance with paragraph 8.2 above,
- 12.5 and provided GECC or the relevant GECF Group Companies have properly rejected the New Business Proposal or Amended New Business Proposal (as the case may be), for the remainder of the Term of this agreement, the relevant GECF Group Company or Acquired GECF Business shall have no obligation to appoint, GEFA or any GEFA Company as its provider, whether exclusive or otherwise, in the relevant Territory in respect of the relevant Potential New Business the subject of the notification pursuant to paragraph 1 and the relevant GECF Group Company or Acquired GECF Business shall have no obligation to terminate or give notice of termination in relation to any existing arrangements or agreements relating to the relevant Potential New Business and shall be free to enter into discussions, tenders, negotiations, arrangements and agreements with third parties and/or other companies in its Group in respect of the relevant Potential New Business.

**Part B Potential New Business in Existing Territories or Territories where a Local Agreement is in place**

In relation to Potential New Business in Existing Territories or Territories where a Local Agreement is in place, the following paragraphs of Part A shall apply as amended below:

- 13 paragraph 1;
- 14 paragraph 3;
- 15 paragraph 4;
- 16 paragraph 5 provided that references to “20 Business Days” shall be read as references to “10 Business Days”
- 17 paragraph 6;
- 18 paragraph 7;
- 19 paragraph 8;
- 20 paragraph 9;

- 21 paragraph 10 ;
- 22 paragraph 11; and
- 23 paragraph 12 provided that references to “20 Business Days” in paragraph 12.2 shall be read as references to “10 Business Days”;

**Part C: Material Change Process**

If, pursuant to clause 20.2.3 or 20.4.4, GECC has issued a written notice to GEFA, the procedure to be followed shall be as follows:

- 24 GECC shall, or shall procure that the relevant GECF Group Company shall, and GEFA shall, or shall procure that the relevant GEFA Company shall, enter into good faith discussions for a period of 30 Business Days commencing on the date of the notice issued pursuant to clause 20.2.3 or clause 20.4.4 (the “Consultation Period”) to seek to agree an appropriate solution to the Material Change or Local Material Change (as the case may be).
- 25 On or by the date falling 20 Business Days after the end of the Consultation Period, GEFA shall, or GEFA shall procure that the relevant GEFA Company shall, prepare and submit to GECC or the relevant GECF Group Company a written proposal (the “Material Change Proposal”) setting out its proposed or amended terms and conditions for the provision of Payment Protection Products and related services in response to the Material Change or Local Material Change (as the case may be) (the “Material Change Business”), which shall include the following:
  - 25.1 confirmation that the Material Change Proposal is for the provision of all of the required Payment Protection Products and related services required by GECC or the relevant GECF Group Company as notified by GECC pursuant to clause 20.2.3 or clause 20.4.4;
  - 25.2 the commercial terms for the provision of the Material Change Business which shall be in accordance with clause 5 of this agreement;
  - 25.3 the proposed timetable for providing the Payment Protection Products and related services in response to the Material Change or Local Material Change (as the case may be);
  - 25.4 in relation to each relevant Territory, confirmation that the relevant GEFA Company holds the required regulatory or other licences to provide the required Payment Protection Products and related services in response to the Material Change or Local Material Change (as the case may be) to the relevant GECF Group Company or Acquired GECF Business or, if the relevant GEFA Company does not hold the required regulatory or other licences, the proposed steps and timetable for obtaining such licences;

- 25.5 details of its infrastructure in the Territory which shall be able to administer and support the Material Change Business;
- 26 Upon receipt of the Material Change Proposal, GECC or the relevant GECF Company shall assess the Material Change Proposal according to whether in its reasonable opinion the Material Change Proposal provides a solution to the Material Change or Local Material Change (as the case may be) and whether, in its reasonable opinion, the Material Change Proposal satisfies in all material respects in each relevant Territory the following criteria:
  - 26.1 the Material Change Proposal covers all of the Payment Protection Products and related services as notified by GECC or the relevant GECF Group Company pursuant to clause 20.2.3 or clause 20.4.4;

- 26.2 the relevant GEFA Company will be in a position to provide the Payment Protection Products and related services as notified by GECC or the relevant GECF Group Company pursuant to clause 20.2.3 or clause 20.4.4 in compliance with applicable Service Levels;
- 26.3 the relevant GEFA Company will be able to commence provision of the Payment Protection Products and related services in response to the Material Change or Local Material Change (as the case may be) within the timetable as notified by GECC or the relevant GECF Group Company pursuant to clause 20.2.3 or clause 20.4.4;
- 26.4 the relevant GEFA Company has obtained or is in the process of obtaining the required regulatory or other licences to provide the required Payment Protection Products and related services in response to the Material Change or Local Material Change (as the case may be) pursuant to paragraph 2.4;
- 27 Within 10 Business Days of receipt of the Material Change Proposal, the relevant GECF Group Company shall give written notice of its decision to GEFA or the relevant GEFA Company to accept or reject the Material Change Proposal. If GECC or the relevant GECF Group Company rejects the Material Change Proposal, it shall provide detailed written reasons for such rejection. GECC or the relevant GECF Group Company may propose to accept the Material Change Proposal subject to such amendments as it sees fit in which case it shall inform GEFA or the relevant GEFA Company in writing of such amendments together with the reasons for such amendments.
- 28 If GECC or the relevant GECF Group Company rejects the Material Change Proposal or proposes amendments to the Material Change Proposal:
- 28.1 GEFA or the relevant GEFA Company may, within 5 Business Days of the date of the notice of such rejection or proposed amendments, resubmit an amended proposal in writing (the “**Amended Material Change Proposal**”); and
- 28.2 upon receipt of the Amended Material Change Proposal, GECC or the relevant GECF Group Company shall assess such Amended Material Change Proposal and

80

---

shall provide written notice to GEFA or the relevant GEFA Company of its decision to accept or reject the Amended Material Change Proposal (in the case of rejection, with detailed written reasons) within 5 Business Days.

- 29 If pursuant to paragraph 4 or 5 above, GECC or the relevant GECF Group Company and GEFA or the relevant GEFA Group Company agree the terms of the Material Change Proposal (or the Amended Material Change Proposal), GECC or the relevant GECF Group Company and GEFA or the relevant GEFA Company shall finalise the terms of the addendum to the relevant Local Agreement, and the parties shall make available representatives to finalise such terms.
- 30 Once the Local Addendum has been finalised pursuant to paragraph 6 above, then subject in each relevant Territory to the relevant GEFA Company having obtained and providing written evidence to the relevant GECF Group Company that it has obtained the required regulatory or other licences to provide the required Payment Protection Products and related services in response to the Material Change or Local Material Change (as the case may be), the relevant GECF Group Company and the relevant GEFA Company shall enter into the addendum to the Local Agreement.
- 31 If:
- 31.1 GEFA or the relevant GEFA Company has not provided the Material Change Proposal to GECC or the relevant GECF Group Company within the 20 Business Day period in accordance with paragraph 2 above;
- 31.2 GEFA or the relevant GEFA Company has not provided the Amended Material Change Proposal to GECC or the relevant GECF Group Company within the 5 Business Day period in accordance with paragraph 5.1 above; or
- 31.3 GECC or the relevant GECF Group Company has rejected the Amended Material Change Proposal in accordance with paragraph 5.2 above;
- 31.4 then paragraph 9 shall apply.
- 27 Where this paragraph 9 applies GECC or the relevant GECF Group Company shall have the right to contact, potential Replacement Suppliers in each relevant Territory, to agree terms for the provision of the Payment Protection Products provided by the relevant GEFA Company as at the date of the notice pursuant to clause 20.2.3 or 21.4.4 (as the case may be), any such agreements being conditional on the termination of the relevant Local Agreement.
- 28 If GECC or the relevant GECF Group Company is able to agree such terms with a potential Replacement Supplier in a Territory it shall \*\* by the potential Replacement Supplier in all material respects.
- 29 GEFA or the relevant GEFA Company shall within 20 Business Days of the date of the offer in paragraph 10 accept or reject the terms of the offer. In the event that the offer is accepted, the relevant parties shall promptly agree an addendum to the relevant Local

81

---

Agreement which reflects the terms of the offer and the relevant GEFA Company shall continue to be the exclusive supplier to the relevant GECF Group Company of Payment Protection Products in the relevant Territory. If:

- 29.1 GEFA or the relevant GEFA Company rejects the offer; or
- 29.2 GEFA or the relevant GEFA Company does not respond within the timescale set out above,  
paragraph 12 shall apply.
- 30 Where this paragraph 12 applies, GECC or the relevant GECF Group Company shall have the right to terminate this agreement (in the case of a Material Change) or the relevant Local Agreement (in the case of a Local Material Change).

82

## 1 Quarterly Performance Meetings

On a quarterly basis, or as otherwise agreed between the parties, a formal review of the overall relationship between GECC and GEFA will take place. This will be attended by the Relationship Managers of GECC and GEFA, GEFA Regional Managers, GECC Regional Insurance Managers, and further representatives of GEFA and GECC as appropriate. Key agenda items for the quarterly meeting will include:

- (a) Profit Share Account - to be provided by GEFA to GECC in accordance with Schedule 3 and timeframe;
- (b) Scheme performance including the Claims Performance Statement to be provided by GEFA to GECC in accordance with Schedule 4 at least 10 Business days prior to the quarterly meeting;
- (c) Loss Ratio and action plans to ensure that the Loss Ratio is maintained at an adequate level in accordance with Schedule 4;
- (d) New Payment Protection Product development and penetration/growth initiatives;
- (e) Service Credits; and
- (f) Claims Reserve methodology and calculation.

## 2 Monthly Performance Meetings

On a monthly basis, or as otherwise agreed between the Parties, a formal review of the overall relationship between GECC and GEFA will take place. This will be attended by the Relationship Managers of GECC and GEFA, GEFA Regional Managers, GECC Regional Insurance Managers, and further representatives of GEFA and GECC (including finance, risk and operations) as appropriate. Key agenda items for the monthly meeting will include:

- (a) Service Levels (to include premium reconciliation, issues/risk log and escalated items);
- (b) Service Credits; and
- (c) Potential New Business opportunities.

83

---

## Part B: Local Agreement Performance Meetings

### 3 Weekly Meetings

On a weekly basis, or as otherwise agreed between the Parties, a formal review will be held in each Territory. This may take place either by telephone or on a 'face-to-face' basis. As a minimum the attendees will include the GEFA Account Manager for the Territory and the local GECC Insurance Leader.

The results of the meeting will be recorded in a 'Meeting Log'. All issues/tasks relevant to the country concerned will be entered into this log and on a weekly basis the position will be updated. Specific reference will be made to parties responsible for actions and applicable deadlines.

At the end of each week, a joint communication is to be distributed to appropriate individuals within GECC and GEFA. This will update progress on key projects.

### 4 Monthly Meetings

On a monthly basis, or as otherwise agreed between the Parties, a formal review will take place for each country on a regional basis. This will be attended by the GEFA Regional Manager and GECC Regional Insurance Manager, and will be held in one of the Territories within the region on a rotation basis. The local GEFA Account Managers and GECC Insurance Leaders will attend either by telephone or in person depending on the location of the meeting.

Key Agenda Items for this meeting will include: Service Levels, Scheme Performance by way of Management Information Reports, New Product Development and Penetration/Growth Initiatives.

84

---

## Schedule 7 Supplemental Sales Commission

1 From 1st January, 2004, if in accordance with clause 5.3, the total Gross Written Premium for Existing Direct Business and Existing Reinsured Business exceeds the Incentive Threshold in a calendar year then GECC will receive a supplemental sales commission (the "Supplemental Sales Commission"). The Supplemental Sales Commission applies to the element of Existing Direct Business Gross Written Premium in excess of the Incentive Threshold and comprises:

- (a) Additional Sales Commission; and
- (b) Additional Profit Share.

2 GEFA shall calculate the Incentive Threshold in accordance with the following procedure:

2.1 At the end of each calendar month the Gross Written Premium for Existing Business in each Territory will, subject to paragraph 2.2 below, be converted to Euro using the exchange rates set out at Schedule 10.

2.2 The sum total of the 12 months will be the calendar year total for each Territory, and then the overall total Gross Written Premium for Existing Business is calculated as:

- (a) Gross Written Premiums on Existing Reinsured Business in the calendar year (including GWP in respect of any Existing Reinsured Business which has been migrated to New Reinsurance Business); plus
- (b) Gross Written Premiums on Existing Direct Business in the calendar year for single premium up-front policies; plus

(c) Gross Written Premiums on Existing Direct Business in the calendar year for monthly premium policies.

3 If the total Gross Written Premium for Existing Business is \*\* than the Incentive Threshold then the Supplemental Sales Commission is payable on the Existing Direct Business Gross Written Premium \*\* of the Incentive Threshold ("Excess").

4 The Supplemental Sales Commission payable to GECC is then determined as:

(a) Additional Sales Commission at the rate of \*\*% of the Excess and shall be reviewed annually by the Parties on the basis of any change to the mix of Retention Rates in respect of Existing Business ; and

(b) Additional Profit Share at the rate of \*\*% of the Underwriting Profits relating to the Excess calculated as:

85

---

Underwriting Profits in the calendar year for all Existing Business \*\* by the total Gross Earned Premium for all Existing Business \*\* by the Gross Earned Premium on the Excess.

86

---

### Schedule 8 Local Agreements

#### DENMARK

**PARTIES:** FINANCIAL ASSURANCE COMPANY LIMITED and FINANCIAL INSURANCE COMPANY LIMITED, acting through their Danish branches: GE LIVSFORSIKRING and GE SKADESFORSIKRING and GE CAPITAL BANK, DENMARK, a Danish branch of GE CAPITAL BANK AB.

Addendum - 47

**COMMENCEMENT DATE** - - 1 JANUARY 2001

#### NORWAY

**PARTIES:** FINANCIAL INSURANCE COMPANY LIMITED and FINANCIAL ASSURANCE COMPANY LIMITED and GE CAPITAL BANK AS.

**COMMENCEMENT DATE** - - 1 JANUARY 2001

#### SWEDEN

**PARTIES:** FINANCIAL ASSURANCE COMPANY LIMITED and FINANCIAL INSURANCE COMPANY LIMITED represented by GE Financial Insurance Sverige and GE CAPITAL BANK AB

Addendum - TBC

**COMMENCEMENT DATE** - - 1 AUGUST 2000

#### UK

**PARTIES:** FINANCIAL ASSURANCE COMPANY LIMITED and FINANCIAL INSURANCE COMPANY LIMITED and GE CAPITAL BANK LIMITED

Addendum - TBC

**COMMENCEMENT DATE** - - 2000

#### UK AUTO

**PARTIES:** COMBINED LIFE ASSURANCE COMPANY LIMITED and LONDON GENERAL INSURANCE LIMITED and FINANCIAL ASSURANCE COMPANY LIMITED and FINANCIAL INSURANCE COMPANY LIMITED (Reinsurance Agreement). Corresponding Fronting insurance agreement in place with GECC.

Addendum - 1

87

---

**COMMENCEMENT DATE** - - 1 JANUARY 2000

#### IRELAND

**PARTIES:** COMBINED LIFE ASSURANCE COMPANY OF EUROPE LIMITED and LONDON GENERAL INSURANCE COMPANY LIMITED and FINANCIAL ASSURANCE COMPANY LIMITED and FINANCIAL INSURANCE COMPANY LIMITED (Reinsurance Agreement). Corresponding Fronting insurance agreement in place with GECC.

Addendum - 1

**COMMENCEMENT DATE** - - 1 JANUARY 2000

#### GERMANY

**PARTIES:** COMBINED LIFE ASSURANCE COMPANY LIMITED and LONDON GENERAL INSURANCE COMPANY LIMITED acting through its German

branch: London General Insurance Company Limited, Niederlassung Deutschland and FINANCIAL ASSURANCE COMPANY LIMITED and FINANCIAL INSURANCE COMPANY LIMITED acting through their German branches: Financial Assurance Company Limited, Lebensversicherung, Niederlassung Deutschland and Financial Insurance Company Limited, Niederlassung Deutschland. (Reinsurance Agreement). Corresponding Fronting insurance agreement in place with GECC.

Addendum - 6

**COMMENCEMENT DATE** - - 1 DECEMBER 2000

**SWITZERLAND**

**PARTIES:** GE CAPITAL BANK and FINANCIAL INSURANCE COMPANY LIMITED

Addendum - 5

**COMMENCEMENT DATE** - - 1 APRIL 2000

**SPAIN**

**PARTIES:** COMBINED LIFE ASSURANCE COMPANY OF EUROPE LIMITED acting through its Spanish branch: COMBINED LIFE ASSURANCE COMPANY OF EUROPE, SUCURSAL EN ESPAÑA and LONDON GENERAL INSURANCE COMPANY LIMITED acting through its Spanish branch: LONDON GENERAL INSURANCE COMPANY LIMITED, SUCURSAL EN ESPAÑA and GE Financial Assurance, Compañía de Seguros y Reaseguros de Vida, S.A. and GE Financial Insurance, Compañía de Seguros y Reaseguros, S.A. (Reinsurance Agreement). Corresponding Fronting insurance agreement in place with GECC.

88

---

Addendum - TBC

**COMMENCEMENT DATE** - - 1 JANUARY 2000

**PORTUGAL**

**PARTIES:** COMBINED LIFE ASSURANCE COMPANY LIMITED and LONDON GENERAL INSURANCE COMPANY LIMITED acting through its Portuguese Branch: LONDON GENERAL INSURANCE COMPANY LIMITED, SUCURSAL EM PORTUGAL and Financial Insurance Company Limited (Company No. 1515187) and Financial Assurance Company Limited, acting through their Portuguese branches: Financial Insurance Company Limited, C.R.C.L and Financial Assurance Company Limited. (Reinsurance Agreement). Corresponding Fronting insurance agreement in place with GECC.

Addendum - TBC

**COMMENCEMENT DATE** - - 1 MAY 2000

**ITALY**

**PARTIES:** Financial Insurance Company Limited and Financial Assurance Company Limited and GE Capital Servizi Finanziari S.r.l.

Addendum - TBC

**COMMENCEMENT DATE** - - 1 JULY 2001

**FRANCE**

TBC

89

---

**Schedule 9  
GEFA Group Companies**

- GEFA International Holdings Inc.
- GEFA UK Finance Limited
- GEFA UK Holdings Limited
- CFI Administrators Limited
- Financial Insurance Guernsey PCC Limited
- FIG Ireland Limited
- RD Plus SA
- Financial Insurance Group Services Limited
- Financial Assurance Company Limited
- Financial New Life Company Limited

- Consolidated Insurance Group Limited
- Financial Insurance Company Limited
- GE Financial Insurance Compania de Seguros y Reaseguros S.A.
- GE Financial Assurance Compania de Seguros y Reaseguros de vida S.A.
- Vie Plus S.A.
- UK Group Holding Company Limited
- Assocred S.A.

90

**Schedule 10  
EXCHANGE RATES**

**Exchange rates**

	Currency	\$1=	1 Euro =
<u>Existing</u>			
UK	UKP	0.630	0.720
Ireland	EUR	0.876	1.000
Germany	EUR	0.876	1.000
Spain	EUR	0.876	1.000
Portugal	EUR	0.876	1.000
Sweden	SEK	8.132	9.287
Denmark	DKK	6.525	7.452
Norway	NOK	7.334	8.375
Switzerland	CHF	1.340	1.530
Italy	EUR	0.876	1.000
France	EUR	0.876	1.000
<u>New</u>			
**	**	0.876	1.000
**	**	**	**
**	**	**	**
**	**	**	**

91

**Schedule 11  
Form of Local Addendum**

This Addendum is made on [ ] between:

- (1) [•] whose registered office is at [•] (the “**Insurer**”); and
- (2) [•] whose registered office is at [•] (the “**GECF Bank**”).

**Recitals**

- (A) The Insurer and the GECF Bank are parties to a Master Agreement dated [•] (as amended) in relation to the provision of PPI Cover (the “**Master Agreement**”).
- (B) The Insurer and the GECF Bank wish to amend the Master Agreement in accordance with the terms of this Addendum.

It is agreed as follows:

**1 Interpretation**

In this Addendum words and expressions defined in the Master Agreement and the Framework Agreement have the same meanings herein unless the content otherwise requires or specifically defined below.

**2 Definitions**

“**Framework Agreement**” means the framework agreement dated [•] between GE Financial Assurance Holdings Inc. and [GE Consumer Finance].

**Amendment**

The parties agree that the terms of the Master Agreement will be amended in accordance with the provisions of this Addendum with effect from the date of this Addendum and references in the Master Agreement to “**this Agreement**” or otherwise to the agreement between the parties for the provision of PPI shall be deemed to be references to the Master Agreement as amended by this Addendum.

**Provisions of the Framework Agreement to apply to the Master Agreement**

The parties agree that the Master Agreement shall be amended to give effect to the Framework Agreement including the following clauses:



- 4.1 clause 2.3;
- 4.2 clause 3.1 and 3.2 (in respect of Existing Business, Substitute Business and Potential Substitute Business);
- 4.3 clause 4;

92

---

- 4.4 clause 6.1.1;
- 4.5 clause 8;
- 4.6 clause 9.1, 9.2, 9.4 and Schedule 2;
- 4.7 clause 10.2;
- 4.8 clause 11;
- 4.9 clause 12.1;
- 4.10 clause 13;
- 4.11 clause 15;
- 4.12 clause 16.2 and Schedule 6 Part B;
- 4.13 clause 17;
- 4.14 clause 18;
- 4.15 clause 20.4;
- 4.16 clause 21.3;
- 4.17 clause 22;
- 4.18 clause 23; and
- 4.19 clause 24.
- 4.20 In respect of each Local Addendum, the assignment and subcontracting provisions incorporated by virtue of clause 4.14 above shall be supplemented by the addition of the following sub-clause:
- 4.21 *“Notwithstanding anything in this Clause [Assignment Clause], all of the rights and obligations of the Financial Assurance Company Limited under this Agreement shall automatically transfer to Financial New Life Company Limited upon the transfer scheme for the transfer of all or substantially all of Financial Assurance Company Limited’s business to Financial New Life Company Limited pursuant to section 105 Financial Services and Markets Act 2000 becoming effective (with such amendments, deletions or additions to the scheme as the parties to the scheme may approve).”*
- 4.22 GECC and GEFA shall procure that each Existing Local Agreement shall be amended to delete any provision which confers on any GECF Group Company which is a party to such Local Agreement any right to terminate such Local Agreement on a sale or disposal affecting the whole of or any part of any party to that Local Agreement (in either case, whether such sale or disposal is effected by way of an asset or business sale or a share

93

---

sale or otherwise (including by the sale of a portfolio or by a change of the identity of the financing provider)).

*[The parties should also include further provisions, or amendments to existing provisions, to the extent required to give effect to Applicable Laws]*

## 5 Governing Law

This Addendum shall be governed by and construed in all respects in accordance with [English] law.

**In witness** whereof this Addendum has been entered into on the date stated at the beginning.

94

---

### Schedule 12 Form of New Local Agreement

Pro forma New Local Agreement to be inserted to give effect to the following provisions of this agreement:

- (i) the term of the New Local Agreement shall be from the date of the New Local Agreement and expire on [31 December 2008];
- (ii) clause 3.2;
- (iii) clause 4;
- (iv) clause 5.5 or 5.6 (as applicable);

- (v) clause 6.1.2 and Schedule 3;
- (vi) clause 8;
- (vii) clause 9.1, 9.2, 9.4 and Schedule 2;
- (viii) clause 10.2;
- (ix) clause 11;
- (x) clause 12.2;
- (xi) clause 13;
- (xii) clause 15;
- (xiii) clause 16.2 and Schedule 6 Part B;
- (xiv) clause 17;
- (xv) clause 18;
- (xvi) clause 20.4;
- (xvii) clause 21.3;
- (xviii) clause 22;
- (xix) clause 23; and
- (xx) clause 24.

95

---

- (xxi) In respect of each New Local Agreement, the assignment and subcontracting provisions incorporated by virtue of clause (xv) above shall be supplemented by the addition of the following sub-clause:
- (xxii) “Notwithstanding anything in this Clause [Assignment Clause], all of the rights and obligations of the Financial Assurance Company Limited under this Agreement shall automatically transfer to Financial New Life Company Limited upon the transfer scheme for the transfer of all or substantially all of Financial Assurance Company Limited’s business to Financial New Life Company Limited pursuant to section 105 Financial Services and Markets Act 2000 becoming effective (with such amendments, deletions or additions to the scheme as the parties to the scheme may approve).”
- (xxiii) For the avoidance of doubt, no New Local Agreement shall contain any provision which confers on the GECF Group Company which is a party to such Local Agreement any right to terminate such Local Agreement on a sale or disposal affecting the whole of or any part of any party to that Local Agreement (in either case, whether such sale or disposal is effected by way of an asset or business sale or a share sale or otherwise (including by the sale of a portfolio or by a change of the identity of the financing provider)).

*[Others].*

*[Please note the pro forma will need to cater for delay in the provision of PPP by agreed deadlines, acceptance testing of the relevant GEFA Company’s ability to provide the PPP in accordance with the Service Levels and the criteria of Schedule 6]*

96

---

**Schedule 13  
APPROVED SUBCONTRACTORS**

Due Diligence from GECF On Subcontractors

Both Parties acting reasonably shall assess the responses of the relevant subcontractor to the questions set out in (i) the Due Diligence Detailed Plan and (ii) the Due Diligence Detailed List below and shall together determine whether they have satisfied the necessary criteria. If the Parties cannot agree whether the criteria have been satisfied, then the matter shall be referred to the dispute resolution procedure in Clause 15.

97

---

**GE Consumer Finance**

- **Due Diligence**  
**Detailed Plan**

98

---

Page	Area	Owner	Completed	Reviewed
Pg.	Personnel			
Pg.	Operations			
Pg.	Sales and Marketing			
Pg.	Quality Control			
Pg.	Facilities			
Pg.	Information Systems			

**Note:** Some areas or portions of areas may not apply to all vendors and /or products.

### Personnel

Discuss with appropriate management the following items:

1. Are employees issued badges? Are photos included?
2. Are visitors issued badges? Logged in? Escorted?
3. Are employees restricted to certain areas of the plant?
4. If so, how?
5. Are the various work areas partitioned off?
6. Are background checks made on new employees?  
If so,
  - a) Drug tests:
  - b) Credit check:
  - c) Criminal history:
  - d) Other:

### Operations

Team member should tour a facility and processing center with company management and determine the following:

1. Customer Service
  - a) Hours of operation, # of Shifts, # of employees:
  - b) Obtain and review the status and operational reports of customer service levels. These are produced specifically for a client's program since desired hours and service levels vary.
  - c) Review of complaint resolution procedures.
  - d) Cancellation process:
  - e) Customer complaint process:
  - f) A copy of the company disaster recovery plan is needed: We will forward a copy under separate cover? Plan in place: Yes No
  - g) Tenure of CSRs:
  - h) Training:
  - i) Monitoring

- i. Tapes available to observe customer service:
- ii. Samples of monitoring criteria/forms:
- iii. Review process for evaluating reps:
- iv. Disciplinary procedure for reps:
- v. Review process for handling customer service center complaints:

- vi. Monitoring standards:
- 2. Describe operations of subsidiaries/divisions and connections between local, national and headquarter offices:

**Sales and Marketing**

- 1. Obtain the following information pertaining to:
  - a) Description, penetration, and geographical location of served markets. Also, describe any seasonal or cyclical aspects of these markets.
  - b) Summary of product offerings including principal product features such as quality, price design, delivery channels, install requirements, strengths and weaknesses
  - c) Customer satisfaction results.
  - d) General terms of sales, terms, and any unusual financing or payment deferral arrangements offered to customers.
- 2. Describe the pricing and discounting policies. Have there been any significant changes in recent years? Are their Performance Related Telemarketing Programs in place? If so, explain.
- 3. Describe the List Control strategy.
- 4. Can there be separation from other client's campaign activity?
- 5. For channels used, address the following:
  - a) Number of campaigns a year
  - b) Capacity to develop and deliver per day
  - c) Fulfillment of channel
  - d) Quality control procedures for above

**Telemarketing (Inbound/Outbound and customer service):**

- a) Turnaround time for script development, implementation and legal review:
- b) Sales verification process- describe/timing:
- c) Key performance standards (handling of poor performers):
- d) Telemarketing Representative Incentive Plan - describe:
- e) Telemarketing Reports - (Daily sales & service level performance, weekly performance by TSR, Monthly summary analysis, etc.)
- f) Monitoring process and procedures - please provide:
- g) VRU/IVR capabilities (changes & turnaround time):
- h) Long distance carriers:
- i) Call routing capabilities:
- j) How do you prioritize jobs/clients
- k) How long do changes take to implement:
- l) How do you plan/forecast & how quickly can you add reps:
- m) System constraints:

**Quality Control**

- 1. Are any employees assigned solely to Quality Control?
- 2. Copy of quality control plans for detailing methodology and process for:
  - a. Marketing (development and delivery)
  - b. Enrollment –
  - c. Customer Service/Sales Verification:
  - d. Is quality checked during every stage of production?
- 3. Copy of management reports utilized to manage turnaround time of third party service providers.
- 4. Copy of quality control reports and audits of work provided on all third party providers related to products

**Facilities:**

1. Type of construction:
2. Number of Stories:
3. Window Locations: Are they alarmed?
4. Only Occupant? If Not:  
Describe how Separated from other Tenants:
5. Fire Detection Alarms?
6. Automatic Sprinkler System? Yes No  
Flotation Alarms? Yes No  
Heat Detectors? Yes In IT area
7. Location of Parking Area:
  - a) Is access controlled by fencing, gate or guard?
8. Entrances: Number and locations of people doors:
  - i.) Are they double doored (man traps)?:
  - ii.) Can the exterior or the building, adjacent to all entrances, be observed from within?  
Yes No How?
  - iii.) Are doors electrically alarmed? If so, where:
  - iv.) Is a receptionist protected from an armed intruder? Yes No  
How?
- b. How many freight doors?
  - i.) Are they double doored (man and/or truck trap?)
  - ii.) Can the exterior of the building, adjacent to the freight door be observed from within? How?
  - iii.) Does a delivery truck have to pass through a gate or check point before entering premises? How?

- iv.) What procedure is followed before a trucker will be allowed access to plant's interior.
- v.) Are doors electrically alarmed?  
To where?
- vi.) Are loading docks raised above ground level?
- vii.) Could a truck gain access to interior of the building by ramming a door?
9. Does firm utilize more than one building?
10. Is plant owned or leased?

**Security**

1. Does the plant have a vault for secure storage?  
If so,
  - a) Type of construction:
  - b) Size in square feet:
  - c) Type of door:
  - d) Is vault alarmed? To where?
  - e) Are Tapes and Checks awaiting use stored there?
  - f) Who has access to vault?
  - g) Is it entered under dual control?

- h) Is access logged?
  - i) How often are logs audited & by whom?
2. Does the plant have a shredder?
- a) Is waste shredded daily?
  - b) Are precautions taken to ensure all waste is destroyed?
3. Does the plant employ security guards?
- If so,
- a) Are they armed?

- b) How many per shift?
  - c) Are they present when plant is not in operation?
  - d) Are they company employees or those from a private guard force?
  - e) Do they have radio contact?
  - f) Is there ever a period when the plant is unoccupied?
4. Are tapes, printouts, etc., containing cardholder information kept in secure place?
5. Does plant utilize a log, work order, audit form or other similar method to account for all products during the printing and inserting process?
- If yes, does audit form provide ability to identify production status of a given piece or account?
6. Are employees bonded?
- Explain process
7. Describe the procedure for allowing employees to enter building when reporting for work
- How would an intruder be detected?
8. Are there any precautions taken to prevent employees from removing Tapes, Checks, or any Cardholder Information from the premises?

**Alarm Devices**

1. Does plant have any electric alarm alert systems?
- If so,
- a) Is it monitored by a private security firm?
  - b) Does alarm go directly to local police departments?
  - c) Distance to local police department?
  - d) Are all doors alarmed? All windows alarmed?
  - e) Does the building have panic or holdup alarms?
- If so, where does the signal go?

- f) Does building have motion detectors?
  - g) Are heat or smoke detectors utilized?
- If so, who monitors?
- h) Does fire alert go directly to fire departments?
  - i) Distance to local fire station?
  - j) Are TV cameras utilized?
- If so, do they cover
- i.) 

Parking Lot	Yes	No
-------------	-----	----

ii.)	Exterior of Entrance	Yes	No
iii.)	Vault	Yes	No
iv.)	Interior Work Space	Yes	No
v.)	Other	Yes	No

k) In the event of a power outage, will alarms operate? Yes No

l) Alternate power source is?

Does vault have a separate alarm?

**Information Systems**

1. Forms of connectivity:
2. Data Processing- Describe the internal and external handling of the data.
3. Schedule of systems limitations, constraints, expandability and capacity:

Backup procedures and disaster recovery plans:

Question	Operational Definitions	Answer	Service Provider Comments
<b>General Information</b>			
<b>The objective of this section is to gather general information relating to your business that applies to the products or services you may provide to GE Consumer Finance - Americas (GECF)</b>			
1.	What is the name of each company and/or division that may be providing products or services for GECF?		
2.	Please provide the address of the site(s) from which products or services may be provided to GECF?		
3.	What is the name, position & email address of the primary contact for GECF?	<b>Primary Contact:</b> The employee within your business that is responsible for managing the relationship between your company & GECF	
4.	<b>The responses in this document must be reviewed &amp; approved by an executive within your company.</b>	<b>Executive Level:</b> (Company Officer)	
	Please list the name, position & email address of the Executive, that will be certifying this document (see question 90)		
5.	What are the names, positions & email addresses of the privacy & security leaders for your business?		
<b>All questions below apply to each company and/or division that may be providing products or services for GECF.</b>			
6.	How many employees does your company have?		
7.	Are any of your locations outside the United States?	<b>Examples of a Location:</b> Sales offices, warehouses, manufacturing, etc.	
8.	<b>(If yes to question 7)</b> Please list all locations outside the United States.		
9.	What is the name of your parent company, if applicable?		

Question	Operational Definitions	Answer	Service Provider Comments
<b>Information Security &amp; Privacy</b>			
<b>The objective of this section is to determine how a 3rd-party provider will protect GECF information.</b>			
		<b>GECF Information:</b>	
		<ul style="list-style-type: none"> <li>• Personally identifiable consumer information</li> <li>• Non-public customer information</li> <li>• Intellectual property</li> <li>• Confidential GECF business information</li> <li>• Confidential GECF employee data</li> </ul>	
10.	Do you provide services to financial institutions?		

11. (If yes to question 10) For your financial institution clients, does your company have a documented privacy program that supports requirements to protect your clients' customer information?
- This question does not assume that your company, itself, is subject to state & federal privacy & security regulations. Documented Privacy Program: A documented privacy program would include written policies and procedures covering: (i) ownership of the privacy program; (ii) protecting against impermissible sharing of data (i.e., use of information for anything other than customer's approved purposes); (iii) use and maintenance of customer information in accordance with privacy and security laws; and (iv) reasonable security controls for systems and facilities (including segregation of data, access controls).
12. Do you have documented policies that limit system access to a client's information to only those resources that require access to service that client?

108

Question	Operational Definitions	Answer	Service Provider Comments
13. Do your existing systems provide tiered system access levels that limit access to confidential client information?	<b>Tiered System Access Levels:</b> Access rights to customer data fields generally should include more than 1 level of access. Depending on the services being performed, different users might have read, write/update, and delete access to specific data fields.		
14. Are there documented controls/procedures in place to ensure you will not reuse or share restricted GECF information with other parties or use for any purpose other than providing the goods or services to GECF?	<b>Documented Controls/Procedures:</b> The use of: (1) technology, (2) assignment of job responsibilities, (3) deployment of controls and (4) training in items (1)-(3) to ensure systematic compliance with the limits on use and disclosure of restricted GECF information.		
15. Can you systematically label / flag GECF information that you cannot reuse or share with other parties?	<b>Label / Flag:</b> System codes, special databases, special filing arrangements or other methods to label data with the relevant restrictions on use and disclosure		
16. Do you have a documented security risk assessment process?	<b>Security Risk Assessment Process:</b> A process to identify threats, vulnerabilities, attacks, probabilities of occurrence and outcomes.		

109

Question	Operational Definitions	Answer	Service Provider Comments
17. Do you have a documented security incident management process?	<b>Documented Process:</b> A set of written instructions on how to report a security incident, including who to contact and what information is needed. <b>Incident Management Process:</b> A process for responding to security incidents that includes initial notification methods, escalation procedures, client notification, and incident response and investigation. Security Incident Examples: <ul style="list-style-type: none"> <li>• Facilities break-ins</li> <li>• System intrusions</li> <li>• Theft of data</li> <li>• Internal fraud</li> </ul>		

#### Laws, Regulations and Litigation

The objective of this section is to determine that all 3rd-party providers have a process for identifying & complying with legal & regulatory requirements. (PRIMARY CONTACT MUST CONSULT WITH LEGAL COUNSEL IN ANSWERING THESE QUESTIONS)

18. Does your business have a documented process to maintain a current list of legal & regulatory requirements that govern the services to be provided to GECF?
- Examples of requirements:
- Telemarketing Laws
  - Privacy Laws
  - Fair Practices Acts
  - Collections Laws
  - Truth in Advertising



19.	Does your business have a documented process to communicate legal & regulatory updates to all employees, contractors, subcontractors and temporary personnel?	<b>Communicate:</b> Communication can be by one or more of several means, including regular training, newsletters, e-mails, etc...
20.	Is your business required to have a license to provide the proposed products or services to GECEF?	<b>License:</b> registration with one or more state regulatory agencies, such as a state banking or finance department, to perform customer service operations (such as payment processing, collections, customer service inquiries).

Question	Operational Definitions	Answer	Service Provider Comments
21.	<b>(If yes to question 20)</b> Is your company licensed in all necessary jurisdictions to provide the proposed products or services to GECEF?	<b>All Necessary Jurisdictions:</b> certain states, including CA, CT, FL, MD, RI, require state licenses for certain types of entities to perform certain customer service operations	
22.	Is your company currently involved in any pending or threatened litigation that could have an adverse impact on the ability to provide products or services to GECEF or how those service would be provided?		
23.	Is your company currently involved in any regulatory inquiries that could have an adverse impact on the ability to provide products or services to GECEF or how those products or services would be provided?	<b>Regulatory Inquiries:</b> Investigations, complaints or inquiries by federal or state agencies, including attorney general offices and regulatory agencies such as the FTC.	
24.	Does your company have a documented process to proactively investigate & monitor intellectual property (IP) rights of technologies that your company either owns or uses?	There should be a process by which the service provider can meaningfully represent in the contract that it has all necessary rights to the intellectual property being used in the provision of products or services to GECEF.	
25.	Is your company currently involved in any pending or threatened intellectual property disputes that could have an adverse impact on the ability to provide products or services to GECEF or how those products or services would be provided?	<b>Pending or Threatened IP Disputes:</b> Pending litigation or a threat that alleges that you do not have the right to use certain intellectual property which will be used in the provision of services to GECEF.	
26.	Is your company subject to any governmental consent orders, consent decrees or enforcement actions?		
<b>Disaster Recovery</b>			
	<b>The objective of this section is to determine that all 3rd-party providers have plans in place to mitigate service disruptions for all products and services that may be provided to GECEF.</b>	<b>Service disruption:</b> A break in the scheduled delivery of the product or service	

Question	Operational Definitions	Answer	Service Provider Comments
27.	Do you have a completed & documented disaster recovery plan (DRP) in effect that mitigates any potential service disruptions as related to products or services that may be provided to GECEF?	<b>DRP:</b> Actions taken to mitigate the disruption across the entire business that enables a 3rd-party provider to deliver products or service to their customers. (The scope must cover the entire business process across all business functions as related to products or services that may be provided to GECEF.) <b>Completed:</b> A plan that has been approved by executive level management & implemented.	
28.	Is your DRP based on an industry accepted risk assessment methodology?	<b>Industry Accepted Risk Assessment:</b> (ISO 9000, FMEA, Mission Critical Applications)	
29.	Do you electronically store your data related to products or services that may be provided to GECEF?	<b>Example:</b> (Tapes, 3290, Fiche) <b>Your Data:</b> For questions (27-32) specifically references <b>Your</b> internal business process data.	
30.	<b>(If yes to question 29)</b> Does your DRP include backup & recovery strategies for your data related to products or services that may be provided to GECEF?	<b>Backup &amp; Recovery Strategies:</b> Backup & recovery process that supports your company's internal business process.	
31.	<b>(If yes to question 29)</b> Are electronic backups of your data stored with a 3rd-Party data storage company?		
32.	Do you have hard copy files of your data related to products or services that may be provided to GECEF?		
33.	<b>(If Yes to question 32)</b> Does your DRP include backup & recovery strategies for hard copy files of your data related to products or services that may be provided to GECEF?	<b>Hard Copy File:</b> A physical document	

34. (If yes to question 32) Are hard copy files of your data stored with a 3rd-Party data storage company?

35. Will you electronically store GECF information?

**Example:** (Tapes, 3290, Fiche) For questions (33-38) “Will” means effective upon engagement as a GECF product or service provider

Question	Operational Definitions	Answer	Service Provider Comments
36. (If yes to question 35) Will your DRP include backup & recovery strategies for GECF information?	<b>Backup &amp; Recovery Strategies:</b> Backup & recovery process that supports your company’s internal business process.		
37. (If yes to question 35) Will your electronic backups of GECF information stored with a 3rd-Party data storage company?			
38. Will you have hard copy files of GECF information?			
39. (If yes to question 38) Will your DRP include backup & recovery strategies for hard copy files of GECF information?	<b>Hard Copy File:</b> A physical document		
40. (If yes to question 38) Will hard copy files of GECF information be stored with a 3rd-Party data storage company?			
41. Does your DRP include alternative suppliers that are pre-qualified & can promptly be engaged in the event of a service disruption?	<b>Alternative Suppliers:</b> Suppliers capable of providing similar products or services. <b>Pre-qualified:</b> Suppliers’ capability already assessed by your company to be acceptable		
42. Does your DRP include redundant systems or processes that can be promptly enabled in the event of a service disruption?	<b>Redundant Systems/Processes:</b> a back up system/process with capacity and functionality to deliver the product or service to GECF, in the absence of the primary system.		
43. Does your DRP include a communication plan for regular communication to your affected customers during a service disruption?			
44. Do you have a dedicated resource assigned as the DRP owner?			
45. Does the DRP owner report on DRP to an executive level employee or executive level committee?	<b>Executive Level:</b> reports directly to the President or CEO of your company		
46. Do you have a documented process as part of your DRP to review and update your plan for changes to your business processes?	<b>Documented:</b> written document that includes the key requirements for the process, how you execute the process and who is the owner of the process.		

Question	Operational Definitions	Answer	Service Provider Comments
47. Do you test changes to your DRP?	<b>Test:</b> a simulation of a service disruption in which you execute your DRP to meet or exceed you established performance criteria.		
48. If there are no changes to your DRP within a year (12 month period), do you test your disaster recovery plans annually?			
<b>Facilities</b>			
<b>The objective of this section is to determine that 3rd-party providers have reasonable measures in place to physically secure confidential information.</b>		<b>Reasonable Measures:</b> Systems & processes that protect access to facilities that contain confidential information.	
49. Do you have a physical facilities security program for all locations that will process or house GECF information?	<b>Physical Facilities Security Program:</b> To include access control for employees, contractors, subcontractors, temporary personnel & visitors		
50. Does your business use or intend to use subcontractors to provide products or services to GECF?	<b>Subcontractors:</b> a 3rd-party provider that your company has engaged to deliver products & services to GECF.		
51. (If yes to question 50) Do your subcontractors have a physical facilities security program for all locations that will process or house GECF information?			
52. Do you have restricted access to internal data rooms which will process or house GECF information?	<b>Data room:</b> Server room or hard copy file archive		
53. Do you have restricted access to phone closets which will process or house GECF information?	<b>Phone Closet:</b> A closet which houses telecommunication wiring & telecom wiring equipment (Voice & Data)		

54. Do you have access control processes which require employees, contractors, subcontractors & temporary personnel to physically present badges to obtain access to all locations that will process or house GECF information?

Question	Operational Definitions	Answer	Service Provider Comments
55. Do you have a visitor access control process?	<b>Visitor:</b> Anyone who is not an employee, or a contractor, subcontractor, temporary resource employed at the site <b>Visitor Access Control Process:</b> Visitors are escorted in your facilities, & a visitor reconciliation process exists		
56. Is access to your facilities revoked for all terminated employees, contractors, subcontractors & temporary personnel within a 48 hour period?			
57. Do you have a documented process to destroy all physical media that contains your confidential information & the confidential information of your clients after it is no longer actively used or actively archived?	<b>Examples of Physical Media:</b> <ul style="list-style-type: none"> <li>• Paper</li> <li>• Tapes</li> <li>• Fiche</li> <li>• Embossing Foil.....</li> </ul> <b>Destroy:</b> To make unreadable & unusable		
58. Do you utilize a 3rd-party provider for physical media destruction?			
59. Do you have a documented process to destroy all electronic media that contains your confidential information & the confidential information of your clients after it is no longer actively used or actively archived?	<b>Examples of Electronic Media:</b> <ul style="list-style-type: none"> <li>• Chip Sets</li> <li>• Electronic storage devices</li> </ul>		
60. Do you utilize a 3rd-party provider for electronic media destruction?			
61. Do you audit your 3rd-party providers for electronic & physical media destruction?			
<b>Personnel</b>			
<b>The objective of this section is to determine that the 3rd-party provider has appropriate processes &amp; procedures for hiring, training &amp; monitoring employees.</b>			
62. Are all new hires subject to Federal Criminal background checks covering the last 10 years?	<b>New Hires:</b> All employees, contractors & Temporary personnel		
63. Are all new hires subject to State Criminal background checks covering the last 10 years?	<b>State Criminal Background Requirements:</b> Must be executed for all states & counties in which the individual has resided and / or worked		
64. Are all new hires subject to credit bureau checks?			

Question	Operational Definitions	Answer	Service Provider Comments
65. Are all new hires subject to employment verification?			
66. Are all new hires subject to education verification?			
67. Are all US based new hire employees subject to drug tests?			
68. Do you provide services to financial institutions?			
69. <b>(If yes to question 68)</b> For your financial institution clients, Do you require formal privacy & security training for your employees with access to their confidential information?	<b>Privacy &amp; Security Training:</b> Classroom or Computer Based Training covering privacy laws & appropriate handling of confidential information		
70. <b>(If yes to question 68)</b> Do you require annual privacy & security training?			
71. Will your employees, contractors or temporary personnel directly interact with GECF customers?	<b>GECF Customers:</b> Cardholders & / or clients of GECF		
72. <b>(If yes to question 71)</b> Are employees, contractors & Temporary personnel who will directly interact with GECF customers subject to quality assurance monitoring for compliance & service level requirements?	<b>Examples of Monitoring:</b> <ul style="list-style-type: none"> <li>• Call monitoring</li> <li>• Mystery shopping</li> <li>• Customer satisfaction surveys</li> </ul>		
73. Does your company comply with the Fair Labor Standards Act (FLSA) or equivalent Employment standards acts if not based in the US?			
74. Does your company have a documented policy & process that complies with environmental health & safety regulations			
<b>Subcontracting</b>			

**The objective of this section is to determine that the 3rd-party provider has appropriate processes & procedures for engaging, training & monitoring contractors, subcontractors & temporary personnel.**

75. Does your business use or intend to use subcontractors to provide products or services to GECF? **Subcontractors:** a 3rd-party provider that your company has engaged to deliver products & services to GECF. **Note:** If the answer to this question is “No”, you may skip to the finance section
76. **(If yes to question 75)** Are any of your subcontracted service providers on the *OFAC* list?

Question	Operational Definitions	Answer	Service Provider Comments
77. <b>(If yes to question 75)</b> Do you have a documented security incident management process for subcontractors?			
78. Will your subcontractors have access to GECF <i>information</i> ?			
79. <b>(If yes to question 78)</b> Are subcontractors who will access to GECF <i>information</i> subject to the same background checks as your permanent employees who have access to GECF <i>information</i> ?			
80. <b>(If yes to question 78)</b> Do you require formal privacy & security training for contractors, subcontractors and temporary personnel who will have access to GECF <i>information</i> ?			
81. <b>(If yes to question 78)</b> Do you require annual privacy & security training?			
82. Will GECF <i>information</i> be passed to a <i>3rd-party managed IT system</i> ?		<b>3rd-Party Managed IT System:</b> Database or other technology systems that are maintained by a contracted supplier	
83. <b>(If yes to question 82)</b> Will you actively monitor the security of outsourced IT systems?			
84. <b>(If yes to question 82)</b> Will you actively monitor the transfer, storage & disposal of GECF <i>information</i> ?			
85. Will your subcontractors directly interact with GECF customers?			
86. <b>(If yes to question 85)</b> Are subcontractors who will directly interact with GECF customers subject to quality assurance monitoring for compliance & service level requirements?			

**Finance**

**The objective of this section is to determine if there are sound financial practices & controls in place?**

87. Does your company prepare stand-alone financial statements?		<b>Stand-Alone:</b> Separate set of financial statements for your division, subsidiary, company or enterprise	
88. <b>(If yes to question 87)</b> Have you received an unqualified audit opinion letter from your independent accounting firm in each of the last 3 years?			

Question	Operational Definitions	Answer	Service Provider Comments
89. Do you have a parent company?			
90. <b>(If yes to question 89)</b> Does your parent company prepare stand-alone financial statements?			
91. <b>(If yes to question 90)</b> Have you received an unqualified audit opinion letter from your independent accounting firm in each of the last 3 years?			
92. Does either your company or your parent company prepare a SAS70 or have an independent 3rd-party review of internal controls?			

**Certification**

93. Are the responses provided in this document accurate & complete to the best knowledge of the 3rd-party provider executive (listed above), based upon investigation & review with those management individuals who have responsibility for the business processes & issues evaluated in this questionnaire?			
--	--	--	--

## Benchmarking

- 1 The first benchmarking exercise shall be undertaken by an organisation recognised as having benchmarking capability (the “Benchmarking Adviser”). The following provisions shall apply in respect of the selection of the Benchmarking Adviser:
  - 1.1 GECC shall identify three potential candidates to act as the Benchmarking Adviser. GEFA shall then eliminate one of the three choices and GECC shall choose which of the remaining candidates shall become the Benchmarking Adviser.
- 2 The Parties shall bear the costs of the first benchmarking exercise in equal shares and GEFA shall bear the costs of all subsequent benchmarking exercises.
- 3 The Benchmarking Adviser shall be required to submit to the parties the name(s) and curriculum vitae of its personnel proposed to be deployed on this matter and the estimated costs (which shall be reasonable). Each Party shall have the right to object to the deployment of proposed personnel and to require the Benchmarking Adviser to propose (and submit particulars of) alternative personnel, provided that the reasons for its objections are reasonable, and are supplied to the other Party and the Benchmarking Adviser in writing within five Business Days of the parties receiving the particulars of the personnel. GEFA shall have the right to object to the estimated costs and to negotiate such costs. The Benchmarking Adviser shall be required to enter into a confidentiality agreements with GECC and GEFA on no less onerous terms than those which apply to the Parties under this agreement.
- 4 In order that there are no ambiguities in relation to each Party’s understanding of how the benchmarking activity is to be undertaken, its findings interpreted and any resulting actions taken, the Benchmarking Adviser will be instructed to conduct the benchmarking activity in accordance with a set of instructions (the “**Benchmarking Terms of Reference**”). GECC will prepare the first draft of the Benchmarking Terms of Reference and deliver it to GEFA. GECC and GEFA shall endeavour to agree the Benchmarking Terms of Reference (acting reasonably and in good faith). If GECC and GEFA are unable to agree the Benchmarking Terms of Reference within 10 Business Days of the date on which the first draft was delivered to GEFA, either party may request the Benchmarking Adviser to prepare a draft Terms of Reference. Neither party shall unreasonably withhold or delay its approval of the draft Benchmarking Terms of Reference prepared by the Benchmarking Adviser. Following agreement of the Benchmarking Terms of Reference, a representative of each Party shall sign the Benchmarking Terms of Reference, which shall then be delivered to the Benchmarking Adviser.
- 5 As a minimum, the Benchmarking Terms of Reference will instruct the Benchmarking Adviser to gather in each Territory, using generally accepted benchmarking processes, the following information in respect of at least five members of the Benchmarking Pool (or where there are not five members of the Benchmarking Pool, then as many as is reasonably practicable) in the relevant Territory at that time:

119

---

- 5.1 types of Payment Protection Products offered to consumers;
- 5.2 features of Payment Protection Products offered to consumers including:
  - (a) marketing channels (including direct mail, inbound and outbound telemarketing, email and internet campaigns);
  - (b) details of types of cover;
  - (c) details of benefit;
  - (d) consumer price and mechanism for charging consumer;
  - (e) length of time on the market; and
  - (f) such other information as agreed between the Parties.
- 5.3 The Benchmarking Adviser shall set out the information gathered in a report (the “**Benchmarking Report**”).
- 6 In respect of each six-monthly benchmarking exercise carried out after the first benchmarking exercise, GEFA shall gather the information set out in paragraphs 5.1 and 5.2 above. For the avoidance of doubt, the Benchmarking Adviser shall not be involved in any Benchmarking Exercise subsequent to the first Benchmarking Exercise. If the Parties agree to involve the Benchmarking Adviser in a Subsequent Benchmarking Exercise, the Parties shall bear the costs equally.
- 7 The Parties shall, within a reasonable time, assess, in the light of the information provided in accordance with paragraph 5 or paragraph 6 as appropriate, whether there are any Payment Protection Products or features of Payment Protection Products that are offered by GECF Group Companies’ Competitors to consumers in the relevant Territory but that the relevant GEFA Company does not offer to the relevant GECF Group Company.
- 8 For the avoidance of doubt the information specific to GECC in any and all Benchmarking Reports and Product Development Plans produced under this agreement shall be treated in the same way as if it were Confidential Information disclosed by a party under the agreement.
- 9 If:
  - 9.1 GECC considers that the information provided by GEFA in accordance with paragraph 6 does not provide an accurate view of the market for Payment Protection Products in the relevant Territory; or
  - 9.2 the Parties are not able to agree on the assessment carried out under paragraph 7; or

120

---

- 9.3 the Parties are not able to agree a Product Development Plan in accordance with Clause 9.4.4,  
then Clause 15 of this agreement shall apply

121

---

Criteria for determining when Potential Substitute Business becomes Substitute Business

The Parties agree that any substitute Payment Protection Products which directly replace the Existing Business will be Substitute Business and will be subject to the existing terms, both the Retention Rate and Profit Share as set out in Schedule 1 and the Local Agreements.

The Parties agree that the following scenarios shall fall within or outside the definition of Substitute Business, as set out below. This is not an exhaustive list and any additional scenarios that may arise from time to time will be agreed between the senior management of GEFA and GECC centrally.

Furthermore, if the senior management of GEFA and GECC centrally agree a Payment Protection Product is partly Substitute Business and partly New Business, they will agree terms based on a weighted average of the Existing Business and New Business terms.

Scenario	Type of Business	Exceptions
Any modification to Existing Business its terms, conditions or exclusions whether a minor change is made or a change in benefits to meet GECC finance agreements by modification to cover or an addition or removal of a cover section or sections.	Is Substitute Business	
Resolicitation activity GEFA currently does not offer on the back of Existing Business. <b>“Resolicitation”</b> means resolicitation activity in the marketing of a Payment Protection Product by mail or phone to uninsured GECC finance customers who have not opted to purchase the GEFA Payment Protection Product at the point of sale of the finance agreement.	Is New Business	If GECC intends to replace the Existing Business provided at initial point of sale of the finance agreement with a Resolicitation Payment Protection Product it will be Substitute Business and GECC will advise GEFA of its intent. If GECC stops actively promoting the Existing Business provided at the initial point of sale of the finance agreement by means of training or account management or

122

Scenario	Type of Business	Exceptions
		incentives or other method which adversely impacts on the Existing Business performance, measured by insurance penetration of the Existing Business, then any Resolicitation Scheme will be restructured as Substitute Business with the appropriate Retention Rate and Profit Share terms applied.
A joint borrower cover Payment. Protection Product where GEFA currently only offers a single cover Payment Protection Product.	Is Substitute Business for the first named principal borrower. Is New Business for the second named borrower.	As GEFA cannot split terms within one Payment Protection Product, aggregate terms will be provided combining the proportion of the Risk Rate allocated to the first named principal borrower and the second named borrower.
New GECC business partnership. This shall include new partnerships with retailers, dealers or broker groups.	Is New Business	It is not intended to include individual additions of a retailer, dealer or broker which will be provided with terms as Substitute Business, unless a separate Scheme is required.
A Payment Protection Product offered to an age range excluded from Existing Business or other Payment Protection Product targeting another specific group of customers not currently provided under Existing Business.	Is New Business	
Committed Payments Products designed to protect in whole or in part GECC finance commitments if they are in replacement of Existing Business.	Is Substitute Business	

123

Scenario	Type of Business	Exceptions
Committed Payments Products not designed to protect GECC finance commitments.	Is New Business	
A Payment Protection Product provided for a new and distinct GECC finance activity including any new and distinct loan product, which does not replace an existing loan product, offered by GECC.	Is New Business	Any Payment Protection Product provided to a new or distinct loan product, which replaces an existing loan product, will be Substitute Business. If the new loan product increases the volume of Existing Business’s Gross Written Premium then blended terms will be agreed.
Acquired GECC Business.	Is New Business	If Existing Business is transferred to the Acquired GECC Business, the terms for the Existing Business will remain unchanged.

124

**Schedule 16  
Business Proposal Pricing Process**

**Part I**

1 Where:

1.1 GECC or any GECC Group Company request an Offering pursuant to Clause 9.4.4 and such an Offering described in the relevant Product Development Plan constitutes Potential Substitute Business; or

1.2 paragraph 9.2 of Part A of Schedule 5 applies and the Parties need to determine the pricing of a New Business Proposal or Amended New Business Proposal, the procedure set out in this Schedule shall apply.

2 Where the Offering, New Business Proposal or Amended Business Proposal as appropriate (in any case the **Business Proposal**):

2.1 does not include the establishment of a new form of distribution channel for the relevant Payment Protection Product (a **New Channel**), the process set out in Part II of this Schedule shall apply; or

2.2 does involve a New Channel for the relevant Payment Protection Product then the process set out in Part III of this Schedule shall apply.

## PART II

3 Where the Business Proposal does not include a New Channel, GEFA or the relevant GEFA Company will provide GECC or the relevant GECF Group Company with a pricing proposal for the Business Proposal. The pricing proposal shall comprise two elements (i) the Retention Rate as has already been agreed by the Parties for the relevant Payment Protection Product as set out in Schedule 1 of this agreement (for Potential Substitute Business) or Clause 5 of this agreement (for Potential New Business) as the case may be; and (ii) the Risk Rate.

4 Where GECC or the relevant GECF Group Company agrees to the pricing proposal, then the Parties shall proceed to implement the Product Development Plan.

5 Where GECC or the relevant GECF Group Company does not agree to the pricing proposal, then the dispute shall be referred to the dispute resolution process set out in Clauses 15.2 of the agreement. If the Parties are not able to resolve the dispute within 10 Business Days of the matter being referred to the dispute resolution process then either Party may refer the pricing proposal to Watson Wyatt or other independent actuary as agreed by the Parties (the **Actuary**). The Actuary shall determine the price by calculating the Risk Rate. The Actuary shall act as an Expert and not as an arbitrator and the Actuary's decision shall be final and binding on the parties. The Actuary shall then determine his own pricing proposal for the Business Proposal. Either Party shall be

125

---

entitled to receive a copy of the assumptions upon which the Actuary determined the Risk Rate.

6 Where the Parties refer the matter to the Actuary, the price shall be calculated by adding the Risk Rate as determined by the Actuary to the Retention Rate. Where:

6.1 the Parties agree to the price, then the Parties will proceed to implement the Business Proposal and (where the New Business Proposal is a New Business Proposal or Amended Business Proposal) the terms of Paragraphs 10 and 11 of Part A of Schedule 5 shall apply; or

6.2 GECC or the relevant GECF Company does not accept the price, then the Product Development Plan will be abandoned; or

6.3 GEFA or the relevant GEFA Company does not accept the price, then (i) GECC and the relevant GECF Group Company shall have no obligation to appoint GEFA or any GEFA Company as its provider, whether exclusive or otherwise, for the relevant Local Agreement in respect of the Business Proposal and (ii) GECC shall be free to enter into discussions, tenders, negotiations, arrangements and agreements with third parties and/or other companies in the GECF Group in respect of the Business Proposal and (iii) the relevant GECF Group Company shall not be obliged to invite the relevant GEFA Company to participate in the tender process but shall provide the relevant GEFA Company with a copy of the tender documentation.

## Part III

7 Where:

7.1 The Business Proposal does include a New Channel and \*\*.

7.2 Any increase in the Retention Rate set out in the relevant Local Agreement must \*\*. GEFA shall provide substantiation for the revised Retention Rate based on a proposed pricing unit for each premium sold via the New Channel.

7.3 GEFA shall also provide:

7.3.1 (if the New Channel is to be provided by GEFA or a GEFA Company directly) the benchmarked costings of the New Channel; or

7.3.2 (if the New Channel is to be provided by an outsourced supplier) the relevant tender documentation for such outsourcing.

The pricing and capabilities offered by GEFA must be competitive with the benchmarked or tender costings identified.

7.4 If the pricing and capabilities offered by GEFA pursuant to paragraph 7.3 are competitive and the Risk Rate is accepted by GECC, then the Parties shall finalise the terms of the

126

---

addendum to the Local Agreement or, where relevant, the terms of a New Local Agreement.

8 Where GECC or the relevant GECF Group Company does not agree to the proposed revised Retention Rate then the matter will be referred to the dispute resolution process set out in Clause 15.

9 Where:

9.1 GECC or the relevant GECF Group Company agrees to the revised Retention Rate and the Risk Rate proposed by GEFA, then the Parties shall proceed to implement the Product Development Plan, or

9.2 GECC or the relevant GECF Group Company does not agree to the Risk Rate, then the dispute shall be referred to the dispute resolution process set out in Clause 15.2 of the agreement. If the Parties are not able to resolve the dispute within 10 Business Days of the matter being referred to the dispute resolution process then either Party may refer the dispute to the Actuary. The Actuary shall determine the price by calculating the Risk Rate. The Actuary shall act as an Expert and not as an arbitrator and the Actuary's decision shall be final and binding on the parties. The Actuary shall then determine his own pricing proposal for the Business Proposal. Either Party shall be entitled to receive a copy of the assumptions upon which the Actuary determined the Risk Rate.

**10** Where the Parties refer the matter to the Actuary, the price shall be calculated by adding the Risk Rate as determined by the Actuary to the revised Retention Rate.

Where:

**10.1** the Parties agree to the price, then the Parties will proceed to implement the Business Proposal and (where the Business Proposal is a New Business Proposal or Amended Business Proposal) the terms of Paragraphs 10 and 11 of Part A of Schedule 5 shall apply; or

**10.2** GECC or the relevant GECF Company does not accept the price, then the Product Development Plan will be abandoned; or

**10.3** GEFA or the relevant GEFA Company does not accept the price, then (i) GECC and the relevant GECF Group Company shall have no obligation to appoint GEFA or any GEFA Company as its provider, whether exclusive or otherwise, for the relevant Local Agreement in respect of the Business Proposal and (ii) GECC and the relevant GECF Group Company shall be free to enter into discussions, tenders, negotiations, arrangements and agreements with third parties and/or other companies in the GECF Group in respect of the Business Proposal and (iii) the relevant GECF Group Company shall not be obliged to invite the relevant GEFA Company to participate in the tender process but shall provide the relevant GEFA Company with a copy of the tender documentation.



## BUSINESS SERVICES AGREEMENT

dated , 2004

between

GNA CORPORATION

and

UNION FIDELITY LIFE INSURANCE COMPANY

**CONFIDENTIAL TREATMENT REQUESTED**

**CONFIDENTIAL TREATMENT REQUESTED: INFORMATION FOR WHICH CONFIDENTIAL TREATMENT HAS BEEN REQUESTED IS OMITTED AND IS NOTED WITH "\*\*\*". AN UNREDACTED VERSION OF THIS DOCUMENT HAS BEEN FILED SEPARATELY WITH THE SECURITIES AND EXCHANGE COMMISSION.**

**TABLE OF CONTENTS**

<a href="#">ARTICLE I</a>	<a href="#">DEFINITIONS</a>
<a href="#">SECTION 1.01.</a>	<a href="#">Certain Defined Terms</a>
<a href="#">SECTION 1.02.</a>	<a href="#">Other Terms</a>
<a href="#">ARTICLE II</a>	<a href="#">SERVICES AND TERMS</a>
<a href="#">SECTION 2.01.</a>	<a href="#">Services: Scope</a>
<a href="#">ARTICLE III</a>	<a href="#">COSTS AND DISBURSEMENTS</a>
<a href="#">SECTION 3.01.</a>	<a href="#">Costs and Disbursements.</a>
<a href="#">ARTICLE IV</a>	<a href="#">STANDARD FOR SERVICE; COMPLIANCE WITH APPLICABLE LAW; LIMITED LIABILITY</a>
<a href="#">SECTION 4.01.</a>	<a href="#">Standard for Service</a>
<a href="#">SECTION 4.02.</a>	<a href="#">Compliance with Applicable Law</a>
<a href="#">SECTION 4.03.</a>	<a href="#">Limited Liability</a>
<a href="#">ARTICLE V</a>	<a href="#">DISPUTE RESOLUTION</a>
<a href="#">SECTION 5.01.</a>	<a href="#">General Provisions</a>
<a href="#">SECTION 5.02.</a>	<a href="#">Consideration by Senior Executives</a>
<a href="#">SECTION 5.03.</a>	<a href="#">Mediation</a>
<a href="#">SECTION 5.04.</a>	<a href="#">Arbitration</a>
<a href="#">ARTICLE VI</a>	<a href="#">TERMINATION</a>
<a href="#">SECTION 6.01.</a>	<a href="#">Termination of the Agreement.</a>
<a href="#">SECTION 6.02.</a>	<a href="#">Termination with Respect to Any Reinsured Business or Recaptured Business</a>
<a href="#">SECTION 6.03.</a>	<a href="#">Effect of Termination</a>
<a href="#">SECTION 6.04.</a>	<a href="#">Survival</a>
<a href="#">SECTION 6.05.</a>	<a href="#">Force Majeure</a>
<a href="#">ARTICLE VII</a>	<a href="#">GENERAL PROVISIONS</a>
<a href="#">SECTION 7.01.</a>	<a href="#">Subcontractors</a>
<a href="#">SECTION 7.02.</a>	<a href="#">Additional Services; Books and Records.</a>
<a href="#">SECTION 7.03.</a>	<a href="#">Taxes.</a>
<a href="#">SECTION 7.04.</a>	<a href="#">Confidential Information</a>
<a href="#">SECTION 7.05.</a>	<a href="#">Non-disclosure; Privilege; Conflicts of Interest</a>
<a href="#">SECTION 7.06.</a>	<a href="#">Headings and Schedules</a>
<a href="#">SECTION 7.07.</a>	<a href="#">Notices</a>
<a href="#">SECTION 7.08.</a>	<a href="#">Successors and Assigns</a>
<a href="#">SECTION 7.09.</a>	<a href="#">Execution in Counterpart</a>
<a href="#">SECTION 7.10.</a>	<a href="#">Currency</a>
<a href="#">SECTION 7.11.</a>	<a href="#">Amendments</a>
<a href="#">SECTION 7.12.</a>	<a href="#">Governing Law</a>
<a href="#">SECTION 7.13.</a>	<a href="#">Entire Agreement; Severability</a>
<a href="#">SECTION 7.14.</a>	<a href="#">No Waiver; Preservation of Remedies</a>
<a href="#">SECTION 7.15.</a>	<a href="#">Cooperation</a>
<a href="#">SECTION 7.16.</a>	<a href="#">Third Party Beneficiary</a>
<a href="#">SECTION 7.17.</a>	<a href="#">Negotiated Agreement</a>
<a href="#">SECTION 7.18.</a>	<a href="#">Interpretation</a>
<a href="#">SECTION 7.19.</a>	<a href="#">No Right to Set-Off</a>

SCHEDULES

<a href="#">SCHEDULE A</a>	<a href="#">Services</a>
<a href="#">SCHEDULE B</a>	<a href="#">Reinsured Businesses and Recaptured Business</a>
<a href="#">SCHEDULE C</a>	<a href="#">Service Charges</a>
<a href="#">SCHEDULE D</a>	<a href="#">Business Associate Addendum</a>

---

This Business Services Agreement, dated \_\_\_\_\_, 2004 (this "Agreement"), is made by and between GNA CORPORATION, a Washington corporation ("GNA") and UNION FIDELITY LIFE INSURANCE COMPANY, an insurance company organized under the laws of the State of Illinois (the "Company").

RECITALS

- A. WHEREAS, GNA, General Electric Company, a New York corporation ("General Electric"), and certain of its other affiliates entered into a Master Agreement, dated as of \_\_\_\_\_, 2004 (the "Master Agreement"); and
- B. WHEREAS, it is contemplated by the Master Agreement that after the date hereof GNA will continue to perform, or GNA will cause its Subsidiaries and Affiliates to continue to perform, certain administrative and support services with respect to the Reinsured Businesses (as defined below) and that GNA will perform, or GNA will cause its Subsidiaries and Affiliates to perform, certain administrative and support services with respect to the Recaptured Business (as defined below) in accordance with the terms and subject to the conditions set forth herein.

NOW, THEREFORE, in consideration of the foregoing and the mutual agreements contained herein and for other good and valuable consideration, the receipt and adequacy of which are hereby acknowledged, the parties hereto hereby agree as follows:

**ARTICLE I**

**DEFINITIONS**

SECTION 1.01. Certain Defined Terms. Unless otherwise defined herein, all capitalized terms used herein shall have the same meaning as in the Master Agreement.

The following capitalized terms used in this Agreement shall have the meanings set forth below:

"Applicable Law" means any federal, state, local or foreign law (including common law), statute, ordinance, rule, regulation, order, writ, injunction, judgment, permit, governmental agreement or decree applicable to a Person or any such Person's subsidiaries, properties, assets, or to such Person's officers, directors, managing directors, employees or agents in their capacity as such.

"CPR Arbitration Rules" shall have the meaning specified in Section 5.04(a)

"GEFA" means GE Financial Assurance Holdings, Inc.

"Governmental Authority" means any foreign or national government, any state or other political subdivision thereof, and any entity exercising executive, legislative, judicial, regulatory or administrative functions of or pertaining to government.

"Initial Notice" shall have the meaning specified in Section 5.02.

---

"Long-Term Care Retroceded Business" means the long-term care insurance business reinsured by the Company pursuant to those Reinsurance Agreements identified as numbered items 7 and 8 on Schedule B hereto.

"Person" means any natural person, firm, limited liability company, general partnership, limited partnership, joint venture, association, corporation, trust, Governmental Authority or other entity.

"Recapture Agreements" means those agreements identified as numbered items 11 and 12 on Schedule B hereto.

"Recaptured Business" means the structured settlement annuity business recaptured by the Company pursuant to the Recapture Agreements.

"Reinsurance Agreements" means those reinsurance agreements relating to the Reinsured Businesses and which are listed on Schedule B hereto.

"Reinsured Businesses" means collectively, the Long-Term Care Retroceded Business, the Structured Settlement Annuity Reinsured Business and the Variable Annuity Reinsured Business.

"Response" shall have the meaning specified in Section 5.02.

"Structured Settlement Annuity Reinsured Business" means the structured settlement annuity business reinsured by the Company pursuant to those Reinsurance Agreements identified as numbered items 1 through 6 on Schedule B hereto.

"Termination Date" means the effective date of any termination, in whole or in part, of this Agreement as provided in Section 6.01.

"Variable Annuity Reinsured Business" means the variable annuity business reinsured by the Company pursuant to those Reinsurance Agreements identified as numbered items 9 and 10 on Schedule B hereto.

SECTION 1.02. Other Terms. For purposes of this Agreement, the following terms have the meanings set forth in the sections or agreements indicated.

Affiliate	Master Agreement
Agreement	Preamble
Closing	Master Agreement
Company	Recitals
Force Majeure	Master Agreement
GE Confidential Information	Master Agreement
General Electric	Preamble
Genworth Confidential Information	Master Agreement
Master Agreement	Recitals
Services	Section 2.01(a)
Service Charges	Section 3.01(a)

Term	Section
Service Provider	Section 4.03
Standard for Services	Section 4.01
Subsidiary	Master Agreement
Taxes	Section 7.03
Third Party Claim	Master Agreement

## ARTICLE II

### SERVICES AND TERMS

#### SECTION 2.01. Services; Scope

(a) During the period commencing on the date hereof and ending on the Termination Date, subject to the terms and conditions set forth in this Agreement, GNA shall perform, or cause its Subsidiaries and Affiliates to perform, with respect to the Reinsured Businesses and the Recaptured Business the services listed in Schedule A hereto (the “Service(s)”).

(b) The Services shall include, and the Service Charges reflect charges for, such maintenance, support, error correction, training, updates and enhancements normally and customarily performed by GNA or its applicable Subsidiaries and Affiliates in connection with providing such services.

(c) The Services shall not include any services GNA and its Subsidiaries and Affiliates performs or causes to be performed pursuant to (i) that certain Transition Services Agreement, dated as of \_\_\_\_\_, 2004, by and among General Electric Company, General Electric Capital Corporation, GEI, Inc., GEFAHI, GE Asset Management Incorporated, Genworth Financial, Inc., and GNA, (ii) the Reinsurance Agreements or (iii) that certain Administrative Services Agreement by and between the Company and First Colony Life Insurance Company relating to the Recaptured Business.

## ARTICLE III

### COSTS AND DISBURSEMENTS

#### SECTION 3.01. Costs and Disbursements.

(a) As reimbursement for expenses incurred by GNA and its Subsidiaries and Affiliates in performing the Services with respect to the Reinsured Businesses and the Recaptured Business, the Company shall pay to GNA with respect to each calendar month ending after the Inception Date of each reinsurance agreement listed on Schedule B hereto, a service charge (the “Service Charges”) in an amount calculated in accordance with Schedule C hereto, as subsequently adjusted, in part, in accordance with the methodology and procedures set forth in Schedule C.

(b) GNA shall deliver an invoice to the Company on a monthly basis in arrears for the Service Charges due to GNA under this Agreement. The Company shall pay the

amount of such invoice to GNA in U.S. dollars within seventy-five (75) days of the date of such invoice. In the event that all or any portion of any payment due GNA pursuant to this Agreement becomes overdue, the portion of the amount overdue shall bear interest at an annual rate equal to the then current thirty (30) day U.S. Treasury Bill discount rate on the date that the payment becomes overdue plus 200 basis points, for the period that the amount is overdue. As soon as practicable after receipt by GNA of any reasonable written request by the Company, GNA shall provide the Company with reasonably detailed data and documentation sufficient to support the calculation of any amount due to GNA under this Agreement for the purpose of verifying the accuracy of such calculation. If, after reviewing such data and documentation, the Company disputes GNA’s calculation of any amount due to GNA, then the dispute shall be resolved pursuant to Article V.

## ARTICLE IV

### STANDARD FOR SERVICE; COMPLIANCE WITH APPLICABLE LAW; LIMITED LIABILITY

SECTION 4.01. Standard for Service. Except as otherwise provided in this Agreement (including in Schedule A hereto), GNA shall perform, or cause its Subsidiaries and Affiliates to perform, the Services (a) in the same manner as they conduct their own businesses not subject to this Agreement and (b) in accordance with the administrative performance standards of GNA and its applicable Subsidiaries and Affiliates in effect on the date hereof, with such revisions to such standards as are made in the ordinary course (the “Standard for Services”).

SECTION 4.02. Compliance with Applicable Law. GNA shall comply, and shall cause its Subsidiaries and Affiliates to comply, with all Applicable Law when providing the Services or when performing obligations under this Agreement. Nothing in this Agreement shall require GNA or its Subsidiaries or Affiliates to act or refuse to act other than in compliance with Applicable Law.

SECTION 4.03. Limited Liability. Notwithstanding the provisions of Section 4.01, GNA and its Subsidiaries and Affiliates and their respective directors, officers or employees (or any of the heirs, executors, successors or assigns of any of the foregoing) (each, a “Service Provider”) shall have no liability to the Company or its Subsidiaries and Affiliates in excess of \$10,000,000 in the aggregate for any and all claims in contract, tort or otherwise for or in connection with any breach

of its obligations under this Agreement; provided, however, that such limitation on liability shall not extend to or otherwise limit any liabilities that result directly from such Service Provider's gross negligence or willful misconduct.

## ARTICLE V

### DISPUTE RESOLUTION

SECTION 5.01. General Provisions. (a) Any dispute, controversy or claim arising out of or relating to this Agreement or the validity, interpretation, breach or termination thereof or otherwise relating to any of the Services performed hereunder (a "Dispute"), shall be

4

---

resolved in accordance with the procedures set forth in this Article V, which shall be the sole and exclusive procedures for the resolution of any such Dispute unless otherwise specified below.

(b) Commencing with the request contemplated by Section 5.02, all communications between the parties or their representatives in connection with the attempted resolution of any Dispute, including any mediator's evaluation referred to in Section 5.03, shall be deemed to have been delivered in furtherance of a Dispute settlement and shall be exempt from discovery and production, and shall not be admissible in evidence for any reason (whether as an admission or otherwise), in any arbitral or other proceeding for the resolution of the Dispute.

(c) In connection with any Dispute, the parties expressly waive and forego any right to (i) special, indirect, punitive, incidental or consequential, lost profits, exemplary, statutorily-enhanced or similar damages, losses or expenses (provided that any such liability with respect to a Third Party Claim (as defined in the Master Agreement) shall be considered direct damages) and (ii) trial by jury.

(d) The specific procedures set forth below, including but not limited to the time limits referenced therein, may be modified by agreement of the parties in writing.

(e) All applicable statutes of limitations and defenses based upon the passage of time shall be tolled while the procedures specified in this Article V are pending. The parties will take such action, if any, required to effectuate such tolling.

SECTION 5.02. Consideration by Senior Executives. If a Dispute is not resolved in the normal course of business at the operational level, the parties shall attempt in good faith to resolve such Dispute by negotiation between executives who hold, at a minimum, the office of President and CEO of the respective business entities involved in such Dispute. Either party may initiate the executive negotiation process by providing a written notice to the other (the "Initial Notice"). Fifteen (15) days after delivery of the Initial Notice, the receiving party shall submit to the other a written response (the "Response"). The Initial Notice and the Response shall include (i) a statement of the Dispute and of each party's position, and (ii) the name and title of the executive who will represent that party and of any other person who will accompany the executive. Such executives will meet in person or by telephone within thirty (30) days of the date of the Initial Notice to seek a resolution of the Dispute.

SECTION 5.03. Mediation. If a Dispute is not resolved by negotiation as provided in Section 5.02 within forty-five (45) days from the delivery of the Initial Notice, then either party may submit the Dispute for resolution by mediation pursuant to the CPR Institute for Dispute Resolution (the "CPR") Model Mediation Procedure as then in effect. The parties will select a mediator from the CPR Panels of Distinguished Neutrals, but such mediator must have prior U.S. reinsurance experience either as a lawyer or as a present or former officer or management employee of a reinsurance company, but not of GNA, or the Company, or any of their respective affiliates. Either party at commencement of the mediation may ask the mediator to provide an evaluation of the Dispute and the parties' relative positions.

5

---

SECTION 5.04. Arbitration. (a) If a Dispute is not resolved by mediation as provided in Section 5.03 within thirty (30) days of the selection of a mediator (unless the mediator chooses to withdraw sooner), either party may submit the Dispute to be finally resolved by arbitration pursuant to the CPR Rules for Non-Administered Arbitration as then in effect (the "CPR Arbitration Rules"). The parties consent to a single, consolidated arbitration for all known Disputes existing at the time of the arbitration and for which arbitration is permitted.

(b) The neutral organization for purposes of the CPR Arbitration Rules will be the CPR. The arbitral tribunal shall be composed of three arbitrators who are each experienced in the U.S. reinsurance business, of whom each party shall appoint one in accordance with the "screened" appointment procedure provided in Rule 5.4 of the CPR Arbitration Rules. The non-party appointed arbitrator must have prior U.S. reinsurance experience as a present or former officer or management employee of a reinsurance company, but not of GNA or the Company or any of their respective affiliates. The arbitration shall be conducted in New York City. Each party shall be permitted to present its case, witnesses and evidence, if any, in the presence of the other party. A written transcript of the proceedings shall be made and furnished to the parties. The arbitrators shall determine the Dispute in accordance with the law of Illinois, without giving effect to any conflict of law rules or other rules that might render such law inapplicable or unavailable, and shall apply this Agreement according to its terms, provided that the provisions relating to arbitration shall be governed by the Federal Arbitration Act, 9 U.S.C. §§ 1 et seq.

(c) The parties agree to be bound by any award or order resulting from any arbitration conducted hereunder and further agree that judgment on any award or order resulting from an arbitration conducted under this Section 5.04 may be entered and enforced in any court having jurisdiction thereof.

(d) Except as expressly permitted by this Agreement, no party will commence or voluntarily participate in any court action or proceeding concerning a Dispute, except (i) for enforcement as contemplated by Section 5.04(c) above, (ii) to restrict or vacate an arbitral decision based on the grounds specified under applicable law, or (iii) for interim relief as provided in paragraph (e) below. For purposes of the foregoing the parties hereto submit to the non-exclusive jurisdiction of the courts of the State of New York.

(e) In addition to the authority otherwise conferred on the arbitral tribunal, the tribunal shall have the authority to make such orders for interim relief, including injunctive relief, as it may deem just and equitable. Notwithstanding paragraph (d) above, each party acknowledges that in the event of any actual or threatened breach of certain of the provisions of this Agreement, the remedy at law would not be adequate, and therefore injunctive or other interim relief may be sought immediately to restrain such breach. If the tribunal shall not have been appointed, either party may seek interim relief from a court having jurisdiction if the award to which the applicant may be entitled may be rendered ineffectual without such interim relief. Upon appointment of the tribunal following any grant of interim relief by a court, the tribunal may affirm or disaffirm such relief, and the parties will seek modification or rescission of the court action as necessary to accord with the tribunal's decision.

(f) Each party will bear its own attorneys fees and costs incurred in connection with the resolution of any Dispute in accordance with this Article V.

6

---

**ARTICLE VI**  
**TERMINATION**

SECTION 6.01. Termination of the Agreement.

- (a) This Agreement will terminate in its entirety on the earliest of:
- (i) the date the Company's liability under all of the Reinsurance Agreements and the Recaptured Business is terminated in accordance with the terms thereof;
  - (ii) the date that all of the Reinsurance Agreements are terminated in accordance with the terms thereof and the Company's liability under the Recaptured Business is terminated; or
  - (iii) the date that this Agreement has been terminated with respect to all of the Reinsured Businesses and the Recaptured Business under Section 6.02(e).
- (b) This Agreement is subject to immediate termination at the option of the Company, upon written notice to GNA, on the occurrence of any of the following events:
- (i) A voluntary or involuntary proceeding is commenced in any jurisdiction by or against GNA or its Subsidiaries or Affiliates performing Services pursuant to this Agreement for the purpose of conserving, rehabilitating or liquidating GNA or such Subsidiaries or Affiliates, but only if the Services performed by the subject of such proceeding are not assumed or performed by GNA or its Subsidiaries or Affiliates that are not the subject of such proceeding; or
  - (ii) GNA or its Subsidiaries and Affiliates are unable to perform the services required under this Agreement for a period of thirty (30) consecutive days for any reason other than as a result of a Force Majeure.
- (c) This Agreement may be terminated at any time upon the mutual written consent of the parties hereto, which writing shall state the effective date of termination.

SECTION 6.02. Termination with Respect to Any Reinsured Business or Recaptured Business The term of this Agreement will terminate with respect to the portion of any Reinsured Business under any given Reinsurance Agreement or any Recaptured Business on the earliest of:

- (a) the date the Company's liability under such Reinsurance Agreement is terminated in accordance with the terms thereof;
- (b) the date that such Reinsurance Agreement is terminated in accordance with the terms thereof;
- (c) with respect to any Recaptured Business, the date on which the Company's liability under such Recaptured Business is terminated;

7

---

- (d) the date that the Company or its assignee becomes entitled to assume administration of the portion of the Reinsured Business reinsured under such Reinsurance Agreement or the administration of the Recaptured Business;
- (e) seventy-five (75) days following written notice by the Company of GNA's willful, material breach of its obligations under Articles II and IV of this Agreement with respect to such Reinsured Business or Recaptured Business (provided that the Company shall not have the right to terminate this Agreement (A) for so long as the GNA and its Subsidiaries and Affiliates are making good faith effort to cure such breach, not to exceed an additional one hundred eighty (180) days or (B) during the pendency of any dispute resolution proceedings as set forth in Article V regarding an alleged material breach); or
- (f) such other date as agreed by the Company and GNA.

SECTION 6.03. Effect of Termination. Upon termination of this Agreement in accordance with its terms, GNA will have no further obligation to perform any Service, and the Company will have no obligation to pay any Service Charges relating to any Service or make any other payments under this Agreement (other than for Services performed prior to such termination). Upon termination of this Agreement with respect to a Reinsured Business or a Recaptured Business in accordance with this Agreement's terms, GNA will have no further obligation to perform, or cause its Subsidiaries or Affiliates to perform any Service with respect to such Reinsured Business or such Recaptured Business, and the Company will have no obligation to pay any Service Charges relating to any Service with respect to such Reinsured Business or such Recaptured Business or make any other payments under this Agreement with respect to such Reinsured Business or Recaptured Business (other than for Services performed prior to such termination).

SECTION 6.04. Survival. Article III (Costs and Disbursements) (but only in connection with Service Charges incurred and accrued as of the date of termination of this Agreement and the terms of Section 3.01(b) as applied to such Service Charges), Section 4.03 (Limitation of Liability), Article V (Dispute Resolution), Section 6.03 (Effect of Termination), Section 6.04 (Survival), and Article VII (General Provisions) shall survive the expiration or other termination of this Agreement and remain in full force and effect.

SECTION 6.05. Force Majeure. GNA (and any Person acting on its behalf including its Subsidiaries and Affiliates) shall not have any liability or responsibility for failure to fulfill any obligation under this Agreement so long as and to the extent to which the fulfillment of such obligation is prevented, frustrated, hindered or delayed as a consequence of circumstances of Force Majeure. As soon as reasonably practicable after the occurrence of any such event GNA shall: (a) notify the Company of the nature and extent of any such Force Majeure condition and (b) use commercially reasonable efforts to remove any such causes and resume performance under this Agreement as soon as feasible.

8

---

**ARTICLE VII**  
**GENERAL PROVISIONS**

SECTION 7.01. Subcontractors. GNA and its Subsidiaries and Affiliates may hire or engage one or more subcontractors to perform any or all of its obligations under this Agreement; provided that if such subcontractors are used solely in connection with the Reinsured Business or the Recaptured Business, then the prior

written consent of the Company to the use of any such subcontractors shall be required, which consent will not be unreasonably withheld; provided further that GNA shall in all cases remain liable for all its obligations under this Agreement, including, without limitation, with respect to the scope of the Services, the Standard for Services and the content of the Services performed in respect of the Reinsured Businesses and the Recaptured Business. Under no circumstances shall the Company be responsible for making any payments directly to any subcontractor engaged by GNA or its Subsidiaries or Affiliates.

SECTION 7.02. Additional Services; Books and Records.

(a) If, during the term of this Agreement, either party identifies any additional or other service that GNA or its Subsidiaries or Affiliates are performing or that is necessary for GNA to start performing in respect of the Reinsured Businesses and the Recaptured Business, the parties hereto agree to negotiate in good faith with respect to the Service Charge for such service (provided that such services are of a type generally performed in respect of business like the Reinsured Businesses and the Recaptured Business) and the applicable service fees, payment procedures, and other rights and obligations with respect thereto. To the extent practicable, such additional or other services shall be performed on terms substantially similar to those applicable to Services of similar types and otherwise on terms consistent with those contained in this Agreement.

(b) All books, records and data maintained by GNA and its Subsidiaries and Affiliates with respect to the performance of a Service with respect to the Reinsured Businesses shall be the exclusive property of GNA and its applicable Subsidiaries and Affiliates. The Company, at its sole cost and expense, shall have the right to inspect, and make copies of, any such books, records and data during regular business hours upon reasonable advance notice to GNA.

(c) All books, records and data maintained by GNA and its Subsidiaries and Affiliates with respect to the performance of a Service with respect to the Recaptured Business shall be the exclusive property of the Company. The Company, at its sole cost and expense, shall have the right to inspect, and make copies of, any such books, records and data during regular business hours upon reasonable advance notice to GNA.

SECTION 7.03. Taxes.

(a) Each party shall be responsible for any personal property taxes on property it owns or leases, for franchise and privilege taxes on its business, and for taxes based on its net income or gross receipts.

9

(b) The Company may report and (as appropriate) pay any sales, use, excise, value-added, services, consumption, and other taxes and duties ("Taxes") with respect to the Reinsured Business directly if the Company provides GNA with a direct pay or exemption certificate.

(c) The parties agree to cooperate with each other to enable each to more accurately determine its own tax liability and to minimize such liability to the extent legally permissible. GNA's invoices shall separately state the amount of any Taxes GNA is proposing to collect from the Company.

(d) GNA shall promptly notify the Company of any claim for Taxes asserted by applicable taxing authorities with respect to the Reinsured Business for which the Company is alleged to be financially responsible hereunder. GNA shall coordinate with the Company the response to and settlement of, any such claim. Notwithstanding the above, the Company's liability for such Taxes is conditioned upon GNA providing the Company notification within twenty (20) business days of receiving any proposed assessment of any additional Taxes, interest or penalty due by GNA.

(e) The Company shall be entitled to receive and to retain any refund of Taxes paid to GNA pursuant to this Agreement. In the event GNA shall be entitled to receive a refund of any Taxes paid by the Company to GNA, GNA shall promptly pay, or cause the payment of, such refund to the Company.

SECTION 7.04. Confidential Information. GNA agrees to maintain and safeguard, and cause its Subsidiaries and Affiliates to maintain and safeguard, all GE Confidential Information pursuant to Section 6.2 of the Master Agreement and the Company agrees to maintain and safeguard, and cause its Subsidiaries and Affiliates to maintain and safeguard, all Genworth Confidential Information pursuant to Section 6.2 of the Master Agreement and each party hereto agrees that Section 6.2 of the Master Agreement is hereby incorporated by reference into, and made a part of, this Agreement. The parties hereto agree to comply with the terms of the Business Associate Addendum attached as Schedule D.

SECTION 7.05. Non-disclosure; Privilege; Conflicts of Interest. Neither GNA, the Company nor any of their respective Subsidiaries or Affiliates shall be required to disclose any of their respective trade secret information or other information that provides GNA and its Subsidiaries and Affiliates, or the Company and its Subsidiaries and Affiliates, as applicable, a significant competitive advantage. Further, neither GNA, the Company, nor any of their respective Subsidiaries or Affiliates will be required to provide any information in connection with this Agreement if the provision of such information would serve as a waiver of any attorney-client privilege or other applicable privilege afforded such information. In no event will GNA or its Subsidiaries and Affiliates be required to perform any Services if doing so would constitute a conflict of interest or a breach of any applicable ethical rules governing the conduct of attorneys; provided that GNA shall use its commercially reasonable efforts to resolve any such conflict of interest or prevent any breach of any such ethical rules.

10

SECTION 7.06. Headings and Schedules. Headings used herein are not a part of this Agreement and shall not affect the terms hereof. The attached Schedules are a part of this Agreement.

SECTION 7.07. Notices. All notices, requests, demands and other communications under this Agreement must be in writing and will be deemed to have been duly given or made as follows: (a) if sent by registered or certified mail in the United States return receipt requested, upon receipt; (b) if sent by reputable overnight air courier, two business days after mailing; (c) if sent by facsimile transmission, with a copy mailed on the same day in the manner provided in (a) or (b) above, when transmitted and receipt is confirmed by telephone; or (d) if otherwise actually personally delivered, when delivered, and shall be delivered as follows:

If to GNA:

[                    ]  
[                    ]  
[                    ]  
Facsimile: [                    ]  
Attention: [                    ]

With a copy to:

[                    ]  
[                    ]

[                    ]  
Facsimile: [                    ]  
Attention: [                    ]

If to the Company:

Union Fidelity Life Insurance Company  
200 North Martingale Road  
Schaumburg, IL 60173-2096  
Facsimile: (847) 330-3404  
Attention: Chief Financial Officer

With a copy to:

Union Fidelity Life Insurance Company  
200 North Martingale Road  
Schaumburg, IL 60173-2096  
Facsimile: (847) 605-3044  
Attention: General Counsel

or to such other address or to such other Person as either party may have last designated by notice to the other party.

11

---

SECTION 7.08. Successors and Assigns. This Agreement shall be binding upon and inure to the benefit of the parties hereto and their respective successors, permitted assigns and legal representatives. Neither this Agreement, nor any right or obligation hereunder, may be assigned by any party without the prior written consent of the other party hereto. Any assignment in violation of this Section 7.08 shall be void and shall have no force and effect.

SECTION 7.09. Execution in Counterpart. This Agreement may be executed by the parties hereto in any number of counterparts, and by each of the parties hereto in separate counterparts, each of which counterparts, when so executed and delivered, shall be deemed to be an original, but all such counterparts shall together constitute but one and the same instrument.

SECTION 7.10. Currency. Whenever the word "Dollars" or the "\$" sign appear in this Agreement, they shall be construed to mean United States Dollars, and all transactions under this Agreement shall be in United States Dollars.

SECTION 7.11. Amendments. This Agreement may not be changed, altered or modified unless the same shall be in writing executed by GNA and the Company.

SECTION 7.12. Governing Law. This Agreement will be construed, performed and enforced in accordance with the laws of the State of Illinois without giving effect to its principles or rules of conflict of laws thereof to the extent such principles or rules would require or permit the application of the laws of another jurisdiction.

SECTION 7.13. Entire Agreement; Severability. (a) This Agreement constitutes the entire agreement between the parties hereto relating to the subject matter hereof and supersedes all prior and contemporaneous agreements, understandings, statements, representations and warranties, negotiations and discussions, whether oral or written, of the parties and there are no general or specific warranties, representations or other agreements by or among the parties in connection with the entering into of this Agreement or the subject matter hereof except as specifically set forth or contemplated herein.

(b) If any provision of this Agreement is held to be void or unenforceable, in whole or in part, (i) such holding shall not affect the validity and enforceability of the remainder of this Agreement, including any other provision, paragraph or subparagraph, and (ii) the parties agree to attempt in good faith to reform such void or unenforceable provision to the extent necessary to render such provision enforceable and to carry out its original intent.

SECTION 7.14. No Waiver; Preservation of Remedies. No consent or waiver, express or implied, by any party to or of any breach or default by any other party in the performance by such other party of its obligations hereunder shall be deemed or construed to be a consent or waiver to or of any other breach or default in the performance of obligations hereunder by such other party hereunder. Failure on the part of any party to complain of any act or failure to act of any other party or to declare any other party in default, irrespective of how long such failure continues, shall not constitute a waiver by such first party of any of its rights hereunder. The rights and remedies provided are cumulative and are not exclusive of any rights or remedies that any party may otherwise have at law or equity.

12

---

SECTION 7.15. Cooperation. Each party hereto shall cooperate fully with the other in all reasonable respects in order to accomplish the objectives of this Agreement including making available to each their respective officers and employees for interviews and meetings with Governmental Authorities and furnishing any additional assistance, information and documents as may be reasonably requested by a party from time to time.

SECTION 7.16. Third Party Beneficiary. Nothing in this Agreement will confer any rights upon any Person that is not a party or a successor or permitted assignee of a party to this Agreement.

SECTION 7.17. Negotiated Agreement. This Agreement has been negotiated by the parties and the fact that the initial and final draft will have been prepared by either party or an intermediary will not give rise to any presumption for or against any party to this Agreement or be used in any respect or forum in the construction or interpretation of this Agreement or any of its provisions.

SECTION 7.18. Interpretation. Wherever the words "include," "includes" or "including" are used in this Agreement, they shall be deemed to be followed by the words "without limitation." In addition, interpretation of this Agreement shall be governed by the following rules of construction: (a) words in the singular shall be held to include the plural and vice versa and words of one gender shall be held to include the other gender as the context requires, (b) references to the terms Article, Section, paragraph, and Schedule are references to the Articles, Sections, paragraphs, and Schedules to this Agreement unless otherwise specified, (c) provisions shall apply, when appropriate, to successive events and transactions, and (d) this Agreement shall be construed without regard to any presumption or rule requiring construction or interpretation against the party drafting or causing any instrument to be drafted.

SECTION 7.19. No Right to Set-Off. The Company shall pay the full amount of costs and disbursements incurred under this Agreement, and shall not set-off, counterclaim or otherwise withhold any other amount owed to GNA on account of any obligation owed by GNA to the Company.

IN WITNESS WHEREOF, the parties have caused this Agreement to be executed on the date first written above by their respective duly authorized officers.

GNA CORPORATION

By:  
Name:  
Title:

UNION FIDELITY LIFE INSURANCE COMPANY

By:  
Name:  
Title:

SCHEDULE A

SERVICES

The Services are broadly defined as activities performed by GNA and its Subsidiaries and Affiliates that benefit the Reinsured Businesses and the Recaptured Business. The Services are more fully defined, without limitation, below by functional area under the general headings “Business Overhead Services” and “Corporate Overhead Services.”

Business Overhead Services

The services below will be provided by the “WIM” business unit of GNA and its Subsidiaries and Affiliates with regards to the Structured Settlement Annuity Reinsured Business, the Recaptured Business and the Variable Annuity Reinsured Business:

Executive:  
General support, counsel, strategy and leadership provided by WIM’s Chief Executive Officer.

Human Resources:  
General business level Human Resource related activities including but not limited to leadership development, employee recruitment and staffing, implementation of compensation policies and practices, payroll and benefit administration, organizational communication, training, general security and employee issue resolution and guidance.

Finance:  
Cost of finance activities including but not limited to product financial support and analysis, account reconciliations, state reporting, product profitability analysis, investment income planning & analysis, expense management, audit support, statutory & GAAP accounting, reporting & analysis and ad hoc financial analysis.

Legal/Compliance:  
Cost of support and coordination of litigation, government relations, human resource, intellectual property, insurance regulatory, consumer privacy, contract, compliance, and public relations matters.

Risk:  
Cost of Risk Management and reinsurance support—Monitor production vs. authority limits, monitor and review key risk measures. General oversight of inforce product performance analysis and reviews. Reinsurance oversight and treaty management including settlement with reinsurers.

---

Facilities:  
Campus expenses including building rent and maintenance, parking garage, cafeteria, campus lawn care and utilities.

Information Technology:  
General business technology infrastructure costs including but not limited to general management, help desk assistance, data center management, disaster recovery plans and digitization of processes.

Six Sigma Quality:  
Costs including business project management and process improvement coaching, execution and leadership.

Product Management:  
Costs for product line managers to manage inforce policies and general product line maintenance activities such as risk assessment, return on equity (“ROE”) variance analysis and related ROE improvement projects.

Operations:  
Costs including management, project leadership and administrative support for service operations supporting customers, policyholders and other stakeholders.

Other:



Costs including corporate insurance allocation to product lines (e.g., cost of building insurance and other property, plant and equipment).

**Retention:**

Costs including monitoring of inforce policy retention levels, design and execute programs to retain inforce business.

Corporate Overhead Services

The services listed below will be provided by the “HQ” or corporate functions at GNA with regard to each of the Reinsured Businesses and Recaptured Business:

**Executive Office:**

Costs including general support, counsel, strategy and leadership provided by CEO, various HQ business insurance charges and allocations.

**Human Resources:**

Costs of general HR related activities such as leadership development, employee recruitment and

staffing, compensation policies and practices, payroll and benefit administration, organizational communication, that which is currently known as the “GEFA University” learning center including online course development and administration, physical security of the business locations and employee issue resolution and guidance.

**Actuarial Department and Capital Management:**

Costs including rating agency coordination such as answering queries, making presentations, and providing other required information for rating agencies; state insurance department regulatory support, NAIC lobbying and investor relations, including issues related to risk based capital; completion of various actuarial and capital management functions such as: reserve calculations, experience analysis, asset/liability management, cash flow testing support, dividend forecasting, capital management, reinsurance and capital markets support.

**Finance:**

HQ related finance costs, such as business level financial planning and analysis, Statutory and GAAP accounting, reinsurance accounting, reporting and analysis, annual statement (“blue book”) preparation and related disclosures and schedules, statutory audit support, tax information needed to prepare returns, treasury services, financial systems related support, maintenance and infrastructure, technical accounting expertise.

**Product Management:**

Costs including general product management and product marketing compliance, support pricing and retention initiatives.

**Legal:**

Costs including support and coordination of litigation, government relations, human resource, intellectual property, insurance regulatory, consumer privacy, contract, compliance, and public relations matters.

**Risk:**

Costs including business risk policies (currently known as “Policy 5.0/6.0”) development and monitoring, treaty management, reinsurance and controllership oversight. These policies are developed and implemented by the Risk team with others at Headquarters to manage assets and liabilities, control business risks associated with investments, controllership, systems infrastructure, process management, etc. Various metrics are used to “trigger” leadership decision points in an effort to reduce business risks. Includes the leadership of projects to reduce the business risks associated with various systems and processes across the business.

**Sourcing (Purchasing) and Facilities:**

Costs including sourcing related services including Purchasing card (“P-card”) Administration, Oracle sourcing/purchasing/receiving system (know as the “SSS System”) Administration, requisition processing, competitive bidding/auction services, spend data tracking/analysis, and

contract definition/negotiation. Leadership of certain expense reduction projects currently known as “Bullet Trains” (which focus across the business on reducing individual expense categories (PC leasing, postage, consulting, telecommunications, office supplies, etc.) and other projects related to the increase in purchasing efficiency and reduction of costs.

**IT and e-Solutions:**

General management costs associated with IT infrastructure, management of on and off shore contractors, help desk, asset management (PC’s, printers, servers, etc.), email service, Wide Area Networks (WAN), desktop support (visiting actual users to assist them with IT needs), web hosting, Unix and NT system administration, global computer operations, intellectual property, contract and licenses of software, services and hardware, U.S.-based consulting and control over remote infrastructure (for example, those systems currently housed in Alpharetta, GA).

Costs of HQ security team, who provides disaster recovery, including risk analysis & coordination of all IT associated with Disaster Recovery. In addition, security includes coordination with all local business security officers, relating to intrusion detection, anti-virus and other protections of systems.

Costs including project management, oversight and project manager certification, using several industry standard processes including Six Sigma “DMAIC” process improvement and other process improvement/development regimes.

Costs of developing and monitoring architectural plans for future operations including technology related standards, guidelines and polices.

Costs of IT Vendor Management — includes negotiations and oversight for vendor agreements on hardware, software and services.

Costs of IT Solutions — delivers IT solutions that meet business needs through digitization of processes and deployment of web applications.

**Operations Excellence:**

Costs of Consolidation, Analysis, Management Strategy, and Leadership for Operations and Shared Services. Provide strategic leadership and oversight to all operations departments, ensuring that best practices are shared.

Costs of managing services used by all GEFA businesses, including Xerox (current outsourced document processing provider), “1-800 Think GE” call center (a point of contact for all GEFA products), and One Front Door (inbound imaging strategy).

Changes in Services

The Business Overhead Services and Corporate Overhead Services shall include such other comparable and/or successor Services implemented or maintained from time to time by GNA and its Subsidiaries and Affiliates.

SCHEDULE B

REINSURED BUSINESSES and RECAPTURED BUSINESS

**Structured Settlement Annuities**

1. Coinsurance Agreement, dated as of \_\_\_\_\_, 2004, by and between the Company and GE Life and Annuity Assurance Company, a Virginia domiciled life insurance company
2. Coinsurance Agreement, dated as of \_\_\_\_\_, 2004, by and between the Company and Federal Home Life Insurance Company, a Virginia domiciled life insurance company
3. Coinsurance Agreement, dated as of \_\_\_\_\_, 2004, by and between the Company and First Colony Life Insurance Company, a Virginia domiciled life insurance company
4. Coinsurance Agreement, dated as of \_\_\_\_\_, 2004, by and between the Company and General Electric Capital Assurance Company, a Delaware domiciled life insurance company
5. Coinsurance Agreement, dated as of \_\_\_\_\_, 2004, by and between the Company and GE Capital Life Assurance Company of New York, a New York domiciled life insurance company
6. Coinsurance Agreement, dated as of \_\_\_\_\_, 2004, by and between the Company and American Mayflower Life Insurance Company of New York, a New York domiciled life insurance company

**Long Term Care**

7. Retrocession Agreement, dated as of \_\_\_\_\_, 2004, by and between the Company and General Electric Capital Assurance Company, a Delaware domiciled life insurance company
8. Retrocession Agreement, dated as of \_\_\_\_\_, 2004, by and between the Company and GE Capital Life Assurance Company of New York, a New York domiciled life insurance company

**Variable Annuities**

9. Reinsurance Agreement, dated as of \_\_\_\_\_, 2004, by and between the Company and GE Life and Annuity Assurance Company, a Virginia domiciled life insurance company
10. Reinsurance Agreement, dated as of \_\_\_\_\_, 2004, by and between the Company and GE Capital Life Assurance Company of New York, a New York domiciled life insurance company

---

**Structured Settlement Annuities:**

11. Recapture Agreement dated as of \_\_\_\_\_, 2004, by and between the Company and GE Life and Annuity Assurance Company, a Virginia domiciled life insurance company
12. Recapture Agreement dated as of \_\_\_\_\_, 2004, by and between the Company and GE Capital Life Assurance Company of New York, a New York domiciled life insurance company

SCHEDULE C

SERVICE CHARGES

The "Annual Expense Reimbursement Factors" used to calculate the Service Charges for each respective line of business are as follows:

Structured Settlement Annuity Reinsured Business and Recaptured Business:

Corporate Overhead Factor \$\*\* per Annum

Business Overhead Factor \$\*\* per Policy

Variable Annuity Reinsured Business

Corporate Overhead Factor \$\*\* per Annum

Business Overhead Factor \$\*\* per Policy

Long-Term Care Retroceded Business

Corporate Overhead Factor \$\*\* per Annum

The Service Charges will be determined quarterly and billed to the Company in three equal installments at the end of the month during the quarter. Each monthly installment billed for a particular line of business will be determined by (a) multiplying the actual number of units at the beginning of the quarter covered by this Agreement times the Business Overhead Factor (divided by twelve), if applicable, and (b) adding the applicable Corporate Overhead Factor (divided by twelve).

The Annual Expense Reimbursement Factors for each respective line of business will be adjusted (i) for the year beginning January 1, 2005 and, thereafter, every three (3) years during the term of this Agreement based on a triennial cost/time study prepared in accordance with the methodology set forth below (the "Triennial Study") and (ii) for

the years between the Triennial Studies based on a report setting forth the Annual Expense Reimbursement Factors prepared in accordance with the methodology set forth below (the "Annual Expense Reimbursement Factors Report").

(a) Triennial Study. As soon as practicable (and in any event within sixty (60) days) prior to January 1, 2005 and prior to the beginning of every third calendar year thereafter during the term of this Agreement, GNA shall cause to be prepared and delivered to the Company the Triennial Study which sets forth the Annual Expense Reimbursement Factors for the next calendar year, together with all supporting data used in preparing the Triennial Study and work papers, in reasonable detail, setting forth the determination of such Annual Expense Reimbursement Factors based on such Triennial Study (such documents, together with the Triennial Study, the "Triennial Study Documents").

---

(b) Annual Expense Reimbursement Factors Report. As soon as practicable (and in any event within thirty (30) days) prior to January 1, 2006 and prior to the beginning of each calendar year thereafter in which no Triennial Study is prepared, GNA shall cause to be prepared and delivered to the Company the Annual Expense Reimbursement Factors Report, together with all supporting data used in preparing the Annual Expense Reimbursement Factors Report and work papers, in reasonable detail, setting forth the determination of such Annual Expense Reimbursement Factors for the next calendar year (such documents, together with the Annual Expense Reimbursement Factors Report, the "Annual Expense Reimbursement Factors Documents").

(c) Methodology. At the time of the Triennial Study, historical costs (to include costs for those services identified as Business Overhead Services and Corporate Overhead Services in Schedule A and any changes thereto pursuant to Schedule A) will be determined for the Annual Expense Reimbursement Factors identified above. For a given Business Overhead Factor (identified above in this Schedule C) the identified or allocated costs, as applicable, will be divided by the total number of remaining Reinsured Policies, Reinsured Contracts (as such terms are defined in the applicable Reinsurance Agreement) or Insurance Contracts (as such term is defined in the Administrative Services Agreement by and between Union Fidelity Life Insurance Company and First Colony Life Insurance Company effective as of [ ], 2004), as applicable, and the Company's current in-force business to derive an historical cost per unit. The historical cost per unit will be used as a prospective cost per unit for the next calendar year. For the purposes of allocating costs of providing Business Overhead Services, actual identified costs allocable to each of the lines of business specified above (Structured Settlement Annuity Reinsured Business, Recaptured Business and Variable Annuity Reinsured Business) shall be allocated to such lines of business. For the purpose of allocating costs of providing the Corporate Overhead Services, the historical costs of such services shall be allocated equally to each of the lines of business specified above.

For the two succeeding years in the period between the Triennial Studies the historical dollar amounts by Annual Expense Reimbursement Factors will be adjusted (rolled forward) for current year cost changes agreed to by GNA and the Company (in accordance with the procedures set forth above). The costs for Business Overhead Services will then be divided by the total number of remaining Reinsured Policies, Reinsured Contracts (as such terms are defined in the applicable Reinsurance Agreement) or Insurance Contracts (as such term is defined in the Administrative Services Agreement by and between Union Fidelity Life Insurance Company and First Colony Life Insurance Company effective as of [ ], 2004) for the current period to determine a prospective cost per unit for the next calendar year. The costs for Corporate Overhead Services shall be allocated equally to each of the lines of business specified above.

An additional adjustment, positive or negative, to the prospective cost per unit for Business Overhead Services or per annum for Corporate Overhead Services determined by either the Triennial Study or the two succeeding years may be negotiated between the parties. The additional adjustment is for special projected costs or benefits of productivity, process improvements, inflation, loss of scale, and any other cost variation that was not included in the prior Triennial Study or the succeeding roll forward.

2

---

The combined prospective unit cost, per annum cost and additional adjustment for a respective line of business is the Annual Expense Reimbursement Factor for that line of business.

(d) Review of Documents. Following the delivery of the Annual Expense Reimbursement Factors Documents or the Triennial Study Documents, as applicable, GNA shall (i) provide to the Company or its designated representative copies of such additional work papers and other documents relating to its preparation of the Annual Expense Reimbursement Factors Report or Triennial Study, as applicable, as the Company or its designated representative may reasonably request, including, without limitation, claims files and practices and (ii) cooperate with, and make its personnel and facilities reasonably available to, the Company and the Company's designated representative for the purpose of providing such other information as the Company or the Company's designated representative may reasonably request concerning Annual Expense Reimbursement Factor Documents or the Triennial Study Documents, as applicable, and the calculation of the Annual Expense Reimbursement Factors.

(e) Notice of Disagreement. In the event that the Company has any disagreement with any of the Annual Expense Reimbursement Factor Documents or the Triennial Study Documents, as applicable, the Company shall give written notice of all such disagreements (a "Notice of Disagreement") to GNA within thirty (30) days after the Annual Expense Reimbursement Factors Documents or the Triennial Study Documents, as applicable, are delivered to the Company. Any Notice of Disagreement shall set forth each item in disagreement and shall provide reasonable specificity as to the basis for each disagreement and shall specify the total adjustment to the Annual Expense Reimbursement Factors as proposed by GNA as a result of such items in disagreement.

(f) Dispute Resolution. If the Company does not deliver a Notice of Disagreement to the Company within such thirty (30) day period, the Annual Expense Reimbursement Factors Documents and the Triennial Study Documents, as applicable, shall be final and binding upon the parties hereto and shall constitute the final calculation of the Annual Expense Reimbursement Factors for the next calendar year. If the Company delivers a Notice of Disagreement to GNA within such thirty (30) day period, the parties shall (and shall cause their respective designated representatives to) negotiate in good faith to resolve all disagreements as promptly as practicable. Any changes in the Annual Expense Reimbursement Factors, if any, that are agreed to by the Company and GNA within sixty (60) days of the aforementioned delivery of the Annual Expense Reimbursement Factors Documents or the Triennial Study Documents, as applicable, shall be incorporated into a final calculation of the Annual Expense Reimbursement Factors. If the parties and their respective designated representatives are unable to resolve all disagreements within sixty (60) days of delivery of the Annual Expense Reimbursement Factors Documents or the Triennial Study Documents, as applicable, then all unresolved disagreements will be submitted within ten (10) days after the end of such sixty (60) day period for resolution in accordance herewith to an independent certified public accounting firm of national standing and reputation (the "Accounting Firm") mutually acceptable to the Company and GNA. The parties shall cooperate in good faith with the Accounting Firm and shall give the Accounting Firm access to all data and other information requested by the Accounting Firm for purposes of such resolution. The Accounting Firm shall, within thirty (30) days after its engagement, deliver to the Company and GNA a definitive calculation of the

3

---

Business Overhead Factors, which shall be final and binding upon the parties hereto and shall be so reflected in the calculation of the Business Overhead Factors. The Company and GNA shall each pay one-half of the fees and expenses of the Accounting Firm.

(g) Service Charges Pending Resolution. In the event of a dispute with respect to any Annual Expense Reimbursement Factors for the next succeeding Calendar year, the Company and GNA agree that the Annual Expense Reimbursement Factors then in effect under this Agreement shall remain in effect pending resolution of such dispute and adjustment, if any, in accordance with the dispute resolution procedure set forth in paragraph (f) above.

4

SCHEDULE D

BUSINESS ASSOCIATE ADDENDUM

I. Purpose.

In order to disclose certain information to GNA (for purposes of this Addendum, the “Provider”) under this Addendum, some of which may constitute Protected Health Information (defined below), the Company (for purposes of this Addendum, the “Recipient”) and Provider mutually agree to comply (and Provider shall cause its Subsidiaries and Affiliates performing Services to comply) with the terms of this Addendum for the purpose of satisfying the requirements of the Health Insurance Portability and Accountability Act of 1996 (“HIPAA”) and its implementing privacy regulations at 45 C.F.R. Parts 160-164 (“HIPAA Privacy Rule”). These provisions shall apply to Provider and its Subsidiaries and Affiliates to the extent that any or Provider or its Subsidiaries and Affiliates is considered a “Business Associate” under the HIPAA Privacy Rule and all references in this section to Business Associates shall refer to Provider or such Subsidiary or Affiliate. Capitalized terms not otherwise defined herein shall have the meaning assigned in the Agreement. Notwithstanding anything else to the contrary in the Agreement, in the event of a conflict between this Addendum and the Agreement, the terms of this Addendum shall prevail.

II. Permitted Uses and Disclosures.

A. Business Associate agrees to use or disclose Protected Health Information (“PHI”) that it creates for or receives from Recipient or its Subsidiaries only as follows. The capitalized term “Protected Health Information or PHI” has the meaning set forth in 45 Code of Federal Regulations Section 164.501, as amended from time to time. Generally, this term means individually identifiable health information including, without limitation, all information, data and materials, including without limitation, demographic, medical and financial information, that relates to the past, present, or future physical or mental health or condition of an individual; the provision of health care to an individual; or the past present, or future payment for the provision of health care to an individual; and that identifies the individual or with respect to which there is a reasonable basis to believe the information can be used to identify the individual. This definition shall include any demographic information concerning members and participants in, and applicants for, Recipient’s or its Subsidiaries’ health benefit plans. All other terms used in this Addendum shall have the meanings set forth in the applicable definitions under the HIPAA Privacy Rule.

B. Functions and Activities on Company’s Behalf. Business Associate is permitted to use and disclose PHI it creates for or receives from Recipient or its Subsidiaries only for the purposes described in this Addendum or the Agreement that are not inconsistent with the provisions of this Addendum, or as required by law, or following receipt of prior written approval from whichever of the Recipient or its Subsidiary or Affiliate for which the relevant PHI was created or from which the relevant PHI was received. In addition to these specific requirements below, Business Associate may use or disclose PHI only in a manner that would not violate the HIPAA Privacy Rule if done by the Recipient or its Subsidiaries.

---

C. Business Associate’s Operations. Business Associate is permitted by this Agreement to use PHI it creates for or receives from Recipient or its Subsidiaries: (i) if such use is reasonably necessary for Business Associate’s proper management and administration; and (ii) as reasonably necessary to carry out Business Associate’s legal responsibilities. Business Associate is permitted to disclose PHI it creates for or receives from Recipient or its Subsidiaries for the purposes identified in this Section only if the following conditions are met:

1. The disclosure is required by law; or
2. The disclosure is reasonably necessary to Business Associate’s proper management and administration, and Business Associate obtains reasonable assurances in writing from any person or organization to which Business Associate will disclose such PHI that the person or organization will:
  - a. Hold such PHI as confidential and use or further disclose it only for the purpose for which Business Associate disclosed it to the person or organization or as required by law; and
  - b. Notify Business Associate (who will in turn promptly notify whichever of the Recipient or its Subsidiary or Affiliate for which the relevant PHI was created or from which the relevant PHI was received) of any instance of which the person or organization becomes aware in which the confidentiality of such PHI was breached.

D. Minimum Necessary Standard. In performing the functions and activities on Recipient’s or its Subsidiaries’ behalf pursuant to the Agreement, Business Associate agrees to use, disclose or request only the minimum necessary PHI to accomplish the purpose of the use, disclosure or request. Business Associate must have in place policies and procedures that limit the PHI disclosed to meet this minimum necessary standard.

E. Prohibition on Unauthorized Use or Disclosure. Business Associate will neither use nor disclose PHI it creates or receives for or from Recipient, its Subsidiaries, or from another business associate of Recipient or its Subsidiaries, except as permitted or required by this Addendum or the Agreement that are not inconsistent with the provisions of this Addendum, or as required by law, or following receipt of prior written approval from whichever of the Recipient or its Subsidiary or Affiliate for which the relevant PHI was created or from which the relevant PHI was received.

F. De-identification of Information. Business Associate agrees neither to de-identify PHI it creates for or receives from Recipient or its Subsidiaries or from another business associate of Recipient or its Subsidiaries, nor use or disclose such de-identified PHI, unless such de-identification is expressly permitted under the terms and conditions of this Addendum or the Agreement and related to Recipient’s or its Subsidiaries’ activities for purposes of “treatment”, “payment” or “health care operations”, as those terms are defined under the HIPAA Privacy Rule. De-identification of PHI, other than as expressly permitted under the terms and conditions of the Addendum for Business Associate to perform services for Recipient or its Subsidiaries, is

---

not a permitted use of PHI under this Addendum. Business Associate further agrees that it will not create a “Limited Data Set” as defined by the HIPAA Privacy Rule using PHI it creates or receives, or receives from another business associate of Recipient or its Subsidiaries, nor use or disclose such Limited Data Set unless: (i) such creation, use or disclosure is expressly permitted under the terms and conditions of this Addendum or the Agreement that are not inconsistent with the provisions of this Addendum; and such creation, use or disclosure is for services provided by Business Associate that relate to Recipient’s or its Subsidiaries’ activities for purposes of “treatment”, “payment” or “health care operations”, as those terms are defined under the HIPAA Privacy Rule.

G. Information Safeguards. Business Associate will develop, document, implement, maintain and use appropriate administrative, technical and physical safeguards to preserve the integrity and confidentiality of and to prevent non-permitted use or disclosure of PHI created for or received from Recipient or its Subsidiaries. These safeguards must be appropriate to the size and complexity of Business Associate’s operations and the nature and scope of its activities. Business Associate agrees that these safeguards will meet any applicable requirements set forth by the U.S. Department of Health and Human Services, including (as of the effective date or as of the compliance date, whichever is applicable) any requirements set forth in the final HIPAA security regulations. Business Associate agrees to mitigate, to the extent practicable,

any harmful effect that is known to Business Associate resulting from a use or disclosure of PHI by Business Associate in violation of the requirements of this Addendum.

III. Conducting Standard Transactions. In the course of performing services for Recipient or its Subsidiaries, to the extent that Business Associate will conduct Standard Transactions for or on behalf of Recipient or its Subsidiaries, Business Associate will comply, and will require any subcontractor or agent involved with the conduct of such Standard Transactions to comply, with each applicable requirement of 45 C.F.R. Part 162. "Standard Transaction(s)" shall mean a transaction that complies with the standards set forth at 45 C.F.R. parts 160 and 162. Further, Business Associate will not enter into, or permit its subcontractors or agents to enter into, any trading partner agreement in connection with the conduct of Standard Transactions for or on behalf of the Recipient or its Subsidiaries that:

- a. Changes the definition, data condition, or use of a data element or segment in a Standard Transaction;
- b. Adds any data element or segment to the maximum defined data set;
- c. Uses any code or data element that is marked "not used" in the Standard Transaction's implementation specification or is not in the Standard Transaction's implementation specification; or
- d. Changes the meaning or intent of the Standard Transaction's implementation specification.

3

---

IV. Sub-Contractors, Agents or Other Representatives. Business Associate will require any of its subcontractors, agents or other representatives to which Business Associate is permitted by this Addendum or the Agreement (or is otherwise given Recipient's or the relevant Subsidiary's or Affiliate's prior written approval) to disclose any of the PHI Business Associate creates or receives for or from Recipient or its Subsidiaries, to provide reasonable assurances in writing that subcontractor or agent will comply with the same restrictions and conditions that apply to the Business Associate under the terms and conditions of this Addendum with respect to such PHI.

V. Protected Health Information Access, Amendment and Disclosure Accounting.

A. Access. Business Associate will promptly upon Recipient's or its Subsidiary's or Affiliate's request make available to Recipient, its Subsidiary, its Affiliate, or, at Recipient's or such Subsidiary's or Affiliate's direction, to the individual (or the individual's personal representative) for inspection and obtaining copies any PHI about the individual which Business Associate created for or received from Recipient or its Subsidiary or Affiliate and that is in Business Associate's custody or control, so that Recipient or its Subsidiary or Affiliate may meet its access obligations under 45 Code of Federal Regulations § 164.524.

B. Amendment. Upon Recipient's or its Subsidiary's or Affiliate's request Business Associate will promptly amend or permit Recipient or its Subsidiary or Affiliate access to amend any portion of the PHI which Business Associate created for or received from Recipient or its Subsidiary or Affiliate, and incorporate any amendments to such PHI, so that Recipient or its Subsidiary or Affiliate may meet its amendment obligations under 45 Code of Federal Regulations § 164.526.

C. Disclosure Accounting. So that Recipient or its Subsidiaries or Affiliates may meet their disclosure accounting obligations under 45 Code of Federal Regulations § 164.528:

1. Disclosure Tracking. Business Associate will record for each disclosure, not excepted from disclosure accounting under Section V.C.2 below, that Business Associate makes to Recipient or its Subsidiaries of PHI that Business Associate creates for or receives from Recipient or its Subsidiaries, (i) the disclosure date, (ii) the name and member or other policy identification number of the person about whom the disclosure is made, (iii) the name and (if known) address of the person or entity to whom Business Associate made the disclosure, (iv) a brief description of the PHI disclosed, and (v) a brief statement of the purpose of the disclosure (items i-v, collectively, the "disclosure information"). For repetitive disclosures Business Associate makes to the same person or entity (including Recipient or its Subsidiaries) for a single purpose, Business Associate may provide a) the disclosure information for the first of these repetitive disclosures, (b) the frequency, periodicity or number of these repetitive disclosures and (c) the date of the last of these repetitive disclosures. Business Associate will make this disclosure information available to Recipient or its Subsidiaries promptly upon Recipient's or its Subsidiaries' request.

2. Exceptions from Disclosure Tracking. Business Associate need not record disclosure information or otherwise account for disclosures of PHI that this Addendum or

4

---

Recipient or the relevant Subsidiary or Affiliate in writing permits or requires (i) for the purpose of Recipient's or its Subsidiaries' treatment activities, payment activities, or health care operations, (ii) to the individual who is the subject of the PHI disclosed or to that individual's personal representative; (iii) to persons involved in that individual's health care or payment for health care; (iv) for notification for disaster relief purposes, (v) for national security or intelligence purposes, (vi) to law enforcement officials or correctional institutions regarding inmates; or (vii) pursuant to an authorization; (viii) for disclosures of certain PHI made as part of a Limited Data Set; (ix) for certain incidental disclosures that may occur where reasonable safeguards have been implemented; and (x) for disclosures prior to April 14, 2003.

3. Disclosure Tracking Time Periods. Business Associate must have available for Recipient and its Subsidiaries the disclosure information required by this section for the 6 years preceding Recipient's or its Subsidiaries' request for the disclosure information (except Business Associate need have no disclosure information for disclosures occurring before April 14, 2003).

VI. Additional Business Associate Provisions

A. Reporting of Breach of Privacy Obligations. Business Associate will provide written notice to whichever of the Recipient or its Subsidiary or Affiliate for which the relevant PHI was created or from which the relevant PHI was received of any use or disclosure of PHI that is neither permitted by this Addendum nor given prior written approval by Recipient or the relevant Subsidiary or Affiliate promptly after Business Associate learns of such non-permitted use or disclosure. Business Associate's report will at least:

- (i) Identify the nature of the non-permitted use or disclosure;
- (ii) Identify the PHI used or disclosed;
- (iii) Identify who made the non-permitted use or received the non-permitted disclosure;
- (iv) Identify what corrective action Business Associate took or will take to prevent further non-permitted uses or disclosures;
- (v) Identify what Business Associate did or will do to mitigate any deleterious effect of the non-permitted use or disclosure; and
- (vi) Provide such other information, including a written report, as Recipient or the relevant Subsidiary or Affiliate may reasonably request.

B. Amendment. Upon the effective date of any final regulation or amendment to final regulations promulgated by the U.S. Department of Health and Human Services with respect to PHI, including, but not limited to the HIPAA privacy and security regulations, this Addendum and the Agreement will automatically be amended so that the obligations they impose on Business Associate remain in compliance with these regulations.

5

---

In addition, to the extent that new state or federal law requires changes to Business Associate's obligations under this Addendum, this Addendum shall automatically be amended to include such additional obligations, upon notice by Recipient or its Subsidiaries to Business Associate of such obligations. Business Associate's continued performance of services under the Agreement shall be deemed acceptance of these additional obligations.

C. Audit and Review of Policies and Procedures. Business Associate agrees to provide, upon Recipient request, access to and copies of any policies and procedures developed or utilized by Business Associate regarding the protection of PHI. Business Associate agrees to provide, upon Recipient's request, access to Business Associate's internal practices, books, and records, as they relate to Business Associate's services, duties and obligations set forth in this Addendum and the Agreement(s) under which Business Associate provides services and / or products to or on behalf of Recipient or its Subsidiaries, for purposes of Recipient's or its Subsidiaries' review of such internal practices, books, and records.

6

---

## DERIVATIVES MANAGEMENT SERVICES AGREEMENT

AMONG

UNION FIDELITY LIFE INSURANCE COMPANY

AND

GE ASSET MANAGEMENT INCORPORATED

AND

GENERAL ELECTRIC CAPITAL CORPORATION

DATED AS OF APRIL 15, 2004

---

**THIS DERIVATIVES MANAGEMENT SERVICES AGREEMENT** (the "Agreement") is made and entered into as of the 15th day of April, 2004 (the "Effective Date"), by and among UNION FIDELITY LIFE INSURANCE COMPANY, an insurance company domiciled in the State of Illinois ("UFLIC"), GE ASSET MANAGEMENT INCORPORATED, a Delaware corporation ("GEAM") and GENERAL ELECTRIC CAPITAL CORPORATION, a Delaware corporation ("GECC").

**RECITALS**

WHEREAS, UFLIC, GEAM and GECC are all subsidiaries of General Electric Company; and

WHEREAS, the UFLIC, from time to time, desires to hedge certain risks, including but not limited to interest rate risk, associated with its assets through the use of instruments commonly referred to as derivatives; and

WHEREAS, resolutions adopted by the GECC Board and related policy statements require that GECC's Treasury Operation ("GECC Treasury") executes, manages and administers all derivative transactions on behalf of GECC and its subsidiaries; and

WHEREAS, effective May 1, 2002, UFLIC entered into an Investment Management and Services Agreement with GEAM; and

WHEREAS, GECC Treasury may from time to time, at the request of GEAM, appoint certain individuals at GEAM as representatives of GECC Treasury with limited authority to execute, manage and administer certain derivative transactions on behalf of UFLIC; and

WHEREAS, UFLIC will enter into ISDA Master Agreements together with related schedules and confirmations (the "Contracts") with various unaffiliated counterparties (individually, a "Counterparty" and collectively, the "Counterparties"); and

WHEREAS, UFLIC, GECC and GEAM desire to enter into this Agreement to set forth the services that each of GECC and GEAM will provide to UFLIC in connection with the Contracts;

**NOW, THEREFORE**, in consideration of the premises and mutual covenants contained herein, UFLIC, GECC and GEAM hereby agree as follows:

---

**ARTICLE I  
DEFINITIONS AND USAGE**

**1.1 Definitions.** The following capitalized terms, as used in this Agreement, have the following meanings:

"Affiliate" of a Person means a Person who, directly or indirectly through one or more intermediaries, controls or is controlled by, or is under common control with, such Person.

"Applicable Law" or "Applicable Laws" means any domestic or foreign federal, state or local statute, law, ordinance or code, including the Illinois insurance code, or any rules, regulations, administrative interpretations or orders issued by any Governmental Authority, including any Insurance Authority, pursuant to any of the foregoing, and any order, writ, injunction, directive, judgment or decree of a court of competent jurisdiction applicable to the parties hereto.

"Board" means the Board of Directors of UFLIC as the same may be elected from time to time by the shareholders of UFLIC.

"Contracts" shall have the meaning set forth in the recitals to this Agreement.

"Effective Date" shall have the meaning set forth in the introductory paragraph.

"GAAP" means generally accepted accounting principles in effect, from time to time, in the United States.

"Governmental Authority" means any Insurance Authority or any court, tribunal, arbitrator, authority, agency, commission, official or other instrumentality of the United States or any federal, national, state, municipal, county, city or other political subdivision.

"Insurance Authority" means the department, bureau, commission or other agency responsible for overseeing insurance matters within any state that UFLIC is authorized to do business (as applicable to UFLIC).

"Investment Committee" means a committee designated by UFLIC's Board to oversee UFLIC's investment activities, including the execution and

management of derivative transactions.

“Investment Guidelines” shall mean the resolutions pertaining to derivatives transactions adopted by the Board of UFLIC.

“Person” means an individual, corporation, partnership, limited liability company, association, trust or any other entity or organization, including governmental or political subdivision or an agency or instrumentality thereof.

2

---

“Records” shall have the meaning set forth in Section 2.5.

“Representatives” means, as applicable, UFLIC’s directors, officers, employees, accountants and legal and financial advisors.

“Representer” shall have the meaning set forth in Section 6.2.

“SAP” means statutory accounting procedures and principles prescribed or permitted by Applicable Law.

- 1.2 Headings; Rules of Construction.** The headings contained in this Agreement are for reference purposes only and shall not affect the meaning or interpretation of this Agreement. Except as otherwise expressly provided in this Agreement, the following rules of interpretation apply to this Agreement: (i) the singular includes the plural and the plural includes the singular; (ii) “or” and “any” are not exclusive and “include” and “including” are not limiting; (iii) a reference to any agreement or other contract includes permitted supplements and amendments; (iv) a reference to a law includes any amendment or modification to such law and any rules or regulations issued thereunder; (v) a reference to a person includes its successors and permitted assigns; and (vi) a reference in this Agreement to an article, section, annex, exhibit or schedule is to the article, section, annex, exhibit or schedule of this Agreement.

## ARTICLE II SERVICES

- 2.1 Execution and Management.** Subject to the provisions of this Section 2.1, GECC Treasury will establish and confirm the terms of derivative transactions from time to time in the name of UFLIC and shall execute and deliver or otherwise enter into from time to time one or more derivatives confirmations or agreements evidencing such derivative transactions on behalf of and in the name of UFLIC as requested by UFLIC. In its performance of the foregoing obligations, GECC Treasury may appoint, from time to time at the request of GEAM, certain employees of GEAM as representatives of GECC Treasury with authority to execute, manage and administer certain derivative transactions on behalf of UFLIC in accordance with the terms of such appointment; provided, however, that such appointment shall be in writing and any action taken by any such GEAM employee shall be in accordance with GECC’s policies with respect to derivatives transactions as in effect from time to time.
- 2.2 Credit Support.** With respect to each Contract, GECC or one of its affiliates may provide a guaranty in favor of the Counterparty to such Contract.
- 2.3 Administrative Services.** With respect to the Contracts, GECC will provide certain administrative services, including without limitation certain legal services and paying agent services, on behalf of UFLIC, as set forth in the Administrative Services Agreement

3

---

(in the form attached as Exhibit A hereto), dated as of the date hereof, between GECC and UFLIC. In its performance of the foregoing obligations, GECC may appoint, from time to time, certain employees of GEAM as representatives of GECC Treasury with authority to execute, manage and administer certain derivative transactions on behalf of UFLIC in accordance with the terms of such appointment; provided, however, that any such appointment shall be in writing and any action taken by any such GEAM employee shall be in accordance with GECC’s policies with respect to derivatives transactions as in effect from time to time.

**2.4 Covenants of GECC and GEAM.**

- (a) Each of GECC and GEAM shall discharge its duties with the care, skill, prudence and diligence under the circumstances then prevailing that a prudent person, acting in a like capacity and familiar with such matters should use in the conduct of an enterprise of a like character and with like aims. Further, each of GECC and GEAM shall use the same skill and care in the management of UFLIC’s derivative transactions and in its other duties hereunder as it uses in the administration of other similar matters for which it has comparable responsibility.
- (b) In the performance of its duties and obligations to UFLIC under this Agreement, each of GECC and GEAM shall act in conformity with (i) the Articles of Incorporation and Bylaws of UFLIC, (ii) UFLIC’s Investment Guidelines or other written instructions of UFLIC’s Board, (iii) UFLIC’s Investment Committee or Representatives of UFLIC, as applicable, (iv) GECC’s policies, including with respect to derivatives transactions, as in effect from time to time, and (v) all Applicable Laws.

**2.5 Recordkeeping and Reports; Review and Inspection.**

- (a) GECC and GEAM shall, unless otherwise agreed with UFLIC, maintain all records, memoranda, instructions or authorizations (collectively, “Records”) relating to the execution, management and administration of derivative transactions on behalf of UFLIC as required by Applicable Laws, GAAP or SAP. Such Records will be the property of UFLIC. On a timely basis, GECC and GEAM shall make available to UFLIC, at its administrative offices or such other location as may be designated by UFLIC, copies or originals of such Records upon reasonable request and, as necessary, to comply with Applicable Laws.
- (b) All Records, both internal and external with third parties, to the extent within the control of GECC and GEAM, will clearly specify the ownership interest of UFLIC with respect to the relevant derivative transactions.
- (c) Records concerning derivative transactions executed or managed on behalf of UFLIC that are not maintained physically on UFLIC’s premises or UFLIC’s care, custody and control shall be subject to review and audit at any time by UFLIC, its

4

---

Representatives, any Insurance Authority and any other Governmental Authority, or any other entity designated by UFLIC, and GECC and GEAM shall cooperate with and provide reasonable assistance to any such person, including any auditor appointed by UFLIC to conduct an audit of or for UFLIC. Such Records shall be maintained for the time periods and in a format required by Applicable Law. GECC and GEAM shall notify UFLIC prior to destruction of UFLIC’s Records (in order that UFLIC may request transfer of such Records to UFLIC as an alternative to destruction); provided that GECC and GEAM



may not, in any event, destroy such Records prior to expiration of all applicable statutes of limitation.

- (d) GECC and GEAM shall provide to UFLIC such other documents and information pertaining to this Agreement and the derivative transactions executed or managed on behalf of UFLIC at such times as UFLIC may reasonably request including, but not limited to, information required to prepare reports to any Insurance Authority or any other entity designated by UFLIC or as may be required to comply with GAAP, SAP or Applicable Law.
- (e) GECC and GEAM will fully cooperate with UFLIC with respect to unsettled or unreconciled transactions and daily transmission of trading activity.

**2.6** **Information Furnished to GECC or GEAM.** UFLIC shall furnish to GECC or GEAM in a timely manner any information that GECC or GEAM may reasonably request with respect to the services performed under this Agreement for UFLIC. In determining the requirements of Applicable Laws with respect to UFLIC, GECC and GEAM may rely on an interpretation of law by legal counsel to UFLIC. In determining the requirements of applicable accounting rules with respect to UFLIC, GECC and GEAM may rely on an interpretation of such rules by accountants for UFLIC.

### ARTICLE III TERM AND TERMINATION

**3.1** This Agreement shall continue in effect for an initial term beginning on the Effective Date and ending December 31, 2004. Unless earlier terminated, this Agreement shall automatically renew on January 1, 2005 and on each January 1 thereafter for successive periods of one (1) year. This Agreement may be terminated (i) at any time during the initial term or any renewal term by GECC or UFLIC without payment of any penalty upon sixty (60) days prior written notice to the other parties (which notice shall specify the effective date of termination), and (ii) immediately for cause by UFLIC (cause being understood as any material breach, action or omission by GECC or GEAM that, in the reasonable belief of UFLIC, is inconsistent with the terms of this Agreement). This Agreement also shall automatically terminate in the event of its unauthorized assignment by any party or if any party ceases to be a majority-owned direct or indirect subsidiary of General Electric Company. Termination in any manner shall not affect the rights of any party, including the status of any guarantees issued pursuant to Section 2.2 of this Agreement that accrued prior to termination.

5

---

**3.2** Within sixty (60) days of the termination of this Agreement, GECC and GEAM shall transfer all Records of UFLIC to UFLIC or its designee. All reasonable costs to transfer UFLIC's Records shall be paid by UFLIC.

### ARTICLE IV COMPENSATION

Each of GEAM and GECC agree that if services are performed under this agreement, the parties will determine appropriate compensation at the time the services are rendered, provided, that such compensation shall be fair and reasonable. Such agreement, however, shall not extend to reimbursement of losses, damages and other expenses contemplated under Section 7.2 and for reimbursement of all reasonable out-of-pocket costs and expenses incurred on behalf of UFLIC.

### ARTICLE V CONFIDENTIALITY

Subject to the duty of GECC, GEAM or UFLIC to comply with Applicable Laws, each party hereto shall treat as confidential all information with respect to any other party received pursuant to this Agreement. No party shall use or disclose another party's confidential information except as contemplated by this Agreement or except as required by Applicable Law.

### ARTICLE VI REPRESENTATIONS AND WARRANTIES

**6.1** **By UFLIC.** UFLIC represents and warrants that:

- (a) It is an insurance company duly organized, validly existing and in good standing under the laws of its state of incorporation and has the power and authority (including approval from the relevant Insurance Authority, if required) to execute, deliver and perform this Agreement; and
- (b) This Agreement is the valid and binding obligation of UFLIC enforceable against it in accordance with its terms, except as enforceability may be limited by bankruptcy, insolvency, moratorium or other similar laws affecting creditors' rights generally or by the principles governing the availability of equitable remedies.

**6.2** **By GECC and GEAM.** Each of GECC and GEAM (each a "Representer") represents and warrants with respect only to itself that:

- (a) It is a corporation duly organized, validly existing and in good standing under the laws of Delaware, has the power and authority to execute, deliver and perform this Agreement;

6

---

- (b) This Agreement is the valid and binding obligation of the Representer enforceable against it in accordance with its terms, except as enforceability may be limited by bankruptcy, insolvency, moratorium or other similar laws affecting creditors' rights generally or by the principles governing the availability of equitable remedies; and
- (c) Neither the execution and delivery nor the performance of this Agreement by the Representer will violate any law, statute, order, rule or regulation or judgment, order or decree by any federal, state, local or foreign court or governmental authority, domestic or foreign, to which the Representer is subject nor will the same constitute a breach of, or default under, provisions of any agreement or contract to which it is a party or by which it is bound.

### ARTICLE VII MISCELLANEOUS

**7.1** **Limitation of Liability.** In furnishing UFLIC with services as provided herein, none of GECC or GEAM nor any officer, director or agent thereof shall be held liable to UFLIC, its creditors or the holders of its securities for good faith errors of judgment or for anything except willful misfeasance, bad faith or negligence in the performance of its duties, or reckless disregard of its obligations and duties under the terms of this Agreement. It is further understood and agreed that GECC and GEAM may rely upon information furnished to it by UFLIC that GECC or GEAM (as applicable) reasonably believes to be accurate and reliable. Certain federal laws, including federal securities laws, impose liabilities under certain circumstances on persons who act in good faith and therefore nothing contained herein shall in any way constitute a waiver or limitation of any rights that UFLIC may have under any such federal laws.

**7.2 Indemnification.**

- (a) Notwithstanding any limitation of liability contained in Section 7.1, GECC and GEAM shall indemnify and hold UFLIC harmless from and against any losses, damages, expenses (including reasonable attorneys' fees), liabilities, penalties, demands and claims of any nature whatsoever with respect to or arising out of the breach or violation by GECC or GEAM of any agreement, covenant, representation or warranty made by GECC or GEAM herein.
- (b) UFLIC shall indemnify and hold GECC or GEAM harmless from and against any losses, damages, expenses (including reasonable attorneys' fees), liabilities, penalties, demands and claims of any nature whatsoever with respect to or arising out UFLIC's breach or violation of any agreement, covenant, representation or warranty made by UFLIC herein.

**7.3 Assignment.** No assignment (by operation of law or otherwise) of this Agreement, in whole or in part, nor any of the rights, interests or obligations under this Agreement by

7

---

any party shall be effective without the prior written consent of the other parties and any necessary approvals from the relevant Insurance Authority. Subject to the provisions of this Section 7.3, this Agreement shall be binding upon, inure to the benefit of, and be enforceable by the parties and their respective successors and permitted assigns.

**7.4 Independent Contractor.** GEAM and GECC shall be deemed to be independent contractors and, except as expressly provided or authorized in this Agreement, shall have no authority to act for or represent UFLIC. UFLIC shall always retain the ultimate authority to make decisions regarding the execution or management of derivative transactions on its own behalf.

**7.5 Right to Contract with Third Parties.** Nothing herein shall be deemed to grant to GEAM or GECC an exclusive right to provide the services described herein to UFLIC, and UFLIC retains the right to contract with any third party, affiliated or unaffiliated, for the performance of services or for the use of facilities as are available to or have been requested by UFLIC pursuant to this Agreement; provided, however, GECC Treasury shall execute all derivatives transactions of any subsidiary with respect to which GECC has direct or indirect voting control in accordance with the GECC Derivatives Policy.

**7.6 Governing Law.** This Agreement shall be governed by the laws of the State of Illinois, without giving effect to its conflict of laws principles.

**7.7 Notices.** Any notice under this Agreement shall be given in writing, addressed, and delivered by hand or facsimile, or mailed postpaid by U.S. Mail or overnight courier service, to the party to this Agreement entitled to receive such notice, at such party's principal place of business as set out here:

If to GECC:

Associate General Counsel  
General Electric Capital Corporation  
201 High Ridge Road  
Stamford, Connecticut 06927-9400  
Facsimile: (203) 357-3490

8

---

If to GEAM:

General Counsel  
GE Asset Management Incorporated  
3003 Summer Street, P.O. Box 7900  
Stamford, Connecticut 06904-7900  
Facsimile: (203) 326-4177

If to UFLIC:

General Counsel  
Union Fidelity Life Insurance Company  
200 North Martingale Road  
Schaumburg, IL 60173  
Facsimile: (847) 605-3044

or to such other address as each party may designate in writing mailed to the other parties. Unless otherwise permitted by the terms hereof, whenever any notice is required to be given hereunder, such notice shall be deemed given and such requirement satisfied only when such notice is delivered by hand, or, if delivered by facsimile, overnight courier or mail, when received.

**7.8 Severability.** Any provision of this Agreement which is prohibited or unenforceable in any jurisdiction shall, as to such jurisdiction, be ineffective to the extent of such prohibition or unenforceability without invalidating the remaining provisions hereof, and any such prohibition or unenforceability in any jurisdiction shall not invalidate or render unenforceable such provision in any other jurisdiction.

**7.9 Amendments.** No term or provision of this Agreement may be modified, amended, waived, discharged or terminated except by an agreement in writing, executed by each of the parties hereto; provided that any material amendment shall be subject to the approval, if required, of the relevant Insurance Authority.

**7.10 Entire Agreement.** This Agreement supersedes any and all oral or written agreements or understandings heretofore made, and contains the entire agreement of the parties, with respect to the subject matter hereof.

**7.11 Counterparts.** This Agreement may be executed in one or more counterparts, and such counterparts together shall constitute one and the same agreement.

[THE REST OF THIS PAGE IS LEFT BLANK INTENTIONALLY]

9

---

IN WITNESS WHEREOF, the parties hereto have caused this instrument to be duly executed by their respective officers thereunto duly authorized as of the day and year first above written.

GENERAL ELECTRIC CAPITAL CORPORATION

By: /s/ JAMES A. PARKE

Name: James A. Parke

Title: Vice Chairman and Chief Financial Officer

GE ASSET MANAGEMENT INCORPORATED

By: /s/ ALAN M. LEWIS

Name: Alan M. Lewis

Title: Executive Vice President - General Counsel and Secretary

UNION FIDELITY LIFE INSURANCE COMPANY

By: /s/ GLENN JOPPA

Name: Glenn Joppa

Title: Senior Vice President and Secretary

---

[ ] 2004

**TRANSITIONAL SERVICES AGREEMENT**

between

**FINANCIAL INSURANCE GROUP SERVICES LIMITED**

and

**GE LIFE SERVICES LIMITED**

**WEIL, GOTSHAL & MANGES**

One South Place London EC2M 2WG  
Tel: +44 (0) 20 7903 1000 Fax: +44 (0) 20 7903 0990  
www.weil.com

---

**TABLE OF CONTENTS**

<a href="#">1</a>	<a href="#">INTERPRETATION</a>
<a href="#">2</a>	<a href="#">THE SERVICES</a>
<a href="#">3</a>	<a href="#">CONVERSION SERVICES</a>
<a href="#">4</a>	<a href="#">OTHER ARRANGEMENTS/ADDITIONAL AGREEMENTS/CONSENTS</a>
<a href="#">5</a>	<a href="#">THE PROVIDER'S RESPONSIBILITIES</a>
<a href="#">6</a>	<a href="#">CHARGES</a>
<a href="#">7</a>	<a href="#">TERMS OF PAYMENT</a>
<a href="#">8</a>	<a href="#">COMPLIANCE WITH LAWS AND STANDARD FOR SERVICES</a>
<a href="#">9</a>	<a href="#">WARRANTIES</a>
<a href="#">10</a>	<a href="#">CONTRAT DE GROUPEMENT DE FAIT</a>
<a href="#">11</a>	<a href="#">RECORDS AND AUDIT</a>
<a href="#">12</a>	<a href="#">INTELLECTUAL PROPERTY</a>
<a href="#">13</a>	<a href="#">LIMITATION OF LIABILITY AND INDEMNITIES</a>
<a href="#">14</a>	<a href="#">CONDUCT OF CLAIMS</a>
<a href="#">15</a>	<a href="#">ASSIGNMENT AND SUB-CONTRACTING</a>
<a href="#">16</a>	<a href="#">CONFIDENTIALITY</a>
<a href="#">17</a>	<a href="#">TERMINATION</a>
<a href="#">18</a>	<a href="#">THE PROVIDER'S OBLIGATIONS ON TERMINATION</a>
<a href="#">19</a>	<a href="#">SURVIVAL OF OBLIGATIONS ON TERMINATION</a>
<a href="#">20</a>	<a href="#">FORCE MAJEURE/BUSINESS CONTINUITY</a>
<a href="#">21</a>	<a href="#">INCONSISTENCY/PREVAILING AGREEMENT</a>
<a href="#">22</a>	<a href="#">MASTER AGREEMENT</a>
<a href="#">23</a>	<a href="#">REGULATORY APPROVAL AND COMPLIANCE</a>
<a href="#">24</a>	<a href="#">SEVERABILITY</a>
<a href="#">25</a>	<a href="#">APPLICABLE LAW AND DISPUTE RESOLUTION</a>
<a href="#">26</a>	<a href="#">DATA PROTECTION</a>
<a href="#">27</a>	<a href="#">FURTHER ASSURANCE</a>
<a href="#">28</a>	<a href="#">WAIVER OF REMEDIES</a>
<a href="#">29</a>	<a href="#">NOTICES</a>
<a href="#">30</a>	<a href="#">NO PARTNERSHIP</a>
<a href="#">31</a>	<a href="#">ENTIRE AGREEMENT</a>
<a href="#">32</a>	<a href="#">RIGHTS OF THIRD PARTIES</a>
<a href="#">33</a>	<a href="#">COUNTERPARTS</a>
	<a href="#">SCHEDULE I SERVICES</a>

---

**THIS AGREEMENT** is made on [ ] 2004 between the following parties:

- (1) FINANCIAL INSURANCE GROUP SERVICES LIMITED**, a company incorporated in England and Wales (registered number 1670707) whose registered office is at Vantage West, Great West Road, Brentford, Middlesex, TW8 9AG (“**FIGSL**”); and
- (2) GE LIFE SERVICES LIMITED**, a company incorporated in England and Wales (registered number 4330120) whose registered office is at The Priory, Hitchin, Hertfordshire, SG5 2DW (“**GELS**”).

**WHEREAS:**

- (A) General Electric Company (“GE”), General Electric Capital Corporation, GEI, Inc., GE Financial Assurance Holdings, Inc. (“GEFAHI”) and Genworth Financial, Inc. (“Genworth”) have entered into a Master Agreement of even date (the “**Master Agreement**”).
- (B) In connection with the Master Agreement, GE, General Electric Capital Corporation, GEI, Inc., GEFAHI, GNA Corporation, GE Asset Management Incorporated, General Electric Mortgage Holdings LLC and Genworth have entered into a Transition Services Agreement of even date (the “**Global Transition Services Agreement**”) pursuant to which (i) GE and its subsidiaries will provide or cause to be provided certain administrative and support services and other assistance to Genworth together with its subsidiaries, including GNA Corporation, on a transitional basis and (ii) Genworth and its subsidiaries will provide or cause to be provided certain administrative and support services and other assistance to GE together with its subsidiaries, including General Electric Capital Corporation, GEFAHI and GE Asset Management Incorporated, on a transitional basis.
- (C) Further to and in connection with the Global Transition Services Agreement the parties hereto are to provide transitional administrative and support services to each other and its group companies on a reciprocal basis on the terms and conditions of this Agreement.
- (D) Certain FIGSL Group Companies and GEIH Group Companies (both as defined below) which are incorporated in France are parties to a Contrat de Groupement de Fait dated 20 November 1998 (the “**Contrat de Groupement de Fait**”) pursuant to which they enjoy certain tax benefits. The parties to the Contrat de Groupement de Fait desire that, so far as is possible, such tax benefits shall continue to apply and that equivalent tax benefits be obtained in respect of the Services to be provided as between the parties to the Contrat Groupement de Fait pursuant to this Agreement, subject to the terms and conditions of this Agreement.

IT IS AGREED as follows:

## 1 INTERPRETATION

- 1.1 As used herein, the following terms shall have the following meanings, unless the context otherwise requires:

1

---

“**Affiliate**” means in respect of any person, any direct or indirect subsidiary of such person and any other person that directly, or through one or more intermediaries, controls or is controlled by or is under common control with such first person;

“**Agreement**” means this agreement, including the Clauses and the Schedule and all other written schedules, annexes, attachments and amendments which are signed in writing by all parties and which are made a part hereof in accordance with this Agreement;

“**Closing Date**” means the date on which the underwriting agreements between Genworth, GEFAHI and the managing underwriters in connection with the initial public offering of common stock by GEFAHI of Genworth Common Stock and the registered public offerings by GEFAHI of Genworth Series A Preferred Stock and Genworth Equity Units are executed;

“**Commencement Date**” means the Closing Date save in respect of the French Services where it shall mean the French Scheme Transfer Date;

“**Consents**” shall have the meaning given to it in Clause 4.5;

“**Consents Costs**” shall have the meaning given to it in Clause 4.5;

“**Continuing Agreement**” means any agreement, arrangement, commitment or understanding that survives the Closing Date pursuant to Section 2.4(b) of the Master Agreement;

“**Control**” or “**Controlled**” means, with respect to any Intellectual Property, the right to grant a license or sublicense to such Intellectual Property as provided for herein without (i) violating the terms of any agreement or other arrangement with any third party, (ii) requiring any consent, approvals or waivers from any third party, or any breach or default by the party being granted any such license or sublicense being deemed a breach or default affecting the rights of the party granting such license or sublicense or (iii) requiring the payment of material compensation to any third party;

“**Conversion Costs**” shall have the meaning given to it in Clause 3.3;

“**Cross License**” means the Intellectual Property Cross License of even date between GE and Genworth;

“**European Tax Matters Agreement**” means the European Tax Matters Agreement of even date between, *inter alia*, GE, Consolidated Insurance Holdings Limited, UK Group Holding Company Limited and Genworth;

“**FACL**” means Financial Assurance Company Limited (registered number 1044679);

“**FIGSL Group**” means (i) FIGSL, CFI Administrators Limited, CFI Pension Trustees Limited, Ennington Properties Limited, FIG Ireland Limited, Financial Insurance Guernsey PCC Limited, Financial New Life Company Limited, GEFA UK Finance Limited, GEFA UK Holdings Limited, Assocred S.A., RD Plus S.A. and UK Group Holding Company Limited, (ii) with effect from the UK Transfer Date, Financial Insurance Company Limited, Consolidated Insurance Group Limited, GE Financial Assurance, Compania de Seguros y Reaseguros de Vida S.A. and GE

2

---

Financial Insurance, Compania de Seguros y Reaseguros S.A., (iii) with effect from the date (if ever) that all the shares in FACL are transferred to GEFA UK Holdings Limited, FACL, and (iv) any other company that the parties shall agree from time to time shall be included within this definition;

“**French Services**” means those GEIH Services set out in Part A of Schedule 1 to be provided to RD Plus S.A. and Assocred S.A. and those FIGSL Services set out in Part B of Schedule 1 to be provided to Vie Plus S.A. and SCI Laborde, in each case following the French Scheme Transfer Date;

“**French Scheme Transfer Date**” means the date on which the Minister of the Economy, Finance and Industry for France grants an order approving the transfer of Vie Plus S.A.’s payment protection insurance business to Financial New Life Company Limited pursuant to the provisions of Article L.324-1 of the Insurance Code;

“**FSA**” means the United Kingdom’s Financial Services Authority or its successors;

“**GEIH**” means GE Insurance Holdings Limited (registered number 2221244);

“**GEIH Group**” means (i) GELS, GEIH, Consolidated Insurance Holdings Limited, GE Asset Management Limited, GE Financial Asset Management Limited, GE Life Equity Release Limited, GE Life Fund Management Limited, GE Life Group Limited, GE Life Limited, GE Life Residential Limited, GE Life Trustees Limited, GE Pensions Limited, GE Pensions Trustees Limited, Namulas Pension Trustees Limited, National Mutual Life Assurance Society, National Mutual Pension Trustees Limited, Vie Plus S.A., SCI Laborde and Three X Communication Limited, (ii) until the UK Transfer Date, Financial Insurance Company Limited, Consolidated Insurance Group Limited, GE Financial Assurance, Compania de Seguros y Reaseguros de Vida S.A. and GE Financial Insurance, Compania de Seguros y Reaseguros S.A., (iii) until such time (if ever) as all the shares in FACL are transferred to GEFA UK Holdings Limited, FACL, and (iv) any other company that the parties shall agree from time to time shall be included within this definition;

“**Goods**” means any goods or materials which are supplied by a Provider;

“**Group**” means, in relation to any party, its Group as defined hereunder;

“**Group Companies**” means in relation to any party, any member of that party’s Group and “**Group Company**” means any such company;

“**Improvement**” means any modification, derivative work or improvement of any Technology;

“**Information Systems**” means computing, telecommunications or other digital operating or processing systems or environments, including, without limitation, computer programs, data, databases, computers, computer libraries, communications equipment, networks and systems. When referenced in connection with Services, Information Systems shall mean the Information Systems accessed and/or used in connection with the Services;

3

---

“**Intellectual Property**” means all of the following, whether protected, created or arising under the laws of England and Wales or any other foreign jurisdiction: (i) patents, patent applications (along with all patents issuing thereon) and statutory invention registrations, including divisions, continuations, continuations-in-part, substitute application of the foregoing and any extensions, reissues, restorations and re-examinations thereof, and all rights therein provided by international treaties or conventions, (ii) copyrights, mask work rights, design rights and database rights, whether or not registered, published or unpublished, and registrations and applications for registration thereof, and all rights therein whether provided by international treaties or conventions or otherwise, (iii) trademarks, service marks, trade dress, logos and other identifiers of source, including all goodwill associated therewith and all common law rights, registrations and applications for registration thereof, and all rights therein provided by international treaties or conventions, and all reissues, extensions and renewals of any of the foregoing, (iv) intellectual property rights arising from or in respect of domain names, domain name registrations and reservations, (v) trade secrets, (vi) intellectual property rights arising from or in respect of Technology, and (vii) all other applications and registrations related to any of the intellectual property rights set forth in the foregoing clauses (i) — (vi) above;

“**negligence**” means negligence as defined in Section 1 of the Unfair Contract Terms Act 1977 being “the breach (a) of any obligation, arising from the express or implied terms of a contract, to take reasonable care or exercise reasonable skill in the performance of the contract; (b) of any common law duty to take reasonable care or exercise reasonable skill (but not any stricter duty); or (c) of the common duty of care imposed by the Occupiers’ Liability Act 1957 or the Occupiers’ Liability Act (Northern Ireland) 1957”;

“**Provider**” means in relation to any Service, the party providing or causing the provision of such Service under this Agreement;

“**Provider’s Group**” means in relation to a Provider, its Group as defined hereunder;

“**Provider Indemnified Party**” shall have the meaning given to it in Clause 13.3;

“**Recipient**” means in relation to any Service, the party to whom such Service is being provided under this Agreement;

“**Recipient’s Group**” means in relation to a Recipient, its Group as defined hereunder;

“**Recipient Group Companies**” means in relation to a Recipient, each of its Group Companies as defined hereunder;

“**Recipient Indemnified Party**” shall have the meaning given to it in Clause 13.2;

“**Representatives**” means in relation to a person, any director, officer, employee, agent, consultant, sub-contractor, accountant, auditor, financing source, attorney, investment banker or other representative of such person;

“**Service Charges**” means in relation to any Services, the charges to be paid by the relevant Recipient to the relevant Provider pursuant to Clause 6.1 in respect of the

4

---

Services provided by the relevant Provider to the relevant Recipient and its Group. The charges for each Service or the basis for calculation thereof are set out opposite that Service in column 2 of the relevant Part of Schedule 1;

“**Service Termination Date**” means, in relation to any Service, the date set out opposite it in column 3 of Parts A and B of Schedule 1, or such earlier date as provided hereunder;

“**Services**” means the FIGSL Services or the GEIH Services (each as defined in Clause 2.1) as appropriate and “**Service**” means any individual service to be provided as part of the Services;

“**Software**” means the object and source code versions of computer programs and any associated documentation therefore.

“**Standard for Services**” shall have the meaning given to it in Clause 8;

“**subsidiary**” and “**holding company**” shall have the meanings given to them respectively in Sections 736 and 736A of the Companies Act 1985;

“**Technology**” means, collectively, all designs, formulas, algorithms, procedures, techniques, ideas, know-how, software, programs, models, routines, confidential and proprietary information, databases, tools, inventions, invention disclosures, creations, improvements, works of authorship, and all recordings, graphs, drawings, reports, analyses, other writings, and any other embodiment of the above, in any form, whether or not specifically listed herein;

“**Term**” means the term of this Agreement;

“**Total Consents Cost Amount**” shall have the meaning given to it in Clause 4.5;

“**Total Conversion Cost Amount**” shall have the meaning given to it in Clause 3.3;

“**Transfer Regulations**” means the Transfer of Undertakings (Protection of Employees) Regulations 1981;

“**Trigger Date**” means the first date after which GE no longer beneficially owns more than fifty percent (50%) of the outstanding common stock of Genworth (excluding for such purposes common stock of Genworth beneficially owned by GE but not for its own account, including (in such exclusion) beneficial ownership which arises by virtue of some entity that is an Affiliate of GE being a sponsor of or advisor to of a mutual or similar fund that beneficially owns common stock of Genworth. For the avoidance of doubt, a member of the Genworth group is not an Affiliate of GE);

“**UK Scheme**” means the Scheme for the transfer of the insurance business of FACL to Financial New Life Company Limited pursuant to Part VII of the Financial Services and Markets Act 2000;

“**UK Transfer Date**” means the earlier of (i) the date on which the UK Scheme becomes effective in accordance with its terms or (ii) the date on which all of the shares of FACL are transferred to GEFA UK Holdings Limited; and

5

---

“**Virus**” means any computer instructions (i) that adversely affect the operation, security or integrity of a computing telecommunications or other digital operating or processing system or environment, including without limitation, other programs, data, databases, computer libraries and computer and communications equipment, by altering, destroying, disrupting or inhibiting such operation, security or integrity; (ii) that without functional purpose, self-replicate without manual intervention; or (iii) that purport to perform a useful function but which actually perform either a destructive or harmful function, or perform no useful function and utilize substantial computer, telecommunications or memory resources.

- 1.2 As used herein unless the context otherwise requires the singular includes the plural and vice versa and words importing the masculine gender shall include the feminine.
- 1.3 References in this Agreement to any enactment, order, regulation or other similar instrument shall be construed as a reference to the enactment, order, regulation or instrument as amended by any subsequent enactment, order, regulation or instrument or as contained in any subsequent re-enactment thereof.
- 1.4 References in this Agreement to a party shall be construed as a reference to that party, its successors and permitted assigns.
- 1.5 The Schedules form part of this Agreement.
- 1.6 The headings in this Agreement are for the convenience of the parties only and are in no way intended to affect, describe, interpret, define or limit the scope, extent, intent or interpretation of this Agreement or any provision of this Agreement.
- 1.7 References in this Agreement to Clauses and the Schedule are to the clauses and schedule of this Agreement. In the event of any conflict or inconsistency between any provision of the Clauses and any provision of the Schedule, the former shall prevail, but only to the extent of the conflict or inconsistency. These terms and conditions shall prevail over any terms and conditions of the Providers now or in the future.

## 2 THE SERVICES

- 2.1 From the Commencement Date until the relevant Service Termination Date:
  - 2.1.1 GELS shall provide, or cause to be provided, the services listed in Schedule 1, Part A to the FIGSL Group (together with any additional services to be provided to the FIGSL Group pursuant to Clause 2.8 and any GEIH Substitute Services, the “**GEIH Services**”); and
  - 2.1.2 FIGSL shall provide, or cause to be provided, the services listed in Schedule 1, Part B to the GEIH Group (together with any additional services to be provided to the GEIH Group pursuant to Clause 2.8 and any FIGSL Substitute Services, the “**FIGSL Services**”).
- 2.2 The scope of each Service shall be substantially the same as the scope of such service provided by the Provider, or, if applicable, its predecessor, prior to the date hereof. The use of each Service by a Recipient Group Company shall include use by the Recipient Group Company’s contractors in substantially the same manner as used by

6

---

the contractors of that Recipient Group Company or its predecessor, if applicable, prior to the Closing Date. Save as provided in Clause 15 (*Assignment and Sub-contracting*), nothing in this Agreement shall require that any Service be provided other than for use in, or in connection with, the Recipient’s business and the Recipient Group Companies’ businesses. For the avoidance of doubt, nothing in this Clause 2.2 or in this Agreement shall be deemed to restrict or otherwise limit the volume or quantity of any Service, provided that certain changes in a Recipient’s requirements for the volume or quantity of a Service may require the parties to negotiate in good faith and use their commercially reasonable efforts to agree upon a price adjustment to the Service Charges for such Service pursuant to Clause 15.3.

- 2.3 If for any reason FIGSL is unable to provide any FIGSL Service to the GEIH Group pursuant to the terms of this Agreement, FIGSL shall provide to the GEIH Group a substantially equivalent service (a “**FIGSL Substitute Service**”) for not more than the Service Charge for the substituted FIGSL Service set forth in Schedule 1, Part B and otherwise in accordance with the terms of this Agreement, including the Standard for Services.
- 2.4 If for any reason GELS is unable to provide any GEIH Service to the FIGSL Group pursuant to the terms of this Agreement, GELS shall provide to the FIGSL Group a substantially equivalent service (a “**GEIH Substitute Service**”) for not more than the Service Charge for the substituted GEIH Service set forth in Schedule 1, Part A and otherwise in accordance with the terms of this Agreement, including the Standard for Services.
- 2.5 The Services shall include:
  - 2.5.1 such maintenance, support, error correction, training, updates and enhancements normally and customarily provided by the Provider to its Group Companies that receive such services; and
  - 2.5.2 all functions, responsibilities, activities and tasks, and the materials, documentation, resources, rights and licenses to be used, granted or provided by the Provider that are not specifically described in this Agreement as a part of the Services, but are incidental to, and would normally be considered an inherent part of, or necessary subpart included within, the Services or are otherwise necessary for the Provider to provide, or the Recipient or the Recipient Group Companies to receive, the Services.
- 2.6 In addition, a Recipient may request that the Provider provides a custom modification to any Service. For the avoidance of doubt, to the extent any custom

modification constitutes Software and such Software and all the Intellectual Property therein is owned by the Provider, the Provider hereby assigns or agrees to cause the assignment of such Software and all Intellectual Property therein to the relevant Recipient Group Company and the Recipient hereby grants the Provider or agrees to cause the grant to the Provider of a perpetual, worldwide, fully paid up, irrevocable, transferable, royalty-free, non-exclusive licence, with the right to sub-licence, to use and modify such Software.

2.7 This Agreement shall not assign any rights to Technology or Intellectual Property between the parties other than as specifically set forth herein.

7

2.8 If from time to time during the Term any party identifies a need for additional services to be provided by or on behalf of a Provider, the parties hereto agree to negotiate in good faith to provide such requested services (provided that such services are of a type generally provided by the relevant Provider at such time) and the applicable Service Charges, Service Termination Date and other rights and obligations with respect thereto. To the extent practicable, such additional services shall be provided on terms substantially similar to those applicable to Services of similar types and in all other respects be provided on terms consistent with those contained in this Agreement.

2.9 Each party will, promptly following the date of this Agreement, designate a services account manager (the "Services Manager") who will be directly responsible for coordinating and managing the delivery of the Services and will have authority to act on that party's behalf with respect to matters relating to this Agreement. The Services Managers will work with each other to address any problems arising in connection with the Services and manage the parties' relationship under this Agreement.

2.10 The following provisions shall apply to the Services:

2.10.1 the Provider and Recipient shall comply and where appropriate shall cause their Group Companies to comply with their own security guidelines as in force from time to time which are applicable to the performance, access and/or use of the Services and the Information Systems;

2.10.2 the parties hereto shall take commercially reasonable measures to ensure that no Viruses or similar items are coded or introduced into the Services or Information Systems. If a Virus is found to have been introduced into such Services or Information Systems, the parties hereto shall use their commercially reasonable efforts to cooperate and to diligently work together to eliminate the effects of the Virus; and

2.10.3 the Provider and Recipient shall exercise and where appropriate shall cause their Group Companies to exercise reasonable care in providing, accessing and using the Services to (i) prevent access to the Services by unauthorised persons and (ii) not damage, disrupt or interrupt the Services.

2.11 Any Software delivered by a Provider hereunder shall be delivered at the election of the Provider either (i) with the assistance of the Provider, through electronic transmission or downloaded by the Recipient from the GE intranet or (ii) by installation by Provider on the relevant equipment with retention by Provider of all tangible media on which such Software resides. Provider and Recipient acknowledge and agree that no tangible medium containing such Software (including any enhancements, upgrades or updates) will be transferred to Recipient at any time for any reason under the terms of this Agreement, and that Provider will, at all times, retain possession and control of any such tangible medium used or consumed by Provider in the performance of this Agreement. Each party shall comply with all reasonable security measures implemented by the other party in connection with the delivery of Software.

8

### 3 CONVERSION SERVICES

3.1 During the Term, FIGSL shall provide or cause to be provided, in addition to the FIGSL Services, the following support for no extra charge except for actual out-of-pocket costs and expenses approved in advance in writing by the GEIH Services Manager:

3.1.1 FIGSL shall provide, or cause to be provided, current and reasonably available historical data related to the FIGSL Services and predecessor services thereto as reasonably required by GELS, in a manner and within a time period as mutually agreed by the parties;

3.1.2 FIGSL shall make reasonably available or cause to be made reasonably available to GELS the services of those employees, contractors and consultants of the FIGSL Group whose assistance, expertise or presence is necessary to assist GELS' transition team in establishing a fully functioning stand-alone environment in respect of the GEIH Group Companies' businesses and the timely assumption by GELS, or by a supplier of GELS, of the FIGSL Services; and

3.1.3 with respect to any Software or other electronic content ("**Electronic Materials**") licensed to Genworth and its Affiliates under the Cross License and used to provide a GEIH Service, GELS shall make available or deliver to FIGSL a copy of such Software or Electronic Materials that are in existence and current as of the Service Termination Date for such GEIH Service, including any upgrades, updates and other modifications made to such Software and Electronic Materials since the Closing Date. Any upgrades, updates or other modifications to Software and Electronic Materials made available or delivered to the FIGSL Group pursuant to this Clause shall be deemed to be GE Intellectual Property under the Cross License and licensed to Genworth and its Affiliates pursuant to the terms of the Cross License, notwithstanding that such upgrades, updates or other modifications (x) were not used, held for use or contemplated to be used by Genworth and its Affiliates as of the Closing Date, (y) were not Controlled by GE and its Affiliates as of the Closing Date or (z) may constitute Improvements made after the Closing Date.

3.2 During the Term, GELS shall provide or cause to be provided, in addition to the GEIH Services, the following support for no extra charge except for actual out-of-pocket costs and expenses approved in advance in writing by the FIGSL Services Manager:

3.2.1 GELS shall provide, or cause to be provided current and reasonably available historical data related to GEIH Services and predecessor services thereto as reasonably required by FIGSL, in a manner and within a time period as mutually agreed by the parties;

3.2.2 GELS shall make reasonably available or cause to be made reasonably available to FIGSL the services of those employees, contractors and consultants of the GEIH Group whose assistance, expertise or presence is necessary to assist FIGSL's transition team in establishing a fully

9

functioning stand-alone environment in respect of the FIGSL Group Companies' businesses and the timely assumption by FIGSL, or by a supplier of FIGSL, of the GEIH Services and

3.2.3 with respect to any Software or other Electronic Materials licensed to GE and its Affiliates under the Cross License and used to provide a FIGSL Service, FIGSL shall make available or deliver to GELS a copy of such Software or Electronic Materials that are in existence and current as of the Service Termination Date for such FIGSL Service, including any upgrades, updates and other modifications made to such Software and Electronic Materials since the



Closing Date. Any upgrades, updates or other modifications to Software and Electronic Materials made available or delivered to the GEIH Group pursuant to this Clause shall be deemed to be Genworth Intellectual Property under the Cross License and licensed to GE and its Affiliates pursuant to the terms of the Cross License, notwithstanding that such upgrades, updates or other modifications (x) were not used, held for use or contemplated to be used by GE and its Affiliates as of the Closing Date, (y) were not Controlled by Genworth and its Affiliates as of the Closing Date or (z) may constitute Improvements made after the Closing Date.

- 3.3 The parties acknowledge and agree that in connection with the implementation, provision, receipt and transition of the Services, the parties will incur certain non-recurring out-of-pocket conversion costs and expenses (“**Conversion Costs**”):

3.3.1 GEIH Services Conversion Costs

Following the termination of a GEIH Service, the GEIH Group shall either reimburse FIGSL for all actual Conversion Costs incurred by FIGSL in respect of such GEIH Service or, after consultation with FIGSL, pay such Conversion Costs directly on an as incurred basis, in either case regardless of whether FIGSL replaces the GEIH Service with the same application, system, vendor or other means of effecting the GEIH Service provided however that the GEIH Group’s payment and reimbursement obligations under this Clause 3.3.1 and GE’s payment and reimbursement obligations under Section 2.01(f) of the Global Transition Services Agreement shall not in the aggregate exceed the Total Conversion Cost Amount. For the purposes of this Clause, the “**Total Conversion Cost Amount**” means US\$29.6 million, which amount represents the parties’ agreed-upon good faith estimate of (i) the anticipated Conversion Costs with respect to the transition of the GEIH Services pursuant to the terms of this Agreement and (ii) the anticipated, non-recurring, out-of-pocket conversion costs with respect to the transition of the GE Services (as such term is defined in the Global Transition Services Agreement) pursuant to the terms of the Global Transition Services Agreement.

3.3.2 FIGSL Services Conversion Costs

The GEIH Group shall be solely responsible without limitation for paying any Conversion Costs in respect of the FIGSL Services and any such

10

---

Conversion Costs or related costs shall not be included in the Total Conversion Cost Amount.

- 3.4 Prior to GELS’ payment of or reimbursement for Conversion Costs pursuant to Clause 3.3 above, FIGSL shall provide GELS with an invoice accompanied by reasonably detailed data and documentation sufficient to evidence the Conversion Costs for which FIGSL is seeking payment or reimbursement. Upon receipt of such invoice and data and documentation, GELS shall, except as otherwise provided in Clause 3.3, either pay the amount of such invoice directly in accordance with the vendors’ or suppliers’ payment terms relating to that invoice, where such terms have been previously agreed by GELS or reimburse FIGSL for its payment of the invoice within 30 days of the date of GELS’ receipt of such invoice and request for reimbursement from FIGSL. If GELS in good faith disputes the invoiced amount, then the parties shall work together to resolve such dispute. If the parties are unable to resolve such dispute within 30 days, the dispute shall be resolved pursuant to Clause 25 (*Applicable Law and Dispute Resolution*). The parties acknowledge and agree that no prior approval shall be required from the GEIH Group or GELS in order for FIGSL to seek any reimbursement pursuant to Clause 3.3 and this Clause..

4 **OTHER ARRANGEMENTS/ADDITIONAL AGREEMENTS/CONSENTS**

- 4.1 During the period beginning on the date hereof and ending on the Trigger Date, the FIGSL Group is or may become a party to certain corporate purchasing contracts, master services agreements, vendor contracts, software and other Intellectual Property licenses or similar agreements unrelated to the FIGSL Services (the “**FIGSL Vendor Agreements**”) under which (or under open work orders thereunder) the GEIH Group purchases goods or services, licenses rights to use Intellectual Property and realises certain other benefits and rights. The parties hereby agree that the GEIH Group shall continue to retain the right to purchase goods or services and continue to realise such other benefits and rights under each FIGSL Vendor Agreement to the extent allowed by such FIGSL Vendor Agreement until the expiration or termination of such FIGSL Vendor Agreement for any reason. Additionally, for so long as the purchasing or other rights remain in full force and effect under a FIGSL Vendor Agreement and the GEIH Group continues to exercise its purchasing or other rights and benefits under such FIGSL Vendor Agreement and for a period of six months thereafter, FIGSL shall use its commercially reasonable efforts, upon the written request of GELS, to assist the GEIH Group in obtaining a purchasing contract, master services agreement, vendor contract or similar agreement directly with the third party provider that is a party to the FIGSL Vendor Agreement.
- 4.2 During the period beginning on the date hereof and ending on the Trigger Date, the GEIH Group is or may become a party to certain corporate purchasing contracts, master services agreements, vendor contracts, software and other Intellectual Property licenses or similar agreements unrelated to the GEIH Services (the “**GEIH Vendor Agreements**”) under which (or under open work orders thereunder) the FIGSL Group purchases goods or services, licenses rights to use Intellectual Property and realises certain other benefits and rights. The parties hereby agree that the FIGSL Group shall continue to retain the right to purchase goods or services and continue to realise such other benefits and rights under each GEIH Vendor Agreement to the extent allowed by such GEIH Vendor Agreement until the expiration or termination of such GEIH Vendor Agreement for any reason. Additionally, for so long as the purchasing or

11

---

other rights remain in full force and effect under a GEIH Vendor Agreement and the FIGSL Group continues to exercise its purchasing or other rights and benefits under such GEIH Vendor Agreement and for a period of six months thereafter, GELS shall use its commercially reasonable efforts, upon the written request of FIGSL, to assist the FIGSL Group in obtaining a purchasing contract, master services agreement, vendor contract or similar agreement directly with the third party provider that is a party to the GEIH Vendor Agreement.

- 4.3 Prior to the Trigger Date, each party shall continue to have access to the other party’s Information Systems. On and after the Trigger Date, a party shall not have access to all or any part of the other party’s Information Systems, except to the extent necessary for that party to provide and receive Services (subject to that party complying with all reasonable security measures implemented by the other party as deemed necessary by that other party to protect its Information Systems, provided that the first party shall have had a commercially reasonable period of time in which to comply with such security measures).
- 4.4 Each party will allow the other party and its Representatives reasonable access to its facilities as necessary for the performance of the Services.
- 4.5 The parties acknowledge and agree that certain software and other licences, consents, approvals, notices, registrations, recordings, filings and other actions need to be obtained in order to allow the Services to be provided (collectively, “**Consents**”). The GEIH Group shall, after consultation with FIGSL, either directly pay the out-of-pocket costs of obtaining, performing or satisfying such Consents (the “**Consents Costs**”) or, after any Consent is obtained, satisfied or performed, reimburse FIGSL for all actual Consents Costs incurred by FIGSL in connection with obtaining, performing or satisfying such Consents, provided however that the GEIH Group’s payment and reimbursement obligations in respect of the Consents Costs under this Clause and Clause 4.7.4 and GE’s payment and reimbursement obligations under Section 4.04(a) of the Global Transition Services Agreement shall not in the aggregate exceed the Total Consents Cost Amount. For the purposes of this Clause, the “**Total Consents Cost Amount**” means US\$11 million which amount represents the parties’ agreed-upon good faith estimate of the anticipated out-of-pocket costs with respect to obtaining, performing or otherwise satisfying (i) the Consents pursuant to the terms of this Agreement and (ii) the Consents (as such term is defined in the Global Transition Services Agreement) pursuant to the terms of the Global Transition Services Agreement. The GEIH Group shall be solely responsible for paying any costs or fees in connection with any Consents with respect to the FIGSL Services and any such costs or fees shall not be included in the Total Consents Cost

Amount.

- 4.6 Prior to receiving any reimbursement pursuant to Clause 4.5 above, FIGSL shall provide GELS with an invoice accompanied by reasonably detailed data and documentation sufficient to evidence the Consents Costs for which FIGSL is seeking reimbursement. Upon receipt of such invoice and data and documentation, GELS shall, except as otherwise provided in Clause 4.5, pay the amount of such invoice to FIGSL within 30 days of the date of receipt of such invoice. If GELS in good faith disputes the invoiced amount, then the parties shall work together to resolve such dispute. If the parties are unable to resolve such dispute within 30 days, the dispute shall be resolved pursuant to Clause 25 (*Applicable Law and Dispute Resolution*). The parties acknowledge and agree that no prior approval shall be required from the

12

---

GEIH Group or GELS in order for FIGSL to seek any reimbursement pursuant to Clause 4.5 and this Clause.

- 4.7 The parties agree that the leases and sub-leases listed in Part C of Schedule 1 shall have been assigned to or granted by the appropriate party by the Commencement Date, subject to obtaining any necessary third party consents or approvals. A party to whom a lease or sub-lease is to be assigned or granted agrees to accept such assignment or grant. To the extent that any such leases or sub-leases shall not have been granted or assigned by the Commencement Date:
- 4.7.1 notwithstanding Section 2.4.(a) of the Master Agreement, the leases in respect of (a) Radcliffe House, Keynes House and Pease House Old Charlton Road Priory Park Hitchin; (b) 25 Car Parking Spaces at Priory Park Hitchin; and (c) 88 Car Parking Spaces in the Woodlands Car Park at Hitchin Conference & Banqueting Centre Hitchin each dated 8 April 2002 and made between (1) GE Pensions Limited (2) GE Insurance Holdings Limited (3) FIGSL shall not terminate with effect from the Closing Date but shall continue in full force and effect and shall be assigned to GELS in accordance with this Clause 4.7;
- 4.7.2 the parties agree to work together in good faith to effect the assignment or grant (as appropriate) of any such leases or subleases;
- 4.7.3 to the extent that any assignment or grant of such leases and sub-leases is subject to or conditional upon any third party consents or approvals, the parties shall use their commercially reasonable endeavours to obtain such consents and approvals;
- 4.7.4 subject to Clause 4.5, GELS agrees that it shall pay or reimburse FIGSL for any third party costs payable by FIGSL in relation to the assignment or grant of the leases and sub-leases listed in Part C of Schedule 1;
- 4.7.5 FIGSL agrees to hold the leases or sub-leases which are to be assigned to GELS for the use and benefit of GELS and GELS shall pay or reimburse FIGSL for all amounts paid or incurred in connection with such leases and sub-leases. In addition, FIGSL shall, insofar as reasonably possible and to the extent permitted by applicable law, treat such leases and sub-leases in the ordinary course of business in accordance with past practice and take such other actions as may be reasonably requested by GELS in order to place GELS in the same position as if the relevant leases and sub-leases had been assigned as at the Commencement Date and so that all the benefits and burdens relating to such leases and sub-leases, including possession, use, risk of loss, potential for gain, and dominion, control and command over such leases and sub-leases, is to inure to GELS from and after the Commencement Date.
- 4.7.6 FIGSL shall not be obligated to expend any money in connection with any leases or sub-leases listed on Part C to Schedule 1 which are to be retained by it pending their assignment to GELS unless the necessary funds are advanced (or otherwise made available) by GELS, other than reasonable

13

---

out-of-pocket expenses, attorneys' fees and recording or similar fees, all of which shall be promptly reimbursed by GELS.

- 4.8 The parties acknowledge that it is anticipated that the Transfer Regulations will operate to transfer the contracts of employment of all employees of FIGSL who work primarily for or primarily in support of the members of the GEIH Group (other than Financial Insurance Company Limited, FACL, Consolidated Insurance Group Limited, GE Financial Assurance, Compania de Seguros y Reaseguros de Vida S.A. and GE Financial Insurance, Compania de Seguros y Reaseguros S.A.), other than those employees who provide support to such members of the GEIH Group solely by virtue of FIGSL's obligations hereunder, to GELS on the Closing Date. In the event any such employees shall not have been transferred to GELS on the Closing Date:
- 4.8.1 the parties agree to work together in good faith to effect the transfers of any such employees to GELS;
- 4.8.2 GELS agrees that it shall reimburse FIGSL for all costs incurred in continuing to employ such employees for the period between the Closing Date and the transfer of such employees to GELS taking effect (the "**Interim Period**"), having reference to such employees' existing contracts of employment and FIGSL's past practice;
- 4.8.3 GELS agrees that it shall reimburse FIGSL in respect of all liabilities incurred during the Interim Period as a result of continuing to employ such employees for the Interim Period, including any liabilities arising out of any unfair or constructive dismissal claims brought by such employees against FIGSL; and
- 4.8.4 GELS agrees to reimburse FIGSL for any costs and liabilities FIGSL incurs if FIGSL makes such employees redundant during the Interim Period, subject to FIGSL having consulted GELS prior to making any such redundancies.

FIGSL agrees that it shall at all times act reasonably and in good faith in relation to the transfer of the relevant employees to GELS and the recovery of costs and liabilities in respect of employees who shall not have been transferred to GELS on the Closing Date, including without limitation the costs and liabilities of making such employees redundant, from GELS.

- 4.9 The parties intend that any supplier contracts which need to be transferred from the GEIH Group to FIGSL or from the FIGSL Group to GELS to allow the Services to be provided or to enable the provision by GELS and FIGSL of services to their respective Group Companies shall have been transferred by the Commencement Date. To the extent that any such contracts shall not have been transferred by the Commencement Date, the parties agree to work together in good faith to effect the transfers of any such contracts.
- 4.10 The parties intend that any Intellectual Property which needs to be transferred from the GEIH Group to FIGSL or from the FIGSL Group to GELS to allow the Services to be provided or to enable the provision of GELS and FIGSL of services to their respective Group Companies shall have been transferred by the Commencement Date.

14

---

To the extent that any such Intellectual Property shall not have been transferred by the Commencement Date, the parties agree to work together in good faith to effect the transfers of any such Intellectual Property.

**4.11** With effect from the date on which the UK Scheme is approved in respect of substantially the whole of the business of FACL (as calculated by reference to the number of jurisdictions in which approval of the UK Scheme is obtained) (the “**UK Scheme Effective Date**”), GELS shall procure that FACL shall grant to Financial New Life Company Limited a sole licence to use the name “Financial Assurance Company Limited” and all and any derivatives thereof as a trading or business name in those jurisdictions in which approval of the UK Scheme has been obtained (the “**FACL Name Licence**”). Each party agrees and acknowledges that the FACL Name Licence is to be granted on an “as is” basis, with all faults and without warranty of any kind, and that the GEIH Group does not make and specifically disclaims any representations, warranties, express or implied in respect of the FACL Name Licence. FIGSL assumes for itself and on behalf of the FIGSL Group all risk and liability resulting from Financial New Life Company Limited’s use of the FACL Name Licence. FACL shall continue to be registered with the name “Financial Assurance Company Limited” and shall be entitled to use such name and its derivatives only:

**4.11.1** in those jurisdictions in which approval of the UK Scheme is not obtained on the UK Scheme Effective Date; or

**4.11.2** as required by law.

**4.12** Following the UK Scheme Effective Date, in the event the UK Scheme is approved in any other jurisdiction GELS shall promptly at FIGSL’s request procure that FACL extends the FACL Name Licence to such jurisdiction. Following the extension of the FACL Name Licence to any other jurisdiction FACL shall cease to use the name “Financial Assurance Company Limited” and all and any derivatives thereof in such jurisdiction, save as required by law.

**4.13** Upon the UK Scheme being approved in all relevant jurisdictions, GELS shall procure that:

**4.13.1** FACL shall immediately transfer to Financial New Life Company Limited all rights it owns in the name “Financial Assurance Company Limited” and all and any of the derivatives thereof;

**4.13.2** FACL is reregistered under a different name; and,

**4.13.3** save as required by law, FACL shall cease to use the name and all and any derivatives thereof in all jurisdictions.

## **5 THE PROVIDER’S RESPONSIBILITIES**

**5.1** The Provider shall act on behalf of the Recipient Group Companies but in respect of each Recipient Group Company, only to the extent of the authority given from time to time by such Recipient Group Company. A Recipient Group Company may vary its instructions to the Provider at any time.

15

---

**5.2** The Provider shall comply with all reasonable security requirements of the Recipient Group Companies and shall procure that all of its employees, agents and sub-contractors shall likewise comply with such requirements.

**5.3** The Provider shall notify the Recipient Group Companies of any special health and safety hazards of which it is aware (after making all reasonable enquiries) and which may be involved in performing the Services. The Provider shall further notify the Recipient Group Companies in advance of the Commencement Date of any information or requirements affecting the Recipient Group Companies under any legislation concerning health and safety at work.

## **6 CHARGES**

**6.1** In consideration of the Provider providing the Services to the Recipient and its Group Companies, the Recipient shall pay to the Provider the Service Charges.

**6.2** In addition, in connection with the performance of the Services, the Provider may incur certain out-of-pocket costs (“**Other Costs**”), which shall, without duplication, either be paid directly by the Recipient or reimbursed to the Provider by the Recipient; provided that any Other Costs shall only be payable by the Recipient if such Other Costs have been authorised by the relevant Services Manager prior to having been incurred by the Provider and subject to receipt by the Recipient of data and other documentation reasonably required to support the calculation of amounts due to the Provider as a result of such Other Costs.

**6.3** The parties acknowledge that the Service Charges reflect charges for such maintenance, support, error correction, training, updates and enhancements as shall be provided by the Provider pursuant to Clause 2.5.

**6.4** If the Recipient requests that the Provider provide a custom modification in connection with any Service pursuant to Clause 2.6, the Recipient shall be responsible for the cost of such custom modification.

## **7 TERMS OF PAYMENT**

**7.1** The Provider shall deliver an invoice to the Recipient on a quarterly basis (or at such other frequency as is consistent with the basis on which the Service Charges are determined and, if applicable, charged to Affiliates of the Provider) in arrears for the Service Charges and any Other Costs in respect of all Services provided to and Other Costs incurred in respect of the Recipient and its Group during that quarter.

**7.2** The Recipient shall pay such invoice in full to the Provider in UK sterling or in Euros, as appropriate, according to the terms of the invoice, within seventy-five (75) days of the date of such invoice in cleared funds to the bank nominated by the Provider.

**7.3** If the Recipient fails to pay any amount due to the Provider under this Agreement (excluding any amount contested in good faith) by the due date for payment, the Recipient shall pay to the Provider, in addition to the amount due, interest on such amount at the rate of 2% per annum over Barclays Bank plc’s base rate from time to time from the date the payment was due until the payment is made in full, both before and after any judgment.

16

---

**7.4** As soon as practicable after receipt by the Provider of any reasonable written request from the Recipient, the Provider shall provide the Recipient with data and documentation supporting the calculation of any amount due to the Provider under this Agreement the subject of the request for the purpose of verifying the accuracy of such calculation. If after reviewing such data and documentation the Recipient disputes the calculation of any amount due to the Provider then the dispute shall be resolved pursuant to Clause 25 (*Applicable Law and Dispute Resolution*).

**7.5** All sums due under this Agreement are exclusive of VAT which shall where applicable be paid by the appropriate Recipient.

**7.6** The Provider shall be responsible for the payment of all invoices due to third party suppliers in respect of Goods, equipment or services supplied in connection with the Services.

7.7 The Recipient shall pay the full amount of costs and disbursements including Other Costs incurred under this Agreement, and shall not set-off, counterclaim or otherwise withhold any other amount owed to the Provider on account of any obligation owed by the Provider to the Recipient.

## 8 COMPLIANCE WITH LAWS AND STANDARD FOR SERVICES

8.1 Each Provider will perform the Services in compliance with all applicable laws, enactments, orders, regulations, standards and other similar instruments and all other applicable provisions hereof and will obtain and maintain in force for the Term all licences, permissions, authorisations, consents and permits required to comply with all laws, enactments, orders, standards and regulations relevant to the performance of the Services under this Clause including for the avoidance of doubt the rules of any regulatory authority (whether the FSA or any other regulator) to the extent they apply to the provision of the Services hereunder.

8.2 Except as otherwise provided in this Agreement (including the Schedule hereto), the Provider agrees to perform the Services such that the nature, quality, standard of care and the service levels at which such Services are performed are no less than the nature, quality, standard of care and service levels at which the substantially same services were previously performed by or on behalf of the Provider or its predecessors, if applicable, prior to the Commencement Date (the “**Standard for Services**”).

8.3 The parties shall co-operate with each other and use their good faith commercially reasonable efforts to effect the efficient, timely and seamless provision and receipt of the Services.

## 9 WARRANTIES

9.1 All of the warranties specified in this Clause 9 are without prejudice to any other warranties expressed in this Agreement. Each such warranty shall be construed as a separate warranty and shall not be limited or restricted by reference, or inference from, the terms of any other warranty or any other term.

17

---

9.2 Each Provider hereby acknowledges and agrees that compliance by it with each such warranty shall not relieve it of any of its other obligations under this Agreement.

9.3 Each Provider warrants that, in the event that it delivers any Goods, as at the date of delivery of any Goods:

9.3.1 subject to any valid retention of title to the Goods by a third party, it has good title to the Goods and such title is free of all liens, charges and encumbrances; and

9.3.2 the Goods are of satisfactory quality, conform with the manufacturer’s specifications and are free from defects in design, manufacture, use of or materials for a period of twelve (12) months from the date of delivery;

and in the event this is discovered not to be the case during such twelve (12) month period, without prejudice to any other right or remedy which the Recipient may have, the Provider shall, at the Recipient’s option, replace or repair the Goods free of charge. For the avoidance of doubt, the costs to the Provider of replacing or repairing the Goods shall be subject to and count towards the overall cap on that Provider’s liability under this Agreement contained in Clause 13.2.

9.4 Each Provider further warrants that:

9.4.1 it has taken all requisite corporate and other action to approve the execution, delivery and performance of the Agreement, and agrees to produce to the Recipient evidence of such action upon reasonable request; and

9.4.2 it will not breach any rights (including but not limited to rights relating to Intellectual Property) or commit, or involve the Recipient in the commission of, any tort by entering into this Agreement and that this Agreement will constitute valid and legally binding obligations on the Provider in accordance with its terms when executed by such Provider.

## 10 CONTRAT DE GROUPEMENT DE FAIT

In view of the tax benefits enjoyed by RD Plus S.A., Vie Plus S.A. and Assocred S.A. (all such companies being either a FIGSL Group Company or a GEIH Group Company, and being together the “**Groupe ment de Fait Parties**”) pursuant to the Contrat de Groupement de Fait and their wish to preserve such tax benefits and for equivalent tax benefits to be obtained in respect of the Services to be provided as between the Groupement de Fait Parties pursuant to this Agreement, the parties hereto agree that the provisions of the Contrat de Groupement de Fait shall continue to apply so far as is possible as between the Groupement de Fait Parties to the extent necessary to preserve the tax benefits currently enjoyed by the Groupement de Fait Parties and to obtain equivalent tax benefits in respect of Services provided as between the Groupement de Fait Parties pursuant to this Agreement, provided however that in the event of any inconsistency between any of the provisions of this Agreement and the Contrat de Groupement de Fait, the provisions of this Agreement shall prevail as between the parties and the Groupement de Fait parties in respect of the matters dealt with hereunder.

18

---

## 11 RECORDS AND AUDIT

11.1 The Provider shall maintain proper records (“**Records**”) in connection with all Services provided by it under this Agreement. The Provider shall allow the Recipient, its employees, independent consultants, duly authorised agents, regulators and any other third parties notified by the Recipient to the Provider (to which notified parties the Provider does not reasonably object) to inspect and take copies of or extracts from such Records at all reasonable times (i) in connection with audits carried out pursuant to this Clause 11 to the extent reasonably necessary for the purpose of verifying the proper performance by the Provider of its obligations hereunder and the amounts due to the Provider hereunder or (ii) in connection with any agreements entered into by the Recipient pursuant to which the Recipient has agreed to provide information to the third party. The Provider shall afford the Recipient’s employees, independent consultants, authorised agents, regulators and the third parties notified by the Recipient to the Provider (to which notified parties the Provider does not reasonably object) reasonable access to all other relevant information, reports, documents, records, payments to suppliers, wage slips (whether in human or machine readable form) and data. All confidential information of the Provider made available to the Recipient’s employees, independent consultants, authorised agents and regulators under this Clause 11 shall be treated in accordance with Clause 16 (*Confidentiality*).

11.2 The Recipient reserves the right to conduct periodic audits to verify the Provider’s proper performance of the Services and the cost effectiveness and efficiency thereof. Such audits may be carried out by the Recipient’s employees, independent consultants, duly authorised agents and regulators and shall be carried out at the Recipient’s expense. The Provider hereby grants the Recipient, its employees, independent consultants, duly authorised agents and regulators a right of access to such of its records, employees and premises as the Recipient may reasonably request for the purposes of conducting such audits. The Provider shall make available such facilities and give such assistance as the Recipient may reasonably request in connection with the carrying out of any such audit.

11.3 Where an audit is to be carried out pursuant to this Clause 11, the audit shall be conducted with reasonable notice and shall be subject to the consent of the relevant Provider, which shall not be unreasonably withheld or delayed.

- 11.4 If as a result of an audit carried out pursuant to this Clause 11 a Recipient is unable to verify Service Charges previously demanded by its Provider and paid by that Recipient, the Recipient shall have the right to receive a refund of or proportionate reduction in the Service Charges for any such amount that cannot be verified. In the event that a Recipient is entitled to such a refund or reduction following an audit carried out pursuant to this Clause 11, that Recipient may request, and the Provider shall be obliged to pay, a reasonable proportion of the cost of carrying out the audit, bearing in mind the amount of refund or reduction to which the Recipient is entitled.

## 12 INTELLECTUAL PROPERTY

- 12.1 The Recipient shall be the owner of and has title to all property and Intellectual Property in any data, procedures, documentation or materials provided to the Provider hereunder by the Recipient or prepared or maintained by the Provider on behalf of the Recipient in connection with the provision of the Services. The Provider hereby

19

---

agrees from time to time to execute such documents and do such further acts or things as may be necessary to vest title to such Intellectual Property in the Recipient. The Recipient shall be entitled, at its sole cost and expense, to inspect and make copies of any such data, documentation and materials during normal office hours upon reasonable advance notice to the Provider. All such materials or documentation must be returned in good order and condition at the sole cost and expense of the Provider on request or on termination of this Agreement in a mutually agreed upon format and shall not be copied or used for any other purpose other than for carrying out the Services pursuant to this Agreement provided that the Provider shall be entitled, at its sole cost and expense, to retain one copy of all such data, documentation and materials for archiving purposes and for the purposes of responding to any dispute which may arise in connection with the Services.

- 12.2 Each Provider represents and warrants that:

- 12.2.1 save for the Consents, it has all necessary rights, authorisations and licences to provide the Services;
- 12.2.2 it has the authority to grant the rights to be granted to the Recipient hereunder;
- 12.2.3 neither the supply to the Recipient of the Services (or any Goods where relevant) or any part thereof nor the use by the Recipient of the Services (or any Goods) or any part thereof shall in any way constitute an infringement or other violation of any Intellectual Property of any third party; and
- 12.2.4 it owns or has obtained valid licences for all Intellectual Property which are necessary to the performance of any of its obligations hereunder.

## 13 LIMITATION OF LIABILITY AND INDEMNITIES

- 13.1 Save as provided in Clauses 13.2 and 13.4, and subject to Clause 13.6, no Provider or its Affiliates or any of their respective directors, officers or employees or any of the heirs, executors, successors and assigns of any of the foregoing (each, a “**Provider Indemnified Party**”) shall have any liability in contract, tort or otherwise to the Recipient or its Affiliates or Representatives for or in connection with any Services rendered or to be rendered by any Provider Indemnified Party pursuant to this Agreement, (ii) the transactions contemplated by this Agreement or (iii) any Provider Indemnified Party’s actions or inactions in connection with any such Services or transactions. For the avoidance of doubt this Clause shall not preclude a Recipient from exercising any remedies expressly provided elsewhere in this Agreement.

- 13.2 Each Provider shall indemnify, defend and hold harmless each relevant Recipient and each of its subsidiaries and each of their respective directors, officers and employees, and each of the heirs, executors, successors and assigns of any of the foregoing (each a “**Recipient Indemnified Party**”), from and against any and all liabilities of the Recipient Indemnified Parties relating to, arising out of, or resulting from:

- (i) the gross negligence or wilful misconduct of a Provider Indemnified Party in connection with the Provider Indemnified Party’s provision of the Services;

20

- 
- (ii) the improper use or disclosure of information of, or regarding, a customer or potential customer of a Recipient Indemnified Party in connection with the Provider Indemnified Party’s provision of the Services; or

- (iii) any violation of applicable law or regulation by a Provider Indemnified Party in connection with the Provider Indemnified Party’s provision of the Services including without limitation any breach of the FSA’s rules or any other regulator’s rules, save where the Provider Indemnified Party was acting in compliance with the Recipient Indemnified Party’s express instructions,

provided that, subject to Clause 13.6, (a) the aggregate liability of FIGSL as a Provider pursuant to this Clause shall in no event exceed £5 million and (b) the aggregate liability of GELS as a Provider pursuant to this Clause shall not exceed £5 million.

- 13.3 Each Recipient shall indemnify, defend and hold harmless each relevant Provider Indemnified Party from and against any and all liabilities of the Provider Indemnified Parties relating to, arising out of, or resulting from the provision of the Services by any Provider or any of its subsidiaries (including without limitation any liabilities arising out of any violation of applicable law or regulation or any breach of the FSA’s rules or any other regulator’s rules by a Recipient Indemnified Party in connection with the Services) except for (A) any liabilities that result from a Provider Indemnified Party’s negligence in connection with the provision of the Services, (B) any liabilities that result from a Provider Indemnified Party’s breach of this Agreement or (C) any liabilities for which the Provider is required to indemnify a Recipient Indemnified Party pursuant to Clause 13.2. For the avoidance of doubt, a Recipient’s liability under this Clause 13.3 shall be unlimited save as provided in Clause 13.5.

- 13.4 In addition, save as provided in Clause 4.8, the parties agree they shall share equally any liability incurred by a party or any of its Group Companies in connection with any claim brought against a party or any of its Group Companies pursuant to the Transfer Regulations by any employee of either party or any of the parties’ Group Companies in connection with the termination of any Service under this Agreement or of the Agreement as a whole (an “**Employee Claim**”). Each party shall indemnify the other party and each of the other party’s Group Companies against fifty per cent. (50%) of all expenses, damages, compensation, fines and other liabilities including reasonable legal costs arising out of or in connection with any Employee Claim.

- 13.5 Subject to Clause 13.6 but notwithstanding any other provision contained in this Agreement, neither party shall be liable to the other for any special, indirect, punitive, incidental or consequential losses, damages or expenses of the other, including, without limitation, loss of profits, arising from any claim relating to breach of this Agreement or otherwise relating to any of the Services provided hereunder save that the limitations contained in this Clause 13.5 shall not apply to:

- 13.5.1 damages awarded to a third party pursuant to a third party claim for which a Provider is required to indemnify, defend and hold harmless any Recipient Indemnified Party under Clause 13.2; or

21

13.5.2 damages awarded to a third party pursuant to a third party claim for which a Recipient is required to indemnify, defend and hold harmless any Provider Indemnified Party under Clause 13.3.

13.6 Nothing in this Agreement shall exclude or limit the liability of a party in respect of:

13.6.1 death or personal injury caused by the negligent or malicious acts or omissions of such party;

13.6.2 fraud;

13.6.3 the indemnities in respect of Employee Claims contained in Clause 13.4; or

13.6.4 GELS' payment obligations in respect of employees under Clause 4.8.

13.7 Nothing in this Clause 13 shall be deemed to eliminate or limit in any respect GELS or FIGSL's express payment and reimbursement obligations under this Agreement.

#### 14 CONDUCT OF CLAIMS

14.1 If a party entitled to indemnification under Clause 13 (the "**Indemnified Party**") becomes aware of a matter which may give rise to a claim by a third party in respect of which the other party (the "**Indemnifying Party**") may be required to indemnify the Indemnified Party (a "**Relevant Claim**") or any proceedings shall be instituted against the Indemnified Party which may give rise to a Relevant Claim, the Indemnified Party shall give notice thereof in writing to the Indemnifying Party within 20 days of becoming aware of such Relevant Claim or such proceedings, stating in reasonable detail the nature of the matter on a without prejudice basis, if practicable and the amount claimed. Notwithstanding the foregoing, the failure of any Indemnified Party to give notice pursuant to this Clause 14.1 shall not relieve the Indemnifying Party of its obligations under Clause 13.

14.2 The Indemnifying Party shall have the option, at its own expense and subject to the Indemnified Party being indemnified by the Indemnifying Party against all costs and liabilities incurred by the Indemnified Party in relation thereto, to assume the defence of a Relevant Claim, including the instruction of legal advisers reasonably satisfactory to the Indemnified Party to represent the Indemnified Party and any others which the Indemnifying Party may designate in such proceedings and the Indemnifying Party shall pay the fees and disbursements of such legal advisers related to such proceedings. Within 30 days of the receipt of notice from the Indemnified Party pursuant to Clause 14.1 (or sooner, if the nature of the Relevant Claim requires), the Indemnifying Party shall notify the Indemnified Party whether it chooses to assume the defence of the Relevant Claim, which notice shall specify any reservations or exceptions.

14.3 If the Indemnifying Party exercises the option referred to in Clause 14.2:

14.3.1 the Indemnified Party shall provide to the Indemnifying Party and its advisers reasonable access to its personnel and to its premises, assets and documents and records in its possession or under its control, and give the Indemnifying Party any information and assistance as it shall reasonably

22

---

request, and the Indemnifying Party may, at its cost, take copies of such documents and records as it reasonably requires;

14.3.2 the Indemnified Party shall take any action and institute any proceedings, to enable the Indemnifying Party to dispute, resist, appeal, compromise, defend, remedy or mitigate the Relevant Claim or enforce against another person the Indemnified Party's rights in relation to the Relevant Claim;

14.3.3 the Indemnifying Party shall, if so required by the Indemnified Party, maintain consultation with the Indemnified Party on all aspects of such proceedings and shall provide the Indemnified Party with all information reasonably requested by it in relation to such proceedings; and

14.3.4 the Indemnified Party shall have the right to retain its own legal advisers, but the fees and expenses of such legal advisers shall be at the expense of the Indemnified Party unless:

(a) the Indemnifying Party and the Indemnified Party shall have mutually agreed to the retention of such legal advisers; or

(b) the named parties to any such proceedings (including any added parties) include both the Indemnifying Party and the Indemnified Party and representation of both parties by the same legal advisers would be inappropriate due to actual or potential differing interests between them.

14.4 If the Indemnifying Party does not exercise its option contained in Clause 14.2, or fails to notify the indemnified Party that it chooses to exercise such option within the relevant timetable set out in that Clause, in the event of a Relevant Claim the Indemnified Party shall, subject to being indemnified by the Indemnifying Party against all costs and liabilities incurred in so doing:

14.4.1 take or procure such action to be taken as the Indemnifying Party shall reasonably request to deal with a Relevant Claim;

14.4.2 if so required by the Indemnifying Party, maintain consultation with the Indemnifying Party on all aspects of any proceedings in defence of a Relevant Claim; and

14.4.3 provide the Indemnifying Party with all information reasonably requested by it in relation to such proceedings.

14.5 Unless the Indemnifying Party has failed to assume the defence of a Relevant Claim, the Indemnified Party shall not admit liability in respect of a Relevant Claim, nor compromise, nor settle any proceedings in defence of a Relevant Claim, without the written consent of the Indemnifying Party (such consent not to be unreasonably withheld or delayed). No Indemnifying Party shall consent to entry of any judgment or settle any proceedings in defence of a Relevant Claim without the consent of the Indemnified Party if the effect thereof is to permit any injunction, declaratory judgment, other order or other non-monetary relief to be entered directly or indirectly against the Indemnified Party.

23

---

14.6 No Indemnifying Party shall, without the prior written consent of the Indemnified Party, effect any settlement of any pending or threatened Relevant Claim in respect of which any Indemnified Party is or could have been a party and indemnity could have been sought hereunder by such Indemnified Party, unless such settlement includes an unconditional release of such Indemnified Party from all liability on claims that are the subject matter of such Relevant Claim.

14.7 Any liabilities for which an Indemnified Party is entitled to indemnification or contribution under Clause 13 shall be paid by the Indemnifying Party to the Indemnified

Party as such liabilities are incurred. The indemnity and contribution agreements contained in Clause 13 shall remain operative and in full force and effect, regardless of (i) any investigation made by or on behalf of any Indemnified Party and (ii) any termination of this Agreement.

- 14.8** Any claim on account of a liability which does not result from a Relevant Claim shall be asserted by written notice given by the Indemnified Party to the applicable Indemnifying Party. Such Indemnifying Party shall have a period of 30 days after the receipt of such notice within which to respond thereto. If such Indemnifying Party does not respond within such 30-day period, such Indemnifying Party shall be deemed to have refused to accept responsibility to make payment. If such Indemnifying Party does not respond within such 30-day period or rejects such claim in whole or in part, such Indemnified Party shall be free to pursue such remedies as may be available to such party as contemplated by this Agreement.
- 14.9** If payment is made by or on behalf of any Indemnifying Party to any Indemnified Party in connection with any Relevant Claim, such Indemnifying Party shall be subrogated to and shall stand in the place of such Indemnified Party as to any events or circumstances in respect of which such Indemnified Party may have any right, defence or claim relating to such Relevant Claim against any claimant or plaintiff asserting such Relevant Claim or against any other Person. Such Indemnified Party shall cooperate with such Indemnifying Party in a reasonable manner, and at the cost and expense of such Indemnifying Party, in prosecuting any subrogated right, defence or claim.
- 14.10** In an action in which the Indemnifying Party is not a named defendant, if either the Indemnified Party or Indemnifying Party shall so request, the parties shall endeavour to substitute the Indemnifying Party for the named defendant if they conclude that substitution is desirable and practical. If such substitution or addition cannot be achieved for any reason or is not requested, the named defendant shall allow the Indemnifying Party to manage the action as set forth in this Clause, and the Indemnifying Party shall fully indemnify the named defendant against all costs of defending the action (including court costs, sanctions imposed by a court, legal fees, experts' fees and all other external expenses), the costs of any judgment or settlement, and the cost of any interest or penalties relating to any judgment or settlement.
- 14.11** The Indemnified Party shall have no right to an indemnity under Clause 13 in respect of any liability to the extent that it actually recovers any monies in respect of such liability under any insurances it maintains. If an Indemnified Party receives a payment in respect of a liability pursuant to the indemnities contained in Clause 13 from the Indemnifying Party and subsequently recovers monies under its insurances

24

---

in respect of such liability, the Indemnified Party shall reimburse the Indemnifying Party an amount equal to the monies received under its insurances.

- 14.12** The Indemnified Party shall use its commercially reasonable efforts to seek or collect or recover any insurance monies (save from any captive insurance subsidiary) to which the Indemnified Party is entitled in connection with any liability for which it is indemnified under Clause 13.
- 14.13** The Indemnified Party shall use its commercially reasonable endeavours to mitigate any loss in respect of which it is indemnified under Clause 13.

## **15 ASSIGNMENT AND SUB-CONTRACTING**

- 15.1** This Agreement shall not be assigned or transferred by a party hereto without the prior written consent of the other party save as provided in Clause 15.2.
- 15.2** In the event a Recipient sells the whole or part of any Recipient Group Company (a "**Recipient Divested Company**") or the whole or part of the business of any Recipient Group Company (a "**Recipient Divested Business**") to a third party, the Provider shall remain obliged to continue to provide Services to such Recipient Divested Company or the purchaser of such Recipient Divested Business (but not otherwise to such purchaser) to the extent it was providing such Services immediately prior to such divestiture, pursuant to the terms of this Agreement, unless otherwise agreed upon by the parties hereto, provided however that the Provider's obligation to provide Services to a Recipient Divested Company or the purchaser of a Recipient Divested Business shall be subject to:
- (i) the implementation of new Service Charges as between the Provider and such Recipient Divested Company or the third party purchaser of such Recipient Divested Business for such Services, which new Service Charges shall be proposed by the Provider at its sole discretion save that such new Service Charges shall be consistent with applicable market rates for such Services;
  - (ii) the Recipient or the Recipient Divested Company or the third party purchaser of such Recipient Divested Business agreeing to pay or cause to be paid any incremental fees or expenses incurred by the Provider in connection with establishing or transferring the provision of such Services to the third party;
  - (iii) obtaining any consents that are necessary to enable the Provider to provide the Services to the Recipient Divested Company or the third party purchaser of such Recipient Divested Business, provided that FIGSL and GELS shall each use commercially reasonable efforts to obtain any such consents;
  - (iv) the Recipient Divested Company or the third party purchaser of such Recipient Divested Business agreeing to any reasonable security measures implemented by the Provider in providing the Services as deemed necessary by the Provider to protect its Information Systems; and
  - (v) the Recipient Divested Company or the third party purchaser of such Recipient Divested Business agreeing in writing to be bound by all applicable provisions of this Agreement.

25

---

- 15.3** In the event a Recipient Group Company acquires a business or portion thereof by merger, stock purchase, asset purchase, reinsurance or other means that engages in the same type of business as the relevant Recipient Group, (a "**Recipient Acquired Company**"), then the Provider shall be obliged to provide the Services to such Recipient Acquired Company, to the extent applicable, pursuant to the terms of this Agreement, unless otherwise agreed upon by the parties hereto provided however that in the event the acquisition of a Recipient Acquired Company results in a change to the volume or quantity of any Service which causes a material increase in the Provider's costs of providing such Service, the parties shall negotiate in good faith and use their commercially reasonable efforts to agree upon a price increase to the Service Charges for such Service to compensate the Provider for the increase in the cost of providing such Service.
- 15.4** Nothing in this Clause shall be deemed to waive any party's rights to relieve or otherwise satisfy any party's non-compete obligations between GE and Genworth provided for under the Master Agreement.
- 15.5** The parties may sub-contract any of their obligations under this Agreement but a sub-contracting party must ensure that its subcontractor complies with all of that party's obligations under this Agreement and the sub-contracting party shall remain responsible at all times for the performance of such obligations.

## **16 CONFIDENTIALITY**

- 16.1** GELS shall not, and shall cause its Affiliates and Representatives not to, directly or indirectly, disclose, reveal, divulge or communicate to any person other than its Representatives or its Affiliates who reasonably need to know such information in providing services to any member of the FIGSL Group or use or otherwise exploit for its own benefit or for the benefit of any third party, any FIGSL Confidential Information. For purposes of this Clause, "**FIGSL Confidential Information**" means any information, material or documents relating to the businesses currently or formerly conducted, or proposed to be conducted, by any member of the FIGSL Group

furnished to or in possession of the GEIH Group, irrespective of the form of communication, and all notes, analyses, compilations, forecasts, data, translations, studies, memoranda or other documents prepared by the GEIH Group or their respective officers, directors and Affiliates, that contain or otherwise reflect such information, material or documents. FIGSL Confidential Information does not include, and there shall be no obligation hereunder with respect to, information that (i) is or becomes generally available to the public, other than as a result of a disclosure by any member of the GEIH Group in breach of this Clause, or (ii) GELS can demonstrate was or became available to the GEIH Group from a source other than the FIGSL Group or their Affiliates provided however that the source of such information was not known by the GEIH Group to be bound by a confidentiality agreement with, or other contractual, legal or fiduciary obligation of confidentiality to, FIGSL or any member of the FIGSL Group with respect to such information.

- 16.2 FIGSL shall not, and shall cause its Affiliates and Representatives, not to, directly or indirectly, disclose, reveal, divulge or communicate to any person other than its Representatives or its Affiliates who reasonably need to know such information in providing services to any member of the GEIH Group or use or otherwise exploit for its own benefit or for the benefit of any third party, any GEIH Confidential

26

---

Information. For purposes of this Clause, “**GEIH Confidential Information**” means any information, material or documents relating to the businesses currently or formerly conducted, or proposed to be conducted, by any member of the GEIH Group furnished to or in possession of the FIGSL Group, irrespective of the form of communication, and all notes, analyses, compilations, forecasts, data, translations, studies, memoranda or other documents prepared by the FIGSL Group or their respective officers, directors and Affiliates, that contain or otherwise reflect such information, material or documents. GEIH Confidential Information does not include, and there shall be no obligation hereunder with respect to, information that (i) is or becomes generally available to the public, other than as a result of a disclosure by any member of the FIGSL Group in breach of this Clause, or (ii) FIGSL can demonstrate was or became available to the FIGSL Group from a source other than the GEIH Group or their Affiliates; provided however that the source of such information was not known by the FIGSL Group to be bound by a confidentiality agreement with, or other contractual, legal or fiduciary obligation of confidentiality to, the GEIH Group or any member of the GEIH Group with respect to such information.

- 16.3 If either party is requested or required (by oral question, interrogatories, requests for information or documents, subpoena, civil investigative demand or similar process) by any governmental authority or pursuant to applicable law or regulation to disclose or provide any FIGSL Confidential Information or GEIH Confidential Information, as applicable, the entity or person receiving such request or demand shall (where permitted by law) use all reasonable efforts to provide the other party with written notice of such request or demand as promptly as practicable under the circumstances so that such other party shall have an opportunity to seek an appropriate protective order. The party receiving such request or demand agrees to take, and cause its representatives to take, at the requesting party’s expense, all other reasonable steps necessary to obtain confidential treatment by the recipient. Subject to the foregoing, the party that received such request or demand may thereafter disclose or provide any FIGSL Confidential Information or GEIH Confidential Information, as the case may be, to the extent required by such law (as so advised by counsel) or regulation or by lawful process or such governmental authority.
- 16.4 Notwithstanding anything to the contrary set forth in this Agreement or in any other agreement to which the parties hereto are parties or by which they are bound, the obligations of confidentiality contained herein and therein, as they relate to the transactions contemplated by the Master Agreement, shall not apply to the tax structure or tax treatment of such transactions, and each party hereto (and any employee, Representative, or agent of any party thereto) may disclose to any and all persons, without limitation of any kind (including opinions or other tax analysis) that are provided to such party relating to such tax treatment and tax structure; provided, however, that such disclosure shall not include the name (or other identifying information not relevant to the tax structure or tax treatment) of any person and shall not include information for which nondisclosure is reasonably necessary in order to comply with applicable securities laws.

## 17 TERMINATION

### 17.1 Automatic Termination

27

---

17.1.1 This Agreement shall terminate automatically in relation to an individual Service on the applicable Service Termination Date unless the Provider and Recipient agree to extend the Service Termination Date in which case this Agreement shall terminate in relation to that Service on the extended Service Termination Date.

17.1.2 This Agreement shall terminate automatically on the date on which the last remaining Service being provided under this Agreement shall terminate.

### 17.2 Failure to Perform

If at any time during the Term a party commits a breach of its material obligations hereunder and in the case of a breach capable of remedy, fails to remedy such breach within sixty (60) working days after receipt of notice from the other party to remedy the same, the other party shall be entitled to terminate this Agreement with immediate effect by written notice in respect of any or all of the Services provided or received by the party in breach provided however that no Service may be terminated pursuant to this Clause 17.2 until the parties have completed the dispute resolution process set out in Clause 25.2.2 with respect to such Service and the Chief Executive Officers of the parties have failed to resolve matters.

### 17.3 By Mutual Agreement

The parties may from time to time agree in writing to terminate any Service in whole but not in part, provided that any such agreement to terminate a Service shall set out any terms and conditions of termination.

### 17.4 Insolvency

If at any time during the Term a party:

- 17.4.1 passes a resolution for voluntary winding up or a court of competent jurisdiction makes an order that such party be wound up except for the purposes of bona fide reconstruction while solvent; or
- 17.4.2 makes a composition or arrangement with its creditors; or
- 17.4.3 has a receiver or manager or provisional liquidator or administrator appointed over the whole or a substantial part of its business or undertaking or circumstances arise which would entitle a court of competent jurisdiction or a creditor to appoint the same; or
- 17.4.4 is unable to pay its debts within the meaning of section 123 of the Insolvency Act 1986,

then the other party shall be entitled to terminate this Agreement with immediate effect by written notice.



## 17.5 On Notice

17.5.1 Subject to Clause 17.5.2, a Recipient shall be entitled to terminate this Agreement in respect of any or all of the Services provided to it at its

28

---

absolute discretion at any time by giving not less than sixty (60) days' notice of its intention to do so to the Provider (or such shorter period of time as is agreed in writing by the parties). Subject to payment of the Service Charges payable under the Agreement which are due to the Provider for the period up to the effective date of termination, a Recipient shall have the right to require the relevant Provider to cease provision of the Services during the sixty (60) day notice period and to instruct its sub-contractors, if any, to do similarly.

17.5.2 Until the transfer of the FACL Bonds (as defined in the Master Agreement) to an appropriate GE Affiliate in accordance with Section 2.10(b) of the Master Agreement, FIGSL shall not be entitled to terminate the bond administration service to be provided to FACL (Schedule 1, Part A, Service No. 4) on notice. For the avoidance of doubt, following such transfer, FACL will be entitled to terminate such service pursuant to Clause 17.5.1 above.

## 17.6 Force Majeure Event of Longstanding Duration

If any Force Majeure Event (as defined in Clause 20) prevents a party from performing all of its obligations hereunder for a period in excess of one (1) month, the other party may terminate this Agreement in respect of the Services provided to or by the party so prevented with immediate effect on written notice.

## 17.7 Accrued Rights

Termination in accordance with this Clause 17 shall not prejudice or affect any right of action or remedy which shall have accrued or shall thereafter accrue to either party.

## 18 THE PROVIDER'S OBLIGATIONS ON TERMINATION

18.1 In the event that a Recipient requires a different organisation to take on the provision of any or all of the Services provided to it by its Provider on the termination of this Agreement in respect of such Services, the Provider shall co-operate in the transfer, under any arrangements to be notified to it by the Recipient, to effect a full and orderly transition of such Services to the succeeding contractor by the Service Termination Date or thereafter and will furnish any succeeding contractor with any information or documentation required to perform such Services.

18.2 The Provider shall comply with all reasonable instructions from the Recipient with regard to termination of the Services and take reasonable steps to mitigate any costs which the Recipient will incur as a result of the termination.

18.3 Upon the written request of the Recipient, the Provider will, for a reasonable period of time after the effective date of any termination of a Service pursuant to Clause 17.2 above (which period shall not exceed the earlier of (i) the applicable Service Termination Date as set out in Parts A and B of Schedule 1 or (ii) six months after the effective date of termination), continue to provide the terminated Service on the terms of this Agreement (subject to the timely payment, when due and payable, by the Recipient of all Service Charges related to such terminated Service). The Service

29

---

Charges for a Service provided pursuant to this Clause 18.3 shall be the same as were in effect prior to the termination of such Service.

18.4 In the event that the Agreement is terminated as provided for herein:

18.4.1 each party shall return to the other party all property belonging to the other party then in its possession in good working order; and

18.4.2 in the event the Recipient has paid Service Charges in advance for Services not received as at the date of termination, the Provider shall refund the Recipient such Service Charges.

18.5 In the event that the Agreement is terminated for fundamental breach the Recipient shall have the following rights (but not obligations) to require the Provider to:

18.5.1 provide a schedule of all equipment, labour, resources and subcontracts used exclusively or primarily to provide the Services;

18.5.2 transfer any or all assets which are exclusively or primarily used for the performance of the Services to the Recipient at a fair market value which may be verified by an independent valuer who is acceptable to both parties; and

18.5.3 assign any or all software licences or other licences or agreements that are used exclusively or primarily in the provision of the Services for the benefit of the Recipient, where this is permitted by the terms of the licence.

18.6 On termination of this Agreement the Provider shall comply with its obligations to return documentation and materials provided by the Recipient under Clause 12.1.

## 19 SURVIVAL OF OBLIGATIONS ON TERMINATION

Following the termination of this Agreement as provided for herein, no party shall have any further right or obligation with respect to any other party except as set forth in the following Clauses:

<i>Clause 1</i>	—	<i>Interpretation</i>
<i>Clause 4.7</i>	—	<i>Leases</i>
<i>Clause 8</i>	—	<i>Warranties</i>
<i>Clause 12</i>	—	<i>Intellectual Property</i>
<i>Clause 13</i>	—	<i>Limitation of Liability and Indemnities</i>
<i>Clause 14</i>	—	<i>Conduct of Claims</i>
<i>Clause 16</i>	—	<i>Confidentiality</i>
<i>Clause 18</i>	—	<i>The Provider's Obligations on Termination</i>
<i>Clause 25</i>	—	<i>Applicable Law and Dispute Resolution</i>
<i>Clause 26</i>	—	<i>Data Protection</i>
<i>Clause 27</i>	—	<i>Further Assurance</i>
<i>Clause 29</i>	—	<i>Notices</i>

## 20 FORCE MAJEURE/BUSINESS CONTINUITY

- 20.1 Each party shall maintain and comply with a reasonable disaster recovery, crisis management and business continuity plan designed to help ensure that it can continue to provide the Services in accordance with this Agreement in the event of a disaster or other significant event that might otherwise impact its operations. Each party shall ensure that any disaster recovery, crisis management and business continuity plan shall comply with any relevant regulatory requirements, whether of the FSA or any other regulator. Upon the written request of a Recipient, a Provider shall (i) disclose to the Recipient the Provider's disaster recovery, crisis management and business continuity plans and procedures applicable to a Service and (ii) permit the Recipient to participate in testing of such disaster recovery, crisis management and business continuity plans and procedures, in each case so that the Recipient may assess such plans and procedures and develop or modify its own such plans and procedures in connection with the Services as the Recipient reasonably deems necessary.
- 20.2 Neither party hereto (or any person acting on its behalf) shall have any liability or responsibility for failure to fulfil any obligation (other than a payment obligation) under this Agreement so long as and to the extent to which the fulfilment of such obligation is prevented, frustrated, hindered or delayed as a consequence of a Force Majeure Event, provided that such party shall have first exhausted, to the extent commercially reasonably to do so, the procedures described in its disaster recovery, crisis management, and business continuity plan.
- 20.3 A party claiming the benefit of this provision shall, as soon as reasonably practicable after the occurrence of any such event: (i) notify the other party of the nature and extent of any such Force Majeure Event and (ii) use all reasonable endeavours to remove any such causes and resume performance under this Agreement as soon as feasible.
- 20.4 For the purposes of this Clause, a "Force Majeure Event" means, with respect to a party, an event beyond the control of such party (or any person acting on its behalf), which by its nature could not have been foreseen by such party (or such person), or, if it could have been foreseen, was unavoidable, and includes, without limitation, acts of God, storms, floods, riots, fires, sabotage, civil commotion or civil unrest, interference by civil or military authorities, acts of war (declared or undeclared) or armed hostilities or other national or international calamity or one or more acts of terrorism or failure of energy sources.

## 21 INCONSISTENCY/PREVAILING AGREEMENT

In the event of an inconsistency between any of the provisions of this Agreement and the Global Transition Services Agreement, the Master Agreement or any Continuing Agreement, the provisions of this Agreement shall prevail as between the parties in respect of the matters dealt with hereunder.

## 22 MASTER AGREEMENT

The parties hereby agree that notwithstanding the provisions of Section 2.4(a) of the Master Agreement, any intercompany accounts payable or accounts receivable outstanding between the parties' Groups as at the Closing Date shall continue to be

outstanding following that date provided however that, subject to the provisions of the European Tax Matters Agreement, the parties shall settle all such intercompany accounts payable or accounts receivable within 60 days following the Closing Date.

## 23 REGULATORY APPROVAL AND COMPLIANCE

Each party shall be responsible for its own compliance with any and all laws and requirements of any regulator (whether in the UK or elsewhere) applicable to its performance under this Agreement; provided, however, that each party shall at the request of the other party and subject to reimbursement of out-of-pocket expenses by the requesting party, cooperate and provide one another with all reasonably requested assistance (including, without limitation, the execution of documents and the provision of relevant information) required by the requesting party to ensure compliance with all applicable laws and regulations or in connection with any regulatory action, inquiry or examination.

## 24 SEVERABILITY

If any provision of the Agreement is held invalid, illegal or unenforceable for any reason, such provision shall be severed and the remainder of the provisions hereof shall continue in full force and effect as if the Agreement had been executed with the invalid provision eliminated. In the event a provision hereof is severed, the parties shall negotiate in good faith to modify this Agreement in order to effect the original intent of the parties as closely as possible and enable the transactions contemplated by the parties to be consummated as originally contemplated as far as is possible.

## 25 APPLICABLE LAW AND DISPUTE RESOLUTION

- 25.1 The Agreement shall be governed by and construed in accordance with the law of England and Wales.
- 25.2 In the event of any dispute, controversy or claim arising out of or relating to this Agreement or the breach, termination or validity hereof or thereof (a "Dispute"), the parties shall follow the dispute resolution procedure set out in this Clause:
- 25.2.1 upon a party serving written notice requesting that the parties attempt to resolve a Dispute ("Notice") the Service Managers of the parties shall attempt in good faith to resolve such Dispute;
- 25.2.2 if the Service Managers are for any reason unable to resolve a Dispute within 30 days of delivery of a Notice, the Dispute shall be referred to the Chief Executive Officers of FIGSL and GELS who shall attempt in good faith to resolve such dispute; and
- 25.2.3 if the Chief Executive Officers of FIGSL and GELS are for any reason unable to resolve a Dispute within 45 days of such Dispute being referred to them for resolution then either party may submit the Dispute for resolution by mediation pursuant to the procedures of the Centre for Effective Dispute Resolution as then in effect. The mediation shall be heard by a mediator appointed by the parties but if they cannot agree upon a mediator within 14 days of either of them submitting the Dispute to mediation, such mediator

shall be appointed by the Centre for Effective Dispute Resolution. Either party may at the commencement of mediation ask the mediator to provide an evaluation of the Dispute and the parties' relative positions;

**25.2.4** If a Dispute is not resolved by mediation within 30 days of the selection of a mediator (unless the mediator chooses to withdraw sooner), then either party may refer the Dispute to be settled and finally resolved by arbitration in accordance with the UNCITRAL Arbitration Rules as in force at the time of the election (the “Rules”) by a panel of three arbitrators (or a sole arbitrator as the parties may agree) appointed in accordance with the Rules.

**25.3** The seat of any reference to arbitration shall be London, England, the procedural law of any reference to arbitration shall be English law and the language of any arbitration proceedings shall be English.

**25.4** The appointing authority for the purposes set forth in Article 7(2) of the Rules shall be the London Court of International Arbitration.

**25.5** Any right of appeal or reference of points of law to the courts is hereby waived, to the extent that such waiver can be validly made.

**25.6** The arbitral tribunal shall have the power to order on a provisional basis any relief which it would have power to grant in a final award.

## **26 DATA PROTECTION**

Each Provider agrees that it is registered in accordance with the Data Protection Act 1998 so far as is necessary to provide the Services and agrees to maintain such registrations in full force and effect. Each Provider undertakes that it will comply and agrees to ensure that its sub-contractors will comply with its appropriate obligations under all data protection legislation in force from time to time.

## **27 FURTHER ASSURANCE**

Each party agrees at its own expense to execute such documents and generally do everything further that may be necessary to fulfil its obligations under and achieve the objectives of this Agreement.

## **28 WAIVER OF REMEDIES**

No waiver of any rights arising under this Agreement shall be effective unless agreed (where possible in writing and signed by a duly authorised signatory) by the party against whom the waiver is to be enforced. No failure or delay by a party in exercising any right, power or remedy under this Agreement (except as expressly provided herein) shall operate as a waiver of any such right, power or remedy.

## **29 NOTICES**

**29.1** Any notice, invoice or other communication which a party is required by the Agreement to be served on the other party shall be sufficiently served if addressed to the Company Secretary of the other party and sent to the other party at its specified address as follows:

33

---

**29.1.1** by hand;

**29.1.2** by registered or first class post or recorded delivery; or

**29.1.3** by facsimile transmission confirmed by registered or first class post or recorded delivery.

Notices sent by registered post or first class post or recorded delivery shall be deemed to be served three (3) working days following the day of posting. Notices sent by facsimile transmission shall be deemed to be served on the day of transmission if transmitted before 4:00 p.m. on a working day, but otherwise on the next following working day. In all other cases, notices are deemed to be served on the day when they are actually received. All notices, invoices and other communications served hereunder shall expressly refer to the Clause or sub-Clause pursuant to which they are served.

**29.2** For the purposes of this Clause 29 the authorised address of each party shall be the address set out at the head of this Agreement or such other address (and details) as that party may notify to the other party from time to time in accordance with the requirements of this Clause 29.

## **30 NO PARTNERSHIP**

Nothing in the Agreement is intended or shall be construed to create a partnership between the parties or unless expressly stated, a relationship of agency. Unless otherwise authorised, neither party shall have any authority to act or make representations on behalf of the other party, and nothing herein shall impose any liability on either party in respect of any liability incurred by the other party to a third party.

## **31 ENTIRE AGREEMENT**

This Agreement together with the Schedule hereto contains the entire agreement between the parties and supersedes any previous understandings, commitments, contracts or representations whatsoever whether oral or written, except in respect of any fraudulent representation made by any party. This Agreement shall not be varied except by an instrument in writing of date even herewith or subsequent hereto executed by all parties by their duly authorised representatives.

## **32 RIGHTS OF THIRD PARTIES**

With the exception of any Recipient Group Company which is entitled to receive Services hereunder and any person expressly indemnified hereunder by a party to this Agreement, this Agreement is for the sole benefit of the parties to this Agreement and nothing in this Agreement, is intended to or shall confer upon any other person or entity any legal or equitable right, benefit or remedy of any nature whatsoever under or by reason of this Agreement. A person who is not a party to this Agreement has no rights under the Contracts (Rights of Third Parties) Act 1999 or otherwise to enforce any term of this Agreement but this does not affect any right or remedy of a third party which exists or is available apart from that Act.

34

---

## **33 COUNTERPARTS**

This Agreement may be executed in any number of counterparts, each of which when executed and delivered shall constitute an original of this Agreement, but all the counterparts shall together constitute one and the same agreement. No counterpart shall be effective until each party has executed at least one part or counterpart.

**IN WITNESS WHEREOF** this Agreement was executed by the parties hereto on the date set out on Page 1.

**SCHEDULE 1  
SERVICES  
PART A — GEIH SERVICES**

**PART B — FIGSL SERVICES**

**PART C  
SECTION I — LEASES TO BE TRANSFERRED BY FIGSL TO GELS**

Date	Parties	Premises
1 May 1995	1. Wingrove Property Trading Limited 2. FIGSL 3. Diplema 115 Limited	Vantage West, Great West Road, Brentford
23 March 1990	1. The Medical Sickness Annuity and Life Assurance Society Limited 2. Frogmore Developments Limited 3. Frogmore Estates plc	Oliver House, 19/23 Windmill Hill, Enfield
9 May 1975	1. The Churchbury Investment Company Limited 2. Hartley Cooper Group Services Limited 3. Hartley Cooper (Holdings) Limited	Wenlock House, Eaton Road, Enfield
18 November 2003	1. Abbey Business Centre Limited 2. FIGSL	Suite 5:8 The Beacon, 176 St Vincent Street, Glasgow
8 April 2002	1. GE Pensions Limited 2. GE Insurance Holdings Limited 3.FIGSL	Radcliffe House, Keynes House and Pease House, Old Charlton Road, Priory Park, Hitchin
8 April 2002	1. GE Pensions Limited 2. FIGSL 3. GE Insurance Holdings Limited	25 Car Parking Spaces at Priory Park, Hitchin
8 April 2002	1. GE Pensions Limited 2. FIGSL	88 Car Parking Spaces in the Woodland Car Park at Hitchin Conference & Banqueting Centre, Hitchin
1 2002	1. The Chartridge Conference Company Limited 2. National Mutual Life Assurance Society	The Remote Computer Room, Priory Park, Hitchin
29 September 1988	1. Britel Fund Trustees Limited 2. Consolidated Insurance Group Limited	Penne House, Sheen Road, Richmond
20 June 1988	1. Currys Group plc 2. FIGSL	Unit 6, Mowlem Trading Estate, Leaside Road, Tottenham, London N17

**SECTION II — LEASE/LICENCE TO BE GRANTED BY GELS TO FIGSL**

Document	Premises
Underlease Licence Agreement	Ground Floor and the 1st and 2nd Floors, Vantage West, Great West Road, Brentford Allocated storage space, Unit 6, Mowlem Trading Estate, Leaside Road, Tottenham, London N17

SIGNED by )  
 )  
for and on behalf of )  
FINANCIAL INSURANCE )  
GROUP SERVICES )  
LIMITED )

SIGNED by )  
 )  
for and on behalf of )  
GE LIFE SERVICES )  
LIMITED )

**CONFIDENTIAL TREATMENT REQUESTED**

**INFORMATION FOR WHICH CONFIDENTIAL TREATMENT HAS BEEN REQUESTED IS OMITTED AND NOTED WITH "\*\*\*". AN UNREDACTED VERSION OF THIS DOCUMENT HAS ALSO BEEN PROVIDED TO THE SECURITIES AND EXCHANGE COMMISSION.**

**AMENDED AND RESTATED  
INVESTMENT MANAGEMENT AND SERVICES AGREEMENT**

**BETWEEN**

**GENERAL ELECTRIC CAPITAL ASSURANCE COMPANY**

**AND**

**GE ASSET MANAGEMENT INCORPORATED**

**DATED AS OF                    2004**

**THIS AMENDED AND RESTATED INVESTMENT MANAGEMENT AND SERVICES AGREEMENT** (the "Agreement") is made and entered into as of the day of \_\_\_\_\_, 2004 (the "Effective Date"), by and between GENERAL ELECTRIC CAPITAL ASSURANCE COMPANY, an insurance company domiciled in the State of Delaware ("Client"), and GE ASSET MANAGEMENT INCORPORATED, a Delaware corporation ("Manager").

***RECITALS***

WHEREAS, Client and Manager previously entered into an investment management and services agreement (the "Original Agreement") dated as of May 1, 2002 pursuant to which Client retained Manager to provide investment management and other services for Client's investment portfolio and Manager agreed to provide those services on the terms and conditions contained in the Original Agreement; and

WHEREAS, Client and Manager now desire to amend and restate the Original Agreement in its entirety as more specifically provided below.

**NOW, THEREFORE**, in consideration of the promises and mutual covenants contained herein, Client and Manager agree as follows:

**ARTICLE I  
DEFINITIONS AND USAGE**

**1.1 Definitions.** The following capitalized terms, as used in this Agreement, have the following meanings:

"Account" shall have the meaning set forth in Section 2.1.

"Account Assets" means the assets and any unrealized income, profit or gain (or loss) from, those assets in the Account from time to time. Unless specifically described otherwise, Account Assets shall be valued at market.

"Actual Costs" shall have the meaning set forth in Article IV(b).

"Affiliate" of a Person means a Person who, directly or indirectly through one or more intermediaries, Controls or is Controlled by, or is under common Control with, such Person.

"Applicable Law" means, as applicable to each of the parties hereto, any domestic or foreign federal, state or local statute, law, ordinance or code (including, with respect to Client, the Delaware insurance code and, with respect to Manager, the Investment Advisers Act), any rules, regulations, administrative interpretations or orders issued by any Governmental Authority (including with respect to Client, the Insurance Authority

and, with respect to Manager, the SEC) pursuant to any of the foregoing, and any order, writ, injunction, directive, judgment or decree of a court of competent jurisdiction applicable to the parties hereto.

"Board" means the Board of Directors of Client as the same may be elected from time to time by the shareholders of Client.

"Budgeted Costs" shall have the meaning set forth in Article IV(a).

"Control" means, as to any Person, the power to direct or cause the direction of the management and policies of such Person, whether through the ownership of voting securities, by contract or otherwise. The terms "Controlled", "under common Control with" and "Controlling" shall have correlative meanings.

"Control Event" means, with respect to either party, the occurrence of: (a) any event which results in the Control of the party transferring from a Person that was an Affiliate immediately prior to the occurrence of such event to a Person that is not an Affiliate; (b) the sale or transfer of substantially all of a party's assets to a Person that is not an Affiliate; or (c) the merger or consolidation of a party with or into another Person and the surviving Person is not an Affiliate.

"CPR" shall have the meaning set forth in Section 8.3.

"CPR Arbitration Rules" shall have the meaning set forth in Section 8.4(a).

“Custodian” shall have the meaning set forth in Section 2.6.

“Directed Brokers” shall have the meaning set forth in Section 2.7(b)

“Directed Trades” shall have the meaning set forth in Section 2.7(b).

“Dispute” shall have the meaning set forth in Section 8.1(a).

“Effective Date” shall have the meaning set forth in the introductory paragraph.

“ERISA” means the Employee Retirement Income Security Act of 1974, as amended.

“First Extension” shall have the meaning set forth in Article III(a).

“GAAP” means generally accepted accounting principles in effect, from time to time, in the United States.

“GE” means General Electric Company, a New York corporation.

“GE Change” shall have the meaning set forth in Article III(a).

3

---

“Governmental Authority” means the SEC, the Insurance Authority or any court, tribunal, arbitrator, authority, agency, commission, official or other instrumentality of the United States or any federal, national, state, municipal, county, city or other political subdivision.

“Initial Notice” shall have the meaning set forth in Section 8.2.

“Initial Termination Date” shall have the meaning set forth in Article III(a).

“Insurance Authority” means the Delaware Department of Insurance.

“Investment Advisers Act” means the Investment Advisers Act of 1940, as amended.

“Investment Committee” means a committee directed by the Board to oversee Client’s investment activities.

“Investment Guidelines” shall mean certain guidelines and procedures concerning the investment and management of the Account Assets (and which may be specific as to any particular Account) as may be adopted from time to time by the Board or the Investment Committee all of which shall be compliant in all respects and at all times with all Applicable Law, and as may from time to time be modified or amended by the Board or the Investment Committee; provided that any such modification or amendment shall be provided by Client to Manager in writing in advance.

“Investment Objectives” shall mean any investment objectives set forth in the Investment Guidelines or otherwise communicated in writing from time to time by Client to Manager.

“Investment Reports” means statements, reports, analyses, data, summaries, calculations, formulas and the like concerning Account Assets, investment strategy, security selection and performance results, whether in written, oral or electronic form.

“Management Percentage” shall have the meaning set forth in Article IV(a).

“Original Agreement” shall have the meaning set forth in the Recitals.

“Person” means an individual, corporation, partnership, limited liability company, association, trust or any other entity or organization, including governmental or political subdivision or an agency or instrumentality thereof.

“Proposal” shall have the meaning set forth in Article IV(c).

“Records” shall have the meaning set forth in Section 2.9.

4

---

“Regulatory Change” shall have the meaning set forth in Article III(a).

“Remaining Term” shall have the meaning set forth in Article III(a).

“Representatives” means, as applicable, Client’s or Manager’s directors, officers, employees, accountants and legal and financial advisors.

“Response” shall have the meaning set forth in Section 8.2.

“SAP” means statutory accounting procedures and principles prescribed or permitted by Applicable Law.

“Second Extension” shall have the meaning set forth in Article III(a).

“SEC” means the U.S. Securities and Exchange Commission.

“SEC Termination” shall have the meaning set forth in Article III(a).

“Taxes” shall have the meaning set forth in Section 7.18(b).

“True-up” shall have the meaning set forth in Article IV(b).

**ARTICLE II  
SERVICES**

**2.1 Investment Management.** With respect to accounts and/or investment portfolios designated by Client from time to time in writing and which may include, without limitation, an account established to hold assets of Client placed into a trust or other special purpose vehicle utilized to secure performance of Client's obligations (collectively, the "Account"), Manager will provide continuous, discretionary investment management services to Client, which services may include (but not be limited to) the following:

- (a) Research and identify investment opportunities;
- (b) Open (or direct the Custodian to open) and maintain brokerage accounts for securities and other property for and in the name of Client and execute for Client, as its agent and attorney-in-fact, standard customer agreements;
- (c) Invest Account Assets in income earning investments, such as bonds and cash equivalents, and such other investments as are permitted by Applicable Law, subject to any restrictions or limitations imposed by the Investment Guidelines,

5

---

the Board or the Investment Committee, in each case, as communicated to Manager in writing;

- (d) Exercise, on behalf of Client or direct the exercise by the Custodian where appropriate, all rights and remedies conferred by any investment including, without limitation, voting rights (as discussed more fully in Section 2.8 below) with respect to the Account Assets;
- (e) Sell or dispose of investments as appropriate, subject to any restrictions or limitations imposed by the Investment Guidelines, the Board or the Investment Committee; provided, however, that the proceeds from any such sales will be deposited in the relevant Account on the date of receipt;
- (f) Assist in developing an overall investment strategy for the Account Assets; provided that in all cases Client shall have sole responsibility for approving and adopting any such strategy;
- (g) Conduct inspections, valuations, projections or other due diligence activities with respect to investments;
- (h) Negotiate the terms and conditions of investments and review and participate in the preparation of any documentation relating to such investments and execute for Client, as its agent and attorney-in-fact, such documentation;
- (i) Keep the Account under review and confer at regular intervals with Client regarding the investment and management of the Account;
- (j) Prepare a summary of all purchases and sales of investments with respect to the Account for approval and ratification by the Board or the Investment Committee not less than quarterly and more frequently if the Board or the Investment Committee so requests;
- (k) Assist with cash management and cash flow forecasting;
- (l) Participate in meetings of the Board, the Investment Committee and such other meetings with Client Representatives as Client may request from time to time;
- (m) Provide Client, in a timely manner, with such reports, documentation and information as Client may reasonably request in connection with monthly, quarterly and annual closing activities;
- (n) Provide Client with such additional investment management services relating to the Account as Client may reasonably request from time to time; and
- (o) Provide other support and analysis concerning investments, which, by way of example, may include due diligence in connection with potential business

6

---

acquisitions or dispositions by Client and its Affiliates, reinsurance transactions and capital markets structures; provided, however, such support and analysis shall be similar in scope to that which Manager has previously provided to Client and shall be consistent with the range of services provided in the normal course by Manager under this Agreement.

**2.2 [Reserved]**

**2.3 Appointment of Manager.** Client appoints Manager and Manager accepts appointment by Client as investment adviser for the Account with full discretion subject to the terms of this Agreement; provided that, and without limitation to any right or remedy of Client under this Agreement, the ultimate control of Client's accounts and/or investment portfolios shall remain with the Board, and nothing contained in this Agreement shall be deemed to transfer or delegate such control to Manager.

**2.4 Non-Exclusivity.** Manager shall perform its services described in this Agreement on a nonexclusive basis. Client shall be free to retain at any time one or more additional investment advisers to perform similar services in connection with any of its assets. Manager may give advice and take action with respect to other clients that differs from advice given or action taken with respect to the Account, so long as Manager attempts in good faith to allocate investment opportunities to Client and the Account over a period of time on a fair and equitable basis compared to investment opportunities extended to other clients. Manager is not obligated to initiate the purchase or sale of any security for Client or the Account that Manager, or its Affiliates or the respective Representatives of either of them, may purchase or sell for its or their own accounts or for the account of any other client if, in the reasonable opinion of Manager, such transaction or investment appears unsuitable or undesirable for Client or the Account.

**2.5 Covenants of Manager.**

- (a) Manager shall discharge its duties with the care, skill, prudence and diligence under the circumstances then prevailing that a prudent person, acting in a like capacity and familiar with such matters should use in the conduct of an enterprise of a like character and with like aims. Further, Manager shall use the same skill and care in the management of the Account and other duties hereunder as it uses in the administration of other similar accounts for which it has investment responsibility.
- (b) Manager shall use its commercially reasonable efforts to achieve the Investment Objectives. Notwithstanding the foregoing, Client understands that Manager makes no representation regarding its ability to achieve any Investment Objective and Manager shall have no liability hereunder for such failure provided it has otherwise complied with the terms of this Agreement.



- (c) Manager shall notify Client in writing within seven (7) business days of: (i) Manager's failure or inability to comply with any material term or provision of

---

this Agreement; (ii) any change in Manager's senior officers who exercise investment discretion in respect of the Account; (iii) any change in Manager's condition, financial or otherwise, or in its business or any other change which is reasonably likely to be materially adverse to Manager, the Account or the Account Assets; (iv) the occurrence of any happening or event which is reasonably likely to cause or has caused any breach of any representation or warranty made by Manager below and the nature and scope of the breach; (v) any threatened or actual material adverse change in the Account or nature of the Account Assets of which it is aware; (vi) if it is unable to comply with the Investment Guidelines including any change resulting from an amendment to such Investment Guidelines or any instruction or direction given by Client pursuant to this Agreement; or (vii) if an instruction, direction or guideline given by Client is: (A) in Manager's opinion, inconsistent with the Investment Guidelines; or (B) in Manager's opinion, ambiguous or unclear in any respect, and the instruction, direction or guideline must be clarified by Client.

- (d) In the performance of its duties and obligations under this Agreement, Manager shall act in conformity with the Investment Guidelines or other written instructions of the Board, the Investment Committee or Representatives of Client, in each case as supplied to Manager by Client, and all Applicable Law. At Client's request, Manager shall provide to Client certificates or other evidence of compliance relating to any Applicable Law or other legal requirements, in each case in form and substance satisfactory to Client.
- (e) Manager shall at all times maintain sufficient and knowledgeable personnel to perform the services under this Agreement.
- (f) Manager shall inform Client of, and comply with, Manager's policy regarding the receipt by Manager of all services received in connection with soft dollar commissions in relation to the investment or management of the Account.
- (g) Manager shall account to Client for any monetary benefits, fees or commissions received by Manager or any Affiliate of Manager in relation to the investment of the Account other than benefits or amounts permitted to be received in accordance with Section 2.7 and Article IV.
- (h) Manager shall exercise due care in selecting, appointing and reviewing the performance of any agent of Manager in connection with the Account or any broker engaged by Manager.
- (i) Except as otherwise disclosed in this Agreement, Manager does not have and will not have any interest, direct or indirect, which would conflict in any manner with its obligations under this Agreement.

- 2.6 Custodial Matters.** All transactions authorized by this Agreement with respect to the Account will be consummated through a custodian designated in writing by Client (the

---

"Custodian"). Manager (who shall not act as Custodian) may issue such instructions to the Custodian as may be appropriate in connection with the settlement of transactions initiated by Manager under this Agreement, either in writing or sent electronically or orally and confirmed in writing or electronically as soon as practical thereafter. Manager shall instruct all brokers, dealers or other persons executing orders on behalf of the Account to forward to the Custodian copies of all brokerage or dealer confirmations promptly after execution of all transactions. Manager shall not be authorized to take custody or possession of any Account Assets. Manager shall not be responsible for the fees of the Custodian or for any loss incurred by reason of any act or omission of the Custodian. Client may, at any time in its sole discretion, appoint one or more additional or substitute custodians to hold the Account Assets. Manager will be advised of the appointment of any substitute custodians in writing by Client.

**2.7 Brokerage Matters.**

- (a) Manager may place orders directly with brokers or dealers for executing transactions for the Account. In selecting brokers or dealers, Manager is authorized to use its discretion and may take into account such relevant factors as (i) total transaction price (including commissions, as a component of price); (ii) the broker's facilities, reliability and financial responsibility; (iii) the ability of the broker to effect the securities transaction, particularly with regard to such aspects as timing, size and execution of orders; and (iv) the research services provided by such broker to Manager (either directly or by arrangement with third parties) which may enhance Manager's general investment decision-making process, notwithstanding that the Account may not be the direct or exclusive beneficiary of such services. Specifically, Manager may pay a broker a commission in excess of the amount another broker would have charged for effecting such transaction, so long as, in the good faith judgment of Manager, the amount of the commission is reasonable in relation to the value of the brokerage and research services provided by such broker, viewed in terms of that particular transaction or Manager's overall investment management business. Client shall be responsible for the total transaction costs, including all reasonable broker's commissions with respect to transactions of the Account and all taxes or government fees, domestic or foreign, attributable to such transactions. Manager may enter into arrangements with brokers to open "average price" accounts wherein orders during a trading day are placed on behalf of Client and other clients and are allocated (along with an equivalent portion of the expenses related thereto) among the Account and the accounts of the other clients using an average price. Manager may execute any and all transactions for the Account with or through brokers or dealers that are Affiliates of Manager so long as such transactions are executed on terms no less favorable than those available from an unaffiliated broker or dealer.
- (b) Client may direct Manager to effect securities transactions for the Account ("Directed Trades") through broker-dealer(s) identified by Client in writing ("Directed Brokers") in a separate agreement acceptable to Manager. Client acknowledges that: (i) Directed Trades may not enable Client to obtain the cost

---

and execution benefits, if any, of participating in aggregated trades with other clients; and (ii) Directed Trades may be executed before or after Manager effects the execution of transactions for other accounts with the result that Client may pay or receive, as the case may be, a different price for securities which were also the subject of trades by Manager for its other clients. Client represents that Directed Trades are not prohibited by Applicable Law or Client's governing documents.

- 2.8 Exercise of Rights.** Subject to the Investment Guidelines and any other written instructions of the Board, the Investment Committee or Representatives of the Client provided to Manager, Manager shall use its best judgment to exercise or instruct the Custodian to exercise, in a manner that Manager deems to be in the best interests of Client, all voting rights, consent rights, subscription rights, conversion rights or any other rights arising in connection with any investment in the Account. Manager shall determine whether to consent to modifications of any documents governing securities held in the Account. Unless provided herein or requested in writing by Client, Manager need not forward any proxy material, consent solicitations or similar material to Client.

**2.9 Recordkeeping and Reports; Review and Inspection.**

- (a) Manager shall maintain all records, memoranda, instructions or authorizations (collectively, "Records") relating to the acquisition or disposition of securities or other investments in the Account as required by the Investment Advisers Act. Such Records will be the property of Client. On a timely basis, Manager shall make available to Client, at its administrative offices or such other location as may be designated by Client, copies or originals of such Records upon reasonable request.
- (b) All Records, both internal and external with third parties, to the extent within the control of Manager, will clearly specify the ownership interest of Client in the Account Assets.
- (c) Records relating solely to the Account and/or the Account Assets that are not maintained physically on Client's premises or in Client's care, custody and control shall be subject to review and audit at any time by Client, its Representatives, the Insurance Authority and any other Governmental Authority, or any other entity designated by Client, and Manager shall cooperate with and provide reasonable assistance to any such Person, including any auditor appointed by Client to conduct an audit of the Account. Such Records shall be maintained for the time periods and in a format required by the Investment Advisers Act. Manager shall notify Client prior to destruction of such Records (in order that Client may request transfer of such Records to Client as an alternative to destruction).
- (d) Manager shall provide to Client such other documents and information pertaining to this Agreement, the Account and/or Account Assets at such times as Client

10

may reasonably request including, but not limited to, information required to prepare reports to the Insurance Authority or any other entity designated by Client or as may be required in order for Client to comply with GAAP, SAP or Applicable Law.

- (e) Manager will cooperate fully with Client with respect to unsettled or unreconciled transactions and daily transmission of trading activity.

**2.10 Information Furnished to Manager.** Client shall furnish to Manager in a timely manner any information that Manager may reasonably request with respect to the services performed under this Agreement. In determining the requirements of Applicable Law, Manager may rely on an interpretation of law by legal counsel to Client.

### ARTICLE III TERM AND TERMINATION

- (a) This Agreement shall continue in effect for a term beginning on the Effective Date and ending on the third anniversary of the Effective Date (the "Initial Termination Date"). Not less than one (1) year prior to the Initial Termination Date, Client shall notify Manager in writing of its intent to terminate this Agreement on the Initial Termination Date or to extend this Agreement for an additional one (1) year term (the "First Extension"). If Client exercises the First Extension, Client shall, no later than the Initial Termination Date, notify Manager in writing of its intent to terminate this Agreement at the end of the First Extension or to further extend this Agreement for an additional one (1) year term (the "Second Extension"). This Agreement may only be terminated by Client (i) for any reason with one (1) year prior written notice (which notice shall specify the effective date of termination) to the Manager or (ii) immediately (A) for cause ("cause" being understood as any fraud or willful misconduct by Manager in managing the Account, Manager's material breach of this Agreement, materially deficient investment performance with respect to the Account or Manager's material or repeated non-compliance in managing the Account in accordance with the Investment Guidelines or Investment Objectives; provided that, except with respect to Manager's fraud or willful misconduct, Manager shall have thirty (30) days from notice of such material breach or non-compliance to cure the material breach or non-compliance to the reasonable satisfaction of Client in which case "cause" shall not be deemed to have occurred) or (B) upon a Control Event with respect to Client. If Client terminates this Agreement with less than one (1) year prior notice and if such termination is not for cause or due to a Control Event with respect to Client, Client will then continue to pay to Manager the lesser of (1) the unpaid balance of the Budgeted Costs (as defined in Article IV(a)) for the remaining portion of the calendar year plus the pro-rata portion of the Budgeted Costs for the following calendar year but only for the number of days which when added to the time elapsed since the giving of such notice would equal one (1) year (such remaining period, the "Remaining Term") or (2) the Actual Costs incurred by Manager for providing services under this Agreement for the Remaining Term

11

(in each case as adjusted to reflect the pro-rata portion of the True-up (as defined below) from the prior year and entire True-up for the following year, or portion thereof, if applicable). Manager shall use reasonable efforts to mitigate the incurrence of such costs and expenses. This Agreement may be terminated by Manager if the SEC suspends or withdraws Manager's investment adviser registration ("SEC Termination") or a change in Applicable Law occurs that would materially and adversely affect Manager's ability to provide services hereunder ("Regulatory Change"). Manager shall provide prompt written notice of a SEC Termination or Regulatory Change to Client and Manager shall use best efforts to extend the termination date for this Agreement to the maximum date consistent with the requirements of the SEC or the date of implementation of the Regulatory Change, as applicable, and in a manner consistent with subsection (d) of this Article III. This Agreement may be terminated by Manager (i) upon a Control Event with respect to Manager; (ii) if GE decides to dissolve Manager and commences dissolution proceedings; or (iii) if GE decides to engage other investment managers to provide substantially all advisory services to the fixed income allocation of the General Electric Pension Trust (each event a "GE Change"); provided that Manager shall give prompt written notice of a GE Change to Client and the date of termination shall occur on the later of the Initial Termination Date or one (1) year from the giving of notice of the GE Change to Client. This Agreement also shall automatically terminate in the event of its unauthorized assignment by either party. Termination in any manner shall not affect the rights of either party that accrued prior to termination.

- (b) Client acknowledges that Manager has and will continue to expend substantial fixed costs in providing services to Client and such costs would not have been incurred but for Manager providing services to Client. Furthermore, Client acknowledges that Manager has agreed to provide services hereunder for the fees noted in Article IV in part because Client has expressed a good faith intention to engage Manager for not less than three (3) years following the Effective Date. Therefore, Client acknowledges that the management fees still to be paid to Manager following a termination by Client of this Agreement for reasons other than cause or upon a Control Event with respect to Client and with less than one (1) year prior notice should not be construed as a penalty but as a reasonable approximation of the additional costs incurred by Manager due to the failure of Client to meet the parties' expectations.
- (c) Within sixty (60) days of the termination of this Agreement, Manager shall transfer all Records to Client or its designee provided that Manager shall be entitled to maintain a copy of such Records. All reasonable costs to transfer such Records shall be paid by Client.
- (d) In the event of any termination of this Agreement, Client may request that Manager continue to serve as a manager hereunder (at the then-existing compensation level) in order to assist Client in effecting a smooth and orderly transfer of services and all Records to any successor manager (which may be

12

Client); provided that such transition period shall not exceed 3 months unless otherwise agreed to by the parties. Manager shall consent to such request provided termination is not the result of a SEC Termination or Regulatory Change.

#### ARTICLE IV COMPENSATION

- (a) Subject to the provisions of this Article IV, Client agrees to pay Manager a management fee on a quarterly basis in arrears for services provided by Manager to Client pursuant to this Agreement. The management fee shall be equal to \*\* basis points (\*\*%) (the "Management Percentage") multiplied by the value of the Account Assets as of the end of the relevant calendar quarter, as determined by the Custodian's records, divided by four (4). The parties acknowledge that the initial Management Percentage has been, and the Management Percentage applicable for each calendar year thereafter will be, equal to the percentage resulting from dividing Manager's budgeted direct and indirect costs and expenses for such period (the "Budgeted Costs") as adjusted by any True-up (as defined below) for the prior year by Client's estimated aggregate Account Assets for the next calendar year, all as determined in good faith.
- (b) The parties will reestablish the Management Percentage for each calendar year in accordance with the following process; provided, however, that if the Management Percentage for such period exceeds by more than ten percent (10%) the Management Percentage applicable during the prior calendar year or portion thereof, such increase shall be submitted to the Insurance Authority for prior approval. By each September 15, Client shall provide Manager with a provisional forecast of Client's Account Assets for the following calendar year together with an outline of any significant changes that Client proposes to implement to its investment strategy during the following calendar year. By each October 1, Manager shall provide Client with a detailed budget setting forth the expected Budgeted Costs to be incurred by Manager in order to provide services to Client for the following calendar year along with reasonable documentation in support of such budget (collectively, the "Proposal"). Client shall promptly review the Proposal and shall accept or reject the Proposal, in Client's reasonable discretion, by no later than November 1; provided, however, if Client rejects the Proposal it shall provide Manager with a written explanation for such rejection. If Client rejects the Proposal, Client and Manager will work in good faith to resolve all issues so that the Proposal is acceptable to both parties no later than December 1. As promptly as possible, but in no event later than January 15 of each year, Client shall provide Manager its final forecast of Account Assets for the calendar year and any significant changes to Client's investment strategy that Client proposes to implement during the calendar year. Within five (5) business days following receipt of such information, Manager shall calculate the difference between the management fees paid or payable by Client to Manager for the prior year under this Agreement (and under the Original Agreement for the portion of 2004 that

13

---

such agreement remained in effect) and Manager's actual direct and indirect costs and expenses of providing services ("Actual Costs") during such period (such difference is referred to as the "True-up") and shall provide the True-up and proposed Management Percentage to Client. The calculation of any True-up shall not give effect to fees received by Manager or reductions in fees otherwise owed to Manager as a result of a prior True-up. The True-up shall be added to or subtracted from, as applicable, the Budgeted Costs set forth in the approved Proposal and shall be reflected in the Management Percentage established for the following calendar year. If Manager is entitled to the benefit of the True-up because Actual Costs exceeded Budgeted Costs, the True-up added to Budgeted Costs for the following calendar year shall be the lesser of the actual True-up or an amount equal to 10% of Budgeted Costs for the prior calendar year; provided however, that any Actual Costs that were not included in the approved Proposal for the year but were previously approved in writing by Client in consultation with Manager during such year shall not be included when applying the 10% cap. The Manager shall provide Client with reasonable back-up documentation supporting Manager's calculation of the True-up. Client shall approve or reject the True-Up and the Management Percentage not later than five (5) business days after receipt thereof from Manager. The Management Percentage shall be implemented as if it were effective as of the prior January 1. If the parties are unable to agree on a revised Proposal, the True-up or the Management Percentage, the then existing Management Percentage shall remain in effect until the parties agree on a revised Proposal and True-up. If the parties are unable to agree on the Proposal, the Management Percentage and the True-up by February 15, the Budgeted Costs and Management Percentage (which shall reflect the True-up) shall be established pursuant to the Arbitration process described in Article VIII of this Agreement. Both parties understand that time is of the essence with respect to this subsection. For purposes of all dates set forth in this subsection, if such date is not a business day, then such date shall be deemed to be the next calendar day that is a business day.

- (c) Manager shall submit to Client within thirty (30) days following each calendar quarter, a written statement of the amount owed by Client for the previous quarter. Client shall pay Manager undisputed amounts within thirty (30) days following receipt of such statement.

#### ARTICLE V CONFIDENTIALITY

Subject to the duty of Manager or Client to comply with Applicable Law, each party hereto shall treat as confidential all information with respect to the other party received pursuant to this Agreement. No party shall use or disclose the other party's confidential information except as contemplated by this Agreement.

Manager shall establish and maintain reasonable procedures to keep Investment Reports, the information supplied by Client to Manager for the Investment Reports and other non-public

14

---

information provided hereunder confidential and to prevent disclosure or distribution to any Person other than to Client's Representatives or to Manager's Representatives or Manager's service providers who have a reasonable need to know or have access to such information in connection with providing services hereunder; provided that Manager may include information from such Investment Reports when presenting Manager's performance as long as Client is not identified as the source of such information. Manager will be responsible for compliance with the terms of this Article V by its Representatives.

Investment Reports provided by Manager to Client are privileged and may include proprietary information. Investment Reports will be used solely for the purpose of monitoring and evaluating the performance of the Account and for use by Client in testing the Account Assets for regulatory compliance and similar purposes. Client shall establish and maintain reasonable procedures to keep Investment Reports confidential and to prevent disclosure or distribution to any Person other than to Client's Representatives who have a reasonable need to know or have access to such Investment Reports in connection with the receipt of services hereunder. Client will be responsible for compliance with the terms of this Article V by its Representatives.

Each party hereto will obtain the other party's approval before sending or making available any Investment Report to third parties. If a party is required by Applicable Law or requested (by legal process, civil investigative demand or similar process) to disclose any confidential information of the other party, the party being required or requested to make such disclosure will promptly notify the other party so that the other party may seek an appropriate protective order or waive compliance with this confidentiality covenant.

#### ARTICLE VI REPRESENTATIONS AND WARRANTIES

6.1 **By Client.** Client represents and warrants that:

- (a) It is an insurance company duly organized, validly existing and in good standing under the laws of Delaware and has the power and authority (including approval from the Insurance Authority, if required) to execute, deliver and perform this Agreement;
- (b) This Agreement is the valid and binding obligation of the Client enforceable against it in accordance with its terms, except as enforceability may be limited by bankruptcy, insolvency, moratorium or other similar laws affecting creditors' rights generally or by the principles governing the availability of equitable remedies; and
- (c) Except as set forth on Schedule 6.1 attached hereto, none of the Account Assets are "plan assets" within the meaning of ERISA and if any Account Assets ever become "plan assets" within the meaning of ERISA, Client will immediately so notify Manager.

15

---

**6.2 By Manager.** Manager represents and warrants that:

- (a) It is a corporation duly organized, validly existing and in good standing under the laws of Delaware, has the power and authority to carry on the business of an investment adviser, and has the power and authority to execute, deliver and perform this Agreement;
- (b) This Agreement is the valid and binding obligation of Manager enforceable against it in accordance with its terms, except as enforceability may be limited by bankruptcy, insolvency, moratorium or other similar laws affecting creditors' rights generally or by the principles governing the availability of equitable remedies;
- (c) Other than approval from the Insurance Authority, if any, it has made, obtained and performed all other registrations, filings, approvals, authorizations, consents, licenses or examinations required by any government or governmental or quasi-governmental authority, domestic or foreign, or required by any other person, corporation or other entity in order to execute, deliver and perform this Agreement and to be an investment adviser;
- (d) Neither the execution and delivery nor the performance of this Agreement by Manager will violate any law, statute, order, rule or regulation or judgment, order or decree by any federal, state, local or foreign court or governmental authority, domestic or foreign, to which Manager is subject nor will the same constitute a breach of, or default under, provisions of any agreement or contract to which it is a party or by which it is bound;
- (e) It is registered as an investment adviser under the Investment Advisers Act and has at least 48 hours prior to entering into this Agreement furnished to Client a true and complete copy of Part II of its most recent Form ADV; and since the date of such Form ADV, there has not been, occurred or arisen any material adverse change in the financial condition or in the business of Manager or any event, condition, or state of facts which materially and adversely affects, or to its knowledge threatens to materially affect, the business or financial condition of Manager; and
- (f) In terms of intellectual property, it is the sole owner of all right, title and interest in and to the intellectual property used by it to perform its obligations hereunder or, to its knowledge, possesses all appropriate rights to use the intellectual property; has not sold, granted, conveyed, licensed or assigned to any third party, or in any way encumbered, the intellectual property in a manner that interferes with Manager's obligations under this Agreement; and the intellectual property used by Manager does not to Manager's knowledge infringe the rights of any third party.

16

---

**ARTICLE VII  
MISCELLANEOUS**

- 7.1 Limitation of Liability.** In furnishing Client with services as provided herein, neither Manager nor any officer, director or agent thereof shall be held liable to Client, its creditors or the holders of its securities for good faith errors of judgment or for anything except willful misfeasance, bad faith or gross negligence in the performance of its duties, or reckless disregard of its obligations and duties under the terms of this Agreement. It is further understood and agreed that Manager may rely upon information furnished to it by Client that Manager reasonably believes to be accurate and reliable. Certain federal laws, including federal securities laws, impose liabilities under certain circumstances on persons who act in good faith and therefore nothing contained herein shall in any way constitute a waiver or limitation of any rights that Client may have under any such federal laws.
- 7.2 Indemnification.**
- (a) Notwithstanding any limitation of liability contained in Section 7.1, Manager shall indemnify and hold Client harmless from and against any losses, damages, expenses (including reasonable attorneys' fees), liabilities, penalties, demands and claims of any nature whatsoever with respect to or arising out of Manager's breach or violation of any agreement, covenant, representation or warranty made by Manager herein.
  - (b) Client shall indemnify and hold Manager harmless from and against any losses, damages, expenses (including reasonable attorneys' fees), liabilities, penalties, demands and claims of any nature whatsoever with respect to or arising out of Client's breach or violation of any agreement, covenant, representation or warranty made by Client herein.
- 7.3 Assignment.** No assignment (by operation of law or otherwise) of this Agreement, in whole or in part, nor any of the rights, interests or obligations under this Agreement by either party shall be effective without the prior written consent of the other party and the Insurance Authority. For purposes of this section, the term "assignment" with respect to Manager as assignor shall have the same meaning as defined in Section 202 of the Investment Advisers Act. Subject to the provisions of this Section 7.3, this Agreement shall be binding upon, inure to the benefit of, and be enforceable by the parties and their respective successors and permitted assigns.
- 7.4 Independent Contractor.** Manager shall be deemed to be an independent contractor and, except as expressly provided or authorized in this Agreement, shall have no authority to act for or represent Client. Client shall always retain the ultimate authority to make investment decisions on its own behalf.
- 7.5 [Reserved]**
- 7.6 Specimen Signatures.** From time to time, Client shall provide Manager with a certificate setting forth the names and specimen signatures of the Representatives who are

17

---

authorized to act on behalf of Client (including, but not limited to, the Investment Committee). From time to time, Manager will provide Client with a certificate setting forth the names and specimen signatures of the Representatives who are authorized to act on behalf of Manager. The parties hereto shall be fully protected in relying upon any written notice, instruction, direction or other communication (based upon the most recent certificate that has been received by the party) which is

reasonably believed to have been executed by an individual who is authorized to act on behalf of the other party.

7.7 [Reserved]

7.8 [Reserved]

7.9 **Advertising and Promotion.** A party shall not engage in any advertising or promotional activity that refers to the other party without receiving the written consent of the other party prior to publication or announcement. Manager shall however be entitled to disclose Client's name and the size of the Account Assets in client listings and other similar material.

7.10 **Governing Law.** This Agreement shall be governed by the laws of the State of Delaware, without giving effect to its conflict of laws principles.

7.11 **Notices.** Any notice under this Agreement shall be given in writing, addressed, and delivered, or mailed postpaid, to the party to this Agreement entitled to receive such, at such party's principal place of business as set out here:

18

---

Manager:

General Counsel  
GE Asset Management Incorporated  
3003 Summer Street  
Stamford, CT 06905

Client:

General Counsel  
General Electric Capital Assurance Company  
6620 W. Broad Street  
Richmond, Virginia 23230

or to such other address as either party may designate in writing mailed to the other. Whenever any notice is required to be given hereunder, such notice shall be deemed given and such requirement satisfied only when such notice is delivered, or, if mailed, when received unless otherwise permitted by the terms hereof.

7.12 **Severability.** Any provision of this Agreement which is prohibited or unenforceable in any jurisdiction shall, as to such jurisdiction, be ineffective to the extent of such prohibition or unenforceability without invalidating the remaining provisions hereof, and any such prohibition or unenforceability in any jurisdiction shall not invalidate or render unenforceable such provision in any other jurisdiction.

7.13 **Amendments.** No term or provision of this Agreement may be amended, waived, discharged or terminated orally, but only by an instrument in writing signed by both parties.

7.14 **Electronic Notices, Waivers and Amendments.** For purposes of providing notices required or permitted by this Agreement, waiving any right under this Agreement, or amending any term of this Agreement and notwithstanding any law recognizing electronic signatures or records, "a writing signed," "in writing" and words of similar meaning, shall mean only a writing in a tangible form bearing an actual "wet" signature in ink manually applied by the person authorized by the respective party, unless both parties agree otherwise by making a specific reference to this section.

7.15 **Entire Agreement.** This Agreement supersedes any and all oral or written agreements or understandings heretofore made, and contains the entire agreement of the parties, with respect to the subject matter hereof.

7.16 **Counterparts.** This Agreement may be executed in one or more counterparts, and such counterparts together shall constitute one and the same agreement.

7.17 **Additional Parties.** Insurance company Affiliates of Genworth Financial, Inc. may become party to and bound by the provisions of this Agreement subject only to executing

19

---

the Adoption Agreement attached hereto as Exhibit I and obtaining any necessary regulatory approvals. Each such additional insurance company becoming a party to this Agreement shall be deemed a "Client" hereunder. If and when the Agreement involves two or more Clients, any one Client may terminate this Agreement, but only with respect to such Client's participation in the Agreement, in accordance with Article III.

7.18 **Taxes.**

- (a) Each party shall be responsible for any personal property taxes on property it owns or leases, for franchise and privilege taxes on its business, and for taxes based on its net income or gross receipts.
- (b) Client may report and (as appropriate) pay any sales, use, excise, value-added, services, consumption, and other taxes and duties ("Taxes") directly if Client provides Manager with a direct pay or exemption certificate.
- (c) The parties agree to cooperate with each other to enable each to more accurately determine its own tax liability and to minimize such liability to the extent legally permissible. Manager's invoices shall separately state the amounts of any Taxes Manager is proposing to collect from Client.
- (d) Manager shall promptly notify Client of any claim for Taxes asserted by applicable taxing authorities for which Client is alleged to be financially responsible hereunder. Manager shall coordinate with Client the response to and settlement of, any such claim. Notwithstanding the above, Client's liability for such Taxes is conditioned upon Manager providing Client notification within twenty (20) business days of receiving any proposed assessment of any additional Taxes, interest or penalty due by Manager.
- (e) Client shall be entitled to receive and to retain any refund of Taxes paid to Manager pursuant to this Agreement. In the event Manager shall be entitled to receive a refund of any Taxes paid by Client to Manager, Manager shall promptly pay, or cause the payment of, such refund to Client.

## 8.1 General Provisions.

- (a) Any dispute, controversy or claim arising out of or relating to this Agreement or the validity, interpretation, breach or termination thereof (a "Dispute"), shall be resolved in accordance with the procedures set forth in this Article VIII, which shall be the sole and exclusive procedures for the resolution of any such Dispute unless otherwise specified below.

20

---

- (b) Commencing with a request contemplated by Section 8.2 set forth below, all communications between the parties or their representatives in connection with the attempted resolution of any Dispute, including any mediator's evaluation referred to in Section 8.3 set forth below, shall be deemed to have been delivered in furtherance of a Dispute settlement and shall be exempt from discovery and production, and shall not be admissible in evidence for any reason (whether as an admission or otherwise), in any arbitral or other proceeding for the resolution of the Dispute.
- (c) Except as provided in Section 8.1(f) in connection with any Dispute, the parties expressly waive and forego any right to (i) punitive, exemplary, statutorily-enhanced or similar damages in excess of compensatory damages, and (ii) trial by jury.
- (d) The specific procedures set forth below, including but not limited to the time limits referenced therein, may be modified by agreement of the parties in writing.
- (e) All applicable statutes of limitations and defenses based upon the passage of time shall be tolled while the procedures specified in this Article VIII are pending. The parties will take such action, if any, required to effectuate such tolling.
- (f) The parties hereto hereby irrevocably submit to the exclusive jurisdiction of any federal or state court located within the State of Delaware over any such Dispute and each party hereby irrevocably agrees that all claims in respect of any such Dispute or any suit, action proceeding related thereto may be heard and determined in such courts. The parties hereby irrevocably waive, to the fullest extent permitted by Applicable Law any objection which they may now or hereafter have to the laying of venue of any such Dispute brought in such court or any defense of inconvenient forum for the maintenance of such dispute. Each of the parties hereto agrees that a judgment in any such Dispute may be enforced in other jurisdictions by suit on the judgment or in any other manner provided by Applicable Law.

- 8.2 Consideration by Senior Executives.** If a Dispute is not resolved in the normal course of business at the operational level, the parties shall attempt in good faith to resolve such Dispute by negotiation between executives who hold, at a minimum, the office of President and CEO of the respective business entities involved in such Dispute. Either party may initiate the executive negotiation process by providing a written notice to the other (the "Initial Notice"). Fifteen (15) days after delivery of the Initial Notice, the receiving party shall submit to the other a written response (the "Response"). The Initial Notice and the Response shall include (i) a statement of the Dispute and of each party's position, and (ii) the name and title of the executive who will represent that party and of any other person who will accompany the executive. Such executives will meet in person or by telephone within thirty (30) days of the date of the Initial Notice to seek a resolution of the Dispute.

21

---

- 8.3 Mediation.** If a Dispute is not resolved by negotiation as provided in Section 8.2 within forty-five (45) days from the delivery of the Initial Notice, then either party may submit the Dispute for resolution by mediation pursuant to the CPR Institute for Dispute Resolution (the "CPR") Model Mediation Procedure as then in effect. The parties will select a mediator from the CPR Panels of Distinguished Neutrals. Either party at commencement of the mediation may ask the mediator to provide an evaluation of the Dispute and the parties' relative positions.

## 8.4 Arbitration

- (a) If a Dispute is not resolved by mediation as provided in Section 8.3 within thirty (30) days of the selection of a mediator (unless the mediator chooses to withdraw sooner), either party may submit the Dispute to be finally resolved by arbitration pursuant to the CPR Rules for Non-Administered Arbitration as then in effect (the "CPR Arbitration Rules"). The parties consent to a single, consolidated arbitration for all known Disputes existing at the time of the arbitration and for which arbitration is permitted.
- (b) The neutral organization for purposes of the CPR Arbitration Rules will be the CPR. The arbitral tribunal shall be composed of three arbitrators, of whom each party shall appoint one in accordance with the "screened" appointment procedure provided in Rule 5.4 of the CPR Arbitration Rules. The arbitration shall be conducted in New York City. Each party shall be permitted to present its case, witnesses and evidence, if any, in the presence of the other party. A written transcript of the proceedings shall be made and furnished to the parties. The arbitrators shall determine the Dispute in accordance with the law of State of Delaware, without giving effect to any conflict of law rules or other rules that might render law inapplicable or unavailable, and shall apply this Agreement according to its terms, provided that the provisions relating to arbitration shall be governed by the Federal Arbitration Act, 9 U.S.C. § 1 et seq.
- (c) The parties agree to be bound by any award or order resulting from any arbitration conducted in accordance with this Section 8.4 and further agree that judgment on any award or order resulting from an arbitration conducted under this Section 8.4 may be entered and enforced in any court having jurisdiction thereof.
- (d) Except as expressly permitted by this Agreement, no party will commence or voluntarily participate in any court action or proceeding concerning a Dispute, except (i) for enforcement as contemplated by Section 8.4(c) above, (ii) to restrict or vacate an arbitral decision based on the grounds specified under Applicable Law, or (iii) for interim relief as provided in paragraph (e) below. For purposes of the foregoing, the parties hereto submit to the non-exclusive jurisdiction of the courts of State of Delaware.
- (e) In addition to the authority otherwise conferred on the arbitral tribunal, the tribunal shall have the authority to make such orders for interim relief, including

22

---

injunctive relief, as it may deem just and equitable. Notwithstanding Section 8.4(d) above, each party acknowledges that in the event of any actual or threatened breach of Article V, the remedy at law would not be adequate, and therefore injunctive or other interim relief may be sought immediately to restrain such breach. If the tribunal shall not have been appointed, either party may seek interim relief from a court having jurisdiction if the award to which the applicant may be entitled may be rendered ineffectual without such interim relief. Upon appointment of the tribunal following any grant of interim relief by a court, the tribunal may affirm or disaffirm such relief, and the parties will seek modification or rescission of the court action as necessary to accord with the tribunal's decision.

- (f) Each party will bear its own attorneys' fees and costs incurred in connection with the resolution of any Dispute in accordance with this Article VIII.

IN WITNESS WHEREOF, the parties hereto have caused this instrument to be duly executed by their respective officers thereunto duly authorized as of the day and year first above written.

GE ASSET MANAGEMENT INCORPORATED

By: \_\_\_\_\_  
Name: \_\_\_\_\_  
Title: \_\_\_\_\_

GENERAL ELECTRIC CAPITAL  
ASSURANCE COMPANY

By: \_\_\_\_\_  
Name: \_\_\_\_\_  
Title: \_\_\_\_\_

**SCHEDULE 6.1**

**PLAN ASSETS**

None.

**EXHIBIT 1**

**ADOPTION AGREEMENT**

**(AMENDED AND RESTATED INVESTMENT MANAGEMENT AND SERVICES AGREEMENT)**

By executing this Adoption Agreement, the undersigned corporation, an insurance company Affiliate of General Electric Capital Assurance Company, hereby adopts and agrees to be bound by the terms and provisions of the Amended and Restated Investment Management and Services Agreement between GE Asset Management Incorporated and General Electric Capital Assurance Company dated as of \_\_\_\_\_, 2004 (the "Agreement"), as provided in Section 7.17 of the Agreement.

This Adoption Agreement shall become effective on the date executed unless otherwise noted.

[Name and Address of Corporation]

By:  
Name:  
Title:  
Date:

DATED \_\_\_\_\_, 2004

INVESTMENT MANAGEMENT AGREEMENT

Between

FINANCIAL ASSURANCE COMPANY LIMITED

-and-

GE ASSET MANAGEMENT LIMITED

CONFIDENTIAL TREATMENT REQUESTED

CONFIDENTIAL TREATMENT REQUESTED: INFORMATION FOR WHICH CONFIDENTIAL TREATMENT HAS BEEN REQUESTED IS OMITTED AND IS NOTED WITH "\*\*\*". AN UNREDACTED VERSION OF THIS DOCUMENT HAS BEEN FILED SEPARATELY WITH THE SECURITIES AND EXCHANGE COMMISSION.

This INVESTMENT MANAGEMENT AGREEMENT (this "Agreement"), made the \_\_\_\_\_ day of \_\_\_\_\_ 2004.

BETWEEN:

(1) FINANCIAL ASSURANCE COMPANY LIMITED (Registered Number 1044679) whose registered office is at Vantage West, Great West Road, Brentford, Middlesex TW8 9AG (the "Customer"); and

(2) GE ASSET MANAGEMENT LIMITED (Registered Number 3084561) whose registered office is at 6 Agar Street, London, WC2N 4HR (the "Investment Manager").

WHEREAS:

- (A) The Customer wishes the Investment Manager to provide it with investment management services and the Investment Manager has agreed to do so on the terms and subject to the conditions contained in this Agreement.
- (B) The Investment Manager is authorised and regulated by the FSA (as defined below) and has the appropriate Part IV permission under the FSMA (as defined below) to provide the Services (as defined below) and nothing in this Agreement shall exclude any liability of the Investment Manager to the Customer arising under the FSMA or the FSA Rules (as defined below) as modified or re-enacted or both from time to time.
- (C) The Investment Manager is registered as an investment adviser under the Investment Advisers Act (as defined below).
- (D) The Investment Manager is treating the Customer as a Market Counterparty as defined in the FSA Rules.

IT IS AGREED:

ARTICLE I  
DEFINITIONS AND USAGE

1. **Interpretation.**

1.1 In this Agreement the following expressions shall have the following meanings:

"Account" shall have the meaning ascribed to it in clause 2.1.

"Account Assets" means the assets and any unrealized income, profit or gain (or loss) from those assets in the Account from time to time. Unless specifically described otherwise, Account Assets shall be valued at market.

"Actual Costs" shall have the meaning ascribed to it in clause 4(b).

"Applicable Requirements" means all applicable laws and regulations (including with respect to the Customer, the FSMA to the extent applicable to an insurance company and, with respect to the Investment Manager, the Investment Advisers Act and the FSMA to the extent applicable to an investment manager) and, if applicable, the prevailing rules, regulations, requirements, determinations, practice and guidelines of the Board of Inland Revenue of the United Kingdom, or any other governmental, market or regulatory authority (including with respect to the Customer, the FSA and with respect to the Investment Manager, the SEC (as long as the

Investment Manager is registered as an investment adviser with the SEC) and the FSA), in each case for the time being in force.

"Associate" in this Agreement has the meaning ascribed to it in the FSA Rules.



“**Board**” means the board of directors from time to time of the Customer.

“**Brokers**” means dealers, brokers, agents or other similar persons selected by the Investment Manager in its discretion through whom dealings for the Account shall be effected.

“**Budgeted Costs**” shall have the meaning ascribed to it in clause 4(a).

“**Control**” means, as to any Person, the power to direct or cause the direction of the management and policies of such Person, whether through the ownership of voting securities, by contract or otherwise. The terms “Controlled”, “under common Control with” and “Controlling” shall have correlative meanings.

“**Control Event**” means, with respect to either party, the occurrence of: (a) any event which results in the Control of the party transferring from a Person that was an Associate immediately prior to the occurrence of such event to a Person that is not an Associate; (b) the sale or transfer of substantially all of a party’s assets to a Person that is not an Associate; or (c) the merger or consolidation of a party with or into another Person and the surviving Person is not an Associate.

“**CPR**” shall have the meaning set forth in Section 9.3.

“**CPR Arbitration Rules**” shall have the meaning set forth in Section 9.4.

“**Custodian**” shall have the meaning ascribed to it in clause 2.5.

“**Custody Agreement**” shall have the meaning ascribed to it in clause 2.5.

“**Directed Brokers**” shall have the meaning ascribed to it in clause 2.4(c).

“**Directed Trades**” shall have the meaning ascribed to it in clause 2.4(c).

“**Dispute**” shall have the meaning set forth in Section 9.1(a).

“**Effective Date**” means the date of this Agreement.

“**First Extension**” shall have the meaning ascribed to it in clause 3(a).

“**FSA**” means the Financial Services Authority.

“**FSA Rules**” means the designated rules made, from time to time, by the FSA under and in accordance with the FSMA, including under the FSA Handbook of Rules and Guidance.

“**FSA Termination**” shall have the meaning ascribed to it in clause 3(e)(i).

“**FSMA**” means the Financial Services and Markets Act 2000, as amended.

“**GAAP**” means generally accepted accounting principles in effect, from time to time, in the United States and/or in the United Kingdom as applicable, including all applicable SEC requirements.

“**GE**” means General Electric Company, a New York corporation.

“**GE Change**” shall have the meaning ascribed to it in clause 3(e)(iii).

“**Initial Notice**” shall have the meaning set forth in Section 9.2.

“**Initial Termination Date**” shall have the meaning ascribed to it in clause 3(a).

“**Investment Advisers Act**” means the United States Investment Advisers Act of 1940, as amended.

“**Investment Committee**” means a committee appointed by the Board to oversee the Customer’s investment activities.

“**Investment Guidelines**” shall mean certain guidelines and procedures concerning the investment and management of the Account Assets (and which may be specific as to any particular Account) as may be adopted from time to time by the Board or the Investment Committee and which shall in all respects and at all times be compliant with all Applicable Requirements, a copy of which will be delivered to Investment Manager upon execution of this Agreement and from time to time thereafter as the same may be modified or amended by the Board or the Investment Committee; provided that any such modification shall be provided by the Customer to the Investment Manager in writing in advance.

“**Investment Objectives**” shall mean any investment objectives set forth in the Investment Guidelines or otherwise communicated in writing from time to time by the Customer to the Investment Manager.

“**Investment Reports**” means statements, reports, analyses, data, summaries, calculations, formulas and the like concerning Account Assets, investment strategy, security selection and performance results, whether in written, oral or electronic form.

“**Losses**” shall have the meaning ascribed to it in clause 8.2(c).

“**Management Percentage**” shall have the meaning ascribed to it in clause 4(a).

“**Person**” means an individual, corporation, partnership, limited liability company, association, trust or any other entity or organization, including governmental or political subdivision or an agency or instrumentality thereof

“**Proposal**” shall have the meaning ascribed to it in clause 4(c).

“**Records**” shall have the meaning ascribed to it in clause 2.7(a).

“**Regulatory Change**” shall have the meaning ascribed to it in clause 3(e)(ii).

“**Remaining Term**” shall have the meaning ascribed to in clause 3(d).

“**Representatives**” means, as applicable, the Customer’s or the Investment Manager’s directors, officers, employees, agents, auditors, delegates, sub-contractors and legal and financial advisors.

“**Response**” shall have the meaning set forth in Section 9.2.

“**SAP**” means statutory accounting procedures and principles prescribed or permitted by Applicable Requirements.

“**SEC**” means the United States Securities and Exchange Commission.

“**Second Extension**” shall have the meaning ascribed to it in clause 3(b).

“**Securities Valuation Date**” shall have the meaning ascribed to it in clause 2.9(b).

“**Services**” shall have the meaning as described in clause 2.1.

“**True-up**” shall have the meaning ascribed to it in clause 4(b).

1.2 **Headings.** The headings contained in this Agreement are for reference purposes only and shall not affect the meaning or interpretation of this Agreement.

1.3 **Exhibits.** The Exhibits to this Agreement shall be regarded as incorporated into, and forming part of, this Agreement.

## ARTICLE II SERVICES

### 2.1 **Appointment as Investment Manager.**

The Customer appoints the Investment Manager and the Investment Manager accepts appointment by the Customer as investment adviser for the Account with full discretion subject to the terms of this Agreement; provided that, and without limitation to any right or remedy of the Customer under this Agreement, the ultimate control of the Customer’s accounts shall remain with the Board, and nothing contained in this Agreement shall be deemed to transfer or delegate such control to the Investment Manager. The Investment Manager, acting in good faith and with due diligence will provide continuous discretionary investment management services (“**Services**”) to the Customer, which services may include (but not limited to) the following:

- (a) Research and identify investment opportunities;
- (b) Open (or direct the Custodian to open) and maintain brokerage accounts for securities and other property for and in the name of the Customer and execute for the Customer, as its agent and attorney-in-fact, standard customer agreements;
- (c) Invest Account Assets in income earning investments, such as bonds and cash equivalents, and such other investments as are permitted by Applicable Requirements, subject to any restrictions or limitations imposed by the Investment Guidelines, the Board or the Investment Committee, in each case, as communicated to the Investment Manager in writing;
- (d) Exercise, on behalf of the Customer or direct the exercise by the Custodian where appropriate, all rights and remedies conferred by any investment including, without limitation, voting rights (as set out in clause 2.6 below) with respect to the Account Assets;
- (e) Sell or dispose of investments as appropriate, subject to any restrictions or limitations imposed by the Investment Guidelines, the Board or the Investment Committee; provided, however, that the proceeds from any such sales will be deposited in the relevant Account on the date of receipt;
- (f) Assist in developing an overall investment strategy for the Account Assets; provided that in all cases the Customer shall have sole responsibility for approving and adopting any such strategy;
- (g) As requested by the Customer, conduct inspections, valuations, projections or other due diligence activities with respect to investments;
- (h) Negotiate the terms and conditions of investments and review and participate in the preparation of any documentation relating to such investments and execute for the Customer, as its agent and attorney-in-fact, such documentation;

- (i) Keep the Account under review and confer at regular intervals with the Customer regarding the investment and management of the Account;
- (j) Prepare a summary of all purchases and sales of investments with respect to the Account for approval and ratification by the Board or the Investment Committee not less than quarterly and more frequently if the Board or the Investment Committee so requests;
- (k) Assist with cash management and cash flow forecasting;
- (l) Participate in meetings of the Board, the Investment Committee and such other meetings with Customer Representatives as the Customer may request from time to time;
- (m) Provide the Customer, in a timely manner, with such reports, documentation and information as the Customer may reasonably request in connection with monthly, quarterly and annual closing activities;
- (n) Provide the Customer with such additional investment management services relating to the Account as the Customer may reasonably request from time to time; and
- (o) Provide other support and analysis concerning investments, which, by way of example, may include due diligence in connection with potential business acquisitions or dispositions by the Customer and its Associates, reinsurance transactions and capital markets structures; provided, however, such support and

analysis shall be similar in scope to that which Financial Insurance Group Services Limited had previously provided to the Customer and shall be consistent with the range of Services provided in the normal course by the Investment Manager under this Agreement.

- 2.2 **Non-Exclusivity.** The Investment Manager shall perform the Services on a nonexclusive basis. The Customer shall be free to retain at any time one or more additional investment advisers to perform similar services in connection with any of its assets. The Investment Manager may give advice and take action with respect to other customers that differs from advice given or action taken with respect to the Account, so long as the Investment Manager attempts in good faith to allocate investment opportunities to the Customer and the Account over a period of time on a fair and equitable basis compared to investment opportunities extended to other customers. The Investment Manager is not obligated to initiate the purchase or sale of any security for the Customer or the Account that the Investment Manager, its Associates or the respective Representatives of either of them may purchase or sell for its or their own accounts or for the account of any other customer if, in the reasonable opinion of the Investment Manager, such transaction or investment appears unsuitable or undesirable for the Customer or the Account.

2.3 **Covenants of the Investment Manager.**

During the term of this Agreement:

- (a) The Investment Manager shall discharge its duties with the care, skill, prudence and diligence under the circumstances then prevailing that a prudent person, acting in a like capacity and familiar with such matters should use in the conduct of an enterprise of a like character and with like aims. Further, the Investment Manager shall use the same skill and care in the management of the Account and other duties hereunder as it uses in the administration of other similar accounts for which it has investment

---

5

responsibility. The Investment Manager shall at all times comply with its applicable duties under the FSA Rules.

- (b) The Investment Manager shall use its commercially reasonable efforts to achieve the Investment Objectives. Notwithstanding the foregoing the, Customer understands that the Investment Manager makes no representation regarding its ability to achieve any Investment Objective and the Investment Manager shall have no liability hereunder for such failure provided it has otherwise complied with the terms of this Agreement.
- (c) The Investment Manager shall notify the Customer in writing within seven (7) business days of the Investment Manager becoming aware of: (i) the Investment Manager's failure or inability to comply with any material term or provision of this Agreement; (ii) any change in the Investment Manager's senior officers who exercise investment discretion in respect of the Account; (iii) any change in the Investment Manager's condition, financial or otherwise or in its business or any other change which is reasonably likely to be materially adverse to the Investment Manager, the Account or the Account Assets; (iv) the occurrence of any happening or event which is reasonably likely to cause or has caused any breach of any representation or warranty made by the Investment Manager in Article VI and the nature and scope of the breach; (v) any threatened or actual material adverse change in the Account or nature of the Account Assets of which it is aware; (vi) its inability to comply with any part of the Investment Guidelines including any change resulting from an amendment to such Investment Guidelines or any instruction or direction given by the Customer pursuant to this Agreement; (vii) an instruction, direction or guideline given by the Customer that is: (A) in the Investment Manager's opinion, inconsistent with the Investment Guidelines; or (B) in the Investment Manager's opinion, ambiguous or unclear in any respect, and the instruction, direction or guideline must be clarified by the Customer; (viii) a breach of any FSA Rule, which breach will or is expected to have a material adverse effect on the Investment Manager's ability to provide the Services; or (ix) actual or potential non-routine investigation by the FSA or any other regulator into the Investment Manager's condition, financial or otherwise or in its business or any actual or threatened withdrawal or suspension of any of the Investment Manager's authorisations, permission or licences necessary to provide the Services.
- (d) In the performance of its duties and obligations under this Agreement, the Investment Manager shall act in conformity with the Investment Guidelines or other written instructions of the Board, the Investment Committee or Representatives of the Customer, in each case as supplied to the Investment Manager by the Customer, and all Applicable Requirements. At the Customer's request, the Investment Manager shall provide to the Customer certificates or other evidence of compliance relating to any Applicable Requirements or other legal requirements, in each case in form and substance satisfactory to the Customer.
- (e) The Investment Manager shall at all times maintain sufficient and knowledgeable personnel to perform the Services.
- (f) The Investment Manager shall inform the Customer of, and comply with, the Investment Manager's policy regarding the receipt by the Investment Manager of all services received in connection with soft dollar commissions in relation to the investment or management of the Account.
- (g) The Investment Manager shall account to the Customer for any monetary benefits, fees or commissions received by the Investment Manager or any Associate of the Investment Manager in relation to the investment of the

---

6

Account other than such monetary benefits or amounts permitted to be received in accordance with Article IV.

- (h) The Investment Manager shall exercise due diligence in selecting, appointing and reviewing the performance of any agent of the Investment Manager in connection with the Account or any Brokers engaged by the Investment Manager.
- (i) Except as otherwise disclosed in this Agreement, the Investment Manager does not have and will not have any interest, direct or indirect, which would conflict in any manner with its obligations under this Agreement.

2.4 **Transactions Involving Brokers.**

- (a) In performing the Services, the Investment Manager shall have full power, right, and authority to issue orders for the purchase or sale of securities for the Account, directly to Brokers, as well as to exercise or abstain from exercising any option, privilege or right held in the Account. In selecting a Broker with respect to effecting any securities transaction on behalf of the Customer, the Investment Manager may take into account such relevant factors as (i) total transaction price (including commissions, as a component of price), (ii) the Broker's facilities, reliability and financial responsibility, (iii) the ability of the Broker to effect securities transactions, particularly with regard to such aspects as timing, size and execution of orders, and (iv) the research services provided by such Broker to the Investment Manager (either directly or by arrangement with third parties) which may enhance the Investment Manager's general investment decision-making process, notwithstanding that the Customer may not be the direct or exclusive beneficiary of such services. Specifically, the Investment Manager may pay a Broker a commission in excess of the amount another broker would have charged for effecting such transaction, so long as, subject to the overriding principles of suitability and in the good faith judgment of the Investment Manager, the amount of the commission is reasonable in relation to the value of the brokerage and research services provided by such Broker, viewed in terms of that particular transaction or the Investment Manager's overall investment management business. The Investment Manager will make periodic disclosure to the Customer regarding transactions subject to soft dollar arrangements as required.

- (b) Subject to FSA Rules, the Investment Manager may enter into arrangements with Brokers to open “average price” accounts wherein orders during a trading day are placed on behalf of the Customer and other customers of the Investment Manager and its Associates and of its employees without prior reference to the Customer and will allocate such transactions (along with an equivalent portion of the expense related thereto) on a fair and reasonable basis using an average price.
- (c) The Customer may direct the Investment Manager to effect securities transactions for the Account (“Directed Trades”) through broker-dealer(s) identified by the Customer in writing (“Directed Brokers”) in a separate agreement acceptable to the Investment Manager. The Customer acknowledges that: (i) Directed Trades may not enable the Customer to obtain the cost and execution benefits, if any, of participating in aggregated trades with other customers; and (ii) Directed Trades may be executed before or after the Investment Manager effects the execution of transactions for other accounts with the result that the Customer may pay or receive, as the case may be, a different price for securities which were also the subject of trades by the Investment Manager for its other customers. The Customer

7

---

represents that Directed Trades are not prohibited by Applicable Requirements or the Customer’s governing documents.

- (d) The Investment Manager may provide typical investment representations and warranties on behalf of the Customer, including but not limited to those representations and warranties contained in clause 6.2 hereof, in connection with the purchase or sale of securities by the Customer.

2.5 **Custody Arrangements.** The Customer has established an agreement with JPMorgan Chase Bank (the “Custodian” and such agreement, the “Custody Agreement”). The Custodian shall be responsible for arranging custody and safekeeping of the Account Assets, the collection of income and other entitlements, the carrying out of any foreign exchange transaction and all other administrative functions in relation to such Account Assets. All Account Assets will be held by the Custodian in accordance with the provisions of the Custody Agreement. The Customer, during the term of this Agreement, shall promptly provide to the Investment Manager copies of any amendments to the Custody Agreement that may affect the Investment Manager in providing the Service and shall give to the Investment Manager notice of any termination of the Custody Agreement. The Customer shall be responsible for the payment of all custodial fees to the Custodian. The Investment Manager shall have no responsibility including supervisory responsibility or liability with respect to the acts, omissions or other conduct of the Custodian.

2.6 **Exercise of Rights.** Subject to the Investment Guidelines and any other written instructions of the Board, the Investment Committee or Representatives of the Customer provided to the Investment Manager, the Investment Manager shall use its best judgment to exercise or instruct the Custodian to exercise, in a manner that the Investment Manager deems to be in the best interests of the Customer, all voting rights, consent rights, subscription rights, conversion rights or any other rights arising in connection with any investment in the Account. The Investment Manager shall determine whether to consent to modifications of any documents governing securities held in the Account. Unless provided herein or requested in writing by the Customer, the Investment Manager need not forward any proxy material, consent solicitations or similar material to the Customer.

2.7 **Record Keeping and Inspection.**

- (a) The Investment Manager shall maintain all books, accounts, vouchers, records, memoranda, instructions or authorizations (collectively, “Records”) relating to the acquisition or disposition of securities or other investments in the Account in accordance with FSA Rules. Such Records will at all times be the property of the Customer. On a timely basis, the Investment Manager shall make available to the Customer, at its administrative offices or such other location as may be designated by the Customer, copies or originals of such Records upon reasonable request.
- (b) All Records, both internal and external with third parties, to the extent within the control of the Investment Manager, will clearly specify the ownership interest of the Customer in the Account Assets.
- (c) Records relating solely to the Account and/or the Account Assets that are not maintained physically on the Customer’s premises or in the Customer’s care, custody and control shall be subject to review and audit at any time by the Customer, its Representatives, the FSA and any other governmental or regulatory authority, or any other entity designated by the Customer, and the Investment Manager shall cooperate with and provide reasonable assistance to any such Person, including any Representative appointed by the Customer to conduct an audit of the Account. The Investment Manager shall notify the Customer prior to destruction of such Records (in order that the Customer

8

---

may request transfer of such Records to the Customer as an alternative to destruction).

- (d) The Investment Manager shall provide to the Customer such other documents and information pertaining to this Agreement, the Account and/or Account Assets at such times as the Customer may reasonably request including, but not limited to, information required to prepare reports to the FSA or any other entity designated by the Customer or as may be required in order for the Customer to comply with GAAP, SAP or Applicable Requirements.
- (e) The Investment Manager will cooperate fully with the Customer with respect to unsettled or unreconciled transactions and daily transmission of trading activity.
- (f) The Investment Manager shall permit representatives of the FSA to have access, with or without notice, during reasonable business hours to:
  - (i) any of the Investment Manager’s business premises;
  - (ii) any records, files, tapes, computer systems, computer data or other material within the Investment Manager’s possession or control related to the provision of the Services; and
  - (iii) any facilities which the FSA representatives may reasonably request, and at the Investment Manager’s reasonable expense to make and remove copies of any such Records are referred to in (ii) above.
- (g) The Investment Manager shall make itself readily available for meetings with FSA representatives as reasonably requested and shall answer truthfully, fully and promptly all questions that are reasonably put to them by FSA representatives.
- (h) The Investment Manager shall give the Customer’s duly appointed auditors entitlement to such information and explanations from its officers as they reasonably consider necessary for the performance of their duties.

2.8 **Information Furnished to the Investment Manager.**

- (a) The Customer shall furnish to the Investment Manager in a timely manner any information that the Investment Manager may reasonably request with respect to the Services. In determining the requirements of Applicable Requirements, the Investment Manager may rely on an interpretation of law by legal counsel to the Customer.

- (b) The Customer shall furnish to the Investment Manager in a timely manner details of inflows of cash to the Account in the first instance by e-mail followed by post in accordance with clause 8.3.
- (c) The Investment Guidelines may be modified or amended by the Board or the Investment Committee from time to time, provided that any such modification or amendment shall be provided by the Customer to the Investment Manager in writing in advance. The Investment Manager shall have a reasonable amount of time to bring the Account into compliance with any modification and amendment.

2.9 **Reporting and valuation**

- (a) The Investment Manager shall meet the Customer at such frequency as the Customer may reasonably require to review the performance of the Account and to discuss the Investment Guidelines. The Investment Manager shall

9

(provided it receives no less than two weeks' notice of the meeting) provide the Customer not less than one week before each such meeting a written submission reviewing developments since the last meeting and outlining the major topics on which it proposes to comment at the forthcoming meeting.

- (b) The Investment Manager shall promptly deliver to the Chief Financial Officer of the Customer monthly statements showing all investments in each Account as of the close of business on the last business day of each month (the "Securities Valuation Date"). Said statements shall be sent to the Customer promptly following the end of each month and shall include:
  - (i) a statement summarizing the transactions subsequent to the immediately prior Securities Valuation Date; and
  - (ii) a report, if any, assessing the negative performance of the Custodian with respect to the custody of the Account Assets, to the extent known by the Investment Manager.
- (c) The Investment Manager shall agree with the Customer on any other statements to be provided and in the absence of such agreement, shall have no obligation to provide any statements other than as expressly provided herein.
- (d) For the purposes of these statements and any other statements or reports requested by the Customer, unless otherwise agreed upon in writing by the Customer and the Investment Manager, the basis for valuing Account Assets shall be determined in good faith by the Investment Manager.
- (e) The Customer shall provide the Investment Manager with a certificate (substantially in the form set out in Exhibit A) setting forth the names and specimen signatures of the individuals who are authorized to act on behalf of the Customer. The Customer may from time to time amend or vary such certificate by written notice to the Investment Manager.

**ARTICLE III  
TERM AND TERMINATION**

3. **Term and Termination.**

- (a) This Agreement shall continue in effect for a term beginning on the Effective Date and ending on the third anniversary of the Effective Date (the "Initial Termination Date"). Not less than one (1) year prior to the Initial Termination Date, the Customer shall notify the Investment Manager in writing of its intent to terminate this Agreement on the Initial Termination Date or to extend this Agreement for an additional one (1) year term (the "First Extension").
- (b) If the Customer exercises the First Extension, the Customer shall, no later than the Initial Termination Date, notify the Investment Manager in writing of its intent to terminate this Agreement at the end of the First Extension or to further extend this Agreement for an additional one (1) year term (the "Second Extension").
- (c) This Agreement may only be terminated by the Customer:
  - (i) for any reason (including, without any limitation, if the GE Life Group decides to engage other investment managers to provide substantially all advisory services to its fixed income assets) with six (6) months prior notice (which notice shall specify the effective date

10

of termination) to the Investment Manager, provided, that the Customer may provide less than six (6) months notice subject to clause 3(d) below; or

- (ii) immediately (A) for cause ("cause" being understood as any fraud or wilful misconduct by the Investment Manager in managing the Account, the Investment Manager's material breach of this Agreement, materially deficient investment performance with respect to the Account or the Investment Manager's material or repeated non-compliance in managing the Account in accordance with the Investment Guidelines or Investment Objectives; provided that, except with respect to Manager's fraud or wilful misconduct, the Investment Manager shall have thirty (30) days from notice of such non-compliance or material breach to cure such non-compliance or material breach to the reasonable satisfaction of the Customer in which case cause shall not be deemed to have arisen); (B) upon a Control Event with respect to the Customer or the Investment Manager; or (C) following the occurrence of a FSA Termination or Regulatory Change (each as defined in clause 3(e) below) or the occurrence of an event described in clause 3(e) (iii)(A) below.
- (d) If the Customer terminates this Agreement with less than six (6) months prior notice and if such termination is not due to the occurrence of any event set forth in clause 3(c)(ii) above, the Customer will pay to the Investment Manager, in addition to all fees applicable for the period from notice to termination, the lesser of (1) the unpaid balance of the Budgeted Costs that have been applicable for providing the Services during the period from the termination date through the date that is six (6) months from the date that notice was received (the "Remaining Term") or (2) the Actual Costs incurred by the Investment Manager for providing the Services for the Remaining Term (in each case as adjusted to reflect the pro-rata portion of the True-up for the following year, or portion thereof, if applicable). The Investment Manager shall use reasonable efforts to mitigate the incurrence of such costs and expenses.
- (e) This Agreement may be terminated by the Investment Manager:
  - (i) if the FSA suspends or withdraws the Investment Manager's investment adviser registration or permission to carry on investment management activities ("FSA Termination");
  - (ii) if a change in Applicable Requirements occurs that would materially and adversely affect the Investment Manager's ability to provide the Services

- (iii) (“Regulatory Change”); or  
if (A) GE or an Associate thereof, as the case may be, decides to dissolve the Investment Manager and commences dissolution or other winding up proceedings; (B) a Control Event with respect to the Investment Manager occurs; or (C) the GE Life Group decides to engage other investment managers to provide substantially all advisory services to its fixed income assets (each such event in (A), (B) or (C), a “GE Change”); provided that the Investment Manager shall give prompt written notice of a GE Change to the Customer and the date of termination shall occur on the later of the Initial Termination Date or six (6) months from the giving of notice of the GE Change to the Customer.
- (f) The Investment Manager shall provide prompt written notice of a FSA Termination or Regulatory Change to the Customer and the Investment Manager shall use best efforts to extend the termination date of this Agreement to the maximum date consistent with the requirements of the FSA

11

---

or the date of implementation of the Regulatory Change, as applicable, and in a manner consistent with regard to clause 3(k).

- (g) This Agreement also shall automatically terminate in the event of its unauthorized assignment by either party.
- (h) Termination in any manner shall not affect the rights of either party that accrued prior to termination.
- (i) The Customer acknowledges that the Investment Manager has and will continue to expend substantial fixed costs in providing the Services to the Customer and such costs would not have been incurred but for the Investment Manager providing the Services. Furthermore, the Customer acknowledges that the Investment Manager has agreed to provide the Services for the fees payable pursuant to Article IV in part because the Customer has expressed a good faith intention to engage the Investment Manager for not less than three (3) years following the Effective Date. Therefore, the Customer acknowledges that the management fees still to be paid to the Investment Manager following a termination by the Customer of this Agreement for reasons other than pursuant to clause 3(c)(ii) above and with less than six (6) months prior notice should not be construed as a penalty but as a reasonable approximation of the additional costs incurred by the Investment Manager due to the failure of the Customer to meet the parties’ expectations.
- (j) Within sixty (60) days of the termination of this Agreement, the Investment Manager shall transfer all Records to the Customer or its designee provided that Investment Manager shall be entitled to maintain a copy of such Records. All reasonable costs (but not any copying costs) to transfer such Records shall be paid by the Customer.
- (k) In the event of any termination of this Agreement, the Customer may request that the Investment Manager continue to serve as an investment manager hereunder (at the then-existing compensation level) in order to assist the Customer in effecting a smooth and orderly transfer of services and all Records to any successor Investment Manager (which may be Customer); provided that such transition period shall not exceed 3 months unless otherwise agreed to by the parties. The Investment Manager shall consent to such request provided termination is not the result of a FSA Termination or Regulatory Change.

#### ARTICLE IV COMPENSATION

#### 4. Compensation.

- (a) Subject to the provisions of this Article IV, the Customer agrees to pay the Investment Manager a management fee on a quarterly basis in arrears for the Services. The management fee shall be equal to \*\* basis points (\*\*%) (the “Management Percentage”) multiplied by the value of the Account Assets as of the end of the relevant calendar quarter, as determined by the Custodian’s records, divided by four (4). The Customer agrees to pay an estimate (determined in good faith by the Investment Manager) of this amount in monthly installments in advance with any difference between the amount paid and the amount due being set against the actual quarterly fee. The parties acknowledge that the initial Management Percentage has been, and the Management Percentage applicable for each calendar year thereafter, will be equal to 105% of the percentage resulting from dividing the

12

---

Investment Manager’s budgeted direct and indirect costs and expenses for providing the Services for such period (the “Budgeted Costs”) as adjusted by any True-up for the prior year by the Customer’s estimated average Account Assets for the next calendar year.

- (b) The parties will reestablish the Management Percentage for each calendar year in accordance with the following process. By each September 15, the Customer shall provide the Investment Manager with a provisional forecast of the Customer’s Account Assets for the following calendar year together with an outline of any significant changes that the Customer proposes to implement to its investment strategy during the following calendar year. By each October 1, the Investment Manager shall provide the Customer with a detailed budget setting forth the expected Budgeted Costs to be incurred by the Investment Manager in order to provide the Services for the following calendar year along with reasonable documentation in support of such budget (collectively, the “Proposal”). The Customer shall promptly review the Proposal and shall accept or reject the Proposal, in the Customer’s reasonable discretion, by no later than November 1; provided, however, if the Customer rejects the Proposal it shall provide the Investment Manager with a written explanation for such rejection. If the Customer rejects the Proposal, the Customer and the Investment Manager will work in good faith to resolve all issues so that the Proposal is acceptable to both parties no later than December 1. As promptly as possible, but in no event later than January 15 of each year, the Customer shall provide the Investment Manager its final forecast of Account Assets for the calendar year and any significant changes to the Customer’s investment strategy that the Customer proposes to implement during such calendar year. Within five (5) business days following receipt of such information, the Investment Manager shall calculate the difference between the management fees paid or payable by the Customer to the Investment Manager for the prior year under this Agreement and the Investment Manager’s actual direct and indirect costs and expenses of providing services (“Actual Costs”) during such period (such difference is referred to as the “True-up”) and shall provide the True-up and proposed Management Percentage to the Customer. The calculation of any True-up shall not give effect to fees received by the Investment Manager or reductions in fees otherwise owed to the Investment Manager as a result of a prior True-up. The True-up shall be added to or subtracted from, as applicable, the Budgeted Costs set forth in the approved Proposal and shall be reflected in the Management Percentage established for the following calendar year. If the Investment Manager is entitled to the benefit of the True-up because Actual Costs exceeded Budgeted Costs, the True-up added to Budgeted Costs for the following calendar year shall be the lesser of the actual True-up or an amount equal to 10% of Budgeted Costs for the prior calendar year; provided however, that any Actual Costs that were not included in the approved Proposal for the year but were previously approved in writing by the Customer in consultation with the Investment Manager during such year shall not be included when applying the 10% cap. The Investment Manager shall provide the Customer with reasonable back-up documentation supporting the Investment Manager’s calculation of the True-up. The Customer shall approve or reject the True-Up and the Management Percentage not later than five (5) business days after receipt thereof from the Investment Manager. The Management Percentage shall be implemented as if it were effective as of the prior January 1. If the parties are unable to agree on a revised Proposal, the True-up or the Management Percentage, the then existing Management Percentage shall remain in effect until the parties agree on a revised Proposal and True-up. If the parties are unable to agree on the Proposal, the Management Percentage and the True-up by February 15, the Budgeted Costs and Management Percentage (which shall reflect the True-up) shall be established pursuant to the Arbitration process described in

Article IX of this Agreement. In accordance with the foregoing procedure, if the GE Life Group decides to engage other investment managers to provide substantially all advisory services to its fixed income assets, the Manager agrees that Budgeted Costs (without giving effect to any True-up) for the calendar year immediately following such change shall not increase by more than 5% unless mutually agreed by the parties. Both parties understand that time is of the essence with respect to this clause 4(b). For purposes of all dates set forth in this clause, if such date is not a business day, then such date shall be deemed to be the next calendar day that is a business day.

- (c) The Customer agrees to pay an estimate (determined in good faith by the Investment Manager) of the quarterly charge contemplated in clause 4(a) above in monthly installments in advance with any difference between the amount paid and the amount due being set against the actual quarterly fee. The Investment Manager shall submit to the Customer at the beginning of each month, a written statement of the amount owed by the Customer for that month. The Customer shall pay the Investment Manager undisputed amounts within twenty eight (28) days following receipt of such statement. Fees to be paid in GBP. VAT will be added and paid, where applicable, by the Customer. The Customer will inform the Investment Manager as soon as possible when it is no longer within the GE Capital Bank Limited VAT Group.

## ARTICLE V CONFIDENTIALITY

Subject to the duty of the Investment Manager or the Customer to comply with Applicable Requirements, each party hereto shall treat as confidential all information with respect to the other party received pursuant to this Agreement. No party shall use or disclose the other party's confidential information except as contemplated by this Agreement.

The Investment Manager shall establish and maintain reasonable procedures to keep Investment Reports, the information supplied by the Customer to the Investment Manager for the Investment Reports and other non-public information provided hereunder confidential and to prevent disclosure or distribution to any Person other than to the Customer's Representatives or the Investment Manager's Representatives or their service providers who have a reasonable need to know or have access to such information in connection with providing the Services; provided that the Investment Manager may include information from such Investment Reports when presenting the Investment Manager's performance as long as the Customer is not identified as the source of such information. The Investment Manager will be responsible for compliance with the terms of this clause by its Representatives.

Investment Reports provided by the Investment Manager to the Customer are privileged and may include proprietary information. Investment Reports will be used solely for the purpose of monitoring and evaluating the performance of the Account and for use by the Customer in testing the Account Assets for regulatory compliance and similar purposes. The Customer shall establish and maintain reasonable procedures to keep Investment Reports confidential and to prevent disclosure or distribution to any Person other than to the Customer's Representatives who have a reasonable need to know or have access to such Investment Reports in connection with the receipt of the Services. The Customer will be responsible for compliance with the terms of this clause by its Representatives.

Each party hereto will, to the extent legally possible, obtain the other party's approval before sending or making available any Investment Report to third parties. If a party is required by Applicable Requirements or requested (by legal process, civil investigative demand or similar process) to disclose any confidential information of the other party, the party being required or requested to make such disclosure will to the extent legally possible promptly notify the other party so that the other party may to the extent legally and practically possible seek an appropriate protective order or waive compliance with this confidentiality covenant.

## ARTICLE VI REPRESENTATIONS AND WARRANTIES

### 6.1. Representations and Warranties of the Investment Manager.

The Investment Manager represents, warrants and covenants that:

- (a) It is duly incorporated under the laws of England and Wales.
- (b) It has and will maintain throughout the term of this Agreement, all of the powers, rights and authorities to carry on the business of an investment manager under Applicable Requirements (including, without limitation, the appropriate permissions from the FSA, but excluding solely for this purpose any registrations with the SEC).
- (c) Neither the execution and delivery nor the performance of this Agreement will violate any Applicable Requirements or applicable court order, nor will the same constitute a breach of, or default under, provisions of any agreement or contract to which it is a party or by which it is bound and assuming the accuracy of sub-clause 6.2(b) below, all required regulatory filings and notices, if any, have been made and, if necessary, approvals received (or applicable waiting or notice periods lapsed) in connection with this Agreement.
- (d) It has the power, right and authority to execute, deliver and perform this Agreement and any transaction contemplated by the terms of this Agreement.
- (e) It has, at least 48 hours prior to entering into this Agreement furnished to the Customer a true and complete copy of Part II of its most recent Form ADV; and since the date of such Form ADV, there has not been, occurred or arisen any material adverse change in the financial condition or in the business of the Investment Manager or any event, condition, or state of facts which materially and adversely affects, or to its knowledge threatens to materially affect, the business or financial condition of the Investment Manager.
- (f) In terms of intellectual property, it is the sole owner of all right, title and interest in and to the intellectual property used by it to perform its obligations hereunder or, to its knowledge, possesses all appropriate licenses to use the intellectual property; has not sold, granted, conveyed, licensed or assigned to any third party, or in any way encumbered, the intellectual property in a manner that interferes with the Investment Manager's obligations under this Agreement; and the intellectual property used by the Investment Manager does not to the Investment Manager's knowledge infringe the rights of any third party.

### 6.2. Representations and Warranties of the Customer.

The Customer hereby represents and warrants that:

- (a) It has the power to enter into and perform its obligations under this Agreement, and has duly executed this Agreement so as to constitute a valid and binding obligation of the Customer.
- (b) Neither the execution and delivery nor the performance of this Agreement (including the payment of fees to the Investment Manager) will violate any

contract to which it is a party or by which it is bound and, assuming the accuracy of sub-clause 6.1(c) above, all required regulatory filings and notices, if any, have been made, and if necessary, approvals received (or applicable waiting or notice periods lapsed) in connection with this Agreement.

**ARTICLE VII  
NATURE OF RELATIONSHIP**

**7. Nature of Relationship; Conflicts of Interest.**

- (a) The Investment Manager acts as the agent of the Customer, who will therefore be bound by the Investment Manager's acts under this Agreement providing the Investment Manager acts within the authority granted to it by the Customer. Nevertheless, none of the Services nor any other matter shall give rise to any fiduciary or equitable duties which would prevent or hinder the Investment Manager from providing similar services to other customers or otherwise from acting as provided in this Agreement.
- (b) The Investment Manager may effect transactions in which the Investment Manager or an Associate has or may have, directly or indirectly, a material interest or relationship of any description with another party which may involve a potential conflict with the Investment Manager's duty to the Customer, without reference to the Customer, provided that such transactions are at arm's length. Neither the Investment Manager nor any Associate shall be liable to account to the Customer for any profit, commission or remuneration made or received from or by reason of such transactions or any connected transactions and the Investment Manager's fees shall not, unless otherwise provided, be abated thereby.
- (c) The Investment Manager will ensure that such transactions are effected on terms that are no less favourable to the Customer than if the potential conflict had not existed.
- (d) The Investment Manager shall (subject to receiving instructions from the Customer to the contrary) take all necessary steps (acting always in the best interests of the Account) to ensure that the Investment Guidelines are fully complied with, and to rectify any breach of such Investment Guidelines which may occur through movements in the market as soon as reasonably practicable after such breach occurs.
- (e) In accordance with the FSA Rules, the Investment Manager notifies the Customer that the potential conflicting interest or duties referred to in clause (b) above may arise because:
  - (i) any of the Investment Manager's directors or employees (or those of an Associate) is a director of, holds or deals in securities of, or is otherwise interested in any company whose securities are held or dealt in on behalf of the Customer;
  - (ii) the transaction is in relation to an investment in respect of which the Investment Manager or an Associate benefits from a commission, fee, mark-up or mark-down payable otherwise than by the Customer, and/or the Investment Manager or an Associate is also remunerated by the counterparty to any such transaction;
  - (iii) the Investment Manager acts as agent for the Customer in relation to a transaction in which it is also acting as an agent for the account of other Customers and/or Associate;

- (iv) the Investment Manager or an Associate deals in investments as principal with the Customer, or acting as principal, sells to or purchases from the Customer currency other than sterling;
- (v) a transaction is effected in securities issued by an Associate or the Customer of an Associate;
- (vi) the Investment Manager deals on behalf of the Customer with or in securities of an Associate;
- (vii) the transaction is in units or shares of a collective investment scheme (e.g. a unit trust) or of any company of which in either case the Investment Manager or an Associate is the investment manager, operator, banker, adviser or trustee;
- (viii) the transaction is in the securities of a company for which the Investment Manager or an Associate has underwritten, managed or arranged an issue within the period of 12 months before the date of the transaction;
- (ix) the Investment Manager may effect transactions involving placings and or new issues with an Associate who may be acting as principal or receiving agents commission;
- (x) the Investment Manager or an Associate receives remuneration or other benefits by reason of acting in corporate finance or similar transactions involving companies whose securities are held by the Customer; and
- (xi) the transaction is in securities in respect of which the Investment Manager or an Associate or a director or employee of either is contemporaneously trading or has traded on its own account has either a long or short position.

**ARTICLE VIII  
MISCELLANEOUS**

**8.1 Other Charges.**

The Investment Manager shall direct the Custodian to pay out of the relevant Account Assets the total transaction costs including all reasonable Broker's commissions with respect to transactions of the Account and all taxes or governmental fees, domestic or foreign, attributable to such transactions.

**8.2 Investment Manager's Conduct.**

- (a) In furnishing the Customer with the Services, neither the Investment Manager nor any officer, director or agent thereof shall be held liable to the Customer, its creditors or the holders of its securities for good faith errors of judgment or for anything except wilful misfeasance, bad faith or gross negligence in the



performance of its duties, or reckless disregard of its obligations and duties under the terms of this Agreement. It is further understood and agreed that the Investment Manager may rely upon information furnished to it by the Customer that the Investment Manager reasonably believes to be accurate and reliable.

- (b) No warranty is given by the Investment Manager as to the performance or profitability of the Account any part thereof and there is no guarantee that the Investment Objectives will be achieved, including without limitation any risk control, risk management or return objectives. The Account may suffer loss

17

---

of principal, and income, if any, may fluctuate. The value of investments may be affected by a variety of factors, including, but not limited to, economic and political developments, interest rates and issuer-specific events, market conditions, sector positioning, or other reasons.

- (c) Notwithstanding any limitation of liability contained in sub-clause (a) above, the Investment Manager shall indemnify and hold the Customer harmless from and against any losses, damages, expenses (including reasonable attorneys' fees), liabilities, penalties, demands and claims of any nature whatsoever (collectively, "Losses") with respect to or arising out of the Investment Manager's breach or violation of this Agreement or any Applicable Requirement or the wilful misfeasance, bad faith or gross negligence by the Investment Manager in the performance of its duties, or reckless disregard of its obligations and duties under the terms of this Agreement.
- (d) The Customer shall indemnify and hold the Investment Manager harmless from and against all Losses with respect to or arising out of the Customer's breach or violation of this Agreement or any Applicable Requirement or with respect to or arising out of the Investment Manager's actions or inactions in providing the Services as long as such Losses did not result from the Investment Manager's breach of this Agreement or any Applicable Requirements, wilful misfeasance, bad faith or gross negligence in the performance of its duties, or reckless disregard of its obligations and duties under the terms of this Agreement.
- (e) The Investment Manager shall be entitled to rely upon any notice, designation, instruction, direction, request or other communication given it hereunder (whether given in writing by letter, fax, email teletype, order or other document, or orally by telephone or in person) by or on behalf of any person notified by the Customer from time to time as being authorised to instruct the Investment Manager in respect of the Account Assets without being required to determine the authenticity or correctness thereof, provided the Investment Manager believes such notice, designation, instruction, direction, request or other communication to be genuine or given by a person duly authorized and unless the Investment Manager shall have received written notice to the contrary that the authority of any such person shall have been terminated. The Investment Manager shall be entitled to rely upon advice of counsel selected by it concerning all matters pertaining to this Agreement and the Investment Manager's duties hereunder.

### **8.3 Notices.**

Notices hereunder shall be by confirmed fax, teletype or other written form of electronic communication (including e-mail) or by letter which shall be mailed by certified mail, postage paid, addressed (except as the same may be like notice be changed) as follows:

To the Customer:

Financial Assurance Company Limited  
Vantage West  
Great West Road  
Brentford Middlesex TW8 9AG  
Attn: Chief Finance Officer

Telephone No:  
Fax No:

18

---

To the Investment Manager:

GE Asset Management Limited  
6 Agar Street  
London  
WC2N 4HR  
Attn: Chief Executive Officer

Telephone No: 44 207 599 5200  
Fax No: 44 207 599 5233

### **8.4 Assignment: Governing Law and Jurisdiction.**

This Agreement shall not be assignable in whole or in part by either party without the prior consent of the other party (such consent not to be unreasonably withheld), provided that this Agreement shall automatically be assigned to any Person to which the business of the Customer is transferred by virtue of any order made by the Court under Part VII of FSMA. For purposes of this clause, the term "assignment" with respect to the Investment Manager as assignor shall have the same meaning as defined in Section 202 of the Investment Advisors Act. Any successor or permitted assignee of the Customer to whom the rights and/or the obligations of the Customer under this Agreement are in any way transferred may require that the Investment Manager (and if it does so require, the Investment Manager shall) provide all or certain of the Services to the Customer after that transfer, for such period as that successor or permitted assignee may require, and in addition to the Services which the Investment Manager shall provide to that successor or permitted assignee pursuant to the terms of this Agreement. This Agreement shall be governed by the laws of England..

### **8.5 Force Majeure.**

The Investment Manager shall not be liable to the Customer for any failure to carry out or delay in carrying out any of its obligations hereunder attributable to any cause of whatever nature outside its reasonable control provided that the Investment Manager shall (1) use its best efforts to remedy any such failure or delay or malfunction, event or circumstance as soon as practicable and (2) maintain throughout the term of this Agreement effective disaster recovery systems, details of which will be provided to the Customer upon reasonable request.

### **8.6 Independent Contractor.**

The Investment Manager shall be deemed to be an independent contractor and, except as expressly provided or authorized in this Agreement, shall have no authority to act for or represent the Customer. The Customer shall always retain the ultimate authority to make investment decisions on its own behalf.

### **8.7 Advertising and Promotion.**

A party shall not engage in any advertising or promotional activity that refers to the other party without receiving the written consent of the other party prior to publication or announcement. The Investment Manager shall however be entitled to disclose the Customer's name and the size of the Account Assets in the client listings and other similar material.

8.8 **Severability.**

Any provision of this Agreement which is prohibited or unenforceable in any jurisdiction shall, as to such jurisdiction, be ineffective to the extent of such prohibition or unenforceability without invalidating the remaining provisions hereof, and any such

19

---

prohibition or unenforceability in any jurisdiction shall not invalidate or render unenforceable such provision in any other jurisdiction.

8.9 **Amendments.**

No term or provision of this Agreement may be amended, waived, discharged or terminated orally, but only by an instrument in writing signed by both parties.

8.10 **Counterparts.**

This Agreement may be executed in one or more counterparts, and such counterparts together shall constitute one and the same agreement

8.11 **Complaints.**

If the Customer has any complaint about the Investment Manager, it should be directed to the Compliance Officer at the Investment Manager's address at the head of this Agreement. The Customer acknowledges that it is not an eligible complainant as defined by the FSA Rules and as such does not have a right to refer a complaint to the Financial Ombudsman Service.

8.12 **Contracts (Rights of Third Parties) Act of 1999.**

Other than as specifically provided for, the parties to this Agreement do not intend that any term of this Agreement should be enforceable by virtue of the Contracts (Right of Third Parties) Act of 1999, by any person who is not a party to this Agreement.

8.13 **Entire Agreement.**

This Agreement (including the Exhibits to this Agreement which shall be regarded as incorporated into, and forming part of, this Agreement) embodies the entire understanding of the parties hereto with respect to its subject matter, supersedes any prior or contemporaneous agreements or understandings between the parties with respect to such subject matter and cannot be altered, waived, amended, supplemented or abridged except by the written agreement of the parties.

8.14 **Exclusion or Termination of Liability.**

Nothing in this Agreement shall exclude any liability of the Investment Manager to the Customer arising under Applicable Requirements (including, without limitation, the FSMA or the FSA Rules).

**ARTICLE IX  
DISPUTE RESOLUTION**

9.1 **General Provisions.**

- (a) Any dispute, controversy or claim arising out of or relating to this Agreement or the validity, interpretation, breach or termination thereof (a "Dispute"), shall be resolved in accordance with the procedures set forth in this Article IX, which shall be the sole and exclusive procedures for the resolution of any such Dispute unless otherwise specified below.
- (b) Commencing with a request contemplated by Section 9.2 set forth below, all communications between the parties or their representatives in connection with the attempted resolution of any Dispute, including any mediator's evaluation referred to in Section 9.3 set forth below, shall be deemed to be without prejudice communications and to have been delivered in furtherance

20

---

of a Dispute settlement and shall be exempt from inspection, and shall not be admissible in evidence for any reason (whether as an admission or otherwise), in any arbitral or other proceeding for the resolution of the Dispute.

- (c) In connection with any Dispute, the parties expressly waive and forego any right to (i) punitive, exemplary, statutorily-enhanced or similar damages in excess of compensatory damages, and (ii) trial by jury.
- (d) The specific procedures set forth below, including but not limited to the time limits referenced therein, may be modified by agreement of the parties in writing.
- (e) The running of time shall be suspended in respect of any Dispute for the purposes of any defences based upon the passage of time (whether under the Limitation Act 1980 (in its present form or as subsequently amended or replaced or otherwise) while the procedures specified in this Article IX are pending. The parties will take such action, if any, required to effectuate this suspension.

9.2 **Consideration by Senior Executives.** If a Dispute is not resolved in the normal course of business at the operational level, the parties shall attempt in good faith to resolve such Dispute by negotiation between executives who hold, at a minimum, the office of President and CEO of the respective business entities involved in such Dispute. Either party may initiate the executive negotiation process by providing a written notice to the other (the "Initial Notice"). Fifteen (15) days after delivery of the Initial Notice, the receiving party shall submit to the other a written response (the "Response"). The Initial Notice and the Response shall include (i) a statement of the Dispute and of each party's position, and (ii) the name and title of the executive who will represent that party and of any other person who will accompany the executive. Such executives will meet in person or by telephone within thirty (30) days of the date of the Initial Notice to seek a resolution of the Dispute.

9.3 **Mediation.** If a Dispute is not resolved by negotiation as provided in Section 9.2 within forty-five (45) days from the delivery of the Initial Notice, then either party may submit the Dispute for resolution by mediation pursuant to the CPR Institute for Dispute Resolution (the "CPR") Model Mediation Procedure as then in effect.

The parties will select a mediator from the CPR Panels of Distinguished Neutrals. Either party at commencement of the mediation may ask the mediator to provide an evaluation of the Dispute and the parties' relative positions.

**9.4 Arbitration**

- (a) If a Dispute is not resolved by mediation as provided in Section 9.3 within thirty (30) days of the selection of a mediator (unless the mediator chooses to withdraw sooner), either party may submit the Dispute to be finally resolved by arbitration pursuant to the CPR Rules for Non-Administered Arbitration as then in effect (the "CPR Arbitration Rules"). The parties consent to a single, consolidated arbitration for all known Disputes existing at the time of the arbitration and for which arbitration is permitted.
- (b) The neutral organization for purposes of the CPR Arbitration Rules will be the CPR. The arbitral tribunal shall be composed of three arbitrators, of whom each party shall appoint one in accordance with the "screened" appointment procedure provided in Rule 5.4 of the CPR Arbitration Rules. The arbitration shall be conducted in London, England. Each party shall be permitted to present its case, witnesses and evidence, if any, in the presence of the other party. A written transcript of the proceedings shall be made and furnished to the parties. The arbitrators shall determine the Dispute in accordance with

the law of England, without giving effect to any conflict of law rules or other rules that might render law inapplicable or unavailable, and shall apply this Agreement according to its terms.

- (c) The parties agree to be bound by any award or order resulting from any arbitration conducted in accordance with this Section 9.4 and further agree that judgment on any award or order resulting from an arbitration conducted under this Section 9.4 may be entered and enforced in any court having jurisdiction thereof.
- (d) Except as expressly permitted by this Agreement, no party will commence or voluntarily participate in any court action or proceeding concerning a Dispute, except (i) for enforcement as contemplated by Section 9.4(c) above, (ii) to restrict or vacate an arbitral decision based on the grounds specified under applicable law, or (iii) for interim relief as provided in paragraph (e) below. For purposes of the foregoing, the parties hereto submit to the non-exclusive jurisdiction of the courts of England.
- (e) In addition to the authority otherwise conferred on the arbitral tribunal, the tribunal shall have the authority to make such orders for interim relief, including injunctive relief, as it may deem just and equitable. Notwithstanding Section 9.4(d) above, each party acknowledges that in the event of any actual or threatened breach of Article V, the damages would not be adequate, and therefore injunctive or other interim relief may be sought immediately to restrain such breach. If the tribunal shall not have been appointed, either party may seek interim relief from a court having jurisdiction if the award to which the applicant may be entitled may be rendered ineffectual without such interim relief. Upon appointment of the tribunal following any grant of interim relief by a court, the tribunal may affirm or disaffirm such relief, and the parties will seek modification or rescission of the court action as necessary to accord with the tribunal's decision.
- (f) Each party will bear its own attorneys' fees and costs incurred in connection with the resolution of any Dispute in accordance with this Article IX

IN WITNESS WHEREOF, the parties have duly executed this Agreement as of the day and year first above written.

FINANCIAL ASSURANCE COMPANY LIMITED

By: \_\_\_\_\_  
Name:  
Title:

GE ASSET MANAGEMENT LIMITED

By: \_\_\_\_\_  
Name:  
Title:

**Financial Assurance Company Limited  
Duly Authorised Representatives  
Exhibit A**

The following persons are duly authorized to act on behalf of the above captioned for accounts managed by GE Asset Management Limited.

Signature: \_\_\_\_\_  
Name:  
Title:  
Firm Name:

Type of Authorisation  
Bind Firm (sign/amend contracts)  
Authorise Contributions/Withdrawals  
Comments:

Signature: \_\_\_\_\_  
Name:  
Title:  
Firm Name:

Type of Authorisation  
Bind Firm (sign/amend contracts)  
Authorise Contributions/Withdrawals  
Comments:

Signature: \_\_\_\_\_  
Name:

Type of Authorisation  
Bind Firm (sign/amend contracts)

Title:  
Firm Name:

Signature: \_\_\_\_\_  
Name:  
Title:  
Firm Name:

Authorise Contributions/Withdrawals  
Comments:

Type of Authorisation  
Bind Firm (sign/amend contracts)  
Authorise Contributions/Withdrawals  
Comments:

## ASSET MANAGEMENT SERVICES AGREEMENT

**THIS ASSET MANAGEMENT SERVICES AGREEMENT**, made this      day of January, 2004, effective the 1st day of January, 2004 (this “Agreement”) by and among Genworth Financial, Inc. (“Genworth”), a Delaware corporation, General Electric Financial Assurance Holdings, Inc. (“GEFAHI”), a Delaware corporation, and GE Asset Management Incorporated (“GEAM”), a Delaware corporation.

**WHEREAS**, Genworth desires to make an initial public offering of shares of its common stock;

**WHEREAS**, GEFAHI owns preferred stock of GEAM, an affiliated company of GEFAHI, and relies on fees generated by GEAM’s institutional asset management clients to receive dividends in respect of such preferred stock;

**WHEREAS**, Genworth and subsidiaries or predecessors were previously responsible for overseeing the growth and development of GEAM’s institutional asset management business and have distributed certain mutual fund assets which are being managed for a fee by GEAM, and will continue to distribute certain mutual funds managed by GEAM under a separate agreement;

**WHEREAS**, Genworth has developed expertise in consulting and analytical services related to the retention of assets under management which it is and has been providing to GEFAHI and GEAM;

**WHEREAS**, Genworth has developed expertise in broker-dealer regulatory compliance matters which it is and has been providing to GEAM and certain affiliated entities;

**WHEREAS**, Genworth may have regular contacts with corporate and other institutions that may have an interest in obtaining asset management services provided by GEAM;

**WHEREAS**, GEFAHI and GEAM desire to engage Genworth to continue providing certain services, subject to Genworth entering into this Agreement.

**NOW, THEREFORE**, the parties hereto hereby agree as follows:

**1. Asset Under Management and Retention Services.** Genworth will assist in the retention of GEAM assets under management. Part of this assistance will include providing to GEAM services such as statistical and data mining for the purpose of identifying customer trends, identifying industry best practices regarding client retention, and providing training on client retention strategies to GEAM personnel involved in sales and client-relationship management, all of which help identify at-risk clients and achieve customer satisfaction that

---

results in the retention of asset management customers. Genworth will provide such reasonably requested services within thirty days of receiving a written request from GEAM.

**2. Broker-Dealer Regulatory Compliance.** Genworth will provide to GEAM and certain affiliated entities assistance in meeting broker-dealer regulatory compliance requirements, including with respect to required filings, and will make reasonably available to GEAM and such affiliated entities broker-dealer compliance experts for consultation. These services will include:

- (a) Preparation of monthly or quarterly FOCUS filings for GE Investment Distributors, Inc. (“GEID”) as required by the National Association of Securities Dealers, Inc. (“NASD”);
- (b) Preparation of Annual Financial Statements for GEID to be filed with the NASD;
- (c) Maintenance of the financial records necessary to support the annual independent audit requirements for GEID and the periodic examination by the NASD and/or the U.S. Securities and Exchange Commission (the “SEC”); and
- (d) Provision of broker-dealer compliance consultation which shall consist of up to twenty hours per week of consultation by an experienced compliance professional with respect to broker-dealer operations and mutual fund compliance requirements in relationship to the distribution of products for which GEID serves as distributor.

**3. Introduction Services.** Genworth will use commercially reasonable efforts to identify corporate and other institutional investors that it believes are appropriate for, and may be interested in the institutional asset management services offered by, GEAM. Upon identifying any such potential clients, Genworth will notify GEAM promptly in writing of the name and address of any such potential clients. Genworth also will use commercially reasonable efforts to assist GEAM in establishing relationships with potential clients identified by Genworth.

**4. Representations, Warranties and Covenants of Genworth.**

- (a) Genworth is a company duly organized, validly existing and in good standing under the laws of Delaware and has the power and authority to execute, deliver and perform this Agreement.
- (b) This Agreement is the valid and binding obligation of Genworth enforceable against it in accordance with its terms, except as enforceability may be limited by bankruptcy, insolvency, moratorium or other similar laws affecting creditor’s rights generally or the principles governing the availability of equitable remedies.
- (c) Genworth shall perform its introduction services as described in Section 3 in accordance with this Agreement; GEAM’s instructions; applicable federal, state and local law; and any additional agreement(s) as may be required if, at any time that this Agreement remains in effect, Genworth is no longer under common control (as that term is defined in the Investment

---

Advisers Act of 1940, as amended (the “Advisers Act”) with GEAM. Genworth shall notify GEFAHI and GEAM when it is no longer under common control with GEAM and will suspend all introduction services as described in Section 3 until such time as the additional agreement(s) is in place.

(d) Genworth (and its officers, directors and employees, including those of its subsidiaries) are not authorized to enter into any agreement or undertaking on behalf of GEAM; and will make clear their affiliation with GEAM whenever making initial contact with potential GEAM clients in conjunction with any introduction services

they may provide as described in Section 3.

(e) No officer, director or employee of Genworth or of its respective subsidiaries who engages in introduction services as described in Section 3 is or will be a person who is or has been: (a) subject to an SEC order issued under Section 203(f) of the Advisers Act; (b) convicted within the past 10 years of any felony or misdemeanor involving conduct described in Section 203(e)(2)(A)-(D) of the Advisers Act; (c) found by the SEC to have engaged, or been convicted of engaging, in any of the conduct specified in paragraphs (1), (5) or (6) of Section 203(e) of the Advisers Act; or (d) subject to an order, judgment or decree described in Section 203(e) of the Advisers Act.

(f) Due to the reliance that GEAM intends to place on Genworth's asset retention and introductory services, as well as the confidential information that Genworth possesses, and may in the future obtain, about GEAM's business processes and procedures, the parties agree that Genworth will exclusively provide introductory services to GEAM with respect to large domestic or foreign defined benefit or defined contribution plans, as described in Section 7(c)(i) of this Agreement, and that Genworth is required to exert commercially reasonable efforts in connection with the introduction services on behalf of GEAM, unless otherwise agreed to in writing.

#### 5. Representation, Warranties and Covenants of GEFAHI and GEAM.

(a) GEFAHI is a company duly organized, validly existing and in good standing under the laws of Delaware and has the power and authority to execute, deliver and perform this Agreement.

(b) This Agreement is the valid and binding obligation of GEFAHI enforceable against it in accordance with its terms, except as enforceability may be limited by bankruptcy, insolvency, moratorium or other similar laws affecting creditor's rights generally or the principles governing the availability of equitable remedies.

(c) GEAM is a company duly organized, validly existing and in good standing under the laws of Delaware and has the power and authority to execute, deliver and perform this Agreement.

(d) This Agreement is the valid and binding obligation of GEAM enforceable against it in accordance with its terms, except as enforceability may be limited by bankruptcy,

3

---

insolvency, moratorium or other similar laws affecting creditor's rights generally or the principles governing the availability of equitable remedies.

(e) GEAM represents, warrants and covenants that it is registered, and will maintain its registration, as an investment adviser with the SEC and that GEAM has made, and will make, all notice filings as required by any state in which GEAM is required to do so.

(f) Except with respect to any contractual or other restrictions prohibiting the disclosure or sharing of certain information, GEAM will make all data related to the services to be provided herein available for the performance of those services, including but not limited to transactional and financial data required for the preparation of regulatory filings and customer and other relevant data required for the performance of retention services.

(g) GEAM will make customer and assets under management data available for verification of the fee payment under the fee schedule.

**6. Compensation.** In consideration for its agreements set forth herein, GEFAHI shall compensate Genworth according to the schedule attached herein at Exhibit A. The compensation will be calculated based upon the ending asset balance as of the last business day of March, June, September and December on which the New York Stock Exchange is open for business. The quarterly payments shall be made no later than the last business day of each of April, July, October and January on which banks in both New York, New York and Richmond, Virginia are generally open for business. All payments will be made by wire transfer to an account designated by Genworth. Except in those instances where GEFAHI specifically agrees in writing to reimburse Genworth for reasonable travel, entertainment or other expenses, Genworth shall bear all expenses incurred by Genworth in providing services identified in Sections 1, 2 and 3 of this Agreement, including any compensation to be paid to its officers, directors and employees with respect to any introduction services performed hereunder as described in Section 3 of this Agreement. In no case shall the amount of compensation payable to Genworth exceed \$10 million on an annual basis, except to the extent GEFAHI has specifically agreed in advance in writing to make certain reimbursements of expenses as provided above.

#### 7. Termination.

(a) This Agreement shall terminate on the fourth anniversary of the effective date of this Agreement.

(b) Notwithstanding Section 7(a):

(i) GEFAHI and GEAM jointly may terminate this Agreement at any time on sixty days written notice to Genworth if they reasonably determine that Genworth has failed to provide the services described in Sections 1, 2 and 3 of this Agreement and Genworth has not cured its failure in a reasonably acceptable manner by the end of the sixty day period;

4

---

(ii) GEFAHI and GEAM jointly may terminate this Agreement immediately without any further obligation if, during the term of this Agreement, Genworth or any affiliated entity engages in the institutional asset management business;

(iii) Genworth may terminate this Agreement for any reason on sixty days written notice to GEFAHI, in which case GEFAHI shall pay Genworth within thirty days following the termination date (i.e., the last day of such sixty-day notice period) a pro rata portion of the quarterly fee referred to in Section 6 of this Agreement based on the number of days elapsed during the year and the ending asset balance on the termination date; and

(iv) Genworth may terminate this Agreement if GEFAHI or GEAM is in breach of any representation, warranty or covenant in Section 5 of this Agreement and GEFAHI and GEAM jointly may terminate this agreement if Genworth is in breach of any representation, warranty or covenant in Section 4 of this Agreement, provided, however, that the party seeking to terminate the Agreement has provided to the other party a written notification at least sixty days in advance specifying the representation, warranty or covenant that the other party has breached and the other party has failed to cure the breach by the end of the sixty day period.

(c) For purposes of Section 7(b)(ii):

(i) The term "institutional asset management services" means (A) serving as an investment adviser or sub-adviser to any large domestic or foreign defined benefit or defined contribution plans (meaning those over \$10 million in assets), including, but not limited to, employer-sponsored pension and profit sharing plans and plans that meet the requirements for qualification under Section 401 (a), 403(b) or 457 of the Internal Revenue Code, or to any mutual funds or other commingled accounts offered principally to such investors, or (B) providing solicitation or introduction services (as described in Section 3) with respect to any large plans as described above for itself, any affiliated entity that is an investment adviser or any other investment adviser. Notwithstanding the foregoing and the limitation set forth in Section 4(f) hereof, the term "institutional asset management services" shall not include serving as an investment adviser for, or providing solicitation or introduction services (as described

in Section 3) with respect to, any domestic or foreign defined benefit or defined contribution plan, provided that (X) the advice is given to, or services relate to, no more than \$50 million of the plan's total investment portfolio and (Y) the advice exclusively consists of, or the services exclusively relate to, recommendations provided on a discretionary or non-discretionary basis through an investment advisory program (including a mutual fund asset allocation program) that substantially meets the conditions of Rule 3a-4 under the Investment Company Act of 1940, as amended, and is commonly referred to as a "wrap" or "mini" account program. Notwithstanding Section 7(c)(i)(X) above, the total value of large defined benefit or defined contribution plan assets with respect to which the investment advice is provided constitutes no more than 15% of the aggregate value of all assets under management by Genworth and its affiliated entities, and no more than 15% of the gross revenue received by Genworth or its affiliated entities from solicitation or introduction services is derived from providing such services to unaffiliated entities (excluding GEAM) with respect to investment advice that is provided to any large plans, as described above. This definition is not intended to limit the ability of Genworth to provide

5

advice in connection with the offering of its annuity or insurance products or managing the underlying assets supporting such products.

(ii) The term "affiliated entity" means (A) any entity controlled by Genworth for so long as Genworth and GEAM are under common control with each other and, (B) any entity that controls, is controlled by and is under common control with Genworth if Genworth and GEAM are no longer under common control with each other. The term "control" shall have the same meaning as used in the Advisers Act.

(iii) The terms "Genworth" and "affiliated entity" do not include any person engaged by Genworth or an affiliated entity as an independent contractor to the extent such person is (A) acting outside the scope of such engagement and (B) receiving no compensation from Genworth or an affiliated entity for such outside activities.

**8. Notices.** Any written notices pursuant to this Agreement shall be sent by hand, facsimile transmission, or certified mail, return receipt requested, as follows:

If to Genworth:

Genworth Financial, Inc.  
6604 West Broad Street  
Richmond, VA 23230  
Attn: Chief Financial Officer- Retirement  
Income & Investments or General Counsel-  
Retirement Income & Investments  
Telecopier Numbers: 804-281-6165 (CFO)  
804-281-6005 (GC)

If to GEFAHI or GEAM:

GE Financial Assurance Holdings, Inc.  
GE Asset Management Incorporated  
3003 Summer Street  
Stamford, CT 06904  
Attn: GEAM General Counsel  
Telecopier Numbers: 203-326-4177  
203-708-3107

**9. Indemnification.** Each party (as such, an "indemnifying party" hereunder) agrees to indemnify, hold harmless, reimburse and defend the other party, and such other party's officers, directors and employees (in such capacity collectively, "indemnified parties" and, individually, an "indemnified party"), from and against any and all claims (whether asserted against an indemnified party or otherwise), losses, damages, liabilities, obligations and expenses, including, without limitation, settlement costs and any reasonable legal, accounting and other expenses for defending any actions brought or threatened in writing, (collectively, "Losses") reasonably incurred by such indemnified parties arising out of or in connection with the breach of any representation, warranty, covenant or obligation in this Agreement by the indemnifying party, except to the extent arising out of or based on a breach of any representation, warranty, covenant or obligation in this Agreement by the indemnified parties or any grossly negligent act or omission of the indemnified parties with respect to the subject matter of this Agreement.

Whenever any claim for indemnification arises under this Section 9, the indemnified party will promptly notify the indemnifying party of the claim and, when known, the facts constituting the basis for such claim and the amount or an estimate of the amount of the liability arising therefrom. At its option, the indemnified party may defend itself against any claim

6

subject to indemnification under this Section 9, in which case the indemnifying party will pay all reasonable attorney's fees and costs thus incurred but will no longer be obligated to defend the indemnified party against such claim. In each case in which the indemnified party does not exercise the foregoing option, the indemnified party may require the indemnifying party to defend the former against the claim(s) and to bear all costs and fees incurred in doing so. In such event, the indemnified party may participate in defense of the claim(s) by retaining its own counsel, whose fees and costs it then will pay, and whether or not the indemnified party elects to participate in the defense, the indemnifying party may not settle or compromise such claim(s) in a manner which adversely affects the indemnified party without the latter's written consent beforehand, which consent will not be unreasonably withheld.

**10. Arbitration.** Any controversy or claim between the parties hereto arising out of this Agreement or its breach, shall be settled by arbitration to be held in New York, New York. Each party will choose one arbitrator, and the arbitrators shall then appoint a third arbitrator. The arbitrators shall hold a hearing and render an award in accordance with the rules of the American Arbitration Association. Judgment upon the award rendered by a majority of the arbitrators may be entered in any court having jurisdiction. The arbitrators shall base their decision upon the custom and usage of the business in the spirit of equity, and are relieved from judicial formalities and from following strict rules of evidence. The expenses of the arbitrator chosen by each of the parties shall be borne by the respective party, and the expenses of the third arbitrator shall be borne equally by the opposing sides to the controversy or claim.

**11. Governing Law.** This Agreement is made and shall be construed under the laws of the State of New York.

**12. Confidentiality.** Each party agrees to hold all information it receives from another party relating to this Agreement in strict confidence. Any information provided by one party to another party under this Agreement shall be used solely for the purposes of this Agreement. Each party may disclose such information only (i) as may be required by law, or (ii) to its affiliates and their respective personnel who have a need to know and agree to such duty to keep it confidential and to use it solely for the purposes of this Agreement. Each party agrees to take all reasonable steps to safeguard the information provided to it by another party under this Agreement, including without limitation, those steps it takes to protect its own confidential or proprietary information. Upon written request by a party that provides information to another party under this agreement, such other party shall either return such information or destroy it (and provide a certification of such action taken). In addition, in the case of a request to return or destroy written information provided under this Agreement, the recipient party shall retain no copies of such information, except as may be required by law. Notwithstanding the foregoing, no party to this Agreement shall be under any obligation to restrict the use or disclosure of, or to refrain from retaining copies of, any information that (i) is already available to, or in the possession of the party prior to its receipt of such information under this Agreement, and not otherwise subject to an obligation of confidentiality, (ii) is independently developed by the party, (iii) is or becomes available in the public domain on or after the date it is received by the party (other than as a result of a disclosure by the party or any of its employees in breach of this Agreement), or (iv) is acquired from a

7

person who is not known by the party to be in breach of an obligation of confidentiality to the party that provides such information.





**CONFIDENTIAL TREATMENT REQUESTED: INFORMATION FOR WHICH  
CONFIDENTIAL TREATMENT HAS BEEN REQUESTED IS OMITTED AND NOTED  
WITH “\*\*\*”. AN UNREDACTED VERSION OF THIS DOCUMENT HAS ALSO BEEN  
PROVIDED TO THE SECURITIES AND EXCHANGE COMMISSION.**

**AMENDED AND RESTATED  
MASTER OUTSOURCING AGREEMENT**

by and between

General Electric Capital Assurance Company

and

GE Capital International Services

[Date]

**TABLE OF CONTENTS**

<a href="#">1.0</a>	<a href="#">Services</a>
<a href="#">1.1</a>	<a href="#">Structure of the Agreement</a>
<a href="#">1.2</a>	<a href="#">Business Continuity and Disaster Recovery Services</a>
<a href="#">1.3</a>	<a href="#">PROVIDER Responsibilities</a>
<a href="#">1.4</a>	<a href="#">Service Locations; Security</a>
<a href="#">1.5</a>	<a href="#">Support of CUSTOMER Divestitures</a>
<a href="#">1.6</a>	<a href="#">PROVIDER Divestitures</a>
<a href="#">1.7</a>	<a href="#">New Services</a>
<a href="#">1.8</a>	<a href="#">Services Not to be Withheld; PROVIDER Relief</a>
<a href="#">2.0</a>	<a href="#">Charges</a>
<a href="#">2.1</a>	<a href="#">Generally</a>
<a href="#">2.2</a>	<a href="#">Discount Factor</a>
<a href="#">2.3</a>	<a href="#">Adjustment of Charges</a>
<a href="#">2.4</a>	<a href="#">Renewal Pricing</a>
<a href="#">2.5</a>	<a href="#">Reduction in Work</a>
<a href="#">2.6</a>	<a href="#">Currency</a>
<a href="#">2.7</a>	<a href="#">Taxes</a>
<a href="#">2.8</a>	<a href="#">Foreign Currency Hedging</a>
<a href="#">2.9</a>	<a href="#">Continuous Improvement; Planning</a>
<a href="#">3.0</a>	<a href="#">Billing and Payment</a>
<a href="#">3.1</a>	<a href="#">Invoices</a>
<a href="#">3.2</a>	<a href="#">Payments</a>
<a href="#">3.3</a>	<a href="#">Reimbursements</a>
<a href="#">3.4</a>	<a href="#">Method of Payment</a>
<a href="#">3.5</a>	<a href="#">Notice of Default</a>
<a href="#">3.6</a>	<a href="#">PROVIDER Termination for Non-Payment</a>
<a href="#">3.7</a>	<a href="#">Past Due Amounts</a>
<a href="#">4.0</a>	<a href="#">Performance Standards</a>
<a href="#">4.1</a>	<a href="#">Generally</a>
<a href="#">4.2</a>	<a href="#">Measurement and Reporting</a>
<a href="#">4.3</a>	<a href="#">Compliance</a>
<a href="#">4.4</a>	<a href="#">Additional Remedies</a>
<a href="#">5.0</a>	<a href="#">Record Keeping and Audits</a>
<a href="#">5.1</a>	<a href="#">Generally</a>
<a href="#">5.2</a>	<a href="#">Reports and Certifications</a>
<a href="#">6.0</a>	<a href="#">CUSTOMER Commitments</a>
<a href="#">6.1</a>	<a href="#">System Access</a>
<a href="#">6.2</a>	<a href="#">Data Integrity</a>
<a href="#">6.3</a>	<a href="#">Training</a>

<a href="#">7.0</a>	<a href="#">Term.</a>
	<a href="#">7.1</a> <a href="#">Initial Term</a>
	<a href="#">7.2</a> <a href="#">Limitation on Termination of MOAs; Renewal</a>
<a href="#">8.0</a>	<a href="#">Termination.</a>
	<a href="#">8.1</a> <a href="#">Termination for Cause by CUSTOMER</a>
	<a href="#">8.2</a> <a href="#">Termination by PROVIDER</a>
	<a href="#">8.3</a> <a href="#">Termination for Convenience</a>
	<a href="#">8.4</a> <a href="#">Termination Right Related to Damages Cap.</a>
	<a href="#">8.5</a> <a href="#">Termination Right Relating to Change of Control of CUSTOMER</a>
	<a href="#">8.6</a> <a href="#">Continued Performance</a>
<a href="#">9.0</a>	<a href="#">Obligations on Expiration and Termination.</a>
	<a href="#">9.1</a> <a href="#">Services Transfer Assistance</a>
	<a href="#">9.2</a> <a href="#">Carve-Out Option</a>
<a href="#">10.0</a>	<a href="#">Assignment and Subcontracting</a>
	<a href="#">10.1</a> <a href="#">PROVIDER Assignment</a>
	<a href="#">10.2</a> <a href="#">Subcontracting</a>
	<a href="#">10.3</a> <a href="#">CUSTOMER Assignment</a>
<a href="#">11.0</a>	<a href="#">Confidentiality</a>
	<a href="#">11.1</a> <a href="#">Obligations of PROVIDER</a>
	<a href="#">11.2</a> <a href="#">Obligations of CUSTOMER</a>
	<a href="#">11.3</a> <a href="#">Required Disclosures</a>
	<a href="#">11.4</a> <a href="#">HIPAA Addendum</a>
	<a href="#">11.5</a> <a href="#">Data Ownership</a>
<a href="#">12.0</a>	<a href="#">Indemnities</a>
	<a href="#">12.1</a> <a href="#">Indemnity by PROVIDER</a>
	<a href="#">12.2</a> <a href="#">Indemnity by CUSTOMER</a>
	<a href="#">12.3</a> <a href="#">Indemnification Obligations Net of Insurance Proceeds and Other Amounts, On an After-Tax Basis</a>

	<a href="#">12.4</a> <a href="#">Procedures for Indemnification of Third Party Claims</a>
	<a href="#">12.5</a> <a href="#">Additional Matters</a>
	<a href="#">12.6</a> <a href="#">Remedies Cumulative; Limitations</a>
<a href="#">13.0</a>	<a href="#">Limitation of Liability</a>
	<a href="#">13.1</a> <a href="#">No System Liability</a>
	<a href="#">13.2</a> <a href="#">Liability for Simple Breach</a>
	<a href="#">13.3</a> <a href="#">Liability for Excluded Matters</a>
	<a href="#">13.4</a> <a href="#">No Liability for Acts in Accordance with Instructions</a>
<a href="#">14.0</a>	<a href="#">PROVIDER Employees</a>
<a href="#">14.1</a>	<a href="#">Responsibility for PROVIDER Employees</a>
<a href="#">15.0</a>	<a href="#">Representations, Warranties and Covenants</a>
	<a href="#">15.1</a> <a href="#">PROVIDER Representations</a>
	<a href="#">15.2</a> <a href="#">CUSTOMER Representations</a>
	<a href="#">15.3</a> <a href="#">Approvals and Consents</a>
	<a href="#">15.4</a> <a href="#">Cooperation</a>
<a href="#">16.0</a>	<a href="#">Notices</a>
<a href="#">17.0</a>	<a href="#">Intellectual Property</a>
<a href="#">18.0</a>	<a href="#">Non-Compete</a>
	<a href="#">18.1</a> <a href="#">Limitations on Provision of Services</a>
	<a href="#">18.2</a> <a href="#">Volume Reduction Date</a>
	<a href="#">18.3</a> <a href="#">Equitable Relief</a>
<a href="#">19.0</a>	<a href="#">Change Control Procedure</a>
<a href="#">20.0</a>	<a href="#">Governance</a>
	<a href="#">20.1</a> <a href="#">PROVIDER Account Executive</a>
	<a href="#">20.2</a> <a href="#">CUSTOMER Account Executive</a>
	<a href="#">20.3</a> <a href="#">Key Employees of PROVIDER</a>
	<a href="#">20.4</a> <a href="#">Meetings</a>
	<a href="#">20.5</a> <a href="#">Operational Dispute Resolution</a>

[21.0](#)      [Miscellaneous](#)

- [21.1](#)      [Force Majeure](#)
- [21.2](#)      [Independent Contractors](#)
- [21.3](#)      [Failure to Object Not a Waiver](#)

iii

---

- [21.4](#)      [Governing Law](#)
- [21.5](#)      [No Third-Party Beneficiaries](#)
- [21.6](#)      [Public Announcements](#)
- [21.7](#)      [Entire Agreement](#)
- [21.8](#)      [Amendment](#)
- [21.9](#)      [Rules of Construction](#)
- [21.10](#)     [Severability](#)
- [21.11](#)     [Remedies Not Exclusive](#)
- [21.12](#)     [Dispute Resolution](#)
- [21.13](#)     [Language](#)
- [21.14](#)     [Survival](#)

[22.0](#)      [Attachments](#)

- |                           |   |
|---------------------------|---|
| <a href="#">Exhibit A</a> | <a href="#">Definitions</a>                             |
| <a href="#">Exhibit B</a> | <a href="#">Local Modifications to Master Agreement</a> |
| <a href="#">Exhibit C</a> | <a href="#">Form of PSA</a>                             |
| <a href="#">Exhibit D</a> | <a href="#">BCP/DRP Plans</a>                           |
| <a href="#">Exhibit E</a> | <a href="#">Security Procedures</a>                     |
| <a href="#">Exhibit F</a> | <a href="#">Pricing Template</a>                        |
| <a href="#">Exhibit G</a> | <a href="#">Dispute Resolution</a>                      |
| <a href="#">Exhibit H</a> | <a href="#">Carve-Out Option</a>                        |
| <a href="#">Exhibit I</a> | <a href="#">Intellectual Property</a>                   |
| <a href="#">Exhibit J</a> | <a href="#">Business Associate Addendum</a>             |
| <a href="#">Exhibit K</a> | <a href="#">Change Control Procedure</a>                |
| <a href="#">Exhibit L</a> | <a href="#">PSAs and Base Costs</a>                     |

iv

---

**AMENDED AND RESTATED  
MASTER OUTSOURCING AGREEMENT**

AMENDED AND RESTATED MASTER OUTSOURCING AGREEMENT (“Agreement”) entered into as of the Execution Date, by and between General Electric Capital Assurance Company, a Delaware insurance company, with offices at 6604 West Broad Street, Richmond, Virginia 23230 (“CUSTOMER”) and GE Capital International Services, a corporation duly formed and existing under the laws of India with a place of business at AIFGECIS Building, 1 Rafi Marg, Delhi-110001 and Corporate office at 90A Sector 18, Gurgaon, Haryana (“PROVIDER”).

RECITALS

WHEREAS, PROVIDER and CUSTOMER are parties to a Master Outsourcing Services Agreement and one or more related Project Specific Agreements which incorporate the terms of such Master Outsourcing Services Agreement, as well as certain other services agreements (“PSAs”);

WHEREAS, CUSTOMER is a Subsidiary of Genworth Financial, Inc., a Delaware corporation (“Genworth”);

WHEREAS, General Electric Company and General Electric Capital Corporation have determined to consolidate the Genworth business, including Genworth and certain of its Affiliates, into a separate corporate structure with Genworth acting as the parent entity for the Genworth business, and have further determined to divest a controlling interest in the stock of Genworth (the “Separation”) and, as part of such divestiture, to conduct an initial public offering of the common stock of Genworth (the “IPO”);

WHEREAS, in anticipation of the proposed Separation, PROVIDER and CUSTOMER have determined that it is appropriate to amend and restate such Master Outsourcing Services Agreement in the form of this Amended and Restated Master Outsourcing Services Agreement;

WHEREAS, PROVIDER supplies business and financial and related support services;

WHEREAS, CUSTOMER requires the performance of Services, as defined in the related PSA(s);

WHEREAS, the parties contemplate that PROVIDER will handle a variety of outsourcing projects and services for CUSTOMER and the parties seek to define the basic terms applicable to outsourcing projects between the parties; the parties intend to incorporate these provisions by reference into the outstanding PSAs and PSAs that they enter into for specific outsourcing projects hereafter;

WHEREAS, this Agreement is being executed on, and shall take effect as of, the closing date of the IPO or, if regulatory approval occurs on a later date, on and as of such later date (the “Execution Date”); and

---

WHEREAS, capitalized terms used herein shall have the meanings given such terms in [Exhibit A](#) hereto.

NOW, THEREFORE, in consideration of the premises, and other good and valuable consideration, the receipt and sufficiency of which are hereby acknowledged, the parties hereto agree as follows:

1.0 Services.1.1 Structure of the Agreement.

(a) The Services are governed by the terms of this Agreement as amended and/or supplemented as set forth in Exhibit B, and the PSAs. Each PSA executed after the Execution Date shall be in the form attached as Exhibit C, unless otherwise agreed to by the parties.

(b) PROVIDER agrees to provide the Services under the terms and conditions of this Agreement and as more specifically described in the PSAs.

1.2 Business Continuity and Disaster Recovery Services. PROVIDER shall provide the services set forth in the business continuity and disaster recovery plans referred to in Exhibit D (collectively, the “BCP/DRP Plans”). The BCP/DRP Plans shall address all operations identified by CUSTOMER as “Mission Critical;” shall meet the substantive requirements specified by CUSTOMER and shall be agreed upon by CUSTOMER and PROVIDER. Further, at no additional charge to CUSTOMER other than as provided in Section 2 and the Pricing Template set forth in Exhibit E, PROVIDER will (a) actively review and update the BCP/DRP Plans, (b) test the BCP/DRP Plans at least annually, (c) permit CUSTOMER the opportunity to participate in such testing, (d) give CUSTOMER access to the results and analysis of such testing, and (e) correct deficiencies in the BCP/DRP Plans revealed by such testing. Failure to provide the services described in such BCP/DRP Plans will constitute a material breach of this Agreement, subject to cure as set forth in Section 8.1(f).

1.3 PROVIDER Responsibilities. Except as otherwise noted in this Agreement, PROVIDER shall provide, at its expense, all materials, labor, equipment, facilities and other items necessary to deliver the Services. Subject to Section 6.3 herein, all employees performing the Services shall be skilled in their trades and licensed, if required, by all proper authorities.

1.4 Service Locations; Security. Except as provided in the BCP/DRP Plans, without the prior written consent of CUSTOMER, PROVIDER shall not change or move the original location for the performance by PROVIDER of the Services required under this Agreement. In performing the Services, operating the Facilities used by it to provide the Services and protecting CUSTOMER’s data, information and other property, PROVIDER will comply with the security procedures set forth in Exhibit E of this Agreement.

2

1.5 Support of CUSTOMER Divestitures. If CUSTOMER divests any business operation (other than pursuant to a transaction that would constitute a Change of Control), PROVIDER will provide the Services to such operation if such operation (i) used the Services prior to being divested, (ii) after being divested uses either essentially the same services as before being divested, or CUSTOMER or the acquiring entity compensates PROVIDER to modify its systems or processes used to perform and provide the Services as necessary to accommodate the use of the Services as reasonably requested by the acquiring entity, (iii) the acquiror of such operation agrees to be subject to the provisions of this Agreement and the PSAs, and (iv) CUSTOMER is not in payment default at the time of the request, but, in that case, PROVIDER must provide the Services if paid in advance. At CUSTOMER’s option, PROVIDER and such acquiror shall enter into a separate agreement and PSA(s) providing for the provision of the Services, which agreements shall be on substantially the same terms and conditions as are set forth in this Agreement and the PSA(s), with such changes therein as the parties may agree upon. PROVIDER shall charge for the continuing performance and delivery of such Services based on the then-existing charging methodologies and may charge CUSTOMER or the acquiring entity for the reasonable implementation and set-up fees relating to the extension of the Services to such entity approved in writing in advance. PROVIDER and the acquiring entity will negotiate in good faith for up to one hundred twenty (120) days following the divestiture to agree upon alternative terms and conditions that will apply to the provision of the Services to such entity by PROVIDER. If they are unable to so agree, at the request of the acquiring entity, PROVIDER shall be required to provide the Services to such acquiring entity until the earlier of (i) the last day of the twelfth (12<sup>th</sup>) month following such 120-day negotiation period and (ii) the termination date of this Agreement and related PSAs, provided, that if such termination date is to occur later than twelve (12) months following the end of such 120-day period and PROVIDER is requested to provide such Services for less than twelve (12) months following the end of such period, such acquiring entity or CUSTOMER shall bear all costs actually incurred by PROVIDER as a result of such reduction in volume, provided, further, that PROVIDER shall use commercially reasonable efforts to mitigate such costs. Such Services shall be provided by PROVIDER regardless of whether the acquiring entity is a competitor of the GE Group. PROVIDER shall provide Services Transfer Assistance as reasonably requested by the acquiror, solely at the acquiror’s cost, for the period during which PROVIDER is required to provide Services to such acquiror.

1.6 PROVIDER Divestitures. If PROVIDER executes a definitive agreement to divest any or part of any business operation relating to the Services provided to CUSTOMER other than the CUSTOMER India operations operating on a stand-alone basis (specifically, the operations responsible for providing core services exclusively relating to long term care, life insurance, group insurance, annuities, retirement plans and mortgage insurance to CUSTOMER, but excluding, *inter alia*, accounting, help desk, software solutions, e-learning and other knowledge-based operations, collectively, the “Genworth Stand-Alone Operations”) (a “PROVIDER Divestiture”), PROVIDER will provide no less than thirty (30) days’ prior written notice of the expected closing date of the PROVIDER Divestiture to CUSTOMER, which notice will include the identity of the acquiror and any Affiliate which would provide Services to CUSTOMER and a description of the material terms of the transaction applicable to the Services being transferred to the acquiror. PROVIDER will provide CUSTOMER with such further

3

information regarding the divestiture and the acquiror as CUSTOMER may reasonably request. CUSTOMER may take no action with respect to the proposed PROVIDER Divestiture (in which case the PROVIDER Divestiture may proceed without CUSTOMER’s consent) or, within thirty (30) days of receipt of such notice from PROVIDER, CUSTOMER may at its option (i) exercise the Carve-Out Option (as more fully described in Section 9.2 hereof) only with respect to the Carve-Out Resources relating to such Services which are being or have been divested to the acquiring entity at a purchase price equal to the lesser of book value or the value of the divested operations relating to CUSTOMER implied by the consideration to be paid by the acquiror and/or (ii) terminate the PSAs affected by the PROVIDER Divestiture and require PROVIDER and/or the acquiror to provide Services Transfer Assistance for a period not exceeding fourteen (14) months from the date of receipt of notice by PROVIDER from CUSTOMER. Notwithstanding any other provision of this Agreement, PROVIDER shall be responsible for all transition costs incurred by CUSTOMER relating to its exercise of the Carve-Out Option or its termination of the PSAs and transition of the Services in-house or to a new PROVIDER. Any transfer of the PSAs pursuant to this paragraph shall be subject to the receipt by CUSTOMER of all necessary regulatory approvals. For the avoidance of doubt, any transfer by PROVIDER of the Genworth Stand-Alone Operations shall be subject to the limitations described under Section 10.0 hereof.

1.7 New Services. From time to time, CUSTOMER may request that PROVIDER furnish additional services to CUSTOMER that are not within the scope of the Services (“New Services”). PROVIDER will discuss with CUSTOMER such request and the ramifications of such additional services on the existing Services, but will not be obligated to provide such additional services. Such requests shall be addressed through the Change Control Procedure described in Section 19.0 hereof. CUSTOMER shall bear all costs agreed in advance between the parties and incurred by PROVIDER on account of transition or migration of New Services from CUSTOMER to PROVIDER.

1.8 Services Not to be Withheld; PROVIDER Relief Except as provided in Section 8.2 and 21.1 hereof (it being understood that Force Majeure will not relieve PROVIDER of its responsibility to provide the Services set forth in the BCP/DRP Plans), PROVIDER shall not voluntarily refuse to provide all or any portion of the Services in violation or breach of the terms of the Agreement or any related PSA. PROVIDER shall be relieved from its obligation to perform any Services and its obligations to pay any service credit under a PSA to the extent it is unable to perform any Services or to perform in accordance with any applicable Performance Standard as a result of CUSTOMER’s failure to perform its obligations under such PSA. Notwithstanding the dispute resolution provisions set forth in Section 21.12, if PROVIDER

breaches this covenant, CUSTOMER shall be entitled to apply to a court of competent jurisdiction for specific performance by PROVIDER of its obligations under this Agreement and the related PSAs without the necessity of posting any bond.

## 2.0 Charges.

2.1 Generally. Notwithstanding any provision related to fees and charges in a PSA to the contrary, as consideration for the provision of the Services, CUSTOMER will pay to PROVIDER the charges calculated as set forth in this Section 2.0 (the "Charges"). The Charges

4

in effect immediately prior to the Execution Date shall be referred to as the "Baseline Charges". For existing PSAs, the Baseline Charges and the Charges for the initial Contract Year (or part thereof) shall be as set forth on Exhibit L. For PSAs executed after the Execution Date, the Baseline Charges shall be set forth in each such PSA. The Charges shall be adjusted annually to reflect changes in PROVIDER's Base Costs and to reflect scheduled discounts from the Baseline Charges pursuant to the following formula:

New Charges = Baseline Charges \* Discount Factor \* Cost Factor

2.2 Discount Factor. For the periods indicated, the "Discount Factor" shall mean and be as follows:

<u>Period</u>	<u>Discount Factor</u>
from the Execution Date through the first anniversary of the Trigger Date (as defined below)	**
from the first anniversary of the Trigger Date through the second anniversary of the Trigger Date	**
from the second anniversary of the Trigger Date through the third anniversary of the Trigger Date	**

"Cost Factor" means and shall be calculated as follows:

$$Y(n) \text{ Base Cost} / Y(0) \text{ Base Cost}$$

where Y(n) Base Cost is determined pursuant to Section 2.3 for each Contract Year, Y(n-1) Base Cost is the Base Cost for the preceding Contract Year and Y(0) Base Cost is the Base Cost for the initial Contract Year, as set forth in Exhibit L.

2.3 Adjustment of Charges. Prior to the commencement of each Contract Year, the parties will negotiate in good faith to agree upon the elements of Base Cost and the rates to be charged to CUSTOMER for such elements during such year (excluding the cost of hedging foreign currency exchange risks, which shall be charged to CUSTOMER on a pass-through basis as described in Section 2.8). The parties will reflect their agreement on such matters in a written document to be executed by each of them and the Charges for the Services in such year shall not exceed the agreed amounts. Any amendment or addition to such elements or rates must be approved by CUSTOMER in advance in writing. If the parties are unable to agree upon such matters, the Cost Factor for the applicable year shall be calculated using Base Cost as determined by PROVIDER in accordance with the definition of Base Cost, provided, that Base Cost for any Contract Year shall not exceed one hundred five percent (105%) of Base Cost for the immediately preceding Contract Year. If Base Cost relating to any PSA for any Contract Year during the Initial Term exceeds one hundred five percent (105%) of Base Cost for the immediately preceding Contract Year, CUSTOMER may terminate that PSA upon at least six (6) months' written notice to PROVIDER and shall not be liable for any costs incurred by PROVIDER as a result of such termination.

5

2.4 Renewal Pricing. As described in Section 7.2, at least eighteen (18) months prior to the expiration of the Initial Term, PROVIDER will propose in writing to CUSTOMER revised methods for calculating Base Cost and Charges to CUSTOMER under the Base Cost and Baseline Charges methodology described in this Section 2.0. The applicable charges proposed by PROVIDER for the first and second years of the renewal term shall be determined as provided in this Section 2.4 and Exhibit F, but shall reflect Discount Factors of \*\* and \*\*, respectively, provided, that such charges shall be at least as favorable to CUSTOMER as PROVIDER's charges for similar services provided to any other CUSTOMER of PROVIDER. If the parties are unable to agree on revised costs, CUSTOMER may elect to exercise the Carve-Out Option upon expiration of this Agreement and the related PSAs, as described in Section 9.2.

2.5 Reduction in Work. CUSTOMER shall provide PROVIDER with no less than nine (9) months' written notice in advance if the amount of Services consumed by the Genworth Group under all of the outstanding MOAs will change in a manner that will result in a reduction in the Dedicated FTEs necessary to provide the Services to seventy-five percent (75%) or less of the Dedicated FTEs agreed upon by the parties for the most recent Contract Year pursuant to Section 2.3, as adjusted pursuant to any notices previously given pursuant to this Section 2.5. In such an event, PROVIDER shall bear all costs relating to such reduction in volume to the extent stated in such nine-(9) month notice. If CUSTOMER does not provide nine (9) months' advance written notice of such a reduction, CUSTOMER shall bear any facilities occupancy, technology and telecommunications costs incurred by PROVIDER resulting from such reduction, provided, that PROVIDER shall use commercially reasonable efforts to mitigate such costs.

2.6 Currency. All currency references in this Agreement are in the currency of the United States of America and all payments shall be made in such currency.

2.7 Taxes. The Charges for the Services shall be inclusive of any sales, use, gross receipts or value added, withholding, ad valorem and other taxes based on or measured by PROVIDER's cost in acquiring equipment, materials, supplies or services used by PROVIDER in providing the Services. Further, each party shall bear sole responsibility for any real or personal property taxes on any property it owns or leases, for franchises or similar taxes on its business, for employment taxes on its employees, for intangible taxes on property it owns or licenses and for taxes on its net income. If a sales, use, privilege, value added, excise, services and/or similar tax ("Tax") is assessed with respect to PROVIDER'S Charges to CUSTOMER for the provision of the Services, CUSTOMER shall be responsible for and pay the amount of any such Tax to PROVIDER or as applicable Law otherwise requires, in addition to the Charges. CUSTOMER may report and (as appropriate) pay any Taxes directly if CUSTOMER provides PROVIDER with a direct pay or exemption certificate. PROVIDER's invoices shall separately state the amounts of any Taxes PROVIDER is proposing to collect from CUSTOMER. PROVIDER shall promptly notify CUSTOMER of any claim for Taxes asserted by any applicable taxing authorities. Notwithstanding the above, CUSTOMER's liability for such Taxes is conditioned upon PROVIDER providing CUSTOMER notification within twenty (20) business days of receiving any proposed assessment of any additional Taxes, interest or penalty due by PROVIDER. PROVIDER shall coordinate with CUSTOMER the response to and settlement of, any such assessment. CUSTOMER shall be entitled to receive and to retain any refund of Taxes paid to PROVIDER pursuant to this Agreement.

6

2.8 Foreign Currency Hedging. PROVIDER shall bear all costs associated with the purchase, exchange or translation of currencies as necessary in connection with the performance of the Services. If PROVIDER elects to enter into hedging transactions with third parties relating to such risks, CUSTOMER will reimburse PROVIDER for the reasonable costs (without mark-up by PROVIDER) of such hedging transactions, provided, however, that CUSTOMER approves of the hedging strategy and the hedging contracts related to such transactions in writing as part of the annual budget process, as further described in Section 20.4.

2.9 Continuous Improvement; Planning. PROVIDER shall use commercially reasonable efforts to increase productivity and efficiency in performing the Services and shall endeavor to reduce Base Cost annually, depending on the overall reduction in its cost of operations. The parties will participate in an annual budgeting process as part of determining Base Cost that will address improvements in PROVIDER productivity and efficiency in performing the Services and dedicate appropriate resources to execute the budgeted improvements. To support PROVIDER's demand planning, each quarter, CUSTOMER shall provide PROVIDER a good faith estimate of its requirements for the Services for the following twelve (12) months.

### 3.0 Billing and Payment

3.1 Invoices. PROVIDER shall submit an invoice each month for the Charges relating to the Services provided during the prior month period. For the partial month period prior to the Execution Date, PROVIDER shall submit an invoice for Charges calculated as provided in the original Master Outsourcing Agreement and PSAs. For periods beginning on and after the Execution Date, Charges shall be calculated as set forth in this Agreement. Each invoice shall detail all information relevant to calculation of the Charges and the total amount due. PROVIDER agrees to include the information and prepare the invoice in the form as reasonably requested by CUSTOMER.

3.2 Payments. All payments, due and payable by CUSTOMER to PROVIDER, will be made within sixty (60) days of CUSTOMER's receipt of invoice ("Payment Date"). CUSTOMER shall use its good faith efforts to provide PROVIDER as promptly as practicable with the details of any objection it may have to any invoice, but any failure to provide such details shall not foreclose CUSTOMER's right to dispute such invoice. CUSTOMER shall pay the part of any invoiced amount that is not in dispute by the Payment Date.

3.3 Reimbursements. Payment of all reimbursable expenses approved by CUSTOMER in writing in advance will be made within sixty (60) days after CUSTOMER's receipt of invoice together with copies of receipts and other verification.

3.4 Method of Payment. The method of payment shall be by electronic fund transfer to PROVIDER's designated bank account or such other manner as agreed upon by the parties.

3.5 Notice of Default. If CUSTOMER does not pay any invoice by the Payment Date, PROVIDER shall serve CUSTOMER a notice pursuant to Section 16.0 (a "Payment

7

---

Default Notice") and simultaneously initiate the procedures for consideration of Disputes by senior executives of the parties by giving notice as described under Section 1.2 of Exhibit G.

### 3.6 PROVIDER Termination for Non-Payment

(a) PROVIDER shall have the right to terminate any PSA, without prejudice to any other legal rights to which it may be entitled, if CUSTOMER fails to pay to PROVIDER any material amount (i) that is undisputed or determined by the senior executives under Section 1.2 of Exhibit G to be due to PROVIDER, within five (5) business days following CUSTOMER's agreement that such amount is not in dispute or the conclusion of the senior executives' negotiations, whichever is earlier, or (ii) that remains in dispute and is not paid following the conclusion of the senior executives' negotiations contemplated by Section 3.6(b) hereof.

(b) PROVIDER shall have no right to terminate if CUSTOMER pays any disputed amount within five (5) business days following the conclusion of the senior executives' negotiations under Exhibit G, without prejudice, and invokes the remainder of the dispute resolution process set forth in Exhibit G.

(c) If pursuant to the dispute resolution process, PROVIDER is found to have charged improperly, PROVIDER shall promptly refund such excess amount along with interest at an annual rate equal to the lesser of (i) the three (3) month London Interbank Offered Rate (LIBOR) plus 100 basis points or (ii) the maximum rate of interest allowed by applicable law, from the date the payment was made through the date of the refund.

3.7 Past Due Amounts. Past due amounts (including Charges, reimbursable expenses and credits) will bear interest at an annual rate equal to the lesser of (i) the three (3) month London Interbank Offered Rate (LIBOR) plus 100 basis points or (ii) the maximum rate of interest allowed by applicable law, from the date the payment was due through the date of payment.

### 4.0 Performance Standards.

4.1 Generally. All work relating to the Services shall be completed in a professional, timely manner and shall conform to such additional Performance Standards, if any, as may be set forth in each PSA. Such Performance Standards may be revised from time to time upon the mutual agreement of the parties.

4.2 Measurement and Reporting. Unless otherwise specified, each Performance Standard shall be measured on a monthly basis. PROVIDER shall create, implement, support and maintain reports for monitoring the metrics associated with the Performance Standards and such other metrics as are mutually agreed upon by the parties on a schedule agreed upon in each PSA or within ninety (90) days after the execution of each PSA.

4.3 Compliance. PROVIDER shall perform the Services in compliance with all applicable Laws, stock exchange rules or generally accepted, statutory or regulatory accounting

8

---

or actuarial principle specified in any PSA or otherwise by CUSTOMER, in each case as applicable to the business processes of CUSTOMER performed by PROVIDER as part of the Services, just as if CUSTOMER performed the Services itself. PROVIDER shall notify CUSTOMER whenever changes in the Services or Performance Standards are necessary to comply with applicable Indian Laws. It is understood that any reference in the PSAs to standards, policies and procedures established by General Electric Company or its Affiliates, is deemed to include any replacement standards, policies and procedures established by CUSTOMER or any member of the Genworth Group, and communicated to PROVIDER, provided, that GECIS shall be entitled to recover its cost of complying with such standards, policies and procedures as part of the Charges for the Services established pursuant to Section 2 and Schedule F.

4.4 Additional Remedies. In addition to all other remedies available under this Agreement, any PSA or at law, CUSTOMER may take one or more of the following actions in the event of PROVIDER's failure to comply with the Performance Standards, provided, that CUSTOMER may not exercise any of these remedies if the failure in performance is caused by inaccurate or incomplete data or information provided by CUSTOMER:

(a) require training of all PROVIDER employees involved in performing the affected Services, the length and nature of such training to be mutually agreed upon by PROVIDER and CUSTOMER;

(b) cause the PROVIDER to correct any deficient Services at no charge or fee to CUSTOMER; or

(c) direct PROVIDER to assign additional employees to perform the Services, which instruction PROVIDER agrees to follow.

## 5.0 Record Keeping and Audits.

5.1 Generally. PROVIDER will keep appropriate records of time and costs related to the Services, as required by Law or as reasonably requested by CUSTOMER. PROVIDER shall maintain a complete audit trail for all financial and non-financial transactions resulting from or arising in connection with this Agreement and the PSAs in such manner as is required under the Genworth Records Management Policies and Indian and United States GAAP. PROVIDER will maintain such audit trail for such periods of time as may be specified in the Genworth Records Management Policies or, if no such period is specified, for such period as the parties may agree upon. PROVIDER shall provide to CUSTOMER, its auditors (including internal audit staff and external auditors), inspectors, regulators, customers and other representatives as CUSTOMER may from time to time designate in writing, access at all reasonable times to any facility or part of a facility at which either PROVIDER or any of its permitted subcontractors is providing the Services, to PROVIDER personnel, to PROVIDER's systems, policies and procedures relating to the Services, and to data and records relating to the Services for the purpose of performing audits and inspections of either PROVIDER or any of its subcontractors with respect to (i) any aspect of PROVIDER's or such subcontractor's performance of the Services, (ii) compliance with the security procedures or (iii) any other matter relevant to this Agreement, including, without

9

---

limitation, the determination and calculation of all elements of Base Cost and all other elements of the pricing mechanism described in Section 2.0 hereof and in Exhibit F. PROVIDER shall reasonably cooperate with CUSTOMER in the performance of these audits, including installing and operating audit software. If CUSTOMER requires PROVIDER to conduct any special audit other than as provided in this Section 5.1 and if the same results in any increased cost to PROVIDER, PROVIDER shall be entitled to pass on such extra costs to CUSTOMER through a special invoice, but only to the extent approved by CUSTOMER in advance.

5.2 Reports and Certifications. PROVIDER shall provide CUSTOMER such other reports and certifications relating to the Services as CUSTOMER may reasonably request, including all reports and sub-certifications necessary for officers of CUSTOMER to make the certifications required under the Sarbanes-Oxley Act of 2002 and all related rules and regulations and all related applicable stock exchange listing requirements.

## 6.0 CUSTOMER Commitments.

6.1 System Access. CUSTOMER agrees to provide to PROVIDER, at CUSTOMER'S expense, necessary access to the mainframe computer and related information technology systems (the "System") on which CUSTOMER data is processed during the times (the "Service Hours") specified in the PSAs, subject to reasonable downtime for utility outages, maintenance, performance difficulties and the like. In the event of a change in the Service Hours, CUSTOMER will provide PROVIDER with at least fifteen (15) calendar days written notice of such change.

6.2 Data Integrity. CUSTOMER will ensure that all data and information submitted by it to PROVIDER for performing the Services shall be accurate and complete and furnished in a timely manner.

6.3 Training. CUSTOMER shall provide all PROVIDER employees who are dedicated to CUSTOMER operations with training or training materials relating to business processes and regulatory matters uniquely related to the CUSTOMER business and reasonably required by such employees to meet the Performance Standards.

To the extent any non-performance or failure to meet Performance Standards by PROVIDER is due to CUSTOMER's failure to comply with this Section 6.0, such non-performance or failure shall not be considered a breach in Performance Standards and/or a breach of this Agreement by PROVIDER.

## 7.0 Term.

7.1 Initial Term. The term of this Agreement shall commence on the Execution Date and terminate on the third (3<sup>rd</sup>) anniversary of the Trigger Date (the "Common Termination Date"). The period from the Execution Date to the Common Termination Date is referred to as the "Initial Term".

10

---

7.2 Limitation on Termination of MOAs: Renewal. CUSTOMER may terminate individual PSAs prior to the Common Termination Date either for cause or for convenience as described therein or in this Agreement. CUSTOMER, however, may not terminate this Agreement, other than for cause as described in Section 8.0, prior to the Common Termination Date, unless all of the members of the Genworth Group then party to an MOA terminate all of the existing MOAs at one time. At least eighteen (18) months prior to the Common Termination Date, PROVIDER shall propose revised terms and conditions on which the Agreement may be renewed for an additional two (2) year period (the "Renewal Period"). CUSTOMER and all of the Genworth Affiliates then party to an MOA may at their sole option renew all, but not less than all, of the MOAs for the Renewal Period, provided, that CUSTOMER, such Genworth Affiliates and PROVIDER agree upon revised charges and other terms and conditions to be applicable to the Services during the Renewal Period prior to the date that is fourteen (14) months prior to the Common Termination Date (the "Notification Date"). If the parties are unable to so agree, CUSTOMER shall inform PROVIDER within fifteen (15) days following the Notification Date as to whether it will exercise the Carve-Out Option (which may only be exercised with respect to all of the then-outstanding MOAs), as described in Section 1.0 of Exhibit H and/or require PROVIDER to provide Services Transfer Assistance. If CUSTOMER, such Genworth Affiliates and PROVIDER fail to agree upon the terms for renewal of the MOAs, or if CUSTOMER fails to provide PROVIDER the notice described above, all of the MOAs will automatically terminate on the Common Termination Date and CUSTOMER shall not be entitled to exercise its Carve-Out Option or require PROVIDER to provide Services Transfer Assistance.

## 8.0 Termination.

8.1 Termination for Cause by CUSTOMER. CUSTOMER shall have the right at any time to terminate any PSA in whole or in part with respect to the affected Services, effective immediately and without prejudice to any other legal rights to which CUSTOMER may be entitled, upon the occurrence of the following events:

(a) PROVIDER becomes subject to any voluntary or involuntary order of any governmental agency prohibiting or materially impairing the performance of any of the Services;

(b) if such Services are inadequate, unsatisfactory or substantially not in conformance with the Performance Standards or if PROVIDER's representations and warranties are materially inaccurate and, upon receipt of notice thereof from CUSTOMER, PROVIDER (i) does not immediately undertake action in good faith to cure such default, and (ii) does not provide to CUSTOMER a preliminary analysis of the root cause of such default and an initial plan to cure such default within ten (10) days of such notice, and (iii) has not agreed with CUSTOMER on a definitive plan to cure such default acceptable to CUSTOMER within thirty (30) days of such notice, and (iv) has not fully cured such default within ninety (90) days of such notice or such longer period as may have been approved by CUSTOMER as part of PROVIDER's plan to cure such default;

(c) if PROVIDER or CUSTOMER, due to the actions of PROVIDER, is administratively cited by any governmental agency for materially violating, or is judicially found to have materially violated, any Law governing the performance of the Services;

11

---

(d) if a trustee or receiver or similar officer of any court is appointed for PROVIDER or for a substantial part of the property of PROVIDER, whether with or without consent;

(e) if bankruptcy, composition, reorganization, insolvency or liquidation proceedings are instituted by or against PROVIDER without such proceedings being dismissed within ninety (90) days from the date of the institution thereof; or

(f) a material breach of this Agreement or a PSA by PROVIDER (which shall include a series of non-material or persistent breaches by PROVIDER, that in the aggregate constitute a material breach or have a material and significant adverse impact (i) on the administrative, management, planning, financial reporting or operations functions of CUSTOMER or (ii) on the management of the Services), and, upon receipt of notice thereof from CUSTOMER, PROVIDER (i) does not immediately undertake action in good faith to cure such breach, and (ii) does not provide to CUSTOMER a preliminary analysis of the root cause of such breach and an initial plan to cure such breach within ten (10) days of such notice, and (iii) has not agreed with CUSTOMER on a definitive plan to cure such breach acceptable to CUSTOMER within thirty (30) days of such notice, and (iv) has not fully cured such default within ninety (90) days of such notice or such longer period as may have been approved by CUSTOMER as part of PROVIDER's plan to cure such breach, provided, that any breach referred to in Section 1.2 shall be fully cured within thirty (30) days of such notice.

Within fifteen (15) days of its notice to PROVIDER of its intent to terminate any PSA, in whole or in part, under this Section 8.1, CUSTOMER shall inform PROVIDER as to whether it will exercise its Carve-Out Option (which may only be exercised with respect to all of the outstanding MOAs, as described in Section 1.0 of Exhibit H) and/or whether it will require PROVIDER to provide Services Transfer Assistance for a period not exceeding twenty-four (24) months from the date of such notice. If CUSTOMER fails to do so, CUSTOMER shall not be entitled to exercise its Carve-Out Option and/or require PROVIDER to provide Services Transfer Assistance.

## 8.2 Termination by PROVIDER

(a) PROVIDER may not terminate this Agreement or any PSA for any reason other than (i) non-payment in accordance with Section 3.6, (ii) as described below under Section 8.4 (Termination Relating to Damages Cap) hereof and (iii) as described below under Section 8.5 (Change of Control), it being understood that PROVIDER will be relieved from its obligations to perform in accordance with the terms of this Agreement or a PSA to the extent that it is prevented from doing so as a result of the failure by CUSTOMER to perform any of its obligations under this Agreement or such PSA.

(b) Within fifteen (15) days of PROVIDER's notice to CUSTOMER of PROVIDER's intent to terminate any PSA in accordance with Sections 8.2(a) (i) or 8.2(a)(ii), CUSTOMER shall inform PROVIDER as to whether it will require PROVIDER to provide Services Transfer Assistance for a period not exceeding fourteen (14) months from the date of such notice, provided, in the case of a termination described in clause (i), that CUSTOMER has

12

---

made all outstanding payments under any invoice in accordance with Section 3.2 hereof. If CUSTOMER fails to give such notice, CUSTOMER shall not be entitled to require PROVIDER to provide Services Transfer Assistance. At PROVIDER's option, CUSTOMER shall be required to pay for Services Transfer Assistance provided under this paragraph in advance.

(c) With respect to any other breach of this Agreement or a PSA by CUSTOMER, PROVIDER will be entitled to invoke the applicable dispute resolution process under Section 21.12 hereof and pursue all remedies permitted by that process, but shall not be entitled to terminate this Agreement or any related PSA or voluntarily withhold any Services except as authorized pursuant to such process.

## 8.3 Termination for Convenience

(a) CUSTOMER may terminate any PSA in whole or in part at any time upon at least one (1) year's prior written notice to PROVIDER. Such notice shall include a commercially reasonable plan for the reduction of Services to be purchased from PROVIDER that will enable PROVIDER to mitigate all costs of such termination. PROVIDER shall be responsible for all costs that PROVIDER incurs as a result of such termination.

(b) Notwithstanding the provisions of the preceding paragraph, CUSTOMER may terminate any PSA in whole or in part at any time upon at least ninety (90) days' prior written notice to PROVIDER. In such event, CUSTOMER shall be responsible for all costs that PROVIDER incurs as a result of such termination; provided, that PROVIDER has taken all commercially reasonable steps to mitigate such costs. Such costs shall not include any element of lost profits or lost opportunity costs.

(c) Within fifteen (15) days of its notice to PROVIDER of its intent to terminate any PSA, in whole or in part, under this Section 8.3, CUSTOMER shall inform PROVIDER as to whether it will require PROVIDER to provide Services Transfer Assistance for a period not exceeding fourteen (14) months from the date of such notice. If CUSTOMER fails to do so, CUSTOMER shall not be entitled to require PROVIDER to provide Services Transfer Assistance.

## 8.4 Termination Right Related to Damages Cap

(a) If either the GE Group members or the Genworth Group members incur liability to the others under one or more MOAs in excess of the applicable Simple Breach Cap or Excluded Matters Cap and do not agree to reset to zero the amounts counted toward such cap, the members of the group that has not incurred such excess liability shall have the right to terminate all, but not less than all, of the then-outstanding MOAs for material breach. Notwithstanding the preceding sentence, CUSTOMER may only exercise the Carve-Out Option if all of the Genworth Group members party to an MOA also exercise the Carve-Out Option under their respective MOAs at the same time.

(b) Within fifteen (15) days of the notice to PROVIDER of termination of the MOAs under this Section 8.4, CUSTOMER shall inform PROVIDER as to whether it will

13

---

exercise its Carve-Out Option and/or whether it will require PROVIDER to provide Services Transfer Assistance for a period not exceeding twenty-four (24) months from the date of such notice. If CUSTOMER fails to do so, CUSTOMER shall not be entitled to exercise its Carve-Out Option and/or require PROVIDER to provide Services Transfer Assistance.

8.5 Termination Right Relating to Change of Control of CUSTOMER. If a Change of Control of Genworth occurs, PROVIDER shall, unless the parties otherwise agree during a one hundred twenty (120) day negotiation period following the Change of Control, have the right to terminate all, but not less than all, of the then-outstanding MOAs upon the later of (A) the last day of the eighteenth (18<sup>th</sup>) month following the effective date of the Change of Control or (B) the expiration of the Initial Term, provided that such termination right is exercised within fifteen (15) days following the end of the one hundred twenty (120) day negotiation period.

8.6 Continued Performance. Termination of this Agreement for any reason provided herein shall not relieve either party from its obligation to perform its



obligations hereunder up to the effective date of such termination or to perform such obligations as may survive termination.

## 9.0 Obligations on Expiration and Termination.

### 9.1 Services Transfer Assistance.

(a) PROVIDER shall cooperate with CUSTOMER to assist in the orderly transfer of the Services to CUSTOMER itself or its designee (including another services provider) in connection with the expiration, non-renewal or earlier termination of the Agreement and/or each PSA for any reason, however described, or exercise of the Carve-Out Option. The Services include "Services Transfer Assistance," which includes providing CUSTOMER and its designees and their agents, contractors and consultants, as necessary, with (i) such cooperation and other services incidental to the transfer of the Services as they may reasonably request, (ii) all or such portions of the Services as CUSTOMER may request, and (iii) such other transition services as may be provided for in any PSA. Neither the term of the Agreement nor the term of any PSA shall be deemed to have expired or terminated until the Services Transfer Assistance thereunder is completed.

(b) Upon CUSTOMER's request, PROVIDER shall provide Services Transfer Assistance commencing up to one (1) year prior to expiration or termination of the Agreement or any PSA and continuing for the periods described in this Agreement. PROVIDER shall provide the Services Transfer Assistance even in the event of CUSTOMER's material breach (other than an uncured payment default) of this Agreement or any PSA.

(c) If any Services Transfer Assistance provided by PROVIDER requires the utilization of additional resources that PROVIDER would not otherwise use in the performance of the Services, but for which there is a charging methodology provided for in the Agreement or such PSAs, CUSTOMER will pay PROVIDER for such usage at the then-current applicable Charges and in the manner set forth in the Agreement and/or applicable PSAs. If the Services Transfer Assistance requires PROVIDER to incur costs that PROVIDER would not otherwise incur in the performance of the Services under the Agreement and applicable PSAs, then

14

---

PROVIDER shall notify CUSTOMER of the identity and scope of the activities requiring that PROVIDER incur such costs and the projected amount of the charges that will be payable by CUSTOMER for the performance of such assistance. Upon CUSTOMER's prior authorization, PROVIDER shall perform the assistance and invoice CUSTOMER for such charges. CUSTOMER shall bear all costs agreed in advance between the parties and incurred by PROVIDER on account of transition/migration of services/processes from PROVIDER to CUSTOMER or its designee.

9.2 Carve-Out Option. At any time during the term of this Agreement and prior to the Volume Reduction Date, PROVIDER agrees that CUSTOMER or its designee shall have the right, upon the occurrence of any one of the Carve-Out Conditions and to the extent permissible under (i) applicable law or (ii) any existing contractual obligation of PROVIDER, to require PROVIDER to transfer to CUSTOMER the Carve-Out Resources used by PROVIDER to provide or support the provision of the Services as described in Exhibit H hereof (the "Carve-Out Option").

## 10.0 Assignment and Subcontracting.

10.1 PROVIDER Assignment. Without the prior written consent of CUSTOMER, PROVIDER shall not voluntarily, involuntarily or by operation of law, assign or otherwise transfer this Agreement, any related PSA or any of PROVIDER's rights hereunder or thereunder, except as permitted under Section 1.6 hereof. Any assignment or transfer without CUSTOMER's written consent, except as permitted under Section 1.6 hereof, shall be null and void and at the option of CUSTOMER shall constitute a material breach of this Agreement. Notwithstanding anything to the contrary above, PROVIDER shall have the right to assign this Agreement or any PSA, in whole or in part, to any Affiliate of PROVIDER upon thirty (30) days prior written notice to CUSTOMER and subject to receipt by CUSTOMER of all regulatory approvals. Following any such assignment to an Affiliate of PROVIDER, PROVIDER shall remain liable for the performance of all of PROVIDER's obligations under this Agreement and each PSA. This Agreement and all of the terms and provisions hereof will be binding upon, and will inure to the benefit of PROVIDER's successors and permitted assigns.

10.2 Subcontracting. PROVIDER shall not enter into subcontracts for the performance of the Services without the prior written consent of CUSTOMER. In the event a subcontract is proposed by PROVIDER, PROVIDER shall furnish such information as reasonably requested by CUSTOMER to enable CUSTOMER to ascertain to its satisfaction that such proposed subcontractor of PROVIDER is able to meet CUSTOMER's quality standards and comply with the terms and conditions of this Agreement. Notwithstanding CUSTOMER's consent to any subcontract, PROVIDER shall remain liable for the performance of all of PROVIDER's obligations under this Agreement and each PSA. CUSTOMER shall not be obligated to pay any person other than PROVIDER for Services rendered by any subcontractor.

10.3 CUSTOMER Assignment. Notwithstanding anything to the contrary in this Section 10.0, CUSTOMER shall have the right to assign this Agreement or any PSA, in whole or in part, to any Affiliate of CUSTOMER upon thirty (30) days prior written notice to PROVIDER and subject to receipt by CUSTOMER of all regulatory approvals. Following any such

15

---

assignment to an Affiliate of CUSTOMER, CUSTOMER shall remain liable for the performance of all of CUSTOMER's obligations under this Agreement and each PSA. This Agreement and all of the terms and provisions hereof will be binding upon, and will inure to the benefit of CUSTOMER's successors and permitted assigns.

## 11.0 Confidentiality.

11.1 Obligations of PROVIDER. From and after the Execution Date, subject to Section 11.3 and the rights of PROVIDER with respect to the CUSTOMER Licensed Technology pursuant to Exhibit I, and except as otherwise contemplated by this Agreement or any PSA, the PROVIDER shall not, and shall cause its Affiliates and their respective officers, directors, employees, and other agents and representatives, including attorneys, agents, customers, suppliers, contractors, consultants and other representatives of any Person providing financing (collectively, "Representatives"), not to, directly or indirectly, disclose, reveal, divulge or communicate to any Person other than Representatives of such party or of its Affiliates who reasonably need to know such information in providing Services to CUSTOMER or use or otherwise exploit for its own benefit or for the benefit of any third party, any CUSTOMER Confidential Information. If any disclosures are made in connection with providing Services to CUSTOMER, its Affiliates or Representatives under this Agreement, then the CUSTOMER Confidential Information so disclosed shall be used only as required to perform the Services. PROVIDER shall use the same degree of care to prevent and restrain the unauthorized use or disclosure of the CUSTOMER Confidential Information by any of its Representatives as it currently uses for its own confidential information of a like nature, but in no event less than a reasonable standard of care. For purposes of this Section 11.1, any Information, material or documents relating to the Genworth Business currently or formerly conducted, or proposed to be conducted, by any member of the Genworth Group furnished to or in possession of the PROVIDER and its Affiliates and Representatives, irrespective of the form of communication, and all notes, analyses, compilations, forecasts, data, translations, studies, memoranda or other documents prepared by PROVIDER, its Affiliates and their respective Representatives, that contain or otherwise reflect such Information, material or documents is hereinafter referred to as "CUSTOMER Confidential Information." "CUSTOMER Confidential Information" does not include, and there shall be no obligation hereunder with respect to, Information that (i) is or becomes generally available to the public, other than as a result of a disclosure by PROVIDER, its Affiliates or Representatives not otherwise permissible hereunder, (ii) PROVIDER or such Affiliate or Representative can demonstrate was or became available to such person from a source other than CUSTOMER or its Affiliates, or (iii) is developed independently by PROVIDER or such Affiliate or Representative without reference to the CUSTOMER Confidential Information; provided, however, that, in the case of clause (ii), the source of such information was not known by such persons to be bound by a confidentiality agreement with, or other contractual, legal or fiduciary obligation of confidentiality to, CUSTOMER or any of its Affiliates with respect to such information.

11.2 Obligations of CUSTOMER. From and after the Execution Date, subject to Section 11.3 and the rights of CUSTOMER with respect to the PROVIDER Licensed Technology pursuant to Exhibit I, and except as otherwise contemplated by this Agreement, CUSTOMER shall not, and shall cause its Affiliates and their respective Representatives, not to,

16

directly or indirectly, disclose, reveal, divulge or communicate to any Person other than Representatives of such party or of its Affiliates who reasonably need to know such information in providing Services to CUSTOMER or any Affiliate of CUSTOMER or use or otherwise exploit for its own benefit or for the benefit of any third party, any PROVIDER Confidential Information. If any disclosures are made in connection with providing Services to CUSTOMER or any of its Affiliates under this Agreement, then the PROVIDER Confidential Information so disclosed shall be used only as required to perform the Services. CUSTOMER and its Affiliates shall use the same degree of care to prevent and restrain the unauthorized use or disclosure of the PROVIDER Confidential Information by any of their Representatives as they currently use for their own confidential information of a like nature, but in no event less than a reasonable standard of care. For purposes of this Section 11.2, any Information, material or documents relating to the businesses currently or formerly conducted, or proposed to be conducted, by GE or any of its Affiliates (other than any member of the Genworth Group) furnished to or in possession of CUSTOMER or any of its Affiliates, irrespective of the form of communication, and all notes, analyses, compilations, forecasts, data, translations, studies, memoranda or other documents prepared by CUSTOMER or its officers, directors and Affiliates, that contain or otherwise reflect such information, material or documents is hereinafter referred to as “PROVIDER Confidential Information.” “PROVIDER Confidential Information” does not include, and there shall be no obligation hereunder with respect to, information that (i) is or becomes generally available to the public, other than as a result of a disclosure by CUSTOMER or its Representatives not otherwise permissible hereunder, (ii) CUSTOMER or such Representative can demonstrate was or became available to it from a source other than PROVIDER and its Affiliates, or (iii) is developed independently by CUSTOMER or its Representatives without reference to the PROVIDER Confidential Information; provided, however, that, in the case of clause (ii), the source of such information was not known by CUSTOMER to be bound by a confidentiality agreement with, or other contractual, legal or fiduciary obligation of confidentiality to, PROVIDER or its Affiliates with respect to such information.

11.3 Required Disclosures. If PROVIDER or its Affiliates, on the one hand, or CUSTOMER or its Affiliates, on the other hand, are requested or required (by oral question, interrogatories, requests for information or documents, subpoena, civil investigative demand or similar process) by any Governmental Authority or pursuant to applicable Law to disclose or provide any CUSTOMER Confidential Information or PROVIDER Confidential Information as applicable, the entity or person receiving such request or demand shall use all reasonable efforts to provide the other party with written notice of such request or demand as promptly as practicable under the circumstances so that such other party shall have an opportunity to seek an appropriate protective order. The party receiving such request or demand agrees to take, and cause its representatives to take, at the requesting party’s expense, all other reasonable steps necessary to obtain confidential treatment by the recipient. Subject to the foregoing, the party that received such request or demand may thereafter disclose or provide any CUSTOMER Confidential Information or PROVIDER Confidential Information, as the case may be, to the extent required by such Law (as so advised by counsel) or by lawful process or such Governmental Authority.

17

11.4 HIPAA Addendum. If PROVIDER in connection with the provision of a Service, constitutes a Business Associate (as defined in HIPAA and/or the HIPAA Privacy Rule) and uses Protected Health Information (as defined in HIPAA and/or the HIPAA Privacy Rule) generated by or entrusted to Customer, then the terms of Exhibit J shall apply with respect to such Service. CUSTOMER shall provide notice to PROVIDER of changes in HIPAA and/or the HIPAA Privacy Rule relevant to the performance of the Services and appropriate training to PROVIDER regarding compliance with HIPAA and the HIPAA Privacy Rule in accordance with Section 6.3

11.5 Data Ownership. All data, records, and reports relating to the Genworth Business and the customers of the Genworth Group (collectively, “Records”), whether in existence at the Execution Date hereof or compiled thereafter in the course of performing the Services, shall be treated by PROVIDER and its subcontractors as the exclusive property of CUSTOMER or other member of the Genworth Group and the furnishing of such Records, or access to such items by, PROVIDER and/or its subcontractors, shall not grant any express or implied interest in or license to PROVIDER and/or its subcontractors relating to such Records other than as is necessary to perform and provide the Services to the Genworth Group. Upon request by CUSTOMER at any time and from time to time and without regard to the default status of the parties under the Agreement, PROVIDER and/or its subcontractors shall promptly deliver to CUSTOMER the Records in electronic format and in such hard copy as exists on the date of the request by Customer.

## 12.0 Indemnities.

12.1 Indemnity by PROVIDER. PROVIDER agrees to indemnify, hold harmless and defend the members of the Genworth Group and their respective directors, officers, employees and agents, from and against any and all actions, liabilities, losses, damages, injuries, judgments and external expenses, including, without limitation, attorneys’ fees, court costs, sanctions imposed by a court, experts’ fees, interest or penalties relating to any judgment or settlement, and other legal expenses (including all incidental expenses in connection with such liabilities, obligations, claims or Actions based upon or arising out of damage, illness or injury (including death) to person or property caused by or sustained in connection with the performance of this Agreement) (“Liabilities”), brought, alleged or incurred by or awarded to any person who is not a member of the GE Group or the Genworth Group (a “Third Party Claim”) arising out of or based upon:

- (a) any alleged or actual violation of any Law by PROVIDER or any of its Affiliates or Representatives (excluding the Genworth Group and excluding any such violation to the extent caused by a breach of this Agreement or any PSA by any Member of the Genworth Group);
- (b) the gross negligence or willful misconduct of PROVIDER or any of its Affiliates (excluding the Genworth Group);
- (c) PROVIDER’s provision of any services to any third party from the same facilities from which the Services are provided to the CUSTOMER;

18

- (d) the improper or illegal use or disclosure of consumer information (including personal, credit or medical information) regarding any customer or potential customer of CUSTOMER in contravention of PROVIDER’s obligations under this Agreement or any PSA; and
- (e) PROVIDER’s tax liabilities arising from PROVIDER’s provision of Services, as set forth in Section 2.7 hereof.

12.2 Indemnity by CUSTOMER. CUSTOMER agrees to indemnify, hold harmless and defend PROVIDER, each other member of the GE Group, and their respective directors, officers, employees and agents, from and against any and all Liabilities relating to any Third Party Claim arising out of or based upon the provision of Services by PROVIDER to CUSTOMER, except for Liabilities arising out of or based upon:

- (a) negligence of PROVIDER, its Affiliates or Representatives;
- (b) any of the Excluded Matters related to an act or omission of PROVIDER, its Affiliates or Representatives;
- (c) any matter with respect to which PROVIDER is required to indemnify CUSTOMER under Section 12.1 hereof; or

(d) any Third Party Claim that any resources provided by the CUSTOMER or used by PROVIDER in connection with the Services infringe, violate or misappropriate any Intellectual Property or Trademarks of any third party, excluding any such infringement, violation or misappropriation caused by:

(i) any such resources first provided to PROVIDER after the Execution Date, but excluding any infringement, violation or misappropriation resulting from modifications by or on behalf of the PROVIDER to any such resources, combinations of such resources with other items, or use of such resources, except as specified by CUSTOMER in each case (it being understood that the use of all Software included in any such resources in combination with computers or other hardware with which such Software is intended to be used shall be deemed to be so specified);

(ii) any such resources first specified by CUSTOMER after the Execution Date for use by PROVIDER in connection with the Services, but excluding any infringement, violation or misappropriation resulting from (A) modifications by or on behalf of the PROVIDER to any such resources, combinations of such resources with other items, or use of such resources, except as specified by CUSTOMER in each case (it being understood that the use of all Software included in any such resources in combination with computers or other hardware with which such Software is intended to be used shall be deemed to be so specified) and (B) any failure by PROVIDER to fulfill its express obligation under any PSA or other applicable written agreement between the parties to

19

---

obtain any rights or consents necessary for the use by PROVIDER of any Intellectual Property of a third party; and

(iii) modifications by or on behalf of the CUSTOMER after the Execution Date to any such resources provided by PROVIDER and/or its Affiliates and Representatives to the CUSTOMER in the course of performing the Services, combinations of such resources with other items, or use of such resources, except as specified by PROVIDER in each case (it being understood that the use of any and all Software in any such resources in combination with computers or other hardware with which such Software is intended to be used shall be deemed to be so specified).

### 12.3 Indemnification Obligations Net of Insurance Proceeds and Other Amounts, On an After-Tax Basis.

(a) Any Liability subject to indemnification pursuant to this Section 12.0 will be net of Insurance Proceeds that actually reduce the amount of the Liability and will be determined on an After-Tax Basis. Accordingly, the amount which any party (an “Indemnifying Party”) is required to pay to any Person entitled to indemnification hereunder (an “Indemnified Party”) will be reduced by any Insurance Proceeds theretofore actually recovered by or on behalf of the Indemnified Party in respect of the related Liability. If an Indemnified Party receives a payment (an “Indemnity Payment”) required by this Agreement from an Indemnifying Party in respect of any Liability and subsequently receives Insurance Proceeds, then the Indemnified Party will pay to the Indemnifying Party an amount equal to the excess of the Indemnity Payment received over the amount of the Indemnity Payment that would have been due if the Insurance Proceeds had been received, realized or recovered before the Indemnity Payment was made.

(b) An insurer who would otherwise be obligated to pay any claim shall not be relieved of the responsibility with respect thereto or, solely by virtue of the indemnification provisions hereof, have any subrogation rights with respect thereto. The Indemnified Party shall use its commercially reasonable efforts to seek to collect or recover any third-party (which shall not include any captive insurance subsidiary) Insurance Proceeds (other than Insurance Proceeds under an arrangement where future premiums are adjusted to reflect prior claims in excess of prior premiums) to which the Indemnified Party is entitled in connection with any Liability for which the Indemnified Party seeks indemnification pursuant to this Section 12.0; provided that the Indemnified Party’s inability to collect or recover any such Insurance Proceeds shall not limit the Indemnifying Party’s obligations hereunder.

(c) The term “After-Tax Basis” as used in this Section 12.0 means that, in determining the amount of the payment necessary to indemnify any party against, or reimburse any party for, Liabilities, the amount of such Liabilities will be determined net of any reduction

20

---

in tax derived by the Indemnified Party as the result of sustaining or paying such Liabilities, and the amount of such indemnification payment will be increased (i.e., “grossed up”) by the amount necessary to satisfy any income or franchise tax liabilities incurred by the Indemnified Party as a result of its receipt of, or right to receive, such Indemnity Payment (as so increased), so that the Indemnified Party is put in the same net after-tax economic position as if it had not incurred such Liabilities, in each case without taking into account any impact on the tax basis that an Indemnified Party has in its assets.

### 12.4 Procedures for Indemnification of Third Party Claims.

(a) If an Indemnified Party shall receive notice or otherwise learn of the assertion of any Third Party Claim or of the commencement by any such Person of any Action with respect to which an Indemnifying Party may be obligated to provide indemnification to such Indemnified Party pursuant to this Section 12.4, such Indemnified Party shall give such Indemnifying Party written notice thereof within 20 days after becoming aware of such Third Party Claim. Any such notice shall describe the Third Party Claim in reasonable detail. Notwithstanding the foregoing, the failure of any Indemnified Party or other Person to give notice as provided in this Section 12.4 shall not relieve the Indemnifying Party of its obligations under this Section 12.4, except to the extent that such Indemnifying Party is actually prejudiced by such failure to give notice.

(b) An Indemnifying Party may elect to defend (and to seek to settle or compromise), at such Indemnifying Party’s own expense and by such Indemnifying Party’s own counsel, any Third Party Claim. Within 30 days after the receipt of notice from an Indemnified Party in accordance with Section 12.4(a) (or sooner, if the nature of such Third Party Claim so requires), the Indemnifying Party shall notify the Indemnified Party of its election whether the Indemnifying Party will assume responsibility for defending such Third Party Claim, which election shall specify any reservations or exceptions. After notice from an Indemnifying Party to an Indemnified Party of its election to assume the defense of a Third Party Claim, such Indemnified Party shall have the right to employ separate counsel and to participate in (but not control) the defense, compromise, or settlement thereof, but the fees and expenses of such counsel shall be the expense of such Indemnified Party except as set forth in the next sentence. If the Indemnifying Party has elected to assume the defense of the Third Party Claim but has specified, and continues to assert, any reservations or exceptions in such notice, then, in any such case, the reasonable fees and expenses of one separate counsel for all Indemnified parties shall be borne by the Indemnifying Party, but the Indemnifying Party shall be entitled to reimbursement by the Indemnified Party for payment of any such fees and expenses to the extent that it establishes that such reservations and exceptions were proper.

(c) If an Indemnifying Party elects not to assume responsibility for defending a Third Party Claim, or fails to notify an Indemnified Party of its election as provided in Section 12.4(b) such Indemnified Party may defend such Third Party Claim at the cost and expense of the Indemnifying Party.

(d) Unless the Indemnifying Party has failed to assume the defense of the Third Party Claim in accordance with the terms of this Agreement, no Indemnified Party may

21

---

settle or compromise any Third Party Claim without the consent of the Indemnifying Party. No Indemnifying Party shall consent to entry of any judgment or enter into any settlement of any pending or threatened Third Party Claim in respect of which any Indemnified Party is or could have been a party and indemnity could have been sought hereunder by such Indemnified Party without the consent of the Indemnified Party if (i) the effect thereof is to permit any injunction, declaratory judgment, other order or other nonmonetary relief to be entered, directly or indirectly against such Indemnified Party and (ii) such settlement does not include an unconditional release of such Indemnified Party from all liability on claims that are the subject matter of such Third Party Claim.

#### 12.5 Additional Matters.

Indemnification payments in respect of any Liabilities for which an Indemnified Party is entitled to indemnification under this Section 12.5 shall be paid by the Indemnifying Party to the Indemnified Party as such Liabilities are incurred upon demand by the Indemnified Party, including reasonably satisfactory documentation setting forth the basis for the amount of such indemnification payment, including documentation with respect to calculations made on an After-Tax Basis and consideration of any Insurance Proceeds that actually reduce the amount of such Liabilities. The indemnities contained in this Section 12.5 shall remain operative and in full force and effect, regardless of (i) any investigation made by or on behalf of any Indemnified Party; (ii) the knowledge by the Indemnified Party of Liabilities for which it might be entitled to indemnification hereunder; (iii) any termination of this Agreement or any PSA; and (iv) the sale or other transfer by any party of any assets or businesses or the assignment by it of any liabilities.

If payment is made by or on behalf of any Indemnifying Party to any Indemnified Party in connection with any Third Party Claim, such Indemnifying Party shall be subrogated to and shall stand in the place of such Indemnified Party as to any events or circumstances in respect of which such Indemnified Party may have any right, defense or claim relating to such Third Party Claim against any claimant or plaintiff asserting such Third Party Claim or against any other Person. Such Indemnified Party shall cooperate with such Indemnifying Party in a reasonable manner, and at the cost and expense of such Indemnifying Party, in prosecuting any subrogated right, defense or claim.

In an Action in which the Indemnifying Party is not a named defendant, if either the Indemnified Party or Indemnifying Party shall so request, the parties shall endeavor to substitute the Indemnifying Party for the named defendant if they conclude that substitution is desirable and practical. If such substitution or addition cannot be achieved for any reason or is not requested, the named defendant shall allow the Indemnifying Party to manage the Action as set forth in this section, and the Indemnifying Party shall fully indemnify the named defendant against all costs of defending the Action (including court costs, sanctions imposed by a court, attorneys' fees, experts fees and all other external expenses), the costs of any judgment or settlement, and the cost of any interest or penalties relating to any judgment or settlement.

22

---

#### 12.6 Remedies Cumulative: Limitations.

(a) The rights provided in this Section 12.6 shall be cumulative and, subject to the provisions of Section 12.0 and Section 21.12, shall not preclude assertion by any Indemnified Party of any other rights or the seeking of any and all other remedies against any Indemnifying Party.

(b) PROVIDER's indemnity hereunder shall not extend to any Liabilities incurred or suffered by CUSTOMER as a result of inaccurate or incomplete data or information submitted to PROVIDER by CUSTOMER.

(c) The liability of each party (and their respective Affiliates) to each other with respect to the indemnified matters shall be included in the calculation of, and limited by, the Excluded Matters Cap.

#### 13.0 Limitation of Liability.

13.1 No System Liability. PROVIDER shall have no liability to CUSTOMER for any delay of performance or breach of this Agreement to the extent caused by or related to any errors in the System or the lack of availability to PROVIDER of the System provided by CUSTOMER under Section 6.1.

13.2 Liability for Simple Breach. The parties shall be liable to one another for fifty percent (50%) of all Direct Damages resulting from their respective breaches of this Agreement or PSA or negligence in the performance of the Services during the Initial Term, provided, that (i) neither party shall have any liability to the other with respect to an individual breach or negligent act or omission until the losses resulting from such matter exceed \$25,000, and then only to the extent that such losses exceed \$25,000, and (ii) the parties and their Affiliates' liability to each other for Direct Damages for such matters arising out of all of the MOAs during the Initial Term shall not exceed \$5,000,000 in the aggregate (the "Simple Breach Cap").

13.3 Liability for Excluded Matters. Subject to the Excluded Matters Cap described in the following sentence, the parties shall be liable to one another for one hundred percent (100%) of all Direct Damages resulting from (i) a party's gross negligence or willful misconduct, (ii) PROVIDER's improper or illegal use or disclosure of consumer information (including, but not limited to, personal, credit or medical information) regarding any customer or potential customer of the CUSTOMER Group, (iii) PROVIDER's breach of its agreement not to voluntarily withhold Services, (iv) a breach of Section 15.1(f), or (v) a party's violation of Law (collectively, the "Excluded Matters"). The parties and their Affiliates' liability to each other for Direct Damages arising out of or relating to the Excluded Matters and their respective indemnification obligations under ARTICLE XII arising under all of the MOAs during the Initial Term shall not exceed \$25,000,000 in the aggregate (the "Excluded Matters Cap").

13.4 No Liability for Acts in Accordance with Instructions. Notwithstanding anything to the contrary set forth in the Agreement or any related PSA, neither party shall be liable to the other party or any of its Affiliates with respect to any act or omission taken or not taken pursuant to the specific instruction, direction or request, in writing of such other party made through its authorized representative.

23

---

#### 14.0 PROVIDER Employees.

14.1 Responsibility for PROVIDER Employees. PROVIDER shall be responsible for all payments to its employees including any insurance coverage and benefit programs required by applicable law and regulation. Nothing in this agreement shall constitute an employer-employee relationship between the employees of PROVIDER and the CUSTOMER.

#### 15.0 Representations, Warranties and Covenants.

15.1 PROVIDER Representations. PROVIDER represents, warrants and covenants that:

(a) PROVIDER has the facilities, equipment, staff, experience and expertise to perform and provide the Services required hereunder;

(b) PROVIDER is solvent and able to meet all financial obligations as they mature, and agrees to notify CUSTOMER promptly of any change in this status;

(c) PROVIDER has the necessary power and authority to execute, deliver and perform its obligations under this Agreement and this Agreement has

been or will be duly executed and delivered by PROVIDER and constitutes or will constitute the valid and binding agreement of PROVIDER, enforceable in accordance with its terms;

(d) Subject to Section 6.3, the execution and delivery of this Agreement by PROVIDER and the consummation by PROVIDER of the transactions herein contemplated will not contravene any provision of applicable Law, and will not constitute a breach of or default under any agreement or other instrument or any decree, judgment or order to which PROVIDER is currently a party or by which PROVIDER is bound;

(e) PROVIDER has provided to CUSTOMER a list referring to this paragraph which, to the knowledge of PROVIDER, sets forth all Software used by PROVIDER (other than such Software provided to PROVIDER by CUSTOMER) in the performance of the Services as of the Execution Date;

(f) After the Execution Date, PROVIDER will not use any New Provider Materials in performing the Services without the prior written consent of CUSTOMER; and

(g) After the Execution Date, PROVIDER will not enter into any material agreement for the purchase of Hardware or Third Party Software or enter into any material Third Party Agreements without the prior written consent of CUSTOMER.

15.2 CUSTOMER Representations. CUSTOMER represents, warrants and covenants that:

(a) CUSTOMER has the necessary power and authority to execute, deliver and perform its obligations under this Agreement and this Agreement has been or will be duly

24

---

executed and delivered by CUSTOMER and constitutes the valid and binding agreement of CUSTOMER, enforceable in accordance with its terms; and

(b) The execution and delivery of this Agreement by CUSTOMER and the consummation by CUSTOMER of the transactions herein contemplated will not contravene any provision of applicable law, and will not constitute a breach of or default under any agreement or other instrument or any decree, judgment or order to which CUSTOMER is currently a party or by which CUSTOMER is bound.

15.3 Approvals and Consents. Each party shall be responsible for obtaining all approvals, permissions, consents or grants required or which may be required for such party to undertake its duties and responsibilities regarding any Services under this Agreement and any related PSA. Additionally, each party shall provide such cooperation and support as may be necessary for the other party to secure such approvals, permissions, consents or grants.

15.4 Cooperation.

(a) The parties shall timely, diligently and on a commercially reasonable basis cooperate, facilitate the performance of their respective duties and obligations under this Agreement and each related PSA and reach agreement with respect to matters left for future review, consideration and/or negotiation and agreement by the parties, as specifically set forth in this Agreement and PSA. Further, the parties shall deal and negotiate with each other and their respective Affiliates in good faith in the execution and implementation of their duties and obligations under this Agreement.

(b) Not in limitation of Sections 12.2(d)(i) and (ii), the parties shall make good faith efforts to share (i) versions, patches, fixes and other modifications recommended or required by third party providers of Software provided hereunder by either party to the other prior to or after the Execution Date and (ii) information regarding the foregoing (i).

(c) PROVIDER agrees, at CUSTOMER'S request and expense, to provide documentary information and any further assistance required in order to respond for CUSTOMER to state department of insurance or third party or administrative demands in regulatory or legal proceedings or in conjunction with formal department of insurance inquiries related to the Services performed by PROVIDER. The assistance rendered by PROVIDER under this Section 15.4(c) shall include causing PROVIDER'S employees to travel to the United States to participate in or testify at regulatory or legal proceedings relating to the Services as required by Law or request of any Governmental Authority or as otherwise reasonably requested by CUSTOMER, provided, that CUSTOMER shall reimburse PROVIDER for the reasonable travel and living expenses incurred by such employees in accordance with CUSTOMER'S reimbursement policies generally applicable to CUSTOMER'S employees.

16.0 Notices.

All notices, requests, claims, demands and other communications under this Agreement shall be given or made (and shall be deemed to have been duly given or made if the sender has

25

---

reasonable means of showing receipt thereof) by delivery in person, by reputable international courier service, by facsimile with receipt confirmed (followed by delivery of an original via reputable international courier service) to the respective parties at the following addresses (or at such other address for a party as shall be specified in a notice given in accordance with this Section 16.0):

TO PROVIDER:  
Attention: Pramod Bhasin  
Designation: President & CEO  
Address: GE Towers, Sector Road, DLF City Phase V Sector Road, Sector 53, Gurgaon, Haryana  
Fax: 91 124 235 6976  
E-mail: Pramod.Bhasin@geind.GE.com

Copy To:  
Attention: Raghuram Raju  
Designation: General Counsel  
Address: GE Towers, Sector Road, DLF City Phase V Sector Road, Sector 53, Gurgaon, Haryana  
Fax: 91 124 235 6978  
E-mail: raghuram.raju@geind.ge.com

TO CUSTOMER:  
Attention: Scott McKay  
Designation: Senior Vice President, Operations & Quality

Address: 6620 West Broad Street, Richmond, VA 23230  
Fax: 804/662-7766  
E-mail: scott.mckay@ge.com

Copy To:  
Attention: Leon Roday  
Designation: Senior Vice President and General Counsel  
Address: 6620 West Broad Street, Richmond, VA 23230  
Fax: (804) 662-2414  
E-mail: Leon.Roday@ge.com

Attention: Elena Edwards  
Designation: Senior Operations Leader  
Address: 700 Main Street, Lynchburg, VA 24504  
Fax: (434) 948-5064  
E-mail: elena.edwards@ge.com

26

---

Attention: Ward Bobitz  
Designation: General Counsel  
Address: 6620 West Broad Street, Richmond, VA 23230  
Fax: (804) 662-2414  
E-mail: ward.bobitz@ge.com

The parties may agree to additional notice requirements related to specific outsourcing projects from time to time.

17.0 Intellectual Property.

Exhibit I of this Agreement sets forth certain additional rights and obligations of the parties with respect to intellectual property.

18.0 Non-Compete.

18.1 Limitations on Provision of Services. From the Execution Date until the Volume Reduction Date, to the extent that PROVIDER provides such Services to CUSTOMER, PROVIDER shall not market, sell or provide the Services (including granting licenses to use or assigning any interest in any PROVIDER Licensed Technology, but excluding any such assignment in connection with a PROVIDER divestiture permitted pursuant to Section L.6 of this Agreement) to any third party in the business of underwriting, marketing, issuing or administering any (i) life insurance, long-term care insurance, or annuities, (ii) mortgage insurance, or (iii) credit life, credit health, credit unemployment or credit casualty insurance products either directly or through a re-insurer; provided, however, that PROVIDER shall have a right to provide the Services to GE and its Affiliates or any party that was an Affiliate of GE on the Execution Date.

18.2 Volume Reduction Date. PROVIDER shall notify CUSTOMER of the potential occurrence of the Volume Reduction Date. If, within ten (10) days of its receipt of such notice, CUSTOMER notifies PROVIDER of its intent to increase the volume of Services consumed by CUSTOMER such that the level of Dedicated FTEs or Customer-Controllable Revenues, as applicable, increases above the fifty percent (50%) threshold, and does so increase such volume within sixty (60) days of receipt of such notice, then the Volume Reduction Date shall not be deemed to have occurred.

18.3 Equitable Relief. PROVIDER acknowledges that any violation of the restrictions contained in the foregoing paragraph would result in irreparable injury to CUSTOMER, and PROVIDER further acknowledges that, in the event of its violation of any of these restrictions, CUSTOMER shall be entitled to obtain from any court of competent jurisdiction (in any jurisdiction) preliminary and permanent injunctive relief, regardless of the dispute resolution provisions set forth in Exhibit G, as well as damages to which it may be entitled under such provisions.

27

---

19.0 Change Control Procedure.

If either party requests a modification of the Agreement or any PSA, including (i) a change to the scope of the Services, Dedicated FTEs, Performance Standards, or Charges under any PSA, (ii) a change to the Exhibits or Schedules to the Agreement, (iii) the addition of New Services, (iv) a change to the features, functionality, scalability or performance of the Services, or (v) any other change to the terms of the Agreement or any PSA, the requesting party's Account Executive or his or her designee shall submit a written proposal in the form attached as Exhibit K (a "Change Order Request") to the other party's Account Executive describing such desired change. Such party's Account Executive shall review the proposal and reject or accept the proposal in writing within a reasonable period of time, but in no event more than thirty (30) days after receipt of the proposal. If the proposal is rejected, the writing shall include the reasons for rejection. If the proposal is accepted, the parties shall mutually agree on the changes to be made, if necessary, to the Agreement, the applicable PSA, or any applicable Exhibits. All such changes shall be made only in a written Change Order signed by the Account Executive of each of the parties or his designee (authorized in writing by the applicable party), and thereafter embodied in the applicable documents by appropriate written addenda thereto executed by PROVIDER and CUSTOMER.

20.0 Governance.

20.1 PROVIDER Account Executive.

(a) Designation and Authority. Immediately after execution of this Agreement, PROVIDER shall designate a PROVIDER Account Executive for the PROVIDER engagement under this Agreement. The PROVIDER Account Executive, and his/her designee(s), shall have the authority to act for and bind PROVIDER and its subcontractors in connection with all aspects of this Agreement. All of CUSTOMER's communications shall be sent to the PROVIDER Account Executive or his/her designee(s).

(b) Selection. Before assigning an individual to the position of Account Executive, whether the person is initially assigned or subsequently assigned, PROVIDER shall:

- (i) notify CUSTOMER of the proposed assignment for CUSTOMER's approval;
- (ii) introduce the individual to appropriate CUSTOMER representatives; and

(iii) consistent with law and PROVIDER's reasonable personnel practices, provide CUSTOMER with any other information about the individual that is reasonably requested.

(c) PROVIDER shall cause the person assigned to the position of Account Executive to maintain his or her principal office at a location designated by CUSTOMER and to devote all time and effort that is reasonably necessary to the provision of the Services under this

28

---

Agreement. PROVIDER shall use commercially reasonable efforts to maintain the initial PROVIDER Account Executive at CUSTOMER for the minimum term of eighteen (18) months following the Execution Date, provided that any term that such Account Executive has already spent in his or her current position prior to the Execution Date shall be considered as a part of the 18-month period referred to herein, and each of the subsequent PROVIDER Account Executives for a minimum term of eighteen (18) months, unless such Account Executive (i) voluntarily resigns from PROVIDER, (ii) is dismissed by PROVIDER for (A) misconduct or (B) unsatisfactory performance in respect of his or her duties and responsibilities to CUSTOMER or PROVIDER, (iii) is unable to work due to his or her death, injury or disability, or (iv) is removed from the CUSTOMER assignment at the request of CUSTOMER. Whenever possible, PROVIDER shall give CUSTOMER at least ninety (90) days advance notice of a change of the Account Executive or if such ninety (90) days notice is not possible, the longest notice otherwise possible.

(d) Removal. If CUSTOMER determines that it is not in the best interests of CUSTOMER for the PROVIDER Account Executive to continue in his or her capacity, then CUSTOMER shall give PROVIDER written notice requesting that the Account Executive be replaced. PROVIDER shall replace the Account Executive as promptly as practicable, but, in any case, within thirty (30) days, in accordance with this Section 20.1.

#### 20.2 CUSTOMER Account Executive.

(a) Designation and Authority. Immediately after execution of this Agreement, CUSTOMER shall designate a CUSTOMER Account Executive for the PROVIDER engagement under this Agreement. The CUSTOMER Account Executive and his/her designee(s) shall have the authority to act for and bind CUSTOMER and its contractors in connection with all aspects of this Agreement. All of PROVIDER's communications shall be sent to the CUSTOMER Account Executive or his/her designee(s).

(b) Term. CUSTOMER shall cause the person assigned to the position of Account Executive to devote substantial time and effort to the management of CUSTOMER's responsibilities under this Agreement. Whenever possible, CUSTOMER shall give PROVIDER at least ninety (90) days advance notice of a change of the Account Executive or if such ninety (90) days notice is not possible, the longest notice otherwise possible.

20.3 Key Employees of PROVIDER. For this Agreement and each PSA executed pursuant hereto, PROVIDER shall notify CUSTOMER in writing of the names of all of the PROVIDER employees providing Services under each such agreement who are at the senior professional band and above (each a "Key Employee"). Such notice shall be provided within thirty (30) days of the execution of this Agreement and each PSA. PROVIDER shall use commercially reasonable efforts to maintain the initial Key Employees at CUSTOMER for the minimum term of eighteen (18) months following the Execution Date, provided that any term that such Key Employee has already spent in his or her current position prior to the Execution Date shall be considered as a part of the 18-month period referred to herein, and each of the subsequent Key Employees for a minimum term of eighteen (18) months, unless any such Key Employee (i) voluntarily resigns from PROVIDER, (ii) is dismissed by PROVIDER for

29

---

(A) misconduct or (B) unsatisfactory performance in respect of his or her duties and responsibilities to CUSTOMER or PROVIDER, (iii) is unable to work due to his or her death, injury or disability, or (iv) is removed from the CUSTOMER assignment at the request of CUSTOMER. Whenever possible, PROVIDER shall give CUSTOMER at least ninety (90) days advance notice of a change of a Key Employee or if such ninety (90) days notice is not possible, the longest notice otherwise possible. If CUSTOMER determines that it is not in the best interests of CUSTOMER for any Key Employee to continue in his or her capacity, then CUSTOMER shall give PROVIDER written notice requesting that such Key Employee be replaced. PROVIDER shall replace the Key Employee as promptly as practicable, but, in any case, within thirty (30) days, in accordance with this Section 20.3.

#### 20.4 Meetings.

(a) The parties will participate in an (i) annual budgeting and pricing process and a quarterly demand planning process as described in Section 2.9 and (ii) an annual business strategy and productivity enhancement process as directed by CUSTOMER.

(b) CUSTOMER may call meetings from time to time with reasonable notice to be held by telephone or video conference to generally review matters relating to the terms and conditions of this Agreement and any PSA, the compliance of each of the parties herewith, and to consider policies, planning and performance relating to quality controls, production, efficiency and productivity, costs and any other special matter or matters of concern. In addition, either party shall have the right to call meetings by telephone or video conference, as necessary, with reasonable notice to the other party, to discuss and resolve specific matters of concern as they occur. All meetings shall be attended by the representatives of the parties who are responsible for performances as to those matters to be discussed. Either party may also request an in-person meeting with reasonable notice to the other party. The expenses for such meeting, including travel and lodging shall be borne by the party calling the meeting; however, such expenses will be agreed upon by the parties prior to such meeting.

20.5 Operational Dispute Resolution. As contemplated by Section 1.2 of Exhibit G, the parties may attempt to resolve Disputes in the normal course of business at the operational level as described in this Section 20.5. The line managers of the parties shall attempt in good faith to resolve such Dispute through negotiation. If the line managers cannot resolve the Dispute within a reasonable period of time, the Dispute shall be escalated by CUSTOMER to the applicable operations leader and by PROVIDER to the applicable service leader. If such persons can not resolve the Dispute within a reasonable period of time, the Dispute shall be escalated to the Account Executives of both parties. If the Dispute is not resolved by the Account Executives within a reasonable period of time or, in any case, if such Dispute is not resolved within ten (10) days after commencement of negotiations pursuant to this Section 20.5, the Dispute shall be handled in accordance with Exhibit G.

#### 21.0 Miscellaneous.

21.1 Force Majeure. No party hereto (or any Person acting on its behalf) shall have any liability or responsibility for failure to fulfill any obligation (other than a payment

30

---

obligation) under this Agreement or any related PSA, so long as and to the extent to which the fulfillment of such obligation is prevented, frustrated, hindered or delayed as a consequence of circumstances of Force Majeure. A party claiming the benefit of this provision shall, as soon as reasonably practicable after the occurrence of any such event: (i) notify the other parties of the nature and extent of any such Force Majeure condition and (ii) use due diligence to remove any such causes and resume performance under this Agreement as soon as feasible. The preceding sentence shall not relieve PROVIDER of its obligation to provide the Services described in the BCP/DRP Plans described

in [Section 1.2](#) hereof. If PROVIDER's performance is affected by Force Majeure for a period of more than ten (10) calendar days, then CUSTOMER may terminate this Agreement by giving written notice to PROVIDER before performance has resumed without payment of any amount other than accrued Charges.

21.2 **Independent Contractors.** The parties shall be and act as independent contractors, and under no circumstances shall this Agreement be construed as one of agency, partnership, joint venture or employment between the parties. Each party agrees and acknowledges that it neither has nor will give the appearance or impression of having any legal authority to bind or commit the other party in any way.

21.3 **Failure to Object Not a Waiver.** The failure of either party to object to or to take affirmative action with respect to any conduct of the other party which is in violation of the terms hereof shall not be construed as a waiver thereof, nor of any future breach or subsequent wrongful conduct.

21.4 **Governing Law.** This Agreement is to be governed by and construed and interpreted in accordance with the laws of Delaware of the United States of America, which is applicable to contracts wholly made and performed therein. PROVIDER hereby submits to the jurisdiction of all courts where CUSTOMER is authorized to do business and all courts of the United States. Any action in regard to the contract or arising out of its terms and conditions shall be instituted and litigated in the United States.

21.5 **No Third-Party Beneficiaries.** Except as provided in [Section 12.0](#) with respect to Indemnified parties, this Agreement is for the sole benefit of the parties to this Agreement and members of their respective Group and their permitted successors and assigns and nothing in this Agreement, express or implied, is intended to or shall confer upon any other Person or entity any legal or equitable right, benefit or remedy of any nature whatsoever under or by reason of this Agreement.

21.6 **Public Announcements.** The parties shall consult with each other before issuing, and give each other the opportunity to review and comment upon, any press release or other public statements with respect to the transactions contemplated by this Agreement and the PSAs, and shall not issue any such press release or make any such public statement prior to such consultation, except as may be required by applicable Law, court process or by obligations pursuant to any listing agreement with any national securities exchange or national securities quotation system.

31

---

21.7 **Entire Agreement.** Except as otherwise expressly provided in this Agreement, this Agreement (including the PSAs and the attachments hereto and thereto) constitutes the entire agreement of the parties hereto with respect to the subject matter hereof and thereof and supersedes all prior agreements and undertakings, both written and oral, between or on behalf of the parties hereto with respect to such subject matter, provided, that, unless otherwise expressly agreed by the parties, matters arising prior to the Execution Date shall be governed by the provisions of the Master Outsourcing Agreement (including the PSAs and attachments thereto) as in effect prior to such date.

21.8 **Amendment.** No provision of this Agreement or any PSA may be amended or modified except by a written instrument signed by all the parties to such agreement. No waiver by any party of any provision hereof shall be effective unless explicitly set forth in writing and executed by the party so waiving. The waiver by any party hereto of a breach of any provision of this Agreement or any PSA shall not operate or be construed as a waiver of any other subsequent breach.

21.9 **Rules of Construction.** Interpretation of this Agreement and the PSAs shall be governed by the following rules of construction: (a) words in the singular shall be held to include the plural and vice versa and words of one gender shall be held to include the other gender as the context requires, (b) references to the terms Article, Section, paragraph, Schedule and Exhibit are references to the Articles, Sections, paragraphs, Schedules and Exhibits to this Agreement and the PSAs unless otherwise specified, (c) the word "including" and words of similar import shall mean "including, without limitation," (d) provisions shall apply, when appropriate, to successive events and transactions, (e) the table of contents and headings contained herein are for reference purposes only and shall not affect in any way the meaning or interpretation of this Agreement and the PSAs, and (f) this Agreement and the PSAs shall be construed without regard to any presumption or rule requiring construction or interpretation against the party drafting or causing any instrument to be drafted. In the event of any apparent conflict between the provisions of this Agreement, any Exhibit to this Agreement or any PSA, such provisions shall be construed so as to make them consistent to the extent possible, and if such is not possible, then the parties will negotiate in good faith to resolve such conflicts in a commercially reasonable manner. If the parties are unable to resolve such conflicts, then the provisions of this Agreement shall control, provided, that the provisions of [Exhibit B](#) shall control over the provisions of the Agreement and any other Exhibits. In the event of any conflict between the provisions of this Agreement and any PSA, the provisions of this Agreement shall control.

21.10 **Severability.** If any term or other provision of this Agreement is invalid, illegal or incapable of being enforced under any Law or as a matter of public policy, all other conditions and provisions of this Agreement shall nevertheless remain in full force and effect. Upon such determination that any term or other provision is invalid, illegal or incapable of being enforced, the parties to this Agreement shall negotiate in good faith to modify this Agreement so as to effect the original intent of the parties as closely as possible in a mutually acceptable manner in order that the transactions contemplated by this Agreement be consummated as originally contemplated to the greatest extent possible.

32

---

21.11 **Remedies Not Exclusive.** No remedy herein conferred upon or reserved to a party is intended to be exclusive of any other remedy available at law or in equity, but each and every such remedy shall be cumulative and shall be in addition to every other remedy given under this Agreement or now or hereafter existing at law or in equity, by statute or otherwise.

21.12 **Dispute Resolution.** Any dispute, controversy or claim arising out of or relating to this Agreement or any related PSA, or the validity, interpretation, breach or termination of any provision of this or PSA shall be resolved in accordance with the dispute resolution process set forth in [Exhibit G](#) hereof.

21.13 **Language.** All PSAs, documents, exhibits, schedules, deliverable items, notices and communications of any kind relating to this Agreement and the PSAs shall be made in the English language.

21.14 **Survival.** The following sections of this Agreement shall survive termination of this Agreement and any PSA:

<a href="#">9.0</a>	<a href="#">Obligations on Expiration and Termination</a>
<a href="#">11.0</a>	<a href="#">Confidentiality</a>
<a href="#">12.0</a>	<a href="#">Indemnities</a>
<a href="#">13.0</a>	<a href="#">Limitation of Liability</a>
<a href="#">16.0</a>	<a href="#">Notices</a>
<a href="#">17.0</a>	<a href="#">Intellectual Property</a>
<a href="#">18.0</a>	<a href="#">Miscellaneous</a>

22.0 **Attachments.**

The following Exhibits are attached hereto and are incorporated into this Agreement:

<a href="#">Exhibit A</a>	<a href="#">Definitions</a>
<a href="#">Exhibit B</a>	<a href="#">Local Modifications to Master Agreement</a>



<a href="#">Exhibit C</a>	<a href="#">Form of PSA</a>
<a href="#">Exhibit D</a>	<a href="#">BCP/DRP Plans</a>
<a href="#">Exhibit E</a>	<a href="#">Security Procedures</a>
<a href="#">Exhibit F</a>	<a href="#">Pricing Template</a>
<a href="#">Exhibit G</a>	<a href="#">Dispute Resolution</a>
<a href="#">Exhibit H</a>	<a href="#">Carve-Out Option</a>
<a href="#">Exhibit I</a>	<a href="#">Intellectual Property</a>
<a href="#">Exhibit J</a>	<a href="#">Business Associate Addendum</a>
<a href="#">Exhibit K</a>	<a href="#">Change Control Procedure</a>
<a href="#">Exhibit L</a>	<a href="#">MOAs and PSAs</a>

IN WITNESS WHEREOF, the parties have caused this Agreement to be signed by their duly authorized representatives as of the date first written above.

General Electric Capital Assurance Company

By: \_\_\_\_\_

Its: \_\_\_\_\_

GE Capital International Services

By: \_\_\_\_\_

Its: \_\_\_\_\_

**EXHIBIT A**

Definitions

“Action” means any demand, action, claim, dispute, suit, countersuit, arbitration, inquiry, proceeding or investigation by or before any federal, state, local, foreign or international Government Authority or any arbitration or mediation tribunal.

“Addendum” means the terms which are supplemental to and/or deviate from this Agreement as set forth in Exhibit B.

“Agreement” means this Agreement, as amended and/or supplemented as set forth in Exhibit A, together with the other Exhibits and Schedules hereto.

“Affiliate” means (and, with a correlative meaning, “affiliated”) means, with respect to any Person, any direct or indirect subsidiary of such Person, and any other Person that directly, or through one or more intermediaries, controls or is controlled by or is under common control with such first Person; provided, however, that from and after the Execution Date, no member of the Genworth Group shall be deemed an Affiliate of any member of the GE Group for purposes of this Agreement and no member of the GE Group shall be deemed an Affiliate of any member of the Genworth Group for purposes of this Agreement. As used in this definition, “control” (including with correlative meanings, “controlled by” and “under common control with”) means possession, directly or indirectly, of power to direct or cause the direction of management or policies or the power to appoint and remove a majority of directors (whether through ownership of securities or partnership or other ownership interests, by contract or otherwise).

“After Tax Basis” shall have the meaning given in Section (c) hereof.

“Appraiser” shall have the meaning given in Exhibit A

“Bankruptcy Code” has the meaning set forth in Section 2.04 of Exhibit I.

“Base Cost” shall be PROVIDER’s actual direct cost of providing the Services reasonably and equitably determined to be attributable to CUSTOMER by PROVIDER for each year. The elements of PROVIDER’s direct cost are described in the attached Exhibit L, and shall take into account productivity gains or losses.

“Baseline Charges” has the meaning set forth in Section 2.1.

“Baseline FTEs” means the number of Dedicated FTEs employed by PROVIDER and its Affiliates to perform the Services under all of the MOAs as of the Execution Date, as agreed upon by the parties. Upon the occurrence of any event that reduces the number of Dedicated FTEs employed by PROVIDER to perform Services under the MOAs (including any transfer by PROVIDER of operations, but excluding the effects of productivity improvements), other than at the direction of any member of the Genworth Group, the Baseline FTEs shall be reduced to

reflect the reduction in the numbers and classes of Dedicated Employees affected by such change.

“Baseline Customer-Controllable Revenues” means the budgeted aggregate Compensation and Benefits expense (as defined in Exhibit F) of the Baseline FTEs for the first twelve months of the Initial Term, as agreed upon by the parties. Upon the occurrence of any event that reduces the number of Dedicated FTEs employed by PROVIDER to perform Services under the MOAs (including any transfer by PROVIDER of operations, but excluding the effects of productivity improvements), other than at the direction of any member of the Genworth Group, the Baseline Customer-Controllable Revenues shall be reduced to reflect the reduction in the numbers and classes of Dedicated Employees affected by such change.

“BCP/DRP Plans” shall have the meaning given such term in Section 1.2 hereof.

“Carve-Out” means the process set forth in Exhibit H commencing upon the election by CUSTOMER of the Carve-Out Option.

“Carve-Out Conditions” shall have the meaning given such term in Exhibit H hereof.

“Carve-Out Option” shall have the meaning given in Section 9.2 hereof.

“Carve-Out Resources” shall have the meaning given such term in Exhibit H hereof.

“Change Control Procedure” means the procedure set forth in Section 19.0 and Exhibit H for amending the Agreement including (i) a change to the scope of the Services, Dedicated FTEs, Performance Standards, or Charges under any Transaction Document, (ii) a change to the Exhibits or Schedules to this Agreement, (iii) the addition of New Services, (iv) a change to the features, functionality, scalability or performance of the Services, and (v) any other change to the terms of this Agreement or PSA.

“Change of Control” (of CUSTOMER) means any (i) consolidation or merger of GENWORTH with or into another entity or entities (whether or not GENWORTH is the surviving entity), excluding any such consolidation or merger with or into an Affiliate of GENWORTH or GE or an Affiliate of GE, (ii) any sale or transfer by GENWORTH of fifty percent (50%) or more of its assets, excluding any such sale to an Affiliate of GENWORTH or to GE or an Affiliate of GE, (iii) any sale, transfer or issuance or series of sales, transfers or issuances of shares or other voting securities of GENWORTH by GENWORTH or the holders thereof, as a result of which one holder, or a group of holders acting in concert (other than GE or an Affiliate of GE), acquires the voting power (under ordinary circumstances) to elect a majority of the directors of GENWORTH. Notwithstanding the foregoing, no transaction of the type described in clauses (i), (ii) or (iii) of this Section shall constitute a Change of Control if, as of immediately following such transaction, persons that possess the voting power (under ordinary circumstances) to elect a majority of the directors of GENWORTH as of immediately prior to such transaction continue to hold (directly or indirectly) such voting power.

A-2

---

“Change of Control” (of PROVIDER) shall have the meaning given such term in Exhibit H hereof.

“Change Order” means a document that amends the Agreement, including the changes described in (i) through (v) of the definition of “Change Control Procedure,” executed pursuant to the Change Control Procedure, in substantially the form set forth in Exhibit H.

“Change Order Request” has the meaning given in Section 19.0 hereof.

“Charges” shall have the meaning given such term in Section 2.1

“Common Termination Date” shall have the meaning given such term in Section 7.1 hereof.

“Contract Year” means the calendar year or any portion thereof (e.g. the initial Contract Year shall be the period from the Execution Date through December 31, 2004).

“Cost Factor” shall have the meaning given such term in Section 2.2 hereof.

“CPR” shall have the meaning given such term in Exhibit G hereof.

“CPR Arbitration Rules” shall have the meaning given such term in Exhibit G hereof.

“CUSTOMER Confidential Information” shall have the meaning given such term in Section 11.1 hereof.

“Customer-Controllable Revenue” means the aggregate salaries of the Dedicated FTEs.

“CUSTOMER Licensed Technology” means all Technology and Intellectual Property owned by CUSTOMER or its Affiliates and provided to PROVIDER (or its authorized subcontractors in accordance with Section 10) by CUSTOMER or its Affiliates for use or necessary for use in the provision of the Services (which, for the avoidance of doubt, does not include any Technology or Intellectual Property owned by a third party). CUSTOMER Licensed Technology shall include Technology or Intellectual Property developed by PROVIDER (or its authorized subcontractors in accordance with Section 10) and owned by CUSTOMER, except as otherwise provided in the Agreement or any PSA relating to such developed Technology or Intellectual Property.

“Dedicated FTEs” shall mean the full-time equivalent employees, including supervisors, direct support personnel (e.g. trainers) and other members of the PROVIDER management identified and agreed to by CUSTOMER, dedicated to the performance of the Services from time to time.

“Delayed Transfer Legal Entities” means Financial Assurance Company Limited, Financial Insurance Company Limited, Consolidated Insurance Group Limited, GE Financial Assurance Compania de Seguros y Reaseguros de Vida SA and GE Financial Insurance Compania de Seguros y Reaseguros SA.

“Direct Damages” means actual, direct damages incurred by the claiming party which include, by way of example (a) erroneous payments made by PROVIDER or CUSTOMER as a result of a

A-3

---

failure by PROVIDER to perform its obligations under an MOA or PSA, (b) the costs to correct any deficiencies in the Services, (c) the costs incurred by CUSTOMER to transition to another provider of Services and/or to take some or all of such functions and responsibilities in-house, (d) the difference in the amounts to be paid to PROVIDER hereunder and the charges to be paid to such other provider and/or the costs of providing such functions, responsibilities and tasks in-house, and (e) similar damages. “Direct Damages” shall not include, and neither party or its Affiliates shall be liable for, any indirect, special, incidental, exemplary, punitive or consequential damages (including, without limitation, any loss of data or records, lost profits or other economic loss) arising out of its breach, negligence or any of the Excluded Matters, even if the other party or its Affiliates have been advised of the possibility of or could have foreseen such damages, provided that any such damages relating to a Third Party Claim shall be considered Direct Damages. For the avoidance of doubt, PROVIDER shall remain liable for all Direct Damages regardless of whether such damages are the subject of any reinsurance arrangement entered into by CUSTOMER. Direct Damages shall be calculated and paid on an After-Tax Basis, net of Insurance Proceeds, in the manner described in Section 12.3.

“Discount Factor” shall have the meaning given such term in Sections 2.2 and 2.4 hereof.

“Dispute” shall have the meaning given such term in Exhibit G hereof.

“Excluded Matters” shall have the meaning given such term in Section 13.3 hereof.

“Excluded Matters Cap” shall have the meaning given such term in Section 13.3 hereof.

“Execution Date” means the date of this Agreement as set forth on the first page hereof.

“Facility” shall have the meaning given such term in Exhibit H hereof.

“Fair Market Value” shall have the meaning given such term in Exhibit H hereof.

“Force Majeure” means, with respect to a party, an event beyond the control of such party (or any Person acting on its behalf), which by its nature could not have been foreseen by such party (or such Person), or, if it could have been foreseen, was unavoidable, and includes, without limitation, acts of God, storms, floods, riots, fires, sabotage, civil commotion or civil unrest, interference by civil or military authorities, acts of war (declared or undeclared) or armed hostilities or other national or international calamity or one or more acts of terrorism or failure of energy sources.

“GAAP” means generally accepted accounting principles prevailing from time to time in the applicable jurisdiction.

“GE” means General Electric Company.

“GE Group” means GE and each Person (other than any member of the Genworth Group) that is an Affiliate of GE immediately after the Execution Date.

“Genworth” shall have the meaning given such term in the recitals of this Agreement.

A-4

---

“Genworth Business” means the businesses of (a) the members of the Genworth Group; (b) GEFAHI; (c) the Delayed Transfer Legal Entities and (d) those terminated, divested or discontinued businesses of the members of Genworth Group, other than those listed on Schedule A-1.

“Genworth Common Stock” means the Class A Common Stock, \$0.0001 par value per share and the Class B Common Stock, \$0.0001 par value per share, of Genworth.

“Genworth Group” means Genworth, each Subsidiary of Genworth immediately after the Execution Date and each other Person that is either controlled directly or indirectly by Genworth immediately after the Execution Date; provided, that certain assets referred to by the parties as “Delayed Transfer Asset,” that are transferred to Genworth at any time following the Closing shall, to the extent applicable, be considered part of the Genworth Group for all purposes of this Agreement.

“Genworth Records Management Policies” means the Genworth Records Management Policy adopted by Genworth and provided to GECIS, as amended from time to time.

“Governmental Authority” means any entity exercising executive, legislative, judicial, regulatory or administrative functions of or pertaining to government, including any governmental authority, agency, department, board, commission or instrumentality whether federal, state, local or foreign (or any political subdivision thereof), and any tribunal, court or arbitrator(s) of competent jurisdiction.

“Hardware” shall have the meaning given such term in Exhibit H hereof.

“HIPPA” shall have the meaning given such term in Exhibit J hereof.

“Improvement” means any modification, derivative work or improvement of any Technology.

“Indemnity Payment” shall have the meaning given such term in Section 12.3 hereof.

“Indemnified Party” shall have the meaning given such term in Section 12.3 hereof.

“Indemnifying Party” shall have the meaning given such term in Section 12.3 hereof.

“Information” means information, whether or not patentable or copyrightable, in written, oral, electronic or other tangible or intangible forms, stored in any medium, including studies, reports, records, books, contracts, instruments, surveys, discoveries, ideas, concepts, know-how, techniques, designs, specifications, drawings, blueprints, diagrams, models, prototypes, samples, flow charts, data, computer data, disks, diskettes, tapes, computer programs or other software, marketing plans, customer names, communications by or to attorneys (including attorney-client privileged communications), memoranda and other materials prepared by attorneys or under their direction (including attorney work product), and other technical, financial, employee or business information or data, including customer and/or consumer non-public personal financial information, non-public health information and protected health information as defined by applicable Law.

A-5

---

“Initial Notice” shall have the meaning given such term in Exhibit G hereof.

“Initial Term” shall have the meaning given such term in Section 5.1 hereof.

“Insurance Proceeds” means those monies: (a) received by an insured from an insurance carrier; (b) paid by an insurance carrier on behalf of the insured; or (c) received (including by way of set off) from any third party in the nature of insurance, contribution or indemnification in respect of any Liability; in any such case net of any applicable premium adjustments (including reserves and retrospectively rated premium adjustments) and net of any costs or expenses incurred in the collection thereof.

“Intellectual Property” means all of the following, whether protected, created or arising under the laws of the United States or any other foreign jurisdiction: (i) patents, patent applications (along with all patents issuing thereon), statutory invention registrations, divisions, continuations, continuations-in-part, substitute applications of the foregoing and any extensions, reissues, restorations and reexaminations thereof, and all rights therein provided by international treaties or conventions, (ii) copyrights, mask work rights, database rights and design rights, whether or not registered, published or unpublished, and registrations and applications for registration thereof, and all rights therein whether provided by international treaties or conventions or otherwise, (iii) trade secrets, (iv) intellectual property rights arising from or in respect of Technology and (v) all other applications and registrations related to any of the intellectual property rights set forth in the foregoing clauses (i) – (v) above. As used in this Agreement, the term “Intellectual Property” expressly excludes (x) trademarks, service marks, trade dress, logos and other identifiers of source, including all goodwill associated therewith and all common law rights, registrations and applications for registration thereof, and all rights therein provided by international treaties or conventions, and all reissues, extensions and renewals of any of the foregoing and (y) intellectual property rights arising from or in respect of domain names, domain name registrations and reservations (all of the foregoing collectively, the “Trademarks”).

“Key Employee” shall have the meaning given in Section 20.3 hereof.

“Law” means any federal, state, local or foreign law (including common law), statute, code, ordinance, rule, regulation, order or other requirement enacted, promulgated, issued or entered by a Governmental Authority, including without limitation, the Gramm-Leach-Bliley Act, its implementing regulations, applicable state privacy laws, and HIPPA.

“Liabilities” shall have the meaning given such term in [Section 12.1](#).

“Licensed Products and Services” means those products and services that use, practice or incorporate the Licensor’s Intellectual Property or Technology.

“Licensee” means a Person receiving a license or sublicense under [Exhibit I](#).

“Licensor” means a Person granting a license or sublicense under [Exhibit I](#).

A-6

---

“Mission Critical” operations shall mean those operations identified by CUSTOMER from time to time as mission critical in one (1) or more written notices to PROVIDER.

“MOAs” means (i) all of the Amended and Restated Master Outsourcing Agreements entered into between Affiliates of Genworth and PROVIDER in connection with that certain Outsourcing Services Separation Agreement dated \_\_\_\_\_, 2004 between Genworth, PROVIDER, General Electric Company and General Electric Capital Corporation, and (ii) all PSAs executed pursuant to such Amended and Restated Master Outsourcing Agreements, all as identified by the parties as of the Execution Date.

“New Provider Materials” means all Software first used by PROVIDER or its Affiliates or their Representatives in performing the Services after [the Execution Date].

“New Services” shall have the meaning given such term in [Section 1.7](#) hereof.

“Non-exclusive Employees” shall have the meaning given such term in [Exhibit H](#) hereof.

“Notification Date” shall have the meaning given such term in [Section 7.2](#) hereof.

“Payment Date” shall have the meaning given such term in [Section 3.5](#) hereof.

“Payment Default Notice” shall have the meaning given such term in [Section 3.5](#) hereof.

“Performance Standards” means the performance requirements for PROVIDER set forth in any PSA.

“Person” means any individual, corporation, partnership, firm, joint venture, association, joint-stock company, trust, unincorporated organization, governmental authority or other entity.

“PROVIDER Licensed Technology” means all Technology and Intellectual Property owned by PROVIDER or its Affiliates and used in the provision of the Services under the Agreement and PSAs (which, for the avoidance of doubt, does not include any Technology or Intellectual Property owned by a third party).

“PROVIDER Confidential Information” has the meaning given such term in [Section 11.2](#) hereof.

“PROVIDER Divestiture” shall have the meaning given such term in [Section 1.6](#) hereof.

“PROVIDER Employees” shall have the meaning given such term in [Exhibit H](#) hereof.

“PSA(s)” means the Project Specific Agreements entered into between the parties under the original Master Outsourcing Agreement and hereafter and certain other services agreements entered into between the parties, all of which are and shall be listed on [Exhibit G](#) hereof.

“Renewal Period” shall have the meaning given such term in [Section 5.2](#) hereof.

A-7

---

“Response” shall have the meaning given such term in [Exhibit G](#) hereof.

“SAP” means statutory accounting practices mandated by state law or regulation.

“Service Hours” shall have the meaning given such term in [Section 6.1](#) hereof.

“Services” means (a) any services described in a PSA, (b) the services described in the BCP/DRP Plans, and (c) any other functions, responsibilities, tasks not specifically described in the Agreement or PSA which are required for the proper performance of and provision of the above services, or are an inherent part of, or necessary subpart included within, such services.

“Services Transfer Assistance” shall have the meaning given such term in [Section 9.1](#) hereof.

“Simple Breach Cap” shall have the meaning given such term in [Section 13.2](#) hereof.

“Software” means the object and source code versions of computer programs and associated documentation, training materials and configurations to use and modify such programs, including programmer, administrator, end user and other documentation.

“Subsidiary” or “subsidiary” means, with respect to any Person, any corporation, limited liability company, joint venture or partnership of which such Person (a) beneficially owns, either directly or indirectly, more than fifty percent (50%) of (i) the total combined voting power of all classes of voting securities of such entity, (ii) the total combined equity interests, or (iii) the capital or profit interests, in the case of a partnership; or (b) otherwise has the power to vote, either directly or indirectly, sufficient securities to elect a majority of the board of directors or similar governing body.

“System” shall have the meaning given such term in [Section 6.1](#) hereof.

“Taxes” shall have the meaning given such term in [Section 2.6](#) hereof.

“Technology” means, collectively, all designs, formulas, algorithms, procedures, techniques, ideas, know-how, Software, programs, models, routines, databases, tools, inventions, creations, improvements, works of authorship, and all recordings, graphs, drawings, reports, analyses, other writings, and any other embodiment of the above, in any form, whether or not specifically listed herein.

“Third Party Agreements” shall have the meaning given such term in [Exhibit H](#) hereof.

“Third Party Claim” shall have the meaning given such term in Section 12.1 hereof.

“Third Party Software” shall have the meaning given such term in Exhibit H hereof.

“Trigger Date” means the first date on which members of the GE Group cease to beneficially own (excluding for such purposes shares of Genworth Common Stock beneficially owned by GE but not for its own account, including (in such exclusion) beneficial ownership which arises by virtue of some entity that is an Affiliate of GE being a sponsor of or advisor to a mutual or

A-8

---

similar fund that beneficially owns shares of Genworth Common Stock) more than fifty percent (50%) of the outstanding Genworth Common Stock.

“Volume Reduction Date” means the date on which either (i) the number of Dedicated FTEs used by PROVIDER to perform the Services for CUSTOMER and its Affiliates under all of the MOAs, or (ii) the annualized Customer-Controllable Revenues relating to Dedicated FTEs performing Services for CUSTOMER and its Affiliates under all of the MOAs are less than fifty percent (50%) of the Baseline FTEs or Baseline Customer-Controllable Revenues, respectively.

A-9

---

#### **Schedule A-1**

##### **Discontinued Businesses**

GE Property & Casualty Insurance Company  
GE Casualty Insurance Company  
GE Indemnity Insurance Company  
GE Auto & Home Assurance Company  
Bayside Casualty Insurance Company

---

#### **EXHIBIT B**

##### **Local Modifications to Master Agreement**

None

---

#### **EXHIBIT C**

##### **Form of PSA**

#### **PROJECT SPECIFIC AGREEMENT**

This Project Specific Agreement (“PSA”) is entered into on \_\_\_\_\_, 200 by [NAME] (hereafter “CUSTOMER”) and [GE Capital International Services] (hereafter “PROVIDER”).

**WHEREAS**, CUSTOMER and PROVIDER are parties to that certain Amended and Restated Master Outsourcing Agreement between CUSTOMER and PROVIDER dated \_\_\_\_\_, 200 (“ARMOA”);

**WHEREAS**, CUSTOMER now desires that PROVIDER provide certain services to CUSTOMER and PROVIDER desires to provide such services pursuant to the terms of the ARMOA;

**WHEREAS**, this PSA defines certain rights and liabilities of the parties with respect to [Insert general Project Name or Type of Service]; and

**WHEREAS**, capitalized terms used herein and not defined shall have the meaning given such terms in the ARMOA.

**NOW THEREFORE**, in consideration of the premises, and other good and valuable consideration, the receipt and sufficiency of which is hereby acknowledged, the parties hereto agree as follows:

(1) Incorporation of ARMOA by Reference. **The provisions of the ARMOA are hereby incorporated in their entirety into this PSA by reference.**

The ARMOA provides substantive terms that the parties agree will govern and define their rights and liabilities in this PSA. The ARMOA defines many fundamental provisions including, but not limited to, a description of the conditions under which the parties may terminate this PSA, confidentiality requirements, contractual remedies, limitations on assignment and subcontracting, indemnification rights, intellectual property rules, limitation of liability, particular representations and warranties made by the parties, and jurisdictional issues. The PSA shall be governed by the terms and conditions stated in the ARMOA.

The provisions of this PSA set forth below describe the term of this PSA, the Services to be performed, performance standards, if any, fees that may be charged, regulatory rules applicable to the Services, and other particulars not otherwise described in the ARMOA.

In the event of any conflict between the provisions of the ARMOA and this PSA, the ARMOA shall control. The parties to this PSA may deviate from any terms

---

and conditions of the ARMOA, only to the extent that the ARMOA permits such deviation. Otherwise, such deviations are not permissible.

(2) Term. **This PSA shall commence on the execution date of this PSA and shall continue for so long as the ARMOA is effective.** [The PSA should run concurrently with the ARMOA unless the parties agree otherwise.]

(3) Description of Services.

(a) The services to be performed by PROVIDER are described below and in Exhibit A to this PSA (the "Services"). The Services will be performed with the oversight of and in conjunction with the offices of CUSTOMER located in the United States of America.

(b) Services generally shall be performed by PROVIDER at certain times of the day to provide for reasonable overlap of common working hours between PROVIDER and CUSTOMER.

**(c) [To the extent CUSTOMER requires specific back-up requirements for records constituting CUSTOMER's books of account, such requirements should be inserted in this Section 3, or if such requirements are regulatory in nature, in Section 6 below. The inclusion of specific back-up requirements may increase the Baseline Charges for the Services.]**

(4) Performance Standards.

(a) PROVIDER shall perform the Services in conformance with CUSTOMER's guidelines and procedures for the Services as agreed to by the parties and attached as Schedule .

**(b) [Section 4.1 of the ARMOA contemplates the insertion of Performance Standards, if any, for the Services. Insert any additional Performance Standards applicable to this PSA as new subsections of this Section 4 or as a new Schedule to this PSA.]**

**(c) [Section 4.2 of the ARMOA contemplates measuring the Performance Standards monthly, but allows for deviations. If different measurement periods are desired, such should be inserted in this Section 4.]**

C-2

---

(5) Fees.

**(a) CUSTOMER agrees to pay the following Baseline Charges to PROVIDER for performance of the Services: [Insert FTE rate]. [Please note that Exhibit A to the ARMOA requires Baseline Charges for new PSAs to be defined in each PSA. The Baseline Charges must be an FTE rate to avoid problems with the pricing adjustment, volume reduction and non-compete provisions of the ARMOA.]**

At the time of execution of the PSA, the parties expect that no. of FTEs will be required to complete the Services. The volume of services required under this PSA may increase during the term of the PSA. In case the volume increases during the term, the parties may agree to increase the number of FTEs providing the Services under the PSA, provided that such number will not exceed . **[Insert the maximum cap of FTE here. The number of FTEs may be changed outside this range in accordance with the Change Control Procedure in Section 19.0 of the ARMOA.]**

(b) [To the extent the fee structure is subject to regulation and the applicable requirements are not addressed in the ARMOA, include such requirements here. For instance, certain existing PSAs require PROVIDER to satisfy certain expense and cost allocation requirements, such as New York Insurance Department Regulation No. 33].

(6) Regulatory Matters.

(a) PROVIDER shall (i) assist and cooperate with CUSTOMER with respect to any regulatory examination or investigation of CUSTOMER or legal proceeding involving CUSTOMER, (ii) make available personnel with detailed knowledge of the Services to meet with CUSTOMER or any regulatory agency with jurisdiction over CUSTOMER at such place as may be requested by CUSTOMER or such regulatory agency, and (iii) employ a compliance officer to monitor the performance of the Services.

**(b) [Section 4.3 of the ARMOA requires PROVIDER to perform the Services in compliance with all applicable Laws, stock exchange rules or generally accepted, statutory or regulatory accounting or actuarial principles specified in a PSA. Therefore, any specific rules that CUSTOMER must require PROVIDER to**

C-3

---

**comply with in performing the Services should be set forth in this Section 6. For instance, an existing PSA requires that: "CUSTOMER records must be maintained by PROVIDER and CUSTOMER in accordance with applicable laws and regulations including, but not limited to, New York Insurance Department Regulation No. 152 (11 NYCRR Part 243)." However, please review Exhibit B to the ARMOA to ensure the specific rules have not already been included there.] Customer shall have the responsibility to inform the Provider about specific compliance and/or regulatory requirements that the Provider needs to comply with and provide regular updates and training regarding the same.**

(7) Remedies. [Insert additional remedies, if any, agreed to by the parties. See Section 4.4 of the ARMOA.]

(8) Intellectual Property

**(a) [Under Section 1.02 of Exhibit I to the ARMOA, all Technology and Intellectual Property developed jointly by the parties will be owned by PROVIDER. However, the parties may agree otherwise in a PSA. Therefore, any deviations from this rule should be specified in this Section 8.]**

**(b) [Schedule I-1 of Exhibit I to the ARMOA contains a list of Technology and Intellectual Property which may not be sublicensed, assigned or otherwise provided to a third party by CUSTOMER without the written consent of General Electric Company. Section 2.01(e) of Exhibit I to the ARMOA allows the parties to add additional intellectual property to this list for a particular PSA.]**

(c) [Section 2.02(e) of Exhibit I to the ARMOA states that PROVIDER will have no license to any CUSTOMER Licensed Technology following the termination of the ARMOA or any related PSA, unless the ARMOA or PSA provides otherwise. Therefore, to the extent the parties desire that PROVIDER continue to license certain CUSTOMER Licensed Technology after termination, this should be inserted in this Section 8.]

C-4

---

(d) [Section 5.03(a) of Exhibit I to the ARMOA states that CUSTOMER, on behalf of itself and its Affiliates, assumes all risk and liability with their use of the PROVIDER Licensed Technology, subject to any exclusions set forth in the ARMOA or PSA. Therefore, any exclusions to this rule should be inserted in this Section 8.]

(e) [Section 5.03(b) of Exhibit I to the ARMOA states that PROVIDER, on behalf of itself and its Affiliates, assumes all risk and liability with their use of the CUSTOMER Licensed Technology, subject to any exclusions set forth in the ARMOA or PSA. Therefore, any exclusions to this rule should be inserted in this Section 8.]

(f) [Section 5.04 of Exhibit I to the ARMOA states that the parties may agree in any PSA to amend the terms and conditions of licenses granted under Exhibit I to the ARMOA. Therefore, any additional or different licensing terms should be included in this Section 8.]

(9) Other Matters.

(a) Provider will have access to the System during the following time periods: [Insert time periods] (“Service Hours”). [Please refer to Section 6.1 of the ARMOA which contemplates that each PSA will define the “Service Hours” applicable to such PSA. CUSTOMER may also desire to define the parameters or scope of “access” in this Section 9 of the PSA.]

(b) [Section 16.0 of the ARMOA contains notice information for the parties. If representatives at the PSA level are different than the ARMOA level representatives, the parties should consider inserting additional notice information under this Section 9.]

(c) If known, the process owners for each party should be inserted into this Section 9.

(d) PROVIDER represents and warrants to CUSTOMER that

(i) PROVIDER has the necessary power and authority to execute, deliver and perform its

C-5

---

obligations under this PSA and this PSA has been or will be duly executed and delivered by PROVIDER and constitutes or will constitute the valid and binding agreement of PROVIDER, enforceable in accordance with its terms; and

(ii) The execution and delivery of this PSA by PROVIDER and the consummation by PROVIDER of the transactions herein contemplated will not contravene any provision of applicable Law, and will not constitute a breach of or default under any agreement or other instrument or any decree, judgment or order to which PROVIDER is currently a party or by which PROVIDER is bound.

(e) CUSTOMER represents and warrants to PROVIDER that

(i) CUSTOMER has the necessary power and authority to execute, deliver and perform its obligations under this PSA and this PSA has been or will be duly executed and delivered by CUSTOMER and constitutes or will constitute the valid and binding agreement of CUSTOMER, enforceable in accordance with its terms; and

(ii) The execution and delivery of this PSA by CUSTOMER and the consummation by CUSTOMER of the transactions herein contemplated will not contravene any provision of applicable Law, and will not constitute a breach of or default under any agreement or other instrument or any decree, judgment or order to which CUSTOMER is currently a party or by which CUSTOMER is bound.

(10) FURTHER, THE PARTIES AGREE THAT THE COMPLETE AND EXCLUSIVE STATEMENT OF THE AGREEMENT BETWEEN THE PARTIES RELATING TO THIS SUBJECT SHALL CONSIST OF 1) THIS PSA AND 2) THE ARMOA, INCLUDING AMENDMENTS TO THOSE DOCUMENTS FROM TIME TO TIME EXECUTED BY THE PARTIES. THIS STATEMENT OF THE AGREEMENT BETWEEN THE PARTIES SUPERSEDES ALL PROPOSALS OR OTHER PRIOR AGREEMENTS, ORAL OR WRITTEN, AND ALL OTHER COMMUNICATIONS BETWEEN THE

C-6

---

PARTIES RELATING TO THE SUBJECT DESCRIBED HEREIN.

[signatures appear on the following page]

C-7

---

IN WITNESS WHEREOF, authorized representatives of the parties have duly executed this PSA, as of the day and year first written above.

[CUSTOMER ENTITY]

By: \_\_\_\_\_

Name: \_\_\_\_\_

Title: \_\_\_\_\_

**[GE CAPITAL INTERNATIONAL SERVICES]**

By: \_\_\_\_\_

Name: \_\_\_\_\_

Title: \_\_\_\_\_

C-8

---

**Exhibit A**

**Services**

C-9

---

**EXHIBIT D**

**BCP/DRP Plans**

As of the Execution Date, CUSTOMER has identified the operational processes set forth in the table below as "Mission Critical" with respect to the Services provided under all of the MOAs. PROVIDER shall provide under this Agreement the Services described in the referenced BCP/DR Plans to the extent the related processes are included within the Services performed under this Agreement. The references to the BCP/DR Plans set forth in the table below include such BCP/DR Plans as they may be amended or supplemented from time to time by agreement of the parties.

<b>Business</b>	<b>Process ID</b>	<b>BCP/DR Plan Reference</b>
GEMICO	2052	*
GEMICO	2051	*
GEMICO	2050	*
GEMICO	2049	*
GEMICO	2048	*
GEMICO	2047	*
GEFA	2627	*
GEFA	1761	*
GEFA	1284	*
GEFA	1969	*
GEFA	1754	*
GEFA	1747	*
GEFA	1746	*
GEFA	1745	*
GEFA	1744	*

---

GEFA	1272	*
GEFA	1991	*
GEFA	2658	*
GEFA	3145	*
GEFA	1266	*
GEFA	1741	*
GEFA	2311	*
GEFA	1739	*
GEFA	1962	*
GEFA	2491	*
GEFA	1243	*
GEFA	1257	*
GEFA	2246	*
GEFA	1960	*
GEFA	1759	*
GEFA	3381	*
GEFA	3384	*

---

\*As provided by PROVIDER to CUSTOMER by email from \_\_\_\_\_ to \_\_\_\_\_ on \_\_\_\_\_, 2004.

D-2

---

**EXHIBIT E**



## Security Procedures

After the Execution Date, Provider shall comply with (i) the security procedures and policies generally applicable within the General Electric Company and its subsidiaries and as observed by PROVIDER immediately prior to the Execution Date, and (ii) such other security procedures and policies as CUSTOMER may direct, provided, that GECIS shall be entitled to recover its cost of complying with such procedures and policies as part of the Charges for the Services established pursuant to Section 2 and Schedule F.

---

### EXHIBIT F

#### Pricing Template

\*\*

---

### EXHIBIT G

#### Dispute Resolution

The following provisions shall govern any Dispute arising under the Agreement or the PSAs:

#### 1.1 General Provisions.

(a) Any dispute, controversy or claim arising out of or relating to this Agreement or any PSA, or the validity, interpretation, breach or termination thereof (a "Dispute"), shall be resolved in accordance with the procedures set forth in this Exhibit G, which shall be the sole and exclusive procedures for the resolution of any such Dispute unless otherwise specified below.

(b) Commencing with a request contemplated by Section 1.2 set forth below, all communications between the parties or their representatives in connection with the attempted resolution of any Dispute, including any mediator's evaluation referred to in Section 1.3 set forth below, shall be deemed to have been delivered in furtherance of a Dispute settlement and shall be exempt from discovery and production, and shall not be admissible in evidence for any reason (whether as an admission or otherwise), in any arbitral or other proceeding for the resolution of the Dispute.

(c) The parties expressly waive and forego any right to (i) punitive, exemplary, statutorily-enhanced or similar damages in excess of compensatory damages, and (ii) trial by jury.

(d) The specific procedures set forth below, including but not limited to the time limits referenced therein, may be modified by agreement of the parties in writing.

(e) All applicable statutes of limitations and defenses based upon the passage of time shall be tolled while the procedures specified in this Exhibit G are pending. The parties will take such action, if any, required to effectuate such tolling.

#### 1.2 Consideration by Senior Executives.

If a Dispute is not resolved in the normal course of business at the operational level, the parties shall attempt in good faith to resolve such Dispute by negotiation between executives who hold, at a minimum, the office of President and CEO of the respective business entities involved in such Dispute. Either party may initiate the executive negotiation process by providing a written notice to the other (the "Initial Notice"). Fifteen (15) days after delivery of the Initial Notice, the receiving party shall submit to the other a written response (the "Response"). The Initial Notice and the Response shall include (i) a statement of the Dispute and of each party's position, and (ii) the name and title of the executive who will represent that party and of any other person who will accompany the executive. Such executives will meet in

---

person or by telephone within thirty (30) days of the date of the Initial Notice to seek a resolution of the Dispute.

#### 1.3 Mediation.

If a Dispute is not resolved by negotiation as provided in Section 1.2 within forty-five (45) days from the delivery of the Initial Notice, then either party may submit the Dispute for resolution by mediation pursuant to the CPR Institute for Dispute Resolution (the "CPR") Model Mediation Procedure as then in effect. The parties will select a mediator from the CPR Panels of Distinguished Neutrals. Either party at commencement of the mediation may ask the mediator to provide an evaluation of the Dispute and the parties' relative positions.

#### 1.4 Arbitration.

(a) If a Dispute is not resolved by mediation as provided in Section 1.3 within thirty (30) days of the selection of a mediator (unless the mediator chooses to withdraw sooner), either party may submit the Dispute to be finally resolved by arbitration pursuant to the CPR Rules for Non-Administered Arbitration as then in effect (the "CPR Arbitration Rules"). The parties consent to a single, consolidated arbitration for all known Disputes existing at the time of the arbitration and for which arbitration is permitted.

(b) The neutral organization for purposes of the CPR Arbitration Rules will be the CPR. The arbitral tribunal shall be composed of three arbitrators, of whom each party shall appoint one in accordance with the "screened" appointment procedure provided in Rule 5.4 of the CPR Arbitration Rules. The arbitration shall be conducted in New York City. Each party shall be permitted to present its case, witnesses and evidence, if any, in the presence of the other party. A written transcript of the proceedings shall be made and furnished to the parties. The arbitrators shall determine the Dispute in accordance with the law of the State of New York, without giving effect to any conflict of law rules or other rules that might render such law inapplicable or unavailable, and shall apply this Agreement, or the applicable MOA or PSA, according to its terms, provided that the provisions relating to arbitration shall be governed by the Federal Arbitration Act, 9 U.S.C. §§ 1 et seq.

(c) The parties agree to be bound by any award or order resulting from any arbitration conducted in accordance with this Section 1.4 and further agree that judgment on any award or order resulting from an arbitration conducted under this Section 1.4 may be entered and enforced in any court having jurisdiction thereof.

(d) Except as expressly permitted by this Agreement, no party will commence or voluntarily participate in any court action or proceeding concerning a Dispute, except (i) for enforcement as contemplated by Section 1.4(c) above, (ii) to restrict or vacate an arbitral decision based on the grounds specified under applicable law, or (iii) for interim relief as provided in paragraph (c) below. For purposes of the foregoing, the parties hereto submit to the non-exclusive jurisdiction of the courts of the State

(e) In addition to the authority otherwise conferred on the arbitral tribunal, the tribunal shall have the authority to make such orders for interim relief, including injunctive relief, as it may deem just and equitable. If the tribunal shall not have been appointed, either party may seek interim relief from a court having jurisdiction if the award to which the applicant may be entitled may be rendered ineffectual without such interim relief. Upon appointment of the tribunal following any grant of interim relief by a court, the tribunal may affirm or disaffirm such relief, and the parties will seek modification or rescission of the court action as necessary to accord with the tribunal's decision.

Each party will bear its own attorneys' fees and costs incurred in connection with the resolution of any Dispute in accordance with this Exhibit G.

1.5 Continued Performance

The parties agree to continue to perform their respective obligations under this Agreement and any related PSA during a Dispute.

**EXHIBIT H**

**Carve-Out Option**

1.0 Affected Carve-Out Resources (a) If the Carve-Out Option is exercised in connection with any Carve-Out Condition other than a PROVIDER Divestiture, the Carve-Out Option shall be exercisable for all, but not less than all, of the Carve-Out Resources used by PROVIDER in connection with all of the then-outstanding MOAs and related PSAs.

(b) If the Carve-Out Option is exercised in connection with a PROVIDER Divestiture, the Carve-Out Option shall be exercisable for all, but not less than all, of the Carve-Out Resources used by PROVIDER in connection with Services transferred to the acquiror as part of the PROVIDER Divestiture.

2.0 Warranty. As of the date hereof, PROVIDER represents and warrants that to its knowledge there is no law or existing contractual obligation of PROVIDER that would materially impair the exercise of the Carve-Out Option by CUSTOMER with relation to any material Hardware, Third-Party Software or PROVIDER Licensed Technology, or to any PROVIDER Employees, except to the extent expressly disclosed to and approved in writing by CUSTOMER.

3.0 Notice. CUSTOMER shall notify PROVIDER of its exercise of the Carve-Out Option (i) at the expiration of the Initial Term, within fifteen (15) days following the Notification Date; (ii) within fifteen (15) days of notice to PROVIDER of its intent to terminate the affected PSAs in the case of a Material Breach, (iii) within one hundred twenty (120) days following a Change of Control of PROVIDER, and (iv) within thirty (30) days of PROVIDER's notice to CUSTOMER of a PROVIDER Divestiture.

4.0 Consents. CUSTOMER and PROVIDER shall cooperate with each other and shall use commercially reasonable efforts to obtain any approvals, permissions, consents or grants required for CUSTOMER to exercise the Carve-Out Option with relation to all Carve-Out Resources, including Third Party Software and Third Party Agreements.

5.0 No Carve-Out Option for Acquiror. No acquiror of a business operation divested by CUSTOMER shall be entitled to exercise the Carve-Out Option.

6.0 Definitions. As used in this Exhibit H, the following capitalized terms shall have the following meaning:

(a) "PROVIDER" refers to PROVIDER and each Affiliate of PROVIDER providing Services under any MOA or PSA, as applicable.

(b) "Carve-Out Resources" refers to the Hardware, Third Party Software, PROVIDER Licensed Technology, PROVIDER Employees, Third Party Agreements, and the Facility, to the extent that they are severable and identifiable, as described below.

(c) "Carve-Out Conditions" means (a) any Change in Control of PROVIDER, (b) a Material Breach, (c) CUSTOMER's becoming entitled to terminate the Agreement under Section 8.4 of the Agreement, (d) the expiration of the Initial Term, or (e) the occurrence of a PROVIDER Divestiture.

For the purposes of this provision only, a "Material Breach" shall refer to any breach or a series of breaches resulting in the termination of one or more PSAs where: (i) such breach or breaches are material and relate to Excluded Matters (other than matters involving the gross negligence of PROVIDER), (ii) CUSTOMER is entitled to recover damages from PROVIDER in excess of \$2,000,000 relating to such breach or breaches, or (iii) such PSAs accounted for ten percent (10%) or more of the aggregate billings by PROVIDER to CUSTOMER and its Affiliates under all of the MOAs during the immediately preceding twelve (12) months, provided, that any dispute as to whether a matter constitutes a Material Breach shall be resolved pursuant to the dispute resolution provisions set forth in Exhibit G and any exercise of the Carve-Out Option by CUSTOMER based on any such matter shall be deferred until such dispute is resolved.

(d) A "Change of Control" of PROVIDER means any (i) consolidation or merger of PROVIDER with or into another entity or entities (whether or not PROVIDER is the surviving entity), excluding any such consolidation or merger with or into GE or an Affiliate of GE, (ii) any sale or transfer by PROVIDER of fifty percent (50%) or more of its assets, excluding any such sale to GE or an Affiliate of GE, (iii) any sale, transfer or issuance or series of sales, transfers or issuances of shares or other voting securities of PROVIDER by PROVIDER or the holders thereof, as a result of which one holder, or a group of holders acting in concert (other than GE or an Affiliate of GE), acquires the voting power (under ordinary circumstances) to elect a majority of the board of directors (or similar managing group) of PROVIDER. Notwithstanding the foregoing, no transaction of the type described in clauses (i), (ii) or (iii) shall constitute a Change of Control of PROVIDER if, as of immediately following such transaction, persons that possess the voting power (under ordinary circumstances) to elect a majority of the board of directors (or similar managing group) of PROVIDER as of immediately prior to such transaction continue to hold (directly or indirectly) such voting power.

(e) "Fair Market Value" shall mean the fair market value of the Carve-Out Resources as proposed by CUSTOMER in its Carve-Out Option notice, served prior to the Notification Date, and agreed by PROVIDER. In the event of disagreement between the parties as to the fair market value of the Carve-Out Resources as specified in the Carve-Out Option notice, the parties shall appoint one (1) appraiser each and such two (2) appraisers will jointly appoint a third (3<sup>rd</sup>) appraiser within thirty (30) days of such disagreement. Within sixty (60) days of their appointment, the three (3) appraisers will each determine and certify in writing the Fair Market Value of the Carve-Out Resources consistent with the methodology described below. The Fair Market Value shall be the average of the three (3) appraised values, which value shall be final and binding on the parties. For the purposes of this provision, an appraiser shall be an investment banker of international repute. Fair Market Value shall be determined by the appraisers pursuant to the methodology set forth in Schedule H-1 to this Exhibit H.

7.0 Terms and Conditions of Option. If the Carve-Out Option is exercised, the parties agree to consider in good faith and agree upon commercially reasonable terms and conditions for

H-2

the exercise of such option proposed by either party, including, without limitation, the terms and conditions (A) to optimize the consequences for both parties on their respective tax and regulatory positions (B) to optimize the fulfillment of the obligations of PROVIDER to its employees, or (C) to optimize the execution of the transition of the Carve-Out Resources from PROVIDER to CUSTOMER or its designee, or (D) to optimize the transaction structure, or combination of transaction structures, to minimize any adverse financial impact to either party, including, but not limited to, the consideration of joint ventures or equity ownership or asset sales or some combination thereof provided, that such optimization does not materially expand or reduce the rights of CUSTOMER relating to the Carve-Out Option.

8.0 Services Transfer Assistance. PROVIDER shall be obligated to provide Services Transfer Assistance to CUSTOMER until the Carve-Out is completed, but shall not be required to provide any portion of the Services provided to CUSTOMER under the MOAs after CUSTOMER has acquired from PROVIDER the Carve-Out Resources used by PROVIDER to provide such Services or to provide Services Transfer Assistance for (i) in the case of an exercise of the Carve-Out Option relating to the expiration of the Initial Term or a PROVIDER Divestiture, more than fourteen (14) months, and (ii) eighteen (18) months, in the case of an exercise of the Carve-Out Option relating to a Change of Control of PROVIDER; AND (iii) in any other case, twenty-four (24) months.

9.0 Payment Obligations. Upon completion of the Carve-Out, all outstanding MOAs and PSAs shall automatically terminate. The monetary consideration to be paid by CUSTOMER for the Carve-Out Resources upon the exercise of the Carve-Out Option shall be equal to (i) the Fair Market Value of the Carve-Out Resources if CUSTOMER exercises the Carve-out Option upon the expiration of the Initial Term, (ii) the book value and all related transition costs of the Carve-Out Resources at the time of transfer if CUSTOMER exercises the Carve-out Option following (a) a Material Breach of any MOA or PSA by PROVIDER, and (b) a Change of Control of PROVIDER or (iii) if CUSTOMER exercises the Carve-Out Option in connection with a PROVIDER Divestiture, the lesser of (y) the book value of the assets to be purchased by CUSTOMER or (z) the value of the divested operations relating to CUSTOMER implied by the consideration to be paid by the acquiror in the PROVIDER Divestiture. The methodology for calculating book value for purposes of this paragraph is set forth in Schedule H-2 to this Exhibit H.

10. Transfer of Carve-Out Resources. The Carve-Out Resources shall be transferred to CUSTOMER as set forth below (subject to any limitations on such transfer referred to in Section 2.0, above):

(a) Hardware. "Hardware" means the hardware and other furniture, fixtures and equipment owned or leased and then currently being used by PROVIDER exclusively to perform the Services under any MOA or PSA or to support such performance. To the extent any such items are not used by PROVIDER exclusively to perform the Services, PROVIDER shall assist CUSTOMER or its designee in purchasing, leasing or otherwise obtaining the use of comparable items.

H-3

(b) Third-Party Software. If PROVIDER has licensed or purchased and is using any Software licensed from a third-party exclusively to provide or support the provision of the Services under any MOA or PSA ("Third-Party Software"), CUSTOMER may elect to take, or elect to direct to its designee, a transfer or an assignment of any and all of the licenses for such software and any attendant maintenance agreements, provided that such licenses are by their terms transferable or assignable. To the extent any such licenses and the attendant current maintenance agreements are not used exclusively to provide Services to CUSTOMER or are not transferable or assignable by PROVIDER to CUSTOMER or its designee, PROVIDER shall assist CUSTOMER or its designee, in obtaining in the name of CUSTOMER or its designee and at the expense of CUSTOMER, a license for such software and a maintenance agreement for such software.

(c) PROVIDER Employees. CUSTOMER or its designee shall have the right to make offers of employment to any or all PROVIDER employees exclusively performing or supporting the performance of the Services ("PROVIDER Employees"). To the extent any PROVIDER Employees perform or support the performance of the Services on other than an exclusive basis (including all employees indirectly supporting the performance of the Services by providing administrative services, including legal, human resources, compliance and other services, ("Non-exclusive Employees"), PROVIDER and CUSTOMER shall use commercially reasonable efforts to allocate such Non-exclusive Employees in an equitable manner between the parties.

(d) Third-Party Agreements. "Third Party Agreements" means any third party agreements not otherwise treated in this Exhibit H, and used by PROVIDER exclusively in connection with Services being provided under any MOA or PSA, including, third party agreements for maintenance, business continuity and disaster recovery services and other necessary third party services then being used by PROVIDER to perform the Services. To the extent any such agreements are not used by PROVIDER exclusively to provide such Services or are not transferable by PROVIDER to CUSTOMER, PROVIDER shall assist CUSTOMER in obtaining in CUSTOMER's name, an agreement for comparable services.

(e) Facilities. PROVIDER will use commercially reasonable efforts to assist CUSTOMER in obtaining a facility comparable to the facility used by PROVIDER to provide the Services (the "Facility").

H-4

## Schedule H-1

### Fair Market Value Calculation

General methods for calculation shall be: (1) a Discounted Cash Flow (DCF) analysis based on the contractual cash flows represented by the aggregate Genworth MOAs and adjusted for carve-out costs; (2) multiples of Revenue, Earnings before Interest, Taxes, Depreciation and Amortization (EBITDA) and EBIT for comparable transactions at the time of carve out. Projected net cash flow will be discounted on the basis outlined below. The final valuation will consider market factors, making appropriate adjustments to the variables below.

#### 1. DCF Methodology

##### Cash Flows In.

Cash flows in (revenue) will be calculated using Genworth Group payments as of the valuation date and projected forward over the Initial Term and Renewal Period, taking into account any future contractual margin reductions, historical volume trends, and any known events as documented in the most recent quarterly capacity management processes.

##### Cash Flows Out.

Expenses will be calculated as of the valuation date using actual expenses and projected forward taking into account the following categories and trends:

- (a) C&B up 12%
- (b) FX up 6%
- (c) Facility down 4%
- (d) Technology & Telecom down 8% and 15% respectively
- (e) Direct support down 13%
- (f) Other variable down 6%
- (g) Overhead down 3%

NOTE: Expense trends will change over time and will be re-calculated based on the prevailing trends supported by the most recent annual pricing process.

Carve Out Costs Subtracted From DCF Valuation

Carve-out costs will include one-time costs including, without limitation, legal entity set-up, transaction costs, capital investments, and the costs to replace assets and personnel required for the Genworth Group to continue the operations of its Insurance business on a stand-alone basis

in substantially the same manner as immediately prior to the exercise of the Carve-Out Option, but which are not to be transferred from GECIS to Genworth at the time of the carve-out.

Term

The term shall be the initial term of the contract and the renewal term.

Discount Rates

The discount rate applied to the cash flows shall be determined to take into account the following factors:

- (1) private company with a single customer.
- (1) Cost of Capital of Comparable companies
- (2) sufficient to generate an after tax equity return
- (3) growth rate.

Final DCF Valuation

The final DCF valuation shall take into consideration NPV of future cash flows over the Initial Term and Renewal Period and may be adjusted for any market conditions that apply to companies of similar characteristics with respect to market space, company maturity, cash flow profile and general market conditions.

2. Multiples Valuation Methodology

The multiples valuations will be based upon the stated revenue and pre-tax earnings for the PROVIDER insurance segment servicing the Genworth Group under the MOAs in the most recent year. Multiples will be applied from comparable transactions to the calculated EBITDA and EBIT amounts, and to the stated revenue.

Final Valuation

In case of disagreement, the final valuation shall be developed by the appraisers appointed in accordance with Section 6.0(e) of Exhibit H, taking into account the factors outlined above.

H-1-2

**Schedule H-2**

**Book Value Calculation**

General method for calculating book value shall be aggregation of transferable assets and transferable liabilities. An illustrative asset category list is included below for the purposes of describing the form analysis to be completed as of the valuation date.

Un-audited Initial Asset Value	Total
\$K	
Account Head	
Assets	
Cash & Bank Balance	
Receivables	236
Accrued Revenues	2,529
Loans to Employees	241
Travel Advances	265
Security Deposit / Adv. Rent	504
Project Advances	—
Fixed Assets (Net)	6,973
Inter Company Deposits/Loans	—
Investment in Countrywide by Mauritius	—
Inter Co Balances(cost sharing)	—
Other Assets	706
<b>Total Assets</b>	<b>11,455</b>

## Assets

At the time the Carve-Out Option is exercised under circumstances requiring payment of the book value of the Carve-Out Resources (a "book value carve out"), the parties will analyze each asset and evaluate its transferability to the Genworth Group in accordance with Exhibit H (i.e. those that are identifiable and severable). Only such Carve-Out Resources as are actually transferred shall be included in the calculation of Book Value.

## Liabilities

The above calculation assumes that no liabilities (other than Carve-Out Resources) are transferred to Genworth in a book value carve out situation. At the time of a book value carve out, Genworth and PROVIDER will evaluate the transferability of liabilities pertaining directly to the Genworth Group and may agree that such liabilities will be transferred to the Genworth Group. All such transferred liabilities will be deducted from the asset values to arrive at book value to be paid to PROVIDER.

---

## **EXHIBIT I**

### **Intellectual Property**

#### **ARTICLE I Ownership**

##### **Section 1.01. Ownership of Pre-Closing IP and Solely Developed IP.**

As between CUSTOMER and PROVIDER (i) all Technology and Intellectual Property owned or licensed by CUSTOMER or its Affiliates or PROVIDER or its Affiliates prior to the Execution Date shall continue to be so owned or licensed after the Execution Date, (ii) all Technology and Intellectual Property acquired, developed or licensed solely by or on behalf of CUSTOMER or its Affiliates or solely by or on behalf of PROVIDER or its Affiliates after the Execution Date and used in connection with the Services provided under the Agreement and PSAs shall continue to be owned or licensed by the applicable acquirer, developer or licensee.

##### **Section 1.02. Ownership of Post-Closing IP Jointly-Developed - Default Rule and Modification of Default Rule**

After the Execution Date, as between CUSTOMER and PROVIDER, all Technology and Intellectual Property developed jointly by or on behalf of PROVIDER and CUSTOMER pursuant to, or in connection with, the Agreement and PSAs shall be owned by PROVIDER. PROVIDER and CUSTOMER may agree in any PSA executed after the Execution Date that certain Technology or Intellectual Property that would otherwise be owned by PROVIDER shall be owned, as between the parties, by CUSTOMER. This Agreement and the PSAs shall not assign any rights to Technology or Intellectual Property between the parties other than as specifically set forth herein or in a PSA.

##### **Section 1.03. Residual Knowledge.**

Notwithstanding anything to the contrary contained in this Agreement or any PSA, PROVIDER and CUSTOMER may further develop their generalized knowledge, skills and experience, and the mere subsequent use by the parties of such knowledge, skills and experience shall not constitute a breach of this Agreement, subject to their obligations respecting CUSTOMER's Confidential Information or PROVIDER Confidential Information, as the case may be, pursuant to the Agreement.

#### **ARTICLE II License Grant**

##### **Section 2.01. Grant from PROVIDER to CUSTOMER and its Affiliates**

(a) PROVIDER hereby grants, and will cause its Affiliates to grant, to CUSTOMER and its Affiliates a non-exclusive, irrevocable, royalty-free, fully paid up,

---

worldwide, perpetual right and license, with no right to sublicense except as provided herein, under the PROVIDER Licensed Technology: (i) to allow employees, directors and officers of CUSTOMER and its Affiliates to use and practice the PROVIDER Licensed Technology for internal purposes, (ii) to make, have made, use, sell, have sold, import, and otherwise commercialize Licensed Products and Services and (iii) to create Improvements in accordance with Section 2.03 of this Exhibit I.

(b) Subject to paragraph (e), below, CUSTOMER and its Affiliates may grant sublicenses of the right and license granted under this Section 2.01 of this Exhibit I to an acquirer of any of the businesses, operations or assets of CUSTOMER or its Affiliates to which this Agreement relates, which acquirer executes an agreement to be bound by all obligations of CUSTOMER and its Affiliates under this Exhibit I relating to such right and license (a copy of which agreement is provided to PROVIDER). CUSTOMER and its Affiliates may assign the right and license granted under this Section 2.01 of this Exhibit I in accordance with Section 5.01 of this Exhibit I.

(c) Subject to Section 11.0 (Confidentiality) of the Agreement, CUSTOMER and its Affiliates may permit their suppliers, contractors and consultants to exercise the right and license granted to CUSTOMER and its Affiliates under this Section 2.01 of this Exhibit I on behalf of and at the direction of CUSTOMER and its Affiliates (and not solely for the benefit of such suppliers, contractors and consultants).

(d) Subject to Section 11.0 (Confidentiality), CUSTOMER and its Affiliates may permit employees, directors and officers of their customers and suppliers in the ordinary course of CUSTOMER's business (and not Persons who are customers or suppliers merely to access and use the PROVIDER Licensed Technology) to use training and productivity-enhancing Software and documentation that is subject to the right and license granted under this Section 2.01 of this Exhibit I and is for general use by customers and suppliers, provided that CUSTOMER's or its Affiliates' purpose in permitting such use is to benefit the business of CUSTOMER or its Affiliates, provided further that such customers and suppliers may not use any such Software and documentation in advertising, publicity or marketing activities without PROVIDER'S prior written approval, which approval will not be unreasonably withheld.

(e) Notwithstanding anything in this Agreement or any PSA to the contrary, CUSTOMER and its Affiliates shall not sublicense, assign or otherwise provide to any third party (including any acquiring entity, contractor, consultant, customer or supplier of CUSTOMER or its Affiliates) any of the Technology or Intellectual Property set forth on Schedule I-1, without the prior written consent of General Electric Company, which will not be unreasonably withheld. For the avoidance of doubt, it shall not be unreasonable to withhold such consent if any such acquiring entity, contractor, consultant, customer or supplier is a competitor of PROVIDER or its Affiliates. The parties may mutually agree in a PSA executed after the Execution Date to amend Schedule I-1 to include additional Technology or Intellectual Property.

**Section 2.02. Grant from CUSTOMER to PROVIDER and its Affiliates**

(a) (i) CUSTOMER hereby grants, and will cause its Affiliates to grant, to PROVIDER and its Affiliates a non-exclusive, royalty-free, irrevocable subject to paragraph (e) below, fully paid up, worldwide right and license, with no right to sublicense except as provided herein, under the CUSTOMER Licensed Technology: (A) to allow employees, directors and officers of PROVIDER and its Affiliates to use and practice the CUSTOMER Licensed Technology for internal purposes, (B) to make, have made, use, sell, have sold, import, and otherwise commercialize Licensed Products and Services and (C) to create Improvements in accordance with Section 2.03 of this Exhibit I.

(ii) In addition to the foregoing right and license, CUSTOMER hereby grants, and shall cause its Affiliates to grant, to PROVIDER a non-exclusive, royalty-free, fully paid up, worldwide right and license, irrevocable during the term of this Agreement and with no right to sublicense, to use all CUSTOMER Licensed Technology, trademarks, service marks, trade dress, logos and other identifiers of source owned by CUSTOMER or its Affiliates and provided to PROVIDER for the sole purpose of providing Services to CUSTOMER and its Affiliates under the Agreement and PSAs. PROVIDER shall comply with all reasonable quality control standards and guidelines provided by CUSTOMER to PROVIDER in writing that are intended to protect the goodwill associated with such trademarks, service marks, trade dress, logos and other identifiers of source. PROVIDER may permit its suppliers, contractors and consultants to exercise such right and license on behalf of and at the direction of PROVIDER (and not for the benefit of such suppliers, contractors and consultants), subject to the prior written consent of CUSTOMER (which shall not be required in the case of temporary employees of PROVIDER and which, otherwise, shall not be unreasonably withheld) and the receipt of any necessary regulatory approval.

(b) Subject to the provisions of Section 10.0 (Assignment and Subcontracting) of the Agreement, PROVIDER and its Affiliates may grant sublicenses of the right and license granted under this Section 2.02 of this Exhibit I to an acquiror of any of the businesses, operations or assets of PROVIDER or its Affiliates to which this Agreement relates, which acquiror executes an agreement to be bound by all obligations of PROVIDER and its Affiliates under this Exhibit I relating to such right and license (a copy of which agreement is provided to CUSTOMER). PROVIDER and its Affiliates may assign the right and license granted under this Section 2.02 of this Exhibit I in accordance with Section 5.01 of this Exhibit I.

(c) Subject to the provisions of Section 11.0 ("Confidentiality") and Section 10 ("Assignment and Subcontracting") of the Agreement, PROVIDER and its Affiliates may permit their suppliers, contractors and consultants to exercise the right and license granted to PROVIDER and its Affiliates under this Section 2.02 of this Exhibit I on behalf of and at the direction of PROVIDER and its Affiliates (and not solely for the benefit of such suppliers, contractors and consultants).

(d) Subject to the provisions of Section 11.0 ("Confidentiality") of the Agreement, PROVIDER and its Affiliates may permit employees, directors and officers of their customers and suppliers in the ordinary course of PROVIDER' business (and not Persons who

I-3

---

are customers or suppliers merely to access and use the CUSTOMER Licensed Technology) to use training and productivity-enhancing Software and documentation that is subject to the right and license granted under this Section 2.02 of this Exhibit I and is for general use by customers and suppliers, provided that PROVIDER' or its Affiliates' purpose in permitting such use is to benefit the business of PROVIDER or its Affiliates, provided further that such customers and suppliers may not use any such Software and documentation in advertising, publicity or marketing activities without CUSTOMER's prior written approval, which approval will not be unreasonably withheld.

(e) PROVIDER, its Affiliates and their respective sub-licensees shall have no license to any CUSTOMER Licensed Technology following the expiration or termination of the Agreement or all PSAs to which such CUSTOMER Licensed Technology relates (including any termination in connection with the exercise by CUSTOMER of the Carve-Out Option), unless otherwise specifically agreed in the Agreement or any PSA. For the avoidance of doubt, the licenses under this Section 2.02 of this Exhibit I shall continue during the provision of any Services Transfer Assistance.

**Section 2.03. Improvements.** Improvements and all Intellectual Property rights therein made solely by or on behalf of the Licensee shall be owned by the Licensee. Improvements jointly developed by Licensee and Licensor shall be owned by PROVIDER. For the avoidance of doubt, (i) Licensee shall not own any Intellectual Property rights or Technology licensed to Licensee hereunder and (ii) each party may freely assign or license Improvements owned by it but shall not have the right to assign any Intellectual Property or Technology of the other party and shall only have the right to sublicense Intellectual Property or Technology of the other party as expressly set forth herein. No rights are granted to the other party to any Improvements owned by each party, unless such Improvements are otherwise subject to the provisions of Sections 2.01 or 2.02 of this Exhibit I.

**Section 2.04. Section 365(n) of the Bankruptcy Code** All rights and licenses granted under this Exhibit I are, and shall otherwise be deemed to be, for purposes of Section 365(n) of the United States Bankruptcy Code (the "**Bankruptcy Code**"), licenses of rights to "intellectual property" as defined under Section 101(35A) of the Bankruptcy Code. The parties shall retain and may fully exercise all of their respective rights and elections under the Bankruptcy Code.

**Section 2.05. Customers.** Each party agrees that it will use reasonable efforts to not knowingly bring any legal action or proceeding against, or otherwise communicate with, any customer of the other party with respect to any alleged infringement, misappropriation or violation of any Intellectual Property of such party licensed hereunder based on such customer's use of the other party's products or services without first providing the other party written notice of such alleged infringement, misappropriation or violation.

**Section 2.06. Reservation of Rights.** All rights not expressly granted by a party hereunder are reserved by such party. Without limiting the generality of the foregoing, the parties expressly acknowledge that nothing contained herein shall be construed or interpreted as a grant, by implication or otherwise, of any licenses other than the licenses expressly set forth in

I-4

---

this Article II. The licenses granted in Sections 2.01 and 2.02 of this Exhibit I are subject to, and limited by, any and all licenses, rights, limitations and restrictions with respect to, as applicable, the PROVIDER Licensed Technology and the CUSTOMER Licensed Technology previously granted to or otherwise obtained by any third party that are in effect as of the Execution Date.

**Section 2.07. Delivery of Software.**

(a) Either party may request one (1) copy of Software or other electronic or written documentation ("Electronic Materials") that (i) is subject to the license granted to such requesting party under this Article II and (ii) has not already been provided to the requesting party since the Execution Date. The delivering party shall make available or deliver to the requesting party a copy of any such Software or Electronic Materials that are in existence at the time of such request.

(b) All Software and Electronic Materials required to be made available to or delivered to a Licensee pursuant to Section 2.07(a) of this Exhibit I will be delivered by the Licensor to the Licensee electronically, or with the assistance of the Licensor, downloaded by the Licensee from the Internet, provided that the Licensee complies with all reasonable security measures implemented by the Licensor.

**Section 2.08. Liability for Acts of Permitted Users and Sublicensees.**

Each Licensee shall be liable to the Licensor for the acts and omissions of the Licensee's sublicensees and other persons permitted to use any Intellectual Property or Technology of the Licensor in accordance with this Article II as though such persons were licensees thereunder.

### ARTICLE III Covenants

**Section 3.01. Ownership.** No party shall represent that it has any ownership interest in any Intellectual Property or Technology of the other party licensed hereunder.

**Section 3.02. Prosecution and Maintenance.** Each party retains the sole right to protect at its sole discretion the Intellectual Property and Technology owned by such party, including, without limitation, deciding whether to file and prosecute applications to register patents, copyrights and mask work rights included in such Intellectual Property, whether to abandon prosecution of such applications, and whether to discontinue payment of any maintenance or renewal fees with respect to any patents included in such Intellectual Property.

#### **Section 3.03. Third Party Infringements, Misappropriations, Violations**

(a) Subject to any confidentiality restrictions that would prevent such disclosure, each party shall promptly notify the other party in writing of any actual or possible infringements, misappropriations or other violations of the Technology or Intellectual Property of the other party being licensed hereunder by a third party that come to such party's attention, as

I-5

---

well as the identity of such third party or alleged third party and any evidence of such infringement, misappropriation or other violation within such party's custody or control. The other party shall have the sole right to determine at its sole discretion whether any action shall be taken in response to such infringements, misappropriations or other violations.

(b) Subject to any confidentiality restrictions that would prevent such disclosure, each party shall promptly notify the other party in writing upon learning of the existence or possible existence of rights held by any third party that may be infringed, misappropriated or otherwise violated by the use or practice of the Technology or Intellectual Property of the other party (or any element or portion thereof) licensed hereunder, as well as the identity of such third party and any evidence relating to such purported infringement, misappropriation or other violation within such party's custody or control. Such party shall cooperate fully with the other party to avoid infringing, misappropriating or violating any third party intellectual property rights, and shall discontinue all use and practice of such Technology or Intellectual Property that is the subject of such purported infringement, misappropriation or other violation upon the reasonable request of the other party.

(c) Subject to any confidentiality restrictions that would prevent such disclosure, each party shall promptly notify the other party in writing upon learning of the existence or possible existence of rights held by any third party that may be infringed, misappropriated or otherwise violated by the use or practice of the Technology or Intellectual Property (or any element or portion thereof) licensed to the other party hereunder, as well as the identity of such third party. The other party shall cooperate fully with such party to avoid infringing, misappropriating or violating any third party intellectual property rights, and shall discontinue all use and practice of such Technology or Intellectual Property that is the subject of such purported infringement, misappropriation or other violation upon the reasonable request of such party, and shall provide such party any evidence relating to such purported infringement, misappropriation or other violation within the other party's custody or control.

**Section 3.04. Patent Marking.** Each party acknowledges and agrees that it will comply with all reasonable requests of the other party relative to patent markings required to comply with or obtain the benefit of statutory notice or other provisions.

### ARTICLE IV No Termination

Notwithstanding anything to the contrary contained herein or in the Agreement, but subject to Section 2.02(e) of this Exhibit I, the terms and conditions of this Exhibit I may only be terminated upon the mutual written agreement of the parties. In the event of a breach of the terms or conditions of this Exhibit I, the sole and exclusive remedy of the non-breaching party shall be to recover monetary damages and/or to obtain injunctive or equitable relief as otherwise provided in the Agreement.

I-6

---

### ARTICLE V General Provisions

#### **Section 5.01. Assignment.**

(a) The rights and duties under this Exhibit I shall not be assignable or delegable, in whole or in part, by any party hereto to any third party, including, without limitation, Affiliates of any party, without the prior written consent of the other party hereto and any necessary regulatory approval, and any attempted assignment or delegation without such consent shall be null and void. Notwithstanding the foregoing, the rights and duties under this Exhibit I may be assigned by any party as follows without obtaining the prior written consent of the other party hereto:

(i) PROVIDER, in its sole discretion, may assign any or all of its rights under this Exhibit I, and may delegate any or all of its duties under this Exhibit I to any Affiliate of PROVIDER at any time, which expressly accepts such assignment in writing and assumes, as applicable, any such obligations, provided that PROVIDER shall continue to remain liable for the performance by such assignee;

(ii) CUSTOMER, in its sole discretion, may assign any or all of its rights under this Exhibit I, and may delegate any or all of its duties under this Exhibit I to any Affiliate of CUSTOMER at any time, which expressly accepts such assignment in writing and assumes, as applicable, any such obligations, provided that CUSTOMER shall continue to remain liable for the performance by such assignee; and

(iii) Subject to Section 2.01(e) of this Exhibit I, each party may assign any or all of its rights, or delegate any or all of its duties, under this Exhibit I to (i) an acquiror of all or substantially all of the equity or assets of the business of such party to which this Agreement relates or (ii) the surviving entity in any merger, consolidation, equity exchange or reorganization involving such party, provided that such acquiror or surviving entity, as the case may be, executes an agreement to be bound by all the obligations of such party under this Exhibit I (a copy of which agreement is provided to the other party).

(b) If a party requests the written consent of the other party to any assignment of this Agreement, the other party agrees to negotiate in good faith with such party regarding such consent. The terms and conditions of this Exhibit I shall also be binding upon and inure to the benefit of and be enforceable by the successors, legal representatives and permitted assigns of each party hereto. All license rights and covenants contained herein shall run with all Intellectual Property of any party licensed hereunder and shall be binding on any successors in interest or assigns thereof.

**Section 5.02. Warranty and Disclaimer.** NOTWITHSTANDING ANYTHING TO THE CONTRARY HEREIN OR IN ANY PSA, BUT SUBJECT TO THE INDEMNITIES CONTAINED IN SECTION 12 OF THE AGREEMENT, THE INTELLECTUAL PROPERTY AND TECHNOLOGY LICENSED BY EACH PARTY TO THE OTHER PARTY PURSUANT TO THIS AGREEMENT IS FURNISHED “AS IS”, WITH

I-7

ALL FAULTS AND WITHOUT WARRANTY OF ANY KIND, EXPRESS, IMPLIED, STATUTORY OR OTHERWISE, INCLUDING, WITHOUT LIMITATION, ANY WARRANTY OF MERCHANTABILITY, FITNESS FOR ANY PARTICULAR PURPOSE, TITLE, NON-INFRINGEMENT, QUALITY, USEFULNESS, COMMERCIAL UTILITY, ADEQUACY, COMPLIANCE WITH ANY LAW, DOMESTIC OR FOREIGN AND IMPLIED WARRANTIES ARISING FROM COURSE OF DEALING OR COURSE OF PERFORMANCE.

**Section 5.03. Assumption of Risk.**

(a) Except as provided in Section 15.1(f) of the Agreement or any PSA entered into after the Execution Date, CUSTOMER, on behalf of itself and its Affiliates, hereby assumes all risk and liability in connection with their use of the PROVIDER Licensed Technology.

(b) Except as provided in Section 12.2 of the Agreement or any PSA executed after the Execution Date, PROVIDER, on behalf of itself and its Affiliates, hereby assumes all risk and liability in connection with their use of the CUSTOMER Licensed Technology.

**Section 5.04. Amendment by PSA.** The parties may agree in any PSA to amend the terms and conditions of the licenses granted under this Exhibit I.

I-8

**Schedule I-1**

**Restricted Intellectual Property**

	<b>Name of Restricted Intellectual Property Innovation</b>	<b>US Business alignment and COE</b>	<b>Brief Notes</b>
1	Migration Toolkit	GECIS	
2	Multi Collinearity Macro	GEFA - ACOE	Macro uses advanced features of SAS. This basically performs the data diagnostics before the modeling process begins.
3	Reconciliation Reporting tool	GEFA -FCOE	Used across GECIS Finance processes - has the capability to capture information at item level (open items for purpose of reconciliation).

**EXHIBIT J**

**Business Associate Addendum**

**I. Purpose.**

In order to disclose certain information to PROVIDER under this Addendum, some of which may constitute Protected Health Information (“PHI”) (defined below), CUSTOMER and PROVIDER mutually agree to comply with the terms of this Addendum for the purpose of satisfying the requirements of the Health Insurance Portability and Accountability Act of 1996 (“HIPAA”) and its implementing privacy regulations at 45 C.F.R. Parts 160-164 (“HIPAA Privacy Rule”). These provisions shall apply to PROVIDER to the extent that PROVIDER is considered a “Business Associate” under the HIPAA Privacy Rule and all references in this section to Business Associates shall refer to PROVIDER. Capitalized terms not otherwise defined herein shall have the meaning assigned in the Agreement. Notwithstanding anything else to the contrary in the Agreement, in the event of a conflict between this Addendum and the Agreement, the terms of this Addendum shall prevail.

**II. Permitted Uses and Disclosures.**

A. Business Associate agrees to use or disclose Protected Health Information (“PHI”) that it creates for or receives from CUSTOMER or any other member of the Genworth Group only as follows. The capitalized term “Protected Health Information or PHI” has the meaning set forth in 45 C.F.R. Section 164.501, as amended from time to time. Generally, this term means individually identifiable health information including, without limitation, all information, data and materials, including without limitation, demographic, medical and financial information, that relates to the past, present, or future physical or mental health or condition of an individual; the provision of health care to an individual; or the past present, or future payment for the provision of health care to an individual; and that identifies the individual or with respect to which there is a reasonable basis to believe the information can be used to identify the individual. This definition shall include any demographic information concerning members and participants in, and applicants for, health benefit plans of the Genworth Group. All other terms used in this Addendum shall have the meanings set forth in the applicable definitions under the HIPAA Privacy Rule.

B. Functions and Activities on Company’s Behalf. Business Associate is permitted to use and disclose PHI it creates for or receives from the Genworth Group only for the purposes described in this Addendum or the Agreement that are not inconsistent with the provisions of this Addendum, or as required by law, or following receipt of prior written approval from members of the Genworth Group for which the relevant PHI was created or from which the relevant PHI was received. In addition to these specific requirements below, Business Associate may use or disclose PHI only in a manner that would not violate the HIPAA Privacy Rule if done by the applicable members of the Genworth Group.

C. Business Associate’s Operations. Business Associate is permitted by this Agreement to use PHI it creates for or receives from the Genworth Group: (i) if such use is

reasonably necessary for Business Associate’s proper management and administration; and (ii) as reasonably necessary to carry out Business Associate’s legal responsibilities. Business Associate is permitted to disclose PHI it creates for or receives from the Genworth Group for the purposes identified in this Section only if the following conditions are met:

- (1) The disclosure is required by law; or



(2) The disclosure is reasonably necessary to Business Associate's proper management and administration, and Business Associate obtains reasonable assurances in writing from any person or organization to which Business Associate will disclose such PHI that the person or organization will:

- a. Hold such PHI as confidential and use or further disclose it only for the purpose for which Business Associate disclosed it to the person or organization or as required by law; and
- b. Notify Business Associate (who will in turn promptly notify the members of the Genworth Group for which the relevant PHI was created or from which the relevant PHI was received) of any instance of which the person or organization becomes aware in which the confidentiality of such PHI was breached.

D. **Minimum Necessary Standard.** In performing the functions and activities on behalf of the Genworth Group pursuant to the Agreement, Business Associate agrees to use, disclose or request only the minimum necessary PHI to accomplish the purpose of the use, disclosure or request. Business Associate must have in place policies and procedures that limit the PHI disclosed to meet this minimum necessary standard.

E. **Prohibition on Unauthorized Use or Disclosure.** Business Associate will neither use nor disclose PHI it creates or receives for or from the Genworth Group, or from another business associate of the Genworth Group, except as permitted or required by this Addendum or the Agreement that are not inconsistent with the provisions of this Addendum, or as required by law, or following receipt of prior written approval from members of the Genworth Group for which the relevant PHI was created or from which the relevant PHI was received.

F. **De-identification of Information.** Business Associate agrees neither to de-identify PHI it creates for or receives from the Genworth Group or from another business associate of the Genworth Group, nor use or disclose such de-identified PHI, unless such de-identification is expressly permitted under the terms and conditions of this Addendum or the Agreement and related to the Genworth Group's activities for purposes of "treatment", "payment" or "health care operations", as those terms are defined under the HIPAA Privacy Rule. De-identification of PHI, other than as expressly permitted under the terms and conditions of the Addendum for Business Associate to perform services for the Genworth Group, is not a permitted use of PHI under this Addendum. Business Associate further agrees that it will not create a "Limited Data Set" as defined by the HIPAA Privacy Rule using PHI it creates or receives, or receives from another business associate of the Genworth Group, nor use or disclose such Limited Data Set unless: (i) such creation, use or disclosure is expressly permitted under the terms and conditions

J-2

---

of this Addendum or the Agreement that are not inconsistent with the provisions of this Addendum; and such creation, use or disclosure is for services provided by Business Associate that relate to the Genworth Group's activities for purposes of "treatment", "payment" or "health care operations", as those terms are defined under the HIPAA Privacy Rule.

G. **Information Safeguards.** Business Associate will develop, document, implement, maintain and use appropriate administrative, technical and physical safeguards to preserve the integrity and confidentiality of and to prevent non-permitted use or disclosure of PHI created for or received from the Genworth Group. These safeguards must be appropriate to the size and complexity of Business Associate's operations and the nature and scope of its activities. Business Associate agrees that these safeguards will meet any applicable requirements set forth by the U.S. Department of Health and Human Services, including (as of the effective date or as of the compliance date, whichever is applicable) any requirements set forth in the final HIPAA security regulations. Business Associate agrees to mitigate, to the extent practicable, any harmful effect that is known to Business Associate resulting from a use or disclosure of PHI by Business Associate in violation of the requirements of this Addendum.

III. **Conducting Standard Transactions.** In the course of performing services for the Genworth Group, to the extent that Business Associate will conduct Standard Transactions for or on behalf of the Genworth Group, Business Associate will comply, and will require any subcontractor or agent involved with the conduct of such Standard Transactions to comply, with each applicable requirement of 45 C.F.R. Part 162. "Standard Transaction(s)" shall mean a transaction that complies with the standards set forth at 45 C.F.R. parts 160 and 162. Further, Business Associate will not enter into, or permit its subcontractors or agents to enter into, any trading partner agreement in connection with the conduct of Standard Transactions for or on behalf of the Genworth Group that:

- a. Changes the definition, data condition, or use of a data element or segment in a Standard Transaction;
- b. Adds any data element or segment to the maximum defined data set;
- c. Uses any code or data element that is marked "not used" in the Standard Transaction's implementation specification or is not in the Standard Transaction's implementation specification; or
- d. Changes the meaning or intent of the Standard Transaction's implementation specification.

IV. **Sub-Contractors, Agents or Other Representatives.** Business Associate will require any of its subcontractors, agents or other representatives to which Business Associate is permitted by this Addendum or the Agreement (or is otherwise given by the applicable member of the Genworth Group's prior written approval) to disclose any of the PHI Business Associate creates or receives for or from the Genworth Group, to provide reasonable assurances in writing that subcontractor or agent will comply with the same restrictions and conditions that apply to the Business Associate under the terms and conditions of this Addendum with respect to such PHI.

J-3

---

IV **Protected Health Information Access, Amendment and Disclosure Accounting.**

A. **Access.** Business Associate will promptly upon the request of a member of the Genworth Group make available to such member, or, such members, or, at the direction of the applicable member of the Genworth Group, to the individual (or the individual's personal representative) for inspection and obtaining copies any PHI about the individual which Business Associate created for or received from the Genworth Group and that is in Business Associate's custody or control, so that the Genworth Group may meet its access obligations under 45 Code of Federal Regulations § 164.524.

B. **Amendment.** Upon the request of a member of the Genworth Group, Business Associate will promptly amend or permit such member access to amend any portion of the PHI which Business Associate created for or received from such member of the Genworth Group, and incorporate any amendments to such PHI, so that the members of the Genworth Group may meet their amendment obligations under 45 Code of Federal Regulations § 164.526.

C. **Disclosure Accounting.** So that the members of the Genworth Group may meet their disclosure accounting obligations under 45 Code of Federal Regulations § 164.528:

1. **Disclosure Tracking.** Business Associate will record for each disclosure, not excepted from disclosure accounting under Section V.C.2 below, that Business Associate makes to the Genworth Group of PHI that Business Associate creates for or receives from the Genworth Group, (i) the disclosure date, (ii) the name and member or other policy identification number of the person about whom the disclosure is made, (iii) the name and (if known) address of the person or entity to whom Business Associate made the disclosure, (iv) a brief description of the PHI disclosed, and (v) a brief statement of the purpose of the disclosure (items i-v, collectively, the

“disclosure information”). For repetitive disclosures Business Associate makes to the same person or entity (including the Genworth Group) for a single purpose, Business Associate may provide a) the disclosure information for the first of these repetitive disclosures, (b) the frequency, periodicity or number of these repetitive disclosures and (c) the date of the last of these repetitive disclosures. Business Associate will make this disclosure information available to the Genworth Group promptly upon the Genworth Group’s request.

2. **Exceptions from Disclosure Tracking.** Business Associate need not record disclosure information or otherwise account for disclosures of PHI that this Addendum or the applicable member of the Genworth Group in writing permits or requires (i) for the purpose of treatment activities of the Genworth Group’s payment activities, or health care operations, (ii) to the individual who is the subject of the PHI disclosed or to that individual’s personal representative; (iii) to persons involved in that individual’s health care or payment for health care; (iv) for notification for disaster relief purposes, (v) for national security or intelligence purposes, (vi) to law enforcement officials or correctional institutions regarding inmates; or (vii) pursuant to an authorization; (viii) for disclosures of certain PHI made as part of a Limited Data Set; (ix) for certain incidental disclosures that may occur where reasonable safeguards have been implemented; and (x) for disclosures prior to April 14, 2003.

J-4

---

3. **Disclosure Tracking Time Periods.** Business Associate must have available for the Genworth Group the disclosure information required by this section for the 6 years preceding their request for the disclosure information (except Business Associate need have no disclosure information for disclosures occurring before April 14, 2003).

VI. Additional Business Associate Provisions.

A. **Reporting of Breach of Privacy Obligations.** Business Associate will provide written notice to the members of the Genworth Group for which the relevant PHI was created or from which the relevant PHI was received of any use or disclosure of PHI that is neither permitted by this Addendum nor given prior written approval by the applicable member of the Genworth Group promptly after Business Associate learns of such non-permitted use or disclosure. Business Associate’s report will at least:

- (i) Identify the nature of the non-permitted use or disclosure;
- (ii) Identify the PHI used or disclosed;
- (iii) Identify who made the non-permitted use or received the non-permitted disclosure;
- (iv) Identify what corrective action Business Associate took or will take to prevent further non-permitted uses or disclosures;
- (v) Identify what Business Associate did or will do to mitigate any deleterious effect of the non-permitted use or disclosure; and
- (vi) Provide such other information, including a written report, as the applicable member of the Genworth Group may reasonably request.

B. **Amendment.** Upon the effective date of any final regulation or amendment to final regulations promulgated by the U.S. Department of Health and Human Services with respect to PHI, including, but not limited to the HIPAA privacy and security regulations, this Addendum and the Agreement will automatically be amended so that the obligations they impose on Business Associate remain in compliance with these regulations.

In addition, to the extent that new state or federal law requires changes to Business Associate’s obligations under this Addendum, this Addendum shall automatically be amended to include such additional obligations, upon notice by any member of the Genworth Group to Business Associate of such obligations. Business Associate’s continued performance of services under the Agreement shall be deemed acceptance of these additional obligations.

C. **Audit and Review of Policies and Procedures.** Business Associate agrees to provide, upon request by any member of the Genworth Group, access to and copies of any policies and procedures developed or utilized by Business Associate regarding the protection of PHI. Business Associate agrees to provide, upon such request, access to Business Associate’s internal practices, books, and records, as they relate to Business Associate’s services, duties and

J-5

---

obligations set forth in this Addendum and the Agreement(s) under which Business Associate provides services and / or products to or on behalf of the Genworth Group, for purposes of their review of such internal practices, books, and records.

J-6

---

**EXHIBIT K**

**Change Control Procedure**

**PURPOSE:** Establish an efficient and effective means to control updates, modifications and other changes to the Agreement, including, without limitation, the scope of the Services, Dedicated FTEs, Performance Standards, Charges, Exhibits, Schedules and PSAs.

**PROCESS:** Consistent with the Agreement, the following process shall be followed to originate, process and maintain control over Change Order Requests and Change Orders under the Agreement.

A. Either PROVIDER or CUSTOMER may identify and submit for consideration a proposed change to the Agreement.

B. All requests for changes shall be submitted in writing to the Account Executives designated by PROVIDER and CUSTOMER. The following areas should be clearly addressed in each Change Order Request:

1. Origination;
2. Clear statement of requested change;
3. Rationale for change;
4. Impact of requested change in terms of operations, cost, schedule and compliance with the matters referred to in Section 19.0 of this Agreement;
5. Effect of change if accepted;

6. Effect of rejection of change;
7. Recommended level of priority;
8. Date final action is required; and
9. Areas for signature by the approval authorities of each party.

C. The Account Executives shall review all Change Order Requests, determine whether to recommend the Change Order Request be accepted or rejected by the parties and forward the Change Order Request, their individual recommendations and the basis for their recommendations to PROVIDER and CUSTOMER for a final decision.

D. The Account Executives will be responsible for the final approval of all Change Order Requests.

E. The Account Executives will be responsible for the implementation of all Change Orders approved pursuant to Change Order Requests, including the coordination of the preparation and execution by the parties of addendums to the Agreement and/or its associated Exhibits to incorporate each requested and agreed change into the Agreement, as applicable.

F. No Change Order or change shall be effective or binding upon the parties to the Agreement until an addendum to the Agreement and/or its associated Exhibits, as applicable, incorporating such change into the Agreement and/or its associated Exhibits has been executed by PROVIDER and CUSTOMER.

G. Requests for changes shall use the format provided below:

K-2

### CHANGE ORDER REQUEST FORM

**CHANGE ORDER REQUEST NUMBER:**

**ORIGINATOR:**

**REQUESTED CHANGE:**

**RATIONALE FOR CHANGE:**

**EFFECT OF CHANGE ACCEPTANCE:**

**IMPACT OF CHANGE REJECTION:**

**PRIORITY:**

**DATE FINAL ACTION ON CHANGE ORDER IS REQUIRED:**

**DISPOSITION OF REQUEST:**

**CHANGE ORDER NUMBER:**

[Note: Attach any documents, comments or notes that explain, describe or otherwise support the Change Order Request.]

**APPROVED**  
**REJECTED**  
**REJECTED WITH COMMENT**

**APPROVED**  
**REJECTED**  
**REJECTED WITH COMMENT**

Approved as of:

\_\_\_\_\_  
 CUSTOMER Account Executive

\_\_\_\_\_  
 PROVIDER Account Executive

### EXHIBIT L

#### PSAs and Base Costs

Original MOA: Master Outsourcing Agreement between General Electric Capital Assurance Company and GE Capital International Services dated July 11, 2000.

The following PSAs are governed by this Agreement:

PSA PPC ID No.	PSA & Amendments Index No.	Y(0) Base Cost per FTE (2003)	FTE Rates Y(0) Baseline Charges per FTE (2003)	New Charges per FTE for Initial Contract Year (2004)
GECA-1272-01	J-23	**	**	**
GECA-1734-01	PSA: J33, J33.1, DOS: J-49	**	**	**
GECA-1737-01	PSA: J33, J33.1, DOS: J-49	**	**	**
GECA-1738-01	PSA: J33, J33.1, DOS: J-49	**	**	**

GECA-1745-01	J-4, J-4.1, J-4.2, J-4.3, J-4.4, J-4.5, J-5.1, J-6.1	**	**	**
GECA-1746-01	J-4, J-4.1, J-4.2, J-4.3, J-4.4, J-4.5, J-5.1, J-6.1	**	**	**
GECA-1753-01	J-24, amendment not uploaded on the site	**	**	**
GECA-1753-02	J-24, amendment not uploaded on the site	**	**	**
GECA-1754-01	J-22	**	**	**
GECA-1754-02	J-22	**	**	**
GECA-1762-01	J-4, J-4.1, J-4.2, J-4.3, J-4.4, J-4.5, J-5.1, J-6.1	**	**	**
GECA-1762-02	J-4, J-4.1, J-4.2, J-4.3, J-4.4, J-4.5, J-5.1, J-6.1	**	**	**
GECA-1763-01	J-4, J-4.1, J-4.2, J-4.3, J-4.4, J-4.5, J-5.1, J-6.1	**	**	**
GECA-1763-02	J-4, J-4.1, J-4.2, J-4.3, J-4.4, J-4.5, J-5.1, J-6.1	**	**	**

GECA-1963-01	PSA: J33, J33.1, DOS: J-49	**	**	**
GECA-1967-01	PSA: J33, J33.1, DOS: J-49	**	**	**
GECA-1967-90	PSA: J33, J33.1, DOS: J-49	**	**	**
GECA-1969-01	J-21, J-46, J46.2, J46.3	**	**	**
GECA-1975-01	J-20, J-20.1, J-20.2	**	**	**
GECA-1977-90	J-11	**	**	**
GECA-1981-01	J-14	**	**	**
GECA-1981-02	J-14	**	**	**
GECA-1985-01	J-11, J-11.1, J-11.2, J-11.3	**	**	**
GECA-1987-01	J-23	**	**	**
GECA-1994-01	J-4, J-4.1, J-4.2, J-4.3, J-4.4, J-4.5, J-5.1, J-6.1	**	**	**
GECA-1995-01	J-4, J-4.1, J-4.2, J-4.3, J-4.4, J-4.5, J-5.1, J-6.1	**	**	**
GECA-2182-01	PSA: J33, J33.1, DOS: J-49	**	**	**
GECA-2246-01	PSA: J33, J33.1, DOS: J-49	**	**	**
GECA-2306-01	PSA: J33, J33.1, DOS: J-49	**	**	**
GECA-2491-01	PSA: J33, J33.1, DOS: J-49	**	**	**
GECA-2764-01	J-11, J-11.1, J-11.2, J-11.3	**	**	**
GECA-2827-01	J-4, J-4.1, J-4.2, J-4.3, J-4.4, J-4.5, J-5.1, J-6.1	**	**	**
GECA-2924-01	PSA: J33, J33.1, DOS: J-49	**	**	**
GECA-2999-01	J-19	**	**	**
GECA-3066-01	J-24, amendment not uploaded on the site	**	**	**
GECA-3067-01	J-4, J-4.1, J-4.2, J-4.3, J-4.4, J-4.5, J-5.1, J-6.1	**	**	**
GECA-3145-01	J-22	**	**	**
GECA-3110601	J-27, J-27.1, J-27.2	**	**	**
GECA-3110801	J-27, J-27.1, J-27.2	**	**	**
GECA-3111101	J-27, J-27.1, J-27.2	**	**	**
GECA-3111301	J-27, J-27.1, J-27.2	**	**	**
GECA-3111501	J-27, J-27.1, J-27.2	**	**	**
GECA-3111701	J-27, J-27.1, J-27.2	**	**	**
GECA-3112701	J-27, J-27.1, J-27.2	**	**	**

GECA-3112801	J-27, J-27.1, J-27.2	**	**	**
GECA-3115199	J-27, J-27.1, J-27.2	**	**	**
GECA-3116401	J-27, J-27.1, J-27.2	**	**	**
GECA-3296001	J-27, J-27.1, J-27.2	**	**	**
GECA — 1962-01	PSA: J33, J33.1, DOS: J-49	**	**	**
GECA-1960-01	PSA: J33, J33.1, DOS: J-49	**	**	**
GECA-1959-01	PSA: J33, J33.1, DOS: J-49	**	**	**
GECA-1964-01	PSA: J33, J33.1, DOS: J-49	**	**	**
GECA-1244-01	J-24	**	**	**
GECA-1963 — 01	PSA: J33, J33.1, DOS: J-49	**	**	**
GECA — 1959 — 90	PSA: J33, J33.1, DOS: J-49	**	**	**
GECA — 1737 — 01	PSA: J33, J33.1, DOS: J-49	**	**	**
GECA-1152-99	PSA: J46	**	**	**

IN THE HIGH COURT OF JUSTICE  
 CHANCERY DIVISION  
 COMPANIES COURT

IN THE MATTER of Financial Assurance Company Limited

- and -

IN THE MATTER of Financial New Life Company Limited

- and -

IN THE MATTER of the Financial Services and Markets Act 2000

SCHEME

for the transfer to Financial New Life Company Limited of  
 the insurance business of Financial Assurance Company Limited  
 (pursuant to Part VII of the Financial Services and Markets Act 2000)

Slaughter and May  
 One Bunhill Row  
 London EC1Y 8YY  
 (GWJ/RJZS)  
 CA032700001

1. DEFINITIONS AND INTERPRETATION

1.1 In this Scheme:

“Act”	means the Financial Services and Markets Act 2000;
“Admissible Value”	means the value determined in accordance with Chapter 4 of IPRU (INS);
“associated company”	means any subsidiary or holding company of a party or any other subsidiary of a holding company of a party (“ <b>subsidiary</b> ” and “ <b>holding company</b> ” have the meanings given to them respectively in Sections 736 and 736A of the Companies Act 1985);
“Bond Portfolio”	means the products known as the guaranteed equity bonds, the guaranteed bonds, the flexible term guaranteed bonds, the investment bonds, the flexible access bonds and the structured settlements, issued by FACL to certain policyholders in the United Kingdom and under which any liability of FACL (whether that liability is current or future, certain or contingent) remains unsatisfied or outstanding on the Transfer Date;
“CIGL”	means Consolidated Insurance Group Limited, a company incorporated in England and Wales with registered number 1870149 and whose registered office is at Vantage West, Great West Road, Brentford, Middlesex, TW8 9AG;
“CIGL Shareholding”	means all of the rights of FACL in those shares in the issued share capital of CIGL that are owned by FACL as at the Transfer Date;
“Court”	means the High Court of Justice in England;
“EEA State”	has the meaning given to that phrase in paragraph 8 of Schedule 3 of the Act;
“Encumbrance”	means any mortgage, charge, pledge, assignation in security, lien, option, restriction, right of first refusal, right of pre-emption, third party right or interest, any other encumbrance or security interest of any kind and any other type of preferential arrangement (including, without limitation, title transfer and retention agreements) having a similar effect;
“FACL”	means Financial Assurance Company Limited, a company incorporated in England and Wales with registered number 1044679 and whose registered office is at Vantage West, Great West Road, Brentford, Middlesex, TW8 9AG;

“ <b>FACL Capital Amount</b> ”	means, if there are any Retained Insurances, the amount of the Minimum Guarantee Fund required for FACL and such further amount as FACL’s Actuary shall determine is required under the provisions of IPRU (INS) to satisfy any capital or solvency requirements that FACL may have in respect of any Retained Insurances, provided that the FACL Capital Amount shall from time to time reduce by such amount as FACL’s Actuary shall determine will leave FACL with such amount as is necessary under such provisions to satisfy such capital or solvency requirements having regard to any Retained Insurances that are transferred to FINCL or are otherwise discharged;
“ <b>FACL’s Actuary</b> ”	means the individual responsible for providing actuarial advice to the board of directors of FACL at the relevant time;
“ <b>FACL Long-Term Insurance Fund</b> ”	means the fund maintained by FACL pursuant to rule 3.1 of IPRU (INS);
“ <b>FACL Shareholder Fund</b> ”	means the fund maintained by FACL which is not part of the FACL Long-Term Insurance Fund;
“ <b>FINCL</b> ”	means Financial New Life Company Limited, a company incorporated in England and Wales with registered number 4873014 and whose registered office is at Vantage West, Great West Road, Brentford, Middlesex TW8 9AG;
“ <b>FINCL Long-Term Insurance Fund</b> ”	means the fund maintained by FINCL pursuant to rule 3.1 of IPRU (INS);
“ <b>FINCL Shareholder Fund</b> ”	means the fund maintained by FINCL which is not part of the FINCL Long-Term Insurance Fund;
“ <b>FINCL’s Actuary</b> ”	means the individual responsible for providing actuarial advice to the board of directors of FINCL at the relevant time;
“ <b>FSA</b> ”	means the Financial Services Authority of the United Kingdom;
“ <b>GMT</b> ”	means Greenwich Mean Time;
“ <b>Goodwill</b> ”	means the goodwill of the Transferring Business;

---

“ <b>Independent Expert</b> ”	means Michael Arnold of Milliman UK who has been approved by the FSA to make the scheme report required by section 109 of the Act;
“ <b>Insurances</b> ”	<p>means, in respect of every contract of insurance or reinsurance under which the whole or any part of the insurance or reinsurance risk in respect of that contract is written by FACL and which is in force at the Transfer Date or under which any liability in respect of the whole or, as the case may be, such part of the insurance or reinsurance risk written by FACL (whether current or future, certain or contingent) remains unsatisfied or outstanding at the Transfer Date, the whole or, as the case may be, such part of the insurance or reinsurance risk under that contract of insurance or reinsurance which is assumed by FACL, together with all liabilities for which FACL is responsible under or by virtue of such contract, and includes (without limitation):</p> <p>(a) the whole or, as the case may be, such part of the insurance or reinsurance risk which FACL would have assumed, together with all liabilities for which FACL would have been liable as a result, under all proposals for insurance or reinsurance received or issued by or on behalf of FACL before the Transfer Date and which have not at the Transfer Date been accepted but which FINCL, on FACL’s behalf, subsequently accepts and which, but for the provisions of the Scheme, FACL would have been able to accept or, as applicable, that FACL would have been bound by the provisions thereof;</p> <p>(b) all obligations of FACL in respect of any third party rights to reinstatement of any contract of insurance or reinsurance under which the whole or, as the case may be, the relevant part of the insurance or reinsurance risk in respect of that contract is written by FACL; and</p>

---

	<p>(c) all liability of FACL for damages (including compensatory, consequential, exemplary, punitive, bad faith or similar or other damages) which relate to the marketing, sale, underwriting, issuance, delivery, cancellation or administration of such contract of insurance or reinsurance, including liability arising out of or relating to any alleged or actual act, error or omission by FACL or its agents, whether intentional or otherwise, with respect to any of such contracts, including (a) any alleged or actual reckless conduct or bad faith in connection with the handling of any claim arising out of or under such contract, or (b) the marketing, sale, underwriting, issuance, delivery, cancellation or administration of such contract,</p> <p>each such contract, proposal, right (including all amendments and other modifications thereto) and liability being an “<b>Insurance</b>”;</p>
“ <b>IPRU (INS)</b> ”	means the Interim Prudential Sourcebook for Insurers issued by the FSA;
“ <b>liabilities</b> ”	means all liabilities, obligations and duties whatsoever (whether present or future, actual or contingent), including, without limitation, any cost, expenses, liability, damage or loss of any kind;
“ <b>Mathematical Reserves</b> ”	has the meaning given to that phrase in IPRU (INS);
“ <b>Minimum Guarantee Fund</b> ”	has the meaning given to that phrase in rule 2.9 of IPRU (INS);
“ <b>Order</b> ”	means the order of the Court sanctioning the Scheme pursuant to Section 111(1) of the Act and any order of the Court making provision under Section 112 of the Act;

**“property”**

means (without limitation) property assets, rights and powers of every description (whether present or future, actual or contingent) and includes property held on trust and any interest in any of the foregoing and, for the avoidance of doubt, real and heritable property, moveable and personal property and any interest proprietor, landlord, tenant, mortgagee, chargee or heritable creditor;

4

---

**“Reinsurance Contracts”**

means all of FACL’s rights, obligations and liabilities under all reinsurance contracts or treaties subsisting at the Transfer Date entered into by FACL pursuant to which FACL reinsures any of its risk or liabilities to another party, to the extent such rights, obligations and liabilities relate to the reinsurance of FACL’s risk or liabilities arising under or in respect of the Transferring Business, and includes, without prejudice to the generality of the foregoing and for the avoidance of doubt, the Viking Reinsurance;

**“Residual Assets”**

means:

- (a) any property of FACL in respect of which an impediment exists such that the Court cannot, or declines to, sanction the transfer of that property by way of the Order;
- (b) any other interest of FACL in any property which FACL and FINCL determine prior to the Transfer Date is more conveniently to be transferred pursuant to this Scheme at a date other than the Transfer Date;
- (c) any rights, proceeds of sale, income or other accrual or return, whether or not in any case in the form of cash, from time to time after the Transfer Date received by FACL in respect of, or earned on, any such property as is referred to in (a), (b) or (d) of this definition; and
- (d) any sum which FACL’s Actuary may determine be transferred to FINCL by way of a reduction in the FACL Capital Amount after the Transfer Date;

**“Residual Liability”**

means any liability whatsoever (whether present or future, actual or contingent) of FACL (other than under a Retained Insurance):

- (a) which is attributable to, or connected with, a Residual Asset and arises at any time before the Subsequent Transfer Date applicable to that Residual Asset; or
- (b) which is not, or is not capable of being, transferred by this Scheme or by the Order;

5

---

**“Retained Insurances”**

means any Insurance in respect of which:

- (a)
  - (i) the establishment of FACL which has written that Insurance is in an EEA State other than the United Kingdom; and
  - (ii) the FSA has not prior to the making of the Order provided the certificate referred to in paragraph 3 of Part 1 of Schedule 12 to the Act; or
- (b)
  - (i) an EEA State other than the United Kingdom is the State of the commitment; and
  - (ii) the FSA has not prior to the making of the Order provided the certificate referred to in paragraph 4 of Part 1 of Schedule 12 to the Act; or
- (c) the transfer of such Insurance would contravene the legal or regulatory requirements to which FACL is subject in any state which is not an EEA State,

and for these purposes **“State of the commitment”** shall have the meaning given in paragraph 6(1) of Part 1 of Schedule 12 of the Act;

**“Scheme”**

means this Scheme, including any schedules to it, in its original form or with, or subject to, any modification, addition or condition which may be approved pursuant to paragraph 21 or imposed by the Court;

**“Subsequent Transfer Date”**

means, in relation to any Residual Asset or Residual Liability, the date (after the Transfer Date) on which that Residual Asset or Residual Liability is or is to be transferred to FINCL, namely:

- (a) in respect of any Residual Asset falling within paragraph (a) of the definition thereof and of any Residual Liability which is attributable to, or connected with, that Residual Asset, the date on which the relevant impediment to the transfer of such Residual Asset or Residual Liability no longer exists;

6

---

- (b) in respect of any Residual Asset falling within (b) of the definition thereof and of any Residual Liability which is attributable to, or connected with, that Residual Asset, the Subsequent Transfer Date shall be the date on which FACL and FINCL mutually agree that the interest is to be transferred;
- (c) in the case of any Residual Asset falling within paragraph (c) of the definition thereof, the date on which such Residual Asset is received or earned by FACL, provided that where such Residual Asset is subject to an impediment on transfer which falls within paragraph (a) of the definition of Residual Asset, the Subsequent Transfer Date shall then be the date on which the relevant impediment no longer exists;

- (d) in the case of any Residual Asset falling within paragraph (d) of the definition thereof, the Subsequent Transfer Date shall be the date on which the determination is made by FACL's Actuary to release the relevant sum from the FACL Capital Amount; and
- (e) in the case of a Residual Liability falling within paragraph (a) of the definition thereof, provided that it can be so transferred on that date, the Subsequent Transfer Date for the relevant Residual Asset or, if it cannot be transferred on that date, as promptly as practicable thereafter;

**"Taxes Act"** means the Income and Corporation Taxes Act 1988;

**"Transfer Date"** means the date and time as determined in accordance with paragraph 20.1;

**"Transferring Assets"** means all of the property of FACL as at the Transfer Date (other than the Residual Assets, the FACL Capital Amount and the rights of FACL under the Retained Insurances), including, without limitation:

- (a) the rights of FACL under or by virtue of the Transferring Insurances;
- (b) all rights of FACL to all client lists in relation to the Transferring Business;

7

- (c) all rights of FACL under the Reinsurance Contracts and the Transferring Contracts;
- (d) all rights that FACL has in any investments entered into in connection with the Bond Portfolio or to which any of the products comprising the Bond Portfolio are linked in any way; and
- (e) all rights and claims (present or future, actual or contingent) against any third party in relation to the Transferring Business or arising as a result of FACL having carried on the Transferring Business,

and, for the avoidance of doubt, any rights of FACL which comprise such property shall include any rights of FACL which relate to, and arose during, any period prior to the Transfer Date;

**"Transferring Business"** means the whole of the business of FACL carried on as at the Transfer Date (including effecting or carrying out the Transferring Insurances, all activities carried on in connection with or for the purposes of FACL's business, and any proposals for insurance not yet accepted) save to the extent that such business relates to the Retained Insurances or to the carrying on of insurance business in any jurisdiction to the extent that, if carried on prior to the Transfer Date, it would have resulted in the issue of further Retained Insurances;

**"Transferring Contracts"** means all rights, obligations and liabilities of FACL under all contracts entered into by FACL to the extent that such rights, obligations and liabilities arise in connection with or in relation to the carrying on of the Transferring Business other than any rights, obligations and liabilities under the Reinsurance Contracts;

8

**"Transferring Insurances"** means, in respect of every contract of insurance or reinsurance under which the whole or any part of the insurance or reinsurance risk in respect of that contract is written or assumed by FACL and which is in force at the Transfer Date or under which any liability in respect of the whole or, as the case may be, such part of the insurance or reinsurance risk written or assumed by FACL (whether current or future, certain or contingent) remains unsatisfied or outstanding at the Transfer Date, the whole or, as the case may be, such part of the insurance or reinsurance risk under that contract of insurance which is assumed by FACL, together with all liabilities whatsoever (whether present or future, certain or contingent) for which FACL is responsible as at the Transfer Date under or by virtue of such contract, and includes (without limitation):

- (a) the whole or, as the case may be, such part of the insurance or reinsurance risk which FACL would have assumed, together with all liabilities for which FACL would have been liable as a result, under all proposals for insurance or reinsurance received or issued by or on behalf of FACL before the Transfer Date which have not at the Transfer Date been accepted but which FINCL, on FACL's behalf, subsequently accepts and which, but for the provisions of the Scheme, FACL would have been able to accept or, as applicable, FACL would have been bound by the provisions thereof;
- (b) all obligations of FACL in respect of any third party rights to reinstatement of any contract of insurance or reinsurance under which the whole or, as the case may be, the relevant part of the insurance or reinsurance risk in respect of that contract is written by FACL; and

9

- (c) all liability of FACL for damages (including compensatory, consequential, exemplary, punitive, bad faith or similar or other damages) which relate to the marketing, sale, underwriting, issuance, delivery, cancellation or administration of such contract of insurance or reinsurance, including liability arising out of or relating to any alleged or actual act, error or omission by FACL or its agents, whether intentional or otherwise, with respect to any of such contracts, including (a) any alleged or actual reckless conduct or bad faith in connection with the handling of any claim arising out of or under such contract, or (b) the marketing, sale, underwriting, issuance, delivery, cancellation or administration of such contract,

each such contract, proposal, right (including all amendments and other modifications thereto) and liability being a **"Transferring Insurance"**.

For the avoidance of doubt, the expression "Transferring Insurances" shall exclude all of the Retained Insurances;



- “Transferring Liabilities”** means all liabilities whatsoever (whether present or future, actual or contingent) of FACL (other than to the extent discharged prior to the Transfer Date) arising in connection with or in relation to the carrying on of the Transferring Business including (for the avoidance of doubt) all obligations and liabilities of FACL under the Transferring Contracts and the Reinsurance Contracts and any liabilities or obligations of FACL which remain outstanding at the Transfer Date or may thereafter arise and relate to, or arose during, any period prior to the Transfer Date, but excluding the Residual Liabilities and liabilities under, or relating to, the Retained Insurances; and
- “Viking Reinsurance”** means the reinsurance agreement effective as of 1st January, 2004 entered into between FACL and Viking Insurance Company, Limited., of Craig Appin House, 8 Wesley Street, Hamilton, Bermuda.

1.2 In this Scheme, any reference, express or implied, to an enactment includes references to:

- (A) that enactment as re-enacted, amended, extended or applied by or under any other enactment (before or after the Transfer Date);
- (B) any enactment which that enactment re-enacts (with or without modification); and

10

- (C) any subordinate legislation made (before or after the court order issued in respect of this Scheme) under that enactment, as re-enacted, amended, extended or applied as described in paragraph (A) above, or under any enactment referred to in paragraph (B) above,

except for any such amendment, extension, application or re-enactment made after the date on which the application is made to Court by FACL and FINCL for an Order in respect of this Scheme, if and to the extent that it would (but for this provision) create or increase any liability of any party hereto, and “enactment” includes any legislation (whether primary or subordinate) in any jurisdiction.

1.3 Where any obligation is expressed to be undertaken or assumed by any person, that obligation shall be interpreted as including a requirement on that person to exercise all rights and powers of control over the affairs of any other person which that person is properly able to exercise (whether directly or indirectly) in order to secure performance of those obligations.

1.4 Words denoting persons shall include any body corporate, unincorporated association of persons, government, state or agency of a state (whether or not having separate legal personality).

1.5 The words “include”, “includes” and “including” shall be construed, as if they were followed by words “without limitation”.

1.6 In this Scheme, a reference to:

- (A) an agreement or document is to the same as amended from time to time;
- (B) a paragraph is to a paragraph of this Scheme;
- (C) a party to this Scheme includes references to the successors or assignors (immediate or otherwise) of that party;
- (D) “this Scheme” includes the schedules to this scheme;
- (E) the singular includes the plural and vice versa; and
- (F) any one gender includes the other.

1.7 Except as the context otherwise requires, words and expressions used in the Act or in any regulations or rules made under it shall have the same meanings in this Scheme.

1.8 Headings in this Scheme are inserted for convenience only and shall not affect its construction.

1.9 Paragraphs 1.2 to 1.8 above apply unless the context otherwise requires.

11

## 2. INTRODUCTION

2.1 Each of FACL and FINCL is (or, in respect of FINCL, will be by the Transfer Date) an insurance company authorised for the purposes of the Act with permission to (amongst other things) effect or carry out contracts of insurance comprising long term insurance business of the same classes as the Transferring Insurances.

2.2 It is proposed that the Transferring Insurances shall be transferred to FINCL on the Transfer Date by Order of the Court in accordance with Part VII of the Act and be dealt with in accordance with this Scheme.

2.3 FACL and FINCL shall execute all such documents and to do all such acts and things as may be necessary or expedient to be executed or done by it for the purposes of giving effect to this Scheme.

## 3. TRANSFER OF TRANSFERRING INSURANCES

3.1 Subject to the provisions of this Scheme, on and with effect from the Transfer Date, each Transferring Insurance and all the interest of FACL in it shall, by the Order and without any further act or instrument, be transferred to and vested in FINCL and dealt with in accordance with this Scheme.

3.2 The Retained Insurances shall be reinsured, administered and dealt with in accordance with this Scheme.

3.3 FINCL shall accept without investigation such title as FACL shall have at the Transfer Date to each Transferring Insurance.

3.4 Without prejudice to any other provision in this Scheme, FACL and FINCL shall each take all such steps and do all such things (including the execution and delivery of any document) as may be required to effect or perfect the transfer to and vesting in FINCL of each Transferring Insurance in accordance with the terms of this Scheme.

#### **4. TRANSFER OF TRANSFERRING BUSINESS**

- 4.1 Subject to the provisions of this Scheme, on and with effect from the Transfer Date, the Transferring Business and all of the interest of FACL in it shall, by the Order and without any further act or instrument, be transferred to and vested in FINCL and dealt with in accordance with this Scheme.
- 4.2 On and with effect from the Transfer Date, FACL shall cease effecting contracts of insurance or reinsurance in any jurisdiction (including any jurisdiction in which it shall have effected any Retained Insurances) and on and with effect from such date FINCL will be entitled to commence doing so in succession to FACL, subject to its having received the requisite regulatory licences and consents for it to be able to do so in such jurisdiction. To the extent that FACL incurs any cost or liability as a result of such discontinuation, such cost or liability shall be borne or promptly reimbursed by FINCL.

12

---

#### **5. TRANSFER OF TRANSFERRING ASSETS, TRANSFERRING CONTRACTS, REINSURANCE CONTRACTS AND RESIDUAL ASSETS**

- 5.1 Subject to the provisions of this Scheme, on and with effect from the Transfer Date, the Transferring Assets shall, by the Order and without any further act or instrument, be transferred to and vested in FINCL subject to all Encumbrances (if any) affecting those assets.
- 5.2 Subject to the provisions of this Scheme, on and with effect from the Transfer Date, the Transferring Contracts and the Reinsurance Contracts shall, by the Order and without any further act or instrument, be transferred to and vested in FINCL subject to all Encumbrances (if any) affecting them.
- 5.3 Subject to [paragraph 16.1](#), on and with effect from each Subsequent Transfer Date, each Residual Asset to which such Subsequent Transfer Date applies shall (subject to the terms of this Scheme), by the Order and without any further act or instrument, be transferred to and vested in FINCL subject to all Encumbrances (if any) affecting that asset.
- 5.4 FINCL shall accept without investigation such title as FACL shall have:
- (A) to the Transferring Assets at the Transfer Date; and
- (B) to the Residual Assets then transferred on each relevant Subsequent Transfer Date.
- 5.5 FACL and FINCL shall promptly execute such documents and perform such other acts as may be required to effect or perfect the transfer to and vesting in FINCL of all Transferring Assets, Transferring Contracts, Reinsurance Contracts and Residual Assets in accordance with this Scheme.

#### **6. TRANSFER OF TRANSFERRING LIABILITIES AND RESIDUAL LIABILITIES**

- 6.1 Subject to the provisions of this Scheme, on and with effect from the Transfer Date, the Transferring Liabilities shall, by the Order and without any further act or instrument, be transferred to, and become the liabilities of, FINCL, and FACL shall then be released from those liabilities.
- 6.2 On and with effect from each Subsequent Transfer Date, each Residual Liability to which such Subsequent Transfer Date applies shall (subject to the terms of this Scheme), by the Order and without any further act or instrument, be transferred to, and become a liability of, FINCL, and FACL shall then be released from that liability.
- 6.3 FACL and FINCL shall promptly execute such documents and perform such acts as may be required promptly to effect the transfer to and assumption by FINCL of all Transferring Liabilities, Residual Liabilities and Retained Insurances, once such Transferring Liabilities, Residual Liabilities and Retained Insurances become capable of being transferred.

13

---

#### **7. AVAILABILITY OF ASSETS**

Any allocation of property or attribution of liabilities, and any re-allocation or re-attribution of the same, which is made under the terms of this Scheme is for the purpose of establishing or recognising respective policyholder and shareholder entitlements from time to time and shall not be taken to limit the availability of all the property from time to time of FINCL to meet the liabilities which it is obliged by law to meet.

#### **8. ALLOCATION OF TRANSFERRING INSURANCES**

On and with effect from the Transfer Date, all of the Transferring Insurances shall be allocated to the FINCL Long-Term Insurance Fund.

#### **9. ALLOCATION OF TRANSFERRING ASSETS, CIGL SHAREHOLDING AND GOODWILL**

- 9.1 Subject to [paragraph 9.3](#), on and with effect from the Transfer Date, all of the Transferring Assets allocated to the FACL Long-Term Insurance Fund immediately prior to the Transfer Date shall be allocated to the FINCL Long-Term Insurance Fund.
- 9.2 Subject to [paragraph 9.3](#), on and with effect from the Transfer Date, all of the Transferring Assets allocated to the FACL Shareholder Fund (including the Goodwill) immediately prior to the Transfer Date shall be allocated to the FINCL Shareholder Fund.
- 9.3 On and with effect from the Transfer Date, and notwithstanding [paragraph 9.1](#), the CIGL Shareholding shall be allocated to the FINCL Shareholder Fund.
- 9.4 Where any Transferring Assets are linked to any Transferring Insurances immediately prior to the Transfer Date, those Transferring Assets shall continue to be so linked immediately after the Transfer Date.
- 9.5 On and with effect from the relevant Subsequent Transfer Date, all of the Residual Assets to which that Subsequent Transfer Date relates shall be allocated to the FINCL Long-Term Insurance Fund if they were allocated to the FACL Long-Term Insurance Fund immediately prior to such date and shall be allocated to the FINCL Shareholder Fund if they were allocated to the FACL Shareholder Fund immediately prior to that date.

#### **10. ALLOCATION OF TRANSFERRING LIABILITIES**

- 10.1 Subject to [paragraph 10.3](#), on and with effect from the Transfer Date, all of the Transferring Liabilities shall be allocated to the FINCL Long-Term Insurance Fund.
- 10.2 Subject to [paragraph 10.3](#), on and with effect from the relevant Subsequent Transfer Date, all of the Residual Liabilities to which that Subsequent Transfer Date relates shall be allocated to the FINCL Long-Term Insurance Fund.

10.3 Any Transferring Liabilities or Residual Liabilities which are, immediately prior to the Transfer Date or the relevant Subsequent Transfer Date (as the case may be), allocated to the FACL Shareholder Fund shall be allocated to the FINCL Shareholder Fund on and with effect from that Transfer Date or Subsequent Transfer Date.

## 11. TRANSFERRING INSURANCES, TRANSFERRING CONTRACTS AND REINSURANCE CONTRACTS

11.1 On and with effect from the Transfer Date, FINCL shall:

- (A) assume, succeed and become entitled to all the rights, discretions, authorities, benefits and powers of FACL whatsoever subsisting on the Transfer Date under or by virtue of each Transferring Insurance;
- (B) assume, succeed and become subject to all liabilities and obligations of FACL whatsoever subsisting on the Transfer Date under or by virtue of each Transferring Insurance, in each case as if FINCL had originally issued each such Transferring Insurance directly; and
- (C) be entitled to any and all defences, claims, counterclaims and rights of set-off under or in respect of each Transferring Insurance which would have been available to FACL.

11.2 Subject to the provisions of this Scheme, every person who is a holder of a Transferring Insurance shall, on and with effect from the Transfer Date, continue to be entitled, to the exclusion of any rights which he may have had against FACL under the Transferring Insurance concerned, to the same rights against FINCL as were available to him against FACL under that Transferring Insurance and (as regards any Transferring Insurance under which premiums or other sums attributable or referable thereto continue to be payable by him) FINCL shall, on and with effect from the Transfer Date, be entitled to any such premiums or other sums and any further or additional premiums or other sums attributable or referable thereto as and when the same became due and payable.

11.3 If any person entitled to do so with respect to a Transferring Insurance exercises any option granted under the terms of that Transferring Insurance and the option provides for a new, additional or replacement policy to be issued or amendments to be made to an existing Transferring Insurance, the obligation thereby arising shall be satisfied by the issue by FINCL of a policy that complies with the terms of such option but if FINCL is not at the time of the exercise of such option writing policies complying exactly with the policy to which the option refers, FINCL shall be entitled to offer in lieu thereof a policy offered by FINCL at such time that FINCL considers to be the nearest equivalent policy.

11.4 The transfer of any rights, benefits, liabilities and obligations under or in connection with any Reinsurance Contract, Transferring Contract, Transferring Insurance, Transferring Asset or Transferring Liability pursuant to this Scheme shall take effect and shall be valid and binding on all parties having any interest in the same notwithstanding any restriction on assigning or otherwise dealing with the same and such transfer shall be

deemed to take effect on the basis that it does not contravene any such restriction and does not give rise to any right of termination or other right which might otherwise arise in respect of such transfer.

## 12. RETAINED INSURANCES

12.1 The Retained Insurances shall not be transferred to FINCL and shall remain liabilities of FACL but shall at all times after the Transfer Date be reinsured in their entirety into FINCL in accordance with this [paragraph 12](#).

12.2 On and with effect from the Transfer Date, all the liabilities of FACL arising under or otherwise attributable to the Retained Insurances and all other amounts paid or payable by FACL in respect of or as a result of the Retained Insurances, including (without limitation) insolvency fund and similar assessments, commission payments and amounts paid or payable in relation to the surrender or termination of any Retained Insurance, shall be reinsured in their entirety into FINCL for no further consideration and in accordance with the terms of this [paragraph 12](#). FINCL shall pay when due all such liabilities and other amounts on behalf of FACL.

12.3 The premiums payable under the reinsurance arrangements described in this [paragraph 12](#) shall be:

- (A) an initial premium comprising assets with an Admissible Value equal to the Mathematical Reserves attributable to the Retained Insurances as at the Transfer Date, which premium shall pass from FACL to FINCL under the terms of this Scheme; and
- (B) all premium payments and all other amounts received by FACL (if any) in respect of Retained Insurances at any time after the Transfer Date, which amounts shall be paid by FACL to FINCL as soon as practicable after they are received by FACL.

12.4 The liability of FINCL in respect of the reinsurance arrangements described in this [paragraph 12](#) shall be calculated so as to ensure that benefits are provided to policyholders holding Retained Insurances which are no less favourable than the benefits that would have been provided to those policyholders if those Retained Insurances had been Transferring Insurances.

12.5 On and with effect from the Transfer Date, FINCL shall be responsible for all aspects of the management and the administration of the Retained Insurances. FINCL shall procure that the Retained Insurances are administered in compliance with the applicable law or regulations, in good faith and with the care, skill, prudence, and diligence of a person experienced in administering payment protection insurance business. FINCL shall not settle any dispute or litigation involving any Retained Insurance without the prior consent of FACL, which consent shall not be unreasonably withheld or delayed. For these purposes, FINCL shall be

entitled to represent itself as managing and administering the Retained Insurances as agent for FACL, and shall be entitled to represent itself in that capacity directly to the holders of Retained Insurances following the Transfer Date.

12.6 If FINCL, with the consent of FACL, procures the novation of any Retained Insurance to FINCL, the assets and liabilities relating to that Retained Insurance shall, to the extent not previously transferred, be transferred to FINCL and such Retained Insurance shall thereafter be dealt with by FINCL under the provisions of the Scheme in all respects as if that Retained Insurance were a Transferring Insurance, and the reinsurance arrangements set out in this [paragraph 12](#) shall, on and with effect from that transfer, cease to apply to that Retained Insurance (provided however that FINCL shall continue to indemnify FACL against any liability of FACL arising under or otherwise attributable to such Retained Insurances).

12.7 FACL shall retain an amount equal to the FACL Capital Amount for such time as there are any Retained Insurances. Any amount by which the FACL Capital Amount

is reduced from time to time shall be promptly transferred to FINCL and allocated to the FINCL Long-Term Insurance Fund or the FINCL Shareholder Fund (as the case may be) in accordance with the principles set out in paragraphs 9.1 and 9.2 as if the reference to "Transfer Date" in those paragraphs was a reference to the date on which such amount is to be transferred under this paragraph 12.7.

- 12.8 FINCL shall procure that accurate and complete records, files and accounts of all transactions and matters with respect to the Retained Insurances continue to be kept in accordance with the arrangements in force immediately prior to the Transfer Date with such changes as may be required from time to time by applicable law. FACL or its designated representative (or any person or entity appointed or charged with the duty to examine or investigate FACL under the applicable law or regulations) may upon reasonable notice inspect and copy (and take away such copies), at the offices where such records are located, the papers and any and all other books or documents reasonably relating to the Retained Insurances and the administration thereof during normal business hours for such period as FACL reasonably needs access to such records for regulatory, tax or similar purposes. FINCL shall procure that relevant personnel are made available for interview and meetings with any person or entity appointed or charged with the duty to examine or investigate FACL under the applicable law or regulations and furnish any additional assistance, information and documents as may be reasonably requested by FACL from time to time.
- 12.9 FACL may upon written notice to FINCL terminate the reinsurance contemplated under this paragraph 12 and recapture the Retained Insurances from FINCL (together with all related assets and liabilities) in the event of (i) the commencement of insolvency or similar proceedings with respect to FINCL or (ii) material breach by FINCL of its obligations under this paragraph 12, where such breach has not been remedied within 45 days after written notice of such breach has been received by FINCL.

### 13. VIKING REINSURANCE

For the avoidance of doubt, on and with effect from the Transfer Date, all of the rights and obligations of FACL under the Viking Reinsurance shall, by the Order and without

17

---

any further act or instrument, be transferred to and vested in FINCL and FINCL shall be able to exercise any of its rights under the terms of the Viking Reinsurance.

### 14. CONTINUITY OF PROCEEDINGS

On and with effect from the Transfer Date, any judicial, quasi-judicial, administrative or arbitration proceedings in any country which are pending by or against FACL by virtue of the Transferring Insurances, Transferring Contracts or Reinsurance Contracts or any of them shall be continued in lieu thereof by or against FINCL and FINCL shall be entitled to all defences, claims, counterclaims and rights of set-off that would have been available to FACL in relation to such proceedings. FINCL shall succeed to and assume any liability under such proceedings to which FACL would have been exposed.

### 15. MANDATES AND OTHER INSTRUCTIONS

Any mandate or other instruction in force on the Transfer Date (including, without limitation, any instruction given to a bank by its customer in the form of a direct debit or standing order) and providing for the payment by a banker or other intermediary of premiums payable under or in respect of any Transferring Insurance to FACL shall, on and with effect from the Transfer Date, take effect as if it had provided for and authorised such payment to FINCL.

### 16. DECLARATION OF TRUST BY FACL

- 16.1 If:
- (A) any property of FACL attributable to the Transferring Business is not, or is not capable of being, immediately transferred to, and vested in, FINCL on the Transfer Date by the Order by reason of:
    - (i) that property being a Residual Asset;
    - (ii) that property being outside the jurisdiction of the Court; or
    - (iii) for any other reason; or
  - (B) any Residual Asset is not, or is not capable of being, transferred to, and vested in, FINCL by the Order on the Subsequent Transfer Date applicable thereto; or
  - (C) the transfer of any property of FACL attributable to any of the Transferring Business outside the jurisdiction of the Court is not recognised by the laws of the jurisdiction in which that property is situated; or
  - (D) in any circumstances FINCL and FACL shall mutually decide before the Transfer Date (or, in the case of any Residual Asset, before the Subsequent Transfer Date applicable thereto) that it is not expedient to effect a transfer of any property of FACL to FINCL pursuant to this Scheme,

18

---

FACL shall, from the Transfer Date or from the relevant Subsequent Transfer Date, as the case may be, hold that property as trustee for FINCL absolutely and shall be subject to FINCL's directions in respect thereof until the relevant property is transferred to, or otherwise vested in, FINCL or is disposed of (whereupon FACL shall account to FINCL for the net proceeds of the disposal thereof received by FACL) and FINCL shall have irrevocable authority to act as the attorney of FACL in respect of such property for all such purposes.

- 16.2 In the event of any payment being made to, property being received by or right being conferred upon FACL after the Transfer Date in respect of the Transferring Business or any of the Transferring Assets, or after the relevant Subsequent Transfer Date in respect of any of the Residual Assets, FACL shall, as soon as is reasonably practicable after its receipt, pay the full amount of that payment or (to the extent that it is able to do so) transfer such property or right to, or in accordance with the directions of, FINCL. FINCL shall indemnify FACL on demand against any costs or liability incurred by FACL in making any such payment or transfer.

### 17. INDEMNITIES IN FAVOUR OF FACL

- 17.1 On and from the Transfer Date, FINCL shall discharge on behalf of FACL, or failing that shall indemnify FACL against, all Transferring Liabilities and Residual Liabilities and all liabilities and obligations arising under or relating to the Transferred Business or any Transferring Contracts, Transferring Insurances, Reinsurance Contracts, Retained Insurances, Residual Assets or Transferred Assets. FINCL shall also bear and indemnify FACL against all costs and expenses of performing any obligation hereunder.
- 17.2 If FACL becomes aware of any matter which might give rise to FACL's right of indemnity in paragraph 17.1, FACL and FINCL agree that the following provisions

shall apply:

- (A) FACL shall promptly give written notice to FINCL of the matter (stating in reasonable detail the nature of the matter and, so far as practicable, the amount claimed) and shall consult with FINCL with respect to the matter;
- (B) Subject to paragraph 17.2(C), FACL will not make any admission as to liability in relation to, or agree to any settlement of or compromise in respect of the matter giving rise to FACL's right of indemnity in paragraph 17.1 without the prior written consent of FINCL which shall not be unreasonably withheld or delayed;
- (C) FINCL shall be entitled to conduct negotiations and litigation or settle all litigation arising from any matter that gives rise to FACL's right of indemnity in paragraph 17.1 and, in such case, FACL will, at the request and expense of FINCL, give FINCL reasonable assistance in connection with those negotiations and litigation. FACL shall provide FINCL and its professional advisers reasonable access to its premises and personnel and to any relevant assets, documents and records within its possession or control for the purposes of investigating the matter and enabling FINCL to take such action as is referred to in this paragraph 17. FINCL shall not settle any matter calling for an admission

19

---

of wrongdoing or similar imposition on FACL without the prior consent of FACL, which consent shall not be unreasonably withheld or delayed; and

- (D) FINCL shall be entitled to take copies of any of the documents or records and photograph any premises or assets, referred to in paragraph 17.2(C) above.

17.3 Where FACL is entitled to receive an amount pursuant to the indemnity contained in paragraph 17.1 it shall be entitled to receive such amount as, after payment of any liability to taxation in respect of the amount receivable, will result in the receipt of an amount equal to the liability indemnified against.

## 18. CONSTRUCTION OF TRANSFERRING INSURANCES

18.1 All references in any Transferring Insurance to FACL (in its capacity as issuer of such Transferring Insurance), its directors, its board of directors, FACL's Actuary or any of its other officers or employees shall be read as references to FINCL, its directors, its board of directors, FINCL's Actuary or other officers or employees of FINCL (as the case may be) from and after the Transfer Date.

18.2 All rights and/or duties exercisable or expressed to be exercisable or responsibilities to be performed by FACL, its directors or board of directors, FACL's Actuary or any other officers or employees of FACL in relation to any of the Transferring Insurances shall be exercisable or required to be performed by, respectively, FINCL, its directors, its board of directors, FINCL's Actuary or other officers or employees of FINCL (as the case may be) from and after the Transfer Date.

18.3 All references in any Transferring Insurance to FACL shall be read and construed, from and after the Transfer Date, as references to FINCL. All references in any Transferring Insurance to the group of companies of which FACL is or has been a member shall be read and construed, from and after the Transfer Date, as references to the group of companies of which FINCL is from time to time a member. All references in any Transferring Insurance to associated companies of FACL shall be read and construed from and after the Transfer Date as references to associated companies of FINCL.

18.4 Where the benefits of any Transferring Insurance are held under the terms of a trust, such terms shall operate and be construed on and from the relevant Transfer Date on a basis which is consistent with the transfer of such Transferring Insurance in accordance with the provisions of this Scheme. For the avoidance of doubt:

- (A) where the consent of FACL is required under any such terms, the consent of FINCL shall, on and with effect from the Transfer Date, instead be treated as required; and
- (B) where a power to appoint trustees under such terms is conferred on FACL, that power shall, on and with effect from the Transfer Date, instead be treated as conferred on FINCL.

20

---

## 19. ADMINISTRATION

On and with effect from the Transfer Date, FINCL shall, as principal, take over from FACL the administration and negotiation of proposals for insurance which would not have been Transferring Insurances had FACL determined to accept them (but whether or not FINCL does so determine) and FINCL shall bear all expenses and liabilities in relation thereto but nothing contained herein shall oblige FINCL to accept any proposal for insurance received by or on behalf of FACL before the Transfer Date but not accepted by FACL by that date.

## 20. TRANSFER DATE

20.1 Subject to paragraphs 20.2, 20.3 and 20.4 below, the Scheme shall become effective in relation to the Transferring Business and each Transferring Insurance, Transferring Asset and Transferring Liability at the time and on the date which the respective boards of FACL and FINCL shall have agreed in advance with the Independent Expert and appointed in writing for the Scheme to become effective. Such date shall be as soon as is reasonably practicable following the making of the Order and, in any event, no later than [31 December] 2004.

20.2 The Scheme shall not become effective unless:

- (A) the Order shall have been made;
- (B) the tax confirmations or clearances listed in Schedule 1 to this Scheme have been received in each case in the form and in the substance satisfactory to FACL and FINCL, both parties acting reasonably in deciding whether or not the form and substance of such tax confirmation or clearance is satisfactory;
- (C) FINCL is authorised by the FSA for the purposes of the Act with permission to (amongst other things) effect or carry out contracts of insurance comprising long term insurance business of the same classes as the Transferring Insurances;
- (D) the conditions set out in paragraph 19 of Schedule 3 of the Act are satisfied in respect of each of the branches listed in Schedule 2 to this Scheme which FINCL seeks to establish in any EEA State (other than the United Kingdom) once FINCL is authorised by the FSA for the purposes of the Act, provided that this paragraph (D) shall not apply in respect of any proposed branch of FINCL for which FINCL withdraws its notice of intention given to the FSA under paragraph 19(2) of Schedule 3 of the Act; and
- (E) the FSA has directed (in response to the relevant application from FINCL) that all relevant rules for which FACL had been granted a waiver or a modification under section 148 of the Act that was in force immediately prior to the Transfer Date shall be waived or modified in respect of FINCL in the

20.3 In circumstances where any tax confirmation or clearance is received in a form and/or substance not satisfactory to either FACL or FINCL or is not received at all, then FACL and FINCL may jointly agree that such tax confirmation or clearance be deemed to have been received in a form and in substance satisfactory for the purposes of paragraph 20.2(B) above.

20.4 Unless the Scheme shall have become effective on or before 23.59 GMT on 31 December 2004 or such later date and/or time, if any, as FACL and FINCL may approve and the Court may allow, this Scheme shall lapse.

## 21. MODIFICATION

FINCL and FACL may at any time agree on behalf of themselves and all other persons concerned to any modification of or addition to this Scheme or to any further condition or provision affecting the same that the Court may approve or impose.

## 22. COSTS AND EXPENSES

To the extent not already borne or discharged by FACL, FINCL shall bear all professional fees, costs of advertising and any required mailing and any other expenses incurred in the preparation and carrying into effect of this Scheme and those fees, costs and expenses shall be attributed to the FINCL Shareholder Fund (but so that this provision shall be without prejudice to any obligation of any person to reimburse such costs).

## 23. GOVERNING LAW

This Scheme shall be governed by and construed in accordance with English law.

### Schedule 1

#### TAX CONFIRMATIONS

FACL and FINCL will seek tax clearances and confirmations in respect of the transfer of FACL's business to FINCL that:

1. the transfers effected pursuant to the Scheme, including those of any residual assets, will not by virtue of sections 139 and 211 of the Taxation of Chargeable Gains Act 1992 and to the extent provided by those sections give rise to chargeable gains;
  2. unrelieved management expenses (including acquisition expenses unrelieved by virtue of section 86(6) of the Finance Act 1989) and Schedule Case VI losses carried or spread forward in FACL at the Transfer Date may be carried or spread forward and set against the appropriate taxable income of FINCL under Section 444A of the Taxes Act;
  3. relevant unused losses in FACL at the Transfer Date are treated as BLAGAB allowable losses accruing to FINCL in the accounting period of FINCL in which the Transfer takes place, under Section 211ZA of the Taxation of Chargeable Gains Act 1992;
  4. the UK taxation consequences of the exercise after the Transfer Date of any option to vary a policy or contract or to effect an additional or substituted policy on favourable terms conferred by policies or contracts issued or granted by FACL will not by virtue of the Scheme be different from the UK taxation consequences which would have ensued from such an exercise before the Transfer Date;
  5. the Scheme will not constitute a breach of a qualifying policy or a variation in any of the terms of any qualifying policy for the purposes of Chapter II of Part XIII of the Taxes Act;
  6. the transactions contemplated under the Scheme are such that no notice under section 703(3) of the Taxes Act ought to be given in respect of any of them or that the Inland Revenue are of the view that section 703 does not apply to such transactions; and
  7. the transfer of the Goodwill does not result in any change in categorisation within section 440 of the Taxes Act.
- 

### Schedule 2

#### EEA BRANCHES LIST

1. Ireland
2. Norway
3. Netherlands
4. Denmark
5. Germany
6. Italy
7. Portugal
8. Finland
9. Sweden

IN THE HIGH COURT OF JUSTICE  
CHANCERY DIVISION  
COMPANIES COURT

[THE HON. MR JUSTICE [     ]]

IN THE MATTER of  
Financial Assurance Company Limited

and

IN THE MATTER of  
Financial New Life Company Limited

and

IN THE MATTER of  
the Financial Services and Markets Act 2000

SCHEME

for the transfer to Financial New Life Company Limited of the insurance business of Financial Assurance Company Limited (pursuant to Part VII of Financial Services and Markets Act 2000)

Slaughter and May  
One Bunhill Row  
London EC1Y 8YY  
(GWJ/RJS)  
CA032700001

CONTENTS

1.	<a href="#">DEFINITIONS AND INTERPRETATION</a>
2.	<a href="#">INTRODUCTION</a>
3.	<a href="#">TRANSFER OF TRANSFERRING INSURANCES</a>
4.	<a href="#">TRANSFER OF TRANSFERRING BUSINESS</a>
5.	<a href="#">TRANSFER OF TRANSFERRING ASSETS, TRANSFERRING CONTRACTS, REINSURANCE CONTRACTS AND RESIDUAL ASSETS</a>
6.	<a href="#">TRANSFER OF TRANSFERRING LIABILITIES AND RESIDUAL LIABILITIES</a>
7.	<a href="#">AVAILABILITY OF ASSETS</a>
8.	<a href="#">ALLOCATION OF TRANSFERRING INSURANCES</a>
9.	<a href="#">ALLOCATION OF TRANSFERRING ASSETS, CIGL SHAREHOLDING AND GOODWILL</a>
10.	<a href="#">ALLOCATION OF TRANSFERRING LIABILITIES</a>
11.	<a href="#">TRANSFERRING INSURANCES, TRANSFERRING CONTRACTS AND REINSURANCE CONTRACTS</a>
12.	<a href="#">RETAINED INSURANCES</a>
13.	<a href="#">VIKING REINSURANCE</a>
14.	<a href="#">CONTINUITY OF PROCEEDINGS</a>
15.	<a href="#">MANDATES AND OTHER INSTRUCTIONS</a>
16.	<a href="#">DECLARATION OF TRUST BY FACL</a>
17.	<a href="#">INDEMNITIES IN FAVOUR OF FACL</a>
18.	<a href="#">CONSTRUCTION OF TRANSFERRING INSURANCES</a>
19.	<a href="#">ADMINISTRATION</a>
20.	<a href="#">TRANSFER DATE</a>

- [21. MODIFICATION](#)
- [22. COSTS AND EXPENSES](#)
- [23. GOVERNING LAW](#)

**Schedules**

[Schedule 1: Tax Confirmations](#)

[Schedule 2: EEA Branches List](#)

---



• 200[4]

**AGREEMENT**

**for the sale and purchase of shares in  
FINANCIAL ASSURANCE COMPANY LIMITED**

**between**

**GE INSURANCE HOLDINGS LIMITED  
as Seller**

**and**

**GEFA UK HOLDINGS LIMITED  
as Buyer**

**Weil, Gotshal & Manges**

One South Place London EC2M 2WG  
Tel: +44 (0) 20 7903 1000 Fax: +44 (0) 20 7903 0990

www.weil.com

---

**THIS AGREEMENT** is made on • 200[4] between the following parties:

- (1) **GE INSURANCE HOLDINGS LIMITED**, a company incorporated in England and Wales (registered number 02221244), whose registered office is at Vantage West, Great West Road, Brentford, Middlesex TW8 9AG (the “**Seller**”); and
- (2) **GEFA UK HOLDINGS LIMITED**, a company incorporated in England and Wales (registered number 4914933), whose registered office is at Vantage West, Great West Road, Brentford, Middlesex TW8 9AG (the “**Buyer**”).

**RECITALS**

- (A) Financial Assurance Company Limited (the “**Company**”) was incorporated in England and Wales on 2 March 1972 under the Companies Act 1948 with registered number 01044679 and is a private company limited by shares.
- (B) The Company has an issued share capital of 31,346,154 ordinary shares of £1 each (the “**Shares**”).
- (C) The Seller has agreed to sell and the Buyer has agreed to buy the Shares for the consideration and upon the terms and subject to the conditions set out in this Agreement.

**IT IS AGREED** as follows:

**1 SALE AND PURCHASE**

The Seller shall sell and the Buyer shall buy the Shares on the date of this Agreement, together with all rights attaching to the Shares as at or after the date of this Agreement.

**2 CONSIDERATION**

The total consideration for the purchase of the Shares shall be satisfied by the payment on the Completion Date (as defined in Clause 3.1) to the Seller of [£]¶ (the “**Consideration**”).

**3 COMPLETION**

**3.1** Completion shall take place on the date of this Agreement (the “**Completion Date**”).

**3.2** On the Completion Date, the Seller shall deliver or procure the delivery to the Buyer of the following:

**3.2.1** duly executed stock transfer form(s) in respect of the Shares and the relevant share certificate(s); and

**3.2.2** resignation letters in the agreed form signed by *[insert names of any resigning director/secretary]*.

**3.3** On the Completion Date, the Seller shall procure that the directors of the Company shall hold a board meeting at which:

---

**3.3.1** the transfer of the Shares (subject to stamping) to the Buyer or its nominee(s) shall be approved for registration in the Company’s books;

3.3.2 [if relevant] such persons as the Buyer nominates shall be appointed as directors and secretary of the Company with effect from the close of the meeting; and

3.3.3 [if relevant] the resignations of the directors and secretary referred to in Clause 3.2.2 shall be tendered and accepted so as to take effect from the close of the meeting.

3.4 [On the Completion Date, the Buyer shall pay the Consideration to [such bank account as] the Seller [shall have specified in writing to the Buyer at least [three] Business Days before the Completion Date] [as the Seller may direct].]

#### 4 RIGHTS OF THIRD PARTIES

A person who is not a party to this Agreement has no rights under the Contracts (Rights of Third Parties) Act 1999 or otherwise to enforce any term of this Agreement but this does not affect any right or remedy of a third party which exists or is available apart from the Act.

#### 5 VARIATION

Any variation of this Agreement must be in writing and signed by each party or, in the case of a body corporate, a duly authorised officer or representative of such party.

#### 6 COUNTERPARTS

This Agreement may be executed in any number of counterparts, each of which when executed and delivered constitutes an original of this Agreement, but all the counterparts shall together constitute one and the same agreement. No counterpart shall be effective until each party has executed at least one counterpart.

#### 7 WHOLE AGREEMENT

This Agreement contains the whole agreement between the parties relating to the subject matter of this Agreement to the exclusion of any terms implied by law which may be excluded by contract. The Buyer acknowledges that it has not been induced to enter into this Agreement by, and so far as permitted by law and except in the case of fraud, hereby waives any remedy in respect of, any warranties, representations, undertakings, promises or assurances not incorporated into this Agreement.

#### 8 GOVERNING LAW

This Agreement is governed by, and shall be construed in accordance with, English law.

#### 9 JURISDICTION

The parties irrevocably agree that the courts of England have non-exclusive jurisdiction to decide and to settle any dispute or claim arising out of or in connection with this Agreement.

IN WITNESS WHEREOF THIS AGREEMENT WAS EXECUTED BY THE PARTIES HERETO ON THE DATE SET OUT ON PAGE 2.

Signed by )  
)  
)  
for and on behalf of )  
**GE INSURANCE HOLDINGS** )  
**LIMITED** )

Signed by )  
)  
)  
for and on behalf of )  
**GEFA UK HOLDINGS** )  
**LIMITED** )

**AGREEMENT ON TRANSFER OF A PORTFOLIO OF  
INSURANCE CONTRACTS**

**Between:**

- Vie Plus, having its registered office at Tour Franklin – Terrasse Boieldieu – 92800 Puteaux represented by Mr. [ ], acting in the capacity of [ ].  
(the “Transferor”)

**And:**

- Financial New Life Company Limited, incorporated in England and Wales registered under n° 4873014 having its registered office at Vantage West, Great West Road, Brentford, Middlesex TW8 9 AG, acting directly or through its French branch having its registered office at [ ], represented by Mr. [ ], acting in the capacity of [ ].  
(the “Transferee”)

**It has been settled and agreed as follows:****Article 1**

In application of the provisions of article L. 324-1 of the Insurance Code, the Transferor shall transfer all of its portfolio of payment protection insurance contracts together with their rights and obligations and all underlying reserves applicable to such contracts, such as they result from the transfer balance sheet appended herewith (Appendix 1) (the “Transferred Portfolio”), to the Transferee, which undertakes to accept this transfer.

1

---

**Article 2**

The transfer of the Transferred Portfolio is made in consideration for payment by the Transferee to the Transferor of EUR [ ] (the “Purchase Price”) payable by bankers draft or bank transfer, as instructed by the Transferor.

**Article 3**

The commitments stipulated in Article 1 above are taken subject to the condition precedent of approval of the transfer by an order made by the Minister of the Economy, Finance and Industry pursuant to the conditions stipulated Article L. 324-1 of the Insurance Code.

**Article 4**

Subject to Article 9 below, on publication in the *Journal Officiel* of the decree bearing approval of the transfer (the “Entry into Possession”), the Transferee shall be substituted to the Transferor, in respect of the Transferred Portfolio, with regard to the policyholders, creditors and third parties.

**Article 5**

In addition to the stipulations of this agreement and its appendices, the transfer is granted and accepted by FINCL subject to execution by the latter of the following charges:

- (a) The Transferee shall take the Transferred Portfolio in the state in which it is found on the day of Entry into Possession without being entitled to exercise any recourse against the transferring company for any reason whatsoever, particularly due to change in the composition of the Portfolio, insolvency of the debtors, error in description or content, whatever the difference;
- (b) as from the time of Entry into Possession, the Transferee shall pay all taxes, contributions and levies of all kinds to which the Transferred Portfolio may be liable, at present or in future, notably with regard to the Registration Authorities concerning the tax on insurance agreements;
- (c) as from the same day, it shall perform all policies, contracts, agreements and commitments relative to the Transferred Portfolio;
- (d) it shall comply with the laws, decrees, orders, regulations and customs concerning the Transferred Portfolio, and it shall be personally responsible for all authorisations that might be required.

2

---

**Article 6**

The records relative to current contracts, supporting documents on the existence of the assets transferred, accounting and, generally, all documents bearing on the transfer shall be handed over to the Transferee by the Transferor.

**Article 7**

The transaction which is the subject of this agreement is subject, in respect of registration duty, to in Article 1065 paragraph 1 of the French General Tax Code.

**Article 8**

The present transfer agreement includes the following appendices:



**BUSINESS TRANSFER AGREEMENT**

between

VIE PLUS S.A.

and

FINANCIAL NEW LIFE COMPANY LIMITED

dated

[ ]

<b><u>Article 1</u></b>	<b><u>Contract Purpose</u></b>
<b><u>Article 2</u></b>	<b><u>Business Description</u></b>
2.1	<u>Tangible and Intangible Assets</u>
2.2	<u>Exclusions</u>
2.3	<u>Employment Agreements</u>
<b><u>Article 3</u></b>	<b><u>Sale Price and Payment</u></b>
3.1	<u>Determining the Price</u>
3.2	<u>Declaration of Truthfulness</u>
3.3	<u>Payment</u>
3.4	<u>Closing</u>
<b><u>Article 4</u></b>	<b><u>Representations and Warranties</u></b>
4.1	<u>Obligatory representations of the Seller pursuant to Article L.141-1 of the Commercial Code</u>
4.2	<u>No Representations and Warranties</u>
<b><u>Article 5</u></b>	<b><u>Buyer Undertakings</u></b>
5.1	<u>Acquiring the Business “As Is”</u>
5.2	<u>Taxes</u>
5.3	<u>Perfection of the Sale</u>
5.4	<u>Indemnity in respect of Liabilities</u>
<b><u>Article 6</u></b>	<b><u>Value-Added Tax</u></b>
<b><u>Article 7</u></b>	<b><u>Miscellaneous</u></b>
7.1	<u>Formalities and Notice</u>
7.2	<u>Duties and Expenses</u>
7.3	<u>Notifications</u>
7.4	<u>Choice of Residence</u>
7.5	<u>Applicable Law and Jurisdiction</u>
7.6	<u>Portfolio Transfer</u>

**BUSINESS TRANSFER AGREEMENT****BETWEEN:**

VIE PLUS S.A., a French *société anonyme* with a capital of 11,500,000 Euros, with its registered office at Tour Franklin, Terrasse Boieldieu, Puteaux (92800), registered under no. 334 502 788 with the Nanterre Registry of Commerce and Companies, represented by [ ], duly authorized for the purposes of this agreement,

(hereinafter referred to as the “Seller”),

**ON THE ONE HAND,****AND**

FINANCIAL NEW LIFE COMPANY LIMITED, incorporated in England and Wales with registered number 4873014 having its registered office at Vantage West, Great West Road, Brentford, Middelsex TW8 9AG, acting through its French Branch, registered in the Commercial and Companies Register of [ ] under number [ ], having its registered office at [ ], duly represented for the purposes hereof by [ ],

(hereinafter referred to as the “Buyer”),

**ON THE OTHER HAND,**

(hereinafter referred to individually as a “Party” and together as the “Parties”).

**WHEREAS:**

The Seller is a subsidiary of GE Capital S.A.S. . The Buyer is a subsidiary of Genworth Financial, Inc.

The Seller is engaged in the business of insurance, including specifically the business of payment protection insurance.

The Buyer is engaged in the business of insurance.

Pursuant to the terms of the Master Agreement of [ ] among General Electric Company, General Electric Capital Corporation, GEI, Inc. GE Financial Assurance Holdings, Inc. and Genworth Financial, Inc. (the "Master Agreement"), the portion of the Seller's business consisting of its payment protection insurance activity, including all assets and

---

liabilities related to such activity, is to be transferred to an entity controlled by Genworth Financial, Inc.

Consequently, within the scope of this business transfer agreement (hereinafter the "Agreement"), the Seller wishes to sell to the Buyer, and the Buyer has accepted to acquire from the Seller, according to the terms and conditions defined herein, the payment protection insurance business of the Seller described below, including certain tangible and intangible assets related to such activity (the "Business").

That portion of the Business consisting of the insurance contracts and underlying reserves more specifically identified in Schedule 1 is being transferred by the Seller to the Buyer, within the framework of this Agreement, by means of a portfolio transfer regulated by article L 324-1 of the Insurance Code as approved by the Minister of Finance and the Economy on [ ] and published in the Journal Officiel on [ ] (the "Portfolio Transfer").

**THEREFORE, THE PARTIES HAVE AGREED AS FOLLOWS:**

ARTICLE 1

**Contract Purpose**

By this Agreement, and pursuant to the provisions of French law applicable to business transfers, the Seller sells, assigns and transfers to the Buyer who purchases, takes and acquires, the Business assets described in Article II herein.

ARTICLE 2

**Business Description**

2.1 **Tangible and Intangible Assets**

The Business includes, in particular, the following:

- (a) The rights attached to the Business clientele.
- (b) All insurance contracts and associated assets and liabilities included in the Portfolio Transfer.
- (c) The tangible assets listed in Schedule 2
- (d) All rights and obligations pursuant to commercial contracts relating to the Business (the "Commercial Contracts") shown in Schedule 3 to this Agreement.

2

- 
- (e) Any technical, commercial or financial documentation relative to the Business.

- (f) Accounts receivable generated after [ ].

2.2 **Exclusions**

The following assets related to the Business are specifically excluded from the transfer of the Business hereunder:

[ ]

2.3 **Employment Agreements**

Pursuant to the provisions of article L. 122-12 para. 2 and Article L. 122-12-1 of the French Labor Code, current employment agreements for the salaried employees shown in the list in Schedule 4 to this Agreement (the "Employees") shall be transferred to the Buyer to be effective as from the Closing as defined in Clause 3.4 below.

ARTICLE 3

**Sale Price and Payment**

3.1 **Determining the Price**

At the Closing, the Buyer shall pay the amount of € [ ] (the "Sale Price"). The Sale Price is broken down in the following manner:

- [ ] - Assets transferred as part of the Portfolio Transfer, other than Clientele
- [ ] - Clientele (transferred as part of the Portfolio Transfer)
- [ ] - Tangible assets
- [ ] - Intangible assets not included as part of the Portfolio Transfer.

3.2 Declaration of Truthfulness

The Parties declare, under pain of the penalties decreed in Article 1837 of the French General Tax Code, that the Sale Price constitutes the entire price agreed and payable at the Closing. Each Party hereto acknowledges having been informed of the penalties to which it is subject in the event of a shortfall or concealment in the price.

3.3 Payment

The entire Sale Price is paid by the Buyer to the Seller on the date hereof.

3

---

3.4 Closing

The date of closing of the transfer of the Business ("Closing") is, for all purposes hereof, the signature date of this Agreement.

ARTICLE 4

**Representations and Warranties**

4.1 Mandatory representations of the Seller pursuant to Article L.141-1 of the Commercial Code

(a) Property Origin The Seller represents and warrants that it is the owner of the Business, which was created by the Seller.

(b) Turnover The Seller represents that its total turnover (before taxes) for the past three years amounted to:

Jan. 1, 2001 to Dec. 31, 2001: [ ]

Jan. 1, 2002 to Dec. 31, 2002: [ ]

Jan. 1, 2002 to Dec. 31, 2003: [ ].

The total turnover (before taxes) for the period from January 1, 2004 to [ ], 2004 is estimated at € [ ].

The Seller declares that the total turnover indicated above includes not only turnover corresponding to the Business but also includes its other activities. As a consequence, the turnover (before taxes) for the Business set forth below is only an estimate. The Buyer acknowledges that the figures set forth below are an estimate, acknowledges the receipt of this information from the Seller, and waives any claim in this regard.

Estimate of the turnover (before taxes) for the Business for the last three years:

Jan. 1, 2001 to Dec. 31, 2001: [ ]

Jan. 1, 2002 to Dec. 31, 2002: [ ]

Jan. 1, 2003 to Dec. 31, 2003: [ ].

The turnover (before taxes) for the Business for the period from January 1, 2004 to [ ], 2004 is estimated at € [ ].

4

---

(c) Earnings The Seller represents that its net earnings for the three previous years amount to:

Jan. 1, 2001 to Dec. 31, 2001: [ ]

Jan. 1, 2002 to Dec. 31, 2002: [ ]

Jan. 1, 2003 to Dec. 31, 2003: [ ].

Net earnings for the period January 1, 2004 to [ ], 2004 are estimated at € [ ].

The Seller declares that the earnings set forth above include not only the Business but also include its other activities. As a consequence, the net earnings relating to the Business and set forth below are only a rough estimate. The Buyer acknowledges that the figures set forth below are only an estimate, acknowledges the receipt of this information from the Seller, and waives any claim in this regard.

Estimates for net earnings for the Business for the three previous years:

Jan. 1, 2001 to Dec. 31, 2001: [ ]

Jan. 1, 2002 to Dec. 31, 2002: [ ]

Jan. 1, 2003 to Dec. 31, 2003: [ ].

Net earnings for the Business for the period January 1, 2004 to [ ], 2004 are estimated at € [ ].

(d) Lease The Business does not include a tenant's right to a lease.

4.2 No Representations and Warranties

Other than the obligatory representations contained in Article 4.1, the Seller makes no representations or warranties whatsoever concerning the Business or any assets being transferred pursuant to this Agreement.

ARTICLE 5

**Buyer Undertakings**

5.1 Acquiring the Business “As Is”

The Buyer shall acquire the Business in the state in which it finds the Business on the date of this Agreement

5.2 Taxes

Without prejudice to any applicable provisions of the Master Agreement, the Buyer is obliged to pay, or to reimburse the Seller, as from the Closing, the taxes and contributions

5

---

including, *prorata temporis*, the professional tax for the year underway, all taxes, fees and other charges of any nature, to which the operation of the Business may and could give rise, even where such taxes or charges are invoiced to the Seller; to pay any city or police fees relative to the operation of the Business, and all in a manner so that the Seller shall not have any liability whatsoever in this regard.

5.3 Perfection of the Sale

The Seller will, whenever reasonably requested to do so by the Buyer, cooperate with the Buyer in order to obtain all necessary consents and carry out any additional steps, notifications or procedures with any authority or third party, including any other entity of the Seller's group, that would be necessary in order to perfect the sale of the Business and the transfer of all of its elements.

5.4 Indemnity in respect of Liabilities

The Buyer will fully indemnify the Seller and all shareholders, directors, officers, agents or employees of the Seller (hereinafter, the “Indemnified Persons”) and hold them harmless, on first demand of the Seller, in respect of any and all liability, whether contractual or extra-contractual, which any of such Indemnified Persons bear or may incur at any time in respect of, or arising out of, the Business (including, but not limited to, the contracts and other assets and liabilities included in the Portfolio Transfer), whether or not the act, omission, event or circumstance giving rise to such liability occurred prior to or after Closing and this indemnity obligation of the Buyer is accepted by both parties as being an integral part of this Agreement and as being an essential condition of the Seller's obligations and undertakings hereunder.

ARTICLE 6

**Value-Added Tax**

The Sale Price is exclusive of any value added taxes.

The Seller shall deliver a tax invoice which satisfies the requirements of French value added tax legislation to the Buyer on the Closing Date.

ARTICLE 7

**Miscellaneous**

7.1 Formalities and Notice

The Buyer shall carry out, within the required deadlines, all the necessary steps for the registration of this Agreement and will accomplish all the formalities for giving notice prescribed by law. All powers are conferred upon the holder of an original of this Agreement, with power to appoint a sub-agent, in order to carry out the registration and publication formalities.

6

---

7.2 Duties and Expenses

As between the Seller and the Buyer, responsibility for payment of any duties (including registration duties) and expenses in connection with the transfer of the assets covered by this Agreement shall be determined in accordance with the relevant provisions of the Master Agreement.

7.3 Notifications

All notices as well as all notifications and other communications stipulated in this Agreement shall be validly delivered for the purposes of this agreement, if they are sent by registered mail with return receipt requested to the exact address noted below.

Notices or notifications intended for the Seller should be sent to:

Vie Plus S.A.  
[ ] Tour Franklin – Terrasse Boieldieu – 92800  
Puteaux  
Attention of Mr. [ ]

Notices or notifications intended for the Buyer should be sent to:

Financial New Life Company Limited [ ]

7.4 Choice of Residence



For the performance of this Agreement, the Parties choose residence at the address of their respective registered office. Concerning objections which may be filed following the legal publication of the sale of the Business, the Parties choose residence at the registered office of the Escrow Agent.

7.5 Applicable Law and Jurisdiction

The Agreement is governed exclusively by French law. Any dispute, litigation or action resulting from the Agreement or related to it, or the actual or alleged violation of this Agreement, or affecting this Agreement in any manner whatsoever, shall be resolved in accordance with the provisions of Article VII of the Master Agreement.

7.6 Portfolio Transfer

The Parties expressly agree that the Portfolio Transfer forms an integral part of this Agreement and acknowledge that the Portfolio Transfer is subject to specific legal rules concerning *inter alia* notifications, effectiveness and registration duty.

7

---

Executed in [ ] on [ ], in five (5) originals, one being for the registration.

VIE PLUS S.A.

FINANCIAL NEW LIFE COMPANY  
LIMITED

By: [ ]

By: [ ]

8

---

**SCHEDULE 1**

**PORTFOLIO TRANSFER**

including Annexes to  
Portfolio Transfer

---

**SCHEDULE 2**

**TANGIBLE ASSETS**

---

**SCHEDULE 3**

**CONTRACTS (NOT INCLUDED AS PART  
OF THE PORTFOLIO TRANSFER)**

---

**SCHEDULE 4**

**EMPLOYEES**

---

---

ADMINISTRATIVE SERVICES AGREEMENT

by and between

UNION FIDELITY LIFE INSURANCE COMPANY

and

GE GROUP LIFE ASSURANCE COMPANY

Effective as of [ ], 2004

---

TABLE OF CONTENTS

<a href="#">ARTICLE I</a>	<a href="#">DEFINITIONS</a>
<a href="#">Section 1.1.</a>	<a href="#">Definitions</a>
<a href="#">ARTICLE II</a>	<a href="#">AUTHORITY</a>
<a href="#">Section 2.1.</a>	<a href="#">Appointment</a>
<a href="#">Section 2.2.</a>	<a href="#">Denial of Claims and Litigation</a>
<a href="#">Section 2.3.</a>	<a href="#">Service Managers</a>
<a href="#">ARTICLE III</a>	<a href="#">STANDARD FOR SERVICES; FACILITIES; SUBCONTRACTING</a>
<a href="#">Section 3.1.</a>	<a href="#">Standard for Services</a>
<a href="#">Section 3.2.</a>	<a href="#">Facilities and Personnel</a>
<a href="#">Section 3.3.</a>	<a href="#">Subcontracting</a>
<a href="#">Section 3.4.</a>	<a href="#">Consultation and Direction</a>
<a href="#">ARTICLE IV</a>	<a href="#">CLAIMS HANDLING</a>
<a href="#">Section 4.1.</a>	<a href="#">Claim Administration Services</a>
<a href="#">Section 4.2.</a>	<a href="#">Claims Settlement Account</a>
<a href="#">ARTICLE V</a>	<a href="#">BILLINGS AND COLLECTIONS</a>
<a href="#">Section 5.1.</a>	<a href="#">Billing and Collection Services</a>
<a href="#">ARTICLE VI</a>	<a href="#">UNDERWRITING</a>
<a href="#">Section 6.1.</a>	<a href="#">Underwriting Services</a>
<a href="#">Section 6.2.</a>	<a href="#">Underwriting Guidelines</a>
<a href="#">ARTICLE VII</a>	<a href="#">CERTAIN ACTIONS BY COMPANY</a>
<a href="#">Section 7.1.</a>	<a href="#">Filings</a>
<a href="#">ARTICLE VIII</a>	<a href="#">REGULATORY MATTERS AND AUDIT REPORTING</a>
<a href="#">Section 8.1.</a>	<a href="#">Regulatory Compliance and Reporting</a>
<a href="#">Section 8.2.</a>	<a href="#">Reporting and Accounting</a>
<a href="#">Section 8.3.</a>	<a href="#">Additional Reports and Updates</a>
<a href="#">ARTICLE IX</a>	<a href="#">BOOKS AND RECORDS</a>
<a href="#">ARTICLE X</a>	<a href="#">COOPERATION</a>
<a href="#">ARTICLE XI</a>	<a href="#">PRIVACY REQUIREMENTS</a>
<a href="#">ARTICLE XII</a>	<a href="#">CONSIDERATION FOR ADMINISTRATIVE SERVICES</a>
<a href="#">ARTICLE XIII</a>	<a href="#">INDEMNIFICATION</a>
<a href="#">Section 13.1.</a>	<a href="#">Indemnification</a>
<a href="#">Section 13.2.</a>	<a href="#">Indemnification Procedures</a>
<a href="#">Section 13.3.</a>	<a href="#">Procedures for Direct Claims</a>
<a href="#">Section 13.4.</a>	<a href="#">Limited Liability</a>
<a href="#">ARTICLE XIV</a>	<a href="#">DURATION; TERMINATION</a>
<a href="#">Section 14.1.</a>	<a href="#">Duration</a>
<a href="#">Section 14.2.</a>	<a href="#">Termination</a>

---

<a href="#">Section 14.3.</a>	<a href="#">Transfer of Books and Records</a>
<a href="#">ARTICLE XV</a>	<a href="#">DISPUTE RESOLUTION</a>
<a href="#">Section 15.1.</a>	<a href="#">General Provisions</a>
<a href="#">Section 15.2.</a>	<a href="#">Consideration by Senior Executives</a>
<a href="#">Section 15.3.</a>	<a href="#">Mediation</a>
<a href="#">Section 15.4.</a>	<a href="#">Arbitration</a>
<a href="#">ARTICLE XVI</a>	<a href="#">MISCELLANEOUS PROVISIONS</a>
<a href="#">Section 16.1.</a>	<a href="#">Headings and Schedules</a>
<a href="#">Section 16.2.</a>	<a href="#">Notices</a>
<a href="#">Section 16.3.</a>	<a href="#">Successors and Assigns</a>
<a href="#">Section 16.4.</a>	<a href="#">Execution in Counterpart</a>
<a href="#">Section 16.5.</a>	<a href="#">Currency</a>
<a href="#">Section 16.6.</a>	<a href="#">Amendments</a>
<a href="#">Section 16.7.</a>	<a href="#">Governing Law</a>
<a href="#">Section 16.8.</a>	<a href="#">Entire Agreement; Severability</a>
<a href="#">Section 16.9.</a>	<a href="#">No Waiver; Preservation of Remedies</a>
<a href="#">Section 16.10.</a>	<a href="#">Third Party Beneficiary</a>
<a href="#">Section 16.11.</a>	<a href="#">Negotiated Agreement</a>
<a href="#">Section 16.12.</a>	<a href="#">Tax Exception to Any Confidentiality</a>
<a href="#">Section 16.13.</a>	<a href="#">Errors and Omissions</a>
<a href="#">Section 16.14.</a>	<a href="#">Interpretation</a>
<a href="#">Section 16.15.</a>	<a href="#">Survival</a>

SCHEDULES

<a href="#">SCHEDULE A</a>	<a href="#">Insurance Contracts</a>
<a href="#">SCHEDULE B</a>	<a href="#">Business Associate Addendum</a>
<a href="#">SCHEDULE C</a>	<a href="#">EXPENSE ALLOWANCE FOR ADMINISTRATIVE SERVICES</a>

**ADMINISTRATIVE SERVICES AGREEMENT**

This ADMINISTRATIVE SERVICES AGREEMENT (this "Agreement"), effective as of [ ], 2004 (the "Effective Date"), is entered into by and between GE GROUP LIFE ASSURANCE COMPANY, an insurance company organized under the laws of the State of Connecticut (the "Administrator"), and UNION FIDELITY LIFE INSURANCE COMPANY, an insurance company organized under the laws of the State of Illinois (the "Company").

**RECITALS:**

WHEREAS, the Company wishes to appoint the Administrator to provide administrative services with respect to certain insurance policies and contracts issued, assumed, reinsured or administered by the Company, and the Administrator desires to provide such administrative services; and

WHEREAS, this Agreement is entered into in connection with an intercompany reorganization among the Company, the Administrator and certain of their Affiliates;

NOW, THEREFORE, in consideration of the covenants and agreements set forth herein, the parties hereto agree as follows:

**ARTICLE I**

**DEFINITIONS**

Section 1.1. **Definitions.** As used in this Agreement, the following terms shall have the following meanings (definitions are applicable to both the singular and the plural forms of each term defined in this Article):

"**Administrative Services**" shall have the meaning specified in Article II.

"**Administrator**" shall have the meaning specified in the first paragraph of this Agreement.

"**Affiliate**" means any other Person that directly or indirectly controls, is controlled by, or is under common control with, the first Person. "**Control**" (including the terms, "**controlled by**" and "**under common control with**") means the possession, directly or indirectly, of the power to direct or cause the direction of the management and policies of a Person, whether through the ownership of voting securities, by contract or credit arrangement, as trustee or executor, or otherwise.

"**Agreement**" shall have the meaning specified in the first paragraph of this Agreement.

"**Allocated Loss Adjustment Expenses**" means all costs, fees and expenses incurred by the Company or its Affiliates in the investigation, adjustment, settlement or defense of all claims or the monitoring, preservation or enforcement of rights, interests or benefits arising out of or relating to the Insurance Contracts (excluding office expenses and salaries of officials of the

Company or its Affiliates or any other administrative or overhead expenses of the Company or of its Affiliates), and court costs, and interest on any judgment or award. Allocated Loss Adjustment Expenses shall also include expenses associated with an action by any entity for declaratory judgment filed in connection with the Insurance Contracts.

“Applicable Law” means any federal, state, local or foreign law (including common law), statute, ordinance, rule, regulation, order, writ, injunction, judgment, permit, governmental agreement or decree applicable to a Person or any of such Person’s subsidiaries, properties, assets, or to such Person’s officers, directors, managing directors, employees or agents in their capacity as such.

“Business Day” means any day other than a Saturday, Sunday or other day on which commercial banks in the States of Illinois or Connecticut are required or authorized by law to be closed.

“Claims Settlement Account” shall have the meaning specified in Section 4.2(a).

“Code” means the Internal Revenue Code of 1986, as amended.

“CPR” shall have the meaning specified in Section 15.3.

“CPR Arbitration Rules” shall have the meaning specified in Section 15.4(a).

“Damage” or “Damages” shall have the meaning set forth in Section 13.1(a).

“Direct Claim” shall have the meaning specified in Section 13.3.

“Direct Expenses” shall have the meaning specified in Article XII.

“Dispute” shall have the meaning specified in Section 15.1(a).

“Effective Date” shall have the meaning specified in the first paragraph of this Agreement.

“Expense Allowance” shall have the meaning specified in Article XII.

“Force Majeure” means any acts or omissions of any civil or military authority, acts of God, acts or omissions of the Company, fires, strikes or other labor disturbances, equipment failures, fluctuations or non-availability of electrical power, heat, light, air conditioning or telecommunications equipment, or any other act, omission or occurrence beyond the Administrator’s reasonable control, irrespective of whether similar to the foregoing enumerated acts, omissions or occurrences.

“GAAP” means U.S. generally accepted accounting principles consistently applied.

“Governmental Authority” means any foreign or national government, any state or other political subdivision thereof, and any entity exercising executive, legislative, judicial, regulatory or administrative functions of or pertaining to government.

“Indemnified Party” shall have the meaning specified in Section 13.2(a).

“Indemnifying Party” shall have the meaning specified in Section 13.2(a).

“Initial Notice” shall have the meaning specified in Section 15.2.

“Insurance Contracts” means collectively the group and individual insurance policies or contracts directly issued by the Company (direct policies) or reinsured by the Company (reinsured policies), or administered by the Company (administered policies), any of which are in effect or which have incurred or open claims on the Effective Date, including renewals of any non-cancelable or guaranteed renewable policies or contracts, which were administered by the Administrator prior to the Effective Date. The Insurance Contracts include those identified in Schedule A.

“Loss” or “Losses” means the amount of liability paid or payable by the Company with respect to claims, losses, liabilities, damages, deficiencies, costs or expenses, including without limitation, any settlements or compromises or disputed claims, arising under the Insurance Contracts.

“Minimum Claims Settlement Amount” shall have the meaning specified in Section 4.2(b).

“Overhead Expenses” shall have the meaning specified in Article XII.

“Person” means any natural person, firm, limited liability company, general partnership, limited partnership, joint venture, association, corporation, trust, Governmental Authority or other entity.

“Response” shall have the meaning specified in Section 15.2.

“Service Costs” shall have the meaning specified in Article XII.

“Subcontractor” shall have the meaning specified in Section 3.3.

“Tax” means all taxes, charges, fees, levies or other assessments, including, without limitation, any net income tax or franchise tax based on net income, any alternative or add-on minimum taxes, any gross income, gross receipts, premium, sales, use, ad valorem, value added, transfer, profits, license, payroll, employment, withholding, excise, severance, stamp, occupation, property, environmental or windfall profit tax, custom duty or other tax, governmental fee or other like assessment.

“Termination Date” means the effective date of any termination of this Agreement as provided in Article XIV.

---

ARTICLE II

AUTHORITY

Section 2.1. Appointment. The Company hereby appoints the Administrator, and the Administrator hereby accepts appointment, to provide as an independent contractor of the Company, from and after the Effective Date, all of the administrative services with respect to the Insurance Contracts that the Administrator is providing to the Company as of the Effective Date, including those set forth in this Agreement (the "Administrative Services"), all on the terms as set forth in this Agreement. In providing the Administrative Services, the Administrator (or the Subcontractor) shall handle all matters, including but not limited to the billing and collection of premiums and reinsurance premiums, the defense, adjustment, settlement and payment of all claims arising under the Insurance Contracts, as more fully described below, and any other required business support services provided to the Company as of the Effective Date. Notwithstanding any other provision of this Agreement to the contrary, the Company shall have the right to direct the Administrator to perform any action necessary relating to the Insurance Contracts or the policyholder and claim servicing thereof to comply with Applicable Law, or to cease performing any action that constitutes a violation of Applicable Law.

Section 2.2. Denial of Claims and Litigation. (a) The Administrator agrees that it will provide prompt notice to the Company of its intention to deny a claim or terminate benefits with respect to any Insurance Contract in the form and manner specified in writing by the Company (which writing by the Company shall be in accordance with Section 16.2), along with copies of all reports of investigation with respect thereto. The Administrator shall thereafter not deny such claim or terminate such benefits without the approval of the Company, provided that the Administrator may deny such claim or terminate such benefits without the approval of the Company if the Company fails to respond or fails to respond within a reasonable time period such as to allow the Administrator to act as required by any Applicable Law.

(b) The Administrator agrees that it will provide prompt notice to the Company of any litigation arising with respect to an Insurance Contract of which it becomes aware, along with copies of all pleadings with respect thereto. The Company shall have the right, at its own expense, to participate jointly with the Administrator in the investigation, adjustment or defense of such litigation and may, upon written notice to the Company, assume the defense thereof with counsel selected by the Company. If the Company assumes such defense, the Administrator shall have the right, at its own expense, to participate jointly with the Company in the defense thereof.

Section 2.3. Service Managers. The Administrator and the Company will each designate a services account manager (respectively, the "Administrator Services Manager" and the "Company Services Manager" and collectively, the "Services Managers") who will be directly responsible for coordinating and managing the Administrative Services and other obligations of the parties hereunder. The Administrator Services Manager will have authority to act on the Administrator's behalf with respect to the Administrative Services and the Administrator's obligations hereunder. The Company Services Manager shall have the authority to act on the Company's behalf with respect to the Administrative Services and the Company's obligations hereunder. The Services Managers shall cooperate in good faith to establish the

---

manner and timing for providing such information. Notwithstanding the provisions of Section 16.2, any requests for consent, consent or approval or other notice may be made in writing as between the Services Managers if the Service Managers agree in advance that the provisions of Section 16.2 do not apply to such request, consent or approval or other notice. Either party, from time to time, may designate a replacement Service Manager for the existing Service Manager, giving notice in accordance with Section 16.2.

ARTICLE III

STANDARD FOR SERVICES; FACILITIES; SUBCONTRACTING

Section 3.1. Standard for Services. The Administrator shall provide the Administrative Services in good faith and with the care, skill, prudence and diligence of a person experienced in providing such services. The Administrator shall provide the Administrative Services (i) in accordance with the terms of the Insurance Contracts, (ii) in accordance with the applicable terms of this Agreement, (iii) in compliance with Applicable Law and, subject to the foregoing, (iv) in the same manner as it conducts its own business not subject to this Agreement and (v) in accordance with the Administrator's administrative performance standards in effect on the date hereof, with such revisions to such standards as are no less favorable to the Company than the Administrator's standards in effect on the date hereof. Notwithstanding the foregoing, the parties may, from time to time, mutually develop specific and/or different standards for providing such Administrative Services with respect to the Insurance Contracts.

Section 3.2. Facilities and Personnel. The Administrator shall at all times maintain sufficient facilities and trained personnel of the kind necessary to perform its obligations under this Agreement in accordance with the performance standards set forth herein.

Section 3.3. Subcontracting. The Administrator may subcontract for the performance of any Administrative Service or Services to (i) any properly licensed affiliated or unaffiliated third party administrator or (ii) any properly licensed Affiliate insurance company or (iii) any other Person (in connection with activities not requiring a license) with the prior written consent of the Company, such consent not to be unreasonably withheld (in each case, the "Subcontractor"); provided, that, notwithstanding any other provision of this Section 3.3, the Administrator may continue to use any subcontractor utilized by the Administrator in connection with the Insurance Contracts on the Effective Date; and provided, further, that no such subcontracting shall relieve the Administrator from any of its obligations or liabilities hereunder, and the Administrator shall remain responsible for all obligations or liabilities of such Subcontractor with regards to the providing of such Administrative Service or Services as if provided by the Administrator.

Section 3.4. Consultation and Direction. From time to time, as is commercially reasonable, the Administrator may seek direction from the Company, including the Company Service Manager, in connection with the Administrative Services. The Company, including the Company Services Manager, may provide such direction, at the Company's sole discretion.

---

ARTICLE IV

CLAIMS HANDLING

The Administrative Services with respect to claims and claims for benefits including claims outstanding on the Effective Date, shall include the following:

Section 4.1. Claim Administration Services. The Administrator shall acknowledge, consider, review, investigate, deny, settle, pay or otherwise dispose of each claim and claim for benefits reported under each Insurance Contract (each, a "Claim" and collectively the "Claims").

Section 4.2. Claims Settlement Account. (a) On the Effective Date, the Company shall establish a separate fiduciary bank account (the "Claims Settlement Account") in its own name for the payment of Claims and shall authorize two signatories who shall be employed by the Administrator and approved by the Company in writing to issue checks in the name of the Company. The Company shall fund such account for payment of Claims in accordance with the provisions of Section 4.2(b). The Claims Settlement Account shall be the property of the Company and any interest earned on the Claims Settlement Account shall belong to the Company. The Claims Settlement Account shall be administered by the Administrator in a fiduciary capacity and shall be used solely by the Administrator to make payments of Claims in accordance with the terms of this Agreement.

(b) The Company shall fund the Claims Settlement Account on or before the fifth (5th) day of each month in amounts agreed by the Company and the Administrator from time to time in amounts sufficient to provide funds to the Administrator for the payment of Claims during the next thirty (30) days, or such other amount as may be mutually agreed by the parties (each minimum funding amount as agreed from time to time shall be referred to as a "Minimum Claims Settlement Amount"). In addition, the Company shall deposit to the Claims Settlement Account such additional amounts as may be required to keep the balance of such account above zero at all times.

(c) The Administrator shall keep true and complete records, in accordance with Applicable Law and its record management practices in effect from time to time for the Administrator's insurance business not covered by this Agreement, clearly recording the deposits in and withdrawals from the Claims Settlement Account, including records relating to the payment of Claims from the Claim Settlement Account. The Administrator will make available to the Company or its designated representative, or shall furnish to the Company or its designated representative, upon request of the Company or its designated representative, copies of all such records. All copies furnished in the ordinary course of business shall be furnished by the Administrator at the Administrator's cost, which shall be included in the Expense Allowance. Any extraordinary costs reasonably incurred by the Administrator in response to requests from the Company shall be reimbursed by the Company.

(d) Within thirty (30) days after each calendar month (or more frequently as mutually agreed by the parties), the Administrator shall render a complete accounting to the Company detailing all transactions with respect to the Claims Settlement Account, in such form as agreed by the parties.

6

---

(e) The parties agree to deliver to the depository bank such depository resolutions, signature cards and other documents as may be requested of them in order to use such accounts at the depository bank in accordance with the provisions of this Section 4.2.

(f) Upon a termination of this Agreement pursuant to Article XIV, the Company shall close the Claims Settlement Account and any closing balance therein shall be the property of the Company. The Administrator's claims payment authority under this Agreement shall terminate immediately upon termination of this Agreement pursuant to Article XIV. Upon termination of its authority to pay claims, the Administrator shall promptly return to the Company all unused check stock held by it in connection with this Agreement.

#### ARTICLE V

##### BILLINGS AND COLLECTIONS

Section 5.1. Billing and Collection Services. (a) The Administrator shall assume all responsibility for billing and collecting premiums and reinsurance premiums and other amounts payable with respect to the Insurance Contracts. The risk of loss, theft or destruction of premiums and such other amounts with respect to the Insurance Contracts shall be borne solely by the Company. The Administrator shall hold any premiums, deposits or other amounts collected with respect to the Insurance Contracts in a fiduciary capacity for the benefit of the Company.

(b) The Administrator shall promptly, but in no event later than three (3) Business Days after receipt, deposit such premiums, reinsurance premiums, or other amounts in the Claims Settlement Account. The Administrator may not commingle, and shall not permit any commingling of, any funds deposited in the Claims Settlement Account with any other funds.

#### ARTICLE VI

##### UNDERWRITING

Section 6.1. Underwriting Services. Subject to Section 6.2, the Administrator shall perform all necessary underwriting with respect to the renewal of the Insurance Contracts, if any.

Section 6.2. Underwriting Guidelines. All insurance underwriting services provided by the Administrator pursuant to this Agreement with respect to the Insurance Contracts shall be in accordance with any written underwriting guidelines and criteria provided to the Administrator by the Company.

#### ARTICLE VII

##### CERTAIN ACTIONS BY COMPANY

Section 7.1. Filings. The Company shall prepare and timely file any filings required to be made with any Governmental Authority that relate to the Company generally and not just to the Insurance Contracts, including filings with guaranty associations and filings and premium tax

7

---

returns with taxing authorities. The Administrator shall, in a timely fashion in light of the dates such filings by the Company are required, provide to the Company all information in the possession of the Administrator with respect to the Insurance Contracts that may be reasonably required for the Company to prepare such filings and tax returns. The parties shall cooperate in good faith to establish the manner and timing for providing such information.

#### ARTICLE VIII

## REGULATORY MATTERS AND AUDIT REPORTING

Section 8.1. Regulatory Compliance and Reporting. The Administrator shall provide to the Company such information with respect to the Insurance Contracts as is required to satisfy all current and future informational reporting, prior approval and any other requirements imposed by any Governmental Authority. Upon the reasonable request of the Company, the Administrator shall timely prepare such reports and summaries, including statistical summaries, as are necessary or useful to satisfy any requirements imposed by a Governmental Authority upon the Company with respect to the Insurance Contracts. In addition, the Administrator, upon the reasonable request of the Company shall promptly provide to the Company copies of all existing records relating to the Insurance Contracts (including, with respect to records maintained in machine readable form, hard copies) that are necessary to satisfy such requirements. All copies of records furnished in the ordinary course of business shall be furnished by the Administrator at the Administrator's cost. Any extraordinary costs reasonably incurred by the Administrator in response to requests from the Company shall be reimbursed by the Company. Among other responsibilities:

- (i) The Administrator shall promptly prepare and furnish to Governmental Authorities all reports and related summaries (including, without limitation, statistical summaries), certificates of compliance and other reports required or requested by a Governmental Authority.
- (ii) The Administrator shall assist the Company and cooperate with the Company in doing all things necessary, proper or advisable, in the most expeditious manner practicable in connection with any and all market conduct or other Governmental Authority examinations relating to the Insurance Contracts.

Section 8.2. Reporting and Accounting. The Administrator shall assume the reporting and accounting obligations set forth below:

- (i) As soon as practicable but not more than forty (40) days after the end of each calendar quarter that this Agreement is in effect (or more frequently as mutually agreed by the parties), the Administrator shall timely provide to the Company reports and summaries of transactions (and, upon request of the Company, detailed supporting records) related to the Insurance Contracts as may be reasonably required for use in connection with the preparation of the Company's statutory and GAAP financial statements, tax returns and other required financial reports and to comply with the

8

---

requirements of the regulatory authorities having jurisdiction over the Company, including all premium written and earned and all Losses and Allocated Loss Adjustment Expenses reserved, paid, and outstanding. The parties shall cooperate in good faith to establish the manner for the providing of such reports.

- (ii) The Administrator shall timely provide to the Company reports or summaries (and, upon the request of the Company, detailed supporting records therefor) related to the payment of commissions under the Insurance Contracts.
- (iii) As soon as practicable but not more than forty (40) days after the end of each calendar quarter that this Agreement is in effect (or more frequently as mutually agreed by the parties), the Administrator shall report to the Company the amount of statutory reserves that the Company is required to maintain in connection with the Insurance Contracts as of the quarter end.
- (iv) The Administrator shall timely provide notice to the Company of any changes in the reserve methodology used by the Administrator in calculating statutory reserves for the Insurance Contracts.

Section 8.3. Additional Reports and Updates. For so long as this Agreement remains in effect, each party shall periodically furnish to the other such other reports and information as may be reasonably required by such other party for regulatory, tax or similar purposes and reasonably available to it.

### ARTICLE IX

#### BOOKS AND RECORDS

The Administrator shall maintain accurate and complete books, records, files and accounts of all transactions and matters with respect to the Insurance Contracts and the administration thereof in accordance with (i) Applicable Law, and (ii) its record management practices in effect from time to time for the Administrator's insurance business not covered by this Agreement. The books and records must be maintained for the term of this Agreement or for as long thereafter as any rights or obligations of any party survives or the Administrator reasonably needs access to such records for regulatory, tax or similar purposes. The Administrator shall maintain the confidentiality of such books and records, including compliance with Article XI. All such books and records pertaining to an Insurance Contract shall be the property of the Company and shall be made available to the Company, its auditors or other designees, and regulatory agencies, during normal business hours and at any other time on reasonable notice, for review, audit, inspection, examination and reproduction.

The parties to this Agreement and their designated representatives may upon reasonable notice inspect, at the offices of the Administrator or the Company where such records are located, the papers and any and all other books or documents of the Administrator or the Company reasonably relating to this Agreement, including the Insurance Contracts, and shall

9

---

have access to appropriate employees and representatives of the other party, in each case during normal business hours for such period as this Agreement is in effect or for as long thereafter as any rights or obligations of any party survives or the Administrator or the Company reasonably need access to such records for regulatory, tax or similar purposes. The information obtained shall be used only for purposes relating to the transactions contemplated under this Agreement.

### ARTICLE X

#### COOPERATION

Each party hereto shall cooperate fully with the other in all reasonable respects in order to accomplish the objectives of this Agreement including making available to each their respective officers and employees for interviews and meetings with Governmental Authorities and furnishing any additional assistance, information and documents as may be reasonably requested by a party from time to time.

## ARTICLE XI

### PRIVACY REQUIREMENTS

In providing the Administrative Services provided for under this Agreement, and in connection with maintaining, administering, handling and transferring the data of the policyholders and other recipients of benefits under the Insurance Contracts, the Administrator shall, and shall cause its Affiliates and any permitted Subcontractors to, comply with all confidentiality and security obligations applicable to them, in connection with the collection, use, disclosure, maintenance and transmission of personal, private, health or financial information about individual policyholders or benefit recipients, including the provisions of privacy policies under which such information was gathered, those laws currently in place and which may become effective during the term of this Agreement, including the Gramm-Leach-Bliley Act, the Health Insurance Portability and Accountability Act of 1996 and any other Applicable Laws. The Administrator shall entitle the Company and its agents and representatives, the Commissioner of Health and Human Services and such other Governmental Authorities to the extent required by Applicable Law, to audit the Administrator's compliance herewith. The Administrator shall also enable individual subjects of personally identifiable information, upon request from such individuals, to review and correct information maintained by the Administrator about them, and to restrict use of such information. The Administrator shall promptly report to the Company any violation of this provision of which the Administrator becomes aware. Unless required by Applicable Law, the Administrator shall not during the term of this Agreement, modify the privacy policies under which information utilized by the Administrator in administering the Insurance Contracts is gathered, without the Company's prior written consent, which consent shall not be unreasonably withheld. The parties hereto agree to comply with the terms of the Business Associate Addendum attached as Schedule B hereto.

10

---

## ARTICLE XII

### CONSIDERATION FOR ADMINISTRATIVE SERVICES

As reimbursement for expenses incurred by the Administrator in the providing the Administrative Services with respect to the Insurance Contracts, the Company shall pay to the Administrator with respect to each calendar month ending after the Effective Date, an expense allowance (the "Expense Allowance"). The Expense Allowance shall be: (i) the actual incurred cost of providing the Administrative Services based on the allocated portion of compensation and benefits of the associates providing such services calculated annually in advance (and pro rated) in accordance with Schedule C (the "Service Costs"); (ii) a proportionate share of overhead related to such Administrative Services (the "Overhead Expenses"); and (iii) all third party expenses incurred in connection with the provision of such Administrative Services, including without limitation all categories of services contracted with third parties as of the Effective Date, such as legal and claim investigation, but excluding services for which Service Costs and Overhead Expenses are charged (the "Direct Expenses"). Such Expense Allowance shall be determined as set forth in Schedule C. The procedures for the billing and payment of the Expense Allowance are set forth in Schedule C. Additionally, the Administrator shall be reimbursed for any unforeseen costs arising from a change in Applicable Law, with the parties mutually agreeing to the payment of such costs in advance of their being incurred by the Administrator. The Administrator shall also be reimbursed for any incurred Direct Expenses for any category of services not contracted with third parties as of the Effective Date but contracted for thereafter, provided that the Company consents to the Administrator entering into third party contracts for such category of services.

## ARTICLE XIII

### INDEMNIFICATION

Section 13.1. Indemnification. (a) For any indemnification under this Article XIII, a party with the obligation to indemnify shall have the right to cure any underlying cause of Damage and/or to mitigate such Damage. As used in this Article XIII, "Damage" and/or "Damages" shall mean losses, liabilities, costs, claims, causes of action, demands, settlements, damages including compensatory, extra contractual and punitive damages, fines, penalties and expenses (including reasonable attorneys' fees and expenses).

(b) The Administrator agrees to indemnify and hold harmless the Company and any of its directors, officers, employees, agents, representatives and affiliates (and the directors, officers, employees, agents and representatives of such affiliates) from any and all Damages arising out of or caused by any actual or alleged: (i) fraud, theft or embezzlement by directors, officers, employees, agents, subcontractors, successors or assigns of the Administrator during the term of this Agreement; (ii) failure, either intentional or unintentional, of the Administrator to properly perform the services or take the actions required by this Agreement, including the failure to properly process, evaluate and pay claims or to comply with disbursement requests in accordance with the terms of this Agreement; (iii) acts of gross negligence or willful misconduct committed by directors, officers, employees, agents, subcontractors, successors or assigns of the Administrator during the term of this Agreement; or

11

---

(iv) failure of the Administrator to comply with Applicable Laws, rules and regulations during the term of this Agreement.

(c) The Company agrees to indemnify and hold harmless the Administrator and any of its directors, officers, employees, agents, representatives and affiliates (and the directors, officers, employees, agents and representatives of such affiliates) from any and all Damages arising out of or caused by any actual or alleged: (i) fraud, theft or embezzlement by directors, officers, employees, agents, successors or assigns of the Company during the term of this Agreement; (ii) acts of negligence or willful misconduct committed by directors, officers, employees, agents, successors or assigns of the Company during the term of this Agreement; or (iii) failure of the Company to comply with Applicable Laws, rules and regulations during the term of this Agreement other than any failure on the part of the Company caused by the action or inaction of the Administrator, including when acting in the name or on behalf of the Company, whether or not in compliance with the terms of this Agreement.

Section 13.2. Indemnification Procedures. (a) In order for a party (the "Indemnified Party") to be entitled to any indemnification provided for under this Agreement in respect of, arising out of or involving a claim or demand made by, or an action, proceeding or investigation instituted by, any Person not a party to this Agreement (a "Third Party Claim"), such Indemnified Party must notify the other party (the "Indemnifying Party") in writing, and in reasonable detail, of the Third Party Claim within ten (10) Business Days after such Indemnified Party learns of the Third Party Claim; provided, however, that failure to give such notification shall not affect the indemnification provided hereunder except to the extent the Indemnifying Party shall have been actually prejudiced as a result of such failure (except that the Indemnifying



Party shall not be liable for any expenses incurred during the period in which the Indemnified Party failed to give such notice). Thereafter, the Indemnified Party shall deliver to the Indemnifying Party, within five (5) Business Days after the Indemnified Party's receipt thereof, copies of all notices and documents (including court papers) received by the Indemnified Party relating to the Third Party Claim.

(b) If a Third Party Claim is made against an Indemnified Party, the Indemnifying Party will be entitled to participate in the defense thereof and, if it so chooses, to assume the defense thereof with counsel selected by the Indemnifying Party. If the Indemnifying Party assumes such defense, the Indemnified Party shall have the right to participate in the defense thereof and to employ counsel, at its own expense, separate from the counsel employed by the Indemnifying Party. If the Indemnifying Party chooses to defend or prosecute any Third Party Claim, all of the parties hereto shall cooperate in the defense or prosecution thereof. Such cooperation shall include the retention and (upon the Indemnifying Party's request) the provision to the Indemnifying Party of records and information which are reasonably relevant to such Third Party Claim, and making employees available on a mutually convenient basis to provide additional information and explanation of any material provided hereunder. Whether or not the Indemnifying Party shall have assumed the defense of a Third Party Claim, the Indemnifying Party shall have no liability with respect to any compromise or settlement of such claims effected without its written consent (such consent not to be unreasonably withheld); the Indemnifying Party shall not admit any liability with respect to, or settle, compromise or discharge, such Third Party Claim without the Indemnified Party's prior written consent (which consent shall not be unreasonably withheld or delayed) unless (A) there is no finding or admission of any violation of

12

---

law or any violation of the rights of any Person and no effect on any other claims that may be made against the Indemnified Party, or (B) the sole relief provided is monetary damages that are paid in full by the Indemnifying Party and a full and complete release is provided to the Indemnified Party.

(c) The provisions of this Article XIII shall survive the termination of this Agreement. The indemnity provided in Sections 13.1(b) and 13.1(c) shall be the sole and exclusive remedy of the Indemnified Party against the Indemnifying Party at law or equity for any matter covered by such Sections.

(d) The amount of any Damages or other liability for which indemnification is provided under this Agreement shall be (i) increased to take account of any Tax cost incurred (grossed up for such increase) by the Indemnified Party arising from the receipt of indemnity payments hereunder and (ii) reduced to take account of any Tax benefit realized by the Indemnified Party arising from the incurrence or payment of any such damages or other liability. Such Tax cost or Tax benefit, as the case may be, shall be computed for any year using the maximum current U.S. federal corporate income tax rate as provided in Section 11 of the Code or a successor section of the Code.

Section 13.3. Procedures for Direct Claims. In the event any Indemnified Party shall have a claim for indemnity against any Indemnifying Party that does not involve a Third Party Claim (a "Direct Claim"), the Indemnified Party shall promptly deliver notice of such claim to the Indemnifying Party. Such notice referred to in the preceding sentence shall state the relevant facts and include therewith relevant documents and a statement in reasonable detail as to the basis for the indemnification sought. The failure by any Indemnified Party so to notify the Indemnifying Party in a timely manner shall not be deemed a waiver of the Indemnified Party's right to indemnification with respect to any claim made pursuant to this Section 13.3, other than to the extent that such failure actually prejudices the Indemnifying Party.

Section 13.4. Limited Liability. Notwithstanding the provisions of Article XIII, the Administrator and its Subsidiaries and Affiliates and their respective directors, officers or employees (or any of the heirs, executors, successors or assigns of any of the foregoing) (each, a "Service Provider") shall have no liability to the Company or its Subsidiaries and Affiliates in excess of \$900,000 in the aggregate annually (as measured from the Effective Date or the most recent anniversary of the Effective Date, whichever is later), for any and all claims in contract, tort or otherwise for or in connection with any breach of its obligations under this Agreement; provided, however, that such limitation on liability shall not extend to or otherwise limit any liabilities that result directly from such Service Provider's gross negligence or willful misconduct; provided further that the Company shall be entitled to indemnification only to the extent that the aggregate amount of such claims annually (as measured from the Effective Date or the most recent anniversary of the Effective Date, whichever is later) exceeds \$25,000 (other than to the extent that such claims arise from the gross negligence or willful misconduct of the Administrator); provided further if the Company, including the Service Manager, provides direction to the Administrator pursuant to Section 3.4, the Company shall not be entitled to indemnification (and the Administrator shall have no liability) to the extent the Damage arises from the Administrator following such direction.

13

---

## ARTICLE XIV

### DURATION; TERMINATION

Section 14.1. Duration. This Agreement shall commence on the Effective Date and continue for two (2) years (the "Term"), unless terminated earlier pursuant to the terms of this Agreement. This Agreement shall automatically renew for one year terms (each a "Renewal Term"). The Company shall have the right to terminate this Agreement at the end of the Term or a Renewal Term, upon providing the Administrator with written notice of such termination not less than ninety (90) days prior to the end of the Term or the applicable Renewal Term. The Company shall bear all transition costs associated with the expiration of this Agreement and an assumption of the administration of the Insurance Contracts by the Company at the end of the term of this Agreement.

Section 14.2. Termination. (a) This Agreement will terminate in its entirety on the earlier of:

- (i) the date the Company's liability under all of the Insurance Contracts is terminated in accordance with the terms thereof; or
- (ii) a termination pursuant to Sections 14.2(b), (c), (d) or (e).

(b) The Company shall have the right, upon written notice to the Administrator, to terminate this Agreement and assume from the Administrator, the administration of the Insurance Contracts upon the occurrence of any of the following events:

- (i) A voluntary or involuntary proceeding is commenced in any jurisdiction by or against the Administrator for the purpose of conserving, rehabilitating or liquidating the Administrator;
- (ii) There is a material breach by the Administrator of any material term or condition of this Agreement that is not cured by the Administrator within thirty (30) days after receipt of written notice from the Company of such breach or act (provided that the Company shall not have the right to terminate this Agreement (A) for so long as the Administrator is making a good faith effort to cure such breach, not to exceed an additional one hundred eighty (180) days or (B) during the pendency of any dispute resolution proceedings as set forth in Article XV regarding an alleged material breach); or

(iii) The Administrator is unable to perform the services required under this Agreement for a period of thirty (30) consecutive days for any reason other than as a result of a Force Majeure, it being understood that nothing in this Section 14.2(b)(iii) shall relieve the Administrator from its administrative responsibilities under this Agreement.

(c) The Administrator shall have the right, upon written notice to the Company, to terminate this Agreement upon the occurrence of any of the following events:

14

---

(i) A voluntary or involuntary proceeding is commenced in any jurisdiction by or against the Company for the purpose of conserving, rehabilitating or liquidating the Company; or

(ii) There is a material breach by the Company of any material term or condition of this Agreement that is not cured by the Company within thirty (30) days after receipt of written notice from the Administrator of such breach or act (provided that the Administrator shall not have the right to terminate this Agreement (A) for so long as the Company is making a good faith effort to cure such breach, not to exceed an additional one hundred eighty (180) days or (B) during the pendency of any dispute resolution proceedings as set forth in Article XV regarding an alleged material breach).

(d) This Agreement may be terminated at any time upon the mutual written consent of the parties hereto, which writing shall state the effective date of termination.

(e) This Agreement may be terminated if the Company elects not to seek a Renewal Term in accordance with Section 14.1.

(f) The Administrator shall bear all transition costs associated with the assumption of the administration of the Insurance Contracts pursuant to Section 14.2(b). The Company shall bear all transition costs associated with the assumption of the administration of the Insurance Contracts pursuant to Section 14.2(c).

Section 14.3. Transfer of Books and Records. In the event that this Agreement is terminated, the Administrator shall cooperate fully in the transfer of services and the books and records maintained by the Administrator pursuant to this Agreement (or, where appropriate, copies thereof) to the third-party administrator or to the Company, so that such third-party administrator or the Company, as the case may be, will be able to perform the services required under this Agreement without interruption following termination of this Agreement.

## ARTICLE XV

### DISPUTE RESOLUTION

Section 15.1. General Provisions. (a) Any dispute, controversy or claim arising out of or relating to this Agreement or the validity, interpretation, breach or termination thereof (a "Dispute"), shall be resolved in accordance with the procedures set forth in this Article XV, which shall be the sole and exclusive procedures for the resolution of any such Dispute unless otherwise specified below.

(b) Commencing with the request contemplated by Section 15.2, all communications between the parties or their representatives in connection with the attempted resolution of any Dispute, including any mediator's evaluation referred to in Section 15.3, shall be deemed to have been delivered in furtherance of a Dispute settlement and shall be exempt from discovery and production, and shall not be admissible in evidence for any reason (whether

15

---

as an admission or otherwise), in any arbitral or other proceeding for the resolution of the Dispute.

(c) In connection with any Dispute, the parties expressly waive and forego any right to (i) punitive, exemplary, statutorily-enhanced or similar damages in excess of compensatory damages (provided that any such liability with respect to a Third Party Claim (as defined in the Master Agreement) shall be considered direct damages), and (ii) trial by jury.

(d) The specific procedures set forth below, including but not limited to the time limits referenced therein, may be modified by agreement of the parties in writing.

(e) All applicable statutes of limitations and defenses based upon the passage of time shall be tolled while the procedures specified in this Article XV are pending. The parties will take such action, if any, required to effectuate such tolling.

Section 15.2. Consideration by Senior Executives. If a Dispute is not resolved in the normal course of business at the operational level, the parties shall attempt in good faith to resolve such Dispute by negotiation between executives who hold, at a minimum, the office of President and CEO of the respective business entities involved in such Dispute. Either party may initiate the executive negotiation process by providing a written notice to the other (the "Initial Notice"). Fifteen (15) days after delivery of the Initial Notice, the receiving party shall submit to the other a written response (the "Response"). The Initial Notice and the Response shall include (i) a statement of the Dispute and of each party's position, and (ii) the name and title of the executive who will represent that party and of any other person who will accompany the executive. Such executives will meet in person or by telephone within thirty (30) days of the date of the Initial Notice to seek a resolution of the Dispute.

Section 15.3. Mediation. If a Dispute is not resolved by negotiation as provided in Section 15.2 within forty-five (45) days from the delivery of the Initial Notice, then either party may submit the Dispute for resolution by mediation pursuant to the CPR Institute for Dispute Resolution (the "CPR") Model Mediation Procedure as then in effect. The parties will select a mediator from the CPR Panels of Distinguished Neutrals, but such mediator must have prior U.S. reinsurance experience either as a lawyer or as a present or former officer or management employee of a reinsurance company, but not of the Company, or the Administrator, or any of their respective affiliates. Either party at commencement of the mediation may ask the mediator to provide an evaluation of the Dispute and the parties' relative positions.

Section 15.4. Arbitration. (a) If a Dispute is not resolved by mediation as provided in Section 15.3 within thirty (30) days of the selection of a mediator (unless the mediator chooses to withdraw sooner), either party may submit the Dispute to be finally resolved by arbitration pursuant to the CPR Rules for Non-Administered Arbitration as then in effect (the "CPR Arbitration Rules"). The parties consent to a single, consolidated arbitration for all known Disputes existing at the time of the arbitration and for which arbitration is permitted.

(b) The neutral organization for purposes of the CPR Arbitration Rules will be the CPR. The arbitral tribunal shall be composed of three arbitrators who are each experienced in the U.S. reinsurance business, of whom each party shall appoint one in accordance with the

“screened” appointment procedure provided in Rule 5.4 of the CPR Arbitration Rules. The non-party appointed arbitrator must have prior U.S. reinsurance experience as a present or former officer or management employee of a reinsurance company, but not of the Company, or the Administrator, or any of their respective affiliates. The arbitration shall be conducted in New York City. Each party shall be permitted to present its case, witnesses and evidence, if any, in the presence of the other party. A written transcript of the proceedings shall be made and furnished to the parties. The arbitrators shall determine the Dispute in accordance with the law of Illinois, without giving effect to any conflict of law rules or other rules that might render such law inapplicable or unavailable, and shall apply this Agreement according to its terms, provided that the provisions relating to arbitration shall be governed by the Federal Arbitration Act, 9 U.S.C. §§ 1 et seq. The arbitral tribunal shall endeavor to render its award or order resulting from any arbitration within forty-five (45) days following the termination of the arbitration proceedings.

(c) The parties agree to be bound by any award or order resulting from any arbitration conducted hereunder and further agree that judgment on any award or order resulting from an arbitration conducted under this Section 15.4 may be entered and enforced in any court having jurisdiction thereof.

(d) Except as expressly permitted by this Agreement, no party will commence or voluntarily participate in any court action or proceeding concerning a Dispute, except (i) for enforcement as contemplated by Section 15.4(c) above, (ii) to restrict or vacate an arbitral decision based on the grounds specified under applicable law, or (iii) for interim relief as provided in paragraph (e) below. For purposes of the foregoing the parties hereto submit to the non-exclusive jurisdiction of the courts of the State of New York.

(e) In addition to the authority otherwise conferred on the arbitral tribunal, the tribunal shall have the authority to make such orders for interim relief, including injunctive relief, as it may deem just and equitable. Notwithstanding paragraph (d) above, each party acknowledges that in the event of any actual or threatened breach of certain of the provisions of this Agreement, the remedy at law would not be adequate, and therefore injunctive or other interim relief may be sought immediately to restrain such breach. If the tribunal shall not have been appointed, either party may seek interim relief from a court having jurisdiction if the award to which the applicant may be entitled may be rendered ineffectual without such interim relief. Upon appointment of the tribunal following any grant of interim relief by a court, the tribunal may affirm or disaffirm such relief, and the parties will seek modification or rescission of the court action as necessary to accord with the tribunal’s decision.

(f) Each party will bear its own attorneys fees and costs incurred in connection with the resolution of any Dispute in accordance with this Article XV.

ARTICLE XVI

MISCELLANEOUS PROVISIONS

Section 16.1. Headings and Schedules. Headings used herein are not a part of this Agreement and shall not affect the terms hereof. The attached Schedules are a part of this Agreement.

Section 16.2. Notices. All notices, requests, demands and other communications under this Agreement must be in writing and will be deemed to have been duly given or made as follows: (a) if sent by registered or certified mail in the United States return receipt requested, upon receipt; (b) if sent by reputable overnight air courier, two business days after mailing; (c) if sent by facsimile transmission, with a copy mailed on the same day in the manner provided in (a) or (b) above, when transmitted and receipt is confirmed by telephone; or (d) if otherwise actually personally delivered, when delivered, and shall be delivered as follows:

If to the Administrator:

[                    ]  
[                    ]  
[                    ]  
Facsimile: [                    ]  
Attention: [                    ]

With a copy to:

[                    ]  
[                    ]  
[                    ]  
Facsimile: [                    ]  
Attention: [                    ]

If to the Company:

Union Fidelity Life Insurance Company  
200 North Martingale Road  
Shaumburg, IL 60173-2096  
Facsimile: (847) 330-3404  
Attention: Chief Financial Officer

With a copy to:

Union Fidelity Life Insurance Company  
200 North Martingale Road  
Shaumburg, IL 60173-2096

or to such other address or to such other Person as either party may have last designated by notice to the other party.

Section 16.3. Successors and Assigns. This Agreement shall be binding upon and inure to the benefit of the parties hereto and their respective successors, permitted assigns and legal representatives. Neither this Agreement, nor any right or obligation hereunder, may be assigned by any party without the prior written consent of the other party hereto. Any assignment in violation of this Section 16.3 shall be void and shall have no force and effect.

Section 16.4. Execution in Counterpart. This Agreement may be executed by the parties hereto in any number of counterparts, and by each of the parties hereto in separate counterparts, each of which counterparts, when so executed and delivered, shall be deemed to be an original, but all such counterparts shall together constitute but one and the same instrument.

Section 16.5. Currency. Whenever the word "Dollars" or the "\$" sign appear in this Agreement, they shall be construed to mean United States Dollars, and all transactions under this Agreement shall be in United States Dollars.

Section 16.6. Amendments. This Agreement may not be changed, altered or modified unless the same shall be in writing executed by the Company and the Administrator. Notwithstanding the immediately preceding sentence, the effectiveness of any amendment to this Agreement is conditioned upon approval of the Connecticut Department of Insurance and the Illinois Department of Insurance, if required, and any such other Governmental Authority whose prior approval is required by Applicable Law.

Section 16.7. Governing Law. This Agreement will be construed, performed and enforced in accordance with the laws of the State of Illinois without giving effect to its principles or rules of conflict of laws thereof to the extent such principles or rules would require or permit the application of the laws of another jurisdiction.

Section 16.8. Entire Agreement; Severability. (a) This Agreement constitutes the entire agreement between the parties hereto relating to the subject matter hereof and supersedes all prior and contemporaneous agreements, understandings, statements, representations and warranties, negotiations and discussions, whether oral or written, of the parties and there are no general or specific warranties, representations or other agreements by or among the parties in connection with the entering into of this Agreement or the subject matter hereof except as specifically set forth or contemplated herein.

(b) If any provision of this Agreement is held to be void or unenforceable, in whole or in part, (i) such holding or provision shall not affect the validity and enforceability of the remainder of this Agreement, including any other provision, paragraph or subparagraph, and (ii) the parties agree to attempt in good faith to reform such void, unenforceable or violative provision to the extent necessary to render such provision enforceable and to carry out its original intent.

Section 16.9. No Waiver; Preservation of Remedies. No consent or waiver, express or implied, by any party to or of any breach or default by any other party in the performance by such other party of its obligations hereunder shall be deemed or construed to be a consent or

waiver to or of any other breach or default in the performance of obligations hereunder by such other party hereunder. Failure on the part of any party to complain of any act or failure to act of any other party or to declare any other party in default, irrespective of how long such failure continues, shall not constitute a waiver by such first party of any of its rights hereunder. The rights and remedies provided are cumulative and are not exclusive of any rights or remedies that any party may otherwise have at law or equity.

Section 16.10. Third Party Beneficiary. Nothing in this Agreement will confer any rights upon any Person that is not a party or a successor or permitted assignee of a party to this Agreement.

Section 16.11. Negotiated Agreement. This Agreement has been negotiated by the parties and the fact that the initial and final draft will have been prepared by either party or an intermediary will not give rise to any presumption for or against any party to this Agreement or be used in any respect or forum in the construction or interpretation of this Agreement or any of its provisions.

Section 16.12. Tax Exception to Any Confidentiality. Notwithstanding anything to the contrary set forth herein or in any other agreement to which the parties hereto are parties or by which they are bound, any obligations of confidentiality contained herein and therein, as they relate to the transactions, shall not apply to the federal tax structure or federal tax treatment of the transactions, and each party hereto (and any employee, representative, or agent of any party hereto) may disclose to any and all persons, without limitation of any kind, the federal tax structure and federal tax treatment of the transactions. The preceding sentence is intended to cause the transactions to be treated as not having been offered under conditions of confidentiality for purposes of Section 1.6011-4(b)(3) (or any successor provision) of the Treasury Regulations promulgated under Section 6011 of the Internal Revenue Code of 1986, as amended, and shall be construed in a manner consistent with such purpose. In addition, each party hereto acknowledges that it has no proprietary or exclusive rights to the federal tax structure of the transactions or any federal tax matter or federal tax idea related to the transactions.

Section 16.13. Errors and Omissions. If any delay, omission, error or failure to pay amounts due or to perform any other act required by this Agreement is unintentional and caused by misunderstanding or oversight, the Company and the Administrator will adjust the situation to what it would have been had the misunderstanding or oversight not occurred. The party first discovering such misunderstanding or oversight, or an act resulting from such misunderstanding or oversight, will notify the other party in writing promptly upon discovery thereof, and the parties shall act to correct such misunderstanding or oversight within twenty (20) Business Days of such other party's receipt of such notice. However, this Section shall not be construed as a waiver by either party of its right to enforce strictly the terms of this Agreement.

Section 16.14. Interpretation. Wherever the words "include," "includes" or "including" are used in this Agreement, they shall be deemed to be followed by the words "without limitation."

Section 16.15. Survival. Articles XI, XIII, XV and XVI shall survive the termination of this Agreement.

IN WITNESS WHEREOF, the Company and the Administrator have executed this Agreement as of the date first above written.

UNION FIDELITY LIFE INSURANCE COMPANY

By: \_\_\_\_\_

Name:  
Title:

GE GROUP LIFE ASSURANCE COMPANY

By: \_\_\_\_\_

Name:  
Title:

SCHEDULE A

INSURANCE CONTRACTS

Insurance Contracts include:

1. All individual and group insurance contracts underwritten or formerly administered by the Company through its Worksite Service Group at the Company's offices in Trevoze, Pennsylvania and Fort Washington Pennsylvania and for which administration was transferred to the Administrator at its offices in Enfield, Connecticut and Greenfield, Massachusetts prior to or contemporaneous with the execution of this Agreement; and

2. Those reinsurance agreements identified below:

Ceding Company/Pool	Product Line	Assuming Company	Effective Date and Renewal Date
AARG I	Special Risk	CICA	12/01/74
AARG II	Special Risk	CICA	09/01/79
AARG III	Special Risk	CICA	04/01/82
London Market Excess (LMX)	Special Risk	CICA	01/01/94
NOMAD (AARG)	Special Risk	CICA → UFLIC <sup>1</sup>	07/01/90
CAN	Special Risk	CICA → UFLIC	11/01/94
GroupAmerica, Trans-General, Highmark → American United Life	LTD	CICA → UFLIC	07/15/94
CICA	All Group, Direct and Assumed	UFLIC	04/01/96
Union Central	Texas Occupational Accident	CICA	11/01/94
CICA	Texas Occupational Accident	Union Central	11/01/94
CICA	Texas Occupational Accident	AARG/SARF	11/01/94
CICA	Student Accident	M&G → Swiss Re	08/01/97
CICA	Student Accident	M&G → Swiss Re	08/15/97
CICA	Student Accident	Swiss Re	08/01/98
UFLIC and GEGLAC	LTD	General & Cologne Re	01/01/00
CICA	LTD	NA Re → Swiss Re	10/01/90

<sup>1</sup> An arrow ("→") indicates the company to which the particular reinsurance agreements were ceded or retroceded.

Ceding Company/Pool	Product Line	Assuming Company	Effective Date and Renewal Date
CICA	LTD	NA Re → Swiss Re	03/01/90
CICA	LTD	Gen Re → Life Re → Swiss Re	11/01/86
CICA → UFLIC	Life	NA Re → Swiss Re	01/01/89
UFLIC	Vol Life	Swiss Re	01/01/97
CICA → UFLIC	AD&D	NA Re → Swiss Re	01/01/89
UFLIC	Vol AD&D	Swiss Re	01/01/97
CICA	All Group	NA Re → Swiss Re	01/01/91
CICA	Life	Gen Re → Life Re → Swiss Re	11/01/77
CICA	AD&D	Gen Re → Life Re → Swiss Re	01/01/80
CICA	Life	Gen Re → Life Re → Swiss Re	10/01/79
UFLIC	LTD	ReliaStar → ING Re	01/01/97

ASSUMED LTD AGREEMENTS:

American Bankers Life	LTD	CICA	10/01/83
Reliance Standard Life	LTD	CICA	11/01/92
First Reliance Standard Life	LTD (NY)	CICA	10/01/93
Life of Virginia	LTD	CICA	04/01/87
Life of Virginia	LTD (MET)	CICA	04/01/87
Gulf Life —> Alta Life	LTD	CICA	10/01/76
Community Life	LTD	CICA	05/01/79
Educators Mutual Life	LTD	CICA	
Capitol Life, Idea Life	LTD	CICA	
Corporate Life, American Guardian —> Jefferson Pilot	LTD	CICA	

SCHEDULE B

BUSINESS ASSOCIATE ADDENDUM

I. Purpose.

In order to disclose certain information to Administrator (for purpose of this Addendum, the “Provider”) under this Addendum, some of which may constitute Protected Health Information (defined below), the Company (for purposes of this Addendum, the “Recipient”) and Provider mutually agree to comply with the terms of this Addendum for the purpose of satisfying the requirements of the Health Insurance Portability and Accountability Act of 1996 (“HIPAA”) and its implementing privacy regulations at 45 C.F.R. Parts 160-164 (“HIPAA Privacy Rule”). These provisions shall apply to Provider to the extent that Provider is considered a “Business Associate” under the HIPAA Privacy Rule and all references in this section to Business Associates shall refer to Provider. Capitalized terms not otherwise defined herein shall have the meaning assigned in the Agreement. Notwithstanding anything else to the contrary in the Agreement, in the event of a conflict between this Addendum and the Agreement, the terms of this Addendum shall prevail.

II. Permitted Uses and Disclosures.

A. Business Associate agrees to use or disclose Protected Health Information (“PHI”) that it creates for or receives from Recipient or its Subsidiaries only as follows. The capitalized term “Protected Health Information or PHI” has the meaning set forth in 45 Code of Federal Regulations Section 164.501, as amended from time to time. Generally, this term means individually identifiable health information including, without limitation, all information, data and materials, including without limitation, demographic, medical and financial information, that relates to the past, present, or future physical or mental health or condition of an individual; the provision of health care to an individual; or the past present, or future payment for the provision of health care to an individual; and that identifies the individual or with respect to which there is a reasonable basis to believe the information can be used to identify the individual. This definition shall include any demographic information concerning members and participants in, and applicants for, Recipient’s or its Subsidiaries’ health benefit plans. All other terms used in this Addendum shall have the meanings set forth in the applicable definitions under the HIPAA Privacy Rule.

B. Functions and Activities on Company’s Behalf. Business Associate is permitted to use and disclose PHI it creates for or receives from Recipient or its Subsidiaries only for the purposes described in this Addendum or the Agreement that are not inconsistent with the provisions of this Addendum, or as required by law, or following receipt of prior written approval from whichever of the Recipient or its Subsidiary for which the relevant PHI was created or from which the relevant PHI was received. In addition to these specific requirements below, Business Associate may use or disclose PHI only in a manner that would not violate the HIPAA Privacy Rule if done by the Recipient or its Subsidiaries.

C. Business Associate’s Operations. Business Associate is permitted by this Agreement to use PHI it creates for or receives from Recipient or its Subsidiaries: (i) if such use

is reasonably necessary for Business Associate’s proper management and administration; and (ii) as reasonably necessary to carry out Business Associate’s legal responsibilities. Business Associate is permitted to disclose PHI it creates for or receives from Recipient or its Subsidiaries for the purposes identified in this Section only if the following conditions are met:

(1) The disclosure is required by law; or

(2) The disclosure is reasonably necessary to Business Associate’s proper management and administration, and Business Associate obtains reasonable assurances in writing from any person or organization to which Business Associate will disclose such PHI that the person or organization will:

a. Hold such PHI as confidential and use or further disclose it only for the purpose for which Business Associate disclosed it to the person or organization or as required by law; and

b. Notify Business Associate (who will in turn promptly notify whichever of the Recipient or its Subsidiary for which the relevant PHI was created or from which the relevant PHI was received) of any instance of which the person or organization becomes aware in which the confidentiality of such PHI was breached.

D. Minimum Necessary Standard. In performing the functions and activities on Recipient’s or its Subsidiaries’ behalf pursuant to the Agreement, Business Associate agrees to use, disclose or request only the minimum necessary PHI to accomplish the purpose of the use, disclosure or request. Business Associate must have in place policies and procedures that limit the PHI disclosed to meet this minimum necessary standard.

E. Prohibition on Unauthorized Use or Disclosure. Business Associate will neither use nor disclose PHI it creates or receives for or from Recipient, its

Subsidiaries, or from another business associate of Recipient or its Subsidiaries, except as permitted or required by this Addendum or the Agreement that are not inconsistent with the provisions of this Addendum, or as required by law, or following receipt of prior written approval from whichever of the Recipient or its Subsidiary for which the relevant PHI was created or from which the relevant PHI was received.

F. De-identification of Information. Business Associate agrees neither to de-identify PHI it creates for or receives from Recipient or its Subsidiaries or from another business associate of Recipient or its Subsidiaries, nor use or disclose such de-identified PHI, unless such de-identification is expressly permitted under the terms and conditions of this Addendum or the Agreement and related to Recipient's or its Subsidiaries' activities for purposes of "treatment", "payment" or "health care operations", as those terms are defined under the HIPAA Privacy Rule. De-identification of PHI, other than as expressly permitted under the terms and conditions of the Addendum for Business Associate to perform services for Recipient or its Subsidiaries, is not a permitted use of PHI under this Addendum. Business Associate further agrees that it will not create a "Limited Data Set" as defined by the HIPAA Privacy Rule using PHI it creates or

2

---

receives, or receives from another business associate of Recipient or its Subsidiaries, nor use or disclose such Limited Data Set unless: (i) such creation, use or disclosure is expressly permitted under the terms and conditions of this Addendum or the Agreement that are not inconsistent with the provisions of this Addendum; and such creation, use or disclosure is for services provided by Business Associate that relate to Recipient's or its Subsidiaries' activities for purposes of "treatment", "payment" or "health care operations", as those terms are defined under the HIPAA Privacy Rule.

G. Information Safeguards. Business Associate will develop, document, implement, maintain and use appropriate administrative, technical and physical safeguards to preserve the integrity and confidentiality of and to prevent non-permitted use or disclosure of PHI created for or received from Recipient or its Subsidiaries. These safeguards must be appropriate to the size and complexity of Business Associate's operations and the nature and scope of its activities. Business Associate agrees that these safeguards will meet any applicable requirements set forth by the U.S. Department of Health and Human Services, including (as of the effective date or as of the compliance date, whichever is applicable) any requirements set forth in the final HIPAA security regulations. Business Associate agrees to mitigate, to the extent practicable, any harmful effect that is known to Business Associate resulting from a use or disclosure of PHI by Business Associate in violation of the requirements of this Addendum.

III. Conducting Standard Transactions. In the course of performing services for Recipient or its Subsidiaries, to the extent that Business Associate will conduct Standard Transactions for or on behalf of Recipient or its Subsidiaries, Business Associate will comply, and will require any subcontractor or agent involved with the conduct of such Standard Transactions to comply, with each applicable requirement of 45 C.F.R. Part 162. "Standard Transaction(s)" shall mean a transaction that complies with the standards set forth at 45 C.F.R. parts 160 and 162. Further, Business Associate will not enter into, or permit its subcontractors or agents to enter into, any trading partner agreement in connection with the conduct of Standard Transactions for or on behalf of the Recipient or its Subsidiaries that:

- a. Changes the definition, data condition, or use of a data element or segment in a Standard Transaction;
- b. Adds any data element or segment to the maximum defined data set;
- c. Uses any code or data element that is marked "not used" in the Standard Transaction's implementation specification or is not in the Standard Transaction's implementation specification; or
- d. Changes the meaning or intent of the Standard Transaction's implementation specification.

IV. Sub-Contractors, Agents or Other Representatives. Business Associate will require any of its subcontractors, agents or other representatives to which Business Associate is permitted by this Addendum or the Agreement (or is otherwise given Recipient's or the relevant Subsidiary's prior written approval) to disclose any of the PHI Business Associate creates or receives for or from Recipient or its Subsidiaries, to provide reasonable assurances in writing that subcontractor

3

---

or agent will comply with the same restrictions and conditions that apply to the Business Associate under the terms and conditions of this Addendum with respect to such PHI.

V. Protected Health Information Access, Amendment and Disclosure Accounting.

A. Access. Business Associate will promptly upon Recipient's or its Subsidiary's request make available to Recipient, its Subsidiary, or, at Recipient's or such Subsidiary's direction, to the individual (or the individual's personal representative) for inspection and obtaining copies any PHI about the individual which Business Associate created for or received from Recipient or its Subsidiary and that is in Business Associate's custody or control, so that Recipient or its Subsidiary may meet its access obligations under 45 Code of Federal Regulations § 164.524.

B. Amendment. Upon Recipient's or its Subsidiary's request Business Associate will promptly amend or permit Recipient or its Subsidiary access to amend any portion of the PHI which Business Associate created for or received from Recipient or its Subsidiary, and incorporate any amendments to such PHI, so that Recipient or its Subsidiary may meet its amendment obligations under 45 Code of Federal Regulations § 164.526.

C. Disclosure Accounting. So that Recipient or its Subsidiaries may meet their disclosure accounting obligations under 45 Code of Federal Regulations § 164.528:

1. Disclosure Tracking. Business Associate will record for each disclosure, not excepted from disclosure accounting under Section V.C.2 below, that Business Associate makes to Recipient or its Subsidiaries of PHI that Business Associate creates for or receives from Recipient or its Subsidiaries, (i) the disclosure date, (ii) the name and member or other policy identification number of the person about whom the disclosure is made, (iii) the name and (if known) address of the person or entity to whom Business Associate made the disclosure, (iv) a brief description of the PHI disclosed, and (v) a brief statement of the purpose of the disclosure (items i-v, collectively, the "disclosure information"). For repetitive disclosures Business Associate makes to the same person or entity (including Recipient or its Subsidiaries) for a single purpose, Business Associate may provide a) the disclosure information for the first of these repetitive disclosures, (b) the frequency, periodicity or number of these

repetitive disclosures and (c) the date of the last of these repetitive disclosures. Business Associate will make this disclosure information available to Recipient or its Subsidiaries promptly upon Recipient's or its Subsidiaries' request.

2. Exceptions from Disclosure Tracking. Business Associate need not record disclosure information or otherwise account for disclosures of PHI that this Addendum or Recipient or the relevant Subsidiary in writing permits or requires (i) for the purpose of Recipient's or its Subsidiaries' treatment activities, payment activities, or health care operations, (ii) to the individual who is the subject of the PHI disclosed or to that individual's personal representative; (iii) to persons involved in that individual's health care or payment for health care; (iv) for notification for disaster relief purposes, (v) for national security or intelligence purposes, (vi) to law enforcement officials or correctional institutions regarding inmates; or (vii) pursuant to an authorization; (viii) for disclosures of certain PHI made as part of a Limited

4

---

Data Set; (ix) for certain incidental disclosures that may occur where reasonable safeguards have been implemented; and (x) for disclosures prior to April 14, 2003.

3. Disclosure Tracking Time Periods. Business Associate must have available for Recipient and its Subsidiaries the disclosure information required by this section for the 6 years preceding Recipient's or its Subsidiaries' request for the disclosure information (except Business Associate need have no disclosure information for disclosures occurring before April 14, 2003).

VI. Additional Business Associate Provisions

A. Reporting of Breach of Privacy Obligations. Business Associate will provide written notice to whichever of the Recipient or its Subsidiary for which the relevant PHI was created or from which the relevant PHI was received of any use or disclosure of PHI that is neither permitted by this Addendum nor given prior written approval by Recipient or the relevant Subsidiary promptly after Business Associate learns of such non-permitted use or disclosure. Business Associate's report will at least:

- (i) Identify the nature of the non-permitted use or disclosure;
- (ii) Identify the PHI used or disclosed;
- (iii) Identify who made the non-permitted use or received the non-permitted disclosure;
- (iv) Identify what corrective action Business Associate took or will take to prevent further non-permitted uses or disclosures;
- (v) Identify what Business Associate did or will do to mitigate any deleterious effect of the non-permitted use or disclosure; and
- (vi) Provide such other information, including a written report, as Recipient or the relevant Subsidiary may reasonably request.

B. Amendment. Upon the effective date of any final regulation or amendment to final regulations promulgated by the U.S. Department of Health and Human Services with respect to PHI, including, but not limited to the HIPAA privacy and security regulations, this Addendum and the Agreement will automatically be amended so that the obligations they impose on Business Associate remain in compliance with these regulations.

In addition, to the extent that new state or federal law requires changes to Business Associate's obligations under this Addendum, this Addendum shall automatically be amended to include such additional obligations, upon notice by Recipient or its Subsidiaries to Business Associate of such obligations. Business Associate's continued performance of services under the Agreement shall be deemed acceptance of these additional obligations.

C. Audit and Review of Policies and Procedures. Business Associate agrees to provide, upon Recipient request, access to and copies of any policies and procedures developed

5

---

or utilized by Business Associate regarding the protection of PHI. Business Associate agrees to provide, upon Recipient's request, access to Business Associate's internal practices, books, and records, as they relate to Business Associate's services, duties and obligations set forth in this Addendum and the Agreement(s) under which Business Associate provides services and/or products to or on behalf of Recipient or its Subsidiaries, for purposes of Recipient's or its Subsidiaries' review of such internal practices, books, and records.

6

---

SCHEDULE C

EXPENSE ALLOWANCE FOR ADMINISTRATIVE SERVICES

1. Calculation for 2004. The Service Costs and Overhead Expenses combined for calendar year 2004 are projected to be \$66,667 per month, and will be paid by Company at that rate, subject to paragraph 1(d) below of this Schedule C. Direct Expenses for 2004 are expected to be \$200,000.

- (a) Service Costs. Service Costs for 2004 were projected based on time studies during the fourth Quarter of 2003 for functions that directly support the ongoing servicing of the business. Examples of these functions include but are not limited to Claims Management, Actuarial Valuation, Finance, Legal and all other functions necessary and appropriate for the administration of the Insurance Contracts.
- (b) Overhead Expenses. Overhead Expenses, including all overhead related to relevant business and corporate functions, are and will be allocated to all product



lines. Corporate functions that are not associated with those product lines, such as business development, marketing, and sales are excluded. Expenses for the remaining business and corporate support functions are totaled and then allocated to the product lines based on reserves.

(c) Direct Expenses. Direct Expenses will be billed directly to Company at cost.

(d) True-up Procedure. At the time of the preparation of the Annual Study for 2005 (as set forth below in paragraph 2(a) of this Schedule C), a similar study shall be prepared for 2004 (the "2004 Study") and submitted to the Company in accordance with paragraph 2(a) of this Schedule C. The Company shall pay or be credited for, as the case may be, any differential between (i) the combined Service Costs and Overhead Expenses from \$66,667 per month for the period from the Effective Date of this Agreement until December 31, 2004 and (ii) the combined Service Costs and Overhead Expenses identified in the 2004 Study for the period from the Effective Date of this Agreement until December 31, 2004.

2. Methodology For Subsequent Years.

(a) Service Costs and Annual Expenses. Service Costs and Overhead Expenses will be adjusted for the year beginning January 1, 2005 and every year thereafter during the term of the Agreement based on an annual cost/time study (the "Annual Study"). The first Annual Study will be provided within sixty (60) days prior to January 1, 2005 and prior to the beginning of every calendar year thereafter during the term of this Agreement. The Administrator shall prepare and deliver to the Company the Annual Study setting forth the projected Service Costs and Overhead Expenses for the next calendar year, together with all supporting data used in preparing the Annual Study and work papers, in reasonable detail, setting forth the determination of such projected Service Costs and Overhead Expenses for the next calendar year. Following the delivery of the Annual Study, the Administrator shall (a) provide to the Company copies of such additional work papers and other documents relating to its preparation of the Annual Study as the Company or its designated representative may reasonably request, including,

7

---

without limitation, claims files and practices; and (b) cooperate with, and make its personnel and facilities reasonably available to, the Company and the Company's designated representative for the purpose of providing such other information as the Company or the Company's designated representative may reasonably request concerning Annual Study documents and the calculation of the projected Service Costs and Overhead Expenses. The Company shall pay the projected Service Costs and Overhead Expenses set forth in the Annual Study for the applicable calendar year (on a monthly basis as set forth herein), provided that in the event that the Company disputes the amount of the projected Service Costs and Overhead Expenses set forth in the Annual Study, then the dispute shall be resolved in accordance with Article XV of this Agreement.

(b) Direct Expenses. Direct Expenses will continue to be billed directly to the Company at cost.

3. Invoicing and Payments:

(a) Invoices. The Administrator shall submit an invoice to the Company on a monthly basis for the Services Costs and Overhead Expenses relating to the Administrative Services provided during the prior month. The Administrator shall include the information and prepare the invoice in the form as reasonably requested by the Company and agreed to by the Administrator. The Administrator shall submit to the Company, whether on a monthly basis or otherwise, an invoice for the Direct Expenses relating to the Administrative Services, together with copies of receipts and other verification agreed to by the parties, as the Administrator receives invoices for those Direct Expenses.

(b) Payments. All payments, due and payable by the Company to the Administrator, will be made within seventy-five (75) days of the Company's receipt of an invoice applicable to such payments ("Payment Date"). The Company shall use its good faith efforts to provide the Administrator as promptly as practicable with the details of any objection it may have to any invoice, but any failure to provide such details shall not foreclose the Company's right to dispute such invoice. The Company shall pay the part of any invoiced amount that is not in dispute by the Payment Date.

(c) Method of Payment. The method of payment shall be by electronic fund transfer to the Administrator's designated bank account or such other manner as agreed upon by the parties.

8

---

## SUBORDINATED CONTINGENT PROMISSORY NOTE

\$550,000,000

Dated: , 2004

FOR VALUE RECEIVED, the undersigned, GENWORTH FINANCIAL, INC., a Delaware corporation (the "**Company**") hereby promises, subject to Section 2, to pay to the order of GE FINANCIAL ASSURANCE HOLDINGS, INC., a Delaware corporation ("**GEFAHI**"), or to any other permitted holders of this Note (GEFAHI or such other holders being the "**Holders**"), the principal amount of FIVE HUNDRED FIFTY MILLION UNITED STATES DOLLARS (U.S. \$550,000,000) on the Maturity Date or, if applicable, the Extended Maturity Date. Principal hereunder is payable in lawful money of the United States of America to GEFAHI at its principal place of business at , or to any other Holder at such other place as such Holder may designate from time to time in writing (such principal place of business or other place being the "**Payment Place**"), in cash or other immediately available funds. Unless otherwise defined in the text of this Note, capitalized terms used herein shall have the meaning ascribed to such terms in Section 12.

SECTION 1. Interest. The principal amount of this Note shall not bear interest.

SECTION 2. Payment of Principal.

(a) Scheduled Payment on the Maturity Date. Subject to Section 2(c), on the Maturity Date, the Company shall pay to the Holders, in cash or other immediately available funds, the lowest of (i) the entire unpaid principal amount of this Note, (ii) if any Regulatory Approval or Rating Agency Affirmation obtained prior to the Maturity Date specifies a withdrawal or a dividend (whether ordinary or extraordinary) in an amount less than \$700,000,000, the excess of the lowest amount so specified over \$150,000,000, (iii) if any Rating Agency Affirmation obtained prior to the Maturity Date specifies the payment of the principal amount of this Note in an amount less than \$550,000,000, the amount so specified and (iv) if one or more of the Rating Agency Affirmations are not obtained prior to the Maturity Date, zero (such lesser amount, the "**Payment Amount**").

(b) Scheduled Payment on the Extended Maturity Date. On the Extended Maturity Date, the Company shall pay to the Holders, in cash or other immediately available funds, the lowest of (i) the Extended Payment Amount, (ii) if any Rating Agency Affirmation obtained after the Maturity Date specifies a withdrawal or a dividend (whether ordinary or extraordinary) in an amount less than the excess, if any, of (w) the amount specified in any Regulatory Approval for a withdrawal or dividend over (x) the amount specified in any Interim Rating Agency Affirmation for a withdrawal or a dividend (whether ordinary or extraordinary) (or zero, if one or more of the Rating Agency Affirmations are not obtained prior to the Maturity Date), the amount so specified less the excess of (y) \$150,000,000 over (z) the amount specified in any Interim

---

Rating Agency Affirmation (or zero, if one or more of the Rating Agency Affirmations are not obtained prior to the Maturity Date), (iii) if any Rating Agency Affirmation obtained after the Maturity Date specifies the payment of the principal amount of this Note in an amount less than the Extended Payment Amount, the amount so specified and (iv) if one or more of the Rating Agency Affirmations are not obtained prior to the Extended Maturity Date, zero.

(c) Mandatory Prepayment. If both the Regulatory Approvals and the Rating Agency Affirmations are obtained: (i) on or prior to October 31, 2004, any Holder may in its sole discretion, by written notice to the Company delivered on or prior to October 31, 2004, demand prepayment of the Payment Amount on December 31, 2004; or (ii) after October 31, 2004, but at least 60 days prior to the Maturity Date, any Holder may in its sole discretion, by written notice to the Company, demand prepayment of the Payment Amount on the date that is 60 days after the date of such notice so long as, on the date of such notice, such Holder believes in good faith that GEFAHI and its affiliates will beneficially own 50% or less of the Common Stock of the Company on such payment date.

(d) Optional Prepayment. The Company may, at any time and from time to time, without premium or penalty, prepay all or a portion of the unpaid principal amount of this Note in cash or other immediately available funds.

(e) Termination. Notwithstanding anything to the contrary set forth in this Note, if one or more of the Regulatory Approvals are not obtained on or prior to , 2005 (the "**Termination Date**") [one day prior to the Maturity Date] this Note shall thereupon terminate in all respects and no amount shall be payable by the Company to the Holders hereunder.

SECTION 3. Events of Default.

(a) For purposes of this Note, an "**Event of Default**" shall be deemed to have occurred upon:

(i) any failure by the Company to pay all or any portion of principal under this Note when the same shall be due and payable in accordance with the terms hereof, whether on the Maturity Date, by acceleration or otherwise, which failure continues unremedied for a period of 30 Business Days; or

(ii) (A) the filing by the Company or any of its Significant Subsidiaries of a voluntary petition seeking liquidation, reorganization, arrangement or readjustment, in any form, of its debts under Title 11 of the United States Code (or corresponding provisions of future laws) or any other applicable bankruptcy, insolvency or similar law, or the filing by the Company or any of its Significant Subsidiaries of an answer consenting to or acquiescing in any such petition, (B) the making by the Company or any of its Significant Subsidiaries of any assignment for the benefit of its creditors, or the admission by the Company or any of its Significant Subsidiaries in writing of its inability to pay its debts as they become due, (C) the filing of (x) an

---

involuntary petition against the Company or any of its Significant Subsidiaries under Title 11 of the United States Code, or any other applicable bankruptcy, insolvency or similar law (or corresponding provisions of future laws), (y) an application for the appointment of a custodian, receiver, trustee or other similar official for the Company or any of its Significant Subsidiaries for all or a substantial part of the assets of the Company or any of its Significant Subsidiaries or (z) an involuntary petition against the Company or any of its Significant Subsidiaries seeking liquidation, winding up, reorganization, arrangement, adjustment, protection, relief or composition of the Company or any of its Significant Subsidiaries or any of the Company's or any such Significant Subsidiary's debts under any other federal or state insolvency law, provided that any such filing shall not have been vacated, set aside or stayed within a 45 day period from the date thereof, or (D) the entry against the Company or any of its Significant Subsidiaries of a final and nonappealable order for relief under any bankruptcy, insolvency or similar law now or hereafter in effect.

(b) Upon the occurrence and during the continuance of any Event of Default described in Section 3(a)(i), the Holder may, by written notice to the Company, declare all or any portion of the unpaid principal amount of this Note to be immediately due and payable. Upon the occurrence of any Event of Default described in Section 3(a)(ii), the unpaid principal amount of this Note shall automatically become due and payable, without any action or notice by the Holder. Demand, presentment, protest and notice of non-payment are hereby waived by the Company.

SECTION 4. Subordination.

(a) Note Subordinated to Senior Debt. The Company covenants and agrees, and GEFAHI and each other Holder of this Note by its acceptance hereof likewise covenants and agrees, that all payments of the principal of this Note (collectively, the “**Subordinated Debt**”) shall be subordinated in accordance with the provisions of this Section 4 to the prior payment in full of all Senior Debt of the Company.

(b) Priority and Payment Over of Proceeds in Certain Events

(i) Subordination on Dissolution, Liquidation or Reorganization of the Company. Upon payment or distribution of assets or securities of the Company of any kind or character, whether in cash, property or securities, upon any dissolution or winding up or total or partial liquidation or reorganization of the Company, whether voluntary or involuntary, or in bankruptcy, insolvency, receivership or other proceedings or upon an assignment for the benefit of creditors or any other marshalling of the assets and liabilities of the Company (each such event, if any, herein referred to as a “**Proceeding**”), all Senior Debt shall first be paid in full in cash, or payment provided for in cash or cash equivalents in a manner satisfactory to the holders of Senior Debt, before any direct or indirect payments or distributions, including, without limitation, by exercise of set-off, of any cash, property or securities on account of this Note and to that end the holders of Senior Debt shall be entitled to receive (pro rata on the basis of the respective amounts of Senior Debt held by them) directly, for application to the payment thereof (to the extent necessary to pay all Senior Debt in full in cash after giving effect to any

3

---

substantially concurrent payment or distribution to or provision for payment to the holders of such Senior Debt), any payment or distribution of any kind or character, whether in cash, property or securities, in respect of the Subordinated Debt, except that the Holders may receive and retain equity securities of the Company or debt securities of the Company that are subordinated to Senior Debt (and any debt securities issued in exchange for Senior Debt) to substantially the same extent as, or to a greater extent than, this Note is subordinated to the Senior Debt pursuant to this Section 4. The holders of Senior Debt are hereby authorized to file an appropriate claim for and on behalf of any Holder if such Holder does not file, and there is not otherwise filed on behalf of such Holder, a proper claim or proof of claim in the form required in any Proceeding prior to 30 days before the expiration of the time to file such claim or claims.

(ii) Subordination on Default in Senior Debt. No direct or indirect payment by or on behalf of the Company with respect to the Subordinated Debt, whether pursuant to the terms of this Note, upon acceleration or otherwise, shall be made if at the time of such payment there exists (i) a default in the payment of all or any portion of principal of (premium, if any), interest on, fees or other amounts owing in connection with any Senior Debt, or (ii) any other default under any document or instrument governing or evidencing any Senior Debt, and the maturity of such Senior Debt is accelerated in accordance with its terms unless, in either case, (A) the default has been cured or waived in writing and any such acceleration has been rescinded or (B) such Senior Debt has been paid in full in cash. During the continuance of any default (other than a default described in clause (i) or (ii) of the preceding sentence) with respect to any Designated Senior Debt pursuant to which the maturity thereof may be accelerated immediately without further notice (except any notice required to affect the acceleration) or the expiration of any applicable grace period, the Company may not make any payment with respect to the Subordinated Debt for a period commencing upon receipt by the Company of a written notice (a “**Payment Blockage Notice**”) (which shall specify all defaults existing under such Designated Senior Debt on the date of such notice and of which the holder thereof or representative giving such notice had actual knowledge at such time) of the commencement of such period from such holder or representative, and ending upon the earlier of (i) waiver or cure of all defaults under such Designated Senior Debt, (ii) termination of such period by written notice from the holders of such Designated Senior Debt and (iii) completion of the 179th day after the beginning of such period. Not more than one Payment Blockage Notice with respect to all issues of Designated Senior Debt may be given in any consecutive 360-day period, irrespective of the number of defaults with respect to one or more issues of Designated Senior Debt during such period. No default under such Designated Senior Debt that existed at the time any Payment Blockage Notice is given may be the basis for any subsequent Payment Blockage Notice. Upon termination of any such period, the Company shall resume payments on account of the Subordinated Debt, subject to the provisions of Sections 4(a) and 4(b) hereof.

(iii) Rights and Obligations of Holders.

(1) If, notwithstanding Section 4(b)(i) and (ii) prohibiting such payment or distribution, any Holder shall have received any payment or

4

---

distribution on account of the Subordinated Debt at a time when such payment is prohibited by such provision before the Senior Debt is paid in full in cash, then and in such event, such payment or distribution shall be received and held in trust by such Holder apart from their other assets and paid over or delivered to the holders of the Senior Debt remaining unpaid to the extent necessary to pay in full in cash the principal of (premium, if any), and interest on, such Senior Debt in accordance with its terms and after giving effect to any concurrent payment or distribution to the holders of such Senior Debt.

(2) Nothing contained in this Section 4 will limit the right of the Holders of Subordinated Debt to take any action to accelerate the maturity of the Subordinated Debt pursuant to Section 3(b) hereof; provided, however, that all Senior Debt then due or thereafter declared to be due shall first be paid in full in cash before the Holders are entitled to receive any payment from the Company of this Note.

(3) Upon any payment or distribution of assets or securities referred to in this Section 4, the Holders shall be entitled to rely upon any order or decree of a court of competent jurisdiction in which such Proceeding is pending, and upon a certificate of the receiver, trustee in bankruptcy, liquidating trustee, agent or other person making any such payment or distribution, delivered to the Holders for the purpose of ascertaining the persons entitled to participate in such distribution, the holders of Senior Debt and other Indebtedness of the Company, the amount thereof or payable thereon, the amount or amounts paid or distributed thereon and all other facts pertinent thereto or to this Section 4.

(c) Rights of Holders of Senior Debt Not To Be Impaired. No right of any present or future holder of any Senior Debt to enforce subordination as herein provided shall at any time in any way be prejudiced or impaired by any act or failure to act by any such holder, or by any noncompliance by the Company with the terms and provisions and covenants herein regardless of any knowledge thereof such holder may have or otherwise be charged with.

The provisions of this Section 4 are intended to be for the benefit of, and shall be enforceable directly by, the holders of the Senior Debt. The Company and each Holder of this Note, by its acceptance hereof, acknowledges that the holders of the Senior Debt are relying upon the provisions of this Section 4 in extending such Senior Debt.

(d) Subrogation. Upon the payment in full of all Senior Debt in cash, the Holders shall be subrogated to the extent of the payments or distributions made to the holders of, or otherwise applied to payment of, the Senior Debt pursuant to the provisions of this Section 4 and to the rights of the holders of Senior Debt to receive payments or distributions of assets of the Company made on the Senior Debt until this Note shall be paid in full. For purposes of such subrogation, no payments or distributions to holders of Senior Debt of any cash, property or securities to which Holders of this Note would be entitled except for the provisions of this Section 4, and no payment over pursuant to the provisions of this Section 4 to holders of Senior Debt by the Holders, shall, as between the Company and the Holders, be deemed to be payment by the Company to or on

5

account of Senior Debt, it being understood that the provisions of this Section 4 are solely for the purpose of defining the relative rights of the holders of Senior Debt, on the one hand, and the Holders, on the other hand.

If any payment or distribution to which the Holders would otherwise have been entitled but for the provisions of this Section 4 shall have been applied, pursuant to the provisions of this Section 4, to the payment of Senior Debt, the Holders shall be entitled to receive from the holders of Senior Debt at the time outstanding any payments or distributions received by such holders of Senior Debt in excess of the amount sufficient to pay all Senior Debt in full in cash.

(e) Obligations of the Company Unconditional. Subject to Section 2, nothing contained in this Section 4 or elsewhere in this Note is intended to or shall impair, as between the Company and the Holders, the obligations of the Company, which are absolute and unconditional, to pay to the Holders the principal of this Note as and when the same shall become due and payable in accordance with its terms, or is intended to or shall affect the relative rights of the Holders and creditors of the Company other than the holders of the Senior Debt, nor shall anything herein or therein prevent any Holder from exercising all remedies otherwise permitted by applicable law upon the occurrence of an Event of Default under this Note, subject to the rights, if any, under this Section 4 of the holders of Senior Debt in respect of cash, property or securities of the Company received upon the exercise of any such remedy.

The failure to make a payment on account of this Note by reason of any provision of this Section 4 shall not be construed as preventing the occurrence of an Event of Default hereunder.

(f) Notice to Holders. The Company shall give prompt written notice to each Holder of any fact known to the Company which would prohibit the making of any payment on or in respect of this Note, but failure to give such notice shall not affect the subordination of the Subordinated Debt to the Senior Debt provided in this Section 4. Notwithstanding the provisions of this Section 4 or any other provision of this Note, no Holder shall be charged with knowledge of the existence of any facts which would prohibit the making of any payment to or in respect of this Note, unless and until the Holders shall have received written notice thereof from the Company or a representative of or holder of Senior Debt, and, prior to the receipt of any such written notice, subject to the provisions of this Section 4, the Holders shall be entitled in all respects to assume no such facts exist. Nothing contained in this Section 4(f) shall limit the right of the holders of Senior Debt to recover payments as contemplated by Sections 4(a) and 4(b).

(g) Right of Any Holder as Holder of Senior Debt. Any Holder in its individual capacity shall be entitled to all the rights set forth in this Section 4 with respect to any Senior Debt which may at any time be held by it, to the same extent as any other holder of Senior Debt, and nothing in this Note shall deprive such Holder of any of its rights as such holder.

6

---

(h) Reinstatement. The provisions of this Section 4 shall continue to be effective or be reinstated, and the Senior Debt shall not be deemed to be paid in full, as the case may be, if at any time any payment of any of the Senior Debt is rescinded or must otherwise be returned by the holder thereof upon the commencement or during the pendency of a Proceeding or otherwise, all as though such payment had not been made.

#### SECTION 5.

(a) Agreement to Obtain Regulatory Approvals and Rating Agency Affirmations. The Company shall, and shall cause GEMIC and the other Subsidiaries of the Company to, use reasonable best efforts to obtain, prior to the Termination Date, all Regulatory Approvals and Rating Agency Affirmations in respect of the early withdrawal from GEMIC's contingency reserve of, and the payment by GEMIC of a dividend (whether ordinary or extraordinary) in the amount of, \$700,000,000 and the payment of the principal amount of this Note in the amount of \$550,000,000. If the Company is unable to obtain any Regulatory Approval or Rating Agency Affirmation in the amount of \$700,000,000 in respect of the early withdrawal from GEMIC's contingency reserve or the payment of a dividend (whether ordinary or extraordinary) or any Rating Agency Affirmation in the amount of \$550,000,000 in respect of the payment of the principal amount of this Note, the Company shall, and shall cause GEMIC and the other Subsidiaries of the Company to, use reasonable best efforts to obtain, prior to the Termination Date, all Regulatory Approvals and Rating Agency Affirmations in respect of the maximum amount that the applicable Governmental Authority or Rating Agency will approve. If any Rating Agency Affirmation obtained prior to the Maturity Date is an Interim Rating Agency Affirmation or if any of the Rating Agency Affirmations are not obtained prior to the Maturity Date, the Company shall, and shall cause GEMIC and the other Subsidiaries of the Company to, use reasonable best efforts to obtain as promptly as practicable and, in any event, prior to the Extended Maturity Date, all Rating Agency Affirmations required to permit the Company to pay the Extended Payment Amount in full or, if any Rating Agency will not permit the payment of the Extended Payment Amount in full, the maximum amount that such Rating Agency will approve. If any Regulatory Approval obtained prior to the Termination Date lapses, the Company shall, and shall cause GEMIC and the other Subsidiaries of the Company to, use reasonable best efforts to obtain as promptly as practicable any reaffirmation or reissuance of such Regulatory Approval that is required to permit the Company to pay the Extended Payment Amount in full. The Company shall, and shall cause GEMIC and the other Subsidiaries of the Company to, afford one or more individuals designated in writing by GEFAHI (or any affiliate of GEFAHI) the opportunity to fully participate in, and consult with respect to, the process of obtaining the Regulatory Approvals and the Rating Agency Affirmations, and shall make available to such individuals all correspondence and other documents relating to such process.

(b) Reasonable Best Efforts. The obligations of the Company, GEMIC and the other Subsidiaries of the Company to use "reasonable best efforts" pursuant to Section 5(a) shall in no event require the Company, GEMIC or any such Subsidiary to (1) incur any additional Indebtedness, repay or refinance any outstanding Indebtedness, enter into any reinsurance transaction, or issue any new stock in order to

7

---

obtain any Regulatory Approval or Rating Agency Affirmation or (2) take any action that would (A) result in any material restriction on GEMIC's status as a licensed insurer in any state other than New York, or (B) result in any arrangement or requirement under which GEMIC ceases to write business in New York other than pursuant to an agreement between GEMIC and the New York Superintendent of Insurance, the terms and outcomes of which are acceptable to GEMIC in the sole but reasonable exercise of its discretion (the "Alternative Licensing Option"). Without limiting the generality of the foregoing clause 5(b)(2)(B), such agreement must (i) permit an affiliate of GEMIC to write mortgage guaranty business in New York on substantially the same terms and conditions as GEMIC currently writes such business, and (ii) not involve the formal suspension or revocation of GEMIC's license in, or require GEMIC to voluntarily withdraw from, the State of New York.

(c) In the event GEMIC's efforts to obtain Regulatory Approvals and Rating Agency Affirmations involve the Alternative Licensing Option, the following shall also be deemed to be elements of such Regulatory Approvals or Rating Agency Affirmations, as the case may be: The affiliate of GEMIC referred to in the last sentence of Section 5(b) hereof must be (1) approved by each of Fannie Mae and the Federal Home Loan Mortgage Corporation as a Type I (or, in the case of Fannie Mae, equivalent) insurer, and (2) acknowledged by the Rating Agencies as having financial strength ratings equivalent to AA, in each case to the reasonable satisfaction of the Company's and GEMIC's management and without requiring GEMIC to take any actions that would reasonably be expected to have an adverse impact on GEMIC's financial condition or results of operations.

SECTION 6. Remedies Cumulative. No failure to exercise or delay in exercising any right, remedy, power or privilege hereunder shall operate as a waiver thereof, nor shall any single or partial exercise of any right, remedy, power or privilege hereunder preclude any other or further exercise thereof or the exercise of any other right, remedy, power or privilege. The rights, remedies, powers and privileges provided herein are cumulative and not exclusive of any rights, remedies, powers and privileges provided by law. Time is of the essence in respect of the performance of all payment obligations under this Note.

SECTION 7. Notices. Any notices or other communications required or permitted hereunder shall be given in writing and personally delivered with receipt acknowledged or mailed, postage prepaid, via registered mail, return receipt requested, if to GEFAHI, at its address first set forth above or any other address notified in writing by any Holder to the Company, and if to the Company, at its address at \_\_\_\_\_, with a copy to \_\_\_\_\_, or any other address notified in writing by the Company to the Holders. Any notice given in conformity with the foregoing shall be deemed given when personally delivered or upon the date of delivery specified in the registered mail receipt.

SECTION 8. Governing Law. This Note shall be governed by and construed and interpreted in accordance with the laws of the State of New York

8

---

irrespective of the choice of laws principles of the State of New York other than Section 5-1401 of the General Obligations Law of the State of New York.

SECTION 9. Severability. If any provision of this Note is invalid or unenforceable in any jurisdiction, the other provisions hereof shall remain in full force and effect in such jurisdiction and the remaining provisions hereof shall be liberally construed in favor of the Holder hereof in order to effectuate the provisions hereof and the invalidity of any provision hereof in any jurisdiction shall not affect the validity or enforceability of any other provision in any other jurisdiction, including the State of New York.

SECTION 10. Transferability; Successors and Assigns. This Note shall not be assignable by GEFAHI or any Holder without the prior written consent of the Company other than to any direct or indirect wholly owned subsidiary of the General Electric Company. This Note shall not be assignable by the Company without the prior written consent of all of the Holders. Subject to the foregoing, this Note shall be binding upon and inure to the benefit of the Holders and the Company and their respective transferees, successors and assigns.

SECTION 11. Replacement of Note. Upon receipt of evidence reasonably satisfactory to the Company of the loss, theft, destruction or mutilation of this Note, and the Company's receipt of an indemnity agreement of the Holders reasonably satisfactory to the Company, the Company will, at the expense of the Holders, execute and deliver, in lieu thereof, a new Note of like terms.

SECTION 12. Definitions.

(a) For purposes of this Note, the following terms have the following meanings:

**"Business Day"** shall mean a day other than a Saturday, Sunday or other day on which commercial banks in New York are authorized or required by law to close.

**"Common Stock"** means the Class A common stock, par value \$.001 per share, and the Class B common stock, par value \$.001 per share, of the Company.

**"Company"** shall have the meaning ascribed to such term in the first paragraph of this Note.

**"Designated Senior Debt"** means any Senior Debt that has, at the time of determination, an aggregate principal amount outstanding of at least \$25,000,000 (including the amount of all undrawn commitments and matured and contingent reimbursement obligations pursuant to letters of credit thereunder).

9

---

**"Extended Maturity Date"** means the earlier of (i) subject to any extension needed to obtain a reaffirmation or reissuance of any Regulatory Approval that lapses, 60 days following the first date after the Maturity Date on which Rating Agency Affirmations are obtained for the full Extended Payment Amount and (ii) \_\_\_\_\_, 200[5]. [two-year anniversary of the date of the Note]

**"Extended Payment Amount"** means the excess of (i) the lowest amount specified in any Regulatory Approval obtained prior to the Maturity Date for a withdrawal or a dividend (not to exceed \$700,000,000) over (ii) the sum of (x) \$150,000,000 and (y) the Payment Amount.

**"GEMIC"** means General Electric Mortgage Insurance Corporation, a North Carolina corporation.

**"Governmental Authority"** means any entity exercising executive, legislative, judicial, regulatory or administrative functions of or pertaining to government, including any governmental authority, agency, department, board, commission or instrumentality whether federal, state, local or foreign (or any political subdivision thereof), any tribunal, court or arbitrator(s) of competent jurisdiction, and Fannie Mae and the Federal Home Loan Mortgage Corporation.

**"Holders"** shall have the meaning ascribed to such term in the first paragraph of this Note.

**"Indebtedness"** shall mean any indebtedness, whether or not contingent, for or in respect of borrowed money or evidenced by bonds, notes, debentures or similar instruments or letters of credit (or reimbursement agreements in respect thereof) or representing the balance deferred and unpaid of the purchase price of any property, including pursuant to capital leases (except any such balance that constitutes an accrued expense or a trade payable), if and to the extent any of the foregoing indebtedness would appear as a liability upon a balance sheet of such person or entity prepared on a consolidated basis in accordance with generally accepted accounting principles, and including, to the extent not otherwise included, the guaranty (other than by endorsement of negotiable instruments for collection in the ordinary course of business), direct or indirect, in any manner (including, without limitation, letters of credit and reimbursement agreements in respect thereof), of all or any part of the foregoing indebtedness.

**"Interim Rating Agency Affirmation"** means any Rating Agency Affirmation obtained prior to the Maturity Date that specifies (i) a withdrawal or dividend in an amount less than the lowest amount specified in any Regulatory Approval obtained prior to the Maturity Date or (ii) the

10

---

payment of the principal amount of this Note in an amount less than the excess of the lowest amount specified in any Regulatory Approval obtained prior to the Maturity Date over \$150,000,000.

**"Maturity Date"** means \_\_\_\_\_, 2005 [one-year anniversary of the date of the Note].

**"Payment Amount"** shall have the meaning ascribed to such term in Section 2(a).

“**Payment Blockage Notice**” shall have the meaning ascribed to such term in Section 4(b)(ii).

“**Payment Place**” shall have the meaning ascribed to such term in the first paragraph of this Note.

“**Person**” means an individual, a partnership, a corporation, an association, a joint stock company, a trust, a joint venture, an unincorporated organization and a governmental entity or any department, agency or political subdivision thereof.

“**Post-Commencement Interest**” means all interest accrued or accruing after the commencement of any Proceeding (and interest that would accrue but for the commencement of any Proceeding) in accordance with and at the contract rate (including, without limitation, any rate applicable upon default) specified in the agreement or instrument creating, evidencing or governing any Senior Debt, whether or not, pursuant to applicable law or otherwise, the claim for such interest is allowed as a claim in such Proceeding.

“**Proceeding**” shall have the meaning ascribed to such term in Section 4(b).

“**Rating Agencies**” means Standard & Poor’s Ratings Group, Moody’s Investors Service, Inc. and Fitch Ratings Ltd., and any successor to any such rating agency.

“**Rating Agency Affirmations**” means affirmations (i) from each of the Rating Agencies that the financial strength rating of GEMIC will not decrease or be placed on credit watch and (ii) from Standard & Poor’s Ratings Group and Moody’s Investors Service, Inc. that the senior unsecured debt rating of the Company will not decrease or be placed on credit watch, in each case as a result of (A) the withdrawal of up to \$700,000,000, or a lesser amount as specified by any of the Rating Agencies or Regulatory Approvals, from GEMIC’s contingency reserve, (B) the payment by GEMIC of a dividend (whether ordinary or extraordinary) of up to \$700,000,000, or a lesser amount as specified by any of the Rating Agencies or Regulatory Approvals and (C) the payment

---

of the principal amount of this Note in an amount of up to \$550,000,000, or a lesser amount as specified by any of the Rating Agencies or Regulatory Approvals.

“**Regulatory Approvals**” means all approvals or consents from any Governmental Authority that are required to permit the Company and GEMIC to effect the early withdrawal from GEMIC’s contingency reserve of, and the payment by GEMIC of a dividend (whether ordinary or extraordinary) in the amount of, \$700,000,000, or such lesser amount as may be specified by any such Governmental Authority.

“**Senior Debt**” means the principal of and premium, if any, and interest on (including Post-Commencement Interest) and other amounts due on or in connection with any Indebtedness of the Company (other than the Subordinated Debt), whether outstanding on the date of this Note or hereafter created, incurred or assumed, unless, in the case of any particular Indebtedness, the instrument creating or evidencing the same or pursuant to which the same is outstanding expressly provides that such Indebtedness shall not be senior in right of payment to the Subordinated Debt.

“**Significant Subsidiary**” shall mean a “significant subsidiary” of the Company as defined in Rule 1-02(v) of Regulation S-X under the Securities Exchange Act of 1933, as amended, and the Securities Exchange Act of 1934, as amended, as said Regulation may be amended from time to time, or any other Subsidiary of the Company that has guaranteed or assumed any obligations of the Company under this Note.

“**Subordinated Debt**” shall have the meaning ascribed to such term in Section 4(a).

“**Subsidiary**” shall mean any person or entity of which at least a majority of the capital stock or other equity interests (including partnership interests) having ordinary voting power for the election of directors or other governing body of such person or entity is owned or controlled by the Company, directly or indirectly through one or more subsidiaries.

“**Termination Date**” shall have the meaning ascribed to such term in Section 2(e).

(b) Unless otherwise provided herein, (i) the word “from” shall mean from and including and (ii) the words “to” or “until” shall mean to and until but excluding.

(c) All references to “Sections” in this Note shall be to Sections of this Note unless otherwise specifically provided.

---

SECTION 13. Descriptive Headings. The descriptive headings of this Note are inserted for convenience only and do not constitute a part of this Note.

IN WITNESS WHEREOF, each of the Company and the Holder has caused this Note to be executed by its duly authorized officer as of the day and year first written above.

GENWORTH FINANCIAL, INC.

By: \_\_\_\_\_  
Name: \_\_\_\_\_  
Title: \_\_\_\_\_

GE FINANCIAL ASSURANCE HOLDINGS, INC.

By: \_\_\_\_\_  
Name: \_\_\_\_\_  
Title: \_\_\_\_\_



**CANADIAN TAX MATTERS AGREEMENT**

**AMONG**

**GENERAL ELECTRIC COMPANY**

**GENERAL ELECTRIC CAPITAL CORPORATION**

**GECMIC HOLDINGS INC.**

**GE CAPITAL MORTGAGE INSURANCE COMPANY (CANADA)**

**AND**

**GENWORTH FINANCIAL, INC.**

**MADE AS OF**

**•, 2004**

---

**CANADIAN TAX MATTERS AGREEMENT**

**AMONG** **GENERAL ELECTRIC COMPANY**, a company incorporated under the laws of the State of New York,  
(hereinafter referred to as “**GE**”)

**AND** **GENERAL ELECTRIC CAPITAL CORPORATION**, a company incorporated under the laws of the State of Delaware,  
(hereinafter referred to as “**GECC**”)

**AND** **GECMIC HOLDINGS INC.**, a company incorporated under the laws of Canada,  
(hereinafter referred to as “**GECMIC Holdings**”)

**AND** **GE CAPITAL MORTGAGE INSURANCE COMPANY (CANADA)**, a company duly incorporated under the laws of Canada,  
(hereinafter referred to as the “**Company**”)

**AND** **GENWORTH FINANCIAL, INC.**, a company incorporated under the laws of Delaware,  
(hereinafter referred to as “**Genworth**”).

**RECITALS:**

- A. Pursuant to the Master Agreement (“Master Agreement”) dated \_\_\_, 2004 among GE, GECC, GEI, Inc., a company incorporated under the laws of the State of Delaware (“GEI”), GE Financial Assurance Holdings, Inc., a company incorporated under the laws of the State of Delaware (“GEFAHI”), and Genworth, Genworth has agreed, *inter alia*, to acquire the outstanding shares of stock of certain subsidiaries of GE.
- B. Pursuant to the US Tax Matters Agreement dated \_\_\_, 2004 between GE, GECC, GEI, GEFAHI, and Genworth, GE and Genworth have entered into an arrangement governing the US tax affairs of the subsidiaries and businesses acquired pursuant to the Master Agreement.



- 
- C. GECMIC Holdings has agreed to sell, and Genworth has agreed to acquire (through a Canadian subsidiary) all of the issued and outstanding shares of the Company, for fair market value consideration (the "Share Transfer"), such Share Transfer to occur immediately before a proposed initial public offering of Genworth shares.
- D. In connection with the Share Transfer, the parties wish to set out their agreement with respect to certain tax matters relating to the Company.

**NOW, THEREFORE, IN CONSIDERATION OF THE SHARE TRANSFER, THE PARTIES HERETO AGREE AS FOLLOWS:**

**1. Definitions**

- 1.1 "Taxes" means all federal, provincial, municipal, territorial, foreign or other taxes, imposts, levies, rates, assessments and government fees, charges or dues lawfully assessed, levied, or imposed against the Company, including all income, capital gains, excise, sales, use, property, capital, goods and services, business transfer, value added, compensation, social security, payroll, employment, privilege, franchise, licence and school taxes and custom and import duties, and includes all interest, fines, and penalties with respect thereto.
- 1.2 "Tax Returns" means all reports, returns, and other documents filed or required to be filed by the Company in respect of Taxes or in respect of or pursuant to any domestic or foreign federal, provincial, state, municipal, territorial or other taxing statute.

**2. Tax Return Filing**

- 2.1 The Company shall be responsible for preparing and filing of the Company's Tax Return for the taxation year of the Company ended December 31, 2004 (the "2004 Return"). The 2004 Return will be subject to review, adjustment and approval by GE, which approval may not be unreasonably withheld. The Company shall prepare a draft 2004 Return in sufficient time to enable GE to review the draft 2004 Return and resolve any outstanding issues, so that the final 2004 Return may be filed on or before its due date.
- 2.2 Subject to section 2.3, GE has the right to cause the Company to claim less than the maximum allowable deduction in respect of reserves (the "Under-Reserve") in its 2004 Canadian Tax Returns. The Under-Reserve shall not exceed the amount that will generate an excess of CAD \$72,000,000 of Canadian federal and provincial income tax over the Canadian federal and provincial income tax the Company would pay absent the Under-Reserve.

2

---

GE shall notify the Company and Genworth of its decision to exercise its right sufficiently in advance of the time the Company is required to deliver the draft Tax Return.

**2.3**

- a) In order for GE to be able to assert its right under section 2.2 the Company must reasonably determine that after having paid the Taxes resulting from the Under-Reserve, the Company will be able to comply with the *Insurance Companies Act* and have adequate regulatory capital to carry on its business in a manner consistent with applicable regulatory guidelines, overall prudence based on the in force business, the Company's reasonable growth expectations, volatility in the investment portfolio, and capital efficiency.
- b) If the Company reasonably determines that it cannot pay the Taxes resulting from the Under-Reserve and meet the obligations in a), then before GE can exercise its rights in section 2.2, the Company and Genworth shall consult and agree on a method for Genworth to supply the required additional regulatory capital to the Company or for the Company to otherwise satisfy the obligations in a) in sufficient time to facilitate timely payment of such Taxes and filing of Tax Returns.
- c) If Genworth reasonably determines that it does not have sufficient liquidity to supply the additional regulatory capital required in b), then GE shall lend or otherwise provide to Genworth an amount up to the required additional regulatory capital without interest or other cost to Genworth, but no more than is required for Genworth to maintain sufficient liquidity after supplying the required additional regulatory capital.
- d) To the extent Genworth uses funds not lent or provided to it by GE to supply additional regulatory capital to enable the Company to pay any or all of the Taxes resulting from the Under-Reserve, GE shall reimburse Genworth for Genworth's opportunity cost of foregone investment. To the extent the Company pays any or all of the Taxes resulting from the Under-Reserve without additional regulatory capital from Genworth, GE shall reimburse the Company for the Company's opportunity cost of foregone investment. In determining the amount of these reimbursements from time to time the foregone investment shall be reduced as the Company recovers Taxes as a result of reinstating maximum reserve claims for taxation years after 2004, which the Company undertakes to do as soon as practicable.

3

- 
- e) If GE disagrees with the determinations in b) or c), any party can send the matter to arbitration for a decision. Section VII of the Master Agreement shall govern these arbitrations.

- 2.4 The Company agrees that it shall take no actions outside of the ordinary course of business that would result in a reduction in the Company's regulatory

capital, unless GE is notified of and approves such action.

- 2.5 Unless otherwise agreed by GE, until any loan or other funding made by GE to Genworth pursuant to Section 2.3c) hereof has been repaid to GE, the Company shall claim the maximum allowable deduction in respect of its reserves in its Canadian Tax Returns for taxation years ending after 2004, to the extent of its taxable income before reserve deductions. Genworth shall repay any loan or other funding received from GE pursuant to Section 2.3c) hereof as soon as is reasonably possible. In all events, Genworth shall repay such loan or other funding no later than the date by which the Company recovers the excess Canadian tax described in Section 2.2 hereof (as a result of reinstating maximum reserve claims for taxable years after 2004).
- 2.6 The Company shall not amend or re-file any Tax Return in respect of any taxation period ending on or before December 31, 2004 without the prior written consent of GE, which consent shall not be unreasonably withheld.

4

---

3. Further Assurances

The parties agree that they shall, from time to time and at all reasonable times hereafter, do and execute or cause to be done and executed, all such further acts as may reasonably be required to give effect to this Agreement.

4. The preamble to this Agreement shall form an integral part of this Agreement.

5. This Agreement shall be governed by and will be construed in accordance with the laws of the Province of Ontario and the laws of Canada applicable therein.

5

---

IN WITNESS WHEREOF, the parties hereto have signed this Agreement on •, 2004.

**GENERAL ELECTRIC COMPANY**

Per: \_\_\_\_\_

**GENERAL ELECTRIC CAPITAL CORPORATION**

Per: \_\_\_\_\_

**GECMIC HOLDINGS INC.**

Per: \_\_\_\_\_

**GE CAPITAL MORTGAGE INSURANCE COMPANY (CANADA)**

Per: \_\_\_\_\_

**GENWORTH FINANCIAL, INC.**

Per: \_\_\_\_\_

**TRUST AGREEMENT**

This TRUST AGREEMENT, dated as of April 15, 2004 (this "Trust Agreement"), among Union Fidelity Life Insurance Company, an insurance company organized under the Laws of the State of Illinois (the "Grantor"), General Electric Capital Assurance Company, an insurance company organized under the laws of the State of Delaware (the "Beneficiary"), and The Bank of New York, a New York corporation (the "Trustee") (the Grantor, the Beneficiary and the Trustee are hereinafter each sometimes referred to individually as a "Party" and collectively as the "Parties"). All terms not defined herein shall have the same meanings as set forth in the Coinsurance Agreements (as hereinafter defined).

**WITNESSETH:**

**WHEREAS**, pursuant to a Coinsurance Agreement of even date herewith between the Beneficiary and the Grantor, the Beneficiary is ceding to the Grantor, and the Grantor is reinsuring on a coinsurance basis, certain of the Beneficiary's liabilities arising under structured settlement annuities, and pursuant to a Retrocession Agreement also of even date herewith between the Beneficiary and the Grantor, the Beneficiary is ceding to the Grantor, and the Grantor is reinsuring on a coinsurance basis, certain of the Beneficiary's liabilities arising under certain long term care policies (collectively the "Coinsurance Agreements"); and

**WHEREAS**, the Grantor desires to transfer to the Trustee for deposit to a trust account (the "Trust Account") certain assets as security for the payment and performance by the Grantor of its obligations under the Coinsurance Agreements; and

**WHEREAS**, the Trustee has agreed to act as Trustee hereunder, and to hold such assets in trust in the Trust Account for the sole use and benefit of the Beneficiary for such purposes in accordance with the terms and conditions of this Trust Agreement; and

**WHEREAS**, this Trust Agreement is made for the sole use and benefit of the Beneficiary and for the purpose of setting forth the duties and powers of the Trustee with respect to the Trust Account;

**NOW, THEREFORE**, for and in consideration of the premises and for other good and valuable consideration, the receipt of which is hereby acknowledged, the Parties hereby agree as follows:

**Section 1. Deposit of Assets to the Trust Account**

(a) The Grantor hereby establishes the Trust Account with the Trustee for the sole use and benefit of the Beneficiary, under the terms set forth herein. The Trustee shall administer the Trust Account in its name as Trustee for the sole benefit of the Beneficiary. The Trust

Account shall be subject to withdrawal by the Beneficiary solely as provided herein. The Trustee hereby accepts the Trust Account upon the terms set forth in this Trust Agreement.

(b) The Grantor shall transfer to the Trustee, for deposit to the Trust Account, such assets as may be required from time to time pursuant to the Coinsurance Agreements (all such assets are herein referred to individually as an "Asset" and collectively as the "Assets"). The Trustee is authorized and shall have power to receive the Assets from the Grantor and to hold, invest, reinvest and dispose of the same for the uses and purposes of and according to the provisions herein set forth. All Assets shall be maintained by the Trustee in the Trust Account separate and distinct from all other assets on the books of the Trustee and in accordance with the terms of this Trust Agreement. The Assets shall consist only of Eligible Securities (as hereinafter defined). In the event of any payment default as to any Asset in the Trust Account or in the event that any Asset no longer is an Eligible Security, the Grantor shall, within five (5) business days after receiving notice from the Trustee pursuant to Section 19 or the Grantor having knowledge of such default or ineligibility, substitute other Assets which meet the requirements of an Eligible Security and having a statutory book value equal to the statutory book value of such Asset, which has a payment default or no longer meets the requirements for an Eligible Security, on the last statement provided by the Trustee.

(c) The Grantor hereby represents and warrants (i) that, to the extent practicable, any Assets transferred by the Grantor to the Trustee for deposit to the Trust Account will be in such form that the Beneficiary whenever necessary may, and the Trustee upon direction by the Beneficiary will, negotiate any such Assets without consent or signature from the Grantor or any other person or entity in accordance with the terms of this Trust Agreement, (ii) that all Assets transferred by the Grantor to the Trustee for deposit into the Trust Account consist only of Eligible Securities, and (iii) that Grantor has at the time of transfer into this Trust Account good and marketable title to the Assets to be so transferred and each such Asset shall be at the time of transfer free and clear of all claims, liens, interests and encumbrances (other than those arising under this Trust Agreement).

(d) Prior to depositing the Assets into the Trust Account, and from time to time thereafter as required, the Grantor shall execute assignments, endorsement in blank, or transfer legal title to the Trustee of all shares, obligations or other Assets requiring assignments, so that, to the extent practicable, the Beneficiary whenever necessary may, and the Trustee upon the direction by the Beneficiary will, negotiate any such Assets without the consent or signature from the Grantor or any other person or entity. The Grantor shall give all notices and take all actions as the Trustee deems appropriate in order to cause payments due or that become due on any Asset within the Trust Account to be paid to the Trustee. The Grantor shall not make or consent to any waiver, amendment or restriction on transfer with respect to any Asset in the Trust Account, in each case without the Beneficiary's prior written consent. In connection with the deposit of Assets into the Trust Account, the Grantor shall furnish to the Trustee all original documentation evidencing the Grantor's ownership thereto.

(e) The parties recognize that certain Assets will not be readily negotiable and that certain notices, opinions of counsel, representations and/or consents will be required for the Beneficiary to obtain good and marketable title to such Assets.

**Section 2. Withdrawal of Assets from the Trust Account**

(a) Without notice to the Grantor, the Beneficiary shall have the right, at any time and from time to time, to withdraw from the Trust Account, upon notice to the Trustee in the form of a certificate substantially in the form of Exhibit A-1 attached hereto (the "Beneficiary Certificate"), signed by a duly authorized officer of the Beneficiary, accompanied by a request for withdrawal substantially in the form of Exhibit A-2 hereto (the "Beneficiary Request for Withdrawal"), signed by a duly authorized officer of the Beneficiary, such Assets as are specified in such Beneficiary Request for Withdrawal. The Beneficiary Request for Withdrawal may designate a third party (the "Beneficiary Designee"), including the Grantor, to whom Assets specified therein shall be delivered. The Beneficiary shall not be required to present any other statement or document in addition to a Beneficiary Certificate and a Beneficiary Request for Withdrawal in order to withdraw any Assets, except that the Beneficiary shall acknowledge receipt of any such Assets withdrawn upon request by the Trustee.

(b) Upon receipt of a Beneficiary Certificate and a Beneficiary Request for Withdrawal, subject to the provision by the Beneficiary of any required notices, opinions of counsel and representations, the Trustee and the Grantor shall use commercially reasonable efforts to transfer absolutely and unequivocally all right, title and

interest in the Assets specified in such Beneficiary Request for Withdrawal and shall deliver physical custody (or such other form as is necessary to complete the transfer) of such Assets to or for the account of the Beneficiary or such Beneficiary Designee, as specified in such Beneficiary Request for Withdrawal. The Trustee shall notify the Grantor and Beneficiary within three (3) business days following each withdrawal from the Trust Account.

(c) Subject to Section 4, in the absence of a Beneficiary Certificate and a Beneficiary Request for Withdrawal, the Trustee shall allow no substitution or withdrawal of any Asset from the Trust Account.

(d) The Trustee shall notify the insurance regulator in the state where the Beneficiary is domiciled within three (3) business days after all the assets in the Trust Account are withdrawn. At the Trustee's request, the Beneficiary shall provide to the Trustee the address of the insurance regulator in the state where the Beneficiary is domiciled.

Section 3. Application of Assets. The Beneficiary shall be permitted to withdraw Assets from the Trust Account only for the purposes set forth in the Coinsurance Agreements.

Section 4. Redemption, Investment and Substitution of Assets.

(a) The Trustee shall surrender for payment all maturing Assets and all Assets called for redemption, and deposit the principal amount of the proceeds of any such payment to the Trust Account.

(b) The Grantor, subject to the prior written approval of the Beneficiary, may retain (and pay the service fees of) a professional asset manager (the "Asset Manager") to manage and make investment decisions with regard to the Assets held by the Trustee in the Trust Account. From time to time, at the written order and direction of the Grantor or the Asset Manager, the Trustee shall invest Assets in the Trust Account in Eligible Securities.

3

---

(c) From time to time, subject to the prior written approval of the Beneficiary, the Grantor or the Asset Manager may direct the Trustee to substitute Assets of equal statutory book value for other Assets presently held in the Trust Account. The Trustee shall have no responsibility whatsoever to determine the value of such substituted Assets or that such substituted Assets constitute Eligible Securities.

(d) All investments and substitutions of securities referred to in Sections 4(b) and 4(c) above shall be in compliance with the definition of "Eligible Securities" in Section 12 of this Trust Agreement. Any instruction or order concerning such investments or substitutions of securities shall be referred to herein as an "Investment Order". The Trustee shall execute Investment Orders and settle securities transactions by itself or by means of an agent or broker. The Trustee shall not be responsible for any act or omission, or for the solvency, of any such agent or broker, except as set forth in Section 7.

(e) From time to time, upon notice to the Beneficiary, the Trustee may withdraw any Asset in the Trust Account upon the call or maturity of such Asset provided that the proceeds from such call or maturity are deposited into the Trust Account.

(f) When the Trustee is directed to deliver Assets against payment, delivery will be made in accordance with generally accepted market practice.

(g) Any loss incurred from any investment pursuant to the terms of this Section 4 shall be borne exclusively by the Trust Account.

(h) The Trustee shall not foreclose on, or direct or consent to the foreclosure of, any real property securing a commercial loan constituting an Asset or take title to such property by deed-in-lieu of foreclosure or other means without the prior written consent of the Grantor and the Beneficiary. The Trustee shall not provide any consent or direction with respect to any such commercial loan except at the written direction of the Grantor.

Section 5. The Income Account. All payments of interest, dividends and other income in respect to Assets in the Trust Account shall be the property of the Grantor and shall be deposited by the Trustee subject to deduction of the Trustee's compensation and expenses as provided in Section 9 of this Agreement, in a separate account (the "Income Account") established and maintained by the Grantor at an office of the Trustee. The Grantor may withdraw amounts from the Income Account at any time and from time to time.

Section 6. Right to Vote Assets. The Trustee shall forward all annual and interim stockholder reports and all proxies and proxy materials relating to the Assets in the Trust Account to the Grantor within a reasonable period of time following the Trustee's receipt thereof. The Grantor shall have the full and unqualified right to vote any Asset in the Trust Account.

Section 7. Additional Rights and Duties of the Trustee.

(a) Before accepting any Asset for deposit to the Trust Account, the Trustee shall determine that such Asset is in such form that, to the extent practicable, the Beneficiary whenever necessary may, or the Trustee upon direction by the Beneficiary will, negotiate such

4

---

Asset without consent or signature from the Grantor or any person or entity other than the Trustee in accordance with the terms of this Trust Agreement.

(b) The Trustee shall be under no obligation to determine whether or not any instructions given by the Grantor and Beneficiary are contrary to any provision of law. It is understood and agreed that the Trustee's duties are solely those set forth herein and that the Trustee shall have no duty to take any other action unless specifically agreed to by the Trustee in writing. Without limiting the generality of the foregoing, the Trustee shall not have any duty to advise, manage, supervise or make recommendations with respect to the purchase, retention or sale of Assets with respect to any Assets in the Trust Account as to which a default in the payment of principal or interest has occurred or to be responsible for the consequences of insolvency or the legal inability of any broker, dealer, bank or other agent employed by the Grantor or Trustee with respect to the Assets except to the extent that the Trustee was negligent, engaged in misconduct or acted in bad faith in the selection of any such person or entity.

(c) The Trustee shall accept and open all mail directed to the Grantor or the Beneficiary in care of the Trustee.

(d) The Trustee shall have no responsibility whatsoever to determine that any Assets in the Trust Account are or continue to be Eligible Securities.

(e) The Trustee shall furnish to the Grantor and the Beneficiary a statement of all Assets in the Trust Account upon the inception of the Trust Account and at the end of each calendar month thereafter. The statement shall include a description of the Assets in the Trust Account and shall be delivered within five (5) business days following the end of such calendar month.

(f) The Trustee shall keep full and complete records of the administration of the Trust Account in accordance with all applicable law. Upon the request of the Grantor or the Beneficiary, the Trustee shall promptly permit the Grantor or the Beneficiary, their respective agents, employees, independent auditors and regulatory authorities to examine, audit, excerpt, transcribe and copy, during the Trustee's normal business hours, any books, documents, papers and records relating to the Trust

(g) Unless otherwise provided in this Trust Agreement, the Trustee is authorized to follow and rely upon all instructions given by officers of the Grantor or the Beneficiary and by attorneys-in-fact acting under written authority furnished to the Trustee by the Grantor or the Beneficiary, including, without limitation, instructions given by letter, facsimile transmission or electronic media, if the Trustee believes such instructions to be genuine and to have been signed, sent or presented by the proper party or parties. In the absence of negligence, the Trustee shall not incur any liability to anyone resulting from actions taken by the Trustee in reliance in good faith on such instructions. The Trustee shall not incur any liability in executing instructions (i) from any attorney-in-fact prior to receipt by it of notice of the revocation of the written authority of the attorney-in-fact or (ii) from any officer of the Grantor or the Beneficiary.

5

---

(h) The duties and obligations of the Trustee shall only be such as are specifically set forth in this Trust Agreement, as it may from time to time be amended, and no implied duties or obligations shall be read into this Trust Agreement against the Trustee.

(i) No provision of this Trust Agreement shall require the Trustee to take any action which, in the Trustee's reasonable judgment, would result in any violation of this Trust Agreement or any provision of law.

(j) The Trustee may confer with counsel of its own choice in relation to matters arising under this Trust Agreement and shall have full and complete authorization from the other Parties for any action taken or suffered by it under this Trust Agreement or in respect of any transaction contemplated hereby in good faith and in accordance with the opinion of such counsel.

(k) The Trustee shall notify the Grantor and Beneficiary in writing of any payment default occurring as to any Asset within three (3) business days after Trustee receives notice of such default. In the event of a delinquency of a timely payment in regard to any of the Assets, the Trustee shall inform the Grantor and the Beneficiary immediately upon Trustee's receipt of notice of such delinquency.

(l) Notwithstanding any provision of this Agreement to the contrary, the Trustee shall be liable for (i) subject to Section 7(n), the safekeeping of the Assets and administering the Trust Account in accordance with the provisions of this Trust Agreement and (ii) its own negligence, willful misconduct or lack of good faith in performing its duties under this Trust Agreement. The Trustee shall exercise the standard of care with respect to the Assets that a professional trustee, engaged in the banking or trust company industry, having professional expertise in financial and securities processing transactions and custody would observe in such affairs. The Trustee shall be strictly liable for physical loss of or damage to Assets under its care, custody, possession or control or the care, custody, possession or control of its subcustodians, other agents or nominee(s), including but not limited to loss due to fire, burglary, robbery, theft or mysterious disappearance. In the event of loss or damage to the Assets under the care, custody, possession or control of Trustee or its subcustodians, other agents or nominee(s), Trustee shall, upon demand of the Grantor or Beneficiary, promptly replace such Assets with like kind and quality together with, all rights and privileges pertaining to the Assets (by among other methods, posting appropriate security or bond with the issuer of the Assets to obtain reissue of such Assets, or, if acceptable to the Grantor, deliver cash equivalent to the market value of the Assets as of the date of the discovery of the loss or damage). Nothing contained in any contract between Trustee and any entity authorized to hold Assets, as defined herein, shall diminish or otherwise alter the liability of Trustee to the Grantor or Beneficiary. The provisions of this paragraph shall not affect the burden of proof under applicable law with respect to the assertions of liability in any claim, action or dispute alleging any breach of or failure to observe such standard of care.

(m) The Trustee shall not be responsible for the existence, genuineness or value of any of the Assets, for the validity, perfection, priority or enforceability of the liens in or with respect to any of the Assets, for the validity of title to the Assets, for insuring the Assets, for the payment of taxes, charges, assessments or liens upon or with respect to the Assets, for any obligations

6

---

under any agreements or other documents evidencing or related to any of the Assets (other than this Trust Agreement), or for the compliance of the Assets with any laws, including any Environmental Law (as hereinafter defined). The Trustee shall have no responsibility for the recording, filing or registration (or for the rerecording, refiling or reregistration) of any instrument or notice, including any financing or continuation statement or any tax or securities form, at any time in any public office or elsewhere for the purpose of perfecting, maintaining the perfection of or otherwise making effective any lien upon or with respect to any of the Assets.

(n) The Parties acknowledge and agree that certain of the Assets are and will continue to be subject to servicing and custodial agreements in effect on the date hereof (as amended or otherwise modified from time to time, including any replacements thereof, the "Servicing/Custodial Agreements"). The Grantor and the Beneficiary acknowledge and agree that (i) the Trustee shall have no liability under this Trust Agreement for any action or omission of any of the parties to the Servicing/Custodial Agreements, including with respect to any of the Assets at any time during which such Assets are under the care, custody, possession or control of any of the parties to the Servicing/Custodial Agreements or any of their respective depositories, subcustodians, other agents or nominees (and, solely for the purposes of limiting the liability and determining the duties of the Trustee under Section 7(l), none of such Persons shall be considered to be the depositories, subcustodians, agents or nominees of the Trustee), (ii) the performance by the Trustee of any of its obligations under this Trust Agreement may be delayed, limited or otherwise affected by the actions or omissions of any of the parties to the Servicing/Custodial Agreements or as a result of the Assets being subject to the Servicing/Custodial Agreements and (iii) the Trustee shall have no liability under this Trust Agreement as a result of the Trustee's failure to perform any of its obligations under this Trust Agreement as a result of the actions or omissions of any of the parties to the Servicing/Custodial Agreements or as a result of the Assets being subject to the Servicing/Custodial Agreements.

Section 8. Representations, Warranties and Covenants of the Trustee. The Trustee represents, warrants and covenants to the Grantor and Beneficiary that:

- (a) The Trustee is a Qualified United States Financial Institution;
- (b) In the ordinary course of its business, the Trustee maintains securities accounts for others and is acting in that capacity in this Trust Agreement;
- (c) The Trust Account is and at all times shall be maintained at an office of the Trustee in the United States of America;
- (d) The Trustee is not an Affiliate of the Grantor or the Beneficiary.

Section 9. The Trustee's Compensation; Expenses.

(a) The Grantor shall pay the Trustee, as compensation for its services under this Trust Agreement, a fee computed at rates determined by the Trustee from time to time and communicated in writing to the Grantor. The Grantor shall pay or reimburse the Trustee for all of the Trustee's expenses and disbursements in connection with its duties under this Trust Agreement (including reasonable attorney's fees and expenses), except any such expense or disbursement as may arise from the Trustee's negligence, willful misconduct, lack of good faith

7

---

or failure to administer the Trust Account in accordance with the terms of this Trust Agreement. The Trustee shall be entitled to deduct its compensation and expenses from payments of dividends, interest and other income in respect of the Assets held in the Trust Account prior to the deposit thereof to the Income Account as provided in Section 5 of this Agreement. The Grantor also hereby indemnifies the Trustee for, and holds it harmless against, any loss, liability, costs or expenses (including reasonable attorney's fees and expenses) incurred or made without negligence, willful misconduct or lack of good faith on the part of the Trustee, arising out of or in connection with the performance of its obligations in accordance with the provisions of this Trust Agreement (which shall be the sole obligation of the Trustee), including any loss, liability, costs or expenses arising out of or in connection with the status of the Trustee and its nominee as the holder of record of the Assets. The Grantor hereby acknowledges that the foregoing indemnities shall survive the resignation of the Trustee or the termination of this Trust Agreement and hereby grants the Trustee a lien, right of set-off and security interest in the funds in the Income Account for the payment of any claim for compensation, reimbursement or indemnity hereunder.

(b) No Assets shall be withdrawn from the Trust Account or used in any manner for paying compensation to, or reimbursement or indemnification of, the Trustee.

(c) In addition to, and without limiting, the Grantor's indemnification obligations set forth in Section 9(a), to the extent resulting from or in connection with the execution, delivery, enforcement, performance, or administration of this Trust Agreement, the Grantor shall defend, indemnify, and hold harmless the Trustee and its employees, officers, directors and agents from and against any claims, demands, penalties, fines, liabilities, settlements, damages, costs, or expenses of whatever kind or nature, known or unknown, contingent or otherwise, arising out of, or in any way related to, (i) the presence, disposal, release, or threatened release of any Hazardous Materials which are on, from, or affecting soil, water, vegetation, buildings, personal property, persons, animals, or otherwise; (ii) any personal injury (including wrongful death), property damage (real or personal) or natural resource damage arising out of or related to such Hazardous Materials; (iii) any third party claim brought or threatened, settlement reached, or government order, or any policies or requirements of the Trustee, which are based upon or in any way related to such Hazardous Materials, including, without limitation, attorney and consultant fees and expenses, investigation and laboratory fees, court costs, and litigation expenses, and (iv) any violations of Environmental Law, except, in each instance, to the extent arising from the negligence, willful misconduct or lack of good faith of the Trustee. The Grantor hereby acknowledges that the foregoing indemnities shall survive the resignation of the Trustee or the termination of this Trust Agreement and hereby grants the Trustee a lien, right of set-off and security interest in the funds in the Income Account for the payment of any claim for compensation, reimbursement or indemnity hereunder. For purposes hereof:

"Hazardous Materials" means, without limit, any pollutant, contaminant or hazardous, toxic, medical, biohazardous, or dangerous waste, substance, constituent or material, defined or regulated as such in, or for the purpose of, any applicable Environmental Law, including, without limitation, any asbestos, any petroleum, oil (including crude oil or any fraction thereof), any radioactive substance, any polychlorinated biphenyls, any toxin, chemical, disease-causing agent or pathogen, and any other substance that gives rise to liability under any applicable Environmental Law; and

8

---

"Environmental Law" means the Comprehensive Environmental Response, Compensation and Liability Act, as amended ("CERCLA"), the Resource Conservation and Recovery Act of 1976, as amended, and any other applicable federal, state, local, or foreign statute, rule, regulation, order, judgment, directive, decree, permit, license or common law as in effect now, previously, or at any time during the term of this Trust Agreement, and regulating, relating to, or imposing liability or standards of conduct concerning air emissions, water discharges, noise emissions, the release or threatened release or discharge of any Hazardous Material into the environment, the use, manufacture, production, refinement, generation, handling, treatment, storage, transport or disposal of any Hazardous Material or otherwise concerning pollution or the protection of the outdoor or indoor environment, or human health or safety in relation to exposure to Hazardous Materials.

#### Section 10. Resignation or Removal of the Trustee.

(a) The Trustee may resign at any time upon delivery of a written notice thereof to the Beneficiary and to the Grantor effective not less than 90 days after receipt by the Beneficiary and the Grantor of such notice. The Trustee may be removed by prior written notice executed by Grantor and Beneficiary. No such resignation or removal shall become effective until a successor Trustee has been appointed and approved by the Beneficiary and the Grantor and all Assets in the Trust Account have been duly transferred to the successor Trustee in accordance with paragraph (b) of this Section 10.

(b) Upon receipt by the proper Parties of the Trustee's notice of resignation or the Grantor's and Beneficiary's notice of removal, the Grantor and the Beneficiary shall appoint a successor Trustee. Any successor Trustee shall be a bank that is a member of the Federal Reserve System and a Qualified United States Financial Institution, and shall not be an Affiliate of the Grantor or the Beneficiary. Upon the acceptance of the appointment as Trustee hereunder by a successor Trustee and the transfer to such successor Trustee of all Assets in the Trust Account, the resignation or removal of the Trustee shall become effective. Thereupon, such successor Trustee shall succeed to and become vested with all the rights, powers, privileges and duties of the resigning or removed Trustee, and the resigning or removed Trustee shall be discharged from any future duties and obligations under this Trust Agreement, but the resigning or removed Trustee shall continue after such resignation or removal to be entitled to the benefits of the indemnities provided herein for the Trustee.

#### Section 11. Termination of the Trust Account.

(a) The Trust Account and this Trust Agreement, except for the indemnities provided herein, may be terminated only after the Grantor and Beneficiary mutually give the Trustee written notice of their intention to terminate the Trust Account (the "Notice of Intention"). The Notice of Intention shall specify the date on which the Parties intend the Trust Account to terminate (the "Termination Date").

(b) On the Termination Date, the Trustee shall transfer to the Grantor all of the Assets not previously withdrawn by the Beneficiary.

9

---

Section 12. Definitions. Except as the context shall otherwise require, the following terms shall have the following meanings for purposes of this Trust Agreement (the definitions to be applicable to both the singular and the plural forms of each term defined if both forms of such term are used in this Trust Agreement):

The term "Affiliate" means any other Person that directly or indirectly controls, is controlled by, or is under common control with, the first Person.

The term "Beneficiary" shall include any successor of the Beneficiary by operation of law including, without limitation, any liquidator, rehabilitator, receiver or conservator.

The term "Control" (including the related terms "controlled by" and "under common control with") shall mean the ownership, directly or indirectly, of more than 50% of the voting securities of a corporation.

The term "Eligible Securities" shall mean and include certificates of deposit (issued by a United States bank and payable in United States legal tender) and other assets of the types specified on Exhibit B attached hereto.

The terms "Person" shall mean and include an individual, a corporation, a partnership, an association, a trust, an unincorporated organization or a government or political subdivision thereof.

The term "Qualified United States Financial Institution" shall mean a bank designated as such by the Securities Valuation Office of the National Association of

Insurance Commissioners (or any successor organization or regulatory agency having similar duties).

Section 13. Governing Law. This Trust Agreement shall be subject to and governed by the laws of the State of New York without regard to its conflict of laws provision and the Trust Account created hereunder shall be administered in accordance with the laws of said state.

Section 14. WAIVER OF JURY TRIAL. EACH PARTY HERETO HEREBY WAIVES TRIAL BY JURY IN ANY JUDICIAL PROCEEDING INVOLVING, DIRECTLY OR INDIRECTLY, ANY MATTER (WHETHER SOUNDING IN TORT, CONTRACT OR OTHERWISE) IN ANY WAY ARISING OUT OF OR RELATED TO THIS AGREEMENT OR THE RELATIONSHIP ESTABLISHED HEREUNDER. THIS PROVISION IS A MATERIAL INDUCEMENT FOR THE PARTIES TO ENTER INTO THIS AGREEMENT.

Section 15. Successors and Assigns. This Trust Agreement shall be binding upon and inure to the benefit of the Parties and their respective successors, permitted assigns and legal representatives. Neither this Trust Agreement, nor any right or obligation hereunder, may be assigned by any Party without the prior written consent of the other Parties hereto. Any assignment in violation of this Section 15 shall be void and shall have no force and effect.

Section 16. Severability. If any provision of this Trust Agreement is held to be void or unenforceable, in whole or in part, (i) such holding shall not affect the validity and enforceability of the remainder of this Trust Agreement, including any other provision, paragraph or subparagraph, and (ii) the Parties agree to attempt in good faith to reform such void or

10

---

unenforceable provision to the extent necessary to render such provision enforceable and to carry out its original intent.

Section 17. Entire Agreement. Except for the Coinsurance Agreements, this Trust Agreement constitutes the entire agreement among the Parties with respect to the subject matter hereof, and there are no understandings or agreements, conditions or qualifications relative to this Trust Agreement which are not fully expressed in this Trust Agreement or the Coinsurance Agreements.

Section 18. Amendments. This Trust Agreement may be modified or otherwise amended, and the observance of any term of this Trust Agreement may be waived, only if such modification, amendment or waiver is in writing and signed by the Parties.

Section 19. Notices. All notices, requests, demands and other communications under this Trust Agreement must be in writing and will be deemed to have been duly given or made as follows: (a) if sent by registered or certified mail in the United States return receipt requested, upon receipt; (b) if sent by reputable overnight air courier, two (2) business days after mailing; (c) if sent by facsimile transmission, with a copy mailed on the same day in the manner provided in (a) or (b) above, when transmitted and receipt is confirmed by telephone; or (d) if otherwise actually personally delivered, when delivered, and shall be delivered as follows:

If to the Grantor:

Union Fidelity Life Insurance Company  
200 North Martingale Road  
Schaumburg, IL 60173-2096  
Facsimile: (847) 330-3404  
Attention: Chief Financial Officer

With a copy to:

Union Fidelity Life Insurance Company  
200 North Martingale Road  
Schaumburg, IL 60173-2096  
Facsimile: (847) 605-3044  
Attention: General Counsel

If to the Beneficiary:

General Electric Capital Assurance Company  
6610 West Broad Street  
Richmond, VA 23230  
Facsimile: (804) 281-6165  
Attention: Chief Executive Officer

11

---

With a copy to:

General Electric Capital Assurance Company  
6620 West Broad Street  
  
Richmond, VA 23230  
  
Facsimile: (804) 662-2414  
Attention: General Counsel

If to the Trustee:

The Bank of New York  
101 Barclay Street - 8W  
New York, NY 10286  
Facsimile: (212) 815-5875  
Attention: Insurance Trust and Escrow Unit

or to such other address or to such other Person as a Party may have last designated by notice to the other Parties.



Section 20. Headings. The headings of the Sections have been inserted for convenience of reference only and shall not be deemed to constitute a part of this Trust Agreement.

Section 21. Counterparts. This Trust Agreement may be executed in any number of counterparts, each of which when so executed and delivered shall constitute an original, but such counterparts together shall constitute but one and the same Trust Agreement.

12

---

**IN WITNESS WHEREOF**, the parties hereto have caused this Trust Agreement to be executed and delivered by their respective officers thereunto duly authorized as of the date first above written.

UNION FIDELITY LIFE INSURANCE COMPANY, as Grantor

By: /s/ GLENN JOPPA  
Name: Glenn Joppa  
Title: Senior Vice President and Secretary

GENERAL ELECTRIC CAPITAL ASSURANCE COMPANY, as Beneficiary

By: /s/ GARY T. PRIZZIA  
Name: Gary T. Prizzia  
Title: Treasurer

THE BANK OF NEW YORK, as Trustee

By: /s/ ROBERT W. RICH  
Name: Robert W. Rich  
Title: Vice President

13

---

**Exhibit A-1**

**CERTIFICATE**

The undersigned, the [insert position] and a duly authorized officer of General Electric Capital Assurance Company, does hereby certify that, pursuant to Section 2 of the Trust Agreement dated as of [ ] entered into by and among General Electric Capital Assurance Company, Union Fidelity Insurance Company and [ ] (the "Trust Agreement") and the Coinsurance Agreement dated as of [ ] between General Electric Capital Assurance Company and Union Fidelity Insurance Company, General Electric Capital Assurance Company is entitled to withdraw from the Trust Account established by Union Fidelity Insurance Company for the benefit of General Electric Capital Assurance Company pursuant to the Trust Agreement, assets with a current statutory book value equal to \$[ ] for the purpose[s] specified in paragraph[s] [ ] and [ ] of Section [ ] of the Coinsurance Agreement.

**[Certification to specify the basis for the withdrawal.]**

This Certificate is a "Beneficiary Certificate" within the meaning of Section 2(a) of the Trust Agreement.

Dated: \_\_\_\_\_

Name: \_\_\_\_\_  
Title: \_\_\_\_\_

14

---

**Exhibit A-2**

**REQUEST FOR WITHDRAWAL**

General Electric Capital Assurance Company ("GECA") hereby requests that [ ] immediately transfer to GECA [/or [ ]] all right, title and interest in those assets set forth on Schedule A attached hereto (which assets have a statutory book value equal to \$[ ]) from the Trust Account established by Union Fidelity Insurance Company ("UFLIC") for the benefit of GECA pursuant to the Trust Agreement dated as of [ , ] entered into by and among GECA, UFLIC and [ ] (the "Trust Agreement"). [Insert transfer instructions.]

This Request for Withdrawal is a "Beneficiary Request for Withdrawal" within the meaning of Section 2(a) of the Trust Agreement, and is made in conjunction with the attached Beneficiary Certificate.

GENERAL ELECTRIC CAPITAL ASSURANCE COMPANY

Dated: \_\_\_\_\_

By: \_\_\_\_\_  
Name: \_\_\_\_\_  
Title: \_\_\_\_\_

15

---

**ELIGIBLE SECURITIES**

Assets of the types for which an Illinois-domiciled life insurance company could obtain full statutory reserve credit under statutory accounting practices prescribed or permitted by the Director of Insurance of the State of Illinois.

**TRUST AGREEMENT**

This TRUST AGREEMENT, dated as of April 15, 2004 (this "Trust Agreement"), among Union Fidelity Insurance Company, an insurance company organized under the Laws of the State of Illinois (the "Grantor"), American Mayflower Life Insurance Company of New York, an insurance company organized under the laws of the State of New York (the "Beneficiary"), and The Bank of New York, a New York corporation (the "Trustee") (the Grantor, the Beneficiary and the Trustee are hereinafter each sometimes referred to individually as a "Party" and collectively as the "Parties"). All terms not defined herein shall have the same meanings as set forth in the Coinsurance Agreement (as hereinafter defined).

**WITNESSETH:**

**WHEREAS**, pursuant to a Coinsurance Agreement of even date herewith between the Beneficiary and the Grantor, the Beneficiary is ceding to the Grantor, and the Grantor is reinsuring on a coinsurance basis, certain of the Beneficiary's liabilities arising under structured settlement annuities (the "Coinsurance Agreement"); and

**WHEREAS**, the Grantor desires to transfer to the Trustee for deposit to a trust account (the "Trust Account") certain assets as security for the payment and performance by the Grantor of its obligations under the Coinsurance Agreement; and

**WHEREAS**, the Trustee has agreed to act as Trustee hereunder, and to hold such assets in trust in the Trust Account for the sole use and benefit of the Beneficiary for such purposes in accordance with the terms and conditions of this Trust Agreement; and

**WHEREAS**, this Trust Agreement is made for the sole use and benefit of the Beneficiary and for the purpose of setting forth the duties and powers of the Trustee with respect to the Trust Account;

**NOW, THEREFORE**, for and in consideration of the premises and for other good and valuable consideration, the receipt of which is hereby acknowledged, the Parties hereby agree as follows:

Section 1. Deposit of Assets to the Trust Account

(a) The Grantor hereby establishes the Trust Account with the Trustee for the sole use and benefit of the Beneficiary, under the terms set forth herein. The Trustee shall administer the Trust Account in its name as Trustee for the sole benefit of the Beneficiary. The Trust Account shall be subject to withdrawal by the Beneficiary solely as provided herein. The Trustee hereby accepts the Trust Account upon the terms set forth in this Trust Agreement.

(b) The Grantor shall transfer to the Trustee, for deposit to the Trust Account, such assets as may be required from time to time pursuant to the Coinsurance Agreement (all such assets are herein referred to individually as an "Asset" and collectively as the "Assets"). The Trustee is authorized and shall have power to receive the Assets from the Grantor and to hold, invest, reinvest and dispose of the same for the uses and purposes of and according to the provisions herein set forth. All Assets shall be maintained by the Trustee in the Trust Account separate and distinct from all other assets on the books of the Trustee and in accordance with the terms of this Trust Agreement. The Assets shall consist only of Eligible Securities (as hereinafter defined). In the event of any payment default as to any Asset in the Trust Account or in the event that any Asset no longer is an Eligible Security, the Grantor shall, within five (5) business days after receiving notice from the Trustee pursuant to Section 19 or the Grantor having knowledge of such default or ineligibility, substitute other Assets which meet the requirements of an Eligible Security and having a statutory book value equal to the statutory book value of such Asset, which has a payment default or no longer meets the requirements for an Eligible Security, on the last statement provided by the Trustee.

(c) The Grantor hereby represents and warrants (i) that, to the extent practicable, any Assets transferred by the Grantor to the Trustee for deposit to the Trust Account will be in such form that the Beneficiary whenever necessary may, and the Trustee upon direction by the Beneficiary will, negotiate any such Assets without consent or signature from the Grantor or any other person or entity in accordance with the terms of this Trust Agreement, (ii) that all Assets transferred by the Grantor to the Trustee for deposit into the Trust Account consist only of Eligible Securities, and (iii) that Grantor has at the time of transfer into this Trust Account good and marketable title to the Assets to be so transferred and each such Asset shall be at the time of transfer free and clear of all claims, liens, interests and encumbrances (other than those arising under this Trust Agreement).

(d) Prior to depositing the Assets into the Trust Account, and from time to time thereafter as required, the Grantor shall execute assignments, endorsement in blank, or transfer legal title to the Trustee of all shares, obligations or other Assets requiring assignments, so that, to the extent practicable, the Beneficiary whenever necessary may, and the Trustee upon the direction by the Beneficiary will, negotiate any such Assets without the consent or signature from the Grantor or any other person or entity. The Grantor shall give all notices and take all actions as the Trustee deems appropriate in order to cause payments due or that become due on any Asset within the Trust Account to be paid to the Trustee. The Grantor shall not make or consent to any waiver, amendment or restriction on transfer with respect to any Asset in the Trust Account, in each case without the Beneficiary's prior written consent. In connection with the deposit of Assets into the Trust Account, the Grantor shall furnish to the Trustee all original documentation evidencing the Grantor's ownership thereto.

(e) The parties recognize that certain Assets will not be readily negotiable and that certain notices, opinions of counsel, representations and/or consents will be required for the Beneficiary to obtain good and marketable title to such Assets.

Section 2. Withdrawal of Assets from the Trust Account

(a) Without notice to the Grantor, the Beneficiary shall have the right, at any time and from time to time, to withdraw from the Trust Account, upon notice to the Trustee in the form of a certificate substantially in the form of Exhibit A-1 attached hereto (the "Beneficiary Certificate"), signed by a duly authorized officer of the Beneficiary, accompanied by a request for withdrawal substantially in the form of Exhibit A-2 hereto (the "Beneficiary Request for Withdrawal"), signed by a duly authorized officer of the Beneficiary, such Assets as are specified in such Beneficiary Request for Withdrawal. The Beneficiary Request for Withdrawal may designate a third party (the "Beneficiary Designee"), including the Grantor, to whom Assets specified therein shall be delivered. The Beneficiary shall not be required to present any other statement or document in addition to a Beneficiary Certificate and a Beneficiary Request for Withdrawal in order to withdraw any Assets, except that the Beneficiary shall acknowledge receipt of any such Assets withdrawn upon request by the Trustee.

(b) Upon receipt of a Beneficiary Certificate and a Beneficiary Request for Withdrawal, subject to the provision by the Beneficiary of any required notices, opinions of counsel and representations, the Trustee and the Grantor shall use commercially reasonable efforts to transfer absolutely and unequivocally all right, title and interest in the Assets specified in such Beneficiary Request for Withdrawal and shall deliver physical custody (or such other form as is necessary to complete the transfer) of such Assets to or for the account of the Beneficiary or such Beneficiary Designee, as specified in such Beneficiary Request for Withdrawal. The Trustee shall notify the Grantor and Beneficiary within three (3) business days following each withdrawal from the Trust Account.

(c) Subject to Section 4, in the absence of a Beneficiary Certificate and a Beneficiary Request for Withdrawal, the Trustee shall allow no substitution or withdrawal of any Asset from the Trust Account.

(d) The Trustee shall notify the insurance regulator in the state where the Beneficiary is domiciled within three (3) business days after all the assets in the Trust Account are withdrawn. At the Trustee's request, the Beneficiary shall provide to the Trustee the address of the insurance regulator in the state where the Beneficiary is domiciled.

Section 3. Application of Assets. The Beneficiary shall be permitted to withdraw Assets from the Trust Account only for the purposes set forth in the Coinsurance Agreement.

Section 4. Redemption, Investment and Substitution of Assets.

(a) The Trustee shall surrender for payment all maturing Assets and all Assets called for redemption, and deposit the principal amount of the proceeds of any such payment to the Trust Account.

(b) The Grantor, subject to the prior written approval of the Beneficiary, may retain (and pay the service fees of) a professional asset manager (the "Asset Manager") to manage and make investment decisions with regard to the Assets held by the Trustee in the Trust Account. From time to time, at the written order and direction of the Grantor or the Asset Manager, the Trustee shall invest Assets in the Trust Account in Eligible Securities.

3

---

(c) From time to time, subject to the prior written approval of the Beneficiary, the Grantor or the Asset Manager may direct the Trustee to substitute Assets of equal statutory book value for other Assets presently held in the Trust Account. The Trustee shall have no responsibility whatsoever to determine the value of such substituted Assets or that such substituted Assets constitute Eligible Securities.

(d) All investments and substitutions of securities referred to in Sections 4(b) and 4(c) above shall be in compliance with the definition of "Eligible Securities" in Section 12 of this Trust Agreement. Any instruction or order concerning such investments or substitutions of securities shall be referred to herein as an "Investment Order". The Trustee shall execute Investment Orders and settle securities transactions by itself or by means of an agent or broker. The Trustee shall not be responsible for any act or omission, or for the solvency, of any such agent or broker, except as set forth in Section 7.

(e) From time to time, upon notice to the Beneficiary, the Trustee may withdraw any Asset in the Trust Account upon the call or maturity of such Asset provided that the proceeds from such call or maturity are deposited into the Trust Account.

(f) When the Trustee is directed to deliver Assets against payment, delivery will be made in accordance with generally accepted market practice.

(g) Any loss incurred from any investment pursuant to the terms of this Section 4 shall be borne exclusively by the Trust Account.

(h) The Trustee shall not foreclose on, or direct or consent to the foreclosure of, any real property securing a commercial loan constituting an Asset or take title to such property by deed-in-lieu of foreclosure or other means without the prior written consent of the Grantor and the Beneficiary. The Trustee shall not provide any consent or direction with respect to any such commercial loan except at the written direction of the Grantor.

Section 5. The Income Account. All payments of interest, dividends and other income in respect to Assets in the Trust Account shall be the property of the Grantor and shall be deposited by the Trustee subject to deduction of the Trustee's compensation and expenses as provided in Section 9 of this Agreement in a separate account (the "Income Account") established and maintained by the Grantor at an office of the Trustee. The Grantor may withdraw amounts from the Income Account at any time and from time to time.

Section 6. Right to Vote Assets. The Trustee shall forward all annual and interim stockholder reports and all proxies and proxy materials relating to the Assets in the Trust Account to the Grantor within a reasonable period of time following the Trustee's receipt thereof. The Grantor shall have the full and unqualified right to vote any Asset in the Trust Account.

Section 7. Additional Rights and Duties of the Trustee.

(a) Before accepting any Asset for deposit to the Trust Account, the Trustee shall determine that such Asset is in such form that, to the extent practicable, the Beneficiary whenever necessary may, or the Trustee upon direction by the Beneficiary will, negotiate such

4

---

Asset without consent or signature from the Grantor or any person or entity other than the Trustee in accordance with the terms of this Trust Agreement.

(b) The Trustee shall be under no obligation to determine whether or not any instructions given by the Grantor and Beneficiary are contrary to any provision of law. It is understood and agreed that the Trustee's duties are solely those set forth herein and that the Trustee shall have no duty to take any other action unless specifically agreed to by the Trustee in writing. Without limiting the generality of the foregoing, the Trustee shall not have any duty to advise, manage, supervise or make recommendations with respect to the purchase, retention or sale of Assets with respect to any Assets in the Trust Account as to which a default in the payment of principal or interest has occurred or to be responsible for the consequences of insolvency or the legal inability of any broker, dealer, bank or other agent employed by the Grantor or Trustee with respect to the Assets except to the extent that the Trustee was negligent, engaged in misconduct or acted in bad faith in the selection of any such person or entity.

(c) The Trustee shall accept and open all mail directed to the Grantor or the Beneficiary in care of the Trustee.

(d) The Trustee shall have no responsibility whatsoever to determine that any Assets in the Trust Account are or continue to be Eligible Securities.

(e) The Trustee shall furnish to the Grantor and the Beneficiary a statement of all Assets in the Trust Account upon the inception of the Trust Account and at the end of each calendar month thereafter. The statement shall include a description of the Assets in the Trust Account and shall be delivered within five (5) business days following the end of such calendar month.

(f) The Trustee shall keep full and complete records of the administration of the Trust Account in accordance with all applicable law. Upon the request of the Grantor or the Beneficiary, the Trustee shall promptly permit the Grantor or the Beneficiary, their respective agents, employees, independent auditors and regulatory authorities to examine, audit, excerpt, transcribe and copy, during the Trustee's normal business hours, any books, documents, papers and records relating to the Trust Account or the Assets.

(g) Unless otherwise provided in this Trust Agreement, the Trustee is authorized to follow and rely upon all instructions given by officers of the Grantor or the Beneficiary and by attorneys-in-fact acting under written authority furnished to the Trustee by the Grantor or the Beneficiary, including, without limitation, instructions given

by letter, facsimile transmission or electronic media, if the Trustee believes such instructions to be genuine and to have been signed, sent or presented by the proper party or parties. In the absence of negligence, the Trustee shall not incur any liability to anyone resulting from actions taken by the Trustee in reliance in good faith on such instructions. The Trustee shall not incur any liability in executing instructions (i) from any attorney-in-fact prior to receipt by it of notice of the revocation of the written authority of the attorney-in-fact or (ii) from any officer of the Grantor or the Beneficiary.

5

(h) The duties and obligations of the Trustee shall only be such as are specifically set forth in this Trust Agreement, as it may from time to time be amended, and no implied duties or obligations shall be read into this Trust Agreement against the Trustee.

(i) No provision of this Trust Agreement shall require the Trustee to take any action which, in the Trustee's reasonable judgment, would result in any violation of this Trust Agreement or any provision of law.

(j) The Trustee may confer with counsel of its own choice in relation to matters arising under this Trust Agreement and shall have full and complete authorization from the other Parties for any action taken or suffered by it under this Trust Agreement or in respect of any transaction contemplated hereby in good faith and in accordance with the opinion of such counsel.

(k) The Trustee shall notify the Grantor and Beneficiary in writing of any payment default occurring as to any Asset within three (3) business days after Trustee receives notice of such default. In the event of a delinquency of a timely payment in regard to any of the Assets, the Trustee shall inform the Grantor and the Beneficiary immediately upon Trustee's receipt of notice of such delinquency.

(l) Notwithstanding any provision of this Agreement to the contrary, the Trustee shall be liable for (i) subject to Section 7(n), the safekeeping of the Assets and administering the Trust Account in accordance with the provisions of this Trust Agreement and (ii) its own negligence, willful misconduct or lack of good faith in performing its duties under this Trust Agreement. The Trustee shall exercise the standard of care with respect to the Assets that a professional trustee, engaged in the banking or trust company industry, having professional expertise in financial and securities processing transactions and custody would observe in such affairs. The Trustee shall be strictly liable for physical loss of or damage to Assets under its care, custody, possession or control or the care, custody, possession or control of its subcustodians, other agents or nominee(s), including but not limited to loss due to fire, burglary, robbery, theft or mysterious disappearance. In the event of loss or damage to the Assets under the care, custody, possession or control of Trustee or its subcustodians, other agents or nominee(s), Trustee shall, upon demand of the Grantor or Beneficiary, promptly replace such Assets with like kind and quality together with, all rights and privileges pertaining to the Assets (by among other methods, posting appropriate security or bond with the issuer of the Assets to obtain reissue of such Assets, or, if acceptable to the Grantor, deliver cash equivalent to the market value of the Assets as of the date of the discovery of the loss or damage). Nothing contained in any contract between Trustee and any entity authorized to hold Assets, as defined herein, shall diminish or otherwise alter the liability of Trustee to the Grantor or Beneficiary. The provisions of this paragraph shall not affect the burden of proof under applicable law with respect to the assertions of liability in any claim, action or dispute alleging any breach of or failure to observe such standard of care.

(m) The Trustee shall not be responsible for the existence, genuineness or value of any of the Assets, for the validity, perfection, priority or enforceability of the liens in or with respect to any of the Assets, for the validity of title to the Assets, for insuring the Assets, for the payment of taxes, charges, assessments or liens upon or with respect to the Assets, for any obligations

6

under any agreements or other documents evidencing or related to any of the Assets (other than this Trust Agreement), or for the compliance of the Assets with any laws, including any Environmental Law (as hereinafter defined). The Trustee shall have no responsibility for the recording, filing or registration (or for the rerecording, refiling or reregistration) of any instrument or notice, including any financing or continuation statement or any tax or securities form, at any time in any public office or elsewhere for the purpose of perfecting, maintaining the perfection of or otherwise making effective any lien upon or with respect to any of the Assets.

(n) The Parties acknowledge and agree that certain of the Assets are and will continue to be subject to servicing and custodial agreements in effect on the date hereof (as amended or otherwise modified from time to time, including any replacements thereof, the "Servicing/Custodial Agreements"). The Grantor and the Beneficiary acknowledge and agree that (i) the Trustee shall have no liability under this Trust Agreement for any action or omission of any of the parties to the Servicing/Custodial Agreements, including with respect to any of the Assets at any time during which such Assets are under the care, custody, possession or control of any of the parties to the Servicing/Custodial Agreements or any of their respective depositories, subcustodians, other agents or nominees (and, solely for the purposes of limiting the liability and determining the duties of the Trustee under Section 7(l), none of such Persons shall be considered to be the depositories, subcustodians, agents or nominees of the Trustee), (ii) the performance by the Trustee of any of its obligations under this Trust Agreement may be delayed, limited or otherwise affected by the actions or omissions of any of the parties to the Servicing/Custodial Agreements or as a result of the Assets being subject to the Servicing/Custodial Agreements and (iii) the Trustee shall have no liability under this Trust Agreement as a result of the Trustee's failure to perform any of its obligations under this Trust Agreement as a result of the actions or omissions of any of the parties to the Servicing/Custodial Agreements or as a result of the Assets being subject to the Servicing/Custodial Agreements.

Section 8. Representations, Warranties and Covenants of the Trustee. The Trustee represents, warrants and covenants to the Grantor and Beneficiary that:

- (a) The Trustee is a Qualified United States Financial Institution;
- (b) In the ordinary course of its business, the Trustee maintains securities accounts for others and is acting in that capacity in this Trust Agreement;
- (c) The Trust Account is and at all times shall be maintained at an office of the Trustee in the United States of America;
- (d) The Trustee is not an Affiliate of the Grantor or the Beneficiary.

Section 9. The Trustee's Compensation; Expenses.

(a) The Grantor shall pay the Trustee, as compensation for its services under this Trust Agreement, a fee computed at rates determined by the Trustee from time to time and communicated in writing to the Grantor. The Grantor shall pay or reimburse the Trustee for all of the Trustee's expenses and disbursements in connection with its duties under this Trust Agreement (including reasonable attorney's fees and expenses), except any such expense or disbursement as may arise from the Trustee's negligence, willful misconduct, lack of good faith

7

or failure to administer the Trust Account in accordance with the terms of this Trust Agreement. The Trustee shall be entitled to deduct its compensation and expenses from payments of dividends, interest and other income in respect of the Assets held in the Trust Account prior to the deposit thereof to the Income Account as provided in Section 5 of this Agreement. The Grantor also hereby indemnifies the Trustee for, and holds it harmless against, any loss, liability, costs or expenses (including reasonable attorney's fees and expenses) incurred or made without negligence, willful misconduct or lack of good faith on the part of the Trustee, arising out of or in connection with the

performance of its obligations in accordance with the provisions of this Trust Agreement (which shall be the sole obligation of the Trustee), including any loss, liability, costs or expenses arising out of or in connection with the status of the Trustee and its nominee as the holder of record of the Assets. The Grantor hereby acknowledges that the foregoing indemnities shall survive the resignation of the Trustee or the termination of this Trust Agreement and hereby grants the Trustee a lien, right of set-off and security interest in the funds in the Income Account for the payment of any claim for compensation, reimbursement or indemnity hereunder.

(b) No Assets shall be withdrawn from the Trust Account or used in any manner for paying compensation to, or reimbursement or indemnification of, the Trustee.

(c) In addition to, and without limiting, the Grantor's indemnification obligations set forth in Section 9(a), to the extent resulting from or in connection with the execution, delivery, enforcement, performance, or administration of this Trust Agreement, the Grantor shall defend, indemnify, and hold harmless the Trustee and its employees, officers, directors and agents from and against any claims, demands, penalties, fines, liabilities, settlements, damages, costs, or expenses of whatever kind or nature, known or unknown, contingent or otherwise, arising out of, or in any way related to, (i) the presence, disposal, release, or threatened release of any Hazardous Materials which are on, from, or affecting soil, water, vegetation, buildings, personal property, persons, animals, or otherwise; (ii) any personal injury (including wrongful death), property damage (real or personal) or natural resource damage arising out of or related to such Hazardous Materials; (iii) any third party claim brought or threatened, settlement reached, or government order, or any policies or requirements of the Trustee, which are based upon or in any way related to such Hazardous Materials, including, without limitation, attorney and consultant fees and expenses, investigation and laboratory fees, court costs, and litigation expenses, and (iv) any violations of Environmental Law, except, in each instance, to the extent arising from the negligence, willful misconduct or lack of good faith of the Trustee. The Grantor hereby acknowledges that the foregoing indemnities shall survive the resignation of the Trustee or the termination of this Trust Agreement and hereby grants the Trustee a lien, right of set-off and security interest in the funds in the Income Account for the payment of any claim for compensation, reimbursement or indemnity hereunder. For purposes hereof:

"Hazardous Materials" means, without limit, any pollutant, contaminant or hazardous, toxic, medical, biohazardous, or dangerous waste, substance, constituent or material, defined or regulated as such in, or for the purpose of, any applicable Environmental Law, including, without limitation, any asbestos, any petroleum, oil (including crude oil or any fraction thereof), any radioactive substance, any polychlorinated biphenyls, any toxin, chemical, disease-causing agent or pathogen, and any other substance that gives rise to liability under any applicable Environmental Law; and

8

---

"Environmental Law" means the Comprehensive Environmental Response, Compensation and Liability Act, as amended ("CERCLA"), the Resource Conservation and Recovery Act of 1976, as amended, and any other applicable federal, state, local, or foreign statute, rule, regulation, order, judgment, directive, decree, permit, license or common law as in effect now, previously, or at any time during the term of this Trust Agreement, and regulating, relating to, or imposing liability or standards of conduct concerning air emissions, water discharges, noise emissions, the release or threatened release or discharge of any Hazardous Material into the environment, the use, manufacture, production, refinement, generation, handling, treatment, storage, transport or disposal of any Hazardous Material or otherwise concerning pollution or the protection of the outdoor or indoor environment, or human health or safety in relation to exposure to Hazardous Materials.

#### Section 10. Resignation or Removal of the Trustee.

(a) The Trustee may resign at any time upon delivery of a written notice thereof to the Beneficiary and to the Grantor effective not less than 90 days after receipt by the Beneficiary and the Grantor of such notice. The Trustee may be removed by prior written notice executed by Grantor and Beneficiary. No such resignation or removal shall become effective until a successor Trustee has been appointed and approved by the Beneficiary and the Grantor and all Assets in the Trust Account have been duly transferred to the successor Trustee in accordance with paragraph (b) of this Section 10.

(b) Upon receipt by the proper Parties of the Trustee's notice of resignation or the Grantor's and Beneficiary's notice of removal, the Grantor and the Beneficiary shall appoint a successor Trustee. Any successor Trustee shall be a bank that is a member of the Federal Reserve System and a Qualified United States Financial Institution, and shall not be an Affiliate of the Grantor or the Beneficiary. Upon the acceptance of the appointment as Trustee hereunder by a successor Trustee and the transfer to such successor Trustee of all Assets in the Trust Account, the resignation or removal of the Trustee shall become effective. Thereupon, such successor Trustee shall succeed to and become vested with all the rights, powers, privileges and duties of the resigning or removed Trustee, and the resigning or removed Trustee shall be discharged from any future duties and obligations under this Trust Agreement, but the resigning or removed Trustee shall continue after such resignation or removal to be entitled to the benefits of the indemnities provided herein for the Trustee.

#### Section 11. Termination of the Trust Account.

(a) The Trust Account and this Trust Agreement, except for the indemnities provided herein, may be terminated only after the Grantor and Beneficiary mutually give the Trustee written notice of their intention to terminate the Trust Account (the "Notice of Intention"). The Notice of Intention shall specify the date on which the Parties intend the Trust Account to terminate (the "Termination Date").

(b) On the Termination Date, the Trustee shall transfer to the Grantor all of the Assets not previously withdrawn by the Beneficiary.

9

---

Section 12. Definitions. Except as the context shall otherwise require, the following terms shall have the following meanings for purposes of this Trust Agreement (the definitions to be applicable to both the singular and the plural forms of each term defined if both forms of such term are used in this Trust Agreement):

The term "Affiliate" means any other Person that directly or indirectly controls, is controlled by, or is under common control with, the first Person.

The term "Beneficiary" shall include any successor of the Beneficiary by operation of law including, without limitation, any liquidator, rehabilitator, receiver or conservator.

The term "Control" (including the related terms "controlled by" and "under common control with") shall mean the ownership, directly or indirectly, of more than 50% of the voting securities of a corporation.

The term "Eligible Securities" shall mean and include certificates of deposit (issued by a United States bank and payable in United States legal tender) and other assets of the types specified on Exhibit B attached hereto.

The terms "Person" shall mean and include an individual, a corporation, a partnership, an association, a trust, an unincorporated organization or a government or political subdivision thereof.

The term "Qualified United States Financial Institution" shall mean a bank designated as such by the Securities Valuation Office of the National Association of Insurance Commissioners (or any successor organization or regulatory agency having similar duties).

Section 13. Governing Law. This Trust Agreement shall be subject to and governed by the laws of the State of New York without regard to its conflict of laws provision and the Trust Account created hereunder shall be administered in accordance with the laws of said state.

Section 14. WAIVER OF JURY TRIAL. EACH PARTY HERETO HEREBY WAIVES TRIAL BY JURY IN ANY JUDICIAL PROCEEDING INVOLVING, DIRECTLY OR INDIRECTLY, ANY MATTER (WHETHER SOUNDING IN TORT, CONTRACT OR OTHERWISE) IN ANY WAY ARISING OUT OF OR RELATED TO THIS AGREEMENT OR THE RELATIONSHIP ESTABLISHED HEREUNDER. THIS PROVISION IS A MATERIAL INDUCEMENT FOR THE PARTIES TO ENTER INTO THIS AGREEMENT.

Section 15. Successors and Assigns. This Trust Agreement shall be binding upon and inure to the benefit of the Parties and their respective successors, permitted assigns and legal representatives. Neither this Trust Agreement, nor any right or obligation hereunder, may be assigned by any Party without the prior written consent of the other Parties hereto. Any assignment in violation of this Section 15 shall be void and shall have no force and effect.

Section 16. Severability. If any provision of this Trust Agreement is held to be void or unenforceable, in whole or in part, (i) such holding shall not affect the validity and enforceability of the remainder of this Trust Agreement, including any other provision, paragraph or subparagraph, and (ii) the Parties agree to attempt in good faith to reform such void or

10

---

unenforceable provision to the extent necessary to render such provision enforceable and to carry out its original intent.

Section 17. Entire Agreement. Except for the Coinsurance Agreement, this Trust Agreement constitutes the entire agreement among the Parties with respect to the subject matter hereof, and there are no understandings or agreements, conditions or qualifications relative to this Trust Agreement which are not fully expressed in this Trust Agreement or the Coinsurance Agreement.

Section 18. Amendments. This Trust Agreement may be modified or otherwise amended, and the observance of any term of this Trust Agreement may be waived, only if such modification, amendment or waiver is in writing and signed by the Parties.

Section 19. Notices. All notices, requests, demands and other communications under this Trust Agreement must be in writing and will be deemed to have been duly given or made as follows: (a) if sent by registered or certified mail in the United States return receipt requested, upon receipt; (b) if sent by reputable overnight air courier, two (2) business days after mailing; (c) if sent by facsimile transmission, with a copy mailed on the same day in the manner provided in (a) or (b) above, when transmitted and receipt is confirmed by telephone; or (d) if otherwise actually personally delivered, when delivered, and shall be delivered as follows:

If to the Grantor:

Union Fidelity Life Insurance Company  
200 North Martingale Road  
Schaumburg, IL 60173-2096  
Facsimile: (847) 330-3404  
Attention: Chief Financial Officer

With a copy to:

Union Fidelity Life Insurance Company  
200 North Martingale Road  
Schaumburg, IL 60173-2096  
Facsimile: (847) 605-3044  
Attention: General Counsel

If to the Beneficiary:

American Mayflower Life Insurance Company of New York  
700 Main Street  
Lynchburg, VA 24504  
Facsimile: (434) 948-5064  
Attention: Chief Executive Officer

11

---

With a copy to:

American Mayflower Life Insurance Company of New York  
700 Main Street  
Lynchburg, VA 24504  
Facsimile: (434) 948-5819  
Attention: General Counsel

If to the Trustee:

The Bank of New York  
101 Barclay Street - 8W  
New York, NY 10286  
Facsimile: (212) 815-5875  
Attention: Insurance Trust and Escrow Unit

or to such other address or to such other Person as a Party may have last designated by notice to the other Parties.

Section 20. Headings. The headings of the Sections have been inserted for convenience of reference only and shall not be deemed to constitute a part of this Trust Agreement.

Section 21. Counterparts. This Trust Agreement may be executed in any number of counterparts, each of which when so executed and delivered shall constitute an original, but such counterparts together shall constitute but one and the same Trust Agreement.

IN WITNESS WHEREOF, the parties hereto have caused this Trust Agreement to be executed and delivered by their respective officers thereunto duly authorized as of the date first above written.

UNION FIDELITY LIFE INSURANCE COMPANY, as Grantor

By: /s/ GLENN JOPPA  
Name: Glenn Joppa  
Title: Senior Vice President and Secretary

AMERICAN MAYFLOWER LIFE INSURANCE COMPANY OF NEW YORK, as Beneficiary

By: /s/ GARY T. PRIZZIA  
Name: Gary T. Prizzia  
Title: Treasurer

THE BANK OF NEW YORK, as Trustee

By: /s/ ROBERT W. RICH  
Name: Robert W. Rich  
Title: Vice President

Exhibit A-1

**CERTIFICATE**

The undersigned, the [insert position] and a duly authorized officer of American Mayflower Life Insurance Company of New York, does hereby certify that, pursuant to Section 2 of the Trust Agreement dated as of [ ] entered into by and among American Mayflower Life Insurance Company of New York, Union Fidelity Life Insurance Company and [ ] (the "Trust Agreement") and the Coinsurance Agreement dated as of [ ] between American Mayflower Life Insurance Company of New York and Union Fidelity Life Insurance Company, American Mayflower Life Insurance Company of New York is entitled to withdraw from the Trust Account established by Union Fidelity Life Insurance Company for the benefit of American Mayflower Life Insurance Company of New York pursuant to the Trust Agreement, assets with a current statutory book value equal to \$[ ] for the purpose[s] specified in paragraph[s] [ ] and [ ] of Section [ ] of the Coinsurance Agreement.

**[Certification to specify the basis for the withdrawal.]**

This Certificate is a "Beneficiary Certificate" within the meaning of Section 2(a) of the Trust Agreement.

Dated: \_\_\_\_\_

\_\_\_\_\_  
Name:  
Title:

Exhibit A-2

**REQUEST FOR WITHDRAWAL**

American Mayflower Life Insurance Company of New York ("AML") hereby requests that [ ] immediately transfer to AML [/or [ ]] all right, title and interest in those assets set forth on Schedule A attached hereto (which assets have a statutory book value equal to \$[ ]) from the Trust Account established by Union Fidelity Life Insurance Company ("UFLIC") for the benefit of AML pursuant to the Trust Agreement dated as of [ , ] entered into by and among AML, UFLIC and [ ] (the "Trust Agreement"). [Insert transfer instructions.]

This Request for Withdrawal is a "Beneficiary Request for Withdrawal" within the meaning of Section 2(a) of the Trust Agreement, and is made in conjunction with the attached Beneficiary Certificate.

AMERICAN MAYFLOWER LIFE INSURANCE COMPANY OF NEW YORK

Dated: \_\_\_\_\_

By: \_\_\_\_\_  
Name:  
Title:

Exhibit B

**ELIGIBLE SECURITIES**



Assets of the types for which an Illinois-domiciled life insurance company could obtain full statutory reserve credit under statutory accounting practices prescribed or permitted by the Director of Insurance of the State of Illinois.

**TRUST AGREEMENT**

This TRUST AGREEMENT, dated as of April 15, 2004 (this "Trust Agreement"), among Union Fidelity Life Insurance Company, an insurance company organized under the Laws of the State of Illinois (the "Grantor"), GE Life and Annuity Assurance Company, an insurance company organized under the laws of the Commonwealth of Virginia (the "Beneficiary"), and The Bank of New York, a New York corporation (the "Trustee") (the Grantor, the Beneficiary and the Trustee are hereinafter each sometimes referred to individually as a "Party" and collectively as the "Parties"). All terms not defined herein shall have the same meanings as set forth in the Coinsurance Agreements (as hereinafter defined).

**WITNESSETH:**

**WHEREAS**, pursuant to a Coinsurance Agreement of even date herewith between the Beneficiary and the Grantor, the Beneficiary is ceding to the Grantor, and the Grantor is reinsuring on a coinsurance basis, certain of the Beneficiary's liabilities arising under structured settlement annuities, and pursuant to a Reinsurance Agreement, also of even date herewith between the Beneficiary and the Grantor, the Beneficiary is ceding to the Grantor, and the Grantor is reinsuring on a modified coinsurance basis (with respect to separate account liabilities) and on a coinsurance basis (with respect to general account liabilities), certain of the Beneficiary's liabilities arising under variable annuities (collectively, the "Coinsurance Agreements"); and

**WHEREAS**, the Grantor desires to transfer to the Trustee for deposit to a trust account (the "Trust Account") certain assets as security for the payment and performance by the Grantor of its obligations under the Coinsurance Agreements; and

**WHEREAS**, the Trustee has agreed to act as Trustee hereunder, and to hold such assets in trust in the Trust Account for the sole use and benefit of the Beneficiary for such purposes in accordance with the terms and conditions of this Trust Agreement; and

**WHEREAS**, this Trust Agreement is made for the sole use and benefit of the Beneficiary and for the purpose of setting forth the duties and powers of the Trustee with respect to the Trust Account;

**NOW, THEREFORE**, for and in consideration of the premises and for other good and valuable consideration, the receipt of which is hereby acknowledged, the Parties hereby agree as follows:

**Section 1. Deposit of Assets to the Trust Account**

(a) The Grantor hereby establishes the Trust Account with the Trustee for the sole use and benefit of the Beneficiary, under the terms set forth herein. The Trustee shall administer

the Trust Account in its name as Trustee for the sole benefit of the Beneficiary. The Trust Account shall be subject to withdrawal by the Beneficiary solely as provided herein. The Trustee hereby accepts the Trust Account upon the terms set forth in this Trust Agreement.

(b) The Grantor shall transfer to the Trustee, for deposit to the Trust Account, such assets as may be required from time to time pursuant to the Coinsurance Agreements (all such assets are herein referred to individually as an "Asset" and collectively as the "Assets"). The Trustee is authorized and shall have power to receive the Assets from the Grantor and to hold, invest, reinvest and dispose of the same for the uses and purposes of and according to the provisions herein set forth. All Assets shall be maintained by the Trustee in the Trust Account separate and distinct from all other assets on the books of the Trustee and in accordance with the terms of this Trust Agreement. The Assets shall consist only of Eligible Securities (as hereinafter defined). In the event of any payment default as to any Asset in the Trust Account or in the event that any Asset no longer is an Eligible Security, the Grantor shall, within five (5) business days after receiving notice from the Trustee pursuant to Section 19 or the Grantor having knowledge of such default or ineligibility, substitute other Assets which meet the requirements of an Eligible Security and having a statutory book value equal to the statutory book value of such Asset, which has a payment default or no longer meets the requirements for an Eligible Security, on the last statement provided by the Trustee.

(c) The Grantor hereby represents and warrants (i) that, to the extent practicable, any Assets transferred by the Grantor to the Trustee for deposit to the Trust Account will be in such form that the Beneficiary whenever necessary may, and the Trustee upon direction by the Beneficiary will, negotiate any such Assets without consent or signature from the Grantor or any other person or entity in accordance with the terms of this Trust Agreement, (ii) that all Assets transferred by the Grantor to the Trustee for deposit into the Trust Account consist only of Eligible Securities, and (iii) that Grantor has at the time of transfer into this Trust Account good and marketable title to the Assets to be so transferred and each such Asset shall be at the time of transfer free and clear of all claims, liens, interests and encumbrances (other than those arising under this Trust Agreement).

(d) Prior to depositing the Assets into the Trust Account, and from time to time thereafter as required, the Grantor shall execute assignments, endorsement in blank, or transfer legal title to the Trustee of all shares, obligations or other Assets requiring assignments, so that, to the extent practicable, the Beneficiary whenever necessary may, and the Trustee upon the direction by the Beneficiary will, negotiate any such Assets without the consent or signature from the Grantor or any other person or entity. The Grantor shall give all notices and take all actions as the Trustee deems appropriate in order to cause payments due or that become due on any Asset within the Trust Account to be paid to the Trustee. The Grantor shall not make or consent to any waiver, amendment or restriction on transfer with respect to any Asset in the Trust Account, in each case without the Beneficiary's prior written consent. In connection with the deposit of Assets into the Trust Account, the Grantor shall furnish to the Trustee all original documentation evidencing the Grantor's ownership thereto.

(e) The parties recognize that certain Assets will not be readily negotiable and that certain notices, opinions of counsel, representations and/or consents will be required for the Beneficiary to obtain good and marketable title to such Assets.

**Section 2. Withdrawal of Assets from the Trust Account**

(a) Without notice to the Grantor, the Beneficiary shall have the right, at any time and from time to time, to withdraw from the Trust Account, upon notice to the Trustee in the form of a certificate substantially in the form of Exhibit A-1 attached hereto (the "Beneficiary Certificate"), signed by a duly authorized officer of the Beneficiary, accompanied by a request for withdrawal substantially in the form of Exhibit A-2 hereto (the "Beneficiary Request for Withdrawal"), signed by a duly authorized officer of the Beneficiary, such Assets as are specified in such Beneficiary Request for Withdrawal. The Beneficiary Request for Withdrawal may designate a third party (the "Beneficiary Designee"), including the Grantor, to whom Assets specified therein shall be delivered. The Beneficiary shall not be required to present any other statement or document in addition to a Beneficiary Certificate and a Beneficiary Request for Withdrawal in order to withdraw any Assets, except that the Beneficiary shall acknowledge receipt of any such Assets withdrawn upon request by the Trustee.

(b) Upon receipt of a Beneficiary Certificate and a Beneficiary Request for Withdrawal, subject to the provision by the Beneficiary of any required notices,

opinions of counsel and representations, the Trustee and the Grantor shall use commercially reasonable efforts to transfer absolutely and unequivocally all right, title and interest in the Assets specified in such Beneficiary Request for Withdrawal and shall deliver physical custody (or such other form as is necessary to complete the transfer) of such Assets to or for the account of the Beneficiary or such Beneficiary Designee, as specified in such Beneficiary Request for Withdrawal. The Trustee shall notify the Grantor and Beneficiary within three (3) business days following each withdrawal from the Trust Account.

(c) Subject to Section 4, in the absence of a Beneficiary Certificate and a Beneficiary Request for Withdrawal, the Trustee shall allow no substitution or withdrawal of any Asset from the Trust Account.

(d) The Trustee shall notify the insurance regulator in the state where the Beneficiary is domiciled within three (3) business days after all the assets in the Trust Account are withdrawn. At the Trustee's request, the Beneficiary shall provide to the Trustee the address of the insurance regulator in the state where the Beneficiary is domiciled.

Section 3. Application of Assets. The Beneficiary shall be permitted to withdraw Assets from the Trust Account only for the purposes set forth in the Coinsurance Agreements.

Section 4. Redemption, Investment and Substitution of Assets.

(a) The Trustee shall surrender for payment all maturing Assets and all Assets called for redemption, and deposit the principal amount of the proceeds of any such payment to the Trust Account.

(b) The Grantor, subject to the prior written approval of the Beneficiary, may retain (and pay the service fees of) a professional asset manager (the "Asset Manager") to manage and make investment decisions with regard to the Assets held by the Trustee in the Trust Account. From time to time, at the written order and direction of the Grantor or the Asset Manager, the Trustee shall invest Assets in the Trust Account in Eligible Securities.

3

---

(c) From time to time, subject to the prior written approval of the Beneficiary, the Grantor or the Asset Manager may direct the Trustee to substitute Assets of equal statutory book value for other Assets presently held in the Trust Account. The Trustee shall have no responsibility whatsoever to determine the value of such substituted Assets or that such substituted Assets constitute Eligible Securities.

(d) All investments and substitutions of securities referred to in Sections 4(b) and 4(c) above shall be in compliance with the definition of "Eligible Securities" in Section 12 of this Trust Agreement. Any instruction or order concerning such investments or substitutions of securities shall be referred to herein as an "Investment Order". The Trustee shall execute Investment Orders and settle securities transactions by itself or by means of an agent or broker. The Trustee shall not be responsible for any act or omission, or for the solvency, of any such agent or broker, except as set forth in Section 7.

(e) From time to time, upon notice to the Beneficiary, the Trustee may withdraw any Asset in the Trust Account upon the call or maturity of such Asset provided that the proceeds from such call or maturity are deposited into the Trust Account.

(f) When the Trustee is directed to deliver Assets against payment, delivery will be made in accordance with generally accepted market practice.

(g) Any loss incurred from any investment pursuant to the terms of this Section 4 shall be borne exclusively by the Trust Account.

(h) The Trustee shall not foreclose on, or direct or consent to the foreclosure of, any real property securing a commercial loan constituting an Asset or take title to such property by deed-in-lieu of foreclosure or other means without the prior written consent of the Grantor and the Beneficiary. The Trustee shall not provide any consent or direction with respect to any such commercial loan except at the written direction of the Grantor.

Section 5. The Income Account. All payments of interest, dividends and other income in respect to Assets in the Trust Account shall be the property of the Grantor and shall be deposited by the Trustee subject to deduction of the Trustee's compensation and expenses as provided in Section 9 of this Agreement, in a separate account (the "Income Account") established and maintained by the Grantor at an office of the Trustee. The Grantor may withdraw amounts from the Income Account at any time and from time to time.

Section 6. Right to Vote Assets. The Trustee shall forward all annual and interim stockholder reports and all proxies and proxy materials relating to the Assets in the Trust Account to the Grantor within a reasonable period of time following the Trustee's receipt thereof. The Grantor shall have the full and unqualified right to vote any Asset in the Trust Account.

Section 7. Additional Rights and Duties of the Trustee.

(a) Before accepting any Asset for deposit to the Trust Account, the Trustee shall determine that such Asset is in such form that, to the extent practicable, the Beneficiary

4

---

whenever necessary may, or the Trustee upon direction by the Beneficiary will, negotiate such Asset without consent or signature from the Grantor or any person or entity other than the Trustee in accordance with the terms of this Trust Agreement.

(b) The Trustee shall be under no obligation to determine whether or not any instructions given by the Grantor and Beneficiary are contrary to any provision of law. It is understood and agreed that the Trustee's duties are solely those set forth herein and that the Trustee shall have no duty to take any other action unless specifically agreed to by the Trustee in writing. Without limiting the generality of the foregoing, the Trustee shall not have any duty to advise, manage, supervise or make recommendations with respect to the purchase, retention or sale of Assets with respect to any Assets in the Trust Account as to which a default in the payment of principal or interest has occurred or to be responsible for the consequences of insolvency or the legal inability of any broker, dealer, bank or other agent employed by the Grantor or Trustee with respect to the Assets except to the extent that the Trustee was negligent, engaged in misconduct or acted in bad faith in the selection of any such person or entity.

(c) The Trustee shall accept and open all mail directed to the Grantor or the Beneficiary in care of the Trustee.

(d) The Trustee shall have no responsibility whatsoever to determine that any Assets in the Trust Account are or continue to be Eligible Securities.

(e) The Trustee shall furnish to the Grantor and the Beneficiary a statement of all Assets in the Trust Account upon the inception of the Trust Account and at the end of each calendar month thereafter. The statement shall include a description of the Assets in the Trust Account and shall be delivered within five (5) business days following the end of such calendar month.

(f) The Trustee shall keep full and complete records of the administration of the Trust Account in accordance with all applicable law. Upon the request of the

Grantor or the Beneficiary, the Trustee shall promptly permit the Grantor or the Beneficiary, their respective agents, employees, independent auditors and regulatory authorities to examine, audit, excerpt, transcribe and copy, during the Trustee's normal business hours, any books, documents, papers and records relating to the Trust Account or the Assets.

(g) Unless otherwise provided in this Trust Agreement, the Trustee is authorized to follow and rely upon all instructions given by officers of the Grantor or the Beneficiary and by attorneys-in-fact acting under written authority furnished to the Trustee by the Grantor or the Beneficiary, including, without limitation, instructions given by letter, facsimile transmission or electronic media, if the Trustee believes such instructions to be genuine and to have been signed, sent or presented by the proper party or parties. In the absence of negligence, the Trustee shall not incur any liability to anyone resulting from actions taken by the Trustee in reliance in good faith on such instructions. The Trustee shall not incur any liability in executing instructions (i) from any attorney-in-fact prior to receipt by it of notice of the revocation of the written authority of the attorney-in-fact or (ii) from any officer of the Grantor or the Beneficiary.

---

5

(h) The duties and obligations of the Trustee shall only be such as are specifically set forth in this Trust Agreement, as it may from time to time be amended, and no implied duties or obligations shall be read into this Trust Agreement against the Trustee.

(i) No provision of this Trust Agreement shall require the Trustee to take any action which, in the Trustee's reasonable judgment, would result in any violation of this Trust Agreement or any provision of law.

(j) The Trustee may confer with counsel of its own choice in relation to matters arising under this Trust Agreement and shall have full and complete authorization from the other Parties for any action taken or suffered by it under this Trust Agreement or in respect of any transaction contemplated hereby in good faith and in accordance with the opinion of such counsel.

(k) The Trustee shall notify the Grantor and Beneficiary in writing of any payment default occurring as to any Asset within three (3) business days after Trustee receives notice of such default. In the event of a delinquency of a timely payment in regard to any of the Assets, the Trustee shall inform the Grantor and the Beneficiary immediately upon Trustee's receipt of notice of such delinquency.

(l) Notwithstanding any provision of this Agreement to the contrary, the Trustee shall be liable for (i) subject to Section 7(n), the safekeeping of the Assets and administering the Trust Account in accordance with the provisions of this Trust Agreement and (ii) its own negligence, willful misconduct or lack of good faith in performing its duties under this Trust Agreement. The Trustee shall exercise the standard of care with respect to the Assets that a professional trustee, engaged in the banking or trust company industry, having professional expertise in financial and securities processing transactions and custody would observe in such affairs. The Trustee shall be strictly liable for physical loss of or damage to Assets under its care, custody, possession or control or the care, custody, possession or control of its subcustodians, other agents or nominee(s), including but not limited to loss due to fire, burglary, robbery, theft or mysterious disappearance. In the event of loss or damage to the Assets under the care, custody, possession or control of Trustee or its subcustodians, other agents or nominee(s), Trustee shall, upon demand of the Grantor or Beneficiary, promptly replace such Assets with like kind and quality together with, all rights and privileges pertaining to the Assets (by among other methods, posting appropriate security or bond with the issuer of the Assets to obtain reissue of such Assets, or, if acceptable to the Grantor, deliver cash equivalent to the market value of the Assets as of the date of the discovery of the loss or damage). Nothing contained in any contract between Trustee and any entity authorized to hold Assets, as defined herein, shall diminish or otherwise alter the liability of Trustee to the Grantor or Beneficiary. The provisions of this paragraph shall not affect the burden of proof under applicable law with respect to the assertions of liability in any claim, action or dispute alleging any breach of or failure to observe such standard of care.

(m) The Trustee shall not be responsible for the existence, genuineness or value of any of the Assets, for the validity, perfection, priority or enforceability of the liens in or with respect to any of the Assets, for the validity of title to the Assets, for insuring the Assets, for the payment of taxes, charges, assessments or liens upon or with respect to the Assets, for any obligations

---

6

under any agreements or other documents evidencing or related to any of the Assets (other than this Trust Agreement), or for the compliance of the Assets with any laws, including any Environmental Law (as hereinafter defined). The Trustee shall have no responsibility for the recording, filing or registration (or for the rerecording, refiling or reregistration) of any instrument or notice, including any financing or continuation statement or any tax or securities form, at any time in any public office or elsewhere for the purpose of perfecting, maintaining the perfection of or otherwise making effective any lien upon or with respect to any of the Assets.

(n) The Parties acknowledge and agree that certain of the Assets are and will continue to be subject to servicing and custodial agreements in effect on the date hereof (as amended or otherwise modified from time to time, including any replacements thereof, the "Servicing/Custodial Agreements"). The Grantor and the Beneficiary acknowledge and agree that (i) the Trustee shall have no liability under this Trust Agreement for any action or omission of any of the parties to the Servicing/Custodial Agreements, including with respect to any of the Assets at any time during which such Assets are under the care, custody, possession or control of any of the parties to the Servicing/Custodial Agreements or any of their respective depositories, subcustodians, other agents or nominees (and, solely for the purposes of limiting the liability and determining the duties of the Trustee under Section 7(l), none of such Persons shall be considered to be the depositories, subcustodians, agents or nominees of the Trustee), (ii) the performance by the Trustee of any of its obligations under this Trust Agreement may be delayed, limited or otherwise affected by the actions or omissions of any of the parties to the Servicing/Custodial Agreements or as a result of the Assets being subject to the Servicing/Custodial Agreements and (iii) the Trustee shall have no liability under this Trust Agreement as a result of the Trustee's failure to perform any of its obligations under this Trust Agreement as a result of the actions or omissions of any of the parties to the Servicing/Custodial Agreements or as a result of the Assets being subject to the Servicing/Custodial Agreements.

Section 8. Representations, Warranties and Covenants of the Trustee. The Trustee represents, warrants and covenants to the Grantor and Beneficiary that:

- (a) The Trustee is a Qualified United States Financial Institution;
- (b) In the ordinary course of its business, the Trustee maintains securities accounts for others and is acting in that capacity in this Trust Agreement;
- (c) The Trust Account is and at all times shall be maintained at an office of the Trustee in the United States of America;
- (d) The Trustee is not an Affiliate of the Grantor or the Beneficiary.

Section 9. The Trustee's Compensation; Expenses.

(a) The Grantor shall pay the Trustee, as compensation for its services under this Trust Agreement, a fee computed at rates determined by the Trustee from time to time and communicated in writing to the Grantor. The Grantor shall pay or reimburse the Trustee for all of the Trustee's expenses and disbursements in connection with its duties under this Trust Agreement (including reasonable attorney's fees and expenses), except any such expense or disbursement as may arise from the Trustee's negligence, willful misconduct, lack of good faith

---

7

or failure to administer the Trust Account in accordance with the terms of this Trust Agreement. The Trustee shall be entitled to deduct its compensation and expenses from payments of dividends, interest and other income in respect of the Assets held in the Trust Account prior to the deposit thereof to the Income Account as provided in Section 5 of this Agreement. The Grantor also hereby indemnifies the Trustee for, and holds it harmless against, any loss, liability, costs or expenses (including reasonable attorney's fees and expenses) incurred or made without negligence, willful misconduct or lack of good faith on the part of the Trustee, arising out of or in connection with the performance of its obligations in accordance with the provisions of this Trust Agreement (which shall be the sole obligation of the Trustee), including any loss, liability, costs or expenses arising out of or in connection with the status of the Trustee and its nominee as the holder of record of the Assets. The Grantor hereby acknowledges that the foregoing indemnities shall survive the resignation of the Trustee or the termination of this Trust Agreement and hereby grants the Trustee a lien, right of set-off and security interest in the funds in the Income Account for the payment of any claim for compensation, reimbursement or indemnity hereunder.

(b) No Assets shall be withdrawn from the Trust Account or used in any manner for paying compensation to, or reimbursement or indemnification of, the Trustee.

(c) In addition to, and without limiting, the Grantor's indemnification obligations set forth in Section 9(a), to the extent resulting from or in connection with the execution, delivery, enforcement, performance, or administration of this Trust Agreement, the Grantor shall defend, indemnify, and hold harmless the Trustee and its employees, officers, directors and agents from and against any claims, demands, penalties, fines, liabilities, settlements, damages, costs, or expenses of whatever kind or nature, known or unknown, contingent or otherwise, arising out of, or in any way related to, (i) the presence, disposal, release, or threatened release of any Hazardous Materials which are on, from, or affecting soil, water, vegetation, buildings, personal property, persons, animals, or otherwise; (ii) any personal injury (including wrongful death), property damage (real or personal) or natural resource damage arising out of or related to such Hazardous Materials; (iii) any third party claim brought or threatened, settlement reached, or government order, or any policies or requirements of the Trustee, which are based upon or in any way related to such Hazardous Materials, including, without limitation, attorney and consultant fees and expenses, investigation and laboratory fees, court costs, and litigation expenses, and (iv) any violations of Environmental Law, except, in each instance, to the extent arising from the negligence, willful misconduct or lack of good faith of the Trustee. The Grantor hereby acknowledges that the foregoing indemnities shall survive the resignation of the Trustee or the termination of this Trust Agreement and hereby grants the Trustee a lien, right of set-off and security interest in the funds in the Income Account for the payment of any claim for compensation, reimbursement or indemnity hereunder. For purposes hereof:

"Hazardous Materials" means, without limit, any pollutant, contaminant or hazardous, toxic, medical, biohazardous, or dangerous waste, substance, constituent or material, defined or regulated as such in, or for the purpose of, any applicable Environmental Law, including, without limitation, any asbestos, any petroleum, oil (including crude oil or any fraction thereof), any radioactive substance, any polychlorinated biphenyls, any toxin, chemical, disease-causing agent or pathogen, and any other substance that gives rise to liability under any applicable Environmental Law; and

---

"Environmental Law" means the Comprehensive Environmental Response, Compensation and Liability Act, as amended ("CERCLA"), the Resource Conservation and Recovery Act of 1976, as amended, and any other applicable federal, state, local, or foreign statute, rule, regulation, order, judgment, directive, decree, permit, license or common law as in effect now, previously, or at any time during the term of this Trust Agreement, and regulating, relating to, or imposing liability or standards of conduct concerning air emissions, water discharges, noise emissions, the release or threatened release or discharge of any Hazardous Material into the environment, the use, manufacture, production, refinement, generation, handling, treatment, storage, transport or disposal of any Hazardous Material or otherwise concerning pollution or the protection of the outdoor or indoor environment, or human health or safety in relation to exposure to Hazardous Materials.

#### Section 10. Resignation or Removal of the Trustee.

(a) The Trustee may resign at any time upon delivery of a written notice thereof to the Beneficiary and to the Grantor effective not less than 90 days after receipt by the Beneficiary and the Grantor of such notice. The Trustee may be removed by prior written notice executed by Grantor and Beneficiary. No such resignation or removal shall become effective until a successor Trustee has been appointed and approved by the Beneficiary and the Grantor and all Assets in the Trust Account have been duly transferred to the successor Trustee in accordance with paragraph (b) of this Section 10.

(b) Upon receipt by the proper Parties of the Trustee's notice of resignation or the Grantor's and Beneficiary's notice of removal, the Grantor and the Beneficiary shall appoint a successor Trustee. Any successor Trustee shall be a bank that is a member of the Federal Reserve System and a Qualified United States Financial Institution, and shall not be an Affiliate of the Grantor or the Beneficiary. Upon the acceptance of the appointment as Trustee hereunder by a successor Trustee and the transfer to such successor Trustee of all Assets in the Trust Account, the resignation or removal of the Trustee shall become effective. Thereupon, such successor Trustee shall succeed to and become vested with all the rights, powers, privileges and duties of the resigning or removed Trustee, and the resigning or removed Trustee shall be discharged from any future duties and obligations under this Trust Agreement, but the resigning or removed Trustee shall continue after such resignation or removal to be entitled to the benefits of the indemnities provided herein for the Trustee.

#### Section 11. Termination of the Trust Account.

(a) The Trust Account and this Trust Agreement, except for the indemnities provided herein, may be terminated only after the Grantor and Beneficiary mutually give the Trustee written notice of their intention to terminate the Trust Account (the "Notice of Intention"). The Notice of Intention shall specify the date on which the Parties intend the Trust Account to terminate (the "Termination Date").

(b) On the Termination Date, the Trustee shall transfer to the Grantor all of the Assets not previously withdrawn by the Beneficiary.

---

Section 12. Definitions. Except as the context shall otherwise require, the following terms shall have the following meanings for purposes of this Trust Agreement (the definitions to be applicable to both the singular and the plural forms of each term defined if both forms of such term are used in this Trust Agreement):

The term "Affiliate" means any other Person that directly or indirectly controls, is controlled by, or is under common control with, the first Person.

The term "Beneficiary" shall include any successor of the Beneficiary by operation of law including, without limitation, any liquidator, rehabilitator, receiver or conservator.

The term "Control" (including the related terms "controlled by" and "under common control with") shall mean the ownership, directly or indirectly, of more than 50% of the voting securities of a corporation.

The term "Eligible Securities" shall mean and include certificates of deposit (issued by a United States bank and payable in United States legal tender) and other assets of the types specified on Exhibit B attached hereto.

The terms "Person" shall mean and include an individual, a corporation, a partnership, an association, a trust, an unincorporated organization or a government or political subdivision thereof.

The term "Qualified United States Financial Institution" shall mean a bank designated as such by the Securities Valuation Office of the National Association of Insurance Commissioners (or any successor organization or regulatory agency having similar duties).

Section 13. Governing Law. This Trust Agreement shall be subject to and governed by the laws of the State of New York without regard to its conflict of laws provision and the Trust Account created hereunder shall be administered in accordance with the laws of said state.

Section 14. WAIVER OF JURY TRIAL. EACH PARTY HERETO HEREBY WAIVES TRIAL BY JURY IN ANY JUDICIAL PROCEEDING INVOLVING, DIRECTLY OR INDIRECTLY, ANY MATTER (WHETHER SOUNDING IN TORT, CONTRACT OR OTHERWISE) IN ANY WAY ARISING OUT OF OR RELATED TO THIS AGREEMENT OR THE RELATIONSHIP ESTABLISHED HEREUNDER. THIS PROVISION IS A MATERIAL INDUCEMENT FOR THE PARTIES TO ENTER INTO THIS AGREEMENT.

Section 15. Successors and Assigns. This Trust Agreement shall be binding upon and inure to the benefit of the Parties and their respective successors, permitted assigns and legal representatives. Neither this Trust Agreement, nor any right or obligation hereunder, may be assigned by any Party without the prior written consent of the other Parties hereto. Any assignment in violation of this Section 15 shall be void and shall have no force and effect.

Section 16. Severability. If any provision of this Trust Agreement is held to be void or unenforceable, in whole or in part, (i) such holding shall not affect the validity and enforceability of the remainder of this Trust Agreement, including any other provision, paragraph or subparagraph, and (ii) the Parties agree to attempt in good faith to reform such void or

10

---

unenforceable provision to the extent necessary to render such provision enforceable and to carry out its original intent.

Section 17. Entire Agreement. Except for the Coinsurance Agreements, this Trust Agreement constitutes the entire agreement among the Parties with respect to the subject matter hereof, and there are no understandings or agreements, conditions or qualifications relative to this Trust Agreement which are not fully expressed in this Trust Agreement or the Coinsurance Agreements.

Section 18. Amendments. This Trust Agreement may be modified or otherwise amended, and the observance of any term of this Trust Agreement may be waived, only if such modification, amendment or waiver is in writing and signed by the Parties.

Section 19. Notices. All notices, requests, demands and other communications under this Trust Agreement must be in writing and will be deemed to have been duly given or made as follows: (a) if sent by registered or certified mail in the United States return receipt requested, upon receipt; (b) if sent by reputable overnight air courier, two (2) business days after mailing; (c) if sent by facsimile transmission, with a copy mailed on the same day in the manner provided in (a) or (b) above, when transmitted and receipt is confirmed by telephone; or (d) if otherwise actually personally delivered, when delivered, and shall be delivered as follows:

If to the Grantor:

Union Fidelity Life Insurance Company  
200 North Martingale Road  
Schaumburg, IL 60173-2096  
Facsimile: (847) 330-3404  
Attention: Chief Financial Officer

With a copy to:

Union Fidelity Life Insurance Company  
200 North Martingale Road  
Schaumburg, IL 60173-2096  
Facsimile: (847) 605-3044  
Attention: General Counsel

If to the Beneficiary:

GE Life and Annuity Assurance Company  
6610 West Broad Street  
Richmond, VA 23230  
Facsimile: (804) 281-6165  
Attention: Chief Executive Officer

11

---

With a copy to:

GE Life and Annuity Assurance Company  
6610 West Broad Street  
Richmond, VA 23230  
Facsimile: (804) 281-6005  
Attention: General Counsel

If to the Trustee:

The Bank of New York  
101 Barclay Street - 8W  
New York, NY 10286  
Facsimile: (212) 815-5875  
Attention: Insurance Trust and Escrow Unit

or to such other address or to such other Person as a Party may have last designated by notice to the other Parties.

Section 20. Headings. The headings of the Sections have been inserted for convenience of reference only and shall not be deemed to constitute a part of this Trust Agreement.

Section 21. Counterparts. This Trust Agreement may be executed in any number of counterparts, each of which when so executed and delivered shall constitute an original, but such counterparts together shall constitute but one and the same Trust Agreement.

**IN WITNESS WHEREOF**, the parties hereto have caused this Trust Agreement to be executed and delivered by their respective officers thereunto duly authorized as of the date first above written.

UNION FIDELITY LIFE INSURANCE  
COMPANY, as Grantor

By: /s/ GLENN JOPPA  
Name: Glenn Joppa  
Title: Senior Vice President and Secretary

GE LIFE AND ANNUITY ASSURANCE  
COMPANY, as Beneficiary

By: /s/ GARY T. PRIZZIA  
Name: Gary T. Prizzia  
Title: Treasurer

THE BANK OF NEW YORK, as Trustee

By: /s/ ROBERT W. RICH  
Name: Robert W. Rich  
Title: Vice President

**Exhibit A-1**

**CERTIFICATE**

The undersigned, the [insert position] and a duly authorized officer of GE Life and Annuity Assurance Company, does hereby certify that, pursuant to Section 2 of the Trust Agreement dated as of [ ] entered into by and among GE Life and Annuity Assurance Company, Union Fidelity Life Insurance Company and [ ] (the "Trust Agreement") and the Coinsurance Agreement dated as of [ ] between GE Life and Annuity Assurance Company and Union Fidelity Life Insurance Company, GE Life and Annuity Assurance Company is entitled to withdraw from the Trust Account established by Union Fidelity Life Insurance Company for the benefit of GE Life and Annuity Assurance Company pursuant to the Trust Agreement, assets with a current statutory book value equal to \$[ ] for the purpose[s] specified in paragraph[s] [ ] and [ ] of Section [ ] of the Coinsurance Agreement.

**[Certification to specify the basis for the withdrawal.]**

This Certificate is a "Beneficiary Certificate" within the meaning of Section 2(a) of the Trust Agreement.

Dated: \_\_\_\_\_

\_\_\_\_\_  
Name:  
Title:

**Exhibit A-2**

**REQUEST FOR WITHDRAWAL**

GE Life and Annuity Assurance Company ("GELAAC") hereby requests that [ ] immediately transfer to GELAAC [/or [ ]] all right, title and interest in those assets set forth on Schedule A attached hereto (which assets have a statutory book value equal to \$[ ]) from the Trust Account established by Union Fidelity Life Insurance Company ("UFLIC") for the benefit of GELAAC pursuant to the Trust Agreement dated as of [ , ] entered into by and among GELAAC, UFLIC and [ ] (the "Trust Agreement"). [Insert transfer instructions.]

This Request for Withdrawal is a "Beneficiary Request for Withdrawal" within the meaning of Section 2(a) of the Trust Agreement, and is made in conjunction with the attached Beneficiary Certificate.

GE LIFE AND ANNUITY ASSURANCE  
COMPANY

Dated: \_\_\_\_\_

By: \_\_\_\_\_  
Name:  
Title:

**ELIGIBLE SECURITIES**

Assets of the types for which an Illinois-domiciled life insurance company could obtain full statutory reserve credit under statutory accounting practices prescribed or permitted by the Director of Insurance of the State of Illinois.



**TRUST AGREEMENT**

This TRUST AGREEMENT, dated as of April 15, 2004 (this "Trust Agreement"), among Union Fidelity Life Insurance Company, an insurance company organized under the Laws of the State of Illinois (the "Grantor"), Federal Home Life Insurance Company, an insurance company organized under the laws of the Commonwealth of Virginia (the "Beneficiary"), and The Bank of New York, a New York corporation (the "Trustee") (the Grantor, the Beneficiary and the Trustee are hereinafter each sometimes referred to individually as a "Party" and collectively as the "Parties"). All terms not defined herein shall have the same meanings as set forth in the Coinsurance Agreement (as hereinafter defined).

**WITNESSETH:**

**WHEREAS**, pursuant to a Coinsurance Agreement of even date herewith between the Beneficiary and the Grantor, the Beneficiary is ceding to the Grantor, and the Grantor is reinsuring on a coinsurance basis, certain of the Beneficiary's liabilities arising under structured settlement annuities (the "Coinsurance Agreement"); and

**WHEREAS**, the Grantor desires to transfer to the Trustee for deposit to a trust account (the "Trust Account") certain assets as security for the payment and performance by the Grantor of its obligations under the Coinsurance Agreement; and

**WHEREAS**, the Trustee has agreed to act as Trustee hereunder, and to hold such assets in trust in the Trust Account for the sole use and benefit of the Beneficiary for such purposes in accordance with the terms and conditions of this Trust Agreement; and

**WHEREAS**, this Trust Agreement is made for the sole use and benefit of the Beneficiary and for the purpose of setting forth the duties and powers of the Trustee with respect to the Trust Account;

**NOW, THEREFORE**, for and in consideration of the premises and for other good and valuable consideration, the receipt of which is hereby acknowledged, the Parties hereby agree as follows:

Section 1. Deposit of Assets to the Trust Account

(a) The Grantor hereby establishes the Trust Account with the Trustee for the sole use and benefit of the Beneficiary, under the terms set forth herein. The Trustee shall administer the Trust Account in its name as Trustee for the sole benefit of the Beneficiary. The Trust Account shall be subject to withdrawal by the Beneficiary solely as provided herein. The Trustee hereby accepts the Trust Account upon the terms set forth in this Trust Agreement.

(b) The Grantor shall transfer to the Trustee, for deposit to the Trust Account, such assets as may be required from time to time pursuant to the Coinsurance Agreement (all such assets are herein referred to individually as an "Asset" and collectively as the "Assets"). The Trustee is authorized and shall have power to receive the Assets from the Grantor and to hold, invest, reinvest and dispose of the same for the uses and purposes of and according to the provisions herein set forth. All Assets shall be maintained by the Trustee in the Trust Account separate and distinct from all other assets on the books of the Trustee and in accordance with the terms of this Trust Agreement. The Assets shall consist only of Eligible Securities (as hereinafter defined). In the event of any payment default as to any Asset in the Trust Account or in the event that any Asset no longer is an Eligible Security, the Grantor shall, within five (5) business days after receiving notice from the Trustee pursuant to Section 19 or the Grantor having knowledge of such default or ineligibility, substitute other Assets which meet the requirements of an Eligible Security and having a statutory book value equal to the statutory book value of such Asset, which has a payment default or no longer meets the requirements for an Eligible Security, on the last statement provided by the Trustee.

(c) The Grantor hereby represents and warrants (i) that, to the extent practicable, any Assets transferred by the Grantor to the Trustee for deposit to the Trust Account will be in such form that the Beneficiary whenever necessary may, and the Trustee upon direction by the Beneficiary will, negotiate any such Assets without consent or signature from the Grantor or any other person or entity in accordance with the terms of this Trust Agreement, (ii) that all Assets transferred by the Grantor to the Trustee for deposit into the Trust Account consist only of Eligible Securities, and (iii) that Grantor has at the time of transfer into this Trust Account good and marketable title to the Assets to be so transferred and each such Asset shall be at the time of transfer free and clear of all claims, liens, interests and encumbrances (other than those arising under this Trust Agreement).

(d) Prior to depositing the Assets into the Trust Account, and from time to time thereafter as required, the Grantor shall execute assignments, endorsement in blank, or transfer legal title to the Trustee of all shares, obligations or other Assets requiring assignments, so that, to the extent practicable, the Beneficiary whenever necessary may, and the Trustee upon the direction by the Beneficiary will, negotiate any such Assets without the consent or signature from the Grantor or any other person or entity. The Grantor shall give all notices and take all actions as the Trustee deems appropriate in order to cause payments due or that become due on any Asset within the Trust Account to be paid to the Trustee. The Grantor shall not make or consent to any waiver, amendment or restriction on transfer with respect to any Asset in the Trust Account, in each case without the Beneficiary's prior written consent. In connection with the deposit of Assets into the Trust Account, the Grantor shall furnish to the Trustee all original documentation evidencing the Grantor's ownership thereto.

(e) The parties recognize that certain Assets will not be readily negotiable and that certain notices, opinions of counsel, representations and/or consents will be required for the Beneficiary to obtain good and marketable title to such Assets.

Section 2. Withdrawal of Assets from the Trust Account

(a) Without notice to the Grantor, the Beneficiary shall have the right, at any time and from time to time, to withdraw from the Trust Account, upon notice to the Trustee in the form of a certificate substantially in the form of Exhibit A-1 attached hereto (the "Beneficiary Certificate"), signed by a duly authorized officer of the Beneficiary, accompanied by a request for withdrawal substantially in the form of Exhibit A-2 hereto (the "Beneficiary Request for Withdrawal"), signed by a duly authorized officer of the Beneficiary, such Assets as are specified in such Beneficiary Request for Withdrawal. The Beneficiary Request for Withdrawal may designate a third party (the "Beneficiary Designee"), including the Grantor, to whom Assets specified therein shall be delivered. The Beneficiary shall not be required to present any other statement or document in addition to a Beneficiary Certificate and a Beneficiary Request for Withdrawal in order to withdraw any Assets, except that the Beneficiary shall acknowledge receipt of any such Assets withdrawn upon request by the Trustee.

(b) Upon receipt of a Beneficiary Certificate and a Beneficiary Request for Withdrawal, subject to the provision by the Beneficiary of any required notices, opinions of counsel and representations, the Trustee and the Grantor shall use commercially reasonable efforts to transfer absolutely and unequivocally all right, title and interest in the Assets specified in such Beneficiary Request for Withdrawal and shall deliver physical custody (or such other form as is necessary to complete the transfer) of such Assets to or for the account of the Beneficiary or such Beneficiary Designee, as specified in such Beneficiary Request for Withdrawal. The Trustee shall notify the Grantor and Beneficiary within three (3) business days following each withdrawal from the Trust Account.

(c) Subject to Section 4, in the absence of a Beneficiary Certificate and a Beneficiary Request for Withdrawal, the Trustee shall allow no substitution or withdrawal of any Asset from the Trust Account.

(d) The Trustee shall notify the insurance regulator in the state where the Beneficiary is domiciled within three (3) business days after all the assets in the Trust Account are withdrawn. At the Trustee's request, the Beneficiary shall provide to the Trustee the address of the insurance regulator in the state where the Beneficiary is domiciled.

Section 3. Application of Assets. The Beneficiary shall be permitted to withdraw Assets from the Trust Account only for the purposes set forth in the Coinsurance Agreement.

Section 4. Redemption, Investment and Substitution of Assets.

(a) The Trustee shall surrender for payment all maturing Assets and all Assets called for redemption, and deposit the principal amount of the proceeds of any such payment to the Trust Account.

(b) The Grantor, subject to the prior written approval of the Beneficiary, may retain (and pay the service fees of) a professional asset manager (the "Asset Manager") to manage and make investment decisions with regard to the Assets held by the Trustee in the Trust Account. From time to time, at the written order and direction of the Grantor or the Asset Manager, the Trustee shall invest Assets in the Trust Account in Eligible Securities.

3

---

(c) From time to time, subject to the prior written approval of the Beneficiary, the Grantor or the Asset Manager may direct the Trustee to substitute Assets of equal statutory book value for other Assets presently held in the Trust Account. The Trustee shall have no responsibility whatsoever to determine the value of such substituted Assets or that such substituted Assets constitute Eligible Securities.

(d) All investments and substitutions of securities referred to in Sections 4(b) and 4(c) above shall be in compliance with the definition of "Eligible Securities" in Section 12 of this Trust Agreement. Any instruction or order concerning such investments or substitutions of securities shall be referred to herein as an "Investment Order". The Trustee shall execute Investment Orders and settle securities transactions by itself or by means of an agent or broker. The Trustee shall not be responsible for any act or omission, or for the solvency, of any such agent or broker, except as set forth in Section 7.

(e) From time to time, upon notice to the Beneficiary, the Trustee may withdraw any Asset in the Trust Account upon the call or maturity of such Asset provided that the proceeds from such call or maturity are deposited into the Trust Account.

(f) When the Trustee is directed to deliver Assets against payment, delivery will be made in accordance with generally accepted market practice.

(g) Any loss incurred from any investment pursuant to the terms of this Section 4 shall be borne exclusively by the Trust Account.

(h) The Trustee shall not foreclose on, or direct or consent to the foreclosure of, any real property securing a commercial loan constituting an Asset or take title to such property by deed-in-lieu of foreclosure or other means without the prior written consent of the Grantor and the Beneficiary. The Trustee shall not provide any consent or direction with respect to any such commercial loan except at the written direction of the Grantor.

Section 5. The Income Account. All payments of interest, dividends and other income in respect to Assets in the Trust Account shall be the property of the Grantor and shall be deposited by the Trustee subject to deduction of the Trustee's compensation and expenses as provided in Section 9 of this Agreement, in a separate account (the "Income Account") established and maintained by the Grantor at an office of the Trustee. The Grantor may withdraw amounts from the Income Account at any time and from time to time.

Section 6. Right to Vote Assets. The Trustee shall forward all annual and interim stockholder reports and all proxies and proxy materials relating to the Assets in the Trust Account to the Grantor within a reasonable period of time following the Trustee's receipt thereof. The Grantor shall have the full and unqualified right to vote any Asset in the Trust Account.

Section 7. Additional Rights and Duties of the Trustee.

(a) Before accepting any Asset for deposit to the Trust Account, the Trustee shall determine that such Asset is in such form that, to the extent practicable, the Beneficiary whenever necessary may, or the Trustee upon direction by the Beneficiary will, negotiate such

4

---

Asset without consent or signature from the Grantor or any person or entity other than the Trustee in accordance with the terms of this Trust Agreement.

(b) The Trustee shall be under no obligation to determine whether or not any instructions given by the Grantor and Beneficiary are contrary to any provision of law. It is understood and agreed that the Trustee's duties are solely those set forth herein and that the Trustee shall have no duty to take any other action unless specifically agreed to by the Trustee in writing. Without limiting the generality of the foregoing, the Trustee shall not have any duty to advise, manage, supervise or make recommendations with respect to the purchase, retention or sale of Assets with respect to any Assets in the Trust Account as to which a default in the payment of principal or interest has occurred or to be responsible for the consequences of insolvency or the legal inability of any broker, dealer, bank or other agent employed by the Grantor or Trustee with respect to the Assets except to the extent that the Trustee was negligent, engaged in misconduct or acted in bad faith in the selection of any such person or entity.

(c) The Trustee shall accept and open all mail directed to the Grantor or the Beneficiary in care of the Trustee.

(d) The Trustee shall have no responsibility whatsoever to determine that any Assets in the Trust Account are or continue to be Eligible Securities.

(e) The Trustee shall furnish to the Grantor and the Beneficiary a statement of all Assets in the Trust Account upon the inception of the Trust Account and at the end of each calendar month thereafter. The statement shall include a description of the Assets in the Trust Account and shall be delivered within five (5) business days following the end of such calendar month.

(f) The Trustee shall keep full and complete records of the administration of the Trust Account in accordance with all applicable law. Upon the request of the Grantor or the Beneficiary, the Trustee shall promptly permit the Grantor or the Beneficiary, their respective agents, employees, independent auditors and regulatory authorities to examine, audit, excerpt, transcribe and copy, during the Trustee's normal business hours, any books, documents, papers and records relating to the Trust Account or the Assets.

(g) Unless otherwise provided in this Trust Agreement, the Trustee is authorized to follow and rely upon all instructions given by officers of the Grantor or the Beneficiary and by attorneys-in-fact acting under written authority furnished to the Trustee by the Grantor or the Beneficiary, including, without limitation, instructions given

by letter, facsimile transmission or electronic media, if the Trustee believes such instructions to be genuine and to have been signed, sent or presented by the proper party or parties. In the absence of negligence, the Trustee shall not incur any liability to anyone resulting from actions taken by the Trustee in reliance in good faith on such instructions. The Trustee shall not incur any liability in executing instructions (i) from any attorney-in-fact prior to receipt by it of notice of the revocation of the written authority of the attorney-in-fact or (ii) from any officer of the Grantor or the Beneficiary.

5

---

(h) The duties and obligations of the Trustee shall only be such as are specifically set forth in this Trust Agreement, as it may from time to time be amended, and no implied duties or obligations shall be read into this Trust Agreement against the Trustee.

(i) No provision of this Trust Agreement shall require the Trustee to take any action which, in the Trustee's reasonable judgment, would result in any violation of this Trust Agreement or any provision of law.

(j) The Trustee may confer with counsel of its own choice in relation to matters arising under this Trust Agreement and shall have full and complete authorization from the other Parties for any action taken or suffered by it under this Trust Agreement or in respect of any transaction contemplated hereby in good faith and in accordance with the opinion of such counsel.

(k) The Trustee shall notify the Grantor and Beneficiary in writing of any payment default occurring as to any Asset within three (3) business days after Trustee receives notice of such default. In the event of a delinquency of a timely payment in regard to any of the Assets, the Trustee shall inform the Grantor and the Beneficiary immediately upon Trustee's receipt of notice of such delinquency.

(l) Notwithstanding any provision of this Agreement to the contrary, the Trustee shall be liable for (i) subject to Section 7(n), the safekeeping of the Assets and administering the Trust Account in accordance with the provisions of this Trust Agreement and (ii) its own negligence, willful misconduct or lack of good faith in performing its duties under this Trust Agreement. The Trustee shall exercise the standard of care with respect to the Assets that a professional trustee, engaged in the banking or trust company industry, having professional expertise in financial and securities processing transactions and custody would observe in such affairs. The Trustee shall be strictly liable for physical loss of or damage to Assets under its care, custody, possession or control or the care, custody, possession or control of its subcustodians, other agents or nominee(s), including but not limited to loss due to fire, burglary, robbery, theft or mysterious disappearance. In the event of loss or damage to the Assets under the care, custody, possession or control of Trustee or its subcustodians, other agents or nominee(s), Trustee shall, upon demand of the Grantor or Beneficiary, promptly replace such Assets with like kind and quality together with, all rights and privileges pertaining to the Assets (by among other methods, posting appropriate security or bond with the issuer of the Assets to obtain reissue of such Assets, or, if acceptable to the Grantor, deliver cash equivalent to the market value of the Assets as of the date of the discovery of the loss or damage). Nothing contained in any contract between Trustee and any entity authorized to hold Assets, as defined herein, shall diminish or otherwise alter the liability of Trustee to the Grantor or Beneficiary. The provisions of this paragraph shall not affect the burden of proof under applicable law with respect to the assertions of liability in any claim, action or dispute alleging any breach of or failure to observe such standard of care.

(m) The Trustee shall not be responsible for the existence, genuineness or value of any of the Assets, for the validity, perfection, priority or enforceability of the liens in or with respect to any of the Assets, for the validity of title to the Assets, for insuring the Assets, for the payment of taxes, charges, assessments or liens upon or with respect to the Assets, for any obligations

6

---

under any agreements or other documents evidencing or related to any of the Assets (other than this Trust Agreement), or for the compliance of the Assets with any laws, including any Environmental Law (as hereinafter defined). The Trustee shall have no responsibility for the recording, filing or registration (or for the rerecording, refiling or reregistration) of any instrument or notice, including any financing or continuation statement or any tax or securities form, at any time in any public office or elsewhere for the purpose of perfecting, maintaining the perfection of or otherwise making effective any lien upon or with respect to any of the Assets.

(n) The Parties acknowledge and agree that certain of the Assets are and will continue to be subject to servicing and custodial agreements in effect on the date hereof (as amended or otherwise modified from time to time, including any replacements thereof, the "Servicing/Custodial Agreements"). The Grantor and the Beneficiary acknowledge and agree that (i) the Trustee shall have no liability under this Trust Agreement for any action or omission of any of the parties to the Servicing/Custodial Agreements, including with respect to any of the Assets at any time during which such Assets are under the care, custody, possession or control of any of the parties to the Servicing/Custodial Agreements or any of their respective depositories, subcustodians, other agents or nominees (and, solely for the purposes of limiting the liability and determining the duties of the Trustee under Section 7(l), none of such Persons shall be considered to be the depositories, subcustodians, agents or nominees of the Trustee), (ii) the performance by the Trustee of any of its obligations under this Trust Agreement may be delayed, limited or otherwise affected by the actions or omissions of any of the parties to the Servicing/Custodial Agreements or as a result of the Assets being subject to the Servicing/Custodial Agreements and (iii) the Trustee shall have no liability under this Trust Agreement as a result of the Trustee's failure to perform any of its obligations under this Trust Agreement as a result of the actions or omissions of any of the parties to the Servicing/Custodial Agreements or as a result of the Assets being subject to the Servicing/Custodial Agreements.

Section 8. Representations, Warranties and Covenants of the Trustee. The Trustee represents, warrants and covenants to the Grantor and Beneficiary that:

- (a) The Trustee is a Qualified United States Financial Institution;
- (b) In the ordinary course of its business, the Trustee maintains securities accounts for others and is acting in that capacity in this Trust Agreement;
- (c) The Trust Account is and at all times shall be maintained at an office of the Trustee in the United States of America;
- (d) The Trustee is not an Affiliate of the Grantor or the Beneficiary.

Section 9. The Trustee's Compensation; Expenses.

(a) The Grantor shall pay the Trustee, as compensation for its services under this Trust Agreement, a fee computed at rates determined by the Trustee from time to time and communicated in writing to the Grantor. The Grantor shall pay or reimburse the Trustee for all of the Trustee's expenses and disbursements in connection with its duties under this Trust Agreement (including reasonable attorney's fees and expenses), except any such expense or disbursement as may arise from the Trustee's negligence, willful misconduct, lack of good faith

7

---

or failure to administer the Trust Account in accordance with the terms of this Trust Agreement. The Trustee shall be entitled to deduct its compensation and expenses from payments of dividends, interest and other income in respect of the Assets held in the Trust Account prior to the deposit thereof to the Income Account as provided in Section 5 of this Agreement. The Grantor also hereby indemnifies the Trustee for, and holds it harmless against, any loss, liability, costs or expenses (including reasonable attorney's fees and expenses) incurred or made without negligence, willful misconduct or lack of good faith on the part of the Trustee, arising out of or in connection with the

performance of its obligations in accordance with the provisions of this Trust Agreement (which shall be the sole obligation of the Trustee), including any loss, liability, costs or expenses arising out of or in connection with the status of the Trustee and its nominee as the holder of record of the Assets. The Grantor hereby acknowledges that the foregoing indemnities shall survive the resignation of the Trustee or the termination of this Trust Agreement and hereby grants the Trustee a lien, right of set-off and security interest in the funds in the Income Account for the payment of any claim for compensation, reimbursement or indemnity hereunder.

(b) No Assets shall be withdrawn from the Trust Account or used in any manner for paying compensation to, or reimbursement or indemnification of, the Trustee.

(c) In addition to, and without limiting, the Grantor's indemnification obligations set forth in Section 9(a), to the extent resulting from or in connection with the execution, delivery, enforcement, performance, or administration of this Trust Agreement, the Grantor shall defend, indemnify, and hold harmless the Trustee and its employees, officers, directors and agents from and against any claims, demands, penalties, fines, liabilities, settlements, damages, costs, or expenses of whatever kind or nature, known or unknown, contingent or otherwise, arising out of, or in any way related to, (i) the presence, disposal, release, or threatened release of any Hazardous Materials which are on, from, or affecting soil, water, vegetation, buildings, personal property, persons, animals, or otherwise; (ii) any personal injury (including wrongful death), property damage (real or personal) or natural resource damage arising out of or related to such Hazardous Materials; (iii) any third party claim brought or threatened, settlement reached, or government order, or any policies or requirements of the Trustee, which are based upon or in any way related to such Hazardous Materials, including, without limitation, attorney and consultant fees and expenses, investigation and laboratory fees, court costs, and litigation expenses, and (iv) any violations of Environmental Law, except, in each instance, to the extent arising from the negligence, willful misconduct or lack of good faith of the Trustee. The Grantor hereby acknowledges that the foregoing indemnities shall survive the resignation of the Trustee or the termination of this Trust Agreement and hereby grants the Trustee a lien, right of set-off and security interest in the funds in the Income Account for the payment of any claim for compensation, reimbursement or indemnity hereunder. For purposes hereof:

"Hazardous Materials" means, without limit, any pollutant, contaminant or hazardous, toxic, medical, biohazardous, or dangerous waste, substance, constituent or material, defined or regulated as such in, or for the purpose of, any applicable Environmental Law, including, without limitation, any asbestos, any petroleum, oil (including crude oil or any fraction thereof), any radioactive substance, any polychlorinated biphenyls, any toxin, chemical, disease-causing agent or pathogen, and any other substance that gives rise to liability under any applicable Environmental Law; and

8

---

"Environmental Law" means the Comprehensive Environmental Response, Compensation and Liability Act, as amended ("CERCLA"), the Resource Conservation and Recovery Act of 1976, as amended, and any other applicable federal, state, local, or foreign statute, rule, regulation, order, judgment, directive, decree, permit, license or common law as in effect now, previously, or at any time during the term of this Trust Agreement, and regulating, relating to, or imposing liability or standards of conduct concerning air emissions, water discharges, noise emissions, the release or threatened release or discharge of any Hazardous Material into the environment, the use, manufacture, production, refinement, generation, handling, treatment, storage, transport or disposal of any Hazardous Material or otherwise concerning pollution or the protection of the outdoor or indoor environment, or human health or safety in relation to exposure to Hazardous Materials.

#### Section 10. Resignation or Removal of the Trustee.

(a) The Trustee may resign at any time upon delivery of a written notice thereof to the Beneficiary and to the Grantor effective not less than 90 days after receipt by the Beneficiary and the Grantor of such notice. The Trustee may be removed by prior written notice executed by Grantor and Beneficiary. No such resignation or removal shall become effective until a successor Trustee has been appointed and approved by the Beneficiary and the Grantor and all Assets in the Trust Account have been duly transferred to the successor Trustee in accordance with paragraph (b) of this Section 10.

(b) Upon receipt by the proper Parties of the Trustee's notice of resignation or the Grantor's and Beneficiary's notice of removal, the Grantor and the Beneficiary shall appoint a successor Trustee. Any successor Trustee shall be a bank that is a member of the Federal Reserve System and a Qualified United States Financial Institution, and shall not be an Affiliate of the Grantor or the Beneficiary. Upon the acceptance of the appointment as Trustee hereunder by a successor Trustee and the transfer to such successor Trustee of all Assets in the Trust Account, the resignation or removal of the Trustee shall become effective. Thereupon, such successor Trustee shall succeed to and become vested with all the rights, powers, privileges and duties of the resigning or removed Trustee, and the resigning or removed Trustee shall be discharged from any future duties and obligations under this Trust Agreement, but the resigning or removed Trustee shall continue after such resignation or removal to be entitled to the benefits of the indemnities provided herein for the Trustee.

#### Section 11. Termination of the Trust Account.

(a) The Trust Account and this Trust Agreement, except for the indemnities provided herein, may be terminated only after the Grantor and Beneficiary mutually give the Trustee written notice of their intention to terminate the Trust Account (the "Notice of Intention"). The Notice of Intention shall specify the date on which the Parties intend the Trust Account to terminate (the "Termination Date").

(b) On the Termination Date, the Trustee shall transfer to the Grantor all of the Assets not previously withdrawn by the Beneficiary.

9

---

Section 12. Definitions. Except as the context shall otherwise require, the following terms shall have the following meanings for purposes of this Trust Agreement (the definitions to be applicable to both the singular and the plural forms of each term defined if both forms of such term are used in this Trust Agreement):

The term "Affiliate" means any other Person that directly or indirectly controls, is controlled by, or is under common control with, the first Person.

The term "Beneficiary" shall include any successor of the Beneficiary by operation of law including, without limitation, any liquidator, rehabilitator, receiver or conservator.

The term "Control" (including the related terms "controlled by" and "under common control with") shall mean the ownership, directly or indirectly, of more than 50% of the voting securities of a corporation.

The term "Eligible Securities" shall mean and include certificates of deposit (issued by a United States bank and payable in United States legal tender) and other assets of the types specified on Exhibit B attached hereto.

The terms "Person" shall mean and include an individual, a corporation, a partnership, an association, a trust, an unincorporated organization or a government or political subdivision thereof.

The term "Qualified United States Financial Institution" shall mean a bank designated as such by the Securities Valuation Office of the National Association of Insurance Commissioners (or any successor organization or regulatory agency having similar duties).

Section 13. Governing Law. This Trust Agreement shall be subject to and governed by the laws of the State of New York without regard to its conflict of laws provision and the Trust Account created hereunder shall be administered in accordance with the laws of said state.

Section 14. WAIVER OF JURY TRIAL. EACH PARTY HERETO HEREBY WAIVES TRIAL BY JURY IN ANY JUDICIAL PROCEEDING INVOLVING, DIRECTLY OR INDIRECTLY, ANY MATTER (WHETHER SOUNDING IN TORT, CONTRACT OR OTHERWISE) IN ANY WAY ARISING OUT OF OR RELATED TO THIS AGREEMENT OR THE RELATIONSHIP ESTABLISHED HEREUNDER. THIS PROVISION IS A MATERIAL INDUCEMENT FOR THE PARTIES TO ENTER INTO THIS AGREEMENT.

Section 15. Successors and Assigns. This Trust Agreement shall be binding upon and inure to the benefit of the Parties and their respective successors, permitted assigns and legal representatives. Neither this Trust Agreement, nor any right or obligation hereunder, may be assigned by any Party without the prior written consent of the other Parties hereto. Any assignment in violation of this Section 15 shall be void and shall have no force and effect.

Section 16. Severability. If any provision of this Trust Agreement is held to be void or unenforceable, in whole or in part, (i) such holding shall not affect the validity and enforceability of the remainder of this Trust Agreement, including any other provision, paragraph or subparagraph, and (ii) the Parties agree to attempt in good faith to reform such void or

10

---

unenforceable provision to the extent necessary to render such provision enforceable and to carry out its original intent.

Section 17. Entire Agreement. Except for the Coinsurance Agreement, this Trust Agreement constitutes the entire agreement among the Parties with respect to the subject matter hereof, and there are no understandings or agreements, conditions or qualifications relative to this Trust Agreement which are not fully expressed in this Trust Agreement or the Coinsurance Agreement.

Section 18. Amendments. This Trust Agreement may be modified or otherwise amended, and the observance of any term of this Trust Agreement may be waived, only if such modification, amendment or waiver is in writing and signed by the Parties.

Section 19. Notices. All notices, requests, demands and other communications under this Trust Agreement must be in writing and will be deemed to have been duly given or made as follows: (a) if sent by registered or certified mail in the United States return receipt requested, upon receipt; (b) if sent by reputable overnight air courier, two (2) business days after mailing; (c) if sent by facsimile transmission, with a copy mailed on the same day in the manner provided in (a) or (b) above, when transmitted and receipt is confirmed by telephone; or (d) if otherwise actually personally delivered, when delivered, and shall be delivered as follows:

If to the Grantor:

Union Fidelity Life Insurance Company  
200 North Martingale Road  
Schaumburg, IL 60173-2096  
Facsimile: (847) 330-3404  
Attention: Chief Financial Officer

With a copy to:

Union Fidelity Life Insurance Company  
200 North Martingale Road  
Schaumburg, IL 60173-2096  
Facsimile: (847) 605-3044  
Attention: General Counsel

If to the Beneficiary:

Federal Home Life Insurance Company  
6620 West Broad Street  
Richmond, VA 23230  
Facsimile: (804) 662-2414  
Attention: Chief Executive Officer

11

---

With a copy to:

Federal Home Life Insurance Company  
700 Main Street  
Lynchburg, VA 24504  
Facsimile: (434) 948-5819  
Attention: General Counsel

If to the Trustee:

The Bank of New York  
101 Barclay Street - 8W  
New York, NY 10286  
Facsimile: (212) 815-5875  
Attention: Insurance Trust and Escrow Unit

or to such other address or to such other Person as a Party may have last designated by notice to the other Parties.

Section 20. Headings. The headings of the Sections have been inserted for convenience of reference only and shall not be deemed to constitute a part of this Trust Agreement.

Section 21. Counterparts. This Trust Agreement may be executed in any number of counterparts, each of which when so executed and delivered shall constitute an original, but such counterparts together shall constitute but one and the same Trust Agreement.

12

IN WITNESS WHEREOF, the parties hereto have caused this Trust Agreement to be executed and delivered by their respective officers thereunto duly authorized as of the date first above written.

UNION FIDELITY LIFE INSURANCE  
COMPANY, as Grantor

By: /s/ GLENN JOPPA  
Name: Glenn Joppa  
Title: Senior Vice President and Secretary

FEDERAL HOME LIFE INSURANCE  
COMPANY, as Beneficiary

By: /s/ GARY T. PRIZZIA  
Name: Gary T. Prizzia  
Title: Treasurer

THE BANK OF NEW YORK, as Trustee

By: /s/ ROBERT W. RICH  
Name: Robert W. Rich  
Title: Vice President

Exhibit A-1

**CERTIFICATE**

The undersigned, the [insert position] and a duly authorized officer of Federal Home Life Insurance Company, does hereby certify that, pursuant to Section 2 of the Trust Agreement dated as of [ ] entered into by and among Federal Home Life Insurance Company, Union Fidelity Life Insurance Company and [ ] (the "Trust Agreement") and the Coinsurance Agreement dated as of [ ] between Federal Home Life Insurance Company and Union Fidelity Life Insurance Company, Federal Home Life Insurance Company is entitled to withdraw from the Trust Account established by Union Fidelity Life Insurance Company for the benefit of Federal Home Life Insurance Company pursuant to the Trust Agreement, assets with a current statutory book value equal to \$[ ] for the purpose[s] specified in paragraph[s] [ ] and [ ] of Section [ ] of the Coinsurance Agreement.

**[Certification to specify the basis for the withdrawal.]**

This Certificate is a "Beneficiary Certificate" within the meaning of Section 2(a) of the Trust Agreement.

Dated: \_\_\_\_\_

\_\_\_\_\_  
Name:  
Title:

Exhibit A-2

**REQUEST FOR WITHDRAWAL**

Federal Home Life Insurance Company ("FHL") hereby requests that [ ] immediately transfer to FHL [/or [ ]] all right, title and interest in those assets set forth on Schedule A attached hereto (which assets have a statutory book value equal to \$[ ]) from the Trust Account established by Union Fidelity Life Insurance Company ("UFLIC") for the benefit of FHL pursuant to the Trust Agreement dated as of [ ], [ ] entered into by and among FHL, UFLIC and [ ] (the "Trust Agreement"). [Insert transfer instructions.]

This Request for Withdrawal is a "Beneficiary Request for Withdrawal" within the meaning of Section 2(a) of the Trust Agreement, and is made in conjunction with the attached Beneficiary Certificate.

FEDERAL HOME LIFE INSURANCE COMPANY

Dated: \_\_\_\_\_

By: \_\_\_\_\_  
Name:  
Title:

Exhibit B

**ELIGIBLE SECURITIES**

Assets of the types for which an Illinois-domiciled life insurance company could obtain full statutory reserve credit under statutory accounting practices prescribed or permitted by the Director of Insurance of the State of Illinois.

**TRUST AGREEMENT**

This TRUST AGREEMENT, dated as of April 15, 2004 (this "Trust Agreement"), among Union Fidelity Life Insurance Company, an insurance company organized under the Laws of the State of Illinois (the "Grantor"), GE Capital Life Assurance Company of New York, an insurance company organized under the laws of the State of New York (the "Beneficiary"), and The Bank of New York a New York corporation (the "Trustee") (the Grantor, the Beneficiary and the Trustee are hereinafter each sometimes referred to individually as a "Party" and collectively as the "Parties"). All terms not defined herein shall have the same meanings as set forth in the Coinsurance Agreement (as hereinafter defined).

**WITNESSETH:**

**WHEREAS**, pursuant to a Coinsurance Agreement of even date herewith between the Beneficiary and the Grantor, the Beneficiary is ceding to the Grantor, and the Grantor is reinsuring on a coinsurance basis, certain of the Beneficiary's liabilities arising under structured settlement annuities, pursuant to a Reinsurance Agreement, also of even date herewith between the Beneficiary and the Grantor, the Beneficiary is ceding to the Grantor, and the Grantor is reinsuring on a modified coinsurance basis (with respect to separate account liabilities), and on a coinsurance basis (with respect to general account liabilities), certain of the Beneficiary's liabilities arising under variable annuities, and pursuant to a Retrocession Agreement, also of even date herewith between the Beneficiary and the Grantor, the Beneficiary is ceding to the Grantor, and the Grantor is reinsuring on a coinsurance basis, certain of the Beneficiary's liabilities arising under certain long term care policies (collectively, the "Coinsurance Agreements").

**WHEREAS**, the Grantor desires to transfer to the Trustee for deposit to a trust account (the "Trust Account") certain assets as security for the payment and performance by the Grantor of its obligations under the Coinsurance Agreements; and

**WHEREAS**, the Trustee has agreed to act as Trustee hereunder, and to hold such assets in trust in the Trust Account for the sole use and benefit of the Beneficiary for such purposes in accordance with the terms and conditions of this Trust Agreement; and

**WHEREAS**, this Trust Agreement is made for the sole use and benefit of the Beneficiary and for the purpose of setting forth the duties and powers of the Trustee with respect to the Trust Account;

**NOW, THEREFORE**, for and in consideration of the premises and for other good and valuable consideration, the receipt of which is hereby acknowledged, the Parties hereby agree as follows:

**Section 1. Deposit of Assets to the Trust Account**

(a) The Grantor hereby establishes the Trust Account with the Trustee for the sole use and benefit of the Beneficiary, under the terms set forth herein. The Trustee shall administer the Trust Account in its name as Trustee for the sole benefit of the Beneficiary. The Trust Account shall be subject to withdrawal by the Beneficiary solely as provided herein. The Trustee hereby accepts the Trust Account upon the terms set forth in this Trust Agreement.

(b) The Grantor shall transfer to the Trustee, for deposit to the Trust Account, such assets as may be required from time to time pursuant to the Coinsurance Agreements (all such assets are herein referred to individually as an "Asset" and collectively as the "Assets"). The Trustee is authorized and shall have power to receive the Assets from the Grantor and to hold, invest, reinvest and dispose of the same for the uses and purposes of and according to the provisions herein set forth. All Assets shall be maintained by the Trustee in the Trust Account separate and distinct from all other assets on the books of the Trustee and in accordance with the terms of this Trust Agreement. The Assets shall consist only of Eligible Securities (as hereinafter defined). In the event of any payment default as to any Asset in the Trust Account or in the event that any Asset no longer is an Eligible Security, the Grantor shall, within five (5) business days after receiving notice from the Trustee pursuant to Section 19 or the Grantor having knowledge of such default or ineligibility, substitute other Assets which meet the requirements of an Eligible Security and having a statutory book value equal to the statutory book value of such Asset, which has a payment default or no longer meets the requirements for an Eligible Security, on the last statement provided by the Trustee.

(c) The Grantor hereby represents and warrants (i) that, to the extent practicable, any Assets transferred by the Grantor to the Trustee for deposit to the Trust Account will be in such form that the Beneficiary whenever necessary may, and the Trustee upon direction by the Beneficiary will, negotiate any such Assets without consent or signature from the Grantor or any other person or entity in accordance with the terms of this Trust Agreement, (ii) that all Assets transferred by the Grantor to the Trustee for deposit into the Trust Account consist only of Eligible Securities, and (iii) that Grantor has at the time of transfer into this Trust Account good and marketable title to the Assets to be so transferred and each such Asset shall be at the time of transfer free and clear of all claims, liens, interests and encumbrances (other than those arising under this Trust Agreement).

(d) Prior to depositing the Assets into the Trust Account, and from time to time thereafter as required, the Grantor shall execute assignments, endorsement in blank, or transfer legal title to the Trustee of all shares, obligations or other Assets requiring assignments, so that, to the extent practicable, the Beneficiary whenever necessary may, and the Trustee upon the direction by the Beneficiary will, negotiate any such Assets without the consent or signature from the Grantor or any other person or entity. The Grantor shall give all notices and take all actions as the Trustee deems appropriate in order to cause payments due or that become due on any Asset within the Trust Account to be paid to the Trustee. The Grantor shall not make or consent to any waiver, amendment or restriction on transfer with respect to any Asset in the Trust Account, in each case without the Beneficiary's prior written consent. In connection with the deposit of Assets into the Trust Account, the Grantor shall furnish to the Trustee all original documentation evidencing the Grantor's ownership thereto.

(e) The parties recognize that certain Assets will not be readily negotiable and that certain notices, opinions of counsel, representations and/or consents will be required for the Beneficiary to obtain good and marketable title to such Assets.

**Section 2. Withdrawal of Assets from the Trust Account**

(a) Without notice to the Grantor, the Beneficiary shall have the right, at any time and from time to time, to withdraw from the Trust Account, upon notice to the Trustee in the form of a certificate substantially in the form of Exhibit A-1 attached hereto (the "Beneficiary Certificate"), signed by a duly authorized officer of the Beneficiary, accompanied by a request for withdrawal substantially in the form of Exhibit A-2 hereto (the "Beneficiary Request for Withdrawal"), signed by a duly authorized officer of the Beneficiary, such Assets as are specified in such Beneficiary Request for Withdrawal. The Beneficiary Request for Withdrawal may designate a third party (the "Beneficiary Designee"), including the Grantor, to whom Assets specified therein shall be delivered. The Beneficiary shall not be required to present any other statement or document in addition to a Beneficiary Certificate and a Beneficiary Request for Withdrawal in order to withdraw any Assets, except that the Beneficiary shall acknowledge receipt of any such Assets withdrawn upon request by the Trustee.

(b) Upon receipt of a Beneficiary Certificate and a Beneficiary Request for Withdrawal, subject to the provision by the Beneficiary of any required notices,



opinions of counsel and representations, the Trustee and the Grantor shall use commercially reasonable efforts to transfer absolutely and unequivocally all right, title and interest in the Assets specified in such Beneficiary Request for Withdrawal and shall deliver physical custody (or such other form as is necessary to complete the transfer) of such Assets to or for the account of the Beneficiary or such Beneficiary Designee, as specified in such Beneficiary Request for Withdrawal. The Trustee shall notify the Grantor and Beneficiary within three (3) business days following each withdrawal from the Trust Account.

(c) Subject to Section 4, in the absence of a Beneficiary Certificate and a Beneficiary Request for Withdrawal, the Trustee shall allow no substitution or withdrawal of any Asset from the Trust Account.

(d) The Trustee shall notify the insurance regulator in the state where the Beneficiary is domiciled within three (3) business days after all the assets in the Trust Account are withdrawn. At the Trustee's request, the Beneficiary shall provide to the Trustee the address of the insurance regulator in the state where the Beneficiary is domiciled.

Section 3. Application of Assets. The Beneficiary shall be permitted to withdraw Assets from the Trust Account only for the purposes set forth in the Coinsurance Agreements.

Section 4. Redemption, Investment and Substitution of Assets.

(a) The Trustee shall surrender for payment all maturing Assets and all Assets called for redemption, and deposit the principal amount of the proceeds of any such payment to the Trust Account.

3

---

(b) The Grantor, subject to the prior written approval of the Beneficiary, may retain (and pay the service fees of) a professional asset manager (the "Asset Manager") to manage and make investment decisions with regard to the Assets held by the Trustee in the Trust Account. From time to time, at the written order and direction of the Grantor or the Asset Manager, the Trustee shall invest Assets in the Trust Account in Eligible Securities.

(c) From time to time, subject to the prior written approval of the Beneficiary, the Grantor or the Asset Manager may direct the Trustee to substitute Assets of equal statutory book value for other Assets presently held in the Trust Account. The Trustee shall have no responsibility whatsoever to determine the value of such substituted Assets or that such substituted Assets constitute Eligible Securities.

(d) All investments and substitutions of securities referred to in Sections 4(b) and 4(c) above shall be in compliance with the definition of "Eligible Securities" in Section 12 of this Trust Agreement. Any instruction or order concerning such investments or substitutions of securities shall be referred to herein as an "Investment Order". The Trustee shall execute Investment Orders and settle securities transactions by itself or by means of an agent or broker. The Trustee shall not be responsible for any act or omission, or for the solvency, of any such agent or broker, except as set forth in Section 7.

(e) From time to time, upon notice to the Beneficiary, the Trustee may withdraw any Asset in the Trust Account upon the call or maturity of such Asset provided that the proceeds from such call or maturity are deposited into the Trust Account.

(f) When the Trustee is directed to deliver Assets against payment, delivery will be made in accordance with generally accepted market practice.

(g) Any loss incurred from any investment pursuant to the terms of this Section 4 shall be borne exclusively by the Trust Account.

(h) The Trustee shall not foreclose on, or direct or consent to the foreclosure of, any real property securing a commercial loan constituting an Asset or take title to such property by deed-in-lieu of foreclosure or other means without the prior written consent of the Grantor and the Beneficiary. The Trustee shall not provide any consent or direction with respect to any such commercial loan except at the written direction of the Grantor.

Section 5. The Income Account. All payments of interest, dividends and other income in respect to Assets in the Trust Account shall be the property of the Grantor and shall be deposited by the Trustee subject to deduction of the Trustee's compensation and expenses as provided in Section 9 of this Agreement, in a separate account (the "Income Account") established and maintained by the Grantor at an office of the Trustee. The Grantor may withdraw amounts from the Income Account at any time and from time to time.

Section 6. Right to Vote Assets. The Trustee shall forward all annual and interim stockholder reports and all proxies and proxy materials relating to the Assets in the Trust Account to the Grantor within a reasonable period of time following the Trustee's receipt thereof. The Grantor shall have the full and unqualified right to vote any Asset in the Trust Account.

4

---

Section 7. Additional Rights and Duties of the Trustee.

(a) Before accepting any Asset for deposit to the Trust Account, the Trustee shall determine that such Asset is in such form that, to the extent practicable, the Beneficiary whenever necessary may, or the Trustee upon direction by the Beneficiary will, negotiate such Asset without consent or signature from the Grantor or any person or entity other than the Trustee in accordance with the terms of this Trust Agreement.

(b) The Trustee shall be under no obligation to determine whether or not any instructions given by the Grantor and Beneficiary are contrary to any provision of law. It is understood and agreed that the Trustee's duties are solely those set forth herein and that the Trustee shall have no duty to take any other action unless specifically agreed to by the Trustee in writing. Without limiting the generality of the foregoing, the Trustee shall not have any duty to advise, manage, supervise or make recommendations with respect to the purchase, retention or sale of Assets with respect to any Assets in the Trust Account as to which a default in the payment of principal or interest has occurred or to be responsible for the consequences of insolvency or the legal inability of any broker, dealer, bank or other agent employed by the Grantor or Trustee with respect to the Assets except to the extent that the Trustee was negligent, engaged in misconduct or acted in bad faith in the selection of any such person or entity.

(c) The Trustee shall accept and open all mail directed to the Grantor or the Beneficiary in care of the Trustee.

(d) The Trustee shall have no responsibility whatsoever to determine that any Assets in the Trust Account are or continue to be Eligible Securities.

(e) The Trustee shall furnish to the Grantor and the Beneficiary a statement of all Assets in the Trust Account upon the inception of the Trust Account and at the end of each calendar month thereafter. The statement shall include a description of the Assets in the Trust Account and shall be delivered within five (5) business days following the end of such calendar month.

(f) The Trustee shall keep full and complete records of the administration of the Trust Account in accordance with all applicable law. Upon the request of the Grantor or the Beneficiary, the Trustee shall promptly permit the Grantor or the Beneficiary, their respective agents, employees, independent auditors and regulatory

authorities to examine, audit, excerpt, transcribe and copy, during the Trustee's normal business hours, any books, documents, papers and records relating to the Trust Account or the Assets.

(g) Unless otherwise provided in this Trust Agreement, the Trustee is authorized to follow and rely upon all instructions given by officers of the Grantor or the Beneficiary and by attorneys-in-fact acting under written authority furnished to the Trustee by the Grantor or the Beneficiary, including, without limitation, instructions given by letter, facsimile transmission or electronic media, if the Trustee believes such instructions to be genuine and to have been signed, sent or presented by the proper party or parties. In the absence of negligence, the Trustee shall not incur any liability to anyone resulting from actions taken by the Trustee in reliance in good faith on such instructions. The Trustee shall not incur any liability in executing instructions (i)

5

---

from any attorney-in-fact prior to receipt by it of notice of the revocation of the written authority of the attorney-in-fact or (ii) from any officer of the Grantor or the Beneficiary.

(h) The duties and obligations of the Trustee shall only be such as are specifically set forth in this Trust Agreement, as it may from time to time be amended, and no implied duties or obligations shall be read into this Trust Agreement against the Trustee.

(i) No provision of this Trust Agreement shall require the Trustee to take any action which, in the Trustee's reasonable judgment, would result in any violation of this Trust Agreement or any provision of law.

(j) The Trustee may confer with counsel of its own choice in relation to matters arising under this Trust Agreement and shall have full and complete authorization from the other Parties for any action taken or suffered by it under this Trust Agreement or in respect of any transaction contemplated hereby in good faith and in accordance with the opinion of such counsel.

(k) The Trustee shall notify the Grantor and Beneficiary in writing of any payment default occurring as to any Asset within three (3) business days after Trustee receives notice of such default. In the event of a delinquency of a timely payment in regard to any of the Assets, the Trustee shall inform the Grantor and the Beneficiary immediately upon Trustee's receipt of notice of such delinquency.

(l) Notwithstanding any provision of this Agreement to the contrary, the Trustee shall be liable for (i) subject to Section 7(n), the safekeeping of the Assets and administering the Trust Account in accordance with the provisions of this Trust Agreement and (ii) its own negligence, willful misconduct or lack of good faith in performing its duties under this Trust Agreement. The Trustee shall exercise the standard of care with respect to the Assets that a professional trustee, engaged in the banking or trust company industry, having professional expertise in financial and securities processing transactions and custody would observe in such affairs. The Trustee shall be strictly liable for physical loss of or damage to Assets under its care, custody, possession or control or the care, custody, possession or control of its subcustodians, other agents or nominee(s), including but not limited to loss due to fire, burglary, robbery, theft or mysterious disappearance. In the event of loss or damage to the Assets under the care, custody, possession or control of Trustee or its subcustodians, other agents or nominee(s), Trustee shall, upon demand of the Grantor or Beneficiary, promptly replace such Assets with like kind and quality together with, all rights and privileges pertaining to the Assets (by among other methods, posting appropriate security or bond with the issuer of the Assets to obtain reissue of such Assets, or, if acceptable to the Grantor, deliver cash equivalent to the market value of the Assets as of the date of the discovery of the loss or damage). Nothing contained in any contract between Trustee and any entity authorized to hold Assets, as defined herein, shall diminish or otherwise alter the liability of Trustee to the Grantor or Beneficiary. The provisions of this paragraph shall not affect the burden of proof under applicable law with respect to the assertions of liability in any claim, action or dispute alleging any breach of or failure to observe such standard of care.

6

---

(m) The Trustee shall not be responsible for the existence, genuineness or value of any of the Assets, for the validity, perfection, priority or enforceability of the liens in or with respect to any of the Assets, for the validity of title to the Assets, for insuring the Assets, for the payment of taxes, charges, assessments or liens upon or with respect to the Assets, for any obligations under any agreements or other documents evidencing or related to any of the Assets (other than this Trust Agreement), or for the compliance of the Assets with any laws, including any Environmental Law (as hereinafter defined). The Trustee shall have no responsibility for the recording, filing or registration (or for the rerecording, refiling or reregistration) of any instrument or notice, including any financing or continuation statement or any tax or securities form, at any time in any public office or elsewhere for the purpose of perfecting, maintaining the perfection of or otherwise making effective any lien upon or with respect to any of the Assets.

(n) The Parties acknowledge and agree that certain of the Assets are and will continue to be subject to servicing and custodial agreements in effect on the date hereof (as amended or otherwise modified from time to time, including any replacements thereof, the "Servicing/Custodial Agreements"). The Grantor and the Beneficiary acknowledge and agree that (i) the Trustee shall have no liability under this Trust Agreement for any action or omission of any of the parties to the Servicing/Custodial Agreements, including with respect to any of the Assets at any time during which such Assets are under the care, custody, possession or control of any of the parties to the Servicing/Custodial Agreements or any of their respective depositories, subcustodians, other agents or nominees (and, solely for the purposes of limiting the liability and determining the duties of the Trustee under Section 7(l), none of such Persons shall be considered to be the depositories, subcustodians, agents or nominees of the Trustee), (ii) the performance by the Trustee of any of its obligations under this Trust Agreement may be delayed, limited or otherwise affected by the actions or omissions of any of the parties to the Servicing/Custodial Agreements or as a result of the Assets being subject to the Servicing/Custodial Agreements and (iii) the Trustee shall have no liability under this Trust Agreement as a result of the Trustee's failure to perform any of its obligations under this Trust Agreement as a result of the actions or omissions of any of the parties to the Servicing/Custodial Agreements or as a result of the Assets being subject to the Servicing/Custodial Agreements.

Section 8. Representations, Warranties and Covenants of the Trustee. The Trustee represents, warrants and covenants to the Grantor and Beneficiary that:

- (a) The Trustee is a Qualified United States Financial Institution;
- (b) In the ordinary course of its business, the Trustee maintains securities accounts for others and is acting in that capacity in this Trust Agreement;
- (c) The Trust Account is and at all times shall be maintained at an office of the Trustee in the United States of America;
- (d) The Trustee is not an Affiliate of the Grantor or the Beneficiary.

Section 9. The Trustee's Compensation; Expenses.

(a) The Grantor shall pay the Trustee, as compensation for its services under this Trust Agreement, a fee computed at rates determined by the Trustee from time to time and

7

---

communicated in writing to the Grantor. The Grantor shall pay or reimburse the Trustee for all of the Trustee's expenses and disbursements in connection with its duties under this Trust Agreement (including reasonable attorney's fees and expenses), except any such expense or disbursement as may arise from the Trustee's negligence, willful misconduct, lack of good faith or failure to administer the Trust Account in accordance with the terms of this Trust Agreement. The Trustee shall be entitled to deduct its compensation and expenses from payments of dividends, interest and other income in respect of the Assets held in the Trust Account prior to the deposit thereof to the Income Account as provided in Section 5 of this Agreement. The Grantor also hereby indemnifies the Trustee for, and holds it harmless against, any loss, liability, costs or expenses (including reasonable attorney's fees and expenses) incurred or made without negligence, willful misconduct or lack of good faith on the part of the Trustee, arising out of or in connection with the performance of its obligations in accordance with the provisions of this Trust Agreement (which shall be the sole obligation of the Trustee), including any loss, liability, costs or expenses arising out of or in connection with the status of the Trustee and its nominee as the holder of record of the Assets. The Grantor hereby acknowledges that the foregoing indemnities shall survive the resignation of the Trustee or the termination of this Trust Agreement and hereby grants the Trustee a lien, right of set-off and security interest in the funds in the Income Account for the payment of any claim for compensation, reimbursement or indemnity hereunder.

(b) No Assets shall be withdrawn from the Trust Account or used in any manner for paying compensation to, or reimbursement or indemnification of, the Trustee.

(c) In addition to, and without limiting, the Grantor's indemnification obligations set forth in Section 9(a), to the extent resulting from or in connection with the execution, delivery, enforcement, performance, or administration of this Trust Agreement, the Grantor shall defend, indemnify, and hold harmless the Trustee and its employees, officers, directors and agents from and against any claims, demands, penalties, fines, liabilities, settlements, damages, costs, or expenses of whatever kind or nature, known or unknown, contingent or otherwise, arising out of, or in any way related to, (i) the presence, disposal, release, or threatened release of any Hazardous Materials which are on, from, or affecting soil, water, vegetation, buildings, personal property, persons, animals, or otherwise; (ii) any personal injury (including wrongful death), property damage (real or personal) or natural resource damage arising out of or related to such Hazardous Materials; (iii) any third party claim brought or threatened, settlement reached, or government order, or any policies or requirements of the Trustee, which are based upon or in any way related to such Hazardous Materials, including, without limitation, attorney and consultant fees and expenses, investigation and laboratory fees, court costs, and litigation expenses, and (iv) any violations of Environmental Law, except, in each instance, to the extent arising from the negligence, willful misconduct or lack of good faith of the Trustee. The Grantor hereby acknowledges that the foregoing indemnities shall survive the resignation of the Trustee or the termination of this Trust Agreement and hereby grants the Trustee a lien, right of set-off and security interest in the funds in the Income Account for the payment of any claim for compensation, reimbursement or indemnity hereunder. For purposes hereof:

"Hazardous Materials" means, without limit, any pollutant, contaminant or hazardous, toxic, medical, biohazardous, or dangerous waste, substance, constituent or material, defined or regulated as such in, or for the purpose of, any applicable Environmental Law, including, without

8

---

limitation, any asbestos, any petroleum, oil (including crude oil or any fraction thereof), any radioactive substance, any polychlorinated biphenyls, any toxin, chemical, disease-causing agent or pathogen, and any other substance that gives rise to liability under any applicable Environmental Law; and

"Environmental Law" means the Comprehensive Environmental Response, Compensation and Liability Act, as amended ("CERCLA"), the Resource Conservation and Recovery Act of 1976, as amended, and any other applicable federal, state, local, or foreign statute, rule, regulation, order, judgment, directive, decree, permit, license or common law as in effect now, previously, or at any time during the term of this Trust Agreement, and regulating, relating to, or imposing liability or standards of conduct concerning air emissions, water discharges, noise emissions, the release or threatened release or discharge of any Hazardous Material into the environment, the use, manufacture, production, refinement, generation, handling, treatment, storage, transport or disposal of any Hazardous Material or otherwise concerning pollution or the protection of the outdoor or indoor environment, or human health or safety in relation to exposure to Hazardous Materials.

#### Section 10. Resignation or Removal of the Trustee.

(a) The Trustee may resign at any time upon delivery of a written notice thereof to the Beneficiary and to the Grantor effective not less than 90 days after receipt by the Beneficiary and the Grantor of such notice. The Trustee may be removed by prior written notice executed by Grantor and Beneficiary. No such resignation or removal shall become effective until a successor Trustee has been appointed and approved by the Beneficiary and the Grantor and all Assets in the Trust Account have been duly transferred to the successor Trustee in accordance with paragraph (b) of this Section 10.

(b) Upon receipt by the proper Parties of the Trustee's notice of resignation or the Grantor's and Beneficiary's notice of removal, the Grantor and the Beneficiary shall appoint a successor Trustee. Any successor Trustee shall be a bank that is a member of the Federal Reserve System and a Qualified United States Financial Institution, and shall not be an Affiliate of the Grantor or the Beneficiary. Upon the acceptance of the appointment as Trustee hereunder by a successor Trustee and the transfer to such successor Trustee of all Assets in the Trust Account, the resignation or removal of the Trustee shall become effective. Thereupon, such successor Trustee shall succeed to and become vested with all the rights, powers, privileges and duties of the resigning or removed Trustee, and the resigning or removed Trustee shall be discharged from any future duties and obligations under this Trust Agreement, but the resigning or removed Trustee shall continue after such resignation or removal to be entitled to the benefits of the indemnities provided herein for the Trustee.

#### Section 11. Termination of the Trust Account.

(a) The Trust Account and this Trust Agreement, except for the indemnities provided herein, may be terminated only after the Grantor and Beneficiary mutually give the Trustee written notice of their intention to terminate the Trust Account (the "Notice of Intention"). The Notice of Intention shall specify the date on which the Parties intend the Trust Account to terminate (the "Termination Date").

9

---

(b) On the Termination Date, the Trustee shall transfer to the Grantor all of the Assets not previously withdrawn by the Beneficiary.

Section 12. Definitions. Except as the context shall otherwise require, the following terms shall have the following meanings for purposes of this Trust Agreement (the definitions to be applicable to both the singular and the plural forms of each term defined if both forms of such term are used in this Trust Agreement):

The term "Affiliate" means any other Person that directly or indirectly controls, is controlled by, or is under common control with, the first Person.

The term "Beneficiary" shall include any successor of the Beneficiary by operation of law including, without limitation, any liquidator, rehabilitator, receiver or conservator.

The term "Control" (including the related terms "controlled by" and "under common control with") shall mean the ownership, directly or indirectly, of more than 50% of the voting securities of a corporation.

The term "Eligible Securities" shall mean and include certificates of deposit (issued by a United States bank and payable in United States legal tender) and other

assets of the types specified on Exhibit B attached hereto.

The terms "Person" shall mean and include an individual, a corporation, a partnership, an association, a trust, an unincorporated organization or a government or political subdivision thereof.

The term "Qualified United States Financial Institution" shall mean a bank designated as such by the Securities Valuation Office of the National Association of Insurance Commissioners (or any successor organization or regulatory agency having similar duties).

Section 13. Governing Law. This Trust Agreement shall be subject to and governed by the laws of the State of New York without regard to its conflict of laws provision and the Trust Account created hereunder shall be administered in accordance with the laws of said state.

Section 14. WAIVER OF JURY TRIAL. EACH PARTY HERETO HEREBY WAIVES TRIAL BY JURY IN ANY JUDICIAL PROCEEDING INVOLVING, DIRECTLY OR INDIRECTLY, ANY MATTER (WHETHER SOUNDING IN TORT, CONTRACT OR OTHERWISE) IN ANY WAY ARISING OUT OF OR RELATED TO THIS AGREEMENT OR THE RELATIONSHIP ESTABLISHED HEREUNDER. THIS PROVISION IS A MATERIAL INDUCEMENT FOR THE PARTIES TO ENTER INTO THIS AGREEMENT.

Section 15. Successors and Assigns. This Trust Agreement shall be binding upon and inure to the benefit of the Parties and their respective successors, permitted assigns and legal representatives. Neither this Trust Agreement, nor any right or obligation hereunder, may be assigned by any Party without the prior written consent of the other Parties hereto. Any assignment in violation of this Section 15 shall be void and shall have no force and effect.

10

---

Section 16. Severability. If any provision of this Trust Agreement is held to be void or unenforceable, in whole or in part, (i) such holding shall not affect the validity and enforceability of the remainder of this Trust Agreement, including any other provision, paragraph or subparagraph, and (ii) the Parties agree to attempt in good faith to reform such void or unenforceable provision to the extent necessary to render such provision enforceable and to carry out its original intent.

Section 17. Entire Agreement. Except for the Coinsurance Agreements, this Trust Agreement constitutes the entire agreement among the Parties with respect to the subject matter hereof, and there are no understandings or agreements, conditions or qualifications relative to this Trust Agreement which are not fully expressed in this Trust Agreement or the Coinsurance Agreements.

Section 18. Amendments. This Trust Agreement may be modified or otherwise amended, and the observance of any term of this Trust Agreement may be waived, only if such modification, amendment or waiver is in writing and signed by the Parties.

Section 19. Notices. All notices, requests, demands and other communications under this Trust Agreement must be in writing and will be deemed to have been duly given or made as follows: (a) if sent by registered or certified mail in the United States return receipt requested, upon receipt; (b) if sent by reputable overnight air courier, two (2) business days after mailing; (c) if sent by facsimile transmission, with a copy mailed on the same day in the manner provided in (a) or (b) above, when transmitted and receipt is confirmed by telephone; or (d) if otherwise actually personally delivered, when delivered, and shall be delivered as follows:

If to the Grantor:

Union Fidelity Life Insurance Company  
200 North Martingale Road  
Schaumburg, IL 60173-2096  
Facsimile: (847) 330-3404  
Attention: Chief Financial Officer

With a copy to:

Union Fidelity Life Insurance Company  
200 North Martingale Road  
Schaumburg, IL 60173-2096  
Facsimile: (847) 605-3044  
Attention: General Counsel

If to the Beneficiary:

GE Capital Life Assurance Company of New York  
6610 West Broad Street  
Richmond, VA 23230

11

---

Facsimile: (804) 281-6165  
Attention: Chief Executive Officer

With a copy to:

GE Capital Life Assurance Company of New York  
6610 West Broad Street  
Richmond, VA 23230  
Facsimile: (804) 281-6005  
Attention: General Counsel

If to the Trustee:

The Bank of New York  
101 Barclay Street - 8W  
New York, NY 10286  
Facsimile: (212) 815-5875  
Attention: Insurance Trust and Escrow Unit

or to such other address or to such other Person as a Party may have last designated by notice to the other Parties.

Section 20. Headings. The headings of the Sections have been inserted for convenience of reference only and shall not be deemed to constitute a part of this Trust Agreement.

Section 21. Counterparts. This Trust Agreement may be executed in any number of counterparts, each of which when so executed and delivered shall constitute an original, but such counterparts together shall constitute but one and the same Trust Agreement.

**IN WITNESS WHEREOF**, the parties hereto have caused this Trust Agreement to be executed and delivered by their respective officers thereunto duly authorized as of the date first above written.

UNION FIDELITY LIFE INSURANCE  
COMPANY, as Grantor

By: /s/ GLENN JOPPA  
Name: Glenn Joppa  
Title: Senior Vice President and Secretary

GE CAPITAL LIFE ASSURANCE  
COMPANY OF NEW YORK, as  
Beneficiary

By: /s/ GARY T. PRIZZIA  
Name: Gary T. Prizzia  
Title: Treasurer

THE BANK OF NEW YORK, as Trustee

By: /s/ ROBERT W. RICH  
Name: Robert W. Rich  
Title: Vice President

**Exhibit A-1**

**CERTIFICATE**

The undersigned, the [insert position] and a duly authorized officer of GE Capital Life Assurance Company of New York, does hereby certify that, pursuant to Section 2 of the Trust Agreement dated as of [ ] entered into by and among GE Capital Life Assurance Company of New York, Union Fidelity Life Insurance Company and [ ] (the "Trust Agreement") and the Coinsurance Agreement dated as of [ ] between GE Capital Life Assurance Company of New York and Union Fidelity Life Insurance Company, GE Capital Life Assurance Company of New York is entitled to withdraw from the Trust Account established by Union Fidelity Life Insurance Company for the benefit of GE Capital Life Assurance Company of New York pursuant to the Trust Agreement, assets with a current statutory book value equal to \$[ ] for the purpose[s] specified in paragraph[s] [ ] and [ ] of Section [ ] of the Coinsurance Agreement.

**[Certification to specify the basis for the withdrawal.]**

This Certificate is a "Beneficiary Certificate" within the meaning of Section 2(a) of the Trust Agreement.

Dated: \_\_\_\_\_

\_\_\_\_\_  
Name:  
Title:

**Exhibit A-2**

**REQUEST FOR WITHDRAWAL**

GE Capital Life Assurance Company of New York ("GECLANY") hereby requests that [ ] immediately transfer to GECLANY [/or [ ]] all right, title and interest in those assets set forth on Schedule A attached hereto (which assets have a statutory book value equal to \$[ ]) from the Trust Account established by Union Fidelity Life Insurance Company ("UFLIC") for the benefit of GECLANY pursuant to the Trust Agreement dated as of [ , ] entered into by and among GECLANY, UFLIC and [ ] (the "Trust Agreement"). [Insert transfer instructions.]

This Request for Withdrawal is a "Beneficiary Request for Withdrawal" within the meaning of Section 2(a) of the Trust Agreement, and is made in conjunction with the attached Beneficiary Certificate.

GE CAPITAL LIFE ASSURANCE  
COMPANY OF NEW YORK

Dated: \_\_\_\_\_

By: \_\_\_\_\_  
Name:  
Title:

15

---

**Exhibit B**

**ELIGIBLE SECURITIES**

Assets of the types for which an Illinois-domiciled life insurance company could obtain full statutory reserve credit under statutory accounting practices prescribed or permitted by the Director of Insurance of the State of Illinois.

16

---

**TRUST AGREEMENT**

This TRUST AGREEMENT, dated as of April 15, 2004 (this "Trust Agreement"), among Union Fidelity Life Insurance Company, an insurance company organized under the Laws of the State of Illinois (the "Grantor"), First Colony Life Insurance Company, an insurance company organized under the laws of the Commonwealth of Virginia (the "Beneficiary"), and The Bank of New York, a New York corporation (the "Trustee") (the Grantor, the Beneficiary and the Trustee are hereinafter each sometimes referred to individually as a "Party" and collectively as the "Parties"). All terms not defined herein shall have the same meanings as set forth in the Coinsurance Agreement (as hereinafter defined).

**WITNESSETH:**

**WHEREAS**, pursuant to a Coinsurance Agreement of even date herewith between the Beneficiary and the Grantor, the Beneficiary is ceding to the Grantor, and the Grantor is reinsuring on a coinsurance basis, certain of the Beneficiary's liabilities arising under structured settlement annuities (the "Coinsurance Agreement"); and

**WHEREAS**, the Grantor desires to transfer to the Trustee for deposit to a trust account (the "Trust Account") certain assets as security for the payment and performance by the Grantor of its obligations under the Coinsurance Agreement; and

**WHEREAS**, the Trustee has agreed to act as Trustee hereunder, and to hold such assets in trust in the Trust Account for the sole use and benefit of the Beneficiary for such purposes in accordance with the terms and conditions of this Trust Agreement; and

**WHEREAS**, this Trust Agreement is made for the sole use and benefit of the Beneficiary and for the purpose of setting forth the duties and powers of the Trustee with respect to the Trust Account;

**NOW, THEREFORE**, for and in consideration of the premises and for other good and valuable consideration, the receipt of which is hereby acknowledged, the Parties hereby agree as follows:

Section 1. Deposit of Assets to the Trust Account

(a) The Grantor hereby establishes the Trust Account with the Trustee for the sole use and benefit of the Beneficiary, under the terms set forth herein. The Trustee shall administer the Trust Account in its name as Trustee for the sole benefit of the Beneficiary. The Trust Account shall be subject to withdrawal by the Beneficiary solely as provided herein. The Trustee hereby accepts the Trust Account upon the terms set forth in this Trust Agreement.

(b) The Grantor shall transfer to the Trustee, for deposit to the Trust Account, such assets as may be required from time to time pursuant to the Coinsurance Agreement (all such assets are herein referred to individually as an "Asset" and collectively as the "Assets"). The Trustee is authorized and shall have power to receive the Assets from the Grantor and to hold, invest, reinvest and dispose of the same for the uses and purposes of and according to the provisions herein set forth. All Assets shall be maintained by the Trustee in the Trust Account separate and distinct from all other assets on the books of the Trustee and in accordance with the terms of this Trust Agreement. The Assets shall consist only of Eligible Securities (as hereinafter defined). In the event of any payment default as to any Asset in the Trust Account or in the event that any Asset no longer is an Eligible Security, the Grantor shall, within five (5) business days after receiving notice from the Trustee pursuant to Section 19 or the Grantor having knowledge of such default or ineligibility, substitute other Assets which meet the requirements of an Eligible Security and having a statutory book value equal to the statutory book value of such Asset, which has a payment default or no longer meets the requirements for an Eligible Security, on the last statement provided by the Trustee.

(c) The Grantor hereby represents and warrants (i) that, to the extent practicable, any Assets transferred by the Grantor to the Trustee for deposit to the Trust Account will be in such form that the Beneficiary whenever necessary may, and the Trustee upon direction by the Beneficiary will, negotiate any such Assets without consent or signature from the Grantor or any other person or entity in accordance with the terms of this Trust Agreement, (ii) that all Assets transferred by the Grantor to the Trustee for deposit into the Trust Account consist only of Eligible Securities, and (iii) that Grantor has at the time of transfer into this Trust Account good and marketable title to the Assets to be so transferred and each such Asset shall be at the time of transfer free and clear of all claims, liens, interests and encumbrances (other than those arising under this Trust Agreement).

(d) Prior to depositing the Assets into the Trust Account, and from time to time thereafter as required, the Grantor shall execute assignments, endorsement in blank, or transfer legal title to the Trustee of all shares, obligations or other Assets requiring assignments, so that, to the extent practicable, the Beneficiary whenever necessary may, and the Trustee upon the direction by the Beneficiary will, negotiate any such Assets without the consent or signature from the Grantor or any other person or entity. The Grantor shall give all notices and take all actions as the Trustee deems appropriate in order to cause payments due or that become due on any Asset within the Trust Account to be paid to the Trustee. The Grantor shall not make or consent to any waiver, amendment or restriction on transfer with respect to any Asset in the Trust Account, in each case without the Beneficiary's prior written consent. In connection with the deposit of Assets into the Trust Account, the Grantor shall furnish to the Trustee all original documentation evidencing the Grantor's ownership thereto.

(e) The parties recognize that certain Assets will not be readily negotiable and that certain notices, opinions of counsel, representations and/or consents will be required for the Beneficiary to obtain good and marketable title to such Assets.

Section 2. Withdrawal of Assets from the Trust Account

(a) Without notice to the Grantor, the Beneficiary shall have the right, at any time and from time to time, to withdraw from the Trust Account, upon notice to the Trustee in the form of a certificate substantially in the form of Exhibit A-1 attached hereto (the "Beneficiary Certificate"), signed by a duly authorized officer of the Beneficiary, accompanied by a request for withdrawal substantially in the form of Exhibit A-2 hereto (the "Beneficiary Request for Withdrawal"), signed by a duly authorized officer of the Beneficiary, such Assets as are specified in such Beneficiary Request for Withdrawal. The Beneficiary Request for Withdrawal may designate a third party (the "Beneficiary Designee"), including the Grantor, to whom Assets specified therein shall be delivered. The Beneficiary shall not be required to present any other statement or document in addition to a Beneficiary Certificate and a Beneficiary Request for Withdrawal in order to withdraw any Assets, except that the Beneficiary shall acknowledge receipt of any such Assets withdrawn upon request by the Trustee.

(b) Upon receipt of a Beneficiary Certificate and a Beneficiary Request for Withdrawal, subject to the provision by the Beneficiary of any required notices, opinions of counsel and representations, the Trustee and the Grantor shall use commercially reasonable efforts to transfer absolutely and unequivocally all right, title and interest in the Assets specified in such Beneficiary Request for Withdrawal and shall deliver physical custody (or such other form as is necessary to complete the transfer) of such Assets to or for the account of the Beneficiary or such Beneficiary Designee, as specified in such Beneficiary Request for Withdrawal. The Trustee shall notify the Grantor and Beneficiary within three (3) business days following each withdrawal from the Trust Account.

(c) Subject to Section 4, in the absence of a Beneficiary Certificate and a Beneficiary Request for Withdrawal, the Trustee shall allow no substitution or withdrawal of any Asset from the Trust Account.

(d) The Trustee shall notify the insurance regulator in the state where the Beneficiary is domiciled within three (3) business days after all the assets in the Trust Account are withdrawn. At the Trustee's request, the Beneficiary shall provide to the Trustee the address of the insurance regulator in the state where the Beneficiary is domiciled.

Section 3. Application of Assets. The Beneficiary shall be permitted to withdraw Assets from the Trust Account only for the purposes set forth in the Coinsurance Agreement.

Section 4. Redemption, Investment and Substitution of Assets.

(a) The Trustee shall surrender for payment all maturing Assets and all Assets called for redemption, and deposit the principal amount of the proceeds of any such payment to the Trust Account.

(b) The Grantor, subject to the prior written approval of the Beneficiary, may retain (and pay the service fees of) a professional asset manager (the "Asset Manager") to manage and make investment decisions with regard to the Assets held by the Trustee in the Trust Account. From time to time, at the written order and direction of the Grantor or the Asset Manager, the Trustee shall invest Assets in the Trust Account in Eligible Securities.

3

---

(c) From time to time, subject to the prior written approval of the Beneficiary, the Grantor or the Asset Manager may direct the Trustee to substitute Assets of equal statutory book value for other Assets presently held in the Trust Account. The Trustee shall have no responsibility whatsoever to determine the value of such substituted Assets or that such substituted Assets constitute Eligible Securities.

(d) All investments and substitutions of securities referred to in Sections 4(b) and 4(c) above shall be in compliance with the definition of "Eligible Securities" in Section 12 of this Trust Agreement. Any instruction or order concerning such investments or substitutions of securities shall be referred to herein as an "Investment Order". The Trustee shall execute Investment Orders and settle securities transactions by itself or by means of an agent or broker. The Trustee shall not be responsible for any act or omission, or for the solvency, of any such agent or broker, except as set forth in Section 7.

(e) From time to time, upon notice to the Beneficiary, the Trustee may withdraw any Asset in the Trust Account upon the call or maturity of such Asset provided that the proceeds from such call or maturity are deposited into the Trust Account.

(f) When the Trustee is directed to deliver Assets against payment, delivery will be made in accordance with generally accepted market practice.

(g) Any loss incurred from any investment pursuant to the terms of this Section 4 shall be borne exclusively by the Trust Account.

(h) The Trustee shall not foreclose on, or direct or consent to the foreclosure of, any real property securing a commercial loan constituting an Asset or take title to such property by deed-in-lieu of foreclosure or other means without the prior written consent of the Grantor and the Beneficiary. The Trustee shall not provide any consent or direction with respect to any such commercial loan except at the written direction of the Grantor.

Section 5. The Income Account. All payments of interest, dividends and other income in respect to Assets in the Trust Account shall be the property of the Grantor and shall be deposited by the Trustee subject to deduction of the Trustee's compensation and expenses as provided in Section 9 of this Agreement, in a separate account (the "Income Account") established and maintained by the Grantor at an office of the Trustee. The Grantor may withdraw amounts from the Income Account at any time and from time to time.

Section 6. Right to Vote Assets. The Trustee shall forward all annual and interim stockholder reports and all proxies and proxy materials relating to the Assets in the Trust Account to the Grantor within a reasonable period of time following the Trustee's receipt thereof. The Grantor shall have the full and unqualified right to vote any Asset in the Trust Account.

Section 7. Additional Rights and Duties of the Trustee.

(a) Before accepting any Asset for deposit to the Trust Account, the Trustee shall determine that such Asset is in such form that, to the extent practicable, the Beneficiary whenever necessary may, or the Trustee upon direction by the Beneficiary will, negotiate such

4

---

Asset without consent or signature from the Grantor or any person or entity other than the Trustee in accordance with the terms of this Trust Agreement.

(b) The Trustee shall be under no obligation to determine whether or not any instructions given by the Grantor and Beneficiary are contrary to any provision of law. It is understood and agreed that the Trustee's duties are solely those set forth herein and that the Trustee shall have no duty to take any other action unless specifically agreed to by the Trustee in writing. Without limiting the generality of the foregoing, the Trustee shall not have any duty to advise, manage, supervise or make recommendations with respect to the purchase, retention or sale of Assets with respect to any Assets in the Trust Account as to which a default in the payment of principal or interest has occurred or to be responsible for the consequences of insolvency or the legal inability of any broker, dealer, bank or other agent employed by the Grantor or Trustee with respect to the Assets except to the extent that the Trustee was negligent, engaged in misconduct or acted in bad faith in the selection of any such person or entity.

(c) The Trustee shall accept and open all mail directed to the Grantor or the Beneficiary in care of the Trustee.

(d) The Trustee shall have no responsibility whatsoever to determine that any Assets in the Trust Account are or continue to be Eligible Securities.

(e) The Trustee shall furnish to the Grantor and the Beneficiary a statement of all Assets in the Trust Account upon the inception of the Trust Account and at the end of each calendar month thereafter. The statement shall include a description of the Assets in the Trust Account and shall be delivered within five (5) business days following the end of such calendar month.

(f) The Trustee shall keep full and complete records of the administration of the Trust Account in accordance with all applicable law. Upon the request of the Grantor or the Beneficiary, the Trustee shall promptly permit the Grantor or the Beneficiary, their respective agents, employees, independent auditors and regulatory authorities to examine, audit, excerpt, transcribe and copy, during the Trustee's normal business hours, any books, documents, papers and records relating to the Trust Account or the Assets.



(g) Unless otherwise provided in this Trust Agreement, the Trustee is authorized to follow and rely upon all instructions given by officers of the Grantor or the Beneficiary and by attorneys-in-fact acting under written authority furnished to the Trustee by the Grantor or the Beneficiary, including, without limitation, instructions given by letter, facsimile transmission or electronic media, if the Trustee believes such instructions to be genuine and to have been signed, sent or presented by the proper party or parties. In the absence of negligence, the Trustee shall not incur any liability to anyone resulting from actions taken by the Trustee in reliance in good faith on such instructions. The Trustee shall not incur any liability in executing instructions (i) from any attorney-in-fact prior to receipt by it of notice of the revocation of the written authority of the attorney-in-fact or (ii) from any officer of the Grantor or the Beneficiary.

5

---

(h) The duties and obligations of the Trustee shall only be such as are specifically set forth in this Trust Agreement, as it may from time to time be amended, and no implied duties or obligations shall be read into this Trust Agreement against the Trustee.

(i) No provision of this Trust Agreement shall require the Trustee to take any action which, in the Trustee's reasonable judgment, would result in any violation of this Trust Agreement or any provision of law.

(j) The Trustee may confer with counsel of its own choice in relation to matters arising under this Trust Agreement and shall have full and complete authorization from the other Parties for any action taken or suffered by it under this Trust Agreement or in respect of any transaction contemplated hereby in good faith and in accordance with the opinion of such counsel.

(k) The Trustee shall notify the Grantor and Beneficiary in writing of any payment default occurring as to any Asset within three (3) business days after Trustee receives notice of such default. In the event of a delinquency of a timely payment in regard to any of the Assets, the Trustee shall inform the Grantor and the Beneficiary immediately upon Trustee's receipt of notice of such delinquency.

(l) Notwithstanding any provision of this Agreement to the contrary, the Trustee shall be liable for (i) subject to Section 7(n), the safekeeping of the Assets and administering the Trust Account in accordance with the provisions of this Trust Agreement and (ii) its own negligence, willful misconduct or lack of good faith in performing its duties under this Trust Agreement. The Trustee shall exercise the standard of care with respect to the Assets that a professional trustee, engaged in the banking or trust company industry, having professional expertise in financial and securities processing transactions and custody would observe in such affairs. The Trustee shall be strictly liable for physical loss of or damage to Assets under its care, custody, possession or control or the care, custody, possession or control of its subcustodians, other agents or nominee(s), including but not limited to loss due to fire, burglary, robbery, theft or mysterious disappearance. In the event of loss or damage to the Assets under the care, custody, possession or control of Trustee or its subcustodians, other agents or nominee(s), Trustee shall, upon demand of the Grantor or Beneficiary, promptly replace such Assets with like kind and quality together with, all rights and privileges pertaining to the Assets (by among other methods, posting appropriate security or bond with the issuer of the Assets to obtain reissue of such Assets, or, if acceptable to the Grantor, deliver cash equivalent to the market value of the Assets as of the date of the discovery of the loss or damage). Nothing contained in any contract between Trustee and any entity authorized to hold Assets, as defined herein, shall diminish or otherwise alter the liability of Trustee to the Grantor or Beneficiary. The provisions of this paragraph shall not affect the burden of proof under applicable law with respect to the assertions of liability in any claim, action or dispute alleging any breach of or failure to observe such standard of care.

(m) The Trustee shall not be responsible for the existence, genuineness or value of any of the Assets, for the validity, perfection, priority or enforceability of the liens in or with respect to any of the Assets, for the validity of title to the Assets, for insuring the Assets, for the payment of taxes, charges, assessments or liens upon or with respect to the Assets, for any obligations

6

---

under any agreements or other documents evidencing or related to any of the Assets (other than this Trust Agreement), or for the compliance of the Assets with any laws, including any Environmental Law (as hereinafter defined). The Trustee shall have no responsibility for the recording, filing or registration (or for the rerecording, refiling or reregistration) of any instrument or notice, including any financing or continuation statement or any tax or securities form, at any time in any public office or elsewhere for the purpose of perfecting, maintaining the perfection of or otherwise making effective any lien upon or with respect to any of the Assets.

(n) The Parties acknowledge and agree that certain of the Assets are and will continue to be subject to servicing and custodial agreements in effect on the date hereof (as amended or otherwise modified from time to time, including any replacements thereof, the "Servicing/Custodial Agreements"). The Grantor and the Beneficiary acknowledge and agree that (i) the Trustee shall have no liability under this Trust Agreement for any action or omission of any of the parties to the Servicing/Custodial Agreements, including with respect to any of the Assets at any time during which such Assets are under the care, custody, possession or control of any of the parties to the Servicing/Custodial Agreements or any of their respective depositories, subcustodians, other agents or nominees (and, solely for the purposes of limiting the liability and determining the duties of the Trustee under Section 7(l), none of such Persons shall be considered to be the depositories, subcustodians, agents or nominees of the Trustee), (ii) the performance by the Trustee of any of its obligations under this Trust Agreement may be delayed, limited or otherwise affected by the actions or omissions of any of the parties to the Servicing/Custodial Agreements or as a result of the Assets being subject to the Servicing/Custodial Agreements and (iii) the Trustee shall have no liability under this Trust Agreement as a result of the Trustee's failure to perform any of its obligations under this Trust Agreement as a result of the actions or omissions of any of the parties to the Servicing/Custodial Agreements or as a result of the Assets being subject to the Servicing/Custodial Agreements.

Section 8. Representations, Warranties and Covenants of the Trustee. The Trustee represents, warrants and covenants to the Grantor and Beneficiary that:

- (a) The Trustee is a Qualified United States Financial Institution;
- (b) In the ordinary course of its business, the Trustee maintains securities accounts for others and is acting in that capacity in this Trust Agreement;
- (c) The Trust Account is and at all times shall be maintained at an office of the Trustee in the United States of America;
- (d) The Trustee is not an Affiliate of the Grantor or the Beneficiary.

Section 9. The Trustee's Compensation: Expenses.

(a) The Grantor shall pay the Trustee, as compensation for its services under this Trust Agreement, a fee computed at rates determined by the Trustee from time to time and communicated in writing to the Grantor. The Grantor shall pay or reimburse the Trustee for all of the Trustee's expenses and disbursements in connection with its duties under this Trust Agreement (including reasonable attorney's fees and expenses), except any such expense or disbursement as may arise from the Trustee's negligence, willful misconduct, lack of good faith

7

---

or failure to administer the Trust Account in accordance with the terms of this Trust Agreement. The Trustee shall be entitled to deduct its compensation and expenses from

payments of dividends, interest and other income in respect of the Assets held in the Trust Account prior to the deposit thereof to the Income Account as provided in Section 5 of this Agreement. The Grantor also hereby indemnifies the Trustee for, and holds it harmless against, any loss, liability, costs or expenses (including reasonable attorney's fees and expenses) incurred or made without negligence, willful misconduct or lack of good faith on the part of the Trustee, arising out of or in connection with the performance of its obligations in accordance with the provisions of this Trust Agreement (which shall be the sole obligation of the Trustee), including any loss, liability, costs or expenses arising out of or in connection with the status of the Trustee and its nominee as the holder of record of the Assets. The Grantor hereby acknowledges that the foregoing indemnities shall survive the resignation of the Trustee or the termination of this Trust Agreement and hereby grants the Trustee a lien, right of set-off and security interest in the funds in the Income Account for the payment of any claim for compensation, reimbursement or indemnity hereunder.

(b) No Assets shall be withdrawn from the Trust Account or used in any manner for paying compensation to, or reimbursement or indemnification of, the Trustee.

(c) In addition to, and without limiting, the Grantor's indemnification obligations set forth in Section 9(a), to the extent resulting from or in connection with the execution, delivery, enforcement, performance, or administration of this Trust Agreement, the Grantor shall defend, indemnify, and hold harmless the Trustee and its employees, officers, directors and agents from and against any claims, demands, penalties, fines, liabilities, settlements, damages, costs, or expenses of whatever kind or nature, known or unknown, contingent or otherwise, arising out of, or in any way related to, (i) the presence, disposal, release, or threatened release of any Hazardous Materials which are on, from, or affecting soil, water, vegetation, buildings, personal property, persons, animals, or otherwise; (ii) any personal injury (including wrongful death), property damage (real or personal) or natural resource damage arising out of or related to such Hazardous Materials; (iii) any third party claim brought or threatened, settlement reached, or government order, or any policies or requirements of the Trustee, which are based upon or in any way related to such Hazardous Materials, including, without limitation, attorney and consultant fees and expenses, investigation and laboratory fees, court costs, and litigation expenses, and (iv) any violations of Environmental Law, except, in each instance, to the extent arising from the negligence, willful misconduct or lack of good faith of the Trustee. The Grantor hereby acknowledges that the foregoing indemnities shall survive the resignation of the Trustee or the termination of this Trust Agreement and hereby grants the Trustee a lien, right of set-off and security interest in the funds in the Income Account for the payment of any claim for compensation, reimbursement or indemnity hereunder. For purposes hereof:

"Hazardous Materials" means, without limit, any pollutant, contaminant or hazardous, toxic, medical, biohazardous, or dangerous waste, substance, constituent or material, defined or regulated as such in, or for the purpose of, any applicable Environmental Law, including, without limitation, any asbestos, any petroleum, oil (including crude oil or any fraction thereof), any radioactive substance, any polychlorinated biphenyls, any toxin, chemical, disease-causing agent or pathogen, and any other substance that gives rise to liability under any applicable Environmental Law; and

8

---

"Environmental Law" means the Comprehensive Environmental Response, Compensation and Liability Act, as amended ("CERCLA"), the Resource Conservation and Recovery Act of 1976, as amended, and any other applicable federal, state, local, or foreign statute, rule, regulation, order, judgment, directive, decree, permit, license or common law as in effect now, previously, or at any time during the term of this Trust Agreement, and regulating, relating to, or imposing liability or standards of conduct concerning air emissions, water discharges, noise emissions, the release or threatened release or discharge of any Hazardous Material into the environment, the use, manufacture, production, refinement, generation, handling, treatment, storage, transport or disposal of any Hazardous Material or otherwise concerning pollution or the protection of the outdoor or indoor environment, or human health or safety in relation to exposure to Hazardous Materials.

#### Section 10. Resignation or Removal of the Trustee.

(a) The Trustee may resign at any time upon delivery of a written notice thereof to the Beneficiary and to the Grantor effective not less than 90 days after receipt by the Beneficiary and the Grantor of such notice. The Trustee may be removed by prior written notice executed by Grantor and Beneficiary. No such resignation or removal shall become effective until a successor Trustee has been appointed and approved by the Beneficiary and the Grantor and all Assets in the Trust Account have been duly transferred to the successor Trustee in accordance with paragraph (b) of this Section 10.

(b) Upon receipt by the proper Parties of the Trustee's notice of resignation or the Grantor's and Beneficiary's notice of removal, the Grantor and the Beneficiary shall appoint a successor Trustee. Any successor Trustee shall be a bank that is a member of the Federal Reserve System and a Qualified United States Financial Institution, and shall not be an Affiliate of the Grantor or the Beneficiary. Upon the acceptance of the appointment as Trustee hereunder by a successor Trustee and the transfer to such successor Trustee of all Assets in the Trust Account, the resignation or removal of the Trustee shall become effective. Thereupon, such successor Trustee shall succeed to and become vested with all the rights, powers, privileges and duties of the resigning or removed Trustee, and the resigning or removed Trustee shall be discharged from any future duties and obligations under this Trust Agreement, but the resigning or removed Trustee shall continue after such resignation or removal to be entitled to the benefits of the indemnities provided herein for the Trustee.

#### Section 11. Termination of the Trust Account.

(a) The Trust Account and this Trust Agreement, except for the indemnities provided herein, may be terminated only after the Grantor and Beneficiary mutually give the Trustee written notice of their intention to terminate the Trust Account (the "Notice of Intention"). The Notice of Intention shall specify the date on which the Parties intend the Trust Account to terminate (the "Termination Date").

(b) On the Termination Date, the Trustee shall transfer to the Grantor all of the Assets not previously withdrawn by the Beneficiary.

9

---

Section 12. Definitions. Except as the context shall otherwise require, the following terms shall have the following meanings for purposes of this Trust Agreement (the definitions to be applicable to both the singular and the plural forms of each term defined if both forms of such term are used in this Trust Agreement):

The term "Affiliate" means any other Person that directly or indirectly controls, is controlled by, or is under common control with, the first Person.

The term "Beneficiary" shall include any successor of the Beneficiary by operation of law including, without limitation, any liquidator, rehabilitator, receiver or conservator.

The term "Control" (including the related terms "controlled by" and "under common control with") shall mean the ownership, directly or indirectly, of more than 50% of the voting securities of a corporation.

The term "Eligible Securities" shall mean and include certificates of deposit (issued by a United States bank and payable in United States legal tender) and other assets of the types specified on Exhibit B attached hereto.

The terms "Person" shall mean and include an individual, a corporation, a partnership, an association, a trust, an unincorporated organization or a government or political subdivision thereof.

The term "Qualified United States Financial Institution" shall mean a bank designated as such by the Securities Valuation Office of the National Association of

Insurance Commissioners (or any successor organization or regulatory agency having similar duties).

Section 13. Governing Law. This Trust Agreement shall be subject to and governed by the laws of the State of New York without regard to its conflict of laws provision and the Trust Account created hereunder shall be administered in accordance with the laws of said state.

Section 14. WAIVER OF JURY TRIAL. EACH PARTY HERETO HEREBY WAIVES TRIAL BY JURY IN ANY JUDICIAL PROCEEDING INVOLVING, DIRECTLY OR INDIRECTLY, ANY MATTER (WHETHER SOUNDING IN TORT, CONTRACT OR OTHERWISE) IN ANY WAY ARISING OUT OF OR RELATED TO THIS AGREEMENT OR THE RELATIONSHIP ESTABLISHED HEREUNDER. THIS PROVISION IS A MATERIAL INDUCEMENT FOR THE PARTIES TO ENTER INTO THIS AGREEMENT.

Section 15. Successors and Assigns. This Trust Agreement shall be binding upon and inure to the benefit of the Parties and their respective successors, permitted assigns and legal representatives. Neither this Trust Agreement, nor any right or obligation hereunder, may be assigned by any Party without the prior written consent of the other Parties hereto. Any assignment in violation of this Section 15 shall be void and shall have no force and effect.

Section 16. Severability. If any provision of this Trust Agreement is held to be void or unenforceable, in whole or in part, (i) such holding shall not affect the validity and enforceability of the remainder of this Trust Agreement, including any other provision, paragraph or subparagraph, and (ii) the Parties agree to attempt in good faith to reform such void or

10

---

unenforceable provision to the extent necessary to render such provision enforceable and to carry out its original intent.

Section 17. Entire Agreement. Except for the Coinsurance Agreement, this Trust Agreement constitutes the entire agreement among the Parties with respect to the subject matter hereof, and there are no understandings or agreements, conditions or qualifications relative to this Trust Agreement which are not fully expressed in this Trust Agreement or the Coinsurance Agreement.

Section 18. Amendments. This Trust Agreement may be modified or otherwise amended, and the observance of any term of this Trust Agreement may be waived, only if such modification, amendment or waiver is in writing and signed by the Parties.

Section 19. Notices. All notices, requests, demands and other communications under this Trust Agreement must be in writing and will be deemed to have been duly given or made as follows: (a) if sent by registered or certified mail in the United States return receipt requested, upon receipt; (b) if sent by reputable overnight air courier, two (2) business days after mailing; (c) if sent by facsimile transmission, with a copy mailed on the same day in the manner provided in (a) or (b) above, when transmitted and receipt is confirmed by telephone; or (d) if otherwise actually personally delivered, when delivered, and shall be delivered as follows:

If to the Grantor:

Union Fidelity Life Insurance Company  
200 North Martingale Road  
Schaumburg, IL 60173-2096  
Facsimile: (847) 330-3404  
Attention: Chief Financial Officer

With a copy to:

Union Fidelity Life Insurance Company  
200 North Martingale Road  
Schaumburg, IL 60173-2096  
Facsimile: (847) 605-3044  
Attention: General Counsel

If to the Beneficiary:

First Colony Life Insurance Company  
700 Main Street  
Lynchburg, VA 24504  
Facsimile: (434) 948-5064  
Attention: Chief Executive Officer

11

---

With a copy to:

First Colony Life Insurance Company  
700 Main Street  
Lynchburg, VA 24504  
Facsimile: (434) 948-5819  
Attention: General Counsel

If to the Trustee:

The Bank of New York  
101 Barclay Street - 8W  
New York, NY 10286  
Facsimile: (212) 815-5875  
Attention: Insurance Trust and Escrow Unit

or to such other address or to such other Person as a Party may have last designated by notice to the other Parties.

Section 20. Headings. The headings of the Sections have been inserted for convenience of reference only and shall not be deemed to constitute a part of this Trust

Agreement.

Section 21. Counterparts. This Trust Agreement may be executed in any number of counterparts, each of which when so executed and delivered shall constitute an original, but such counterparts together shall constitute but one and the same Trust Agreement.

**IN WITNESS WHEREOF**, the parties hereto have caused this Trust Agreement to be executed and delivered by their respective officers thereunto duly authorized as of the date first above written.

UNION FIDELITY LIFE INSURANCE  
COMPANY, as Grantor

By: /s/ GLENN JOPPA  
Name: Glenn Joppa  
Title: Senior Vice President and Secretary

FIRST COLONY LIFE INSURANCE  
COMPANY, as Beneficiary

By: /s/ GARY T. PRIZZIA  
Name: Gary T. Prizzia  
Title: Treasurer

THE BANK OF NEW YORK, as Trustee

By: /s/ ROBERT W. RICH  
Name: Robert W. Rich  
Title: Vice President

**Exhibit A-1**

**CERTIFICATE**

The undersigned, the [insert position] and a duly authorized officer of First Colony Life Insurance Company, does hereby certify that, pursuant to Section 2 of the Trust Agreement dated as of [ ] entered into by and among First Colony Life Insurance Company, Union Fidelity Life Insurance Company and [ ] (the "Trust Agreement") and the Coinsurance Agreement dated as of [ ] between First Colony Life Insurance Company and Union Fidelity Life Insurance Company, First Colony Life Insurance Company is entitled to withdraw from the Trust Account established by Union Fidelity Life Insurance Company for the benefit of First Colony Life Insurance Company pursuant to the Trust Agreement, assets with a current statutory book value equal to \$[ ] for the purpose[s] specified in paragraph[s] [ ] and [ ] of Section [ ] of the Coinsurance Agreement.

**[Certification to specify the basis for the withdrawal.]**

This Certificate is a "Beneficiary Certificate" within the meaning of Section 2(a) of the Trust Agreement.

Dated: \_\_\_\_\_

\_\_\_\_\_  
Name:  
Title:

**Exhibit A-2**

**REQUEST FOR WITHDRAWAL**

First Colony Life Insurance Company ("FCL") hereby requests that [ ] immediately transfer to FCL [/or [ ]] all right, title and interest in those assets set forth on Schedule A attached hereto (which assets have a statutory book value equal to \$[ ]) from the Trust Account established by Union Fidelity Life Insurance Company ("UFLIC") for the benefit of FCL pursuant to the Trust Agreement dated as of [ , ] entered into by and among FCL, UFLIC and [ ] (the "Trust Agreement"). [Insert transfer instructions.]

This Request for Withdrawal is a "Beneficiary Request for Withdrawal" within the meaning of Section 2(a) of the Trust Agreement, and is made in conjunction with the attached Beneficiary Certificate.

FIRST COLONY LIFE INSURANCE  
COMPANY

Dated: \_\_\_\_\_

By: \_\_\_\_\_  
Name:  
Title:

**ELIGIBLE SECURITIES**

Assets of the types for which an Illinois-domiciled life insurance company could obtain full statutory reserve credit under statutory accounting practices prescribed or permitted by the Director of Insurance of the State of Illinois.

## COINSURANCE AGREEMENT

between

FIRST COLONY LIFE INSURANCE COMPANY

and

UNION FIDELITY LIFE INSURANCE COMPANY

Dated as of April 15, 2004

TABLE OF CONTENTS

<a href="#">ARTICLE I</a>	<a href="#">DEFINITIONS</a>
<a href="#">ARTICLE II</a>	<a href="#">COVERAGE</a>
<a href="#">ARTICLE III</a>	<a href="#">ADMINISTRATION; GENERAL PROVISIONS</a>
<a href="#">ARTICLE IV</a>	<a href="#">CLAIMS SETTLEMENT ACCOUNT; CLAIMS</a>
<a href="#">ARTICLE V</a>	<a href="#">REINSURANCE ASSET TRANSFER; CEDING COMMISSION</a>
<a href="#">ARTICLE VI</a>	<a href="#">EXPENSE ALLOWANCES</a>
<a href="#">ARTICLE VII</a>	<a href="#">ACCOUNTING AND SETTLEMENT</a>
<a href="#">ARTICLE VIII</a>	<a href="#">DURATION AND TERMINATION</a>
<a href="#">ARTICLE IX</a>	<a href="#">INSOLVENCY</a>
<a href="#">ARTICLE X</a>	<a href="#">CREDIT FOR REINSURANCE</a>
<a href="#">ARTICLE XI</a>	<a href="#">REINSURANCE SECURITY</a>
<a href="#">ARTICLE XII</a>	<a href="#">DEFERRED ACQUISITION COSTS</a>
<a href="#">ARTICLE XIII</a>	<a href="#">DISPUTE RESOLUTION</a>
<a href="#">ARTICLE XIV</a>	<a href="#">MISCELLANEOUS PROVISIONS</a>

SCHEDULES

<a href="#">SCHEDULE A</a>	— POLICY FORMS
<a href="#">SCHEDULE B</a>	— FORM OF ADMINISTRATIVE SERVICES AGREEMENT
<a href="#">SCHEDULE C</a>	— CEDING COMMISSION
<a href="#">SCHEDULE D</a>	— ASSETS
<a href="#">SCHEDULE E</a>	— EXPENSE ALLOWANCES
<a href="#">SCHEDULE F - PART I</a>	— INITIAL REPORT
<a href="#">SCHEDULE F - PART II</a>	— QUARTERLY REPORT
<a href="#">SCHEDULE F - PART III</a>	— ANNUAL REPORT
<a href="#">SCHEDULE G</a>	— FORM OF TRUST AGREEMENT
<a href="#">SCHEDULE H</a>	— ELIGIBLE SECURITIES

COINSURANCE AGREEMENT

This Coinsurance Agreement, dated as of April 15, 2004 (this "Agreement"), is made and entered into by and between First Colony Life Insurance Company, an insurance company organized under the laws of the Commonwealth of Virginia (the "Company"), and Union Fidelity Life Insurance Company, an insurance company organized under the laws of the State of Illinois (the "Reinsurer"). Defined terms used herein are defined below.

The Company and the Reinsurer mutually agree to reinsure the risks described in this Agreement under the terms and conditions stated herein. This Agreement is an indemnity coinsurance agreement solely between the Company and the Reinsurer, and the performance of the obligations of each party under this Agreement shall be rendered solely to the other party. In no instance shall anyone other than the Company or the Reinsurer have any rights under this Agreement. The Company shall be and shall remain the only party hereunder that is liable to any insured, contract holder, policyholder, claimant or beneficiary under any insurance policy or contract reinsured hereunder.

This Agreement is entered into in connection with an intercompany reorganization among the Company, the Reinsurer and certain of their Affiliates.

## ARTICLE I

DEFINITIONS

1.1. Definitions. As used in this Agreement, the following terms shall have the following meanings (definitions are applicable to both the singular and the plural forms of each term defined in this Article):

"Accounting Period" means calendar quarter, except that the last Accounting Period shall be the period commencing with the first day of the calendar quarter in which the Termination Date falls and ending with the Termination Date.

"Affiliate" means any other Person that directly or indirectly controls, is controlled by, or is under common control with, the first Person. "Control" (including

the terms, “controlled by” and “under common control with”) means the possession, directly or indirectly, of the power to direct or cause the direction of the management and policies of a Person, whether through the ownership of voting securities, by contract or credit arrangement, as trustee or executor, or otherwise.

“Agreement” shall have the meaning specified in the first paragraph of this Agreement.

“Annual Report” shall have the meaning specified in Section 7.4.

“Applicable Law” means any federal, state, local or foreign law (including common law), statute, ordinance, rule, regulation, order, writ, injunction, judgment, permit, governmental agreement or decree applicable to a Person or any of such Person’s subsidiaries,

---

properties, assets, or to such Person’s officers, directors, managing directors, employees or agents in their capacity as such.

“Assets” shall have the meaning specified in Section 5.3(a).

“Assignment Letter Agreement” means the letter agreement dated the date hereof among General Electric Capital Corporation, a Delaware corporation, the Reinsurer, the Company and certain affiliates of the Company relating to the assignment by General Electric Capital Corporation of the Capital Maintenance Agreement.

“Benefits” shall have the meaning specified in Section 2.3(a).

“Business Day” means any day other than a Saturday, Sunday or other day on which commercial banks in the States of Illinois or Virginia are required or authorized by law to be closed.

“Capital Maintenance Agreement” means the Capital Maintenance Agreement between General Electric Capital Corporation, a Delaware corporation, and the Reinsurer.

“Ceding Commission” shall have the meaning specified in Section 5.2.

“Claims Settlement Account” shall have the meaning specified in Section 4.1(a).

“Closing Date” means April 15, 2004.

“Code” means the Internal Revenue Code of 1986, as amended.

“Company Account” shall have the meaning specified in Section 11.1(e).

“CPR” shall have the meaning specified in Section 13.3.

“CPR Arbitration Rules” shall have the meaning specified in Section 13.4(a).

“Dispute” shall have the meaning specified in Section 13.1(a).

“Eligible Securities” shall have the meaning specified in Section 11.1(c).

“Expense Allowance” shall have the meaning specified in Section 6.1.

“Extra Contractual Liabilities” means all liabilities for damages (including compensatory, consequential, exemplary, punitive, bad faith or similar or other damages) which relate to the marketing, sale, underwriting, issuance, delivery, cancellation or administration of the Reinsured Contracts, including liability arising out of or relating to any alleged or actual acts, errors or omissions by the Company or its agents, whether intentional or otherwise, with respect to any of the Reinsured Contracts, including (A) any alleged or actual reckless conduct or bad faith in connection with the handling of any claim arising out of or under Reinsured Contracts, or (B) the marketing, sale, underwriting, issuance, delivery, cancellation or administration of any of the Reinsured Contracts.

“Force Majeure” shall have the meaning specified in Section 3.7(b)(iii).

“Funding Requirement” shall have the meaning specified in Section 11.1(e).

“GAAP” means U.S. generally accepted accounting principles consistently applied.

“Governmental Authority” means any foreign or national government, any state or other political subdivision thereof, and any entity exercising executive, legislative, judicial, regulatory or administrative functions of or pertaining to government.

“Inception Date” shall have the meaning specified in Section 2.1.

“Initial Notice” shall have the meaning specified in Section 13.2.

“Initial Reinsurance Premium” shall have the meaning specified in Section 5.1.

“Initial Report” shall have the meaning specified in Section 7.1.

“Insolvency Fund” means any guarantee fund, insolvency fund, plan, pool, association, fund or other arrangement, however denominated, established or governed, which provides for any assessment of or payment or assumption by the Company of part or all of any claim, debt, charge, fee or other obligation of an insurer or reinsurer, or its successors or assigns, which has been declared by any competent authority to be insolvent, or which is otherwise deemed unable to meet any claim, debt, charge,

fee or other obligation in whole or in part.

“Minimum Claims Settlement Amount” shall have the meaning specified in Section 4.1(b).

“Person” means any natural person, firm, limited liability company, general partnership, limited partnership, joint venture, association, corporation, trust, Governmental Authority or other entity.

“Quarterly Report” shall have the meaning specified in Section 7.2.

“Quarterly Settlement” shall have the meaning specified in Section 5.3(a).

“RBC Reporting Letter Agreement” means the letter agreement dated the date hereof among the Company, the Reinsurer and certain affiliates of the Company relating to the Reinsurer’s requirement to provide periodic certifications and reports regarding the Reinsurer’s risk based capital ratio.

“Reinsured Contracts” means the structured settlements immediate annuity contracts issued by the Company and recorded in the Company’s valuation system on or prior to December 3, 2003 or reinsured by the Company under reinsurance agreements in effect prior to January 1, 2004, and, in each case, written on the policy forms described in Schedule A.

“Reinsured Risks” shall have the meaning specified in Section 2.1.

3

---

“Response” shall have the meaning specified in Section 13.2.

“SAP” means statutory accounting practices prescribed or permitted by the Insurance Department of the Commonwealth of Virginia.

“Tax DAC” means specified policy acquisition expenses capitalized and amortized under section 848 of the Code.

“Termination Date” means the effective date of any termination of this Agreement as provided in Article VIII.

“Termination Letter Agreement” means the letter agreement dated the date hereof among the Company, the Reinsurer and certain affiliates of the Company relating to the rescission of this Agreement upon the failure of certain events to occur after the date hereof.

“Total SAP Ceded Reserves” means, as of any given date, the gross policy reserves of the Company calculated in accordance with SAP with respect to the Reinsured Risks.

“Total GAAP Ceded Reserves” means, as of any given date, the gross policy reserves of the Company calculated in accordance with GAAP with respect to the Reinsured Risks.

“Trust Account” shall have the meaning set forth in Section 11.1(a).

“Trust Agreement” shall have the meaning set forth in Section 11.1(a).

“Trustee” shall have the meaning set forth in Section 11.1(a).

## ARTICLE II

### COVERAGE

2.1. Coverage. Upon the terms and subject to the conditions and other provisions of this Agreement, as of 12:01 a.m. Eastern Time on January 1, 2004 (the “Inception Date”), the Company hereby cedes to the Reinsurer, and the Reinsurer hereby agrees to indemnify the Company for, one hundred percent (100%) of the liability incurred by the Company for Benefits on or after the Inception Date (the “Reinsured Risks”).

2.2. Conditions. (a) If the Company’s liability under any of the Reinsured Contracts is changed because of changes made on or after the Inception Date in the terms and conditions of the Reinsured Contracts (including to any contract riders or endorsements thereto) that are required due to changes in Applicable Law, the Reinsurer will share in the change proportionately to the coinsurance share hereunder and the Company and the Reinsurer will make all appropriate adjustments to amounts due each other under this Agreement.

(b) Except as otherwise set forth in paragraph (a) above, no changes, amendments or modifications made on or after the Inception Date in the terms and conditions of the

4

---

Reinsured Contracts which adversely affect the liability of the Reinsurer hereunder shall be covered hereunder without the prior written approval of such changes, amendments or modifications by the Reinsurer, which approval shall not be unreasonably withheld or delayed. In the event that any such changes, amendments or modifications are made in any Reinsured Contract without the prior written approval of the Reinsurer, this Agreement will cover liability incurred by the Company for Benefits as if the non-approved changes, amendments or modifications had not been made.

2.3. Benefits. (a) Subject to the provisions of Sections 2.2, 2.3(b) and (c) and the terms and conditions of this Agreement, “Benefits” shall mean the actual benefits payable by the Company under the Reinsured Contracts.

(b) Any Extra Contractual Liabilities resulting from actions of the Company or its agents or reinsured by the Company under the Reinsured Contracts shall be treated as a Benefit payable for the purposes of this Agreement to the extent permitted by state law, except to the extent that any such Extra Contractual Liabilities are attributable to the conduct of the Company in the administration of the Reinsured Contracts on or after the Inception Date, other than actions taken by the Company at the written request or



direction of the Reinsurer.

(c) This Agreement excludes all liability arising by contract, operation of law, or otherwise from the Company's participation or membership, whether voluntary or involuntary, in any Insolvency Fund.

2.4. Territory. The territorial limits of this Agreement shall be identical with those of the Reinsured Contracts.

2.5. Ceded Reinsurance. Subsequent to the Inception Date, the Company will not enter into any reinsurance arrangements with respect to the Reinsured Contracts without the prior written consent of the Reinsurer, in its sole discretion.

### ARTICLE III

#### ADMINISTRATION: GENERAL PROVISIONS

3.1. Contract Administration. (a) Subject to Section 3.7, the Company shall provide policyholder and claims servicing with respect to the Reinsured Contracts in accordance with the terms hereof. All Benefits paid by the Company shall be binding upon the Reinsurer; provided, however, that such Benefits are within the terms, conditions and limitations of the Reinsured Contracts. The Company shall provide policyholder and claims servicing with respect to the Reinsured Contracts (including the administration of claims for Benefits thereunder) in good faith and with the care, skill, prudence and diligence of a person experienced in administering structured settlement business. The Company shall provide policyholder and claims servicing with respect to the Reinsured Contracts, (i) in accordance with the terms of the Reinsured Contracts, (ii) in accordance with the applicable terms of this Agreement, (iii) in compliance with Applicable Law and, subject to the foregoing, (iv) in the same manner as it conducts its own business not subject to this Agreement and (v) in accordance with the Company's administrative performance standards in effect on the date hereof, with such revisions

5

---

to such standards as are no less favorable to the Reinsurer than such standards. Notwithstanding the foregoing, the parties may, from time to time, mutually develop specific and/or different standards for providing such services with respect to the Reinsured Contracts.

(b) The Company may subcontract for the performance of any policyholder or claims servicing service or services with respect to the Reinsured Contracts to (i) an Affiliate or (ii) any other Person with the prior written consent of the Reinsurer, such consent not to be unreasonably withheld; provided, that the Company also subcontracts for such service or services for its own structured settlement annuities business not subject to this Agreement to such subcontractor; and provided, further, that no such subcontracting shall relieve the Company from any of its obligations or liabilities hereunder, and the Company shall remain responsible for all obligations or liabilities of such subcontractor with regards to the providing of such service or services as if provided by the Company.

3.2. Claims Settlements. The Company agrees that it will provide prompt notice to the Reinsurer of its intention to contest, compromise or litigate a claim with respect to a Reinsured Contract, along with copies of all pleadings and reports of investigation with respect thereto. The Reinsurer shall have the right, at its own expense, to participate jointly with the Company in the investigation, adjustment or defense of such claims. In addition, in the event that litigation arises against the Company in connection with a claim which seeks damages in excess of \$1 million or other remedies deemed material to the Reinsurer, the Reinsurer may, upon written notice to the Company, assume the defense thereof with counsel selected by the Reinsurer and reasonably satisfactory to the Company. If the Reinsurer assumes such defense, the Company shall have the right, at its own expense, to participate jointly with the Reinsurer in the defense thereof. If the Reinsurer assumes the defense of litigation, the Reinsurer shall not settle such litigation without the Company's prior written consent (which consent shall not be unreasonably withheld or delayed) unless (i) there is no finding or admission of any violation of law or any violation of the rights of any Person, (ii) such settlement would not reasonably be expected to have material adverse precedential consequences to the Company and (iii) the sole relief provided is monetary damages that are paid in full by the Reinsurer.

3.3. Inspection. The Company shall keep accurate and complete records, files and accounts of all transactions and matters with respect to the Reinsured Contracts and the administration hereof in accordance with Applicable Law and its record management practices in effect from time to time for the Company's insurance business not covered by this Agreement. The Reinsurer and its designated representatives may upon reasonable notice inspect, at the offices of the Company where such records are located, the papers and any and all other books or documents of the Company reasonably relating to this Agreement, including the Reinsured Contracts and the administration thereof by the Company (including compliance with the provisions of Section 3.1), and shall have access to appropriate employees and representatives of the Company, in each case during normal business hours for such period as this Agreement is in effect or for as long thereafter as the Company seeks performance by the Reinsurer pursuant to the terms of this Agreement or the Reinsurer reasonably needs access to such records for regulatory, tax or similar purposes. The information obtained shall be used only for purposes relating to the transactions contemplated under this Agreement.

6

---

3.4. Errors and Omissions. If any delay, omission, error or failure to pay amounts due or to perform any other act required by this Agreement is unintentional and caused by misunderstanding or oversight, the Company and the Reinsurer will adjust the situation to what it would have been had the misunderstanding or oversight not occurred. The party first discovering such misunderstanding or oversight, or an act resulting from such misunderstanding or oversight, will notify the other party in writing promptly upon discovery thereof, and the parties shall act to correct such misunderstanding or oversight within twenty (20) Business Days of such other party's receipt of such notice. However, this Section shall not be construed as a waiver by either party of its right to enforce strictly the terms of this Agreement.

3.5. Age, Sex and Other Adjustments. If the Company's liability under any of the Reinsured Contracts is changed because of a misstatement of age or sex or any other material fact, the Reinsurer will share in the change proportionately to the coinsurance share hereunder and the Company and the Reinsurer will make all appropriate adjustments to amounts due each other under this Agreement.

3.6. Setoff. Any debts or credits, matured or unmatured, in favor of or against either the Company or the Reinsurer with respect to this Agreement or any other reinsurance agreement between the Company and the Reinsurer, are deemed mutual debts or credits, as the case may be, and shall be setoff from any amounts due to the Company or the Reinsurer hereunder, as the case may be, and only the net balance shall be allowed or paid.

3.7. Administration by Reinsurer. (a) At any time from and after the fifteenth (15th) anniversary of the Inception Date, the Reinsurer shall have the right to assume from the Company the administration of the Reinsured Contracts, provided that the Reinsurer provides twelve (12) months prior written notice of such assumption, which notice may be given as early as the fourteenth (14th) anniversary of the Inception Date to take effect as of the fifteenth (15th) anniversary of the Inception Date. The Reinsurer shall bear all transition costs associated with an assumption of the administration of the Reinsured Contracts pursuant to this paragraph (a) of this Section 3.7.

(b) In addition to the provisions of Section 3.7(a), the Reinsurer shall have the right, upon written notice to the Company to assume from the Company the

administration of the Reinsured Contracts upon the occurrence of any of the following events:

- (i) A voluntary or involuntary proceeding is commenced in any jurisdiction by or against the Company for the purpose of conserving, rehabilitating or liquidating the Company;
- (ii) There is a material breach by the Company of any material term or condition of this Article III that is not cured by the Company within thirty (30) days after receipt of written notice from the Reinsurer of such breach or act (provided that the Reinsurer shall not have the right to assume such administration (A) for so long as the Company is making a good faith effort to cure such a breach, not to exceed an additional one hundred eighty (180) days or (B) during the pendency of any dispute resolution

7

---

proceedings as set forth in Article XIII regarding an alleged material breach); or

- (iii) The Company is unable to perform the services required under this Article III for a period of thirty (30) consecutive days for any reason, other than as a result of a Force Majeure, it being understood that nothing in this Section 3.7(b)(iii) shall relieve the Company from its administrative responsibilities under this Agreement. For purposes of this Agreement "Force Majeure" means any acts or omissions of any civil or military authority, acts of God, acts or omissions of the Reinsurer, fires, strikes or other labor disturbances, equipment failures, fluctuations or non-availability of electrical power, heat, light, air conditioning or telecommunications equipment, or any other act, omission or occurrence beyond the Company's reasonable control, irrespective of whether similar to the foregoing enumerated acts, omissions or occurrences.

(c) The Company shall bear all transition costs associated with an assumption of the administration of the Reinsured Contracts pursuant to Section 3.7(b).

(d) In the event of the Reinsurer's assumption of the administration of the Reinsured Contracts, the Reinsurer and the Company shall enter into an administrative services agreement in the form attached hereto as Schedule B and the provisions of Article VI and Article VII shall become inoperative.

#### ARTICLE IV

##### CLAIMS SETTLEMENT ACCOUNT; CLAIMS

4.1. Claims Settlement Account. (a) On the Closing Date, the Reinsurer shall establish a separate bank account (the "Claims Settlement Account") in its own name for the payment of Benefits and shall authorize two signatories who shall be representatives of the Company and approved by the Reinsurer in writing to issue drafts in the name of the Reinsurer and showing the identity of the Company. The Reinsurer shall fund such account for payment of Benefits in accordance with the provisions of Section 4.1(b). Any interest earned on the Claims Settlement Account shall belong to the Reinsurer. The Claims Settlement Account shall be administered by the Company in a fiduciary capacity and shall be used solely by the Company to make payments of Benefits in accordance with the terms of this Agreement.

(b) The Reinsurer shall deposit \$47 million in the Claims Settlement Account on the Closing Date and shall thereafter fund the Claims Settlement Account on or before the fifth (5th) day of each month in amounts agreed by the Company and the Reinsurer from time to time in amounts sufficient to provide funds to the Company for the payment of Benefits during the next thirty (30) days, or such other amount as may be mutually agreed by the parties (such initial deposit amount and each minimum funding amount as agreed from time to time shall be referred to as a "Minimum Claims Settlement Amount"). In addition, the Reinsurer shall deposit to the Claims Settlement Account such additional amounts as may be required to keep

8

---

the balance of such account above zero at all times. In consideration of the Reinsurer providing the Claims Settlement Account arrangement, the Company agrees that it shall apply funds in the Claims Settlement Account against the Reinsurer's liability under this Agreement until such funds are exhausted.

(c) The Company shall keep true and complete records, in accordance with Applicable Law and its record management practices in effect from time to time for the Company's insurance business not covered by this Agreement, clearly recording the deposits in and withdrawals from the Claims Settlement Account, including records relating to the payment of Benefits from the Claim Settlement Account. The Company will make available to the Reinsurer or its designated representative, or shall furnish to the Reinsurer or its designated representative, upon request of the Reinsurer or its designated representative, copies of all such records. All copies furnished in the ordinary course of business shall be furnished by the Company at the Company's cost, which shall be included in the Expense Allowance. Any extraordinary costs reasonably incurred by the Company in response to requests from the Reinsurer shall be reimbursed by the Reinsurer.

(d) Within thirty (30) days after each calendar month (or more frequently as mutually agreed by the parties), the Company shall render a complete accounting to the Reinsurer detailing all transactions with respect to the Claims Settlement Account, in such form as agreed by the parties.

(e) The parties agree to deliver to the depository bank such depository resolutions, signature cards and other documents as may be requested of them in order to use such accounts at the depository bank in accordance with the provisions of this Article IV.

(f) Upon a termination of this Agreement pursuant to Article VIII, the Reinsurer shall close the Claims Settlement Account and any closing balance therein shall be the property of the Reinsurer. The Company's claims payment authority under this Agreement with respect to the Claims Settlement Account shall terminate immediately upon termination of this Agreement pursuant to Article VIII or the assumption by the Reinsurer of the administration of the Reinsured Contracts pursuant to Section 3.7. Upon termination of its authority to pay claims, the Company shall promptly return to the Reinsurer all unused check stock held by it in connection with this Agreement.

#### ARTICLE V

##### REINSURANCE ASSET TRANSFER; CEDING COMMISSION

5.1. Initial Reinsurance Premium. As consideration for the reinsurance by the Reinsurer of the Reinsured Risks under this Agreement, on the Closing Date the Reinsurer shall be entitled to an amount equal to one hundred percent (100%) of the Total SAP Ceded Reserves as of the close of business on the day immediately preceding the Inception Date (the "Initial Reinsurance Premium").

5.2. Ceding Commission. On the Closing Date, the Company shall be entitled to a ceding commission (the "Ceding Commission") in an amount determined in accordance with Schedule C.

5.3. Amounts Due the Parties. (a) Except as otherwise specifically provided herein, all amounts due to be paid to the Company under this Agreement shall be determined on a net basis, giving full effect to Section 3.6. The net amount due the Reinsurer from the Company on the Closing Date under Section 5.1 and Section 5.2 shall consist of (i) the investment assets (the "Assets") set forth on Schedule D, which assets have a statutory book value as of the close of business on the day immediately preceding the Inception Date equal to (A) the Initial Reinsurance Premium, less (B) the Ceding Commission, less (C) an amount equal to accrued but unpaid interest on the Assets as of the close of business on the day immediately preceding the Inception Date, plus (ii) an amount equal to the investment cash flows received on the Assets between the Inception Date and the Closing Date. The Company shall pay such net amount concurrent with its delivery of the Initial Report. Each net amount subsequently due with respect to each Accounting Period ending after the Inception Date (the "Quarterly Settlement") shall be paid in cash by the Reinsurer to the Company no later than thirty (30) days after delivery of the Quarterly Report, as applicable. Each net amount subsequently due with respect to each calendar year ending after the Inception Date as reflected on an Annual Report shall be paid in cash by the Reinsurer to the Company no later than thirty (30) days after delivery of the Annual Report.

(b) The Company shall deliver to the Reinsurer possession of the Assets and such bills of sale, endorsements, assignments and other good and sufficient instruments of conveyance and transfer in form and substance reasonably acceptable to the parties as shall be effective to vest in the Reinsurer all of the right, title and interest of the Company in and to the Assets. Delivery of the Assets shall be a condition precedent of reinsurance coverage hereunder.

## ARTICLE VI

### EXPENSE ALLOWANCES

6.1. Expense Allowance. As reimbursement for expenses incurred by the Company in the providing of policyholder and Benefit payment services with respect to the Reinsured Contracts, the Reinsurer shall pay to the Company with respect to each calendar month ending after the Inception Date, an expense allowance (each an "Expense Allowance") in an amount calculated in accordance with Schedule E, as subsequently adjusted in accordance with the methodology and procedures set forth on Schedule E.

## ARTICLE VII

### ACCOUNTING AND SETTLEMENT

7.1. Initial Report. A report shall be provided by the Company to the Reinsurer on the Closing Date providing the data required in Schedule F - Part I (the "Initial Report").

7.2. Quarterly Settlement Reports. As soon as practicable but not more than forty (40) days following each Accounting Period ending after the Closing Date (or more frequently as mutually agreed by the parties), the Company shall supply the Reinsurer with a report that shall provide the financial data for such Accounting Period required in Schedule F - Part II (the "Quarterly Report"). For the avoidance of doubt, the first Quarterly Report will include all transactions with respect to the Reinsured Contracts occurring from the Inception Date through June 30, 2004.

7.3. Quarterly Financial Reports. As soon as practicable but not more than forty (40) days following the end of each Accounting Period ending after the Closing Date (or more frequently as mutually agreed by the parties), the Company shall supply the Reinsurer with reports related to the Reinsured Contracts as may be reasonably requested for use in connection with the preparation of the Reinsurer's SAP financial statements or other reports prepared by the Reinsurer in compliance with its internal reporting requirements. The parties shall cooperate in good faith to establish the form for the providing of such reports.

7.4. Annual Reports. Within forty-five (45) days after the end of each calendar year during the term of this Agreement (or more frequently as mutually agreed by the parties), the Company shall supply the Reinsurer with a report that shall provide the financial data for such year required in Schedule F - Part III (the "Annual Report").

7.5. Additional Reports and Updates. For so long as this Agreement remains in effect, each of the parties shall periodically furnish to the other such other reports and information as may be reasonably requested by such other party for regulatory, tax or similar purposes and reasonably available to it.

7.6. Delayed Payments. In the event that all or any portion of any payment due either party pursuant to this Agreement becomes overdue, the portion of the amount overdue shall bear interest at an annual rate equal to the then current thirty (30) day U.S. Treasury Bill discount rate on the date that the payment becomes overdue plus 200 basis points, for the period that the amount is overdue.

## ARTICLE VIII

### DURATION AND TERMINATION

8.1. Duration. Except as otherwise provided herein, this Agreement shall be unlimited in duration.

8.2. Reinsurer's Liability. The Reinsurer's liability with respect to the Reinsured Risks will terminate on the earliest of: (i) the date the Company's liability with respect to the Reinsured Risks is terminated and all amounts due the Company from the Reinsurer with respect to such Reinsured Risks are paid to the Company by or on behalf of the Reinsurer; and (ii) the date this Agreement is terminated upon the written agreement of the parties.

8.3. Notice of Termination. Upon the termination of the Reinsurer's liability with respect to the Reinsured Risks referred to in Section 8.2 above, the parties shall mutually give the Trustee written notice of their intention to terminate the Trust Account.

## ARTICLE IX

### INSOLVENCY

9.1. Payments. In the event of the insolvency of the Company, the reinsurance payable by the Reinsurer hereunder shall be payable directly to the Company or to its domiciliary liquidator or receiver on the basis of the liability of the Reinsurer under the contract or contracts reinsured, without diminution because of the insolvency of the Company. It is agreed and understood, however, that (i) in the event of the insolvency of the Company, the Reinsurer shall be given written notice of the pendency of a claim against the insolvent Company on a Reinsured Contract within a reasonable time after such claim is filed in the insolvency proceeding and (ii) during the pendency of such claim the Reinsurer may investigate such claim and interpose, at its own expense, in the proceeding where such claim is to be adjudicated any defenses which it may deem available to the Company or its domiciliary liquidator, receiver or statutory successor.

9.2. Expenses. It is further understood that any expense thus incurred by the Reinsurer pursuant to Section 9.1 shall be chargeable, subject to court approval, against the insolvent Company as part of the expense of liquidation to the extent of a proportionate share of the benefit which may accrue to the Company solely as a result of the defense undertaken by the Reinsurer. Where two or more assuming reinsurers are involved in the same claim and a majority in interest elect to interpose defenses to such claim, the expense shall be apportioned in accordance with the terms of this Agreement as though such expense had been incurred by the Company.

## ARTICLE X

### CREDIT FOR REINSURANCE

10.1. Reinsurance Credit. Notwithstanding any other provision of this Agreement to the contrary, if the Reinsurer becomes unauthorized or otherwise unaccredited as an insurer or reinsurer in any U.S. jurisdiction to which the Company must provide statutory statements of financial condition such that the Company will not obtain full statutory financial statement credit for reinsurance in such state for the reinsurance provided under this Agreement, the Reinsurer, upon the request of the Company, will establish, at the Reinsurer's sole cost and

12

---

option, trust accounts for the benefit of the Company, letters of credit, or other acceptable alternatives necessary to permit the Company to obtain such full statutory financial statement credit for such reinsurance in all applicable jurisdictions. The Company shall cooperate with the Reinsurer to take such steps. In addition, in such event, the Reinsurer agrees to amend this Agreement and the Trust Agreement to the extent required under Applicable Law in order to provide the Company with such full statutory financial statement credit.

## ARTICLE XI

### REINSURANCE SECURITY

11.1. Trust. (a) On the Closing Date, the Reinsurer shall enter into a trust agreement in the form attached as Schedule G (the "Trust Agreement") and establish a trust account (the "Trust Account") for the benefit of the Company with respect to the Reinsured Risks with a bank (the "Trustee") designated as a Qualified United States Financial Institution by the Securities Valuation Office of the National Association of Insurance Commissioners or any successor organization or regulatory agency having similar duties.

(b) The Reinsurer agrees to deposit, and maintain in the Trust Account with respect to this Agreement, assets to be held in trust by the Trustee for the benefit of the Company as security for the payment of the Reinsurer's obligations to the Company under this Agreement.

(c) The parties agree that the assets so deposited with respect to this Agreement shall be valued according to their current statutory book value on the books of the Reinsurer and shall consist only of cash (United States legal tender), certificates of deposit (issued by a United States bank and payable in United States legal tender), and other assets of the type specified on Schedule H attached hereto ("Eligible Securities").

(d) The Reinsurer, prior to depositing assets with the Trustee, shall execute all assignments and endorsements in blank, or transfer legal title to the Trustee of all shares, obligations or any other assets requiring assignments, in order that, to the extent practicable, the Company, or the Trustee upon direction of the Company, may whenever necessary negotiate any such assets without consent or signature from the Reinsurer or any other entity. The Company recognizes that certain assets in the Trust Account will not be readily negotiable and that certain notices, opinions of counsel, representations and/or consents will be required for the Company to obtain good and marketable title to such assets.

(e) The Reinsurer and the Company agree that the assets in the Trust Account with respect to this Agreement may be withdrawn for the following purposes only:

- (i) to pay or reimburse the Company for any amount due the Company pursuant to this Agreement to the extent not so paid or reimbursed by the Reinsurer;
- (ii) to pay to the Reinsurer, in accordance with paragraph (h) below, any amounts held in the Trust Account that exceed an amount (the "Funding

13

---

Requirement") equal to the sum of Total SAP Ceded Reserves and any additional reserves attributable to the Reinsured Risks that arise as a result of

regulatory asset adequacy analysis requirements of the Reinsurer, less, prior to the date on which the Claims Settlement Account is closed, the Minimum Claims Settlement Amount then in effect; and

- (iii) in the event that General Electric Capital Corporation breaches its obligations under the Capital Maintenance Agreement, to fund an account with the Company (the "Company Account") in an amount at least equal to the deduction, for reinsurance ceded, from the Company's liabilities ceded under this Agreement. Such amount shall include, but not be limited to, amounts for policy reserves, reserves for claims and losses incurred (including losses incurred but not reported), loss and loss adjustment expenses, and unearned premiums.

(f) In the event that the Company withdraws assets from the Trust Account for the purposes set forth in Section 11.1(e)(i) above in excess of actual amounts required to meet the Reinsurer's obligations to the Company, the Company will promptly return such excess to the Reinsurer, plus interest at an annual rate equal to the then current thirty (30) day U.S. Treasury Bill discount rate on the date of withdrawal plus 200 basis points for the period during which the amounts were held pursuant to Section 11.1(e)(i). In the event that the Company withdraws assets from the Trust Account for the purposes set forth in Section 11.1(e)(iii) above, (i) the Reinsurer shall be relieved of its obligation to maintain assets in the Trust Account pursuant to this Section 11.1 to the extent of the amount of funds held in the Company Account and (ii) the Company shall first apply the funds in the Company Account in satisfaction of the Reinsurer's liability under this Agreement until the funds in the Company Account are exhausted. In the event that the Company withdraws assets from the Trust Account for the purposes set forth in Section 11.1(e)(iii) above, promptly following the date the Reinsurer's liability with respect to the Reinsured Risks is terminated, the Company shall return to the Reinsurer any assets so withdrawn that, together with any and all interest, dividends and other earnings thereon from the date of withdrawal to the date of return, are in excess of actual amounts required to meet the Reinsurer's obligations to the Company under this Agreement.

(g) The initial deposit to the Trust Account with respect to this Agreement shall be made on the Closing Date and shall consist of assets with a statutory book value equal to the Total SAP Ceded Reserves as of the close of business on the day immediately preceding the Inception Date, less an amount of assets with a statutory book value equal to the initial Minimum Claims Settlement Amount.

(h) The aggregate statutory book value of the assets held in the Trust Account with respect to this Agreement, shall at all times be at least equal to the Funding Requirement, and shall be adjusted on a quarterly basis so as to equal the Funding Requirement. On a quarterly basis, the Company shall promptly prepare and deliver to the Reinsurer a specific statement of the Funding Requirement and the Reinsurer shall promptly prepare and deliver to the Company a specific statement of the statutory book value of the assets in the Trust Account, in each case as of the end of the quarter. If the statement shows that the Funding Requirement exceeds 100% of the balance of the Trust Account with respect to this Agreement as of the

statement date, the Reinsurer shall, within ten (10) Business Days after receipt of such notice of excess, secure delivery to the Trustee of additional cash or Eligible Securities having a current statutory book value equal to such difference. If the statement shows that the Funding Requirement is less than 100% of the balance of the Trust Account with respect to this Agreement as of the statement date, the Company shall, within ten (10) Business Days after delivery of such statement to the Reinsurer, deliver a notice of withdrawal to the Trustee directing the Trustee to withdraw from the Trust Account and deliver to the Reinsurer assets from the Trust Account having a current statutory book value equal to such excess amount. In addition to the foregoing, the Reinsurer shall prepare and deliver to the Company on a quarterly basis a specific statement of the market value of the assets in the Trust Account as of the end of the quarter.

## ARTICLE XII

### DEFERRED ACQUISITION COSTS

12.1. Tax DAC Information Sharing. To ensure consistency in their respective Tax DAC calculations for tax purposes, the Company and the Reinsurer will exchange information pertaining to the amount of net consideration under this Agreement each year. The Company will submit a schedule to the Reinsurer by February 28 of each year presenting its calculation of the net consideration for the preceding taxable year. The Reinsurer may contest the calculation by providing to the Company an alternative calculation in writing within thirty (30) days of receipt of the Company's schedule. The Company and the Reinsurer will act in good faith to resolve any differences in the schedule of calculations within thirty (30) days of receipt of the alternative calculation to ensure consistent amounts are reported on the respective tax returns for the preceding tax year.

## ARTICLE XIII

### DISPUTE RESOLUTION

13.1. General Provisions. (a) Any dispute, controversy or claim arising out of or relating to this Agreement or the validity, interpretation, breach or termination thereof (a "Dispute"), shall be resolved in accordance with the procedures set forth in this Article XIII, which shall be the sole and exclusive procedures for the resolution of any such Dispute unless otherwise specified below.

(b) Commencing with the request contemplated by Section 13.2, all communications between the parties or their representatives in connection with the attempted resolution of any Dispute, including any mediator's evaluation referred to in Section 13.3, shall be deemed to have been delivered in furtherance of a Dispute settlement and shall be exempt from discovery and production, and shall not be admissible in evidence for any reason (whether as an admission or otherwise), in any arbitral or other proceeding for the resolution of the Dispute.

(c) In connection with any Dispute, the parties expressly waive and forego any right to (i) punitive, exemplary, statutorily-enhanced or similar damages in excess of compensatory damages, and (ii) trial by jury.

(d) The specific procedures set forth below, including but not limited to the time limits referenced therein, may be modified by agreement of the parties in writing.

(e) All applicable statutes of limitations and defenses based upon the passage of time shall be tolled while the procedures specified in this Article XIII are pending. The parties will take such action, if any, required to effectuate such tolling.

13.2. Consideration by Senior Executives. If a Dispute is not resolved in the normal course of business at the operational level, the parties shall attempt in good faith to resolve such Dispute by negotiation between executives who hold, at a minimum, the office of President and CEO of the respective business entities involved in such Dispute. Either party may initiate the executive negotiation process by providing a written notice to the other (the "Initial Notice"). Fifteen (15) days after delivery of the Initial Notice, the receiving party shall submit to the other a written response (the "Response"). The Initial Notice and the Response shall include (i) a statement of the Dispute and of each party's position, and (ii) the name and title of the executive who will represent that party and of any other person who will accompany the executive. Such executives will meet in person or by telephone within thirty (30) days of the date of the Initial Notice to seek a resolution of the Dispute.

13.3. Mediation. If a Dispute is not resolved by negotiation as provided in Section 13.2 within forty-five (45) days from the delivery of the Initial Notice, then either party may submit the Dispute for resolution by mediation pursuant to the CPR Institute for Dispute Resolution (the "CPR") Model Mediation Procedure as then in effect. The parties will select a mediator from the CPR Panels of Distinguished Neutrals, but such mediator must have prior U.S. reinsurance experience either as a lawyer or as a present or former officer or management employee of a reinsurance company, but not of the Company, or the Reinsurer, or any of their respective affiliates. Either party at commencement of the mediation may ask the mediator to provide an evaluation of the Dispute and the parties' relative positions.

13.4. Arbitration. (a) If a Dispute is not resolved by mediation as provided in Section 13.3 within thirty (30) days of the selection of a mediator (unless the mediator chooses to withdraw sooner), either party may submit the Dispute to be finally resolved by arbitration pursuant to the CPR Rules for Non-Administered Arbitration as then in effect (the "CPR Arbitration Rules"). The parties consent to a single, consolidated arbitration for all known Disputes existing at the time of the arbitration and for which arbitration is permitted.

(b) The neutral organization for purposes of the CPR Arbitration Rules will be the CPR. The arbitral tribunal shall be composed of three arbitrators who are each experienced in the U.S. reinsurance business, of whom each party shall appoint one in accordance with the "screened" appointment procedure provided in Rule 5.4 of the CPR Arbitration Rules. The non-party appointed arbitrator must have prior U.S. reinsurance experience as a present or former officer or management employee of a reinsurance company, but not of the Company, or the Reinsurer, or any of their respective affiliates. The arbitration shall be conducted in New York

16

---

City. Each party shall be permitted to present its case, witnesses and evidence, if any, in the presence of the other party. A written transcript of the proceedings shall be made and furnished to the parties. The arbitrators shall determine the Dispute in accordance with the law of Virginia, without giving effect to any conflict of law rules or other rules that might render such law inapplicable or unavailable, and shall apply this Agreement according to its terms, provided that the provisions relating to arbitration shall be governed by the Federal Arbitration Act, 9 U.S.C. §§ 1 et seq. The arbitral tribunal shall endeavor to render its award or order resulting from any arbitration within forty-five (45) days following the termination of the arbitration proceedings.

(c) The parties agree to be bound by any award or order resulting from any arbitration conducted hereunder and further agree that judgment on any award or order resulting from an arbitration conducted under this Section may be entered and enforced in any court having jurisdiction thereof.

(d) Except as expressly permitted by this Agreement, no party will commence or voluntarily participate in any court action or proceeding concerning a Dispute, except (i) for enforcement as contemplated by Section 13.4(c) above, (ii) to restrict or vacate an arbitral decision based on the grounds specified under applicable law, or (iii) for interim relief as provided in paragraph (e) below. For purposes of the foregoing the parties hereto submit to the non-exclusive jurisdiction of the courts of the State of New York.

(e) In addition to the authority otherwise conferred on the arbitral tribunal, the tribunal shall have the authority to make such orders for interim relief, including injunctive relief, as it may deem just and equitable. Notwithstanding paragraph (d) above, each party acknowledges that in the event of any actual or threatened breach of certain of the provisions of this Agreement, the remedy at law would not be adequate, and therefore injunctive or other interim relief may be sought immediately to restrain such breach. If the tribunal shall not have been appointed, either party may seek interim relief from a court having jurisdiction if the award to which the applicant may be entitled may be rendered ineffectual without such interim relief. Upon appointment of the tribunal following any grant of interim relief by a court, the tribunal may affirm or disaffirm such relief, and the parties will seek modification or rescission of the court action as necessary to accord with the tribunal's decision.

(f) Each party will bear its own attorneys' fees and costs incurred in connection with the resolution of any Dispute in accordance with this Article XIII.

#### ARTICLE XIV

##### MISCELLANEOUS PROVISIONS

14.1. Headings and Schedules. Headings used herein are not a part of this Agreement and shall not affect the terms hereof. The attached Schedules are a part of this Agreement.

14.2. Notices. All notices, requests, demands and other communications under this Agreement must be in writing and will be deemed to have been duly given or made as

17

---

follows: (a) if sent by registered or certified mail in the United States return receipt requested, upon receipt; (b) if sent by reputable overnight air courier, two business days after mailing; (c) if sent by facsimile transmission, with a copy mailed on the same day in the manner provided in (a) or (b) above, when transmitted and receipt is confirmed by telephone; or (d) if otherwise actually personally delivered, when delivered, and shall be delivered as follows:

If to the Company:

First Colony Life Insurance Company  
700 Main Street  
Lynchburg, VA 24504  
Facsimile: (434) 948-5064  
Attention: Chief Executive Officer

With a copy to:

First Colony Life Insurance Company  
700 Main Street  
Lynchburg, VA 24504  
Facsimile: (434) 948-5819  
Attention: General Counsel

If to the Reinsurer:

Union Fidelity Life Insurance Company  
200 North Martingale Road  
Schaumburg, IL 60173-2096  
Facsimile: (847) 330-3404  
Attention: Chief Financial Officer

With a copy to:

Union Fidelity Life Insurance Company  
200 North Martingale Road  
Schaumburg, IL 60173-2096  
Facsimile: (847) 605-3044  
Attention: General Counsel

or to such other address or to such other Person as either party may have last designated by notice to the other party.

14.3. Successors and Assigns. This Agreement shall be binding upon and inure to the benefit of the parties hereto and their respective successors, permitted assigns and legal representatives. Neither this Agreement, nor any right or obligation hereunder, may be assigned by any party without the prior written consent of the other party hereto. Any assignment in violation of this Section 14.3 shall be void and shall have no force and effect. Nothing in this

18

---

Section 14.3 shall be construed to prohibit the Reinsurer from retroceding all or any portion of the business reinsured hereunder.

14.4. Execution in Counterpart. This Agreement may be executed by the parties hereto in any number of counterparts, and by each of the parties hereto in separate counterparts, each of which counterparts, when so executed and delivered, shall be deemed to be an original, but all such counterparts shall together constitute but one and the same instrument.

14.5. Currency. Whenever the word "Dollars" or the "\$" sign appear in this Agreement, they shall be construed to mean United States Dollars, and all transactions under this Agreement shall be in United States Dollars.

14.6. Amendments. This Agreement may not be changed, altered or modified unless the same shall be in writing executed by the Company and the Reinsurer.

14.7. Governing Law. This Agreement will be construed, performed and enforced in accordance with the laws of the Commonwealth of Virginia without giving effect to its principles or rules of conflict of laws thereof to the extent such principles or rules would require or permit the application of the laws of another jurisdiction.

14.8. Entire Agreement; Severability. (a) This Agreement and the Termination Letter Agreement constitute the entire agreement between the parties hereto relating to the subject matter hereof and supersede all prior and contemporaneous agreements, understandings, statements, representations and warranties, negotiations and discussions, whether oral or written, of the parties and there are no general or specific warranties, representations or other agreements by or among the parties in connection with the entering into of this Agreement or the subject matter hereof except as specifically set forth or contemplated herein or in the Termination Letter Agreement.

(b) If any provision of this Agreement is held to be void or unenforceable, in whole or in part, (i) such holding shall not affect the validity and enforceability of the remainder of this Agreement, including any other provision, paragraph or subparagraph, and (ii) the parties agree to attempt in good faith to reform such void or unenforceable provision to the extent necessary to render such provision enforceable and to carry out its original intent.

14.9. Contemporaneous Agreements. Concurrent with the execution of this Agreement, the parties and/or their Affiliates are also entering into the Capital Maintenance Agreement, the RBC Reporting Letter Agreement and the Assignment Letter Agreement.

14.10. No Waiver; Preservation of Remedies. No consent or waiver, express or implied, by any party to or of any breach or default by any other party in the performance by such other party of its obligations hereunder shall be deemed or construed to be a consent or waiver to or of any other breach or default in the performance of obligations hereunder by such other party hereunder. Failure on the part of any party to complain of any act or failure to act of any other party or to declare any other party in default, irrespective of how long such failure continues, shall not constitute a waiver by such first party of any of its rights hereunder. The rights and remedies provided are cumulative and are not exclusive of any rights or remedies that any party may otherwise have at law or equity.

19

---

14.11. Cooperation. Each party hereto shall cooperate fully with the other in all reasonable respects in order to accomplish the objectives of this Agreement including making available to each their respective officers and employees for interviews and meetings with Governmental Authorities and furnishing any additional assistance, information and documents as may be reasonably requested by a party from time to time.

14.12. Third Party Beneficiary. Nothing in this Agreement will confer any rights upon any Person that is not a party or a successor or permitted assignee of

a party to this Agreement.

14.13. Tax Exception to Any Confidentiality. Notwithstanding anything to the contrary set forth herein or in any other agreement to which the parties hereto are parties or by which they are bound, any obligations of confidentiality contained herein and therein, as they relate to the transactions, shall not apply to the federal tax structure or federal tax treatment of the transactions, and each party hereto (and any employee, representative, or agent of any party hereto) may disclose to any and all persons, without limitation of any kind, the federal tax structure and federal tax treatment of the transactions. The preceding sentence is intended to cause the transactions to be treated as not having been offered under conditions of confidentiality for purposes of Section 1.6011-4(b)(3) (or any successor provision) of the Treasury Regulations promulgated under Section 6011 of the Internal Revenue Code of 1986, as amended, and shall be construed in a manner consistent with such purpose. In addition, each party hereto acknowledges that it has no proprietary or exclusive rights to the federal tax structure of the transactions or any federal tax matter or federal tax idea related to the transactions.

14.14. Interpretation. Wherever the words “include,” “includes” or “including” are used in this Agreement, they shall be deemed to be followed by the words “without limitation.”

14.15. Survival. Article XIII and Article XIV shall survive the termination of this Agreement.



IN WITNESS WHEREOF, the parties hereto have caused this Agreement to be executed by their duly authorized representatives.

FIRST COLONY LIFE INSURANCE COMPANY

By /s/ WARD BOBITZ  
Name: Ward Bobitz  
Title: Vice President

UNION FIDELITY LIFE INSURANCE COMPANY

By /s/ GLENN JOPPA  
Name: Glenn Joppa  
Title: Senior Vice President and Secretary

SCHEDULE A

POLICY FORMS

8001

8101

8201

8401

1700

ANN-PPR

ANN-PPR-Q

FCL RA&Q

---

FORM OF ADMINISTRATIVE SERVICES AGREEMENT

---

SSA UFLIC/FCL

---

ADMINISTRATIVE SERVICES AGREEMENT

by and between

FIRST COLONY LIFE INSURANCE COMPANY

and

UNION FIDELITY LIFE INSURANCE COMPANY

Effective as of [       ]

---

---

**ADMINISTRATIVE SERVICES AGREEMENT**

This ADMINISTRATIVE SERVICES AGREEMENT (this "Agreement"), effective as of [       ] (the "Effective Date"), is entered into by and between FIRST COLONY LIFE INSURANCE COMPANY, an insurance company organized under the laws of the Commonwealth of Virginia (the "Company"), and UNION FIDELITY LIFE INSURANCE COMPANY, an insurance company organized under the laws of the State of Illinois (the "Administrator").

**RECITALS:**

WHEREAS, the Company and the Administrator have entered into a Coinsurance Agreement dated as of April 15, 2004 (the "Coinsurance Agreement") which provides for the parties to enter into this Agreement;

WHEREAS, pursuant to the Coinsurance Agreement, the Administrator has agreed to indemnify the Company for, among other things, 100% of the liability of the Company for Benefits payable on or after the Inception Date with respect to the Reinsured Contracts (capitalized terms used herein and not defined herein, unless otherwise indicated, have the respective meanings assigned to them in the Coinsurance Agreement); and

WHEREAS, the Company wishes to appoint the Administrator to provide policyholder and claim servicing with respect to the Reinsured Contracts, and the Administrator desires to provide such administrative services;

NOW, THEREFORE, in consideration of the covenants and agreements set forth herein, the parties hereto agree as follows:

ARTICLE I

AUTHORITY

The Company hereby appoints the Administrator, and the Administrator hereby accepts appointment, to provide as an independent contractor of the Company, from and after the Effective Date, all of the policyholder and claim servicing services necessary or appropriate with respect to the Reinsured Contracts including those set forth in this Agreement (the "Administrative Services"), all on the terms as set forth in this Agreement. Notwithstanding any other provision of this Agreement to the contrary, the Company shall have the right to direct the Administrator to perform any action necessary for the Reinsured Contracts or the policyholder and claim servicing thereof to comply with Applicable Law, or to cease performing any action that constitutes a violation of Applicable Law.

---

ARTICLE II

STANDARD FOR SERVICES; FACILITIES; SUBCONTRACTING

2.1. Standard for Services. The Administrator shall provide policyholder and claims servicing with respect to the Reinsured Contracts in good faith and with the care, skill, prudence and diligence of a person experienced in administering structured settlement business. Without limiting the generality of the foregoing, the Administrator shall provide policyholder and claims servicing with respect to the Reinsured Contracts (i) in accordance with the terms of the Reinsured Contracts, (ii) in accordance with the applicable terms of this Agreement, (iii) in compliance with Applicable Law, (iv) in accordance with industry standards and, subject to the foregoing, (v) to the extent applicable, in the same manner as it conducts its own business not subject to this Agreement.

2.2. Facilities and Personnel. To the extent not sub-contracted to a Subcontractor, the Administrator shall at all times maintain sufficient facilities and trained personnel of the kind necessary to perform its obligations under this Agreement in accordance with the performance standards set forth herein.

2.3. Subcontracting. The Administrator may subcontract for the performance of any policyholder or claims servicing service or services with respect to the Reinsured Contracts to (i) an Affiliate or (ii) any other Person with the prior written consent of the Company, such consent not to be unreasonably withheld (in each case, the "Subcontractor"); provided, that, no such subcontracting shall relieve the Administrator from any of its obligations or liabilities hereunder, and the Administrator shall remain responsible for all obligations or liabilities of such Subcontractor with regards to the providing of such service or services as if provided by the Administrator.

### ARTICLE III

#### CLAIMS HANDLING

The Administrator shall pay all Benefits payable on or after the Inception Date with respect to the Reinsured Contracts (each, a "Claim" and collectively the "Claims").

### ARTICLE IV

#### REGULATORY AND LEGAL PROCEEDINGS

4.1. Regulatory Complaints and Proceedings. The Administrator shall:

- (i) respond to any Claims payment related complaints or inquiries made by any Governmental Authority, within the Governmental Authority's requested time frame for response or, if no such time frame is provided, within the time frame as allowed by Applicable Law; and promptly provide a copy of such response to the Company;

2

---

- (ii) promptly notify the Company of any non-Claims payment related complaints or inquiries initiated by a Governmental Authority, and of any proceedings (either Claims or non-Claims related) initiated by a Governmental Authority, and, in either case, prepare and send to the Governmental Authority, with a copy to the Company, a response within the Governmental Authority's requested time frame for response or, if no such time frame is provided, within the time frame as allowed by Applicable Law; provided, that, subject to meeting such time frames, the Administrator shall provide such response to the Company for its prior review and comment;

- (iii) subject to Section 4.4, supervise and control the investigation, contest, defense and/or settlement of all complaints, inquiries and proceedings by Governmental Authorities at its own cost and expense, and in the name of the Company when necessary; and

- (iv) at the Company's request, provide to the Company a report in a form mutually agreed by the parties summarizing the nature of any complaints, inquiries or proceedings by Governmental Authorities, the alleged actions or omissions giving rise to such complaints, inquiries or proceedings and copies of any files or other documents that the Company may reasonably request in connection with its review of these matters.

4.2. Legal Proceedings. The Administrator shall:

- (i) notify the Company promptly of any lawsuit, action, arbitration or other dispute resolution proceedings that are instituted or threatened with respect to any matter relating to the Reinsured Contracts ("Legal Proceeding(s)"), and in no event more than five (5) Business Days after receipt of notice thereof;
- (ii) subject to Section 4.4, supervise and control the investigation, contest, defense and/or settlement of all Legal Proceedings at its own cost and expense, and in the name of the Company when necessary; and
- (iii) keep the Company fully informed of the progress of all Legal Proceedings handled by the Administrator in which the Company is named a party and, at the Company's request, provide to the Company a report summarizing the nature of any Legal Proceedings, the alleged actions or omissions giving rise to such Legal Proceedings and copies of any files or other documents that the Company may reasonably request in connection with its review of these matters in each case other than such files, documents and other information as would, in the judgment of counsel to the Administrator, lead to the loss or waiver of legal privilege.

4.3. Notice to Administrator. The Company shall give prompt notice to the Administrator of any Legal Proceeding made or brought against the Company after the Inception

3

---

Date arising under or in connection with the Reinsured Contracts to the extent known to it and not made against or served on the Administrator or a Subcontractor as administrator hereunder, and in no event more than five (5) Business Days after receipt of notice thereof, and shall promptly furnish to the Administrator copies of all pleadings in connection therewith. The Administrator shall assume the defense of the Company.

4.4. Defense of Regulatory and Legal Proceedings. Notwithstanding anything in this Agreement to the contrary, the Company shall have the right to engage in its own separate legal representation, at its own expense, and to participate fully in the defense of any Legal Proceedings or complaints, inquiries or proceedings by Governmental Authorities with respect to the Reinsured Contracts in which the Company is a named party without waiving any right to indemnification it may have under Article XV hereof. The Administrator and the Company shall cooperate with each other with respect to the administration of any Legal Proceeding and any complaint, inquiry or proceeding by Governmental Authorities. The Administrator shall not settle any Legal Proceeding or any complaint, inquiry or proceeding by Governmental Authorities without the Company's prior written consent (which consent shall not be unreasonably withheld or delayed) unless (i) there is no finding or admission of any violation of law or any violation of the rights of any Person, (ii) such settlement would not reasonably be expected to have material adverse precedential consequences to the Company and (iii) the sole relief provided is monetary damages that are paid in full by the Administrator.

### ARTICLE V

#### NOTIFICATION TO POLICYHOLDERS

The Administrator agrees to send to policyholders of the Reinsured Contracts a written notice prepared by the Administrator and reasonably acceptable to the Company to the effect that the Administrator, or such other Person designated by the Administrator in accordance with the terms of this Agreement, has been appointed by the Company to provide Administrative Services. The Administrator shall send such notice by first class U.S. mail at a time reasonably acceptable to the Company and the Administrator and in all events in accordance with Applicable Law. The parties intend to minimize the cost associated with any notification under this Article V, including by means of inclusion of the notice in a regularly scheduled mailing to policyholders in lieu of a separate mailing. The cost associated with such notification under this Article V (upon the initial assumption of the administration of the Reinsured Contracts under Section 3.7 of the Coinsurance Agreement) shall be a transition cost payable by the Administrator or the Company in accordance with Section 3.7(a) or 3.7(c) of the Coinsurance Agreement, as applicable.

## ARTICLE VI

### INSOLVENCY FUND ACCOUNTINGS

6.1. Quarterly Accountings. Within thirty (30) days after the end of each calendar quarter that this Agreement is in effect (or more frequently as mutually agreed by the

4

---

parties), the Company shall submit to the Administrator a written statement of accounting in a form and containing such information to be agreed upon by the parties hereto (each, an "Insolvency Fund Quarterly Accounting") setting forth the Insolvency Fund amounts assessed or payable to the extent that such assessments constitute Reinsured Risks with respect to the Reinsured Contracts (collectively, the "Post-Effective Date Assessments"). The Administrator shall remit to the Company an amount equal to the Post-Effective Date Assessments set forth in an Insolvency Fund Quarterly Accounting received by the Administrator within ten (10) Business Days of receipt by the Administrator of such Insolvency Fund Quarterly Accounting.

6.2. Adjustments Regarding Insolvency Fund Accountings. In the event that subsequent data or calculations require revision of any of the Insolvency Fund Quarterly Accountings, the required revision and appropriate payments thereunder shall be made within ten (10) Business Days after the parties hereto mutually agree as to the appropriate revision.

## ARTICLE VII

### CERTAIN ACTIONS BY COMPANY

7.1. Filings. The Company shall prepare and timely file any filings required to be made with any Governmental Authority that relate to the Company generally and not just to the Reinsured Contracts, including filings with guaranty associations and filings and premium tax returns with taxing authorities. The Administrator shall, in a timely fashion in light of the dates such filings by the Company are required, provide to the Company all information in the possession of the Administrator with respect to the Reinsured Contracts that may be reasonably required for the Company to prepare such filings and tax returns.

7.2. Annual Adjustment. The Company shall pay or provide to the Administrator the benefit of any Post-Effective Date Assessments which have been or can be applied to reduce the Company's premium tax liability ("Premium Tax Credits"). The Company shall provide to the Administrator by March 15 of each year a statement of the amount of Premium Tax Credits for the prior calendar year and the Company will pay or credit to the Administrator an amount equal to such Premium Tax Credits.

## ARTICLE VIII

### REGULATORY MATTERS AND AUDIT REPORTING

8.1. Regulatory Compliance and Reporting. The Administrator shall provide to the Company such information with respect to the Reinsured Contracts as is required to satisfy all current and future informational reporting, prior approval and any other requirements imposed by any Governmental Authority. Upon the reasonable request of the Company, the Administrator shall timely prepare such reports and summaries, including statistical summaries, as are necessary or reasonably required to satisfy any requirements imposed by a Governmental Authority upon the Company with respect to the Reinsured Contracts. In addition, the Administrator, upon the reasonable request of the Company, shall promptly provide to the Company copies of all existing records relating to the Reinsured Contracts (including, with

5

---

respect to records maintained in machine readable form, hard copies) that are necessary to satisfy such requirements. All copies of records furnished in the ordinary course of business shall be furnished by the Administrator at the Administrator's cost. Any extraordinary costs reasonably incurred by the Administrator in response to requests from the Company shall be reimbursed by the Company. Among other responsibilities:

- (i) The Administrator shall promptly prepare and furnish to Governmental Authorities all reports and related summaries (including, without limitation, statistical summaries), certificates of compliance and other reports required or requested by a Governmental Authority.
  - (ii) The Administrator shall assist the Company and cooperate with the Company in doing all things necessary, proper or advisable, in the most expeditious manner practicable in connection with any and all market conduct or other Governmental Authority examinations relating to the Reinsured Contracts.
- 8.2. Reporting and Accounting. The Administrator shall assume the reporting and accounting obligations set forth below:
- (i) As soon as practicable but not more than forty (40) days after the end of each calendar quarter that this Agreement is in effect (or more frequently as mutually agreed by the parties), the Administrator shall timely provide to the Company reports and summaries of transactions (and, upon request of the Company, detailed supporting records) related to the Reinsured Contracts as may be reasonably required for use in connection with the preparation of the Company's statutory and GAAP financial statements, tax returns and other required financial reports and to comply with the requirements of the regulatory authorities having jurisdiction over the Company. The parties shall cooperate in good faith to establish the manner for the providing of such reports.

- (ii) As soon as practicable but not more than forty (40) days after the end of each calendar quarter that this Agreement is in effect (or more frequently as mutually agreed by the parties), the Administrator shall report to the Company the amount of statutory reserves that the Company is required to maintain in connection with the Reinsured Risks with respect to the Reinsured Contracts as of the quarter end.
- (iii) The Administrator shall promptly provide notice to the Company of any changes in the reserve methodology used by the Administrator in calculating statutory reserves for the Reinsured Contracts.
- (iv) Within forty-five (45) days after each calendar year end (or such longer time as may be agreed by the parties) that this Agreement is in effect, the Administrator shall provide to the Company (a) an opinion of an actuary reasonably acceptable to the Company as to the adequacy of statutory

6

---

reserves for the Reinsured Contracts, prepared according to accepted actuarial standards of practice, and as otherwise required for regulatory reporting purposes and (b) an analysis which reasonably supports such opinion.

8.3. Additional Reports and Updates. For so long as this Agreement remains in effect, each party shall periodically furnish to the other such other reports and information as may be reasonably required by such other party for regulatory, tax or similar purposes and reasonably available to it.

#### ARTICLE IX

##### MISCELLANEOUS ADMINISTRATIVE SERVICES

The Administrator shall provide such other Administrative Services as are necessary or appropriate to fully effectuate the purpose of the Reinsurance Agreement and this Agreement, including such Administrative Services as are not performed by or on behalf of the Company on the date hereof but the need for which may arise due to changes or developments in Applicable Law.

#### ARTICLE X

##### BOOKS AND RECORDS

The Administrator shall keep accurate and complete records, files and accounts of all transactions and matters with respect to the Reinsured Contracts and the administration thereof in accordance with Applicable Law and its record management practices in effect from time to time for the Administrator's insurance business not covered by this Agreement, if any. The parties to this Agreement and their designated representatives may upon reasonable notice inspect, at the offices of the Administrator or the Company where such records are located, the papers and any and all other books or documents of the Administrator or the Company reasonably relating to this Agreement, including the Reinsured Contracts, and shall have access to appropriate employees and representatives of the other party, in each case during normal business hours for such period as this Agreement is in effect or for as long thereafter as any rights or obligations of any party survives or the Administrator or the Company reasonably need access to such records for regulatory, tax or similar purposes. The information obtained shall be used only for purposes relating to the transactions contemplated under this Agreement.

#### ARTICLE XI

##### COOPERATION

Each party hereto shall cooperate fully with the other in all reasonable respects in order to accomplish the objectives of this Agreement including making available to each their respective officers and employees for interviews and meetings with Governmental Authorities and

7

---

furnishing any additional assistance, information and documents as may be reasonably requested by a party from time to time.

#### ARTICLE XII

##### PRIVACY REQUIREMENTS

In providing the Administrative Services provided for under this Agreement, and in connection with maintaining, administering, handling and transferring the data of the policyholders and other recipients of benefits under the Reinsured Contracts, the Administrator shall, and shall cause its Affiliates and any permitted Subcontractors to, comply with all confidentiality and security obligations applicable to them in connection with the collection, use, disclosure, maintenance and transmission of personal, private, health or financial information about individual policyholders or benefit recipients, including the provisions of privacy policies under which such information was gathered, those laws currently in place and which may become effective during the term of this Agreement, including the Gramm-Leach-Bliley Act, the Health Insurance Portability and Accountability Act of 1996 and any other Applicable Laws. The Administrator shall entitle the Company and its agents and representatives, the Commissioner of Health and Human Services and such other Governmental Authorities, to the extent required by Applicable Law, to audit the Administrator's compliance herewith. The Administrator shall also enable individual subjects of personally identifiable information, upon request from such individuals, to review and correct information maintained by the Administrator about them, and to restrict use of such information. The Administrator shall promptly report to the Company any violation of this provision of which the Administrator becomes aware. Unless required by Applicable Law, the Administrator shall not during the term of this Agreement, modify the privacy policies under which information utilized by the Administrator in administering the Reinsured Contracts is gathered, without the Company's prior written consent, which consent shall not be unreasonably withheld. The parties agree to comply with the terms of the Business Associate Addendum attached hereto, if applicable, or such other written agreement as may be required by Applicable Law on the date hereof.

#### ARTICLE XIII

##### CONSIDERATION FOR ADMINISTRATIVE SERVICES

Apart from the performance by the Company of its obligations under the Coinsurance Agreement, there shall be no fee or other consideration due to the Administrator

for performance of the Administrative Services under this Agreement.

#### ARTICLE XIV

##### BANK ACCOUNT; USE OF COMPANY LETTERHEAD

When and on terms reasonably requested by the Administrator, the Company shall open, modify or close, and make available for use by the Administrator for the payment of amounts to

8

---

be paid by the Administrator hereunder one or more bank accounts of the Company and check stock of the Company. The Administrator shall maintain such account(s) and pay all applicable bank fees and check stock costs. The Company shall adopt such resolutions and execute such documents as required to designate senior officers of the Administrator (by title) as signatories on such account(s) and authorize the Administrator to certify to such bank(s), from time to time, the names of such officers. The Company shall also make available to the Administrator, at the sole expense of the Administrator, such letterhead, printed forms and other documents of the Company as may be reasonably required by the Administrator in performing services hereunder. Upon termination of this Agreement, the Administrator shall promptly return to the Company all such unused check stock, letterhead, printed forms and other documents held by it in connection with this Agreement as provided under this Article XIV.

#### ARTICLE XV

##### INDEMNIFICATION

Any claim for or with respect to indemnification arising out of, or relating to, this Agreement or the Administrative Services hereunder shall be permitted under and governed by the provisions of Article V of the Master Agreement, dated as of [ ], 2004, among General Electric Company, General Electric Capital Corporation, GEI, Inc., GE Financial Assurance Holdings, Inc. and Genworth Financial, Inc (the "Master Agreement"), to the extent such provisions are applicable, as if this Agreement were a Transaction Document under the Master Agreement.

#### ARTICLE XVI

##### DURATION; TERMINATION

16.1. Duration. This Agreement shall commence on the Effective Date and continue with respect to each Reinsured Contract until no further Administrative Services in respect of such Reinsured Contract is required, unless this Agreement is earlier terminated under Section 16.2.

16.2. Termination. (a) This Agreement is subject to immediate termination at the option of the Company, upon written notice to the Administrator, on the occurrence of any of the following events:

- (i) A voluntary or involuntary proceeding is commenced in any jurisdiction by or against the Administrator for the purpose of conserving, rehabilitating or liquidating the Administrator;
- (ii) There is a material breach by the Administrator of any material term or condition of this Agreement that is not cured by the Administrator within thirty (30) days after receipt of written notice from the Company of such breach or act (provided that the Company shall not have the right to terminate this Agreement (A) for so long as the Administrator is making a

9

---

good faith effort to cure such breach, not to exceed an additional one hundred eighty (180) days or (B) during the pendency of any dispute resolution proceedings as set forth in Article XVII regarding an alleged material breach); or

- (iii) The Administrator is unable to perform the services required under this Agreement for a period of thirty (30) consecutive days for any reason other than as a result of a Force Majeure, it being understood that nothing in this Section 16.2(a)(iii) shall relieve the Administrator from its administrative responsibilities under this Agreement. For purposes of this Agreement, "Force Majeure" means any acts or omissions of any civil or military authority, acts of God, acts or omissions of the Company, fires, strikes or other labor disturbances, equipment failures, fluctuations or non-availability of electrical power, heat, light, air conditioning or telecommunications equipment, or any other act, omission or occurrence beyond the Administrator's reasonable control, irrespective of whether similar to the foregoing enumerated acts, omissions or occurrences.

(b) This Agreement may be terminated at any time upon the mutual written consent of the parties hereto, which writing shall state the effective date of termination.

(c) In the event that this Agreement is terminated under any of the provisions of Section 16.2(a), the Administrator shall select a third-party administrator to perform the services required by this Agreement. The Company shall have the right to approve any such administrator selected by the Administrator, but such approval will not unreasonably be withheld or delayed. If the Administrator fails to select an administrator pursuant to this Section 16.2(c), the Company shall select such an administrator. In either case, the Administrator shall pay all fees and charges imposed by the selected administrator and shall bear all transition costs associated with the transition of the performance of the services required under this Agreement to such administrator, including the expense of sending policyholder notices as provided in Article V.

#### ARTICLE XVII

##### DISPUTE RESOLUTION

17.1. General Provisions. (a) Any dispute, controversy or claim arising out of or relating to this Agreement or the validity, interpretation, breach or termination thereof (a "Dispute"), shall be resolved in accordance with the procedures set forth in this Article XVII, which shall be the sole and exclusive procedures for the resolution of any such Dispute unless otherwise specified below.

(b) Commencing with the request contemplated by Section 17.2, all communications between the parties or their representatives in connection with the attempted resolution of any Dispute, including any mediator's evaluation referred to in Section 17.3, shall be deemed to have been delivered in furtherance of a Dispute settlement and shall be exempt

from discovery and production, and shall not be admissible in evidence for any reason (whether as an admission or otherwise), in any arbitral or other proceeding for the resolution of the Dispute.

(c) In connection with any Dispute, the parties expressly waive and forego any right to (i) punitive, exemplary, statutorily-enhanced or similar damages in excess of compensatory damages (provided that any such liability with respect to a Third Party Claim (as defined in the Master Agreement) shall be considered direct damages), and (ii) trial by jury.

(d) The specific procedures set forth below, including but not limited to the time limits referenced therein, may be modified by agreement of the parties in writing.

(e) All applicable statutes of limitations and defenses based upon the passage of time shall be tolled while the procedures specified in this Article XVII are pending. The parties will take such action, if any, required to effectuate such tolling.

17.2. Consideration by Senior Executives. If a Dispute is not resolved in the normal course of business at the operational level, the parties shall attempt in good faith to resolve such Dispute by negotiation between executives who hold, at a minimum, the office of President and CEO of the respective business entities involved in such Dispute. Either party may initiate the executive negotiation process by providing a written notice to the other (the "Initial Notice"). Fifteen (15) days after delivery of the Initial Notice, the receiving party shall submit to the other a written response (the "Response"). The Initial Notice and the Response shall include (i) a statement of the Dispute and of each party's position, and (ii) the name and title of the executive who will represent that party and of any other person who will accompany the executive. Such executives will meet in person or by telephone within thirty (30) days of the date of the Initial Notice to seek a resolution of the Dispute.

17.3. Mediation. If a Dispute is not resolved by negotiation as provided in Section 17.2 within forty-five (45) days from the delivery of the Initial Notice, then either party may submit the Dispute for resolution by mediation pursuant to the CPR Institute for Dispute Resolution (the "CPR") Model Mediation Procedure as then in effect. The parties will select a mediator from the CPR Panels of Distinguished Neutrals, but such mediator must have prior U.S. reinsurance experience either as a lawyer or as a present or former officer or management employee of a reinsurance company, but not of the Company, or the Administrator, or any of their respective affiliates. Either party at commencement of the mediation may ask the mediator to provide an evaluation of the Dispute and the parties' relative positions.

17.4. Arbitration. (a) If a Dispute is not resolved by mediation as provided in Section 17.3 within thirty (30) days of the selection of a mediator (unless the mediator chooses to withdraw sooner), either party may submit the Dispute to be finally resolved by arbitration pursuant to the CPR Rules for Non-Administered Arbitration as then in effect (the "CPR Arbitration Rules"). The parties consent to a single, consolidated arbitration for all known Disputes existing at the time of the arbitration and for which arbitration is permitted.

(b) The neutral organization for purposes of the CPR Arbitration Rules will be the CPR. The arbitral tribunal shall be composed of three arbitrators who are each experienced in

the U.S. reinsurance business, of whom each party shall appoint one in accordance with the "screened" appointment procedure provided in Rule 5.4 of the CPR Arbitration Rules. The non-party appointed arbitrator must have prior U.S. reinsurance experience as a present or former officer or management employee of a reinsurance company, but not of the Company, or the Administrator, or any of their respective affiliates. The arbitration shall be conducted in New York City. Each party shall be permitted to present its case, witnesses and evidence, if any, in the presence of the other party. A written transcript of the proceedings shall be made and furnished to the parties. The arbitrators shall determine the Dispute in accordance with the law of Virginia, without giving effect to any conflict of law rules or other rules that might render such law inapplicable or unavailable, and shall apply this Agreement according to its terms, provided that the provisions relating to arbitration shall be governed by the Federal Arbitration Act, 9 U.S.C. §§ 1 et seq. The arbitral tribunal shall endeavor to render its award or order resulting from any arbitration within forty-five (45) days following the termination of the arbitration proceedings.

(c) The parties agree to be bound by any award or order resulting from any arbitration conducted hereunder and further agree that judgment on any award or order resulting from an arbitration conducted under this Section 17.4 may be entered and enforced in any court having jurisdiction thereof.

(d) Except as expressly permitted by this Agreement, no party will commence or voluntarily participate in any court action or proceeding concerning a Dispute, except (i) for enforcement as contemplated by Section 17.4(c) above, (ii) to restrict or vacate an arbitral decision based on the grounds specified under applicable law, or (iii) for interim relief as provided in paragraph (e) below. For purposes of the foregoing the parties hereto submit to the non-exclusive jurisdiction of the courts of the State of New York.

(e) In addition to the authority otherwise conferred on the arbitral tribunal, the tribunal shall have the authority to make such orders for interim relief, including injunctive relief, as it may deem just and equitable. Notwithstanding paragraph (d) above, each party acknowledges that in the event of any actual or threatened breach of certain of the provisions of this Agreement, the remedy at law would not be adequate, and therefore injunctive or other interim relief may be sought immediately to restrain such breach. If the tribunal shall not have been appointed, either party may seek interim relief from a court having jurisdiction if the award to which the applicant may be entitled may be rendered ineffectual without such interim relief. Upon appointment of the tribunal following any grant of interim relief by a court, the tribunal may affirm or disaffirm such relief, and the parties will seek modification or rescission of the court action as necessary to accord with the tribunal's decision.

(f) Each party will bear its own attorneys' fees and costs incurred in connection with the resolution of any Dispute in accordance with this Article XVII.

ARTICLE XVIII

MISCELLANEOUS PROVISIONS

18.1. Headings and Schedules. Headings used herein are not a part of this Agreement and shall not affect the terms hereof. The attached Schedules are a part of this Agreement.

18.2. Notices. All notices, requests, demands and other communications under this Agreement must be in writing and will be deemed to have been duly given or made as follows: (a) if sent by registered or certified mail in the United States return receipt requested, upon receipt; (b) if sent by reputable overnight air courier, two business days after mailing; (c) if sent by facsimile transmission, with a copy mailed on the same day in the manner provided in (a) or (b) above, when transmitted and receipt is confirmed by telephone; or (d) if otherwise actually personally delivered, when delivered, and shall be delivered as follows:

If to the Company:

First Colony Life Insurance Company  
700 Main Street  
Lynchburg, VA 24504  
Facsimile: (434) 948-5064  
Attention: Chief Executive Officer

With a copy to:

First Colony Life Insurance Company  
700 Main Street  
Lynchburg, VA 24504  
Facsimile: (434) 948-5819  
Attention: General Counsel

If to the Administrator:

Union Fidelity Life Insurance Company  
200 North Martingale Road  
Schaumburg, IL 60173-2096  
Facsimile: (847) 330-3404  
Attention: Chief Financial Officer

With a copy to:

13

---

Union Fidelity Life Insurance Company  
200 North Martingale Road  
Schaumburg, IL 60173-2096  
Facsimile: (847) 605-3044  
Attention: General Counsel

or to such other address or to such other Person as either party may have last designated by notice to the other party.

18.3. Successors and Assigns. This Agreement shall be binding upon and inure to the benefit of the parties hereto and their respective successors, permitted assigns and legal representatives. Neither this Agreement, nor any right or obligation hereunder, may be assigned by any party without the prior written consent of the other party hereto. Any assignment in violation of this Section 18.3 shall be void and shall have no force and effect.

18.4. Execution in Counterpart. This Agreement may be executed by the parties hereto in any number of counterparts, and by each of the parties hereto in separate counterparts, each of which counterparts, when so executed and delivered, shall be deemed to be an original, but all such counterparts shall together constitute but one and the same instrument.

18.5. Currency. Whenever the word "Dollars" or the "\$" sign appear in this Agreement, they shall be construed to mean United States Dollars, and all transactions under this Agreement shall be in United States Dollars.

18.6. Amendments. This Agreement may not be changed, altered or modified unless the same shall be in writing executed by the Company and the Administrator.

18.7. Governing Law. This Agreement will be construed, performed and enforced in accordance with the laws of the Commonwealth of Virginia without giving effect to its principles or rules of conflict of laws thereof to the extent such principles or rules would require or permit the application of the laws of another jurisdiction.

18.8. Entire Agreement; Severability. (a) This Agreement constitutes the entire agreement between the parties hereto relating to the subject matter hereof and supersedes all prior and contemporaneous agreements, understandings, statements, representations and warranties, negotiations and discussions, whether oral or written, of the parties and there are no general or specific warranties, representations or other agreements by or among the parties in connection with the entering into of this Agreement or the subject matter hereof except as specifically set forth or contemplated herein.

(b) If any provision of this Agreement is held to be void or unenforceable, in whole or in part, (i) such holding or provision shall not affect the validity and enforceability of the remainder of this Agreement, including any other provision, paragraph or subparagraph, and (ii) the parties agree to attempt in good faith to reform such void, unenforceable or violative provision to the extent necessary to render such provision enforceable and to carry out its original intent.



18.9. No Waiver; Preservation of Remedies. No consent or waiver, express or implied, by any party to or of any breach or default by any other party in the performance by such other party of its obligations hereunder shall be deemed or construed to be a consent or waiver to or of any other breach or default in the performance of obligations hereunder by such other party hereunder. Failure on the part of any party to complain of any act or failure to act of any other party or to declare any other party in default, irrespective of how long such failure continues, shall not constitute a waiver by such first party of any of its rights hereunder. The rights and remedies provided are cumulative and are not exclusive of any rights or remedies that any party may otherwise have at law or equity.

18.10. Third Party Beneficiary. Nothing in this Agreement will confer any rights upon any Person that is not a party or a successor or permitted assignee of a party to this Agreement.

18.11. Tax Exception to Any Confidentiality. Notwithstanding anything to the contrary set forth herein or in any other agreement to which the parties hereto are parties or by which they are bound, any obligations of confidentiality contained herein and therein, as they relate to the transactions, shall not apply to the federal tax structure or federal tax treatment of the transactions, and each party hereto (and any employee, representative, or agent of any party hereto) may disclose to any and all persons, without limitation of any kind, the federal tax structure and federal tax treatment of the transactions. The preceding sentence is intended to cause the transactions to be treated as not having been offered under conditions of confidentiality for purposes of Section 1.6011-4(b)(3) (or any successor provision) of the Treasury Regulations promulgated under Section 6011 of the Internal Revenue Code of 1986, as amended, and shall be construed in a manner consistent with such purpose. In addition, each party hereto acknowledges that it has no proprietary or exclusive rights to the federal tax structure of the transactions or any federal tax matter or federal tax idea related to the transactions.

18.12. Interpretation. Wherever the words "include," "includes" or "including" are used in this Agreement, they shall be deemed to be followed by the words "without limitation."

18.13. Survival. Article XVII and Article XVIII shall survive the termination of this Agreement.

IN WITNESS WHEREOF, the Company and the Administrator have executed this Agreement as of the date first above written.

FIRST COLONY LIFE INSURANCE COMPANY

By: \_\_\_\_\_

Name:  
Title:

UNION FIDELITY LIFE INSURANCE COMPANY

By: \_\_\_\_\_

Name:  
Title:

### BUSINESS ASSOCIATE ADDENDUM

#### I. Purpose.

In order to disclose certain information to the party providing a service under this Agreement ("Provider") under this Addendum, some of which may constitute Protected Health Information (defined below), the party to whom a service under this Agreement is being provided ("Recipient") and Provider mutually agree to comply with the terms of this Addendum for the purpose of satisfying the requirements of the Health Insurance Portability and Accountability Act of 1996 ("HIPAA") and its implementing privacy regulations at 45 C.F.R. Parts 160-164 ("HIPAA Privacy Rule"). These provisions shall apply to Provider to the extent that Provider is considered a "Business Associate" under the HIPAA Privacy Rule and all references in this section to Business Associates shall refer to Provider. Capitalized terms not otherwise defined herein shall have the meaning assigned in the Agreement. Notwithstanding anything else to the contrary in the Agreement, in the event of a conflict between this Addendum and the Agreement, the terms of this Addendum shall prevail.

#### II. Permitted Uses and Disclosures.

A. Business Associate agrees to use or disclose Protected Health Information ("PHI") that it creates for or receives from Recipient or its Subsidiaries only as follows. The capitalized term "Protected Health Information or PHI" has the meaning set forth in 45 Code of Federal Regulations Section 164.501, as amended from time to time. Generally, this term means individually identifiable health information including, without limitation, all information, data and materials, including without limitation, demographic, medical and financial information, that relates to the past, present, or future physical or mental health or condition of an individual; the provision of health care to an individual; or the past present, or future payment for the provision of health care to an individual; and that identifies the individual or with respect to which there is a reasonable basis to believe the information can be used to identify the individual. This definition shall include any demographic information concerning members and participants in, and applicants for, Recipient's or its Subsidiaries' health benefit plans. All other terms used in this Addendum shall have the meanings set forth in the applicable definitions under the HIPAA Privacy Rule.

B. Functions and Activities on Company's Behalf. Business Associate is permitted to use and disclose PHI it creates for or receives from Recipient or its Subsidiaries only for the purposes described in this Addendum or the Agreement that are not inconsistent with the provisions of this Addendum, or as required by law, or following receipt of prior written approval from whichever of the Recipient or its Subsidiary for which the relevant PHI was created or from which the relevant PHI was received. In addition to these specific requirements below, Business Associate may use or disclose PHI only in a manner that would not violate the HIPAA Privacy Rule if done by the Recipient or its Subsidiaries.

C. Business Associate's Operations. Business Associate is permitted by this Agreement to use PHI it creates for or receives from Recipient or its Subsidiaries: (i) if

such use is reasonably necessary for Business Associate's proper management and administration; and (ii) as reasonably necessary to carry out Business Associate's legal responsibilities.

---

Business Associate is permitted to disclose PHI it creates for or receives from Recipient or its Subsidiaries for the purposes identified in this Section only if the following conditions are met:

- (1) The disclosure is required by law; or
- (2) The disclosure is reasonably necessary to Business Associate's proper management and administration, and Business Associate obtains reasonable assurances in writing from any person or organization to which Business Associate will disclose such PHI that the person or organization will:
  - a. Hold such PHI as confidential and use or further disclose it only for the purpose for which Business Associate disclosed it to the person or organization or as required by law; and
  - b. Notify Business Associate (who will in turn promptly notify whichever of the Recipient or its Subsidiary for which the relevant PHI was created or from which the relevant PHI was received) of any instance of which the person or organization becomes aware in which the confidentiality of such PHI was breached.

D. Minimum Necessary Standard. In performing the functions and activities on Recipient's or its Subsidiaries' behalf pursuant to the Agreement, Business Associate agrees to use, disclose or request only the minimum necessary PHI to accomplish the purpose of the use, disclosure or request. Business Associate must have in place policies and procedures that limit the PHI disclosed to meet this minimum necessary standard.

E. Prohibition on Unauthorized Use or Disclosure. Business Associate will neither use nor disclose PHI it creates or receives for or from Recipient, its Subsidiaries, or from another business associate of Recipient or its Subsidiaries, except as permitted or required by this Addendum or the Agreement that are not inconsistent with the provisions of this Addendum, or as required by law, or following receipt of prior written approval from whichever of the Recipient or its Subsidiary for which the relevant PHI was created or from which the relevant PHI was received.

F. De-identification of Information. Business Associate agrees neither to de-identify PHI it creates for or receives from Recipient or its Subsidiaries or from another business associate of Recipient or its Subsidiaries, nor use or disclose such de-identified PHI, unless such de-identification is expressly permitted under the terms and conditions of this Addendum or the Agreement and related to Recipient's or its Subsidiaries' activities for purposes of "treatment", "payment" or "health care operations", as those terms are defined under the HIPAA Privacy Rule. De-identification of PHI, other than as expressly permitted under the terms and conditions of the Addendum for Business Associate to perform services for Recipient or its Subsidiaries, is not a permitted use of PHI under this Addendum. Business Associate further agrees that it will not create a "Limited Data Set" as defined by the HIPAA Privacy Rule using PHI it creates or receives, or receives from another business associate of Recipient or its Subsidiaries, nor use or disclose such Limited Data Set unless: (i) such creation, use or disclosure is expressly permitted under the terms and conditions of

2

---

this Addendum or the Agreement that are not inconsistent with the provisions of this Addendum; and such creation, use or disclosure is for services provided by Business Associate that relate to Recipient's or its Subsidiaries' activities for purposes of "treatment", "payment" or "health care operations", as those terms are defined under the HIPAA Privacy Rule.

G. Information Safeguards. Business Associate will develop, document, implement, maintain and use appropriate administrative, technical and physical safeguards to preserve the integrity and confidentiality of and to prevent non-permitted use or disclosure of PHI created for or received from Recipient or its Subsidiaries. These safeguards must be appropriate to the size and complexity of Business Associate's operations and the nature and scope of its activities. Business Associate agrees that these safeguards will meet any applicable requirements set forth by the U.S. Department of Health and Human Services, including (as of the effective date or as of the compliance date, whichever is applicable) any requirements set forth in the final HIPAA security regulations. Business Associate agrees to mitigate, to the extent practicable, any harmful effect that is known to Business Associate resulting from a use or disclosure of PHI by Business Associate in violation of the requirements of this Addendum.

III. Conducting Standard Transactions. In the course of performing services for Recipient or its Subsidiaries, to the extent that Business Associate will conduct Standard Transactions for or on behalf of Recipient or its Subsidiaries, Business Associate will comply, and will require any subcontractor or agent involved with the conduct of such Standard Transactions to comply, with each applicable requirement of 45 C.F.R. Part 162. "Standard Transaction(s)" shall mean a transaction that complies with the standards set forth at 45 C.F.R. parts 160 and 162. Further, Business Associate will not enter into, or permit its subcontractors or agents to enter into, any trading partner agreement in connection with the conduct of Standard Transactions for or on behalf of the Recipient or its Subsidiaries that:

- a. Changes the definition, data condition, or use of a data element or segment in a Standard Transaction;
- b. Adds any data element or segment to the maximum defined data set;
- c. Uses any code or data element that is marked "not used" in the Standard Transaction's implementation specification or is not in the Standard Transaction's implementation specification; or
- d. Changes the meaning or intent of the Standard Transaction's implementation specification.

IV. Sub-Contractors, Agents or Other Representatives. Business Associate will require any of its subcontractors, agents or other representatives to which Business Associate is permitted by this Addendum or the Agreement (or is otherwise given Recipient's or the relevant Subsidiary's prior written approval) to disclose any of the PHI Business Associate creates or receives for or from Recipient or its Subsidiaries, to provide reasonable assurances in writing that subcontractor or

3

---

agent will comply with the same restrictions and conditions that apply to the Business Associate under the terms and conditions of this Addendum with respect to such PHI.

V. Protected Health Information Access, Amendment and Disclosure Accounting.

A. Access. Business Associate will promptly upon Recipient's or its Subsidiary's request make available to Recipient, its Subsidiary, or, at Recipient's or such Subsidiary's direction, to the individual (or the individual's personal representative) for inspection and obtaining copies any PHI about the individual which Business Associate created for or received from Recipient or its Subsidiary and that is in Business Associate's custody or control, so that Recipient or its Subsidiary may meet its access obligations under 45 Code of Federal Regulations § 164.524.

B. Amendment. Upon Recipient's or its Subsidiary's request Business Associate will promptly amend or permit Recipient or its Subsidiary access to amend any portion of the PHI which Business Associate created for or received from Recipient or its Subsidiary, and incorporate any amendments to such PHI, so that Recipient or its Subsidiary may meet its amendment obligations under 45 Code of Federal Regulations § 164.526.

C. Disclosure Accounting. So that Recipient or its Subsidiaries may meet their disclosure accounting obligations under 45 Code of Federal Regulations § 164.528:

1. Disclosure Tracking. Business Associate will record for each disclosure, not excepted from disclosure accounting under Section V.C.2 below, that Business Associate makes to Recipient or its Subsidiaries of PHI that Business Associate creates for or receives from Recipient or its Subsidiaries, (i) the disclosure date, (ii) the name and member or other policy identification number of the person about whom the disclosure is made, (iii) the name and (if known) address of the person or entity to whom Business Associate made the disclosure, (iv) a brief description of the PHI disclosed, and (v) a brief statement of the purpose of the disclosure (items i-v, collectively, the "disclosure information"). For repetitive disclosures Business Associate makes to the same person or entity (including Recipient or its Subsidiaries) for a single purpose, Business Associate may provide a) the disclosure information for the first of these repetitive disclosures, (b) the frequency, periodicity or number of these repetitive disclosures and (c) the date of the last of these repetitive disclosures. Business Associate will make this disclosure information available to Recipient or its Subsidiaries promptly upon Recipient's or its Subsidiaries' request.

2. Exceptions from Disclosure Tracking. Business Associate need not record disclosure information or otherwise account for disclosures of PHI that this Addendum or Recipient or the relevant Subsidiary in writing permits or requires (i) for the purpose of Recipient's or its Subsidiaries' treatment activities, payment activities, or health care operations, (ii) to the individual who is the subject of the PHI disclosed or to that individual's personal representative; (iii) to persons involved in that individual's health care or payment for health care; (iv) for notification for disaster relief purposes, (v) for national security or intelligence purposes, (vi) to law enforcement officials or correctional institutions regarding inmates; or (vii) pursuant to an authorization; (viii) for disclosures

4

---

of certain PHI made as part of a Limited Data Set; (ix) for certain incidental disclosures that may occur where reasonable safeguards have been implemented; and (x) for disclosures prior to April 14, 2003.

3. Disclosure Tracking Time Periods. Business Associate must have available for Recipient and its Subsidiaries the disclosure information required by this section for the 6 years preceding Recipient's or its Subsidiaries' request for the disclosure information (except Business Associate need have no disclosure information for disclosures occurring before April 14, 2003).

VI. Additional Business Associate Provisions

A. Reporting of Breach of Privacy Obligations. Business Associate will provide written notice to whichever of the Recipient or its Subsidiary for which the relevant PHI was created or from which the relevant PHI was received of any use or disclosure of PHI that is neither permitted by this Addendum nor given prior written approval by Recipient or the relevant Subsidiary promptly after Business Associate learns of such non-permitted use or disclosure. Business Associate's report will at least:

- (i) Identify the nature of the non-permitted use or disclosure;
- (ii) Identify the PHI used or disclosed;
- (iii) Identify who made the non-permitted use or received the non-permitted disclosure;
- (iv) Identify what corrective action Business Associate took or will take to prevent further non-permitted uses or disclosures;
- (v) Identify what Business Associate did or will do to mitigate any deleterious effect of the non-permitted use or disclosure; and
- (vi) Provide such other information, including a written report, as Recipient or the relevant Subsidiary may reasonably request.

B. Amendment. Upon the effective date of any final regulation or amendment to final regulations promulgated by the U.S. Department of Health and Human Services with respect to PHI, including, but not limited to the HIPAA privacy and security regulations, this Addendum and the Agreement will automatically be amended so that the obligations they impose on Business Associate remain in compliance with these regulations.

In addition, to the extent that new state or federal law requires changes to Business Associate's obligations under this Addendum, this Addendum shall automatically be amended to include such additional obligations, upon notice by Recipient or its Subsidiaries to Business Associate of such obligations. Business Associate's continued performance of services under the Agreement shall be deemed acceptance of these additional obligations.

5

---

C. Audit and Review of Policies and Procedures. Business Associate agrees to provide, upon Recipient request, access to and copies of any policies and procedures developed or utilized by Business Associate regarding the protection of PHI. Business Associate agrees to provide, upon Recipient's request, access to Business Associate's

internal practices, books, and records, as they relate to Business Associate's services, duties and obligations set forth in this Addendum and the Agreement(s) under which Business Associate provides services and / or products to or on behalf of Recipient or its Subsidiaries, for purposes of Recipient's or its Subsidiaries' review of such internal practices, books, and records.

SCHEDULE C

CEDING COMMISSION

The Ceding Commission shall be the sum of the following:

1. an amount equal to the excess of the Total SAP Ceded Reserves over Total GAAP Ceded Reserves measured as of the close of business on the day immediately preceding the Inception Date (which amount may be negative);
2. an amount equal to the unamortized PVFP intangible asset balance of the Company (excluding any related mark to market adjustments for SFAS 115 requirement) with respect to the Reinsured Contracts as measured as of the close of business on the day immediately preceding the Inception Date, determined in accordance with GAAP;
3. an amount equal to the unamortized deferred acquisition costs of the Company (excluding any related mark to market adjustments for SFAS 115 requirement) with respect to the Reinsured Contracts as measured as of the close of business on the day immediately preceding the Inception Date, determined in accordance with GAAP; and
4. an amount equal to the excess of the GAAP book value of the Assets (excluding any related mark to market adjustments for SFAS 115 requirement) over the SAP book value of the Assets measured as of the close of business on the day immediately preceding the Inception Date (which amount may be negative).

SCHEDULE D

ASSETS

Transfer Document	From	To	Nature of Transfer	Cash Map Cross-Reference	Schedule						
					Schedule D						
FCL SSA Coinsurance	FCL	UFLIC	Treaty	(84)							
Called Securities*	Parent Name	Issuer Name	1Q04 Cusip 1Q04 Tax lot	12/31/03 Local Par	12/31/03 GAAP BV (incl attached derivative)	12/31/03 Accrued Interest	12/31/03 GAAP BV+Accrued Interest	12/31/03 STAT BV (incl attached derivative)	12/31/03 Accrued Interest	12/31/03 STAT BV+ Accrued Interest	
[Individual Asset Details Omitted]											
Asset Sub Total					6,168,100,894.73	102,337,873.54	6,270,438,768.27	6,069,445,083.68	102,337,873.54	6,171,782,957.22	
Cash								11,006,434.84		11,006,434.84	
Total								6,080,451,518.52		6,182,789,392.06	

\* These Securities will not be transferred. The "Call Amount" will be settled in cash.

SCHEDULE E

EXPENSE ALLOWANCES

The "Annual Expense Reimbursement Factor" used to calculate the Expense Allowance is as follows:

Policy Maintenance Factor            \$23.84 per Policy

Such Annual Expense Reimbursement Factor will be adjusted (i) for the year beginning January 1, 2005 and, thereafter, every three (3) years during the term of this Agreement based on a triennial cost/time study prepared in accordance with the methodology set forth below (the "Triennial Study") and (ii) for the years between the Triennial Studies based on a report setting forth the Annual Expense Reimbursement Factor prepared in accordance with the methodology set forth below (the "Annual Expense Reimbursement Factor Report").

(a) **Triennial Study.** As soon as practicable (and in any event within sixty (60) days) prior to January 1, 2005 and prior to the beginning of every third calendar year thereafter during the term of this Agreement, the Company shall cause to be prepared and delivered to the Reinsurer the Triennial Study which sets forth the Annual Expense Reimbursement Factor for the next calendar year, together with all supporting data used in preparing the Triennial Study and work papers, in reasonable detail, setting forth the determination of such Annual Expense Reimbursement Factors based on such Triennial Study (such documents, together with the Triennial Study, the "Triennial Study Documents").

(b) **Annual Expense Reimbursement Factor Report.** As soon as practicable (and in any event within thirty (30) days) prior to January 1, 2006 and prior to the beginning of each calendar year thereafter in which no Triennial Study is prepared, the Company shall cause to be prepared and delivered to the Reinsurer the Annual Expense Reimbursement Factor Report, together with all supporting data used in preparing the Annual Expense Reimbursement Factor Report and work papers, in reasonable detail, setting forth the determination of such Annual Expense Reimbursement Factor for the next calendar year (such documents, together with the Annual Expense Reimbursement Factor Report, the "Annual Expense Reimbursement Factor Documents").

(c) **Methodology.** At the time of the Triennial Study, historical costs (to include costs directly related to maintaining and administering policies, processing claims and reporting results) will be determined for the Policy Maintenance Factor identified above. For a given Annual Expense Reimbursement Factor the identified costs will be divided by the total historical number of units of measure for both the Reinsured Contracts and the retained block of business to derive an historical cost per unit. The historical cost per unit

will be used as a prospective cost per unit for the next calendar year.

---

For the two succeeding years in the period between the Triennial Studies the historical dollar amounts by Policy Maintenance Factor will be adjusted (rolled forward) for current year cost changes agreed to by the Reinsurer and the Company (in accordance with the procedures set forth below). This rolled forward historical cost will then be divided by the total historical number of units for the current period to determine a prospective cost per unit for the next calendar year.

An additional adjustment, positive or negative, to the prospective cost per unit determined by either the Triennial Study or the two succeeding years may be negotiated between the parties. The additional adjustment is for special projected costs or benefits of productivity, process improvements, inflation, loss of scale, and any other cost variation which was not included in the prior Triennial Study or the succeeding roll forward.

The combined prospective unit cost and additional adjustment is the Annual Expense Reimbursement Factor. The Expense Allowance will be determined quarterly and billed to the Reinsurer in three equal installments during the quarter at the end of the month. Each installment will be determined by multiplying the actual number of units at the beginning of the quarter covered by this Agreement times the Annual Expense Reimbursement Factor (divided by twelve).

(d) Review of Documents. Following the delivery of the Annual Expense Reimbursement Factor Documents or the Triennial Study Documents, as applicable, the Company shall (i) provide to the Reinsurer or its designated representative copies of such additional work papers and other documents relating to its preparation of the Annual Expense Reimbursement Factor Report or Triennial Study, as applicable, as the Reinsurer or its designated representative may reasonably request, including, without limitation, claims files and practices and (ii) cooperate with, and make its personnel and facilities reasonably available to, the Reinsurer and the Reinsurer's designated representative for the purpose of providing such other information as the Reinsurer or the Reinsurer's designated representative may reasonably request concerning Annual Expense Reimbursement Factor Documents or the Triennial Study Documents, as applicable, and the calculation of the Annual Expense Reimbursement Factor.

(e) Notice of Disagreement. In the event that the Reinsurer has any disagreement with any of the Annual Expense Reimbursement Factor Documents or the Triennial Study Documents, as applicable, the Reinsurer shall give written notice of all such disagreements (a "Notice of Disagreement") to the Company within thirty (30) days after the Annual Expense Reimbursement Factor Documents or the Triennial Study Documents, as applicable, are delivered to the Reinsurer. Any Notice of Disagreement shall set forth each item in disagreement and shall provide reasonable specificity as to the basis for each disagreement and shall specify the total adjustment to the Annual Expense Reimbursement Factor, as proposed by the Company as a result of such items in disagreement.

(f) Dispute Resolution. If the Reinsurer does not deliver a Notice of Disagreement to the Company within such thirty (30) day period, the Annual Expense Reimbursement Factor Documents and the Triennial Study Documents, as applicable, shall be final and binding upon

the parties hereto and shall constitute the final calculation of the Annual Expense Reimbursement Factor for the next calendar year. If the Reinsurer delivers a Notice of Disagreement to the Company within such thirty (30) day period, the parties shall (and shall cause their respective designated representatives to) negotiate in good faith to resolve all disagreements as promptly as practicable. Any changes in the Annual Expense Reimbursement Factor, if any, that are agreed to by the Company and the Reinsurer within sixty (60) days of the aforementioned delivery of the Annual Expense Reimbursement Factor Documents or the Triennial Study Documents, as applicable, shall be incorporated into a final calculation of the Annual Expense Reimbursement Factor. If the parties and their respective designated representatives are unable to resolve all disagreements within sixty (60) days of delivery of the Annual Expense Reimbursement Factor Documents or the Triennial Study Documents, as applicable, then all unresolved disagreements will be submitted within ten (10) days after the end of such sixty (60) day period for resolution in accordance herewith to an independent certified public accounting firm of national standing and reputation (the "Accounting Firm") mutually acceptable to the Company and the Reinsurer. The parties shall cooperate in good faith with the Accounting Firm and shall give the Accounting Firm access to all data and other information requested by the Accounting Firm for purposes of such resolution. The Accounting Firm shall, within thirty (30) days after its engagement, deliver to the Company and the Reinsurer a definitive calculation of the Annual Expense Reimbursement Factor, which shall be final and binding upon the parties hereto and shall be so reflected in the calculation of the Annual Expense Reimbursement Factor. The Company and the Reinsurer shall each pay one-half of the fees and expenses of the Accounting Firm.

(g) Expense Allowance Pending Resolution. In the event of a dispute with respect to any Annual Expense Reimbursement Factor for the next succeeding Calendar year, the Company and the Reinsurer agree that the Annual Expense Reimbursement Factor then in effect under this Agreement shall remain in effect pending resolution of such dispute and adjustment, if any, in accordance with the dispute resolution procedure set forth in paragraph (f) above.



SCHEDULE F¾PART I

INITIAL REPORT

1.	Total SAP Ceded Reserves		
	Gross Policy Reserves calculated in accordance with SAP with respect to the reinsured risks.		\$ _____
2.	Ceding Commission:		
A.	Excess SAP Ceded Reserves over GAAP Ceded Reserves:		
	1) Total SAP Ceded Reserves	\$ _____	
	2) Total GAAP Ceded Reserves:	\$ _____	
	Gross Policy Reserves calculated in accordance with GAAP with respect to the reinsured risks.		
	Excess SAP Reserves over GAAP Reserves (A1-A2)		\$ _____
B.	Present Value of Future Profits (PVFP)		\$ _____
C.	Deferred Acquisition Costs (DAC)		\$ _____
D.	Asset Book Value Difference —Measured as of close of business the day preceding the Inception Date		
	1) Asset Book Value (GAAP basis)	\$ _____	
	2) Asset Book Value (SAP basis)	\$ _____	
	Excess Asset Book Value (D1-D2)		\$ _____
	Total Ceding Commission (A+B+C+D)		\$ _____
3.	Accrued Interest on Assets as of the day before Inception Date		\$ _____
4.	Investment Cash Flows on the Assets from the Inception Date through the Closing Date		\$ _____
	Net Due Reinsurer (1-2—3+4)		\$ _____

---

SCHEDULE F<sup>3</sup>/<sub>4</sub>PART II

QUARTERLY REPORT

1.	Benefits	\$ _____
2.	Withdrawals from Claims Settlement Account	\$ _____
3.	Expense Allowance	\$ _____
I.	Quarterly Settlement Amount (—1+2-3)	\$ _____
	Net Due to (from) Reinsurer	\$ _____

---

SCHEDULE F<sup>3</sup>/<sub>4</sub>PART III

ANNUAL REPORT

1.	Benefits	\$ _____
2.	Withdrawals from Claims Settlement Account	\$ _____
3.	Expense Allowance	\$ _____
I.	Quarterly Settlement Amount (-1+2-3)	\$ _____
	Net Due to (from) Reinsurer (I-II)	\$ _____

---

SCHEDULE G

FORM OF TRUST AGREEMENT

---

SCHEDULE H

ELIGIBLE SECURITIES

Assets of the types for which an Illinois-domiciled life insurance company could obtain full statutory reserve credit under statutory accounting practices prescribed or permitted by the Director of Insurance of the State of Illinois.

---



This LIABILITY AND PORTFOLIO MANAGEMENT AGREEMENT, dated as of January 1, 2004 (this "Agreement"), between TRINITY PLUS FUNDING COMPANY, LLC, a New York limited liability company (the "Company") and GENWORTH FINANCIAL ASSET MANAGEMENT, LLC, a Virginia limited liability company (the "Manager" and together with the Company, the "Parties").

WITNESSETH:

WHEREAS, FGIC MRCA Corp. ("MRCA Corp.") and the Company entered into that certain Investment Administration Agreement, dated as of June 23, 1997 (as subsequently amended, the "Investment Administration Agreement"); and

WHEREAS, the Manager is an investment adviser registered with the United States Securities and Exchange Commission that will be engaged by the Company to provide the services described herein; and

WHEREAS, MRCA Corp. has provided the Company a written notice of resignation pursuant to Section 3.05 of the Investment Administration Agreement and the Company, by executing this Agreement, accepts such resignation and waives the requirement for sixty (60) days' notice thereof; and

WHEREAS, the Investment Administration Agreement will be terminated and replaced by this Agreement; and

WHEREAS, the Manager and the Company wish to establish and define certain obligations set forth in Exhibit C and Exhibit D (the "Listed Obligations") that the Manager is required to undertake in connection with the services it will provide to the Company under this Agreement;

NOW, THEREFORE, in consideration of the mutual promises made herein and upon the terms and subject to the conditions set forth herein, the Parties hereby agree as follows:

ARTICLE I

Definitions

SECTION 1.01. Terms Defined in the Security Agreement. Capitalized terms used in this Agreement that are not defined herein shall have the respective meanings specified in the Collateral Trust and Security Agreement, dated as of June 23, 1997, among the Company, General Electric Capital Corporation ("GE Capital"), as LOC Agent, and Bankers Trust Company (predecessor-in-interest to Deutsche Bank Trust Company Americas), as Security Trustee (as amended, the "Security Agreement").

SECTION 1.02. Terms Defined in this Agreement. As used in this Agreement, the following capitalized terms have the following meanings:

"Accounts" shall have the meaning specified in Section 2.01.

"Agreement" means this Liability and Portfolio Management Agreement, including all provisions of the Security Agreement incorporated by reference herein, which shall have the same effect as if those provisions were set forth in full herein.

"Company" shall have the meaning specified in the preamble of this Agreement.

"Cure Period" means (i) with respect to the Listed Obligations set forth in Exhibit C, the respective cure periods set forth therein, and (ii) with respect to Listed Obligations in Exhibit D or other obligations set forth in this Agreement that do not appear in Exhibit C, one hundred twenty (120) days during the initial term of this Agreement and sixty (60) days thereafter; in each case such Cure Period to commence upon receipt of notice by the Manager from any party to a Contract entitled to give notice of default, GE Capital or the Company.

"Designee" shall have the meaning specified in Section 4.05(b).

"Dispute Resolution" shall have the meaning specified in Section 4.05(b).

"Failure Notice Recipients" shall have the meaning specified in Section 4.05(b) or such other recipients as are designated from time to time.

"Final Cure Period" shall have the meaning specified in Section 4.05(b).

"GE Capital" shall have the meaning specified in Section 1.01.

"Impossibility" shall have the meaning specified in Section 4.05(b).

"Indemnified Party" shall have the meaning specified in Section 2.12.

"Investment Administration Agreement" shall have the meaning specified in the first recital of this Agreement.

"Listed Obligations" shall have the meaning specified in the fifth recital of this Agreement.

"Management Fee" shall have the meaning specified in Section 2.06.

"Manager" shall have the meaning specified in the preamble to this Agreement.

"Maximum Permitted Program Size" shall have the meaning specified in Section 2.06.

"MRCA Corp." shall have the meaning specified in the first recital of this Agreement.

"Notice of Failure" shall have the meaning specified in Section 4.05(b).

“Operating Costs” shall have the meaning specified in Section 2.07(b).

“Operations, Procedures and Controls Manual” means the Operations, Procedures and Controls Manual of the Company dated as of July 2, 2003, as the same may be amended from time to time. The Rating Agencies shall receive notice and a copy of any amendments or modifications to the Operations, Procedures and Controls Manual on a biennial basis.

“Parties” shall have the meaning specified in the preamble to this Agreement.

“Permitted Investments Amendment” means an amendment to the Security Agreement which allows the Company to purchase debt issued by GE Capital without limit, subject to (i) the provision by GE Capital of a full and irrevocable guarantee of the Company’s payment obligations under the Contracts and Hedge Contracts, (ii) GE Capital’s being rated at least “AAA”/“Aaa” by the Rating Agencies, and (iii) the retirement in full of the outstanding Preferred Securities issued by the Company.

“Policy 5.0” means the policy which sets forth certain risk management guidelines that the Company is required to observe, as the same may be amended from time to time by the Company with the approval of GE Capital. The Rating Agencies shall receive notice and copy of any amendments or modifications to Policy 5.0 on a quarterly basis.

“Policy 6.0” means the policy which sets forth certain risk management parameters that the Company is required to observe, as the same may be amended from time to time by the Company with the approval of GE Capital. The Rating Agencies shall receive notice and copy of any amendments or modifications to Policy 6.0 on a quarterly basis.

“Portfolio” shall have the meaning specified in Section 2.01.

“Remediation Plan” shall have the meaning specified in Section 4.05(b).

“Security Agreement” shall have the meaning specified in Section 1.01.

“Senior Management” shall have the meaning specified in Section 4.05(b).

“Submission” shall have the meaning specified in Section 4.05(b).

SECTION 1.03. Other Definitional Provisions. Section 1.02 of the Security Agreement is incorporated herein by reference.

3

---

## ARTICLE II

### Engagement; Powers and Duties

SECTION 2.01. Engagement of Manager.

(a) The Company hereby retains the Manager:

(i) to advise the Company as to the investment of its Assets, including recommending specific Permitted Investments, Permitted Collateral Investments and Hedge Contracts to the Company;

(ii) to administer the Company’s Assets maintained in the Facility Account, the Collateral Accounts, and the LOC Reimbursement Account and such other accounts as the Company may maintain from time to time (the “Accounts”), which are identified (to the extent established by the effective date hereof) by account number in Exhibit A, as the same may be amended from time to time, with such deposits thereto and withdrawals therefrom as are from time to time permitted under the Security Agreement;

(iii) for as long as the revocable power of attorney granted pursuant to Section 2.02 is in effect, to arrange the purchase and sale through registered broker-dealers of bonds, pass-through certificates, stocks, and other securities relating to the Accounts;

(iv) for as long as the revocable power of attorney granted pursuant to Section 2.02 is in effect, to arrange the purchase and sale and otherwise to effect transactions in Hedge Contracts relating to the Accounts;

(v) to advise the Company in the issuance of and to assist the Company in the preparation of (and, for so long as the revocable power of attorney granted pursuant to Section 2.02 is in effect, to execute and to deliver on behalf of the Company) Investment Orders and Disposition Orders, as may be required from time to time pursuant to the terms of Sections 2.04 and 2.05 of the Security Agreement;

(vi) to prepare reports and to perform valuation tests as specified in Section 2.06 of the Security Agreement;

(vii) to take such action as is necessary and proper on behalf of the Company for the preservation of Company Collateral pursuant to Section 2.07 of the Security Agreement;

(viii) to assist the Company in the preparation and filing of financing statements or amendments of financing statements, as may be required in connection with any change in the Company’s name or location as contemplated by Section 2.08 of the Security Agreement;

(ix) to advise the Company in the granting or effecting of and to assist the Company in the preparation of (and, for so long as the revocable power of attorney

4

---

granted pursuant to Section 2.02 is in effect, to execute and to deliver on behalf of the Company) any consents, waivers, extensions, or modifications in respect of any item of Company Collateral or Contract Collateral as contemplated by Section 2.10 of the Security Agreement;

(x) to advise the Company in the delivery of and to assist the Company in the preparation of (and, for so long as the revocable power of attorney granted pursuant to Section 2.02 is in effect, to execute and to deliver on behalf of the Company) any instrument of transfer or release in respect of any item of Company Collateral or Contract Collateral as contemplated by Section 2.11 of the Security Agreement;

(xi) to notify the Security Trustee and other specified parties as may be required from time to time, pursuant to the terms of the Security Agreement,

of a Credit Event or a Program Event of Default;

- (xii) to advise the Company as to the allocation of Company Collateral to particular Contracts pursuant to Article V of the Security Agreement and the terms of the relevant Contract;
- (xiii) to notify the Security Trustee as may be required from time to time, pursuant to the terms of the Security Agreement, of an LOC Draw Event;
- (xiv) to designate persons who are registered representatives of a registered broker-dealer which is a member of the National Association of Securities Dealers to execute and deliver Contracts on behalf of the Company in their capacity as such pursuant to a power of attorney granted by the Company from time to time to registered representatives designated and notified to the Company by the Manager from time to time;
- (xv) to engage a registered broker-dealer which is a member of the National Association of Securities Dealers to assist the Company in connection with the offering, issuance and sale of Contracts and, in connection therewith, to make such other arrangements with such broker-dealer as may be necessary or advisable to ensure that such broker-dealer supervises its registered representatives who will effect such transactions and takes responsibility for such offering, issuance and sale; and
- (xvi) to take any other action deemed necessary or advisable to write Contracts on behalf of the Company, subject to the limitations set forth in the Security Agreement.

The Manager shall administer all of the Company's Assets in the Accounts (all of such Assets together, the "Portfolio") in accordance with the terms and conditions and shall otherwise observe in all material respects the requirements of the Security Agreement and other Program Documents, the Operations, Procedures and Controls Manual, Policy 5.0 and

5

---

Policy 6.0, this Agreement and all other documents, policies, laws and regulations applicable to the Company from time to time. The Company shall provide copies of the Security Agreement, the Operations, Procedures and Controls Manual, Policy 5.0 and Policy 6.0 to the Manager no later than the time that this Agreement is entered into and shall provide copies of all amendments, supplements and revisions to such documents as soon as they are available to the Company.

(b) Performance. The Parties hereby agree that the Manager shall perform the specific Listed Obligations set forth in Exhibit C and Exhibit D during the term of this Agreement and, subject to Section 2.10, such other functions as are set forth in this Agreement or as are generally required to operate the business of the Company in accordance with applicable laws, regulations, documents and Company policy. The Manager acknowledges that it will take all reasonable steps to continue to conduct the business of the Company in a manner substantially similar to that in which it had been conducted prior to the Parties' entry into this Agreement and in a manner reasonably satisfactory to the Company. The Manager shall perform its duties pursuant to this Agreement (i) exercising the same diligence and care applied to manage its own property; (ii) consistent with the practices used by it (and its Affiliates) to manage portfolios of similar assets for other customers and (iii) consistent with the diligence and care applied by other professional managers of similar stature. Notwithstanding the foregoing, if the Company does not consent, affirmatively or otherwise, to any proposed action by the Manager pursuant to this Section 2.01(b), the Manager's failure to take such proposed action shall not be deemed a breach of its standard of care hereunder.

SECTION 2.02. Power of Attorney. The Company hereby provides the Manager with a revocable power of attorney with full power and authority:

- (i) to evaluate and appraise the Portfolio;
- (ii) to arrange the purchase and sale through registered broker-dealers of bonds, pass-through certificates, stocks, and other securities in connection with making Investments for the Portfolio;
- (iii) to arrange the purchase and sale and otherwise to effect transactions in Hedge Contracts in connection with making Investments for the Portfolio through registered broker-dealers;
- (iv) to execute and to deliver on behalf of the Company any Investment Orders and Disposition Orders, as may be required from time to time pursuant to the terms of Section 2.04 and 2.05 of the Security Agreement;
- (v) to execute and to deliver on behalf of the Company any consents, waivers, extensions, or modifications in respect of any item of Company Collateral or Contract Collateral as contemplated by Section 2.10 of the Security Agreement;
- (vi) to execute and to deliver on behalf of the Company any instrument of transfer or release in respect of any item of Company Collateral or Contract Collateral;
- (vii) to engage a broker-dealer acceptable to the Company to assist the Company in the origination, issuance and sale of Contracts in accordance with all applicable securities laws and regulations; and

6

---

(viii) subject to the limitations set forth in the Operations, Procedures and Controls Manual, Policy 5.0 and Policy 6.0, to take any other action, including executing agreements and any other documents on behalf of the Company that the Manager deems necessary or advisable to purchase, sell, or otherwise effect investment transactions relating to the Portfolio.

All Investments made, and transactions entered into, by the Manager on behalf of the Company shall be entered into in the name of the Company. All actions contemplated above shall be performed in accordance with applicable laws, regulations, documents and applicable Company policy. The Manager shall not be under an obligation to keep the Portfolio fully invested if, in its sole discretion, it shall determine that market and/or economic conditions make it imprudent or disadvantageous to do so at any time or funds should be made available for distributions and other payments pursuant to the Security Agreement. The Company represents that it has the authority to make the appointment set forth in this paragraph. In the event the Manager fails to perform a Listed Obligation and this Agreement is terminated pursuant to Section 4.05(a) or (b), or if this Agreement is terminated pursuant to Sections 4.05(c) or (d), this power of attorney may be revoked by the Company by written notice to the Manager.

SECTION 2.03. Valuation. The Manager shall value the Portfolio from time to time as required by Section 2.06 of the Security Agreement in order to prepare the reports required thereunder, using the portfolio valuation methods set forth in the Market Valuation Addendum attached as Schedule 1.01 to the Security Agreement, in order to determine whether a Coverage Shortfall, a Program Shortfall or a Net Worth Deficit has occurred and is continuing and whether the Market Sensitivity Limit has been exceeded. The Manager shall also value Permitted Collateral Investments on deposit in Collateral Accounts as required under the terms of each Collateralized Contract.

SECTION 2.04. Reports. As more particularly specified in the applicable Program Documents and in Exhibit C and Exhibit D, the Manager shall:

(a) prepare the Company's annual financial statements and, unless otherwise specified by the Company, arrange to have such statements audited by a firm of independent accountants acceptable to the Company and GE Capital;

(b) timely prepare and provide to the Security Trustee, the Company and the Rating Agencies such reports as are required to be provided to each of such Persons pursuant to Section 2.06 of the Security Agreement and in accordance with Exhibit 2.06 of the Security Agreement;

(c) give prompt written notice to the Company, the Security Trustee, the Broker-Dealers and the Rating Agencies of (i) the existence of a Coverage Shortfall, Program Shortfall, or Net Worth Deficit or (ii) the exceeding of a Market Sensitivity Limit; and

7

---

(d) notify the Company and GE Capital immediately upon learning of any Credit Event, Program Event of Default or other material default or breach of the Listed Obligations set forth in Exhibit C.

SECTION 2.05. Confidential Relationships. All information and recommendations furnished by the Manager to the Company shall be treated by the Company as confidential. The Manager shall, in turn, treat as confidential all information concerning the affairs of the Company. Nothing in this Section 2.05 shall be deemed to preclude any such information or recommendations from being disclosed by either Party to such Party's Affiliates or to the directors, officers, employees, representatives, agents, or advisers of such Affiliates, or pursuant to applicable law, regulation or court order; provided, that any such recipients are advised of the confidential nature of such information or recommendations.

SECTION 2.06. Fees. The Company hereby agrees to pay to the Manager a fee (the "Management Fee") at an annual rate of sixteen and one-half (16.5) basis points (0.165%) of the Maximum Permitted Program Size of the Company as of the date hereof, payable quarterly in arrears; provided, however, that the Management Fee shall be pro rated to the date of termination in the event the Agreement is terminated pursuant to Article IV. For the purposes hereof, "Maximum Permitted Program Size" means nine billion dollars (\$9,000,000,000) or such larger amount as shall be approved in writing by GE Capital. In no event shall the Management Fee that is payable to the Manager be an amount less than fourteen million, eight hundred fifty thousand dollars (\$14,850,000) per annum, pro rated to reflect the period of time during which this Agreement was in effect during each year.

SECTION 2.07. Expenses Reimbursed.

(a) The Company shall reimburse the Manager for all out-of-pocket expenses incurred and approved pursuant to Section 2.09(e) in connection with the performance of its duties hereunder, except for any expenses arising out of the Manager's willful misfeasance, bad faith, gross negligence in the performance of or reckless disregard of its obligations and duties hereunder.

(b) The Company shall reimburse the Manager for all appropriate Operating Costs of the Company. Such reimbursement shall be made, upon receipt by the Company from the Manager of a schedule detailing Operating Costs (substantially in the form of Exhibit B hereof), within thirty (30) days following the end of each quarter. For the purposes hereof, "Operating Costs" means all costs incurred by the Manager in connection with the performance of its obligations under this Agreement that have been submitted and approved in writing as part of the annual budget approval process described in Section 2.09(e). For the avoidance of doubt, it is hereby agreed that certain expenses will not be paid by the Manager and do not constitute reimbursable Operating Costs. Such expenses, which are directly attributable to the Company, include fees payable to: (i) each rating agency that assigns a rating to the Company, (ii) external auditors of the Company, (iii) external legal counsel engaged by the Company for services rendered thereto and not in connection with duties of the Manager which are

8

---

unrelated to the management services it renders to the Company, (iv) certain third-party providers of accounting services to the Company, (v) providers of credit research services required by the Company and (vi) any provider of goods or services for costs incurred in connection with requirements imposed by regulatory authorities, the applicable rating agencies, or any applicable law, rule, regulation, administrative interpretation, ordinance, code issued by a Governmental Authority or regulatory body, or any order, writ, injunction, directive, judgment or decree of a court of competent jurisdiction; each such expense shall be paid by the Company.

SECTION 2.08. Execution of Securities Transactions.

(a) In connection with the offering and sale of Contracts, the Manager shall engage a registered broker-dealer approved by the Company that provides services with respect to the origination, issuance and sale of Contracts that the Manager believes to be of value. The Company shall pay all costs associated with the retention of such broker-dealer.

(b) Except as otherwise specifically directed by the Company, the Manager shall have complete discretion to select any registered broker-dealer in all securities transactions affecting the Portfolio not described in Section 2.08(a). The Manager is expressly authorized to select such brokers-dealers who provide brokerage and research services that the Manager believes to be of value. The Manager is expressly authorized to pay from the Assets in the Portfolio commissions on such transactions in amounts that the Manager determines in good faith to be reasonable in relation to the value of such brokerage and research services, viewed in terms either of the particular transaction or the overall responsibilities of the Manager with respect to the Portfolio.

SECTION 2.09. Administrative Responsibilities. The Manager shall have the following administrative responsibilities:

(a) The Manager shall submit the budget for reimbursable Operating Costs to the Company and GE Capital by no later than January 31 of each year and such budget shall be approved by the Manager of Finance of Corporate Treasury and Global Funding Operations (or such other representative as shall be designated from time to time in a notice to the Manager executed by the Company and GE Capital) by February 15 of such year. Operating Costs incurred in excess of the aggregate amounts approved in the annual budget must be separately approved by the Company and GE Capital in order to be considered for reimbursement.

(b) Custody of the Assets comprising the Portfolio will be maintained by the Security Trustee or the applicable Collateral Agent as specified in Article II of the Security Agreement. The Manager shall not have custody of any of the Assets in the Portfolio.

(c) The Manager shall keep such books and records relating to all transactions that it effects pursuant to this Agreement, including without limitation all books and records necessary (in addition to books and records available from the Security

9

---

Trustee pursuant to Section 2.09(c) or otherwise) for preparing the reports required by Section 2.04.

(d) The Manager on behalf of the Company shall instruct the Security Trustee and each Collateral Agent: (i) to send copies of all statements relating

to the Accounts to the Manager; (ii) to permit the Manager, on behalf of the Company, to inspect the Company Collateral or Contract Collateral, as the case may be, in the possession or otherwise under the control of the Security Trustee and the books and records maintained by the Security Trustee or such Collateral Agent, as the case may be, relating thereto (and to allow the Manager to make extracts and copies thereof) as the Manager may reasonably request pursuant to Section 2.03(b) of the Security Agreement; and (iii) to report to the Manager, concurrently with reporting to the Company pursuant to Section 2.03(a) of the Security Agreement, any failure on the part of the Security Trustee or such Collateral Agent, as the case may be, to hold the Company Collateral as provided in Section 2.03(a) of the Security Agreement.

- (e) For the avoidance of doubt, the Manager shall provide no services to the Company in respect of tax planning or tax compliance of any kind.
- (f) The Manager shall submit presentations relating to the offering of Contracts to the Company and GE Capital for approval prior to external use.
- (g) The Manager shall maintain its status as an “investment adviser” under the Investment Advisers Act of 1940, as amended, and shall follow all applicable laws and regulations relating to its status as such and to its performance hereunder, including all applicable laws and regulations relating to bidding for Contracts.

SECTION 2.10. Other Duties as Reasonably Requested. The Manager shall also perform such other duties or shall modify existing duties as the Company may reasonably request or that the Manager shall recommend to the Company from time to time relating to the management of a business involved in the issuance of guaranteed investment contracts and similar debt obligations issued by providers rated “AAA”/“Aaa” and the management of the proceeds of the issuance of such contracts and obligations. If any additional or modified duties are required of Manager under this Agreement, Manager shall have the reasonable time and opportunity to procure such additional resources as may, in Manager’s good faith judgment, be required to perform such duties. Manager also agrees that it will cease to perform the requirements of certain obligations specified hereunder if the Company so directs in writing. Any such changes or additions shall be deemed for all purposes to be amendments or supplements to this Agreement. The Company shall pay such costs as have been mutually agreed to by the Parties and as may from time to time be required to enable the Manager to perform any additional or changed Listed Obligations contemplated herein and other obligations not listed in this Agreement for which additional resources are required or additional costs are reasonably incurred by the Manager.

SECTION 2.11. Limitation of Liability. Neither the Manager nor any of its Affiliates nor any of their respective directors, officers, or employees shall be liable to

the Company for any error of judgment or mistake of law or for any loss arising out of any Investment, Hedge Contract, or any other commitment of funds on behalf of the Company or for any act or omission in the administration of the Portfolio except for willful misfeasance, bad faith, gross negligence in the performance of or reckless disregard of its obligations and duties hereunder, other than as may be provided under applicable law.

SECTION 2.12. Indemnification. (a) The Company shall (i) indemnify and hold harmless the Manager and any Affiliate of the Manager and each of their respective directors, officers, employees and agents (each, an “Indemnified Party”) from and against all losses, claims, damages, expenses or liabilities to which such Indemnified Party may become subject (except in respect of the broker-dealer engaged by the Manager in respect of the placement of Contracts, which shall be the sole liability of the Manager), insofar as such losses, claims, damages, expenses or liabilities (or actions, suits or proceedings including any inquiry or investigation or claims in respect thereof) arise out of, in any way relate to, or result from the transactions contemplated by, this Agreement, and (ii) reimburse each of the Indemnified Parties upon its demand for any reasonable legal or other expenses incurred in connection with investigating, preparing to defend or defending any such loss, claim, damage, liability, action or claim, in each case only to the extent that funds are available therefor in accordance with the Security Agreement; provided, however, that none of the Indemnified Parties shall have the right to be so indemnified hereunder for losses, claims, damages, expenses or liabilities to the extent resulting from its own negligence or willful misconduct or for losses, claims, damages, expenses or liabilities that it is required to pay to any broker-dealer that it has engaged in connection with the Contracts or other liabilities. If any action is brought against an Indemnified Party indemnified or intended to be indemnified pursuant to this Section 2.12, the Company shall, if requested by such Indemnified Party, resist and defend such action, suit or proceeding or cause the same to be resisted and defended by counsel reasonably satisfactory to such Indemnified Party, but shall not be empowered to compromise or settle such action, suit or proceeding unless such Indemnified Party has been fully indemnified for any loss, claim, damage, expense or liability it thereby suffers. Each Indemnified Party shall, unless the Indemnified Party has made the request described in the preceding sentence and such request has been complied with, have the right to employ its own counsel to investigate and control the defense of any matter covered by such indemnity and the reasonable fees and expenses of such counsel shall be at the expense of the Company. Any obligations of the Company pursuant to this Section 2.12 are Deferred Expenses and the Manager shall have recourse solely to the LOC Reimbursement Account for such obligations of the Company (and not to any other assets of the Company) and shall be paid in the priority specified in the applicable sections of Article VII of the Security Agreement. The Manager hereby expressly consents to such limited recourse to the LOC Reimbursement Account and to such priorities of distributions set forth in Article VII of the Security Agreement.

### ARTICLE III

#### Representations and Warranties

SECTION 3.01. Valid Existence; Authorization; Enforceability. Each of the Parties represents and warrant to the other as follows:

- (a) such Party is a limited liability company duly organized, validly existing and in good standing under the laws of the jurisdiction of its organization and has all requisite power, legal right and authority to execute and deliver this Agreement and all other documents to be executed and delivered by such Party in connection herewith and to perform its obligations hereunder and thereunder; and
- (b) this Agreement and all the documents to be executed and delivered by such Party in connection herewith and therewith has been duly authorized by all necessary actions on the part of such Party.

### ARTICLE IV

#### Miscellaneous Provisions

SECTION 4.01. No Assignment Without Consent. This Agreement, and the obligations and rights arising under this Agreement, may not be assigned or otherwise transferred by either Party (including any assignment or transfer in connection with any Person succeeding to any part of the business of either Party) without the prior written consent of the other Party and without obtaining Rating Agency Confirmation.

SECTION 4.02. Counterparts. This Agreement may be executed in one or more counterparts and, as so executed, shall constitute one agreement binding upon the Parties.

SECTION 4.03. No Third Party Beneficiaries. Nothing expressed or implied in this Agreement is intended or shall be construed to confer upon any person (other than the Parties and their permitted assigns), any right, remedy or claim by reason of this Agreement or any term hereof, and all terms contained herein shall be for the sole and exclusive benefit of the Parties and their successors and permitted assigns.

SECTION 4.04. Interpretation. The headings of the Articles and Sections hereof are for convenience of reference only and shall not affect the meaning or construction of any provision hereof.

SECTION 4.05. Term; Termination.

(a) The Manager's appointment hereunder shall continue in effect for an initial term commencing on the date hereof and ending on December 31, 2006, with extensions for additional one (1) year periods commencing automatically upon each anniversary thereof, unless either Party notifies the other Party in writing at least ninety (90) days before such anniversary that such extension shall not be effective.

12

(b) If the Manager fails to perform any of its obligations set forth in this Agreement, Exhibit C or Exhibit D, the Manager (or if the failure is first discovered by the Company, then the Company) shall give prompt written notice (such notice, a "Notice of Failure") to the persons identified in Exhibit E (the "Failure Notice Recipients") specifying the nature of the failure; provided that in the event the Manager fails to perform any of its obligations set forth in Exhibit C, the Company shall give prompt written notice of such failure to the Rating Agencies in addition to the Failure Notice Recipients. In the event such Notice of Failure is given, then either the Manager or the Company may elect to submit the matter for review (a "Submission") and resolution ("Dispute Resolution"), which may include the establishment of a plan of remediation (a "Remediation Plan"), to (i) with respect to the Manager, the Business Leader of the Retirement Income and Investment Segment of Genworth Financial Inc. (or such person or persons as such Business Leader may designate) and (ii) with respect to the Company, the Senior Vice President – Corporate Treasury and Global Funding Operation of GE Capital (or such person or persons as such Senior Vice President may designate) ((i) and (ii) together, "Senior Management"). The Manager and the Company agree (x) to cooperate in good faith and in a reasonable manner to reach an agreement with respect to any Remediation Plan; (y) to be bound by the results of any such Dispute Resolution agreed to by Senior Management including any Remediation Plan (the timing and content of which shall be at the sole discretion of Senior Management) and (z) that the Manager will implement any such Remediation Plan within the period mandated by Senior Management (the "Final Cure Period"). The result of any such Dispute Resolution shall be in writing signed by Senior Management, shall be deemed part of this Agreement and, with respect to the failure involved, shall supersede any conflicting or different terms of this Agreement. The Chief Operating Officer of Manager's Capital Markets Group responsible for management of the Company or a person designated by such officer (a "Designee") shall provide to the Rating Agencies notice and a copy of any Remediation Plan resulting from a Dispute Resolution that is deemed by such officer or Designee to have a potential adverse effect on the ratings of the Company. The Manager shall identify such officer or Designee in the appropriate periodic risk reports submitted to the Rating Agencies.

If Senior Management fails to reach an agreement with respect to a Dispute Resolution and the Cure Period has not expired, the matter in dispute shall be resolved solely and exclusively in accordance with the arbitration procedures set forth in Exhibit F.

If (i) Senior Management or an arbitral tribunal described in Exhibit F fails to reach agreement with respect to a Dispute Resolution and the Cure Period has expired or (ii) the Manager fails to correct the failure by the end of the applicable Final Cure Period, then this Agreement may, subject to Section 4.05(c), be terminated by the Company upon two (2) Business Days' prior written notice to the Manager and each Failure Notice Recipient specifying the basis for and the effective date of the termination.

Notwithstanding the foregoing, the payment obligations of the Company during the initial term of this Agreement shall not be terminated if any such failure and the continuation thereof are caused by Impossibility. For the purposes hereof

13

"Impossibility" means loss or malfunction of electric power, transportation or communication services; general inability to obtain or retain labor, material, equipment or transportation, or a delay in mails or services; the Company's, GE Capital's or their Affiliates' (i) failure to take an action on which the Manager's performance of an obligation or any Listed Obligation depends or (ii) taking an action which renders the Manager's performance of an obligation or any Listed Obligation impossible; governmental or exchange action, statute, ordinance, ruling, regulation, administrative interpretation or directive; acts of terror, vandalism, explosions, tornados, acts of God or public enemy, acts of any civil or military authority, revolutions, insurrections, strike, emergency, riots or civil commotions, freezes, fires, floods, embargoes, wars, sabotage, explosions or other unforeseen or unexpected occurrences, which unforeseen or unexpected occurrences render the performance of any obligations by the Manager impossible. In the event of any such occurrence, the Manager shall use all reasonable efforts to remediate the disruption and resume its performance of the obligations.

(c) The Company shall have the right, by giving the Manager thirty (30) Business Days' prior written notice, to terminate this Agreement at an earlier time than that specified in Section 4.05(a) in the event of continuing non-performance by the Manager due to Impossibility of any obligation hereunder beyond the applicable Cure Period or Final Cure Period, or if the Company liquidates all or substantially all of the Assets of the Company held in the Facility Account (except Contract Collateral) and substitutes therefor the debt of GE Capital pursuant to the terms of the Permitted Investments Amendment. Upon termination of this Agreement pursuant to this Section 4.05(c), the Manager shall be paid a termination fee by the Company equal to the product of (i) sixteen and one-half (16.5) basis points (0.165%), multiplied by (ii) the Maximum Permitted Program Size, multiplied by (iii) the percentage derived by dividing the number of days remaining in the initial term by 365. In addition, the termination fee shall include any actual cost incurred and agreed upon and reasonably associated with terminating the operations set forth in this Agreement, including but not limited to employment severance costs as determined by the standard practices of the Manager.

(d) The Manager may resign upon not less than ninety (90) days' prior written notice to the Company.

(e) Notwithstanding any provision to the contrary, including the expiration of any term of this Agreement, so long as the Portfolio is still outstanding, this Agreement shall remain in full force and effect and no termination or resignation of the Manager shall be effective until the Company has entered into an agreement with a successor manager. Upon receiving a notice of resignation from the Manager, the Company shall use its best efforts to enter into such an agreement unless it elects to terminate this Agreement as provided in Section 4.05(c) above. Except as set forth in Exhibit F, nothing in this Agreement shall be deemed a waiver of any Party's rights to pursue remedies at law or in equity, which shall be available in accordance with applicable law in addition to any remedies provided for in this Agreement.

SECTION 4.06. Independent Contractor. The Manager is being engaged pursuant to this Agreement as an independent contractor and the Parties

14

expressly disclaim any intention to enter into a joint venture, partnership, or any other form of association pursuant to this Agreement.

SECTION 4.07. GOVERNING LAW. THIS AGREEMENT SHALL BE GOVERNED BY, AND CONSTRUED IN ACCORDANCE WITH, THE INTERNAL LAWS OF THE STATE OF NEW YORK, WITHOUT REGARD TO THE RULES OF CONFLICTS OF LAWS OF THE STATE OF NEW YORK OR ANY OTHER JURISDICTION.

SECTION 4.08. Notices. All notices, instructions, and advice with respect to any transactions or other matters contemplated by this Agreement shall be deemed duly given only when actually received at such Party's principal place of business as set forth below. Return receipt or courier record of delivery shall be deemed conclusive evidence of receipt. Notices may be made by fax or other electronic means shall be deemed given upon electronic evidence of receipt at applicable recipient's fax or computer station. A copy of all notices given shall be provided to GE Capital.

If to the Manager:

Genworth Financial Asset Management, LLC  
6620 West Broad Street  
Richmond, Virginia 23230  
Attention: Pamela Schutz  
Phone: (804) 291-6533  
Fax: (804) 281-6165  
E-mail: pamela.schutz@ge.com

with a copy to:

335 Madison Avenue  
Mezz4  
New York, New York 10017  
Attention: Shailesh Shah  
Phone: (212) 389-2575  
Fax: (212) 389-2591  
E-mail: shailesh.shah@ge.com

If to the Company:

Trinity Plus Funding Company, LLC  
335 Madison Avenue  
Mezz4  
New York, New York 10017  
Attention: Shailesh Shah  
Phone: (212) 389-2575  
Fax: (212) 389-2591  
E-mail: shailesh.shah@ge.com

15

---

If to General Electric Capital Corporation:

General Electric Capital Corporation  
260 Long Ridge Road  
Stamford, Connecticut 06927  
Attention: Senior Vice President – Corporate  
Treasury and Global Funding Corporation  
Phone: (203) 961-5077  
Fax: (203) 357-3490  
E-mail: alan.green1@ge.com

SECTION 4.09. Entire Agreement; All Amendments in Writing. (a) This Agreement embodies the entire understanding of the Parties concerning the subject matter hereof and supersedes any and all other previous agreements, written or oral, concerning the same subject matter.

(b) The Parties may at any time and from time to time, agree to any amendment or modification of, any provision of this Agreement to cure any mistake, ambiguity, defect or inconsistency or to correct any manifest error or to correct any error of formal, minor or technical nature. The Rating Agencies shall be given written notice of any amendment under this Section 4.09(b) not less than fifteen (15) days prior to the effective date thereof.

(c) The Parties may at any time and from time to time, agree to any amendment or modification of, any provision of this Agreement other than any amendment or modification provided for in Section 4.09(b); provided that, in each case, a Rating Agency Confirmation shall be obtained prior to the effectiveness of such amendment or modification.

(d) Any amendment to any provision of the Security Agreement that is incorporated by reference in this Agreement (including, without limitation, any amendment to any of the capitalized terms incorporated by reference herein), so long as such amendment is made as permitted under the terms of the Security Agreement, shall constitute an amendment to this Agreement unless the Parties agree in writing that such amendment shall not be effective under this Agreement.

SECTION 4.10. Waiver. No waiver of any provision of this Agreement nor consent to any departure therefrom shall in any event be effective unless the same shall be in writing and signed by the Party from whom such waiver or consent is sought, and then such waiver or consent shall be effective only in the specific instance and for the specific purpose for which given. The Party seeking such waiver or consent shall promptly deliver a copy thereof to the Rating Agencies.

SECTION 4.11. Further Assurances. Each Party hereby agrees to execute and deliver such additional documents, instruments or agreements as may be reasonably necessary and appropriate to effectuate the purposes of this Agreement.

16

---

SECTION 4.12. Successors and Assigns. This Agreement shall be binding upon the Parties and their respective successors and assigns.

SECTION 4.13. Severability. Any term or provision of this Agreement which is invalid or unenforceable in any jurisdiction shall, as to that jurisdiction, be ineffective to the extent of such invalidity or unenforceability without rendering invalid or unenforceable the remaining terms and provisions of this Agreement or affecting the validity or enforceability of any of the terms or provisions of this Agreement in any other jurisdiction. If any provision of this Agreement is so broad as to be unenforceable, the provision shall be interpreted to be only so broad as is enforceable.

SECTION 4.14. Limited Recourse. The obligations of the Company under this Agreement are solely the obligations of the Company. No recourse shall be had for any obligation or claim arising out of or based upon this Agreement against any Member, manager, officer organizer, agent or employee of the Company or any shareholder, officer, director, employee, agent or incorporator of any Member. Any accrued obligations owing by the Company shall be payable by the Company solely to the extent that funds are available therefor from time to time in accordance with the provisions of Article VII of the Security Agreement (and such accrued obligations shall not be extinguished until paid in full.)

SECTION 4.15. Termination of the Investment Administration Agreement; Release. Effective as of the date hereof, the Company does hereby, for itself and its successors and assigns, waive the sixty (60) days' notice requirement of Section 3.05 of the Investment Administration Agreement and accepts the resignation of MRCA Corp. as the Portfolio Adviser thereunder and fully and unconditionally release and forever discharge MRCA Corp. (and any officer, director, employee or agent of MRCA Corp.) from any and all present and future (i) obligations and liabilities under the Investment Administration Agreement and (ii) causes of action, suits, claims, demands, liabilities and obligations whatsoever, whether at law or in equity, arising from or related to the Investment Administration Agreement, arising from and after the date hereof.

[Signature Page Follows]

IN WITNESS WHEREOF, the Parties have executed this Agreement as of the date first above written.

TRINITY PLUS FUNDING COMPANY, LLC,  
a New York limited liability company

By: IC FUNDING CORP.,  
a Delaware corporation,  
as its Controlling Common Member

By: \_\_\_\_\_  
Name:  
Title:

GENWORTH FINANCIAL ASSET MANAGEMENT, LLC

By: \_\_\_\_\_  
Name:  
Title:

ACKNOWLEDGED AND  
CONSENTED TO BY:

FGIC MRCA CORP.

By: \_\_\_\_\_  
Name:  
Title:

AGREED AND ACCEPTED BY:

GENERAL ELECTRIC CAPITAL  
CORPORATION

By: \_\_\_\_\_  
Name:  
Title:

**Exhibit A**

**Accounts Comprising the Portfolio**

<u>Account</u>	<u>Custodian Bank</u>	<u>Account Number</u>
Facility Account	Deutsche Bank Trust Company Americas, New York, NY	23398
LOC Reimbursement Account	Deutsche Bank Trust Company Americas, New York, NY	23405
Account	Deutsche Bank Trust Company Americas, New York, NY	



Form of Schedule of Operating Costs

Operating Costs for the first calendar year, commencing on January 1, 2004, shall be \$[ ] and thereafter shall be equal to [ ]% of the Operating Costs of the Manager, subject to the Company's approval, as provided in Section 2.07(b) and shall consist of the following (allocated [ ]% with respect to the Company):

CMS	2004				2004
	1Q	2Q	3Q	4Q	TY
<b>Comp &amp; Benefits:</b>					
Salaries	\$	\$	\$	\$	\$
Savings Plan 401k					
Bonuses					
Employee Insurance					
Payroll Taxes					
<b>Total Comp &amp; Benefits</b>					
<b>Purchase Base:</b>					
Travel & Living Expenses					
Business Meetings					
Education					
Employment Fees					
Tuition Reimbursement					
Relocation Maintenance					
Dues & Associations					
Consulting Fees					
Outside Services					
Rent/ Utilities					
Legal Fees					
Audit Fees					
Recreation					
Telephone/Cellular					
Printing & Office Supplies					
Postage/Courier Service					
Subscriptions					
Information Services					
Advertising / Marketing					
Temporary Help					
Equipment Maintenance					
Hardware Expense					
Software Expense					
Fiscal Agent Fees					
Investment Fees					
Organizational Misc					
<b>Total Purchase Base</b>					
<b>Total Controllable</b>					

B-1

CMS	2004				2004
	1Q	2Q	3Q	4Q	TY
<b>Other:</b>					
Property Insurance					
Corporate Assessments					
<b>Total Other</b>					
<b>SG&amp;A Expenses</b>					
Rating Agency Fee					
Loss On Other Assets					
Insurance And Licensing					
State And Local Taxes					
Goodwill Amortization					
Change in DAC					
Ceding Commission					
<b>Non-SG&amp;A Expenses</b>					
<b>Op &amp; Admin Expense</b>					
Depreciation					
<b>Total Direct Expenses</b>					
Broker Fees Amortization					
<b>Total Expenses (including Broker Fees)</b>	\$	\$	\$	\$	\$

B-2

## Priority Manager Functions

Listed Obligation	Cure Period
<b>Payments</b>	
Manager shall cause payments to be made as required under any Contracts, Hedge Contracts or other agreement to which the Company is a party.	Five (5) Business Days from the date a notice of nonpayment received by Manager under the applicable Contract, Hedge Contract or agreement (or such shorter period as exists prior to such nonpayment being an actionable default thereunder); <u>provided, however,</u> that if the Manager or the Company gives notice to the other party requesting Dispute Resolution within one (1) Business Day of notice, the cure period hereunder shall be extended by three (3) Business Days from the date the notice of nonpayment is received (it being understood that in no event shall this section supersede the contractual payment obligations in the respective Contracts or Hedge Contracts).
<b>Risk Matters</b>	
Manager shall comply with all requirements of GE Capital's Policy 5.0 and 6.0 relating to the Company and related "strike zones," as such policies and strike zones are amended from time to time, and all requirements relating to Permitted Investments and the portfolio in the Security Agreement; <u>provided,</u> that in the event that a trigger has been tripped under Policy 6.0 by virtue of a change in the market or pursuant to the action of a rating agency, GE Capital shall provide direction on remediation on a case-by-case basis if not otherwise provided for in Policy 6.0 and, if the Manager takes the appropriate corrective action (whether as prescribed by the Policy or as directed by GE Capital), no failure to perform an obligation under this Agreement shall be deemed to have occurred.	Five (5) Business Days.
<b>Rating Agency Requirements</b>	
Manager shall prepare all reports on the dates specified by each rating agency currently rating obligations of the Company and shall meet all requirements specified by any such agency for continuation or reinstatement of their highest long-term and short-term ratings.	Thirty (30) days or such shorter or longer period as is specified for compliance by the rating agencies.

C-1

Listed Obligation	Cure Period
<b>Financial Reporting</b>	
Manager shall comply with <u>Section 2.04</u> hereof and the Listed Obligations and shall prepare all reports relating to the Company as are necessary or desirable for compliance with the Sarbanes-Oxley Act of 2002 and any other financial reporting requirements of the Company under applicable law and external regulation.	Thirty (30) days or such shorter or longer period as is specified by the applicable accounting firm or regulatory body to allow for compliance with the applicable regulatory or disclosure requirement.
<b>Legal Compliance</b>	
Manager shall prepare disclosure documentation annually or more frequently as is necessary or desirable in connection with its offering of Contracts and Preferred Securities and shall otherwise comply with the requirements of contracts to which it is a party, and all applicable laws and regulations.	Thirty (30) days or such other period as is specified in the applicable agreement or regulation or as is directed by the applicable regulatory body.

C-2

## Exhibit D

### Listed Obligations

#### Business

- Manager will use its best efforts to maintain an Average Program Size of thirteen billion dollars (\$13,000,000,000) or such other amount reasonably specified by the Company from time to time for the combined portfolios of the Company and Trinity Funding Company, LLC. For the purposes hereof, the term "Average" means a rolling 3-month average of end-of-day balances, computed daily.
- Manager will review the Portfolio Quality Review with GE Capital on a monthly basis on such dates as Manager and GE Capital shall agree to in advance.

#### Compliance/Legal

- Manager will maintain the corporate and limited liability company minutebooks and records of the Company and its non-controlling common members and any successors thereto, and take all actions required to maintain their valid existence and good standing in the jurisdictions in which they are organized or qualified.
- Manager will comply with applicable law in respect of the Company's issuance of Contracts and Preferred Securities, including with respect to rules promulgated under federal securities laws that restrict certain forms of advertising and solicitation.
- Manager will prepare updated versions of the Confidential Information Memorandum of the Company (i) on an annual basis to reflect then-current audited financial information of the Company or (ii) at such other times as may be required by the Company.

- Manager will, as required from time to time, prepare updated versions of the Private Placement Memorandum of the Company relating to the Company's issuance of Preferred Securities.
- Manager will use its best efforts to take all actions required in connection with obtaining the appropriate authority with respect to the extension of the Liquidity Commitment and/or the Letter of Credit commitment and any required increase of the Liquidity Commitment and/or the Letter of Credit commitment (it being understood that no failure to perform a Listed Obligation shall be deemed to have occurred if either such commitment is not extended or increased after a request has been submitted).
- Manager will consult with and obtain approval from the Company in connection with proposed material modifications to the terms or the form of Contracts.

D-1

---

- Manager will maintain its status as an "investment adviser" under the Investment Advisers Act of 1940, as amended, and will take all reasonable steps to comply with all applicable laws and regulations relating to its status as such.
- Manager will cause its legal staff to draft and prepare all Contracts, Hedge Contracts and other contracts entered into by the Company. The in-house counsel of Manager may, to the extent required, engage outside counsel in connection with the preparation of such contracts if such engagement is approved verbally or in writing by the General Counsel – Treasury Operation of GE Capital and otherwise approved under Section 2.09. Nothing in this Agreement will preclude Manager from engaging its own outside counsel for any purpose it deems necessary or advisable, and Manager need not obtain any separate approval therefor.
- Manager will comply with all applicable laws and all applicable policies and procedures as the same may be provided to Manager by the Company, including but not limited to the USA Patriot Act and Anti-Money Laundering policies and laws.
- Manager will take all reasonable actions required to assist the Company or GE Capital in connection with changes to the corporate structure of the Company and its common members.
- Manager will take all reasonable steps to provide prompt responses to GE Capital in connection with requests from regulatory or other governmental authorities for documentation or data relating to the operation of the Company.
- Manager will comply with all applicable laws, regulations, policies, management procedures and other requirements of the Company, GE Capital and Genworth, including but not limited to the GE Capital Information Security Procedure and, to the extent applicable, the policies contained in "Integrity: The Spirit and the Letter of Our Commitment."

#### Liability/Contract Bidding Process

- Manager shall ensure that transactions in Contracts are effected in accordance with the following general procedure: (i) a registered representative of a broker-dealer (each, a "GIC Salesperson") shall receive bid specifications ("Bid Specs") provided by prospective Contract customers or their agents ("Customers"); (ii) the GIC Salesperson shall analyze the Bid Specs and respond to Customers, indicating to such Customers, where appropriate, the requirements to maintain the Company's exemption from registration under the Investment Company Act of 1940, as amended; (iii) the GIC Salesperson shall submit all Bid Specs for review and comment to the designated member of the Manager's legal staff and will note on any bid acceptance form that is delivered to the Customer all appropriate

D-2

---

comments received from the legal staff; (iv) the GIC Salesperson shall price transactions in which the Company has an interest in bidding and communicate such pricing to the applicable Customer; and (v) the Manager's legal staff shall provide counsel to the GIC Salesperson in connection with the preparation, negotiation and closing of all Contracts for transactions that the Company wins.

#### Financial Controls

- Manager will perform its accounting responsibilities in compliance with GE Capital's internal accounting policies and U.S. GAAP.
- Manager will maintain accounting policies currently in place and all changes to accounting policies must be approved in advance by GE Capital. For new accounting standards, GE Capital will provide Manager with the accounting policy to be adopted by the Company.
- Manager will perform accounting in accordance with FAS 133 and obtain approval from GE Capital for the following FAS 133 activities:
  - Changes to existing hedge documentation
  - Changes in existing methodology used to assess and measure hedge effectiveness
  - Application of "fair value" hedging as defined in FAS 133
  - Economic hedges that do not qualify for FAS 133 hedge treatment
- Manager will provide a monthly variance analysis of:
  - Changes in the fair market value of derivatives
  - Hedge ineffectiveness
  - Amounts excluded from the measure of effectiveness
- Manager will reconcile all general ledger accounts in accordance with GE Capital's account reconciliation criteria. Manager will provide a quarterly dashboard of account reconciliations and open items (in an agreed upon format) on dates to be provided to Manager.
- Manager is responsible for establishing and maintaining a system of internal controls adequate to ensure that Assets are appropriately safeguarded and that the financial statements and related disclosures and schedules fairly present the financial condition of the Company.
- Manager and GE Capital will agree upon and execute a plan to minimize profit and loss volatility associated with FAS 133.

- Manager will deliver monthly unaudited financial results including any adjustments to the monthly financials to be included in the next month's accounting period. These financials should include an explanation of significant items of variance to the Operating Plan. Such financial statements will be delivered within fifteen 15 days of the close as defined by GE Capital.
- Manager will deliver quarterly unaudited financial reports and schedules in accordance with GE Capital's closing instructions. Such financials statement will include variance and profitability analysis suitable for the closing of the books. Closing instruction to be provided by the 15th of the month of the quarterly close.
- Manager will provide the Company with financial projections in accordance with GE Capital's SI, SII and OP process. GE Capital will provide the Manager with SI, SII and OP timing and assumptions where needed to make such forecasts.
- Manager will deliver annual audited financial statements (balance sheet and income statement) upon completion of the annual audit by GE Capital's external auditors.
- Manager will conduct annual reviews in compliance with applicable provisions of the Sarbanes-Oxley Act of 2002, in a manner acceptable to GE Capital.
- Manager will report detailed profit and loss results and details of expenses within fifteen (15) days following the end of each quarterly period, including comparisons of actual versus plan, in a format reasonably agreeable to both parties. Profit and loss reports will be included in the monthly Portfolio Quality Review, substantially in the format attached as Schedule I to this Exhibit D.

#### Risk

- Manager will comply with the Permitted Investments guidelines provided in Schedule 4.01(h) of the Security Agreement.
- Manager will value the Portfolio from time to time, as required by Section 2.06 of the Security Agreement in order to prepare the reports required by such Section of the Security Agreement, using the portfolio valuation methods set forth in the Market Valuation Addendum attached as Schedule 1.01 to the Security Agreement, in order to determine whether a Coverage Shortfall, a Program Shortfall or a Net Worth Deficit has occurred and is continuing and whether the Market Sensitivity Limit has been exceeded. The Manager shall also value Permitted Collateral investments on deposit in Collateral Accounts as required under the terms of each Collateralized Contract.
- Manager will comply with all applicable terms set forth in Policy 5.0 and Policy 6.0 and all "strike zones" defined by GE Capital with respect to assets, liabilities

and derivatives (as each may be amended from time to time by GE Capital). Manager will deliver the following reports on a monthly basis for monitoring such compliance:

- Portfolio Quality Review
- Credit Limit Watch
- Credit Risk Rating
- Stop Loss
- Month End Credit
- Counterparty Exposure
- Except as otherwise specified in this Exhibit D, Manager will deliver risk reports to GE Capital on a monthly basis and will include, at a minimum, the following:
  - Portfolio Quality Review
  - Supplemental Program Shortfall
  - Liquidity Report (provided on a daily basis)
  - Summary Hedge Analysis Report (provided on a daily basis)
  - REM (electronic submission)
- Manager will provide other available reports required from time to time by GE Capital as they are requested.
- Manager will participate, on a monthly and quarterly basis, in in-force reviews with Genworth senior management and GE Capital senior management.
- Manager will from time to time provide GE Capital with data feeds relating to the Portfolio, the content, format and timing of the delivery of which feeds will be agreed upon by Manager and GE Capital.
- Manager will (i) comply with applicable requirements as to hedge counterparty ratings, as set forth in the Security Agreement and as provided in the applicable policies of GE Capital, (ii) comply with the applicable requirements to provide information to GE Capital with respect to hedge counterparty exposure, (iii) deliver a Counterparty Exposure report for monitoring such compliance and (iv) comply with such restrictions as to hedge counterparty that may from time to time be imposed by GE Capital.
- Manager will from time to time provide GE Capital with such available additional risk analyses as GE Capital may request, including but not limited to, stress tests and value at risk analyses. In each case, the content, format and timing of the delivery of such analyses will be agreed upon, prior to delivery, by GE Capital and Manager.

- Manager will comply with all applicable requirements relating to the Company's maintenance of the "AAA"/"Aaa" ratings assigned thereto by the applicable rating agencies.

#### Customer

- Manager will ensure delivery by mail or e-mail, or will make available on the Company's website, to the Company's customers in accordance with such customers' respective Contracts, Customer Statements in respect of customers' investments with the Company.
- Manager will ensure the timely remittance of payments required under each Contract or other agreement of the Company.
- When requested by the Company and GE Capital, Manager will deliver to the Company and GE Capital customer service metrics (e.g., call volume by customer complaint type by date) and deal closing customer survey results (if and to the extent the same is provided by customers).

#### Information Technology

- Manager will maintain the current systems environment to fully support the business requirements and the services to be performed under this Agreement for the Company.

#### Continuous Service (Disaster Recovery)

A disaster recovery site shall be maintained as follows:

- Backup copies of critical servers shall be maintained at an off-premises Disaster Recovery Site (locations to be determined from time to time by the Parties hereto). The critical servers are as follows: Principia PAS server, Oracle Data Warehouse Server, File Server, Oracle GL Server, and FileNET CM Server. In the event of a major disaster where access to production servers and 335 Madison Avenue's assets (or those of a successor location from which the Company's business is operated) is lost, service will be restored on the following schedule: PAS and Oracle Data warehouse systems will be within twenty-four (24) hours. GL and FileNET server will be available within forty-eight (48) hours. The Parties will work with GE Capital Treasury on a best effort basis to establish and implement an adequate Disaster Recovery plan.

D-6

---

- Software refreshes to synchronize the DR systems with the production systems shall be done within twenty-four (24) hours of the update of the production system to coincide with production system updates.
- Backups of the production PAS database shall be copied to the DR PAS server nightly.

#### Data Management (Backups and Retention)

- Full data backups are performed daily on all production and Quality Assurance systems.
- Full data backups of all Network files are performed daily.
- Backup tapes shall be stored offsite at Iron Mountain. Tapes are picked up by 10:30 a.m. daily.
- An authorized list of personnel may recall tapes from Iron Mountain (an agreement exists to deliver backup tapes to any location, including the home of IT personnel).
- Tapes shall be cycled on a rolling eight (8) week rotation. All Financial close and Month End tapes shall be marked permanent and retained indefinitely.

#### Change Management: Notification and Approval Process on Changes to IT Infrastructure and Application Software

- GE Capital Treasury shall have the right to approve the Company's Change Management Process.
- All change requests shall be reported to GE Capital Treasury on a weekly basis.
- Emergency changes to the IT Environment shall be reported to GE Capital Treasury as they occur.
- In the event of a major System Failure GE Capital Treasury shall be notified and required to approve required changes.

#### Performance and Capacity Planning Reporting and Reviews

- In general, monthly business reports shall be available by 9:00 a.m. the last Business Day of the month. The IT team will communicate all exceptions by

D-7

---

8:30 a.m. on the day such exceptions occur. The communication will include the anticipated delivery time. The following performance tracking processes exist:

- Monthly report of nightly batch completion times.
- Monthly report of nightly batch completion times.
- Monthly report of exceptions and violations of the 9:00 a.m. report delivery times and cures employed.
- Monthly report on system loading and projected performance bottlenecks and issues and resolutions.
- Monthly report of license denials.
- GE Capital Treasury shall perform a quarterly review of systems and access rights to those systems. IT shall prepare the report to be reviewed, deliver a copy to GE Capital Treasury and will remediate issues discovered. An updated access matrix will be added to the "CMS Operational Procedures and Controls" document quarterly.

Personnel

- Manager will maintain a staff of qualified employees sufficient to support the business requirements of the Company and to perform the services required under this Agreement.

Other Obligations

- Manager will comply in all material respects with all other obligations provided under this Agreement.

D-8

**Schedule I**

**Format of P&L Included with  
Monthly Portfolio Quality Review**

<u>CMS P&amp;L (\$ millions)</u>	<u>Actual</u>	<u>Operating Plan</u>	<u>Variance from Operating Plan</u>
<b>Net Revenue:</b>			
Trinity Gross Spread Income	\$	\$	\$
Trinity Broker Fees Amortization			
Trinity Hedge Ineffectiveness			
<b>Trinity Net Interest Margin</b>			
Trinity Realized Gains (Losses)			
<b>Subtotal Trinity Net Revenue</b>			
GE Book			
<b>Total CMS Net Revenue</b>			
<b>Operating Expenses:</b>			
CMSI	\$	\$	\$
Trinity			
MRCA			
<b>Total Operating Expenses</b>			
<b>Total CMS Pre-tax Income</b>			
<b>Tax (Benefit)</b>			
<b>Net Income</b>	<b>\$</b>	<b>\$</b>	<b>\$</b>
Trinity Average Liability Balance			
Core Spread (including Broker Fees)			
Net Spread (Including Hedge Ineffectiveness)			
<b>Memo: Net Income Sharing</b>			
Genworth (Management Fee + GE Book)			
GEI Other			

D-9

**Exhibit E**

**Failure Notice Recipients**

<u>Recipient</u>	<u>Address</u>	<u>Telephone</u>	<u>Facsimile</u>
<b><u>Manager</u></b>			
Pamela Schutz	6610 West Broad Street Richmond, Virginia 23230	(804) 281-6533	(804) 281-6165
Kelly Groh	6610 West Broad Street Richmond, Virginia 23230	(804) 281-6321	(804) 281-6310
Toni Ness	6610 West Broad Street Richmond, Virginia 23230	(804) 289-3594	(804) 281-6005
Shailesh Shah	335 Madison Avenue Mezz4 New York, New York 10017	(212) 389-2575	(212) 839-2591
Grant Lineberry	335 Madison Avenue Mezz4 New York, New York 10017	(212) 389-2570	(212) 389-2591

Colin Burrell	335 Madison Avenue Mezz4 New York, New York 10017	(212) 389-2640	(212) 389-2590
<u>Company</u>			
Kathy Cassidy	201 High Ridge Road Stamford, Connecticut 06927	(203) 357-6199	(203) 585-1191
Brian Wenzel	201 High Ridge Road Stamford, Connecticut 06927	(203) 357-6774	(203) 316-7601
Alan Green	201 High Ridge Road Stamford, Connecticut 06927	(203) 961-5077	(203) 357-3490
Johan Fogelberg	201 High Ridge Road Stamford, Connecticut 06927	(203) 357-6072	(203) 357-4975
Robert Ceske	201 High Ridge Road Stamford, Connecticut 06927	(203) 602-8337	(203) 585-1361

E-1

<u>General Electric Capital Corporation</u>			
Kathy Cassidy	201 High Ridge Road Stamford, Connecticut 06927	(203) 357-6199	(203) 585-1191
Brian Wenzel	201 High Ridge Road Stamford, Connecticut 06927	(203) 357-6774	(203) 316-7601
Alan Green	201 High Ridge Road Stamford, Connecticut 06927	(203) 961-5077	(203) 357-3490
Johan Fogelberg	201 High Ridge Road Stamford, Connecticut 06927	(203) 357-6072	(203) 357-4975
Robert Ceske	201 High Ridge Road Stamford, Connecticut 06927	(203) 602-8337	(203) 585-1361

E-2

**Exhibit F**

**Arbitration Procedures**

If Senior Management fails to reach agreement with respect to a Dispute Resolution within forty-five (45) days of a Submission and the Cure Period has not expired, either Party may submit the matter to be finally resolved by arbitration pursuant to the CPR Institute for Dispute Resolution (the “CPR”) Rules for Non-Administered Arbitration as then in effect (the “CPR Arbitration Rules”). The Parties consent to a single, consolidated arbitration for all known matters under dispute existing at the time of the arbitration and for which arbitration is permitted.

The neutral organization for purposes of the CPR Arbitration Rules will be the CPR. The arbitral tribunal shall be composed of three arbitrators, of whom each Party shall appoint one in accordance with the “screened” appointment procedure provided in Rule 5.4 of the CPR Arbitration Rules. The arbitration shall be conducted in New York City. Each Party shall be permitted to present its case, witnesses and evidence, if any, in the presence of the other Party. A written transcript of the proceedings shall be made and furnished to the Parties. The arbitrators shall determine the matter in dispute in accordance with the law of the State of New York, without giving effect to any conflict of law rules or other rules that might render such law inapplicable or unavailable, and shall apply this Agreement according to its terms, provided that the provisions relating to arbitration shall be governed by the Federal Arbitration Act, 9 U.S.C. §§ 1 et seq.

The Parties agree to be bound by any award or order resulting from any arbitration conducted in accordance with this provision and further agree that judgment on any award or order resulting from an arbitration conducted under this provision may be entered and enforced in any court having jurisdiction thereof.

Except as expressly permitted by this Agreement, no Party will commence or voluntarily participate in any court action or proceeding concerning a matter in dispute, except (i) for enforcement, (ii) to restrict or vacate an arbitral decision based on the grounds specified under applicable law, or (iii) for interim relief as provided in paragraph (e) below. For purposes of the foregoing, the parties hereto submit to the non-exclusive jurisdiction of the courts of the State of New York.

In addition to the authority otherwise conferred on the arbitral tribunal, the tribunal shall have the authority to make such orders for interim relief, including injunctive relief, as it may deem just and equitable.

Each Party will bear its own attorneys’ fees and costs incurred in connection with the resolution of any matter in dispute in accordance with this provision.

F-1

**Genworth Financial, Inc.**  
**Computation Of Ratio Of Earnings To Fixed Charges**  
**(Dollar amounts in millions)**

	Historical					Pro Forma
	Year ended December 31,					Year ended December 31,
	2003	2002	2001	2000	1999	2003
Net earnings from continuing operations before income taxes and accounting changes	\$ 1,382	\$ 1,791	\$ 1,821	\$ 1,851	\$ 1,589	\$ 1,330
Fixed charges included in earnings from continuing operations:						
Interest expense	140	124	126	126	78	138
Interest portion of rental expense	23	25	23	25	24	23
Interest credited to contractholder	1,624	1,645	1,620	1,456	1,290	1,358
Subtotal	1,787	1,794	1,769	1,607	1,392	1,519
Fixed charges included in earnings from discontinued operations:						
Interest expense	12	16	15	17	17	12
Interest portion of rental expense	8	12	12	12	9	8
Interest credited to contractholder	68	79	51	41	6	68
Subtotal	88	107	78	70	32	88
Total fixed charges	\$ 1,875	\$ 1,901	\$ 1,847	\$ 1,677	\$ 1,424	\$ 1,607
Earnings available for fixed charges (including interest credited to contractholders)	\$ 3,257	\$ 3,692	\$ 3,668	\$ 3,528	\$ 3,013	\$ 2,937
Ratio of earnings to fixed charges (including interest credited to contractholders) (1)	1.74	1.94	1.99	2.10	2.12	1.83 (2)

- (1) For purposes of determining the historical ratio of earnings to fixed charges, earnings consist of earnings from continuing operations before taxes and accounting changes plus fixed charges from continuing and discontinued operations. Fixed charges consist of (a) interest expense on short-term and long-term borrowings; (b) interest credited to policyholders on annuities and financial products; and (c) the portion of operating leases that are representative of the interest factor.
- (2) For purposes of determining the ratio of pro forma earnings to pro forma fixed charges, pro forma earnings consist of pro forma earnings from continuing operations before taxes plus pro forma fixed charges from continuing operations and fixed charges from discontinued operations. Pro Forma fixed charges consist of (a) pro forma interest expense on short-term and long-term borrowings, including dividends on Series A Preferred Stock; (b) pro forma interest credited to policyholders on annuities and financial products; and (c) the portion of operating leases that are representative of the interest factor.

QuickLinks

[Genworth Financial, Inc. Computation Of Ratio Of Earnings To Fixed Charges \(Dollar amounts in millions\)](#)



[QuickLinks](#) -- Click here to rapidly navigate through this document

EXHIBIT 23.1

WHEN THE TRANSACTIONS REFERRED TO IN NOTE 1 TO THE AUDITED COMBINED FINANCIAL STATEMENTS ON PAGE F-7 HAVE BEEN CONSUMMATED, WE WILL BE IN A POSITION TO RENDER THE FOLLOWING CONSENT.

/s/ KPMG LLP

**Independent Auditors' Consent**

The Board of Directors  
Genworth Financial, Inc.:

We consent to the use of our reports on the combined financial statements and the related schedule of Genworth Financial, Inc. as of December 31, 2003 and 2002, and our report on the statement of financial position of Genworth Financial, Inc. as of December 31, 2003 included herein and to the reference to our firm under the headings "Selected Historical and Pro Forma Financial Information" and "Experts" in the prospectus. Our report dated February 6, 2004, except for note 1 which is as of \_\_\_\_\_, 2004, with respect to the combined statement of financial position of Genworth Financial, Inc. as of December 31, 2003 and 2002 and the related combined statements of earnings, stockholder's interest, and cash flows for each of the years in the three-year period ended December 31, 2003 refers to a change in accounting for variable interest entities in 2003, goodwill and other intangible assets in 2002, and derivative instruments and hedging activities in 2001.

Richmond, Virginia  
April 19, 2004

---

QuickLinks

[Independent Auditors' Consent](#)